

Hisense L675 User Manual

Manufactured by Hisense Communications Co.,Ltd.

4G LTE ready

* Please check with your network operator if 4G LTE is available on your SIM.

- Screen displays and illustrations may differ from those you see on actual phone. Some of the contents of this guide may not apply to your phone, depending on the software and your service provider. All information in this document is subject to change without notice.

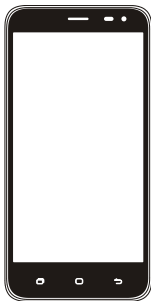

Content

Safety Precautions	3
Medical device	4
Road safety	4
Power supply & Charging	5
Hearing protection	6
Protecting the environment	6
Cleaning and maintenance	6
Emergency call	7
Copyright	7
Getting to know your phone	8
Phone overview	8
Installing the SIM/SD card	10
Charging the battery	10
Basic operations	11
Turning your device on/off	11
Configuring your phone on start up	12
Home screen	13
Notifications panel	14
Opening the notifications panel	15
Customizing your screen	15
Main Function	16
Making and receiving a call	16
Adding contacts	17
Sending message	18
Music	18
Camera	19
Chrome	20
Getting connected (connection to	

Wi-Fi)	20
Important information	21
Dolby	21
Disclaimer	21
Troubleshooting	22

Safety Precautions

Please read the safety precautions carefully to ensure the correct use of your mobile phone.

1. Do not crush, throw, or puncture your mobile phone. Avoid dropping, squeezing and bending of your mobile phone.
2. Do not use your mobile phone in a wet environment, such as the bathroom. Prevent your mobile phone from being soaked or washed in liquid.
3. Do not switch on your mobile phone when it is prohibited to use or when the phone may cause interference or danger.
4. Some parts of your mobile device are made of glass. This glass could break if your mobile device is dropped on a hard surface or receives a substantial impact. If the glass breaks, do not touch or attempt to remove it. Stop using your mobile device until the glass is replaced by an authorized service provider.
5. Switch off your mobile phone in aircraft. The phone may cause interference to control equipment of the aircraft.
6. Switch off your mobile phone near high-precision electronic devices. The phone may affect the performance of these devices.
7. Do not attempt to disassemble your mobile phone or its accessories. Only qualified personnel are allowed to service or repair the phone.
8. The socket-outlet shall be installed near the equipment and shall be easily accessible.
9. Do not place your mobile phone or its accessories in containers with a strong electromagnetic field.
10. Do not place magnetic storage media near your mobile phone. Radiation from the phone may erase the information stored on them.
11. Keep the product away from direct sunlight. Do not put your mobile phone in a high-temperature place or use it in a place with flammable gas such as a gas station.
12. Use only approved batteries and chargers to avoid the risk of explosion.
13. Observe any laws or regulations on the use of wireless devices. Respect others' privacy and legal rights when using your wireless device.

14. Strictly follow the relevant instructions of this manual while using the USB cable. Otherwise your mobile phone or PC may be damaged.
15. Use a dry soft cloth to clean the product; do not use water, alcohol, detergent or any chemicals.
16. Please backup any important data. Repair may result in data loss.
17. Do not disconnect the product during memory formatting or file transfer operations. Otherwise, it may cause program failure or damage to files
18. Keep the phone and charger out of the reach of children. Do not let children use the phone, battery or charger without supervision.
19. Keep children away from small phone accessories to prevent suffocation or blocking of the oesophagus as a result of swallowing.
20. Do not allow children to use your mobile phone without supervision.
21. Do not modify or remanufacture the product, immerse or expose the product to water or other liquids, or expose the product to fire, explosion or other hazards.
22. The product shall only be connected to a USB interface of version USB2.0.
23. The operating temperature shall be between -20°C and $+60^{\circ}\text{C}$.

Medical device

1. Follow any rules or regulations in hospitals and health care facilities.
2. Implanted medical devices such as pacemakers may be affected by the product.
3. Avoid potential interference emitted from the product to the implanted medical device, keeping the product at least 20 cm away from the medical device.
4. Do not carry the product in the breast pocket.
5. Turn off the product immediately if you suspect any interference.

Road safety

Check the laws and regulations on the use of mobile phones in the area when you drive.

1. Do not use a hand-held phone while driving.

2. For driving safety, only a passenger should operate the device when the car is in motion and not the driver. Laws governing the use of electronic devices by the driver may be applicable in your country and/or jurisdiction.
3. Give full attention to driving.
4. Pull off the road and park before making or answering a call if driving conditions so require.
5. RF energy may affect some electronic systems in your vehicle such as car stereos and safety equipment.
6. When your vehicle is equipped with an air bag, do not obstruct with installed or portable wireless equipment. It can cause the air bag to fail or cause serious injury due to improper performance.
7. If you are listening to music, please ensure that the volume is at a reasonable level so that you are aware of your surroundings. This is of particular importance when near roads.

Power supply & Charging

1. Adapter shall be installed near the equipment and shall be easily accessible. The Charger Model name: A34-501000, Input: AC 100-240V 50/60Hz 0.2A, Output: DC5.0V, 1.0A.
2. The plug considered as disconnect device of adapter.
3. Only use the accessories supplied with the phone. The use of incompatible accessories may have serious consequences and permanently damage your phone.
4. Only use the adapter supplied with the product.
5. This adapter is intended for indoor use only.
6. The mains cable is used as a connecting device. The wall outlet should remain readily accessible and access to the outlet should not be blocked during use.
7. To fully disconnect the phone from the mains, unplug the AC/DC cable from the wall outlet.
8. The ventilation should not be impeded by covering the ventilation openings with items, such as newspapers, tablecloths, curtains, etc. to avoid overheating and malfunction.
9. Maintain a clearance of at least 10cm around the phone.
10. The phone should be used in a moderate climate.
11. The phone is built with an internal rechargeable battery: do not expose the product to excessive heat such as sunshine, fire or the like.

12. The battery must be removed from the phone before it is scrapped.
13. The battery is to be disposed of safely.
14. Battery contains materials which are hazardous and harmful for the environment.
15. Do not plug or unplug USB port with wet hands – risk of electric shock.

Hearing protection

1. This phone respects the current regulations for limiting the maximum output volume. Prolonged headset listening at high volume could lead to hearing damage!
2. Stop using the product or lower the volume if you feel your ears ringing.
3. Do not turn up the volume too high, doctors warn against prolonged exposure to high volume.
4. Excessive sound pressure from headsets and headphones can cause hearing loss.
5. To prevent possible hearing damage, do not listen at high volume levels for long periods.
6. Please only use specified headphones with your phone.



Protecting the environment

Please observe the local regulations on phone packaging, battery and used phone disposal and bring them to the collection point for proper recycling. Do not dispose of used phones or batteries in a household rubbish bin.

Please take your used, unwanted lithium batteries to a designated place. Do not dispose of them in a rubbish bin.



CAUTION : RISK OF EXPLOSION IF BATTERY IS REPLACED BY AN INCORRECT TYPE. DISPOSE OF USED BATTERIES ACCORDING TO THE INSTRUCTIONS.

Cleaning and maintenance

1. Switch off the phone before cleaning and maintenance. The charger should be unplugged from the power socket

- and the phone and charger disconnected to prevent any electric shock or short circuiting of the battery or charger.
2. Do not wipe the phone or charger using chemical substance (alcohol benzene), chemical agents or abrasive cleaning agents to avoid damaging its parts or causing a malfunction. You may clean with a slightly damp anti-static soft cloth.
 3. Do not scrape or alter the phone case as paint substances may cause an allergic reaction. If such a reaction occurs, cease using the phone immediately and seek medical help.
 4. Wipe dust off the power plug and keep it dry to avoid risk of fire.
 5. If the phone or accessories do not work properly, contact your local vendor.
 6. Do not dismantle the phone or its accessories yourself.

Emergency call

In an emergency situation, if the phone is on and you are within the network range, it can be used to make an emergency call. However, emergency call numbers may not be reachable on all networks; you should never rely on your mobile phone for emergency calls.

Copyright

This product is for private use only. Copying CDs or downloading music, video or picture files for sale or other business purposes may be a violation of copyright law. Copyrighted materials, works of art and/or presentations may require authorization to be fully or partially copied or recorded. Please be aware of all such applicable laws concerning the recording and use of such contents for your country and jurisdiction.

Getting to know your phone

Phone overview

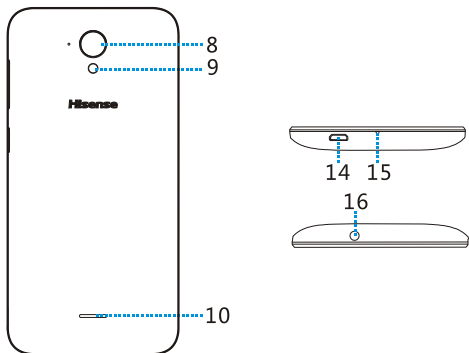
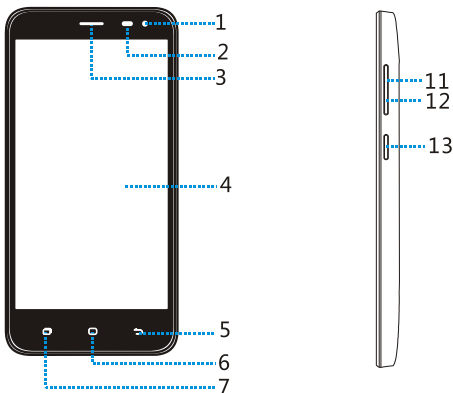

1. Front camera	9. Flashlight
2. Sensors	10. Speaker
3. Receiver	11. Up volume key
4. Touch screen	12. Down volume key
5. Back key	13. Power key
6. Home key	14. Micro-USB connector
7. Recent key	15. Microphone
8. Camera	16. Headset connector

Key's function

- **Power key:** Press to light up or close the screen, press and hold to show the pop-up menu to select from Power off/Reboot/Airplane mode. Press the Power key for more than 10s to restart. Press the Power key and Down volume key to capture a screenshot.
- **Home key:** From any application or screen, touch to return to the Home screen.
- **Recent key:** Touch to open a list of thumbnail images of applications you've worked with recently.
- **Back key:** Touch to go back to the previous screen, or to close a dialog box, options menu, the notification panel, etc.
- **Volume Keys:** In call mode, adjusts the earpiece or headset volume; In Music/Video/Streaming mode, adjusts the media volume; In general mode, adjusts the ringtone volume; Mutes the ringtone of an incoming call.

NOTE: Proximity sensor

When receiving and making calls, the proximity sensor automatically turns the backlight off by sensing when the phone is near your ear. This extends battery life and prevents you from unintentionally activating the touch screen during calls.

WARNING:

Placing a heavy object on the phone or sitting on it can damage the LCD and touch screen functions. Do not cover the LCD proximity sensor with protective film. This could cause the sensor to malfunction.

Installing the SIM/SD card

Before you can start exploring your new phone, you'll need to set it up.

To remove the back cover, hold the phone firmly in one hand. With your other hand, lift off the back cover with your thumbnail.

Slide the SIM/SD card into the corresponding slot as shown in figure., make sure the gold contact area on the card is facing downwards.

Note:

1. Your phone only supports Micro-SIM cards. Do not attempt to insert other SIM type like Nano cards, otherwise this may cause phone damage.
2. Please do not remove the SIM/SD card while the card is in use; otherwise, data loss or damage may occur. Hisense shall not be liable to any loss, including data loss, due to misuse of an SIM/SD card.
3. Please turn off your mobile phone before replacing or removing its SIM/SD card.
4. SD card is not included, you need to buy separately.

Charging the battery

Charging Battery

1. Insert the large end of the USB cable into the mobile phone charger and insert the small end into the mobile phone USB slot, while paying attention to the orientation of the USB plug.
2. Insert the charger into a 100~240V 50/60Hz outlet to

start charging.

3. After charging is complete, remove the USB from your mobile phone and then unplug the charger from the power outlet.

Charging time

1. If the AC power supply is of a lower voltage, then a longer charging time may be needed;
2. The charging time will depend upon the current status of the battery capacity;
3. If non-standard chargers such as computers are used for charging, then a longer charge time may be needed;
4. Using the mobile phone while it's charging will extend its charging time.

Note:

1. This product has a built-in battery, do not disassemble the battery!
2. Please fully charge the battery before first use and disconnect the charger immediately after the first charge is completed.
3. Please remove the charger from the AC power socket when not charging the phone.
4. The phone may not boot immediately if charging with low battery. After a period of charging, the phone will boot normally.
5. The mobile phone can be safely charged within the ambient temperature of 0°C to 40°C. Charging at temperatures below 0°C or higher than 40°C, will harm the battery performance and shorten its life. Long-term charging in extreme temperatures will mean the battery is permanently undercharged or damaged.
6. The charger is important for safety, so please use the special charger for this product and pay attention to safety instructions during operation.

Basic operations

Turning your device on/off

Turn on the phone: Press the Power key located on the right side of the phone and wait for a few seconds until the screen lights up.

Note: If the battery is empty, make sure you charge it for

at least 30 minutes.

Turn off the phone: Press and hold Power key to pop up option menu, select “Power off”.

Configuring your phone on start up

The first time you turn on the phone, you'll see a Welcome screen.

- To choose a different language, touch the menu.
- To set up your phone, and follow the instruction.
- You might need to connect to an active network or Wi-Fi to proceed.
- Choose one screenlock type as youlike.

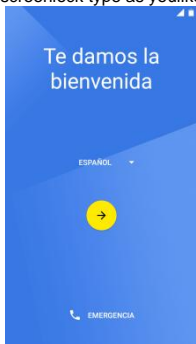

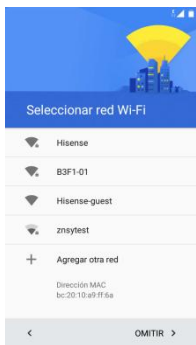

The configuration of a Google account is essential to use all the features and services of your Android phone, such as access to Google Play™, synchronization of contacts or your calendar. If you don't have Gmail or any other Google Account, go ahead and create one.

Home screen

The Home screen is the starting point for many applications and functions, and it allows you to add items like application shortcuts, or Google widgets to give you instant access to information and applications. This is the default canvas and accessible from any menu by tapping the home key .

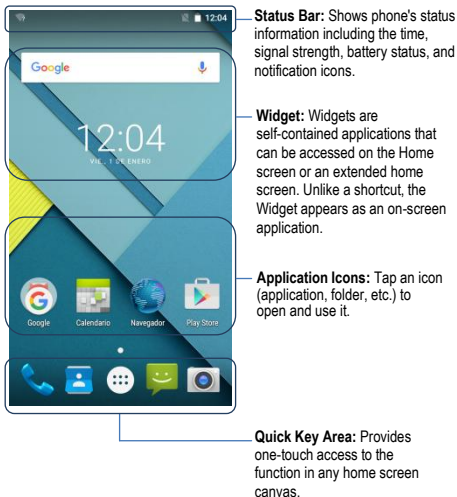

Notifications panel

Notifications alert you the arrival of new messages, calendar events, and alarms, as well as ongoing events, such as when you are on a call.

When a notification arrives, its icon appears at the top of the screen. Icons for pending notifications appear on the left, and system icons such as Wi-Fi or battery strength shown on the right.



Opening the notifications panel

Hold the status bars with your finger, and drag it downwards to open the notifications panel.

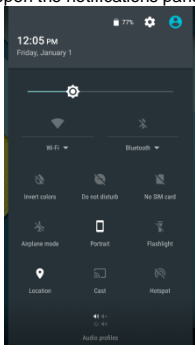

From the shortcut menu, you can quickly access to Bluetooth, Wi-Fi, Mobile Data, etc.

Customizing your screen

To add items on your Home screen

Long press the blank space of the standby interface, then select “wallpaper”.or “wiget”, you can changing wallpapers and adding wigits.



To remove an item from the Home screen

Touch and hold the icon you want to remove from the home screen, then drag it to the  remove icon.

To add an app as a Quick key

From the Apps menu or on the Home screen, touch and hold an application icon and drag it to the Quick key area.

To remove an app from the Quick key area



Touch and hold the desired quick key and drag it to the  remove icon.

Returning to recently-used applications





1. Tap the Recent key, a list of recently used applications will be displayed.
2. Tap an icon to open the application. or tap back key to return to your previous screen.

Main Function

Making and receiving a call

Touch  to enter dialer interface on idle screen or main menu screen, input phone number and click  to make a call, click the End button. If you make a mistake, you can click  to delete the number or hold it to

delete all numbers before the cursor.
During a call, you can do the following:

1. Touch  to open the dial pad.
2. Touch  to enable or disable the loud speaker function.
3. Touch  to enable or disable your microphone.
4. Touch  select Add call to add other call.
5. Touch  select Recordcall to record the call.

Adding contacts

Tap the contact icon 
Click "Create a new contact", to add a new contact to the phone or card.

Click  on the top of the screen. Input a part of the name or contact number you wish to find. All the matching contacts will be displayed.

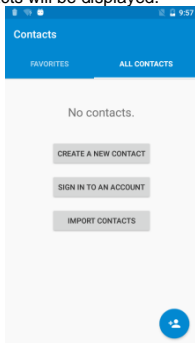

Sending message

Tap the message icon



Click  to create a message. Input recipient's phone number or name to search in contacts.

Click "Type message" to edit the message.

When you are ready to send the message, click

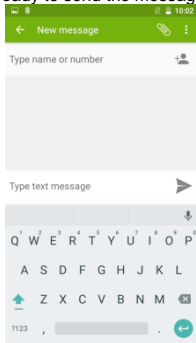

Music

Touch the music application



to enter music player.

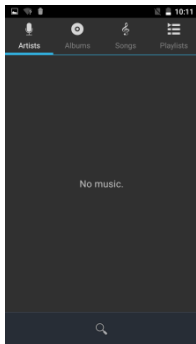

Camera

The camera app is a combination camera and camcorder that actually consists of two cameras, front camera (facing you) and main camera behind the phone.





Take photos

1. Frame your subject on the screen.
2. A green square around the subject indicates that the

camera has focused.

3. Tap  to take a photo. Your picture will be automatically saved to the Gallery.

Record videos

1. Slide the screen to the left, frame your subject on the screen.
2. Tap  to start recording the video.
3. The length of the recording is displayed on the top of the screen.
4. Click  to stop recording, when recording video, click  to take pictures

Make gesture capture

Touch “Settings-> Motions and gestures->Turnoff screen gestures” and click the button to turn on screen gestures. When screen is black, draw “s” on the screen to take a photograph.

Chrome

Connect the web page with the mobile network.

Click the icon  to open the web browser.

Through the chrome address bar/search bar, you can access web pages. Bookmarks, multiple window switching and other functions are also supported. When accessing the network, you may incur additional costs. Consult your local operators for detailed charges.

Getting connected (connection to Wi-Fi)

1. Tap the Settings icon.
2. Tap “Wi-Fi” and select on.
3. Touch the desired network you wish to connect.
4. If the network is secured, enter the password.

Important information

For an optimal experience, the phone regularly connects to mail and internet servers.

This automatically and inevitably generates data exchanges that may be charged in addition to your existing package, or may be deducted from prepaid credit or a prepaid system.

To avoid billing problems related to services that use the Internet, it is strongly recommended to have a suitable option which includes unlimited Internet and emails and to avoid changing the settings preconfigured by default. If you wish, connect to Wi-Fi for a faster and more streamlined experience. It is particularly recommended to use Wi-Fi for streaming, or downloading games, videos or large films.

Dolby

The Dolby® Digital Plus is based on core Dolby Digital technologies, design to deliver better sound quality and enhance the audio experience with advanced cinematic surround sound.

Pull down the status bar. Open the quick settings, then switch on or off Dolby. When open the Dolby, several default settings are available, such as: Movie, Music, Game, Voice and Customs.

Dolby statement:

License Notice and Trademark Acknowledgement
Manufactured under license from Dolby Laboratories.
Dolby and the double-D symbol are trademarks of Dolby Laboratories.

Disclaimer

- The usage of non-original accessories such as headsets, chargers etc. , will cause incompatibility between the mobile phone and the accessories that may cause a reduction in performance and malfunction. Hisense is not responsible for any damage that might occur from use of incompatible accessories.
- Specifications and functions of your mobile phone may

differ to those contained in this user manual.

- Specifications and functions of your mobile phone have been confirmed to work properly post-manufacturing. If there is damage or defects due to the manufacturing and not by usage, it would follow terms and conditions in the warranty card.
- If the functions of your mobile phone related to features and services by the carrier then those functions will follow the terms & conditions applicable by the carrier.
- Please note that your mobile phone still has its limitations referring to the specifications and functions. These limitations cannot be considered as damage or defect and cannot be regarded as manufacturer damage. Please use your mobile phone in accordance with the purposes and functions.

Troubleshooting

This chapter lists some problems you might encounter when using your phone. Some problems require you to call your service provider, but most are easy to fix yourself.

Message	Possible causes	Possible corrective measures
SIM card error	There is no SIM card in the phone or it is inserted incorrectly.	Make sure that the SIM card is correctly inserted.
No network connection/ Dropped network	Signal is weak or you are outside the carrier network.	Move toward a window or into an open area. Check the network operator coverage map.
	Operator applied new services.	Check whether the SIM card is too old. If so, change your SIM card at your

		network provider's nearest branch. Contact your service provider.
Codes do not match	To change a security code, you will need to confirm the new code by re-entering it.	If you forget the code, contact your service provider.
	The two codes you have entered do not match.	
Calls not available	Dialling error.	New network not authorized.
	New SIM card inserted.	Check for new restrictions.
	Pre-paid charge limit reached.	Contact service provider.
Phone cannot be switched on	Power key pressed too briefly.	Press the Power key for at least two seconds.
	Battery is not charged.	Charge battery. Check the charging indicator on the display.
Charge error	Outside temperature is too hot or cold.	Charge battery.
	Outside temperature is too hot or cold.	Make sure phone is charging at a normal temperature.
	Contact problem	Check the charger and its connection to the phone.
	No voltage.	Plug the charger into a different socket.
	Charger defective.	Replace the charger.

	Wrong charger.	Use only original accessories.
Impossible to receive / send SMS & photos	Memory full.	Delete some messages from your phone.
Files do not open	Unsupported file format.	Check the supported file formats.
The screen does not turn on when I receive a call.	Proximity sensor problem.	If you use a protection tape or case, make sure it has not covered the area around the proximity sensor. Make sure that the area around the proximity sensor is clean.
No sound	Vibration mode or silent mode.	Check the settings status in the sound menu to make sure you are not in vibration or silent mode.
Hangs up or freezes	Intermittent software problem.	Try to perform a software update via the website.
Contacts display doubly	Contacts are saved in both phone and SIM card.	Check contacts saved.
App not installed	Not supported by service provider or registration required.	Contact your service provider.
	Your mobile phone has insufficient memory.	Delete some messages from your phone.

Unable to connect to computer	Data cable defective.	Change data cable.
	Defective computer port.	Change computer port.
Call logs are not saved	Time is wrongly set.	Check the time setting.

Changes or modifications not expressly approved by the party responsible for compliance could void the user's authority to operate the equipment.

This equipment has been tested and found to comply with the limits for a Class B digital device, pursuant to Part 15 of the FCC Rules. These limits are designed to provide reasonable protection against harmful interference in a residential installation. This equipment generates, uses and can radiate radio frequency energy and, if not installed and used in accordance with the instructions, may cause harmful interference to radio communications. However, there is no guarantee that interference will not occur in a particular installation.

If this equipment does cause harmful interference to radio or television reception, which can be determined by turning the equipment off and on, the user is encouraged to try to correct the interference by one or more of the following measures:

- Reorient or relocate the receiving antenna.
- Increase the separation between the equipment and receiver.
- Connect the equipment into an outlet on a circuit different from that to which the receiver is connected.

-- Consult the dealer or an experienced radio/TV technician for help.

This equipment complies with FCC radiation exposure limits set forth for an uncontrolled environment. End user must follow the specific operating instructions for satisfying RF exposure compliance. This transmitter must not be co-located or operating in conjunction with any other antenna or transmitter.

The portable device is designed to meet the requirements for exposure to radio waves established by the Federal Communications Commission (USA). These requirements set a SAR limit of 1.6 W/kg averaged over one gram of tissue. The highest SAR value reported under this standard during product certification for use when properly worn on the body.

For body-worn operation, the phone has been tested when positioned a minimum of 15 mm from the body without any metal parts in the vicinity of the phone or when properly used with an appropriate accessory and worn on the body. For devices which include “WiFi hotspot” functionality, SAR measurements for the device operating in WiFi hotspot mode were taken using a separation distance of 10 mm.

This device complies with Part 15 of the FCC Rules. Operation is subject to the following two conditions: (1) this device may not cause harmful interference, and (2) this device must accept any interference received, including interference that may cause undesired operation.