



# TEST REPORT

No.I22N01654-SAR

For

Hisense International Co., Ltd.

Mobile phone

Model Name: HLTE239E

With

Hardware Version: FS301-MB-V1.0

Software Version: Hisense\_HLTE239E\_01\_S01\_01\_05\_MX05

FCC ID: 2ADOBHLTE239E

Issued Date: 2022-10-12

**Designation Number: CN1210**

**Note:**

The test results in this test report relate only to the devices specified in this report. This report shall not be reproduced except in full without the written approval of SAICT.

**Test Laboratory:**

**SAICT, Shenzhen Academy of Information and Communications Technology**

Building G, Shenzhen International Innovation Center, No.1006 Shennan Road, Futian District, Shenzhen, Guangdong, P. R. China 518000.

Tel:+86(0)755-33322000, Fax:+86(0)755-33322001

Email: yewu@caict.ac.cn. www.saict.ac.cn



No.I22N01654-SAR

## **REPORT HISTORY**

<b>Report Number</b>	<b>Revision</b>	<b>Description</b>	<b>Issue Date</b>
I22N01654-SAR	Rev.0	1st edition	2022-10-12



## CONTENTS

<b>1. SUMMARY OF TEST REPORT .....</b>	<b>5</b>
1.1. TEST ITEMS .....	5
1.2. TEST STANDARDS .....	5
1.3. TEST RESULT .....	5
1.4. TESTING LOCATION .....	5
1.5. PROJECT DATA .....	5
1.6. SIGNATURE .....	5
<b>2. STATEMENT OF COMPLIANCE .....</b>	<b>6</b>
<b>3. CLIENT INFORMATION .....</b>	<b>8</b>
3.1. APPLICANT INFORMATION .....	8
3.2. MANUFACTURER INFORMATION .....	8
<b>4. EQUIPMENT UNDER TEST (EUT) AND ANCILLARY EQUIPMENT (AE) .....</b>	<b>9</b>
4.1. ABOUT EUT .....	9
4.2. INTERNAL IDENTIFICATION OF EUT USED DURING THE TEST .....	10
4.3. INTERNAL IDENTIFICATION OF AE USED DURING THE TEST .....	10
4.4. GENERAL DESCRIPTION .....	10
<b>5. TEST METHODOLOGY .....</b>	<b>11</b>
5.1. APPLICABLE LIMIT REGULATIONS .....	11
5.2. APPLICABLE MEASUREMENT STANDARDS .....	11
<b>6. SPECIFIC ABSORPTION RATE (SAR) .....</b>	<b>12</b>
6.1. INTRODUCTION .....	12
6.2. SAR DEFINITION .....	12
<b>7. TISSUE SIMULATING LIQUIDS .....</b>	<b>13</b>
7.1. TARGETS FOR TISSUE SIMULATING LIQUID .....	13
7.2. DIELECTRIC PERFORMANCE .....	13
<b>8. SYSTEM VERIFICATION .....</b>	<b>18</b>
8.1. SYSTEM SETUP .....	18
8.2. SYSTEM VERIFICATION .....	19
<b>9. MEASUREMENT PROCEDURES .....</b>	<b>20</b>
9.1. TESTS TO BE PERFORMED .....	20
9.2. GENERAL MEASUREMENT PROCEDURE .....	22
9.3. WCDMA MEASUREMENT PROCEDURES FOR SAR .....	23
9.4. SAR MEASUREMENT FOR LTE .....	24
9.5. BLUETOOTH & WLAN MEASUREMENT PROCEDURES FOR SAR .....	24
9.6. POWER DRIFT .....	25



**10. CONDUCTED OUTPUT POWER .....26**

10.1. GSM MEASUREMENT RESULT ..... 26

10.2. WCDMA MEASUREMENT RESULT ..... 28

10.3. LTE MEASUREMENT RESULT ..... 30

10.4. BLUETOOTH AND WLAN MEASUREMENT RESULT ..... 59

**11. SIMULTANEOUS TX SAR CONSIDERATIONS .....61**

11.1. INTRODUCTION ..... 61

11.2. TRANSMIT ANTENNA SEPARATION DISTANCES ..... 61

11.3. SAR MEASUREMENT POSITIONS ..... 62

**12. EVALUATION OF SIMULTANEOUS.....63**

**13. SUMMARY OF TEST RESULTS .....64**

13.1. TESTING ENVIRONMENT ..... 64

13.2. SAR RESULTS..... 65

13.3. WLAN EVALUATION FOR 2.4GHZ ..... 77

13.4. WLAN EVALUATION FOR 5GHZ ..... 79

13.5. PRODUCT SPECIFIC 10G SAR..... 81

**14. SAR MEASUREMENT VARIABILITY .....82**

**15. MEASUREMENT UNCERTAINTY .....83**

15.1. MEASUREMENT UNCERTAINTY FOR NORMAL SAR TESTS (300MHZ~3GHZ) ..... 83

15.2. MEASUREMENT UNCERTAINTY FOR NORMAL SAR TESTS (3GHZ~6GHZ) ..... 84

**16. MAIN TEST INSTRUMENTS.....85**

**ANNEX A: GRAPH RESULTS .....86**

**ANNEX B: SYSTEMVERIFICATION RESULTS ..... 115**

**ANNEX C: SAR MEASUREMENT SETUP.....124**

**ANNEX D: POSITION OF THE WIRELESS DEVICE IN RELATION TO THE PHANTOM .....130**

**ANNEX E: EQUIVALENT MEDIA RECIPES .....133**

**ANNEX F: SYSTEM VALIDATION.....134**

**ANNEX G: DAE CALIBRATION CERTIFICATE .....135**

**ANNEX H: PROBE CALIBRATION CERTIFICATE .....140**

**ANNEX I: DIPOLE CALIBRATION CERTIFICATE .....149**

**ANNEX J: EXTENDED CALIBRATION SAR DIPOLE.....195**



## 1. Summary of Test Report

### 1.1. Test Items

Description: Mobile phone  
Model Name: HLTE239E  
Applicant's Name: Hisense International Co., Ltd.  
Manufacturer's Name: Hisense Communications Co., Ltd.

### 1.2. Test Standards

ANSI C95.1:1992, IEEE 1528:2013

### 1.3. Test Result

Pass. Please refer to "13. Summary of Test Results"

### 1.4. Testing Location

Address: Building G, Shenzhen International Innovation Center, No.1006 Shennan Road, Futian District, Shenzhen, Guangdong, P. R. China

### 1.5. Project Data

Testing Start Date: 2022-09-01

Testing End Date: 2022-09-30

### 1.6. Signature

---

Li Yongfu  
(Prepared this test report)

---

Zhang Yunzhuan  
(Reviewed this test report)

---

Cao Junfei  
(Approved this test report)

## 2. Statement of Compliance

The maximum results of Specific Absorption Rate (SAR) found during testing for Hisense International Co., Ltd. Mobile phone HLTE239E are as follows:

**Table 2.1: Highest Reported SAR (1g)**

Equipment Class	Frequency Bands	1g SAR (W/kg)		
		Head (Separation Distance 0mm)	Hotspot (Separation Distance 10mm)	Body-worn (Separation Distance 10/15mm)
PCE	GSM 850	0.29	0.39	0.39
	GSM 1900	0.32	0.14	0.14
	WCDMA Band 2	0.95	0.30	0.30
	WCDMA Band 4	0.21	0.05	0.05
	WCDMA Band 5	0.21	0.25	0.25
	LTE Band 2	0.61	0.26	0.26
	LTE Band 4	0.57	0.21	0.21
	LTE Band 5	0.25	0.32	0.32
	LTE Band 7	<b>1.03</b>	0.37	0.37
	LTE Band 12	0.23	<b>0.47</b>	<b>0.47</b>
LTE Band 26	0.25	0.34	0.34	
DSS	Bluetooth	0.02	0.05	0.01
DTS	WLAN 2.4GHz	0.21	0.07	0.04
NII	WLAN 5GHz	0.70	0.43	0.34

**Table 2.2: Highest Reported SAR (10g)**

Equipment Class	Frequency Bands	Extremity 10g SAR (W/Kg) (Separation Distance 0mm)
NII	WLAN 5GHz	<b>0.90</b>

The SAR values found for the Mobile Phone are below the maximum recommended levels of 1.6 W/Kg as averaged over any 1g tissue according to the ANSI C95.1-1992.

The measurement together with the test system set-up is described in annex C of this test report. A detailed description of the equipment under test can be found in chapter 4 of this test report.

The highest reported SAR value is obtained at the case of **(Table 2.1 & 2.2)**, Head value is **1.03 W/kg (1g)**, Hotspot value is **0.47 W/kg (1g)**, Body-worn value is **0.47 W/kg (1g)** and Extremity SAR value is **0.90 W/kg (10g)**.



**Table 2.3: Maximum Simultaneous Transmission SAR**

/	Position	Sum (W/kg)
Highest reported SAR value for Head	Right Tilt (LTE Band 7 + WLAN 5HGhz + Bluetooth)	<b>1.59</b>
Highest reported SAR value for Hotspot	Rear Side (LTE Band 12 + WLAN 5HGhz + Bluetooth)	<b>0.91</b>
Highest reported SAR value for Body-worn	Rear Side (LTE Band 12 + WLAN 5HGhz + Bluetooth)	<b>0.82</b>

Note: the test positions of above tables are for the worse case that has been evaluated.

According to the above tables, the highest sum of reported SAR values is **1.59 W/kg (1g)**.

The detail for simultaneous transmission consideration is described in chapter 12.



### 3. Client Information

#### 3.1. Applicant Information

Company Name:	Hisense International Co., Ltd.
Address:	Floor 22, Hisense Tower, 17 Donghai Xi Road, Qingdao, 266071, China
City:	Qingdao
Country:	China
Telephone:	+86 15311226475

#### 3.2. Manufacturer Information

Company Name:	Hisense Communications Co., Ltd.
Address:	No.218, Qianwangang Road, Economic and Technological Development Zone, Qingdao, Shandong Province, China
City:	Qingdao
Country:	China
Telephone:	+86 15311226475





## 4. Equipment under Test (EUT) and Ancillary Equipment (AE)

### 4.1. About EUT

Description:	Mobile phone
Model Name:	HLTE239E
Condition of EUT as received:	No obvious damage in appearance
Frequency Bands:	GSM 850/1900, WCDMA Band 2/4/5, LTE Band 2/4/5/7/12/26, Bluetooth, WLAN 2.4GHz, WLAN 5GHz
Tested Tx Frequency:	824 – 849MHz (GSM 850)
	1850 – 1910MHz (GSM 1900)
	1850 – 1910MHz (WCDMA Band 2)
	1710 – 1755MHz (WCDMA Band 4)
	824 – 849MHz (WCDMA Band 5)
	1850 – 1910MHz (LTE Band 2)
	1700 – 1755MHz (LTE Band 4)
	824 – 849MHz (LTE Band 5)
	2500 – 2570MHz (LTE Band 7)
	699 – 716MHz (LTE Band 12)
	814 – 849MHz (LTE Band 26)
	2402 – 2480MHz (Bluetooth)
	2412 – 2462MHz (WLAN 2.4GHz)
	5150 – 5850MHz (WLAN 5GHz)
GPRS / EGPRS Multislot Class:	12
GPRS capability Class:	B
Test device Production information:	Production unit
Device type:	Portable device
Antenna type:	Integrated antenna
Hotspot mode:	Support
Product Dimensions:	Long 165.4mm;Wide 76.4mm;Overall Diagonal 174.7mm
<b>Remark:</b>	
1. This device does not support DTM operation.	
2. This device WLAN 5GHz U-NII-2A and U-NII-2C don't support hotspot operation.	

#### 4.2. Internal Identification of EUT used during the test

EUT ID*	IMEI	HW Version	SW Version	Receipt Date
UT06aa	865269060000374	FS301-MB-V1.0	Hisense_HLTE239E_0 1_S01_01_05_MX05	2022-08-30
UT07aa	865269060000176	FS301-MB-V1.0	Hisense_HLTE239E_0 1_S01_01_05_MX05	2022-08-30
UT08aa	865269060000333	FS301-MB-V1.0	Hisense_HLTE239E_0 1_S01_01_05_MX05	2022-08-30
UT15aa	868551060008870	FS301-MB-V1.0	Hisense_HLTE239E_0 1_S01_01_05_MX05	2022-08-30
UT16aa	868551060009845	FS301-MB-V1.0	Hisense_HLTE239E_0 1_S01_01_05_MX05	2022-08-30

\*EUT ID: is used to identify the test sample in the lab internally.

**Note:** It is performed to test SAR with the UT06aa & UT08aa & UT15aa & UT16aa, and conducted power with the UT07aa.

#### 4.3. Internal Identification of AE used during the test

AE ID*	Description	Model	Manufacturer
AE1	Battery	LPN385400B	Shenzhen Aerospace Electronic Co., Ltd.
AE2	Headset	KS232D	Dongguan Keling Electronic Technology Co., Ltd.

\*AE ID: is used to identify the test sample in the lab internally.

#### 4.4. General Description

According to “Justification Letter” provided by applicant, the table below shows the difference between Config1 and Config2:

Config1 (Main Supply)

Part Name	Model	Supplier(Brand)	Description
Camera	H8B8-KS229FF	Hunan Kingcome OPtoelectronics CO.,LTD	Front CAM
LCM	TM065JVHC32	Tianma Microelectronics Co., Ltd.	/

Config2 (Secondary Supply)

Part Name	Model	Supplier(Brand)	Description
Camera	BM18639	LUZHOU Chengxiangtong technology CO.,LTD	Front CAM
LCM	TXDY650EBAPUG-63V3	Company profile of ShenZhen TXD Technology Co.,Ltd	/

We'll perform the SAR measurement with Config1 and Spot check test with Config2.



## 5. Test Methodology

### 5.1. Applicable Limit Regulations

**ANSI C95.1:1992** IEEE Standard for Safety Levels with Respect to Human Exposure to Radio Frequency Electromagnetic Fields, 3 kHz to 300 GHz.

It specifies the maximum exposure limit of **1.6 W/kg** as averaged over any 1 gram of tissue for portable devices being used within 20 cm of the user in the uncontrolled environment.

### 5.2. Applicable Measurement Standards

**IEEE 1528:2013** Recommended Practice for Determining the Peak Spatial-Average Specific Absorption Rate (SAR) in the Human Head from Wireless Communications Devices: Experimental Techniques.

**KDB 447498 D01 General RF Exposure Guidance v06** RF Exposure Procedures and Equipment Authorization Policies for Mobile and Portable Devices

**KDB 648474 D04 Handset SAR v01r03** SAR Evaluation Considerations for Wireless Handsets.

**KDB 941225 D01 SAR test for 3G devices v03r01** SAR Measurement Procedures for 3G Devices

**KDB 941225 D05 SAR for LTE Devices v02r05** SAR Evaluation Considerations for LTE Devices

**KDB 941225 D06 Hot Spot SAR v02r01** SAR Evaluation Procedures for Portable Devices with Wireless Router Capabilities

**KDB 248227 D01 802.11 Wi-Fi SAR v02r02** SAR Guidance for IEEE 802.11 (Wi-Fi) Transmitters.

**KDB 865664 D01 SAR measurement 100 MHz to 6 GHz v01r04** SAR Measurement Requirements for 100 MHz to 6 GHz

**KDB 865664 D02 RF Exposure Reporting v01r02** RF Exposure Compliance Reporting and Documentation Considerations

**KDB 941225 D07 UMPC Mini Tablet v01r02** SAR Evaluation Procedures for UMPC Mini-Tablet Devices

**TCB workshop April 2019; RF Exposure Procedures (Tissue Simulating Liquids)**

## 6. Specific Absorption Rate (SAR)

### 6.1. Introduction

SAR is related to the rate at which energy is absorbed per unit mass in an object exposed to a radio field. The SAR distribution in a biological body is complicated and is usually carried out by experimental techniques or numerical modeling. The standard recommends limits for two tiers of groups, occupational/controlled and general population/uncontrolled, based on a person's awareness and ability to exercise control over his or her exposure. In general, occupational/controlled exposure limits are higher than the limits for general population/uncontrolled.

### 6.2. SAR Definition

The SAR definition is the time derivative (rate) of the incremental energy ( $dW$ ) absorbed by (dissipated in) an incremental mass ( $dm$ ) contained in a volume element ( $dv$ ) of a given density ( $\rho$ ). The equation description is as below:

$$SAR = \frac{d}{dt} \left( \frac{dW}{dm} \right) = \frac{d}{dt} \left( \frac{dW}{\rho dv} \right)$$

SAR is expressed in units of Watts per kilogram (W/kg)

SAR measurement can be either related to the temperature elevation in tissue by

$$SAR = c \left( \frac{\delta T}{\delta t} \right)$$

Where:  $C$  is the specific heat capacity,  $\delta T$  is the temperature rise and  $\delta t$  is the exposure duration, or related to the electrical field in the tissue by

$$SAR = \frac{\sigma |E|^2}{\rho}$$

Where:  $\sigma$  is the conductivity of the tissue,  $\rho$  is the mass density of tissue and  $E$  is the RMS electrical field strength.

However for evaluating SAR of low power transmitter, electrical field measurement is typically applied.

## 7. Tissue Simulating Liquids

### 7.1. Targets for tissue simulating liquid

**Table 7.1: Targets for tissue simulating liquid**

Frequency (MHz)	Liquid Type	Conductivity ( $\sigma$ )	$\pm 5\%$ Range	Permittivity ( $\epsilon$ )	$\pm 5\%$ Range
750	Head	0.89	0.85~0.93	41.9	39.8~44.0
835	Head	0.90	0.86~0.95	41.5	39.4~43.6
1750	Head	1.37	1.30~1.44	40.1	38.1~42.1
1900	Head	1.40	1.33~1.47	40.0	38.0~42.0
2450	Head	1.80	1.71~1.89	39.2	37.2~41.2
2550	Head	1.91	1.81~2.01	39.1	37.1~41.0
5250	Head	4.71	4.47~4.95	35.9	34.1~37.7
5600	Head	5.07	4.82~5.32	35.5	33.8~37.3
5750	Head	5.22	4.96~5.48	35.4	33.6~37.1

### 7.2. Dielectric Performance

**Table 7.2: Dielectric Performance of Tissue Simulating Liquid**

Measurement Date (yyyy-mm-dd)	Type	Frequency (MHz)	Conductivity $\sigma$ (S/m)	Drift (%)	Permittivity $\epsilon$	Drift (%)
2022-09-10	750	Head	0.904	1.57	40.88	-2.43
2022-09-09	835	Head	0.918	2.00	40.60	-2.17
2022-09-02	1750	Head	1.363	-0.51	40.55	1.12
2022-09-01	1900	Head	1.385	-1.07	40.37	0.92
2022-09-27	2450	Head	1.832	1.78	38.44	-1.94
2022-09-30	2550	Head	1.946	1.88	38.18	-2.35
2022-09-17	5250	Head	4.787	1.63	34.99	-2.53
2022-09-17	5600	Head	5.169	1.95	34.73	-2.17
2022-09-17	5750	Head	5.111	-2.09	36.35	2.68

Note: The liquid temperature is 22.0°C.



**Picture 7-1: Liquid depth in the Head Phantom (750MHz)**

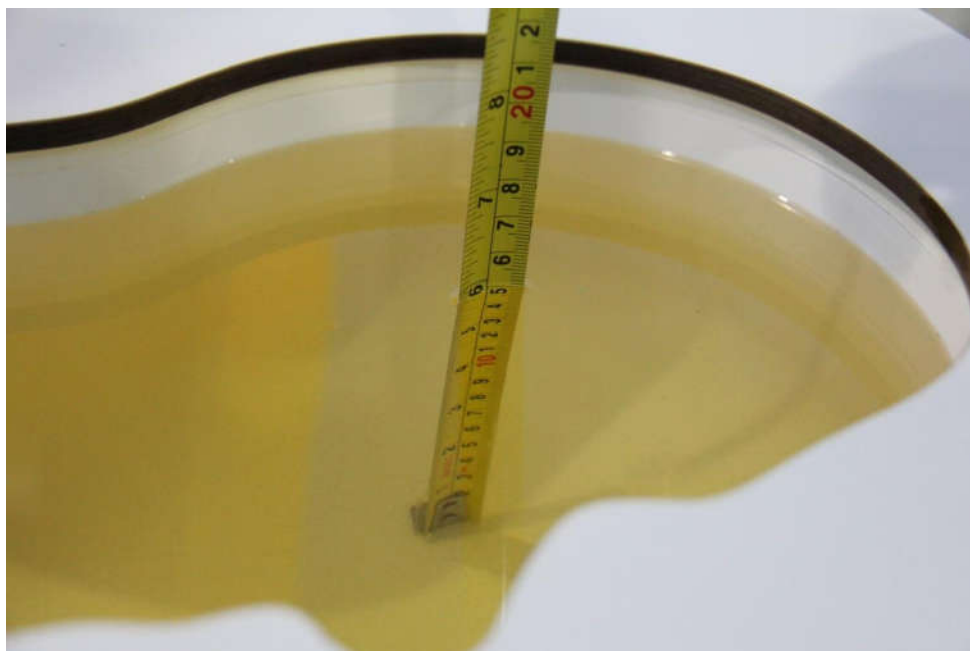

**Picture 7-2: Liquid depth in the Head Phantom (835MHz)**



**Picture 7-3: Liquid depth in the Head Phantom (1750MHz)**



**Picture 7-4: Liquid depth in the Head Phantom (1900MHz)**

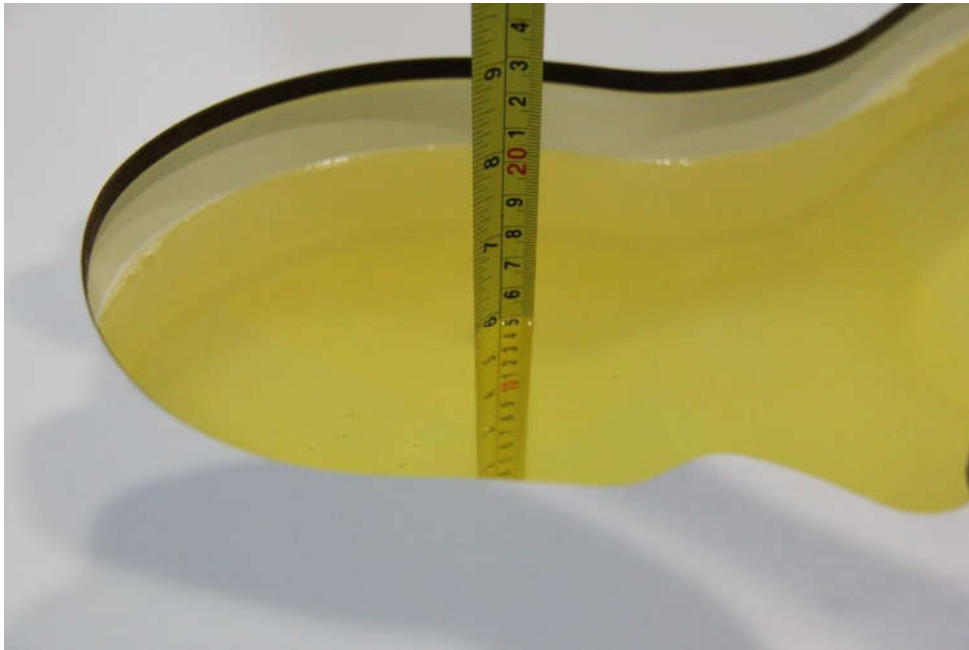

**Picture 7-5: Liquid depth in the Head Phantom (2450MHz)**



**Picture 7-6: Liquid depth in the Head Phantom (2550MHz)**





**Picture 7-7: Liquid depth in the Head Phantom (5GHz)**

## 8. System verification

### 8.1. System Setup

In the simplified setup for system evaluation, the DUT is replaced by a calibrated dipole and the power source is replaced by a continuous wave that comes from a signal generator. The calibrated dipole must be placed beneath the flat phantom section of the SAM twin phantom with the correct distance holder. The distance holder should touch the phantom surface with a light pressure at the reference marking and be oriented parallel to the long side of the phantom. The equipment setup is shown below:

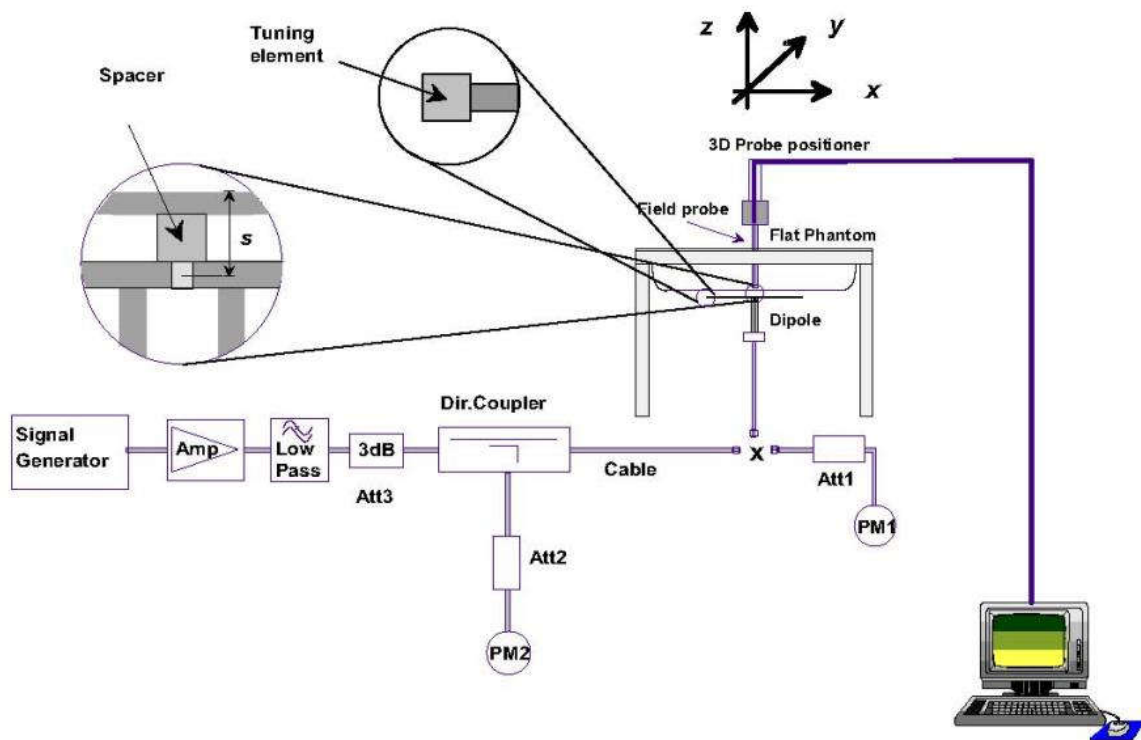

**Picture 8.1 System Setup for System Evaluation**

For the dipole below 3GHz, the output power on dipole port must be calibrated to 24 dBm (250mW) before dipole is connected.

For the dipole above 3GHz, the output power on dipole port must be calibrated to 20 dBm (100mW) before dipole is connected.



Picture 8.2 Photo of Dipole Setup

## 8.2. System Verification

SAR system verification is required to confirm measurement accuracy, according to the tissue dielectric media, probe calibration points and other system operating parameters required for measuring the SAR of a test device. The system verification must be performed for each frequency band and within the valid range of each probe calibration point required for testing the device.

Table 8.1: System Verification of Head

Measurement Date	Frequency (MHz)	Target value (W/kg)		Measured value (W/kg)				Deviation (%)	
				/		Normalize to 1W			
		10 g	1 g	10 g	1 g	10 g	1 g	10 g	1 g
2022-09-10	750	5.62	8.48	1.43	2.19	5.72	8.76	1.78	3.30
2022-09-09	835	6.29	9.64	1.62	2.52	6.48	10.08	3.02	4.56
2022-09-02	1750	19.60	36.30	4.79	8.73	19.16	34.92	-2.24	-3.80
2022-09-01	1900	20.50	40.20	5.04	9.80	20.16	39.20	-1.66	-2.49
2022-09-27	2450	24.20	53.20	6.15	13.7	24.60	54.80	1.65	3.01
2022-09-30	2550	25.20	55.90	6.42	14.4	25.68	57.60	1.90	3.04
2022-09-17	5250	22.80	79.70	2.34	8.28	23.40	82.80	2.63	3.89
2022-09-17	5600	23.60	82.60	2.42	8.60	24.20	86.00	2.54	4.12
2022-09-17	5750	22.10	78.50	2.17	7.59	21.70	75.90	-1.81	-3.31

## 9. Measurement Procedures

### 9.1. Tests to be performed

In order to determine the highest value of the peak spatial-average SAR of a handset, all device positions, configurations and operational modes shall be tested for each frequency band according to steps 1 to 3 below. A flowchart of the test process is shown in picture 9.1.

**Step 1:** The tests described in 9.2 shall be performed at the channel that is closest to the center of the transmit frequency band ( $f_c$ ) for:

- a) all device positions (cheek and tilt, for both left and right sides of the SAM phantom, as described in annex D),
- b) all configurations for each device position in a), e.g., antenna extended and retracted, and
- c) all operational modes, e.g., analogue and digital, for each device position in a) and configuration in b) in each frequency band.

If more than three frequencies need to be tested according to 11.1 (i.e.,  $N_c > 3$ ), then all frequencies, configurations and modes shall be tested for all of the above test conditions.

**Step 2:** For the condition providing highest peak spatial-average SAR determined in Step 1, perform all tests described in 9.2 at all other test frequencies, i.e., lowest and highest frequencies. In addition, for all other conditions (device position, configuration and operational mode) where the peak spatial-average SAR value determined in Step 1 is within 3 dB of the applicable SAR limit, it is recommended that all other test frequencies shall be tested as well.

**Step 3:** Examine all data to determine the highest value of the peak spatial-average SAR found in Steps 1 to 2.

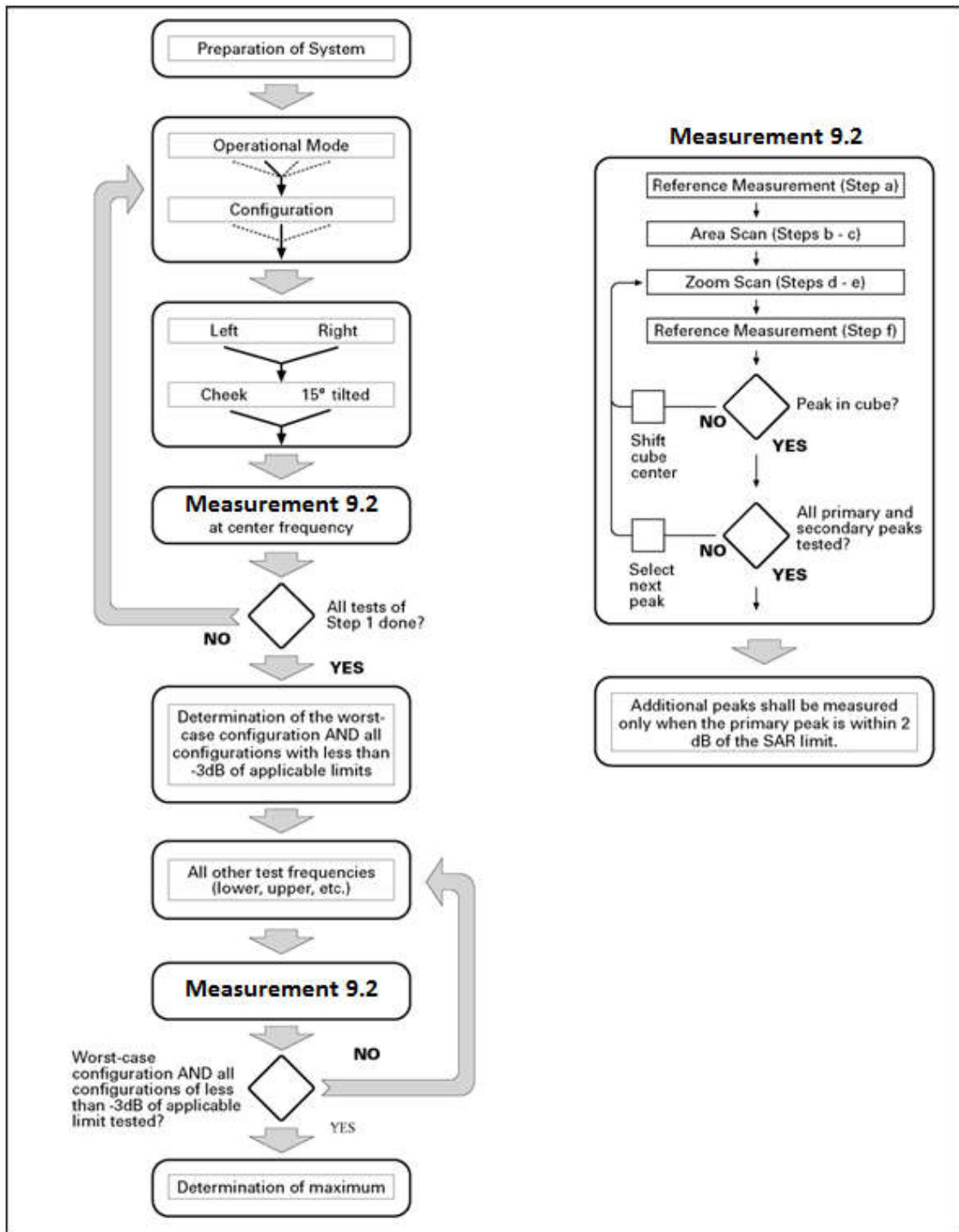

Picture 9.1 Block diagram of the tests to be performed

## 9.2. General Measurement Procedure

The area and zoom scan resolutions specified in the table below must be applied to the SAR measurements and fully documented in SAR reports to qualify for TCB approval. Probe boundary effect error compensation is required for measurements with the probe tip closer than half a probe tip diameter to the phantom surface. Both the probe tip diameter and sensor offset distance must satisfy measurement protocols; to ensure probe boundary effect errors are minimized and the higher fields closest to the phantom surface can be correctly measured and extrapolated to the phantom surface for computing 1-g SAR. Tolerances of the post-processing algorithms must be verified by the test laboratory for the scan resolutions used in the SAR measurements, according to the reference distribution functions specified in IEEE Std 1528-2013. The results should be documented as part of the system validation records and may be requested to support test results when all the measurement parameters in the following table are not satisfied.

		$\leq 3$ GHz	$> 3$ GHz
Maximum distance from closest measurement point (geometric center of probe sensors) to phantom surface		$5 \pm 1$ mm	$\frac{1}{2} \cdot \delta \cdot \ln(2) \pm 0.5$ mm
Maximum probe angle from probe axis to phantom surface normal at the measurement location		$30^\circ \pm 1^\circ$	$20^\circ \pm 1^\circ$
Maximum area scan spatial resolution: $\Delta x_{Area}, \Delta y_{Area}$		$\leq 2$ GHz: $\leq 15$ mm 2 – 3 GHz: $\leq 12$ mm	3 – 4 GHz: $\leq 12$ mm 4 – 6 GHz: $\leq 10$ mm
		When the x or y dimension of the test device, in the measurement plane orientation, is smaller than the above, the measurement resolution must be $\leq$ the corresponding x or y dimension of the test device with at least one measurement point on the test device.	
Maximum zoom scan spatial resolution: $\Delta x_{Zoom}, \Delta y_{Zoom}$		$\leq 2$ GHz: $\leq 8$ mm 2 – 3 GHz: $\leq 5$ mm*	3 – 4 GHz: $\leq 5$ mm* 4 – 6 GHz: $\leq 4$ mm*
Maximum zoom scan spatial resolution, normal to phantom surface	uniform grid: $\Delta z_{Zoom}(n)$	$\leq 5$ mm	3 – 4 GHz: $\leq 4$ mm 4 – 5 GHz: $\leq 3$ mm 5 – 6 GHz: $\leq 2$ mm
	graded grid $\Delta z_{Zoom}(1)$ : between 1 <sup>st</sup> two points closest to phantom surface	$\leq 4$ mm	3 – 4 GHz: $\leq 3$ mm 4 – 5 GHz: $\leq 2.5$ mm 5 – 6 GHz: $\leq 2$ mm
	$\Delta z_{Zoom}(n>1)$ : between subsequent points	$\leq 1.5 \cdot \Delta z_{Zoom}(n-1)$	
Minimum zoom scan volume	x, y, z	$\geq 30$ mm	3 – 4 GHz: $\geq 28$ mm 4 – 5 GHz: $\geq 25$ mm 5 – 6 GHz: $\geq 22$ mm
Note: $\delta$ is the penetration depth of a plane-wave at normal incidence to the tissue medium; see draft standard IEEE P1528-2011 for details. * When zoom scan is required and the <i>reported</i> SAR from the area scan based <i>1-g SAR estimation</i> procedures of KDB 447498 is $\leq 1.4$ W/kg, $\leq 8$ mm, $\leq 7$ mm and $\leq 5$ mm zoom scan resolution may be applied, respectively, for 2 GHz to 3 GHz, 3 GHz to 4 GHz and 4 GHz to 6 GHz.			

### 9.3. WCDMA Measurement Procedures for SAR

The following procedures are applicable to WCDMA handsets operating under 3GPP Release99, Release 5 and Release 6. The default test configuration is to measure SAR with an established radio link between the DUT and a communication test set using a 12.2kbps RMC (reference measurement channel) configured in Test Loop Mode 1. SAR is selectively confirmed for other physical channel configurations (DPCCH & DPDCH<sub>n</sub>), HSDPA and HSPA (HSUPA/HSDPA) modes according to output power, exposure conditions and device operating capabilities. Both uplink and downlink should be configured with the same RMC or AMR, when required. SAR for Release 5 HSDPA and Release 6 HSPA are measured using the applicable FRC (fixed reference channel) and E-DCH reference channel configurations. Maximum output power is verified according to applicable versions of 3GPP TS 34.121 and SAR must be measured according to these maximum output conditions. When Maximum Power Reduction (MPR) is not implemented according to Cubic Metric (CM) requirements for Release 6 HSPA, the following procedures do not apply.

#### For Release 5 HSDPA Data Devices:

Sub-test	$\beta_c$	$\beta_d$	$\beta_d$ (SF)	$\beta_c / \beta_d$	$\beta_{hs}$	CM/dB
1	2/15	15/15	64	2/15	4/15	0.0
2	12/15	15/15	64	12/15	24/25	1.0
3	15/15	8/15	64	15/8	30/15	1.5
4	15/15	4/15	64	15/4	30/15	1.5

#### For Release 6 HSPA Data Devices

Sub-test	$\beta_c$	$\beta_d$	$\beta_d$ (SF)	$\beta_c / \beta_d$	$\beta_{hs}$	$\beta_{ec}$	$\beta_{ed}$	$\beta_{ed}$ (SF)	$\beta_{ed}$ (codes)	CM (dB)	MPR (dB)	AG Index	E-TFCI
1	11/15	15/15	64	11/15	22/15	209/225	1039/225	4	1	1.0	0.0	20	75
2	6/15	15/15	64	6/15	12/15	12/15	12/15	4	1	3.0	2.0	12	67
3	15/15	9/15	64	15/9	30/15	30/15	$\beta_{ed1}:47/15$ $\beta_{ed2}:47/15$	4	2	2.0	1.0	15	92
4	2/15	15/15	64	2/15	4/15	4/15	56/75	4	1	3.0	2.0	17	71
5	15/15	15/15	64	15/15	24/15	30/15	134/15	4	1	1.0	0.0	21	81

#### 9.4. SAR Measurement for LTE

SAR tests for LTE are performed with a base station simulator, Anristu MT8820C. Closed loop power control was used so the UE transmits with maximum output power during SAR testing. All powers were measured with the Anristu MT8820C. It is performed for conducted power and SAR based on the KDB941225 D05.

SAR is evaluated separately according to the following procedures for the different test positions in each exposure condition – head, body, body-worn accessories and other use conditions. The procedures in the following subsections are applied separately to test each LTE frequency band.

1) QPSK with 1 RB allocation

Start with the largest channel bandwidth and measure SAR for QPSK with 1 RB allocation, using the RB offset and required test channel combination with the highest maximum output power among RB offsets at the upper edge, middle and lower edge of each required test channel. When the reported SAR is  $\leq 0.8$  W/kg, testing of the remaining RB offset configurations and required test channels is not required for 1 RB allocation; otherwise, SAR is required for the remaining required test channels and only for the RB offset configuration with the highest output power for that channel. When the reported SAR of a required test channel is  $> 1.45$  W/kg, SAR is required for all three RB offset configurations for that required test channel.

2) QPSK with 50% RB allocation

The procedures required for 1 RB allocation in 1) are applied to measure the SAR for QPSK with 50% RB allocation.

3) QPSK with 100% RB allocation

For QPSK with 100% RB allocation, SAR is not required when the highest maximum output power for 100 % RB allocation is less than the highest maximum output power in 50% and 1 RB allocations and the highest reported SAR for 1 RB and 50% RB allocation in 1) and 2) are  $\leq 0.8$  W/kg. Otherwise, SAR is measured for the highest output power channel; and if the reported SAR is  $> 1.45$  W/kg, the remaining required test channels must also be tested.

#### 9.5. Bluetooth & WLAN Measurement Procedures for SAR

Normal network operating configurations are not suitable for measuring the SAR of 802.11 transmitters in general. Unpredictable fluctuations in network traffic and antenna diversity conditions can introduce undesirable variations in SAR results. The SAR for these devices should be measured using chipset based test mode software to ensure that the results are consistent and reliable.

Chipset based test mode software is hardware dependent and generally varies among manufacturers. The device operating parameters established in a test mode for SAR measurements must be identical to those programmed in production units, including output power levels, amplifier gain settings and other RF performance tuning parameters. The test frequencies should correspond to actual channel frequencies defined for domestic use. SAR for devices with switched diversity should be measured with only one antenna transmitting at a time during each SAR measurement, according to a fixed modulation and data rate. The same data pattern should be used for all measurements.





## 9.6. Power Drift

To control the output power stability during the SAR test, DASY5 system calculates the power drift by measuring the E-field at the same location at the beginning and at the end of the measurement for each test position. These drift values can be found in Section 14 labeled as: (Power Drift [dB]). This ensures that the power drift during one measurement is within 5%.

## 10. Conducted Output Power

### 10.1. GSM Measurement result

During the process of testing, the EUT was controlled via Agilent Digital Radio Communication tester (E5515C) to ensure the maximum power transmission and proper modulation. This result contains conducted output power for the EUT. In all cases, the measured peak output power should be greater and within 5% than EMI measurement.

**Table 10.1: The conducted power measurement results for GSM / GPRS/ EGPRS**

GSM 850 Speech	Tune up	Measured Power (dBm)			calculation	Averaged Power (dBm)		
		Ch.251	Ch.190	Ch.128		Ch.251	Ch.190	Ch.128
1Tx slot	<b>33.5</b>	<b>32.41</b>	<b>32.48</b>	<b>32.52</b>	/	/	/	/
GPRS850/ EGPRS850	/	Measured Power (dBm)			calculation	Averaged Power (dBm)		
		Ch.251	Ch.190	Ch.128		Ch.251	Ch.190	Ch.128
1Tx-slots	<b>33.5</b>	32.46	32.42	32.45	-9.03dB	23.43	23.39	23.42
<b>2Tx-slots</b>	<b>31.5</b>	<b>30.52</b>	<b>30.54</b>	<b>30.66</b>	-6.02dB	24.50	24.52	24.64
3Tx-slots	<b>29.5</b>	28.41	28.43	28.54	-4.26dB	24.15	24.17	24.28
4Tx-slots	<b>27.5</b>	26.27	26.31	26.32	-3.01dB	23.26	23.30	23.31
EGPRS 850 (8PSK)	/	Measured Power (dBm)			calculation	Averaged Power (dBm)		
		Ch.251	Ch.190	Ch.128		Ch.251	Ch.190	Ch.128
1Tx-slots	<b>27.5</b>	26.41	26.49	26.61	-9.03dB	17.38	17.46	17.58
2Tx-slots	<b>25.5</b>	24.34	24.17	24.42	-6.02dB	18.32	18.15	18.40
3Tx-slots	<b>22.5</b>	21.83	21.90	22.01	-4.26dB	17.57	17.64	17.75
4Tx-slots	<b>20.5</b>	19.28	19.22	19.36	-3.01dB	16.27	16.21	16.35

GSM 1900 Speech	Tune up	Measured Power (dBm)			calculation	Averaged Power (dBm)		
		Ch.810	Ch.661	Ch.512		Ch.810	Ch.661	Ch.512
1Tx slot	30.5	29.48	29.55	29.54	/	/	/	/
GPRS1900/ EGPRS1900	/	Measured Power (dBm)			calculation	Averaged Power (dBm)		
		Ch.810	Ch.661	Ch.512		Ch.810	Ch.661	Ch.512
1Tx-slots	30.5	29.46	29.53	29.58	-9.03dB	20.43	20.50	20.55
2Tx-slots	28.5	27.44	27.51	27.88	-6.02dB	21.42	21.49	21.86
3Tx-slots	26.5	25.31	25.52	25.78	-4.26dB	21.05	21.26	21.52
4Tx-slots	24.5	23.19	23.40	23.62	-3.01dB	20.18	20.39	20.61
EGPRS1900 (8PSK)	/	Measured Power (dBm)			calculation	Averaged Power (dBm)		
		Ch.810	Ch.661	Ch.512		Ch.810	Ch.661	Ch.512
1Tx-slots	27.5	27.01	26.61	26.47	-9.03dB	17.98	17.58	17.44
2Tx-slots	25.5	24.78	24.28	24.25	-6.02dB	18.76	18.26	18.23
3Tx-slots	23.5	23.01	22.40	22.45	-4.26dB	18.75	18.14	18.19
4Tx-slots	21.5	20.51	20.25	20.31	-3.01dB	17.50	17.24	17.30

Notes:

1) Division Factors

To average the power, the division factor is as follows:

1TX-slot = 1 transmit time slot out of 8 time slots=> conducted power divided by (8/1) => -9.03dB

2TX-slots = 2 transmit time slots out of 8 time slots=> conducted power divided by (8/2) => -6.02dB

3TX-slots = 3 transmit time slots out of 8 time slots=> conducted power divided by (8/3) => -4.26dB

4TX-slots = 4 transmit time slots out of 8 time slots=> conducted power divided by (8/4) => -3.01dB

**According to the conducted power as above, the body measurements are performed with 2Tx slots for GSM850 and GSM1900.**

## 10.2. WCDMA Measurement result

Table 10.2: The conducted power measurement results WCDMA

Item	band	WCDMA Band 2			
	ARFCN	Tune up	Ch.9538 (1907.6MHz)	Ch.9400 (1880MHz)	Ch.9262 (1852.4MHz)
WCDMA	\	23.0	21.60	21.80	21.70
HSUPA	1	20.5	18.60	18.70	18.70
	2	20.5	19.10	19.30	19.20
	3	20.5	18.90	19.10	19.00
	4	20.5	19.40	19.60	19.50
	5	22.0	21.40	21.50	21.30
HSDPA	1	22.0	21.30	21.50	21.50
	2	22.0	21.00	21.10	21.10
	3	22.0	20.80	20.90	20.90
	4	22.0	20.80	21.00	21.00
DC-HSDPA	1	22.0	21.30	21.40	21.50
	2	22.0	21.10	21.10	21.10
	3	22.0	20.70	20.80	20.90
	4	22.0	20.80	20.90	20.90
Item	band	WCDMA Band 4			
	ARFCN	Tune up	Ch.1513 (1752.6MHz)	Ch.1413 (1732.6MHz)	Ch.1312 (1712.4MHz)
WCDMA	\	23.0	22.00	22.00	22.00
HSUPA	1	20.5	20.00	20.00	20.10
	2	20.5	20.00	20.20	20.20
	3	20.5	20.00	20.00	20.10
	4	20.5	20.30	20.60	20.50
	5	22.0	20.70	20.90	20.70
HSDPA	1	22.0	21.50	21.70	21.60
	2	22.0	21.50	21.70	21.60
	3	22.0	21.50	21.60	21.60
	4	22.0	21.50	21.60	21.60
DC-HSDPA	1	22.0	21.60	21.60	21.60
	2	22.0	21.50	21.60	21.60
	3	22.0	21.40	21.50	21.60
	4	22.0	21.50	21.50	21.60



Item	band	WCDMA Band 5			
	ARFCN	Tune up	Ch.4233 (846.6MHz)	Ch.4183 (836.6MHz)	Ch.4132 (826.4MHz)
<b>WCDMA</b>	\	<b>23.0</b>	<b>21.90</b>	<b>21.90</b>	<b>21.90</b>
<b>HSUPA</b>	1	<b>20.5</b>	19.00	19.00	18.70
	2	<b>20.5</b>	19.40	19.30	19.00
	3	<b>20.5</b>	19.00	19.00	18.80
	4	<b>20.5</b>	19.10	19.10	18.80
	5	<b>22.0</b>	21.20	21.20	21.00
<b>HSDPA</b>	1	<b>22.0</b>	21.20	21.20	21.00
	2	<b>22.0</b>	21.00	21.00	20.70
	3	<b>22.0</b>	20.60	20.60	20.30
	4	<b>22.0</b>	20.70	20.60	20.30
<b>DC-HSDPA</b>	1	<b>22.0</b>	21.20	21.10	21.20
	2	<b>22.0</b>	21.00	21.00	21.90
	3	<b>22.0</b>	20.60	20.40	20.20
	4	<b>22.0</b>	20.70	20.50	20.30



10.3. LTE Measurement result

Table 10.3: The conducted Power for LTE

LTE Band 2			Actual output Power (dBm)			Tune up		
Band -width	RB No. / RB offset	Frequency (MHz)	Modulation			Modulation		
			QPSK	16QAM	64QAM	QPSK	16QAM	64QAM
1.4 MHz	1RB_5	1909.3	22.72	22.92	/	24.0	24.0	/
		1880.0	22.80	22.41	/			
		1850.7	22.70	22.88	/			
	1RB_3	1909.3	22.63	22.86	/			
		1880.0	22.94	22.54	/			
		1850.7	22.67	22.87	/			
	1RB_0	1909.3	22.67	22.85	/			
		1880.0	22.91	22.46	/			
		1850.7	22.70	22.96	/			
	3RB_3	1909.3	22.86	22.65	/			
		1880.0	22.94	22.51	/			
		1850.7	22.83	22.68	/			
	3RB_1	1909.3	22.95	22.67	/			
		1880.0	22.84	22.33	/			
		1850.7	22.89	22.61	/			
	3RB_0	1909.3	22.93	22.65	/			
		1880.0	22.95	22.29	/			
		1850.7	22.82	22.66	/			
	6RB_0	1909.3	22.28	21.10	/	23.0	22.0	/
		1880.0	22.30	21.41	/			
		1850.7	22.28	21.26	/			



LTE Band 2			Actual output Power (dBm)			Tune up		
Band -width	RB No. / RB offset	Frequency (MHz)	Modulation			Modulation		
			QPSK	16QAM	64QAM	QPSK	16QAM	64QAM
3 MHz	1RB_14	1908.5	22.71	22.35	/	24.0	24.0	/
		1880.0	22.81	22.37	/			
		1851.5	22.74	22.85	/			
	1RB_7	1908.5	22.72	22.37	/			
		1880.0	22.84	22.44	/			
		1851.5	22.69	22.82	/			
	1RB_0	1908.5	22.77	22.35	/			
		1880.0	22.93	22.40	/			
		1851.5	22.70	22.81	/			
	8RB_7	1908.5	22.43	21.59	/	23.0	22.0	/
		1880.0	22.41	21.58	/			
		1851.5	22.31	21.52	/			
	8RB_4	1908.5	22.36	21.61	/			
		1880.0	22.35	21.53	/			
		1851.5	22.34	21.50	/			
	8RB_0	1908.5	22.43	21.57	/			
		1880.0	22.31	21.56	/			
		1851.5	22.30	21.46	/			
15RB_0	1908.5	22.43	21.55	/				
	1880.0	22.31	21.46	/				
	1851.5	22.19	21.38	/				



LTE Band 2			Actual output Power (dBm)			Tune up		
Band -width	RB No. / RB offset	Frequency (MHz)	Modulation			Modulation		
			QPSK	16QAM	64QAM	QPSK	16QAM	64QAM
5 MHz	1RB_24	1907.5	22.66	22.98	/	24.0	24.0	/
		1880.0	22.71	22.96	/			
		1852.5	22.76	22.93	/			
	1RB_12	1907.5	22.74	22.38	/			
		1880.0	22.73	22.93	/			
		1852.5	22.73	22.91	/			
	1RB_0	1907.5	22.76	22.39	/			
		1880.0	22.69	22.91	/			
		1852.5	22.76	22.91	/			
	12RB_13	1907.5	22.35	21.52	/	23.0	22.0	/
		1880.0	22.35	21.50	/			
		1852.5	22.19	21.47	/			
	12RB_6	1907.5	22.28	21.51	/			
		1880.0	22.39	21.55	/			
		1852.5	22.27	21.48	/			
	12RB_0	1907.5	22.25	21.50	/			
		1880.0	22.27	21.50	/			
		1852.5	22.23	21.49	/			
25RB_0	1907.5	22.31	21.67	/				
	1880.0	22.38	21.41	/				
	1852.5	22.16	21.57	/				





LTE Band 2			Actual output Power (dBm)			Tune up		
Band -width	RB No. / RB offset	Frequency (MHz)	Modulation			Modulation		
			QPSK	16QAM	64QAM	QPSK	16QAM	64QAM
10 MHz	1RB_49	1905.0	22.75	22.90	/	24.0	24.0	/
		1880.0	22.82	22.84	/			
		1855.0	22.58	22.91	/			
	1RB_24	1905.0	22.83	22.93	/			
		1880.0	22.83	22.95	/			
		1855.0	22.62	22.83	/			
	1RB_0	1905.0	22.70	22.94	/			
		1880.0	22.76	23.00	/			
		1855.0	22.61	22.30	/			
	25RB_25	1905.0	22.40	21.45	/	23.0	22.0	/
		1880.0	22.27	21.39	/			
		1855.0	22.31	21.32	/			
	25RB_12	1905.0	22.28	21.39	/			
		1880.0	22.40	21.39	/			
		1855.0	22.28	21.38	/			
	25RB_0	1905.0	22.35	21.68	/			
		1880.0	22.34	21.46	/			
		1855.0	22.25	21.38	/			
50RB_0	1905.0	22.40	21.45	/				
	1880.0	22.42	21.40	/				
	1855.0	22.16	21.47	/				



LTE Band 2			Actual output Power (dBm)			Tune up		
Band -width	RB No. / RB offset	Frequency (MHz)	Modulation			Modulation		
			QPSK	16QAM	64QAM	QPSK	16QAM	64QAM
15 MHz	1RB_74	1902.5	22.70	22.96	/	24.0	24.0	/
		1880.0	22.70	22.34	/			
		1857.5	22.63	23.00	/			
	1RB_37	1902.5	22.70	22.89	/			
		1880.0	22.74	22.36	/			
		1857.5	22.56	22.93	/			
	1RB_0	1902.5	22.74	22.93	/			
		1880.0	22.75	22.37	/			
		1857.5	22.64	22.76	/			
	36RB_38	1902.5	22.35	21.44	/	23.0	22.0	/
		1880.0	22.23	21.52	/			
		1857.5	22.26	21.39	/			
	36RB_19	1902.5	22.37	21.46	/			
		1880.0	22.39	21.57	/			
		1857.5	22.27	21.46	/			
	36RB_0	1902.5	22.34	21.42	/			
		1880.0	22.41	21.61	/			
		1857.5	22.27	21.48	/			
75RB_0	1902.5	22.42	21.41	/				
	1880.0	22.37	21.57	/				
	1857.5	22.32	21.33	/				



LTE Band 2			Actual output Power (dBm)			Tune up		
Band -width	RB No. / RB offset	Frequency (MHz)	Modulation			Modulation		
			QPSK	16QAM	64QAM	QPSK	16QAM	64QAM
20 MHz	1RB_99	1900.0	22.88	22.84	/	24.0	24.0	/
		1880.0	<b>22.94</b>	22.49	/			
		1860.0	22.80	22.96	/			
	1RB_50	1900.0	22.85	22.31	/			
		1880.0	22.81	22.34	/			
		1860.0	22.69	22.87	/			
	1RB_0	1900.0	22.78	22.24	/			
		1880.0	22.90	22.48	/			
		1860.0	22.78	22.96	/			
	50RB_50	1900.0	22.34	21.41	/	23.0	22.0	/
		1880.0	22.29	21.52	/			
		1860.0	22.26	21.33	/			
	50RB_25	1900.0	22.39	21.53	/			
		1880.0	<b>22.42</b>	21.49	/			
		1860.0	22.29	21.45	/			
	50RB_0	1900.0	22.26	21.45	/			
		1880.0	22.22	21.44	/			
		1860.0	22.26	21.40	/			
100RB_0	1900.0	22.29	21.46	/				
	1880.0	22.27	21.55	/				
	1860.0	22.20	21.40	/				



LTE Band 4			Actual output Power (dBm)			Tune up		
Band -width	RB No. / RB offset	Frequency (MHz)	Modulation			Modulation		
			QPSK	16QAM	64QAM	QPSK	16QAM	64QAM
1.4 MHz	1RB_5	1754.3	22.78	22.83	/	24.0	24.0	/
		1732.5	22.66	22.96	/			
		1710.7	22.69	22.28	/			
	1RB_3	1754.3	22.68	22.73	/			
		1732.5	22.69	22.36	/			
		1710.7	22.62	22.28	/			
	1RB_0	1754.3	22.67	22.99	/			
		1732.5	22.66	22.36	/			
		1710.7	22.63	22.56	/			
	3RB_3	1754.3	23.03	22.68	/			
		1732.5	22.92	22.70	/			
		1710.7	22.91	22.66	/			
	3RB_1	1754.3	23.01	22.72	/			
		1732.5	22.86	22.71	/			
		1710.7	22.84	22.70	/			
	3RB_0	1754.3	22.97	22.63	/			
		1732.5	22.93	22.66	/			
		1710.7	22.89	22.64	/			
	6RB_0	1754.3	22.38	21.25	/	23.0	22.0	/
		1732.5	22.36	21.37	/			
		1710.7	22.30	21.33	/			



LTE Band 4			Actual output Power (dBm)			Tune up		
Band -width	RB No. / RB offset	Frequency (MHz)	Modulation			Modulation		
			QPSK	16QAM	64QAM	QPSK	16QAM	64QAM
3 MHz	1RB_14	1753.5	22.78	22.82	/	24.0	24.0	/
		1732.5	22.72	22.98	/			
		1711.5	22.68	22.42	/			
	1RB_7	1753.5	22.72	22.77	/			
		1732.5	22.67	22.86	/			
		1711.5	22.70	22.40	/			
	1RB_0	1753.5	22.66	22.81	/			
		1732.5	22.67	22.75	/			
		1711.5	22.63	22.42	/			
	8RB_7	1753.5	22.38	21.59	/	23.0	22.0	/
		1732.5	22.33	21.65	/			
		1711.5	22.33	21.54	/			
	8RB_4	1753.5	22.28	21.56	/			
		1732.5	22.40	21.59	/			
		1711.5	22.35	21.55	/			
	8RB_0	1753.5	22.32	21.61	/			
		1732.5	22.38	21.57	/			
		1711.5	22.27	21.62	/			
	15RB_0	1753.5	22.38	21.65	/			
		1732.5	22.36	21.56	/			
		1711.5	22.31	21.51	/			



LTE Band 4			Actual output Power (dBm)			Tune up		
Band -width	RB No. / RB offset	Frequency (MHz)	Modulation			Modulation		
			QPSK	16QAM	64QAM	QPSK	16QAM	64QAM
5 MHz	1RB_24	1752.5	22.72	22.94	/	24.0	24.0	/
		1732.5	22.69	22.93	/			
		1712.5	22.66	22.90	/			
	1RB_12	1752.5	22.74	22.96	/			
		1732.5	22.83	22.84	/			
		1712.5	22.62	22.92	/			
	1RB_0	1752.5	22.75	22.99	/			
		1732.5	22.80	23.00	/			
		1712.5	22.69	22.92	/			
	12RB_13	1752.5	22.33	21.52	/	23.0	22.0	/
		1732.5	22.32	21.58	/			
		1712.5	22.26	21.49	/			
	12RB_6	1752.5	22.24	21.47	/			
		1732.5	22.44	21.55	/			
		1712.5	22.21	21.49	/			
	12RB_0	1752.5	22.39	21.55	/			
		1732.5	22.33	21.51	/			
		1712.5	22.34	21.46	/			
	25RB_0	1752.5	22.26	21.68	/			
		1732.5	22.32	21.78	/			
		1712.5	22.26	21.30	/			



LTE Band 4			Actual output Power (dBm)			Tune up		
Band -width	RB No. / RB offset	Frequency (MHz)	Modulation			Modulation		
			QPSK	16QAM	64QAM	QPSK	16QAM	64QAM
10 MHz	1RB_49	1750.0	22.66	22.89	/	24.0	24.0	/
		1732.5	22.76	22.41	/			
		1715.0	22.80	22.92	/			
	1RB_24	1750.0	22.77	22.92	/			
		1732.5	22.82	22.51	/			
		1715.0	22.81	22.89	/			
	1RB_0	1750.0	22.79	22.81	/			
		1732.5	22.83	22.39	/			
		1715.0	22.79	22.88	/			
	25RB_25	1750.0	22.29	21.48	/	23.0	22.0	/
		1732.5	22.39	21.70	/			
		1715.0	22.32	21.39	/			
	25RB_12	1750.0	22.25	21.49	/			
		1732.5	22.30	21.72	/			
		1715.0	22.29	21.40	/			
	25RB_0	1750.0	22.31	21.53	/			
		1732.5	22.26	21.69	/			
		1715.0	22.36	21.70	/			
50RB_0	1750.0	22.29	21.53	/				
	1732.5	22.31	21.47	/				
	1715.0	22.35	21.45	/				



LTE Band 4			Actual output Power (dBm)			Tune up		
Band -width	RB No. / RB offset	Frequency (MHz)	Modulation			Modulation		
			QPSK	16QAM	64QAM	QPSK	16QAM	64QAM
15 MHz	1RB_74	1747.5	22.67	22.77	/	24.0	24.0	/
		1732.5	22.76	22.95	/			
		1717.5	22.72	22.31	/			
	1RB_37	1747.5	22.70	22.86	/			
		1732.5	22.83	22.94	/			
		1717.5	22.83	22.41	/			
	1RB_0	1747.5	22.69	22.46	/			
		1732.5	22.70	22.85	/			
		1717.5	22.81	22.33	/			
	36RB_38	1747.5	22.34	21.53	/	23.0	22.0	/
		1732.5	22.41	21.39	/			
		1717.5	22.39	21.40	/			
	36RB_19	1747.5	22.38	21.61	/			
		1732.5	22.39	21.49	/			
		1717.5	22.28	21.39	/			
	36RB_0	1747.5	22.44	21.57	/			
		1732.5	22.48	21.48	/			
		1717.5	22.29	21.41	/			
75RB_0	1747.5	22.37	21.40	/				
	1732.5	22.44	21.44	/				
	1717.5	22.40	21.44	/				





LTE Band 4			Actual output Power (dBm)			Tune up		
Band -width	RB No. / RB offset	Frequency (MHz)	Modulation			Modulation		
			QPSK	16QAM	64QAM	QPSK	16QAM	64QAM
20 MHz	1RB_99	1745.0	22.66	22.79	/	<b>24.0</b>	<b>24.0</b>	/
		1732.5	22.75	22.36	/			
		1720.0	22.62	22.42	/			
	1RB_50	1745.0	22.68	22.77	/			
		1732.5	22.84	22.40	/			
		1720.0	22.64	22.36	/			
	1RB_0	1745.0	22.79	22.87	/			
		1732.5	<b>22.91</b>	22.34	/			
		1720.0	22.65	22.34	/			
	50RB_50	1745.0	22.35	21.52	/	<b>23.0</b>	<b>22.0</b>	/
		1732.5	22.31	21.52	/			
		1720.0	22.29	21.47	/			
	50RB_25	1745.0	22.38	21.52	/			
		1732.5	<b>22.40</b>	21.46	/			
		1720.0	22.38	21.42	/			
	50RB_0	1745.0	22.32	21.57	/			
		1732.5	22.34	21.52	/			
		1720.0	22.28	21.53	/			
100RB_0	1745.0	22.40	21.56	/				
	1732.5	22.27	21.57	/				
	1720.0	22.23	21.53	/				



LTE Band 5			Actual output Power (dBm)			Tune up		
Band -width	RB No. / RB offset	Frequency (MHz)	Modulation			Modulation		
			QPSK	16QAM	64QAM	QPSK	16QAM	64QAM
1.4 MHz	1RB_5	848.3	22.54	22.25	/	24.0	24.0	/
		836.5	22.39	22.52	/			
		824.7	22.42	22.36	/			
	1RB_3	848.3	22.48	22.14	/			
		836.5	22.49	22.10	/			
		824.7	22.45	22.40	/			
	1RB_0	848.3	22.46	22.22	/			
		836.5	22.35	22.08	/			
		824.7	22.43	22.35	/			
	3RB_3	848.3	22.64	22.32	/			
		836.5	22.54	22.32	/			
		824.7	22.54	22.28	/			
	3RB_1	848.3	22.59	22.31	/			
		836.5	22.51	22.37	/			
		824.7	22.45	22.28	/			
	3RB_0	848.3	22.55	22.32	/			
		836.5	22.57	22.32	/			
		824.7	22.55	22.25	/			
	6RB_0	848.3	22.14	20.88	/	23.0	22.0	/
		836.5	22.04	20.77	/			
		824.7	21.96	20.70	/			



LTE Band 5			Actual output Power (dBm)			Tune up		
Band -width	RB No. / RB offset	Frequency (MHz)	Modulation			Modulation		
			QPSK	16QAM	64QAM	QPSK	16QAM	64QAM
3 MHz	1RB_14	847.5	22.58	22.38	/	24.0	24.0	/
		836.5	22.41	22.50	/			
		825.5	22.42	22.41	/			
	1RB_7	847.5	22.33	22.27	/			
		836.5	22.42	22.57	/			
		825.5	22.32	22.45	/			
	1RB_0	847.5	22.48	22.26	/			
		836.5	22.43	22.41	/			
		825.5	22.44	22.41	/			
	8RB_7	847.5	22.12	21.20	/	23.0	22.0	/
		836.5	22.05	21.05	/			
		825.5	21.95	21.08	/			
	8RB_4	847.5	22.14	21.21	/			
		836.5	22.11	21.17	/			
		825.5	22.00	21.04	/			
	8RB_0	847.5	22.09	21.19	/			
		836.5	21.97	21.44	/			
		825.5	21.97	21.05	/			
	15RB_0	847.5	21.98	21.20	/			
		836.5	21.94	21.16	/			
		825.5	21.97	21.01	/			



LTE Band 5			Actual output Power (dBm)			Tune up		
Band -width	RB No. / RB offset	Frequency (MHz)	Modulation			Modulation		
			QPSK	16QAM	64QAM	QPSK	16QAM	64QAM
5 MHz	1RB_24	846.5	22.58	22.48	/	24.0	24.0	/
		836.5	22.33	22.28	/			
		826.5	22.37	22.44	/			
	1RB_12	846.5	22.62	22.38	/			
		836.5	22.40	22.15	/			
		826.5	22.27	22.35	/			
	1RB_0	846.5	22.50	21.98	/			
		836.5	22.26	21.98	/			
		826.5	22.33	22.40	/			
	12RB_13	846.5	22.11	21.18	/	23.0	22.0	/
		836.5	21.91	21.07	/			
		826.5	21.94	20.98	/			
	12RB_6	846.5	22.14	21.17	/			
		836.5	22.13	21.00	/			
		826.5	21.99	20.98	/			
	12RB_0	846.5	21.94	21.52	/			
		836.5	22.05	21.37	/			
		826.5	21.99	21.01	/			
	25RB_0	846.5	22.06	21.35	/			
		836.5	22.11	21.21	/			
		826.5	21.98	21.00	/			



LTE Band 5			Actual output Power (dBm)			Tune up		
Band -width	RB No. / RB offset	Frequency (MHz)	Modulation			Modulation		
			QPSK	16QAM	64QAM	QPSK	16QAM	64QAM
10 MHz	1RB_49	844.0	<b>22.62</b>	22.17	/	<b>24.0</b>	<b>24.0</b>	/
		836.5	22.55	22.66	/			
		829.0	22.37	22.44	/			
	1RB_24	844.0	22.60	22.15	/			
		836.5	22.39	22.55	/			
		829.0	22.31	22.47	/			
	1RB_0	844.0	22.55	22.22	/			
		836.5	22.32	22.54	/			
		829.0	22.30	22.41	/			
	25RB_25	844.0	22.05	21.07	/	<b>23.0</b>	<b>22.0</b>	/
		836.5	21.98	21.01	/			
		829.0	22.04	21.52	/			
	25RB_12	844.0	<b>22.17</b>	21.09	/			
		836.5	22.08	21.05	/			
		829.0	22.05	21.23	/			
	25RB_0	844.0	21.94	21.40	/			
		836.5	22.03	21.41	/			
		829.0	21.89	21.18	/			
50RB_0	844.0	22.14	21.13	/				
	836.5	22.16	21.05	/				
	829.0	22.09	21.10	/				



LTE Band 7			Actual output Power (dBm)			Tune up		
Band -width	RB No. / RB offset	Frequency (MHz)	Modulation			Modulation		
			QPSK	16QAM	64QAM	QPSK	16QAM	64QAM
5 MHz	1RB_24	2567.5	21.49	21.39	/	23.0	23.0	/
		2535.0	21.49	21.34	/			
		2502.5	21.54	21.53	/			
	1RB_12	2567.5	21.47	21.37	/			
		2535.0	21.48	21.36	/			
		2502.5	21.43	21.37	/			
	1RB_0	2567.5	21.44	21.40	/			
		2535.0	21.43	21.36	/			
		2502.5	21.44	21.45	/			
	12RB_13	2567.5	21.10	20.27	/	22.0	21.0	/
		2535.0	21.13	20.17	/			
		2502.5	20.98	20.26	/			
	12RB_6	2567.5	21.03	20.19	/			
		2535.0	21.12	20.18	/			
		2502.5	21.15	20.28	/			
	12RB_0	2567.5	21.03	20.18	/			
		2535.0	20.99	20.21	/			
		2502.5	21.05	20.22	/			
25RB_0	2567.5	20.98	20.41	/				
	2535.0	20.98	20.35	/				
	2502.5	21.03	20.42	/				



LTE Band 7			Actual output Power (dBm)			Tune up		
Band -width	RB No. / RB offset	Frequency (MHz)	Modulation			Modulation		
			QPSK	16QAM	64QAM	QPSK	16QAM	64QAM
10 MHz	1RB_49	2565.0	21.56	21.83	/	23.0	23.0	/
		2535.0	21.47	21.73	/			
		2505.0	21.58	21.80	/			
	1RB_24	2565.0	21.49	21.78	/			
		2535.0	21.39	21.75	/			
		2505.0	21.57	21.81	/			
	1RB_0	2565.0	21.41	21.64	/			
		2535.0	21.45	21.75	/			
		2505.0	21.46	21.78	/			
	25RB_25	2565.0	21.07	20.15	/	22.0	21.0	/
		2535.0	21.01	20.19	/			
		2505.0	21.10	20.17	/			
	25RB_12	2565.0	21.09	20.14	/			
		2535.0	21.05	20.05	/			
		2505.0	21.13	20.24	/			
	25RB_0	2565.0	21.09	20.12	/			
		2535.0	21.00	20.04	/			
		2505.0	21.08	20.15	/			
50RB_0	2565.0	21.07	20.14	/				
	2535.0	20.94	20.09	/				
	2505.0	21.21	20.20	/				



LTE Band 7			Actual output Power (dBm)			Tune up		
Band -width	RB No. / RB offset	Frequency (MHz)	Modulation			Modulation		
			QPSK	16QAM	64QAM	QPSK	16QAM	64QAM
15 MHz	1RB_74	2562.5	21.52	21.39	/	23.0	23.0	/
		2535.0	21.39	21.36	/			
		2507.5	21.45	21.40	/			
	1RB_37	2562.5	21.41	21.36	/			
		2535.0	21.42	21.30	/			
		2507.5	21.42	21.35	/			
	1RB_0	2562.5	21.37	21.30	/			
		2535.0	21.38	21.26	/			
		2507.5	21.40	21.30	/			
	36RB_38	2562.5	21.14	20.42	/	22.0	21.0	/
		2535.0	21.15	20.33	/			
		2507.5	21.20	20.36	/			
	36RB_19	2562.5	21.17	20.33	/			
		2535.0	21.05	20.23	/			
		2507.5	21.08	20.40	/			
	36RB_0	2562.5	21.16	20.32	/			
		2535.0	20.98	20.22	/			
		2507.5	21.23	20.36	/			
75RB_0	2562.5	21.14	20.18	/				
	2535.0	21.13	20.13	/				
	2507.5	21.10	20.17	/				





LTE Band 7			Actual output Power (dBm)			Tune up		
Band -width	RB No. / RB offset	Frequency (MHz)	Modulation			Modulation		
			QPSK	16QAM	64QAM	QPSK	16QAM	64QAM
20 MHz	1RB_99	2560.0	21.68	21.50	/	23.0	23.0	/
		2535.0	21.66	21.58	/			
		2510.0	<b>21.71</b>	21.45	/			
	1RB_50	2560.0	21.50	21.33	/			
		2535.0	21.43	21.49	/			
		2510.0	21.55	21.34	/			
	1RB_0	2560.0	21.49	21.25	/			
		2535.0	21.33	21.41	/			
		2510.0	21.50	21.37	/			
	50RB_50	2560.0	21.17	20.32	/	22.0	21.0	/
		2535.0	21.07	20.25	/			
		2510.0	<b>21.19</b>	20.27	/			
	50RB_25	2560.0	21.16	20.27	/			
		2535.0	21.06	20.20	/			
		2510.0	21.18	20.21	/			
	50RB_0	2560.0	21.16	20.22	/			
		2535.0	20.99	20.14	/			
		2510.0	21.26	20.28	/			
100RB_0	2560.0	21.02	20.29	/				
	2535.0	20.99	20.16	/				
	2510.0	21.19	20.19	/				



LTE Band 12			Actual output Power (dBm)			Tune up		
Band -width	RB No. / RB offset	Frequency (MHz)	Modulation			Modulation		
			QPSK	16QAM	64QAM	QPSK	16QAM	64QAM
1.4 MHz	1RB_5	715.3	22.62	22.73	/	24.0	24.0	/
		707.5	22.58	22.42	/			
		699.7	22.40	22.22	/			
	1RB_3	715.3	22.55	22.43	/			
		707.5	22.58	22.35	/			
		699.7	22.48	22.26	/			
	1RB_0	715.3	22.58	22.51	/			
		707.5	22.46	22.35	/			
		699.7	22.45	22.25	/			
	3RB_3	715.3	22.73	22.43	/			
		707.5	22.69	22.46	/			
		699.7	22.64	22.33	/			
	3RB_1	715.3	22.79	22.43	/			
		707.5	22.79	22.45	/			
		699.7	22.59	22.41	/			
	3RB_0	715.3	22.76	22.36	/			
		707.5	22.75	22.37	/			
		699.7	22.62	22.37	/			
	6RB_0	715.3	22.11	21.43	/	23.0	22.0	/
		707.5	22.10	21.02	/			
		699.7	22.13	21.33	/			



LTE Band 12			Actual output Power (dBm)			Tune up		
Band -width	RB No. / RB offset	Frequency (MHz)	Modulation			Modulation		
			QPSK	16QAM	64QAM	QPSK	16QAM	64QAM
3 MHz	1RB_14	714.5	22.67	22.50	/	24.0	24.0	/
		707.5	22.66	22.49	/			
		700.5	22.41	22.45	/			
	1RB_7	714.5	22.75	22.37	/			
		707.5	22.63	22.54	/			
		700.5	22.46	22.31	/			
	1RB_0	714.5	22.65	22.37	/			
		707.5	22.53	22.36	/			
		700.5	22.36	22.30	/			
	8RB_7	714.5	22.22	21.68	/	23.0	22.0	/
		707.5	22.18	21.35	/			
		700.5	22.60	21.69	/			
	8RB_4	714.5	22.13	21.79	/			
		707.5	22.15	21.31	/			
		700.5	22.03	21.62	/			
	8RB_0	714.5	22.19	21.70	/			
		707.5	22.17	21.66	/			
		700.5	21.94	21.70	/			
	15RB_0	714.5	22.12	21.72	/			
		707.5	22.11	21.24	/			
		700.5	22.08	21.65	/			



LTE Band 12			Actual output Power (dBm)			Tune up		
Band -width	RB No. / RB offset	Frequency (MHz)	Modulation			Modulation		
			QPSK	16QAM	64QAM	QPSK	16QAM	64QAM
5 MHz	1RB_24	713.5	22.58	22.67	/	24.0	24.0	/
		707.5	22.66	22.62	/			
		701.5	22.57	22.61	/			
	1RB_12	713.5	22.59	22.62	/			
		707.5	22.63	22.59	/			
		701.5	22.58	22.78	/			
	1RB_0	713.5	22.43	22.54	/			
		707.5	22.50	22.52	/			
		701.5	22.55	22.55	/			
	12RB_13	713.5	22.13	21.73	/	23.0	22.0	/
		707.5	22.18	21.32	/			
		701.5	22.49	21.63	/			
	12RB_6	713.5	22.23	21.71	/			
		707.5	22.19	21.28	/			
		701.5	22.60	21.62	/			
	12RB_0	713.5	22.29	21.12	/			
		707.5	22.11	21.67	/			
		701.5	22.10	21.60	/			
25RB_0	713.5	22.15	21.76	/				
	707.5	22.16	21.14	/				
	701.5	22.57	21.75	/				



LTE Band 12			Actual output Power (dBm)			Tune up		
Band -width	RB No. / RB offset	Frequency (MHz)	Modulation			Modulation		
			QPSK	16QAM	64QAM	QPSK	16QAM	64QAM
10 MHz	1RB_49	711.0	22.72	22.50	/	24.0	24.0	/
		707.5	22.77	22.45	/			
		704.0	<b>22.78</b>	22.45	/			
	1RB_24	711.0	22.58	22.41	/			
		707.5	22.64	22.31	/			
		704.0	22.64	22.53	/			
	1RB_0	711.0	22.53	22.28	/			
		707.5	22.47	22.47	/			
		704.0	22.44	22.30	/			
	25RB_25	711.0	22.22	21.65	/	23.0	22.0	/
		707.5	22.30	21.67	/			
		704.0	22.22	21.59	/			
	25RB_12	711.0	22.22	21.56	/			
		707.5	22.09	21.23	/			
		704.0	22.63	21.51	/			
	25RB_0	711.0	22.24	21.12	/			
		707.5	22.33	21.49	/			
		704.0	<b>22.65</b>	21.51	/			
50RB_0	711.0	22.18	21.56	/				
	707.5	22.08	21.21	/				
	704.0	22.66	21.62	/				



LTE Band 26			Actual output Power (dBm)			Tune up		
Band -width	RB No. / RB offset	Frequency (MHz)	Modulation			Modulation		
			QPSK	16QAM	64QAM	QPSK	16QAM	64QAM
1.4 MHz	1RB_5	848.3	22.56	22.42	/	24.0	24.0	/
		831.5	22.41	22.29	/			
		814.7	22.27	22.31	/			
	1RB_3	848.3	22.73	22.55	/			
		831.5	22.38	22.20	/			
		814.7	22.42	22.22	/			
	1RB_0	848.3	22.61	22.49	/			
		831.5	22.37	22.26	/			
		814.7	22.35	22.24	/			
	3RB_3	848.3	22.63	22.25	/			
		831.5	22.48	22.31	/			
		814.7	22.54	22.23	/			
	3RB_1	848.3	22.69	22.34	/			
		831.5	22.55	22.33	/			
		814.7	22.42	22.23	/			
	3RB_0	848.3	22.66	22.34	/			
		831.5	22.50	22.32	/			
		814.7	22.50	22.15	/			
	6RB_0	848.3	22.06	21.29	/	23.0	22.0	/
		831.5	22.04	20.91	/			
		814.7	21.92	21.11	/			



LTE Band 26			Actual output Power (dBm)			Tune up			
Band -width	RB No. / RB offset	Frequency (MHz)	Modulation			Modulation			
			QPSK	16QAM	64QAM	QPSK	16QAM	64QAM	
3 MHz	1RB_14	847.5	22.58	22.62	/	24.0	24.0	/	
		831.5	22.55	22.32	/				
		815.5	22.41	22.31	/				
	1RB_7	847.5	22.58	22.77	/				
		831.5	22.46	22.31	/				
		815.5	22.40	22.35	/				
	1RB_0	847.5	22.61	22.64	/				
		831.5	22.47	22.40	/				
		815.5	22.36	22.17	/				
	8RB_7	847.5	22.15	21.64	/	23.0	22.0	/	
		831.5	22.08	21.23	/				
		815.5	22.01	21.49	/				
		8RB_4	847.5	22.20	21.27				/
			831.5	22.14	21.18				/
			815.5	22.06	21.52				/
	8RB_0	847.5	22.09	21.24	/				
		831.5	22.13	21.17	/				
		815.5	22.02	21.50	/				
15RB_0	847.5	22.06	21.35	/					
	831.5	22.11	21.17	/					
	815.5	22.02	21.43	/					



LTE Band 26			Actual output Power (dBm)			Tune up		
Band -width	RB No. / RB offset	Frequency (MHz)	Modulation			Modulation		
			QPSK	16QAM	64QAM	QPSK	16QAM	64QAM
5 MHz	1RB_24	846.5	22.31	22.55	/	24.0	24.0	/
		831.5	22.52	22.52	/			
		816.5	22.34	22.29	/			
	1RB_12	846.5	22.46	22.65	/			
		831.5	22.44	22.45	/			
		816.5	22.26	22.19	/			
	1RB_0	846.5	22.35	22.52	/			
		831.5	22.53	22.66	/			
		816.5	22.26	21.85	/			
	12RB_13	846.5	22.02	21.07	/	23.0	22.0	/
		831.5	21.97	20.99	/			
		816.5	21.84	21.32	/			
	12RB_6	846.5	22.06	21.08	/			
		831.5	22.01	20.99	/			
		816.5	21.83	21.25	/			
	12RB_0	846.5	21.98	21.38	/			
		831.5	22.04	20.92	/			
		816.5	21.91	21.28	/			
25RB_0	846.5	22.17	21.27	/				
	831.5	22.01	21.26	/				
	816.5	21.82	21.50	/				





LTE Band 26			Actual output Power (dBm)			Tune up		
Band -width	RB No. / RB offset	Frequency (MHz)	Modulation			Modulation		
			QPSK	16QAM	64QAM	QPSK	16QAM	64QAM
10 MHz	1RB_49	844.0	22.43	22.61	/	24.0	24.0	/
		831.5	22.51	22.52	/			
		819.0	22.49	22.39	/			
	1RB_24	844.0	22.32	22.52	/			
		831.5	22.46	22.54	/			
		819.0	22.29	22.28	/			
	1RB_0	844.0	22.36	22.82	/			
		831.5	22.41	22.35	/			
		819.0	22.33	22.27	/			
	25RB_25	844.0	22.12	21.10	/	23.0	22.0	/
		831.5	22.11	20.94	/			
		819.0	21.87	20.87	/			
	25RB_12	844.0	22.06	20.99	/			
		831.5	21.93	20.90	/			
		819.0	21.91	21.23	/			
	25RB_0	844.0	21.95	21.30	/			
		831.5	22.00	21.05	/			
		819.0	21.74	21.19	/			
50RB_0	844.0	22.14	21.09	/				
	831.5	22.06	20.91	/				
	819.0	21.93	21.26	/				



LTE Band 26			Actual output Power (dBm)			Tune up		
Band -width	RB No. / RB offset	Frequency (MHz)	Modulation			Modulation		
			QPSK	16QAM	64QAM	QPSK	16QAM	64QAM
15 MHz	1RB_74	841.5	<b>22.58</b>	22.52	/	<b>24.0</b>	<b>24.0</b>	/
		831.5	22.37	22.92	/			
		821.5	22.57	22.49	/			
	1RB_37	841.5	22.31	22.43	/			
		831.5	22.30	22.49	/			
		821.5	22.33	22.28	/			
	1RB_0	841.5	22.20	22.35	/			
		831.5	22.26	22.36	/			
		821.5	22.28	22.27	/			
	36RB_38	841.5	21.99	21.47	/	<b>23.0</b>	<b>22.0</b>	/
		831.5	22.09	21.40	/			
		821.5	21.95	21.42	/			
	36RB_19	841.5	21.94	21.40	/			
		831.5	22.01	21.01	/			
		821.5	21.91	21.03	/			
	36RB_0	841.5	<b>22.34</b>	21.38	/			
		831.5	22.10	21.00	/			
		821.5	21.97	21.31	/			
	75RB_0	841.5	21.98	21.39	/			
		831.5	22.05	21.02	/			
		821.5	21.93	20.92	/			

#### 10.4. Bluetooth and WLAN Measurement result

**Table 10.5: The conducted Power measurement results for Bluetooth**

Averaged Power (dBm)				
Mode	Tune up	Ch.0 (2402MHz)	Ch.39 (2441MHz)	Ch.78 (2480MHz)
GFSK	<b>7.5</b>	<b>6.75</b>	5.46	5.25
EDR2M-4_DQPSK	<b>6.0</b>	5.38	4.61	4.33
EDR3M-8DPSK	<b>6.0</b>	5.36	4.43	4.48
/	/	Ch.0 (2402MHz)	Ch.19 (2440MHz)	Ch.39 (2480MHz)
BLE(1M)	<b>1.0</b>	-0.06	-0.38	-0.51
BLE(2M)	<b>1.0</b>	-0.03	-0.33	-0.43

**Table 10.6: The conducted Power measurement results for WLAN 2.4GHz**

Averaged Power (dBm) Duty Cycle: <b>100%</b>				
Mode	Tune up	Ch.1 (2412MHz)	Ch.6 (2437MHz)	Ch.11 (2462MHz)
802.11b	<b>17.0</b>	15.85	<b>16.06</b>	15.53
802.11g	<b>16.5</b>	15.21	15.39	15.16
802.11n(20MHz)	<b>15.5</b>	14.27	14.51	14.17
/	/	Ch.3 (2422MHz)	Ch.6 (2437MHz)	Ch.9 (2452MHz)
802.11n(40MHz)	<b>15.0</b>	13.68	13.95	14.23



**Table 10.7: The conducted Power measurement results for WLAN 5GHz**

Averaged Power (dBm) Duty Cycle: <b>100%</b>								
Mode	802.11a	802.11n -20MHz	802.11ac -20MHz	Mode	802.11n -40MHz	802.11ac -40MHz	Mode	802.11ac -80MHz
Channel	6Mbps	MCS0	MCS0	Channel	MCS0	MCS0	Channel	MCS0
<b>&lt;U-NII-1&gt;</b>								
<b>Tune up</b>	<b>14.0</b>	<b>14.0</b>	<b>14.0</b>	/	<b>13.5</b>	<b>13.5</b>	/	<b>13.5</b>
36(5180MHz)	<b>12.92</b>	12.82	12.80	38(5190MHz)	12.25	12.17	42(5210MHz)	11.98
40(5200MHz)	12.91	12.87	12.76	46(5230MHz)	11.88	11.75	/	/
44(5220MHz)	12.89	12.72	12.77	/	/	/	/	/
48(5240MHz)	12.76	12.44	12.41	/	/	/	/	/
<b>&lt;U-NII-2A&gt;</b>								
<b>Tune up</b>	<b>14.0</b>	<b>14.0</b>	<b>14.0</b>	/	<b>13.5</b>	<b>13.5</b>	/	<b>13.5</b>
52(5260MHz)	12.85	12.65	12.76	54(5270MHz)	12.12	11.96	58(5290MHz)	12.02
56(5280MHz)	12.90	12.88	12.81	62(5310MHz)	12.46	12.39	/	/
60(5300MHz)	<b>12.91</b>	12.78	12.82	/	/	/	/	/
64(5320MHz)	12.73	12.55	12.47	/	/	/	/	/
<b>&lt;U-NII-2C&gt;</b>								
<b>Tune up</b>	<b>14.0</b>	<b>14.0</b>	<b>14.0</b>	/	<b>13.5</b>	<b>13.5</b>	/	<b>13.0</b>
100(5500MHz)	<b>12.84</b>	12.66	12.72	102(5510MHz)	12.14	12.07	106(5530MHz)	11.43
116(5580MHz)	12.80	12.63	12.42	110(5550MHz)	12.21	12.14	122(5610MHz)	11.12
124(5620MHz)	12.23	12.09	11.96	126(5630MHz)	11.59	11.37	/	/
132(5660MHz)	11.46	11.28	11.29	134(5670MHz)	11.38	11.41	/	/
140(5700MHz)	11.18	11.02	11.05	/	/	/	/	/
<b>&lt;U-NII-3&gt;</b>								
<b>Tune up</b>	<b>11.5</b>	<b>11.5</b>	<b>11.5</b>	/	<b>11.0</b>	<b>11.0</b>	/	<b>11.0</b>
149(5745MHz)	<b>10.56</b>	10.38	10.48	151(5755MHz)	10.20	10.41	155(5775MHz)	9.46
157(5785MHz)	9.75	9.61	9.73	159(5795MHz)	9.42	9.59	/	/
165(5825MHz)	9.63	9.41	9.52	/	/	/	/	/

## 11. Simultaneous TX SAR Considerations

### 11.1. Introduction

The following procedures adopted from “FCC SAR Considerations for Cell Phones with Multiple Transmitters” are applicable to handsets with built-in unlicensed transmitters such as 802.11 a/b/g and Bluetooth devices which may simultaneously transmit with the licensed transmitter.

For this device, the Bluetooth and WLAN can transmit simultaneous with other transmitters.

### 11.2. Transmit Antenna Separation Distances

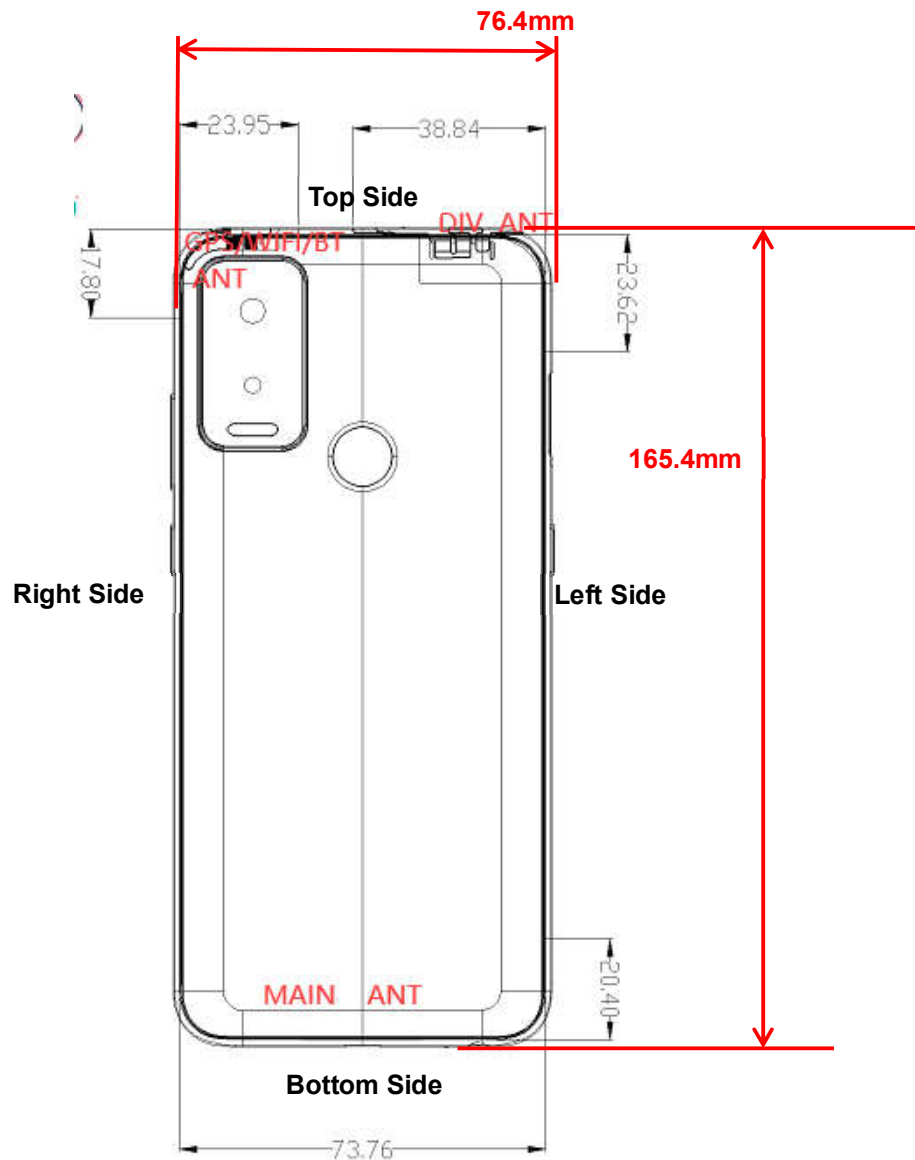

Picture 11.1 Antenna Locations (Back View)



**Note:**

Antenna	Frequency Bands
MAIN ANT	TX: GSM 850, WCDMA Band 5, LTE Band 5/12/26
DIV ANT	TX: GSM 1900, WCDMA Band 2/4, LTE Band 2/4/7

**11.3. SAR Measurement Positions**

According to the KDB941225 D06 Hot Spot SAR, the edges with less than 25mm distance to the antennas need to be tested for SAR.

SAR measurement positions						
Antenna	Front	Rear	Left edge	Right edge	Top edge	Bottom edge
MAIN ANT	Yes	Yes	Yes	Yes	No	Yes
DIV ANT	Yes	Yes	Yes	Yes	Yes	No
Bluetooth/ WLAN	Yes	Yes	No	Yes	Yes	No

## 12. Evaluation of Simultaneous

No.	Simultaneous Transmission Configuration
1	UMTS Voice + Bluetooth + WLAN 5GHz
2	UMTS Data + Bluetooth + WLAN 5GHz
3	UMTS Voice + WLAN 2.4GHz
4	UMTS Data + WLAN 2.4GHz
5	LTE + Bluetooth + WLAN 5GHz
6	LTE + WLAN 2.4GHz

**Table 12.6: Maximum Simultaneous Transmission SAR**

/	Position	Sum (W/kg)
Highest reported SAR value for Head	Right Tilt (LTE Band 7 + WLAN 5GHz + Bluetooth)	<b>1.59</b>
Highest reported SAR value for Hotspot	Rear Side (LTE Band 12 + WLAN 5GHz + Bluetooth)	<b>0.91</b>
Highest reported SAR value for Body-worn	Rear Side (LTE Band 12 + WLAN 5GHz + Bluetooth)	<b>0.82</b>

Note: the test positions of above tables are for the worse case that has been evaluated.

### Conclusion:

According to the above tables, the sum of reported SAR values is less than limit. So the simultaneous transmission SAR with volume scans is not required.

### 13. Summary of Test Results

According to the client's decision rule in the test registration form, which is "based on the measurement results as the basis of the conformity statement", the test conclusion of this report meets the limit requirements.

The calculated SAR is obtained by the following formula:

$$\text{Reported SAR} = \text{Measured SAR} \times 10^{(P_{\text{Target}} - P_{\text{Measured}})/10}$$

Where  $P_{\text{Target}}$  is the power of manufacturing upper limit;

$P_{\text{Measured}}$  is the measured power in chapter 10.

**General Note:**

1. Per KDB648474 D04v01r03, for smart phones with a display diagonal dimension > 15.0 cm or an overall diagonal dimension > 16.0 cm, when hotspot mode applies, 10-g extremity SAR is required only for the surfaces and edges with hotspot mode 1-g reported SAR > 1.2 W/kg, however, when power reduction applies to hotspot mode the measured SAR must be scaled to the maximum output power, including tolerance, allowed for phablet modes to compare with the 1.2 W/kg SAR test reduction threshold.

a. WLAN5GHz U-NII-2A and U-NII-2C tested the product specific 10g SAR since it has no hotspot mode.

b. When 10-g product specific 10g SAR is considered, SAR thresholds is specified in the procedures for SAR test reduction and exclusion should be multiplied by 2.5.

2. C2: Config2 (Secondary Supply)

**Duty Cycle**

Mode	Duty Cycle
Speech for GSM	1:8.3
GPRS	1:4
WCDMA	1:1
FDD_LTE	1:1
Bluetooth	1:1
WLAN	1:1

**13.1. Testing Environment**

Temperature:	18°C~25°C
Relative humidity:	30%~70%
Ambient noise & Reflection:	< 0.012 W/kg





**13.2. SAR results**

**Table 13.1: SAR Values (GSM 850 - Head)**

Frequency		Test Mode	Test Position	Figure No./ Note	Conducted Power (dBm)	Max. tune-up Power (dBm)	Measured SAR(1g) (W/kg)	Reported SAR(1g) (W/kg)	Power Drift(dB)
Ch.	MHz								
190	836.6	Speech	Left Cheek	1	32.48	33.5	<b>0.228</b>	<b>0.29</b>	0.05
190	836.6	Speech	Left Tilt	/	32.48	33.5	0.118	<b>0.15</b>	0.15
190	836.6	Speech	Right Cheek	/	32.48	33.5	0.208	<b>0.26</b>	0.07
190	836.6	Speech	Right Tilt	/	32.48	33.5	0.115	<b>0.15</b>	0.16
190	836.6	Speech	Left Cheek	C2	32.48	33.5	0.216	<b>0.27</b>	0.02

**Table 13.2: SAR Values (GSM 850 - Body)**

Frequency		Test Mode	Test Position	Figure No./ Note	Conducted Power (dBm)	Max. tune-up Power (dBm)	Measured SAR(1g) (W/kg)	Reported SAR(1g) (W/kg)	Power Drift(dB)
Ch.	MHz								
<b>Hotspot / Body-Worn Test Data (10mm)</b>									
190	836.6	GPRS-2	Front	/	30.54	31.5	0.231	<b>0.29</b>	0.02
190	836.6	GPRS-2	Rear	2	30.54	31.5	<b>0.309</b>	<b>0.39</b>	-0.03
190	836.6	GPRS-2	Rear	C2	30.54	31.5	0.301	<b>0.38</b>	0.01
<b>Hotspot Test Data (10mm)</b>									
190	836.6	GPRS-2	Left	/	30.54	31.5	0.059	<b>0.07</b>	0.19
190	836.6	GPRS-2	Right	/	30.54	31.5	0.142	<b>0.18</b>	-0.14
190	836.6	GPRS-2	Bottom	/	30.54	31.5	0.075	<b>0.09</b>	-0.14



**Table 13.3: SAR Values (GSM 1900 - Head)**

Frequency		Test Mode	Test Position	Figure No./ Note	Conducted Power (dBm)	Max. tune-up Power (dBm)	Measured SAR(1g) (W/kg)	Reported SAR(1g) (W/kg)	Power Drift(dB)
Ch.	MHz								
661	1880.0	Speech	Left Cheek	/	29.55	30.5	0.110	<b>0.14</b>	0.03
661	1880.0	Speech	Left Tilt	/	29.55	30.5	0.055	<b>0.07</b>	-0.08
661	1880.0	Speech	Right Cheek	<b>3</b>	29.55	30.5	<b>0.259</b>	<b>0.32</b>	0.04
661	1880.0	Speech	Right Tilt	/	29.55	30.5	0.188	<b>0.23</b>	0.09
661	1880.0	Speech	Right Cheek	C2	29.55	30.5	0.241	<b>0.30</b>	0.01

**Table 13.4: SAR Values (GSM 1900 - Body)**

Frequency		Test Mode	Test Position	Figure No./ Note	Conducted Power (dBm)	Max. tune-up Power (dBm)	Measured SAR(1g) (W/kg)	Reported SAR(1g) (W/kg)	Power Drift(dB)
Ch.	MHz								
<b>Hotspot / Body-Worn Test Data (10mm)</b>									
661	1880.0	GPRS-2	Front	/	27.51	28.5	0.077	<b>0.10</b>	-0.09
661	1880.0	GPRS-2	Rear	<b>4</b>	27.51	28.5	<b>0.113</b>	<b>0.14</b>	-0.04
661	1880.0	GPRS-2	Rear	C2	27.51	28.5	0.109	<b>0.14</b>	0.05
<b>Hotspot Test Data (10mm)</b>									
661	1880.0	GPRS-2	Left	/	27.51	28.5	0.090	<b>0.11</b>	-0.01
661	1880.0	GPRS-2	Right	/	27.51	28.5	0.006	<b>0.01</b>	0.05
661	1880.0	GPRS-2	Top	/	27.51	28.5	0.037	<b>0.05</b>	-0.18



**Table 13.5: SAR Values (WCDMA Band 2 - Head)**

Frequency		Test Mode	Test Position	Figure No./ Note	Conducted Power (dBm)	Max. tune-up Power (dBm)	Measured SAR(1g) (W/kg)	Reported SAR(1g) (W/kg)	Power Drift(dB)
Ch.	MHz								
9400	1880.0	RMC	Left Cheek	/	21.80	23.0	0.290	<b>0.38</b>	0.07
9400	1880.0	RMC	Left Tilt	/	21.80	23.0	0.217	<b>0.29</b>	-0.04
9400	1880.0	RMC	Right Cheek	<b>5</b>	21.80	23.0	<b>0.718</b>	<b>0.95</b>	-0.06
9400	1880.0	RMC	Right Tilt	/	21.80	23.0	0.468	<b>0.62</b>	-0.04
9538	1908.0	RMC	Right Cheek	/	21.60	23.0	0.552	<b>0.76</b>	-0.12
9262	1852.4	RMC	Right Cheek	/	21.70	23.0	0.438	<b>0.59</b>	0.02
9400	1880.0	RMC	Right Cheek	C2	21.80	23.0	0.632	<b>0.83</b>	0.01

**Table 13.6: SAR Values (WCDMA Band 2 - Body)**

Frequency		Test Mode	Test Position	Figure No./ Note	Conducted Power (dBm)	Max. tune-up Power (dBm)	Measured SAR(1g) (W/kg)	Reported SAR(1g) (W/kg)	Power Drift(dB)
Ch.	MHz								
<b>Hotspot / Body-Worn Test Data (10mm)</b>									
9400	1880.0	RMC	Front	/	21.80	23.0	0.147	<b>0.19</b>	-0.12
9400	1880.0	RMC	Rear	<b>6</b>	21.80	23.0	<b>0.224</b>	<b>0.30</b>	0.04
9400	1880.0	RMC	Rear	C2	21.80	23.0	0.141	<b>0.19</b>	0.05
<b>Hotspot Test Data (10mm)</b>									
9400	1880.0	RMC	Left	/	21.80	23.0	0.162	<b>0.21</b>	-0.18
9400	1880.0	RMC	Right	/	21.80	23.0	0.018	<b>0.02</b>	0.19
9400	1880.0	RMC	Top	/	21.80	23.0	0.073	<b>0.10</b>	0.13



**Table 13.7: SAR Values (WCDMA Band 4 - Head)**

Frequency		Test Mode	Test Position	Figure No./ Note	Conducted Power (dBm)	Max. tune-up Power (dBm)	Measured SAR(1g) (W/kg)	Reported SAR(1g) (W/kg)	Power Drift(dB)
Ch.	MHz								
1413	1732.6	RMC	Left Cheek	/	22.00	23.0	0.084	<b>0.11</b>	0.08
1413	1732.6	RMC	Left Tilt	/	22.00	23.0	0.067	<b>0.08</b>	-0.06
1413	1732.6	RMC	Right Cheek	<b>7</b>	22.00	23.0	<b>0.168</b>	<b>0.21</b>	0.02
1413	1732.6	RMC	Right Tilt	/	22.00	23.0	0.102	<b>0.13</b>	0.13
1413	1732.6	RMC	Right Cheek	C2	22.00	23.0	0.154	<b>0.19</b>	0.01

**Table 13.8: SAR Values ( WCDMA Band 4 - Body)**

Frequency		Test Mode	Test Position	Figure No./ Note	Conducted Power (dBm)	Max. tune-up Power (dBm)	Measured SAR(1g) (W/kg)	Reported SAR(1g) (W/kg)	Power Drift(dB)
Ch.	MHz								
<b>Hotspot / Body-Worn Test Data (10mm)</b>									
1413	1732.6	RMC	Front	/	22.00	23.0	0.028	<b>0.03</b>	0.05
1413	1732.6	RMC	Rear	<b>8</b>	22.00	23.0	<b>0.040</b>	<b>0.05</b>	0.18
1413	1732.6	RMC	Rear	C2	22.00	23.0	0.037	<b>0.05</b>	0.03
<b>Hotspot Test Data (10mm)</b>									
1413	1732.6	RMC	Left	/	22.00	23.0	0.031	<b>0.04</b>	0.06
1413	1732.6	RMC	Right	/	22.00	23.0	0.001	<b>&lt;0.01</b>	-0.16
1413	1732.6	RMC	Top	/	22.00	23.0	0.024	<b>0.03</b>	0.06



**Table 13.9: SAR Values (WCDMA Band 5 - Head)**

Frequency		Test Mode	Test Position	Figure No./ Note	Conducted Power (dBm)	Max. tune-up Power (dBm)	Measured SAR(1g) (W/kg)	Reported SAR(1g) (W/kg)	Power Drift(dB)
Ch.	MHz								
4183	836.6	RMC	Left Cheek	/	21.90	23.0	0.159	<b>0.20</b>	0.05
4183	836.6	RMC	Left Tilt	/	21.90	23.0	0.077	<b>0.10</b>	0.02
4183	836.6	RMC	Right Cheek	<b>9</b>	21.90	23.0	<b>0.163</b>	<b>0.21</b>	0.06
4183	836.6	RMC	Right Tilt	/	21.90	23.0	0.083	<b>0.11</b>	0.18
4183	836.6	RMC	Right Cheek	C2	21.90	23.0	0.157	<b>0.20</b>	0.03

**Table 13.10: SAR Values (WCDMA Band 5 - Body)**

Frequency		Test Mode	Test Position	Figure No./ Note	Conducted Power (dBm)	Max. tune-up Power (dBm)	Measured SAR(1g) (W/kg)	Reported SAR(1g) (W/kg)	Power Drift(dB)
Ch.	MHz								
<b>Hotspot / Body-Worn Test Data (10mm)</b>									
4183	836.6	RMC	Front	/	21.90	23.0	0.136	<b>0.18</b>	-0.02
4183	836.6	RMC	Rear	<b>10</b>	21.90	23.0	<b>0.192</b>	<b>0.25</b>	0.00
4183	836.6	RMC	Rear	C2	21.90	23.0	0.188	<b>0.24</b>	0.03
<b>Hotspot Test Data (10mm)</b>									
4183	836.6	RMC	Left	/	21.90	23.0	0.068	<b>0.09</b>	-0.11
4183	836.6	RMC	Right	/	21.90	23.0	0.093	<b>0.12</b>	-0.17
4183	836.6	RMC	Bottom	/	21.90	23.0	0.023	<b>0.03</b>	0.08

**Table 13.11: SAR Values (LTE Band 2 - Head)**

Frequency		Test Mode	Test Position	Figure No./ Note	Conducted Power (dBm)	Max. tune-up Power (dBm)	Measured SAR(1g) (W/kg)	Reported SAR(1g) (W/kg)	Power Drift(dB)
Ch.	MHz								
18900	1880.0	1RB99	Left Cheek	/	22.94	24.0	0.212	<b>0.27</b>	0.03
18900	1880.0	50RB25	Left Cheek	/	22.42	23.0	0.230	<b>0.26</b>	-0.05
18900	1880.0	1RB99	Left Tilt	/	22.94	24.0	0.135	<b>0.17</b>	0.12
18900	1880.0	50RB25	Left Tilt	/	22.42	23.0	0.145	<b>0.17</b>	0.03
18900	1880.0	1RB99	Right Cheek	/	22.94	24.0	0.506	<b>0.65</b>	0.12
18900	1880.0	50RB25	Right Cheek	<b>11</b>	22.42	23.0	<b>0.538</b>	<b>0.61</b>	-0.04
18900	1880.0	1RB99	Right Tilt	/	22.94	24.0	0.344	<b>0.44</b>	-0.04
18900	1880.0	50RB25	Right Tilt	/	22.42	23.0	0.364	<b>0.42</b>	-0.13
18900	1880.0	50RB25	Right Cheek	C2	22.42	23.0	0.498	<b>0.57</b>	0.03

**Table 13.12: SAR Values (LTE Band 2 - Body)**

Frequency		Test Mode	Test Position	Figure No./ Note	Conducted Power (dBm)	Max. tune-up Power (dBm)	Measured SAR(1g) (W/kg)	Reported SAR(1g) (W/kg)	Power Drift(dB)
Ch.	MHz								
<b>Hotspot / Body-Worn Test Data (10mm)</b>									
18900	1880.0	1RB99	Front	/	22.94	24.0	0.144	<b>0.18</b>	0.17
18900	1880.0	50RB25	Front	/	22.42	23.0	0.146	<b>0.17</b>	0.03
18900	1880.0	1RB99	Rear	/	22.94	24.0	0.207	<b>0.26</b>	0.04
18900	1880.0	50RB25	Rear	<b>12</b>	22.42	23.0	<b>0.225</b>	<b>0.26</b>	-0.05
18900	1880.0	50RB25	Rear	C2	22.42	23.0	0.171	<b>0.20</b>	0.02
<b>Hotspot Test Data (10mm)</b>									
18900	1880.0	1RB99	Left	/	22.94	24.0	0.124	<b>0.16</b>	0.06
18900	1880.0	50RB25	Left	/	22.42	23.0	0.120	<b>0.14</b>	-0.11
18900	1880.0	1RB99	Right	/	22.94	24.0	0.002	<b>&lt;0.01</b>	0.08
18900	1880.0	50RB25	Right	/	22.42	23.0	0.003	<b>&lt;0.01</b>	0.04
18900	1880.0	1RB99	Top	/	22.94	24.0	0.061	<b>0.08</b>	-0.04
18900	1880.0	50RB25	Top	/	22.42	23.0	0.058	<b>0.07</b>	0.08

**Table 13.13: SAR Values (LTE Band 4 - Head)**

Frequency		Test Mode	Test Position	Figure No./ Note	Conducted Power (dBm)	Max. tune-up Power (dBm)	Measured SAR(1g) (W/kg)	Reported SAR(1g) (W/kg)	Power Drift(dB)
Ch.	MHz								
20175	1732.5	1RB0	Left Cheek	/	22.91	24.0	0.226	<b>0.29</b>	0.15
20175	1732.5	50RB25	Left Cheek	/	22.40	23.0	0.222	<b>0.25</b>	-0.01
20175	1732.5	1RB0	Left Tilt	/	22.91	24.0	0.160	<b>0.21</b>	0.04
20175	1732.5	50RB25	Left Tilt	/	22.40	23.0	0.157	<b>0.18</b>	-0.05
20175	1732.5	1RB0	Right Cheek	/	22.91	24.0	0.444	<b>0.57</b>	0.02
20175	1732.5	50RB25	Right Cheek	<b>13</b>	22.40	23.0	<b>0.465</b>	<b>0.53</b>	0.05
20175	1732.5	1RB0	Right Tilt	/	22.91	24.0	0.359	<b>0.46</b>	0.01
20175	1732.5	50RB25	Right Tilt	/	22.40	23.0	0.369	<b>0.42</b>	0.17
20175	1732.5	1RB0	Right Cheek	C2	22.91	24.0	0.431	<b>0.55</b>	-0.02

**Table 13.14: SAR Values (LTE Band 4 - Body)**

Frequency		Test Mode	Test Position	Figure No./ Note	Conducted Power (dBm)	Max. tune-up Power (dBm)	Measured SAR(1g) (W/kg)	Reported SAR(1g) (W/kg)	Power Drift(dB)
Ch.	MHz								
<b>Hotspot / Body-Worn Test Data (10mm)</b>									
20175	1732.5	1RB0	Front	/	22.91	24.0	0.114	<b>0.15</b>	0.14
20175	1732.5	50RB25	Front	/	22.40	23.0	0.116	<b>0.13</b>	0.02
20175	1732.5	1RB0	Rear	/	22.91	24.0	0.164	<b>0.21</b>	0.03
20175	1732.5	50RB25	Rear	<b>14</b>	22.40	23.0	<b>0.175</b>	<b>0.20</b>	0.04
20175	1732.5	50RB25	Rear	C2	22.40	23.0	0.133	<b>0.15</b>	0.03
<b>Hotspot Test Data (10mm)</b>									
20175	1732.5	1RB0	Left	/	22.91	24.0	0.098	<b>0.13</b>	0.03
20175	1732.5	50RB25	Left	/	22.40	23.0	0.095	<b>0.11</b>	-0.16
20175	1732.5	1RB0	Right	/	22.91	24.0	0.013	<b>0.02</b>	0.08
20175	1732.5	50RB25	Right	/	22.40	23.0	0.014	<b>0.02</b>	-0.15
20175	1732.5	1RB0	Top	/	22.91	24.0	0.088	<b>0.11</b>	0.04
20175	1732.5	50RB25	Top	/	22.40	23.0	0.084	<b>0.10</b>	-0.10

**Table 13.15: SAR Values (LTE Band 5 - Head)**

Frequency		Test Mode	Test Position	Figure No./ Note	Conducted Power (dBm)	Max. tune-up Power (dBm)	Measured SAR(1g) (W/kg)	Reported SAR(1g) (W/kg)	Power Drift(dB)
Ch.	MHz								
20600	844.0	1RB49	Left Cheek	<b>15</b>	22.62	24.0	<b>0.181</b>	<b>0.25</b>	0.07
20600	844.0	25RB12	Left Cheek	/	22.17	23.0	0.161	<b>0.19</b>	0.09
20600	844.0	1RB49	Left Tilt	/	22.62	24.0	0.093	<b>0.13</b>	0.05
20600	844.0	25RB12	Left Tilt	/	22.17	23.0	0.082	<b>0.10</b>	-0.13
20600	844.0	1RB49	Right Cheek	/	22.62	24.0	0.153	<b>0.21</b>	0.18
20600	844.0	25RB12	Right Cheek	/	22.17	23.0	0.128	<b>0.15</b>	0.14
20600	844.0	1RB49	Right Tilt	/	22.62	24.0	0.076	<b>0.10</b>	0.01
20600	844.0	25RB12	Right Tilt	/	22.17	23.0	0.072	<b>0.09</b>	0.03
20600	844.0	1RB49	Left Cheek	C2	22.62	24.0	0.177	<b>0.24</b>	0.02

**Table 13.16: SAR Values (LTE Band 5 - Body)**

Frequency		Test Mode	Test Position	Figure No./ Note	Conducted Power (dBm)	Max. tune-up Power (dBm)	Measured SAR(1g) (W/kg)	Reported SAR(1g) (W/kg)	Power Drift(dB)
Ch.	MHz								
<b>Hotspot / Body-Worn Test Data (10mm)</b>									
20600	844.0	1RB49	Front	/	22.62	24.0	0.152	<b>0.21</b>	-0.19
20600	844.0	25RB12	Front	/	22.17	23.0	0.134	<b>0.16</b>	0.00
20600	844.0	1RB49	Rear	<b>16</b>	22.62	24.0	<b>0.231</b>	<b>0.32</b>	0.11
20600	844.0	25RB12	Rear	/	22.17	23.0	0.194	<b>0.23</b>	0.04
20600	844.0	1RB49	Rear	C2	22.62	24.0	0.224	<b>0.31</b>	0.02
<b>Hotspot Test Data (10mm)</b>									
20600	844.0	1RB49	Left	/	22.62	24.0	0.062	<b>0.09</b>	0.17
20600	844.0	25RB12	Left	/	22.17	23.0	0.042	<b>0.05</b>	0.19
20600	844.0	1RB49	Right	/	22.62	24.0	0.059	<b>0.08</b>	0.05
20600	844.0	25RB12	Right	/	22.17	23.0	0.041	<b>0.05</b>	0.07
20600	844.0	1RB49	Bottom	/	22.62	24.0	0.062	<b>0.09</b>	-0.06
20600	844.0	25RB12	Bottom	/	22.17	23.0	0.053	<b>0.06</b>	-0.10



**Table 13.17: SAR Values (LTE Band 7 - Head)**

Frequency		Test Mode	Test Position	Figure No./ Note	Conducted Power (dBm)	Max. tune-up Power (dBm)	Measured SAR(1g) (W/kg)	Reported SAR(1g) (W/kg)	Power Drift(dB)
Ch.	MHz								
20850	2510.0	1RB99	Left Cheek	/	21.71	23.0	0.263	<b>0.35</b>	-0.05
20850	2510.0	50RB50	Left Cheek	/	21.19	22.0	0.239	<b>0.29</b>	-0.03
20850	2510.0	1RB99	Left Tilt	/	21.71	23.0	0.276	<b>0.37</b>	0.06
20850	2510.0	50RB50	Left Tilt	/	21.19	22.0	0.248	<b>0.30</b>	-0.02
20850	2510.0	1RB99	Right Cheek	/	21.71	23.0	0.421	<b>0.57</b>	-0.13
20850	2510.0	50RB50	Right Cheek	/	21.19	22.0	0.385	<b>0.46</b>	-0.02
20850	2510.0	1RB99	Right Tilt	/	21.71	23.0	0.738	<b>0.99</b>	0.03
20850	2510.0	50RB50	Right Tilt	/	21.19	22.0	0.709	<b>0.85</b>	0.09
21350	2560.0	1RB99	Right Tilt	/	21.68	23.0	0.670	<b>0.91</b>	-0.13
21100	2535.0	1RB99	Right Tilt	/	21.66	23.0	0.751	<b>1.02</b>	-0.01
21350	2560.0	50RB50	Right Tilt	/	21.17	22.0	0.637	<b>0.77</b>	0.03
21100	2535.0	50RB50	Right Tilt	/	21.07	22.0	0.667	<b>0.83</b>	0.04
20850	2510.0	100RB	Right Tilt	/	21.19	22.0	0.682	<b>0.82</b>	0.04
21100	2535.0	1RB99	Right Tilt	<b>17/C2</b>	21.66	23.0	<b>0.759</b>	<b>1.03</b>	0.08

**Table 13.18: SAR Values (LTE Band 7 - Body)**

Frequency		Test Mode	Test Position	Figure No./ Note	Conducted Power (dBm)	Max. tune-up Power (dBm)	Measured SAR(1g) (W/kg)	Reported SAR(1g) (W/kg)	Power Drift(dB)
Ch.	MHz								
<b>Hotspot / Body-Worn Test Data (10mm)</b>									
20850	2510.0	1RB99	Front	/	21.71	23.0	0.100	<b>0.13</b>	0.02
20850	2510.0	50RB50	Front	/	21.19	22.0	0.081	<b>0.10</b>	-0.12
20850	2510.0	1RB99	Rear	/	21.71	23.0	0.217	<b>0.29</b>	0.04
20850	2510.0	50RB50	Rear	/	21.19	22.0	0.182	<b>0.22</b>	0.06
20850	2510.0	1RB99	Rear	<b>18/C2</b>	21.71	23.0	<b>0.275</b>	<b>0.37</b>	0.04
<b>Hotspot Test Data (10mm)</b>									
20850	2510.0	1RB99	Left	/	21.71	23.0	0.024	<b>0.03</b>	-0.15
20850	2510.0	50RB50	Left	/	21.19	22.0	0.020	<b>0.02</b>	-0.08
20850	2510.0	1RB99	Right	/	21.71	23.0	0.010	<b>0.01</b>	0.02
20850	2510.0	50RB50	Right	/	21.19	22.0	0.010	<b>0.01</b>	0.17
20850	2510.0	1RB99	Top	/	21.71	23.0	0.210	<b>0.28</b>	-0.17
20850	2510.0	50RB50	Top	/	21.19	22.0	0.197	<b>0.24</b>	0.03

**Table 13.19: SAR Values (LTE Band 12 - Head)**

Frequency		Test Mode	Test Position	Figure No./ Note	Conducted Power (dBm)	Max. tune-up Power (dBm)	Measured SAR(1g) (W/kg)	Reported SAR(1g) (W/kg)	Power Drift(dB)
Ch.	MHz								
23060	704.0	1RB49	Left Cheek	<b>19</b>	22.78	24.0	<b>0.175</b>	<b>0.23</b>	0.04
23060	704.0	25RB0	Left Cheek	/	22.65	23.0	0.161	<b>0.17</b>	0.03
23060	704.0	1RB49	Left Tilt	/	22.78	24.0	0.094	<b>0.12</b>	-0.08
23060	704.0	25RB0	Left Tilt	/	22.65	23.0	0.085	<b>0.09</b>	0.16
23060	704.0	1RB49	Right Cheek	/	22.78	24.0	0.124	<b>0.16</b>	0.19
23060	704.0	25RB0	Right Cheek	/	22.65	23.0	0.118	<b>0.13</b>	0.13
23060	704.0	1RB49	Right Tilt	/	22.78	24.0	0.081	<b>0.11</b>	0.02
23060	704.0	25RB0	Right Tilt	/	22.65	23.0	0.080	<b>0.09</b>	0.06
23060	704.0	1RB49	Left Cheek	C2	22.78	24.0	0.167	<b>0.22</b>	0.01

**Table 13.20: SAR Values (LTE Band 12 - Body)**

Frequency		Test Mode	Test Position	Figure No./ Note	Conducted Power (dBm)	Max. tune-up Power (dBm)	Measured SAR(1g) (W/kg)	Reported SAR(1g) (W/kg)	Power Drift(dB)
Ch.	MHz								
<b>Hotspot / Body-Worn Test Data (10mm)</b>									
23060	704.0	1RB49	Front	/	22.78	24.0	0.131	<b>0.17</b>	0.04
23060	704.0	25RB0	Front	/	22.65	23.0	0.121	<b>0.13</b>	0.11
23060	704.0	1RB49	Rear	/	22.78	24.0	0.178	<b>0.24</b>	0.18
23060	704.0	25RB0	Rear	/	22.65	23.0	0.172	<b>0.19</b>	0.14
23060	704.0	1RB49	Rear	<b>20/C2</b>	22.78	24.0	<b>0.358</b>	<b>0.47</b>	0.03
<b>Hotspot Test Data (10mm)</b>									
23060	704.0	1RB49	Left	/	22.78	24.0	0.048	<b>0.06</b>	0.08
23060	704.0	25RB0	Left	/	22.65	23.0	0.045	<b>0.05</b>	-0.06
23060	704.0	1RB49	Right	/	22.78	24.0	0.056	<b>0.07</b>	0.07
23060	704.0	25RB0	Right	/	22.65	23.0	0.045	<b>0.05</b>	-0.17
23060	704.0	1RB49	Bottom	/	22.78	24.0	0.003	<b>&lt;0.01</b>	-0.09
23060	704.0	25RB0	Bottom	/	22.65	23.0	0.002	<b>&lt;0.01</b>	0.03

**Table 13.21: SAR Values (LTE Band 26 - Head)**

Frequency		Test Mode	Test Position	Figure No./ Note	Conducted Power (dBm)	Max. tune-up Power (dBm)	Measured SAR(1g) (W/kg)	Reported SAR(1g) (W/kg)	Power Drift(dB)
Ch.	MHz								
26965	841.5	1RB74	Left Cheek	<b>21</b>	22.58	24.0	<b>0.181</b>	<b>0.25</b>	0.06
26965	841.5	36RB0	Left Cheek	/	22.34	23.0	0.145	<b>0.17</b>	0.05
26965	841.5	1RB74	Left Tilt	/	22.58	24.0	0.096	<b>0.13</b>	0.10
26965	841.5	36RB0	Left Tilt	/	22.34	23.0	0.080	<b>0.09</b>	0.14
26965	841.5	1RB74	Right Cheek	/	22.58	24.0	0.165	<b>0.23</b>	0.15
26965	841.5	36RB0	Right Cheek	/	22.34	23.0	0.135	<b>0.16</b>	0.13
26965	841.5	1RB74	Right Tilt	/	22.58	24.0	0.087	<b>0.12</b>	0.06
26965	841.5	36RB0	Right Tilt	/	22.34	23.0	0.075	<b>0.09</b>	0.03
26965	841.5	1RB74	Left Cheek	C2	22.58	24.0	0.169	<b>0.23</b>	0.03

**Table 13.22: SAR Values (LTE Band 26 - Body)**

Frequency		Test Mode	Test Position	Figure No./ Note	Conducted Power (dBm)	Max. tune-up Power (dBm)	Measured SAR(1g) (W/kg)	Reported SAR(1g) (W/kg)	Power Drift(dB)
Ch.	MHz								
<b>Hotspot / Body-Worn Test Data (10mm)</b>									
26965	841.5	1RB74	Front	/	22.58	24.0	0.149	<b>0.21</b>	0.03
26965	841.5	36RB0	Front	/	22.34	23.0	0.150	<b>0.17</b>	-0.06
26965	841.5	1RB74	Rear	<b>22</b>	22.58	24.0	<b>0.246</b>	<b>0.34</b>	0.02
26965	841.5	36RB0	Rear	/	22.34	23.0	0.214	<b>0.25</b>	-0.19
26965	841.5	1RB74	Rear	C2	22.58	24.0	0.241	<b>0.33</b>	0.03
<b>Hotspot Test Data (10mm)</b>									
26965	841.5	1RB74	Left	/	22.58	24.0	0.004	<b>0.01</b>	-0.09
26965	841.5	36RB0	Left	/	22.34	23.0	0.004	<b>&lt;0.01</b>	0.07
26965	841.5	1RB74	Right	/	22.58	24.0	0.003	<b>&lt;0.01</b>	0.02
26965	841.5	36RB0	Right	/	22.34	23.0	0.003	<b>&lt;0.01</b>	0.05
26965	841.5	1RB74	Bottom	/	22.58	24.0	0.043	<b>0.06</b>	0.09
26965	841.5	36RB0	Bottom	/	22.34	23.0	0.070	<b>0.08</b>	0.10



**Table 13.23: SAR Values (Bluetooth - Head)**

Frequency		Test Mode	Test Position	Figure No./ Note	Conducted Power (dBm)	Max. tune-up Power (dBm)	Measured SAR(1g) (W/kg)	Reported SAR(1g) (W/kg)	Power Drift(dB)
Ch.	MHz								
0	2402.0	GFSK	Left Cheek	<b>23</b>	6.75	7.5	<b>0.020</b>	<b>0.02</b>	0.05
0	2402.0	GFSK	Left Tilt	/	6.75	7.5	0.020	<b>0.02</b>	0.09
0	2402.0	GFSK	Right Cheek	/	6.75	7.5	0.006	<b>0.01</b>	-0.01
0	2402.0	GFSK	Right Tilt	/	6.75	7.5	0.008	<b>0.01</b>	-0.05
0	2402.0	GFSK	Left Cheek	C2	6.75	7.5	0.018	<b>0.02</b>	0.03

**Table 13.24: SAR Values (Bluetooth - Body)**

Frequency		Test Mode	Test Position	Figure No./ Note	Conducted Power (dBm)	Max. tune-up Power (dBm)	Measured SAR(1g) (W/kg)	Reported SAR(1g) (W/kg)	Power Drift(dB)
Ch.	MHz								
<b>Test Data (10mm)</b>									
0	2402.0	GFSK	Front	/	6.75	7.5	0.004	<b>0.01</b>	0.06
0	2402.0	GFSK	Rear	/	6.75	7.5	0.006	<b>0.01</b>	0.05
0	2402.0	GFSK	Right	/	6.75	7.5	0.006	<b>0.01</b>	0.04
0	2402.0	GFSK	Top	<b>24</b>	6.75	7.5	<b>0.044</b>	<b>0.05</b>	0.03
0	2402.0	GFSK	Top	C2	6.75	7.5	0.043	<b>0.05</b>	0.01



### 13.3. WLAN Evaluation for 2.4GHz

According to the KDB248227 D01, SAR is measured for 2.4GHz 802.11b DSSS using the initial test position procedure.

**Table 13.25: SAR Values (WLAN 2.4GHz - Head)**

Frequency		Test Mode	Test Position	Figure No./ Note	Conducted Power (dBm)	Max. tune-up Power (dBm)	Measured SAR(1g) (W/kg)	Reported SAR(1g) (W/kg)	Power Drift(dB)
Ch.	MHz								
6	2437.0	802.11b	Left Cheek	/	16.06	17.0	0.158	<b>0.20</b>	0.12
6	2437.0	802.11b	Left Tilt	/	16.06	17.0	0.120	<b>0.15</b>	0.04
6	2437.0	802.11b	Right Cheek	/	16.06	17.0	0.056	<b>0.07</b>	0.03
6	2437.0	802.11b	Right Tilt	/	16.06	17.0	0.053	<b>0.07</b>	0.05
6	2437.0	802.11b	Left Cheek	<b>25/C2</b>	16.06	17.0	<b>0.169</b>	<b>0.21</b>	0.08

Note: For all positions/configurations tested using the initial test position and subsequent test positions, when the reported SAR is > 0.8 W/kg, SAR is measured for these test positions/configurations on the subsequent next highest measured output power channel until the reported SAR is ≤ 1.2 W/kg or all required channels are tested.

According to the KDB248227 D01, The reported SAR must be scaled to 100% transmission duty factor to determine compliance at the maximum tune-up tolerance limit.

**Table 13.26: SAR Values (WLAN - Head) – 802.11b (Scaled Reported SAR)**

Frequency		Test Position	Actual duty factor	maximum duty factor	Reported SAR (1g)(W/kg)	Scaled reported SAR (1g)(W/kg)
Ch.	MHz					
6	2437.0	Left Cheek	100%	100%	0.21	<b>0.21</b>

SAR is not required for OFDM because the 802.11b adjusted SAR ≤ 1.2 W/kg.



**Table 13.27: SAR Values (WLAN 2.4GHz - Body)**

Frequency		Test Mode	Test Position	Figure No./ Note	Conducted Power (dBm)	Max. tune-up Power (dBm)	Measured SAR(1g) (W/kg)	Reported SAR(1g) (W/kg)	Power Drift(dB)
Ch.	MHz								
<b>Hotspot / Body-Worn Test Data (10mm)</b>									
6	2437.0	802.11b	Front	/	16.06	17.0	0.028	<b>0.04</b>	0.04
6	2437.0	802.11b	Rear	/	16.06	17.0	0.036	<b>0.04</b>	0.08
<b>Hotspot Test Data (10mm)</b>									
6	2437.0	802.11b	Right	/	16.06	17.0	0.044	<b>0.05</b>	0.04
6	2437.0	802.11b	Top	/	16.06	17.0	0.025	<b>0.03</b>	0.17
6	2437.0	802.11b	Right	<b>26/C2</b>	16.06	17.0	<b>0.054</b>	<b>0.07</b>	0.12

Note: For all positions/configurations tested using the initial test position and subsequent test positions, when the reported SAR is > 0.8 W/kg, SAR is measured for these test positions/configurations on the subsequent next highest measured output power channel until the reported SAR is ≤ 1.2 W/kg or all required channels are tested.

According to the KDB248227 D01, The reported SAR must be scaled to 100% transmission duty factor to determine compliance at the maximum tune-up tolerance limit.

**Table 13.28: SAR Values (WLAN - Body) – 802.11b (Scaled Reported SAR)**

Frequency		Test Position	Actual duty factor	maximum duty factor	Reported SAR (1g)(W/kg)	Scaled reported SAR (1g)(W/kg)
Ch.	MHz					
6	2437.0	Right	100%	100%	0.07	<b>0.07</b>

SAR is not required for OFDM because the 802.11b adjusted SAR ≤ 1.2 W/kg.

**13.4. WLAN Evaluation for 5GHz**

**Table 13.29: SAR Values (WLAN 5GHz - Head)**

Frequency		Test Mode	Test Position	Figure No./ Note	Conducted Power (dBm)	Max. tune-up Power (dBm)	Measured SAR(1g) (W/kg)	Reported SAR(1g) (W/kg)	Power Drift(dB)
Ch.	MHz								
<b>&lt;U-NII-2A&gt;</b>									
60	5300.0	802.11a	Left Cheek	/	12.91	14.0	0.437	<b>0.56</b>	-0.15
60	5300.0	802.11a	Left Tilt	<b>27</b>	12.91	14.0	<b>0.545</b>	<b>0.70</b>	0.00
60	5300.0	802.11a	Right Cheek	/	12.91	14.0	0.339	<b>0.44</b>	-0.03
60	5300.0	802.11a	Right Tilt	/	12.91	14.0	0.418	<b>0.54</b>	0.01
60	5300.0	802.11a	Left Tilt	C2	12.91	14.0	0.361	<b>0.46</b>	0.05
<b>&lt;U-NII-2C&gt;</b>									
100	5500.0	802.11a	Left Cheek	/	12.84	14.0	0.462	<b>0.60</b>	-0.02
100	5500.0	802.11a	Left Tilt	/	12.84	14.0	0.536	<b>0.70</b>	0.01
100	5500.0	802.11a	Right Cheek	/	12.84	14.0	0.374	<b>0.49</b>	-0.06
100	5500.0	802.11a	Right Tilt	/	12.84	14.0	0.421	<b>0.55</b>	-0.17
<b>&lt;U-NII-3&gt;</b>									
149	5745.0	802.11a	Left Cheek	/	10.56	11.5	0.288	<b>0.36</b>	0.13
149	5745.0	802.11a	Left Tilt	/	10.56	11.5	0.282	<b>0.35</b>	0.15
149	5745.0	802.11a	Right Cheek	/	10.56	11.5	0.256	<b>0.32</b>	0.11
149	5745.0	802.11a	Right Tilt	/	10.56	11.5	0.299	<b>0.37</b>	0.03

**Note:**

1. U-NII-1 and U-NII-2A bands have the same specified maximum output and tolerance; SAR is measured for U-NII-2A band first. Adjusted SAR of U-NII-2A band is  $\leq 1.2$  W/kg, SAR is not required for U-NII-1 band.
2. For all positions/configurations tested using the initial test position and subsequent test positions, when the reported SAR is  $> 0.8$  W/kg, SAR is measured for these test positions/configurations on the subsequent next highest measured output power channel until the reported SAR is  $\leq 1.2$  W/kg or all required channels are tested.

According to the KDB248227 D01, The reported SAR must be scaled to 100% transmission duty factor to determine compliance at the maximum tune-up tolerance limit.

**Table 13.30: SAR Values (WLAN - Head) - 802.11a (Scaled Reported SAR)**

Frequency		Test Position	Actual duty factor	maximum duty factor	Reported SAR (1g)(W/kg)	Scaled reported SAR (1g)(W/kg)
Ch.	MHz					
60	5300.0	Left Tilt	100%	100%	0.70	<b>0.70</b>

**Table 13.31: SAR Values (WLAN 5GHz - Body)**

Frequency		Test Mode	Test Position	Figure No./ Note	Conducted Power (dBm)	Max. tune-up Power (dBm)	Measured SAR(1g) (W/kg)	Reported SAR(1g) (W/kg)	Power Drift(dB)
Ch.	MHz								
<b>&lt;U-NII-1&gt; - Hotspot Test Data (10mm)</b>									
36	5180.0	802.11a	Front	/	12.92	14.0	0.074	<b>0.10</b>	-0.13
36	5180.0	802.11a	Rear	<b>28</b>	12.92	14.0	<b>0.335</b>	<b>0.43</b>	0.04
36	5180.0	802.11a	Right	/	12.92	14.0	0.106	<b>0.14</b>	0.16
36	5180.0	802.11a	Top	/	12.92	14.0	0.278	<b>0.36</b>	-0.14
36	5180.0	802.11a	Rear	C2	12.92	14.0	0.272	<b>0.35</b>	0.04
<b>&lt;U-NII-3&gt; - Hotspot Test Data (10mm)</b>									
149	5745.0	802.11a	Front	/	10.56	11.5	0.095	<b>0.12</b>	0.03
149	5745.0	802.11a	Rear	/	10.56	11.5	0.174	<b>0.22</b>	0.04
149	5745.0	802.11a	Right	/	10.56	11.5	0.081	<b>0.10</b>	0.12
149	5745.0	802.11a	Top	/	10.56	11.5	0.169	<b>0.21</b>	0.03
<b>&lt; U-NII-2A&gt; - Body-Worn Test Data (15mm)</b>									
60	5300.0	802.11a	Front	/	12.91	14.0	0.088	<b>0.11</b>	0.08
60	5300.0	802.11a	Rear	/	12.91	14.0	0.247	<b>0.32</b>	0.02
<b>&lt; U-NII-2C&gt; - Body-Worn Test Data (15mm)</b>									
100	5500.0	802.11a	Front	/	12.84	14.0	0.080	<b>0.10</b>	0.03
100	5500.0	802.11a	Rear	/	12.84	14.0	0.259	<b>0.34</b>	0.04
<b>&lt; U-NII-3&gt; - Body-Worn Test Data (10mm)</b>									
149	5745.0	802.11a	Front	/	10.56	11.5	0.095	<b>0.12</b>	0.03
149	5745.0	802.11a	Rear	/	10.56	11.5	0.174	<b>0.22</b>	0.04

**Note:**

1. U-NII-1 and U-NII-2A bands have the same specified maximum output and tolerance; SAR is measured for U-NII-2A band first. Adjusted SAR of U-NII-2A band is  $\leq 1.2$  W/kg, SAR is not required for U-NII-1 band.
2. For all positions/configurations tested using the initial test position and subsequent test positions, when the reported SAR is  $> 0.8$  W/kg, SAR is measured for these test positions/configurations on the subsequent next highest measured output power channel until the reported SAR is  $\leq 1.2$  W/kg or all required channels are tested.

According to the KDB248227 D01, The reported SAR must be scaled to 100% transmission duty factor to determine compliance at the maximum tune-up tolerance limit.

**Table 13.32: SAR Values (WLAN - Body) - 802.11a (Scaled Reported SAR)**

Frequency		Test Position	Actual duty factor	maximum duty factor	Reported SAR (1g)(W/kg)	Scaled reported SAR (1g)(W/kg)
Ch.	MHz					
36	5180.0	Rear	100%	100%	0.43	<b>0.43</b>





**13.5. Product specific 10g SAR**

**Table 13.33: SAR Values (WLAN 5GHz - Extremity)**

Frequency		Test Mode	Test Position	Figure No./ Note	Conducted Power (dBm)	Max. tune-up Power (dBm)	Measured SAR(10g) (W/kg)	Reported SAR(10g) (W/kg)	Power Drift(dB)
Ch.	MHz								
<b>&lt;U-NII-2A&gt; -Test Data (0mm)</b>									
60	5300.0	802.11a	Front	/	12.91	14.0	0.238	<b>0.31</b>	-0.18
60	5300.0	802.11a	Rear	/	12.91	14.0	0.613	<b>0.79</b>	0.03
60	5300.0	802.11a	Right	/	12.91	14.0	0.174	<b>0.22</b>	-0.01
60	5300.0	802.11a	Top	/	12.91	14.0	0.568	<b>0.73</b>	-0.05
<b>&lt;U-NII-2C&gt; -Test Data (0mm)</b>									
100	5500.0	802.11a	Front	/	12.84	14.0	0.268	<b>0.35</b>	-0.12
100	5500.0	802.11a	Rear	<b>29</b>	12.84	14.0	<b>0.686</b>	<b>0.90</b>	-0.12
100	5500.0	802.11a	Right	/	12.84	14.0	0.167	<b>0.22</b>	0.19
100	5500.0	802.11a	Top	/	12.84	14.0	0.517	<b>0.68</b>	-0.07
100	5500.0	802.11a	Rear	C2	12.84	14.0	0.468	<b>0.61</b>	0.03

## 14. SAR Measurement Variability

SAR measurement variability must be assessed for each frequency band, which is determined by the SAR probe calibration point and tissue-equivalent medium used for the device measurements. When both head and body tissue-equivalent media are required for SAR measurements in a frequency band, the variability measurement procedures should be applied to the tissue medium with the highest measured SAR, using the highest measured SAR configuration for that tissue-equivalent medium.

The following procedures are applied to determine if repeated measurements are required.

- 1) Repeated measurement is not required when the original highest measured SAR is  $< 0.80$  W/kg; steps 2) through 4) do not apply.
- 2) When the original highest measured SAR is  $\geq 0.80$  W/kg, repeat that measurement once.
- 3) Perform a second repeated measurement only if the ratio of largest to smallest SAR for the original and first repeated measurements is  $> 1.20$  or when the original or repeated measurement is  $\geq 1.45$  W/kg ( $\sim 10\%$  from the 1-g SAR limit).
- 4) Perform a third repeated measurement only if the original, first or second repeated measurement is  $\geq 1.5$  W/kg and the ratio of largest to smallest SAR for the original, first and second repeated measurements is  $> 1.20$ .

## 15. Measurement Uncertainty

### 15.1. Measurement Uncertainty for Normal SAR Tests (300MHz~3GHz)

No.	Error Description	Type	Uncertainty value	Probably Distribution	Div.	(Ci) 1g	(Ci) 10g	Std. Unc. (1g)	Std. Unc. (10g)	Degree of freedom
<b>Measurement system</b>										
1	Probe calibration	B	12	N	2	1	1	6.0	6.0	∞
2	Axial isotropy	B	4.7	R	$\sqrt{3}$	$\sqrt{0.5}$	$\sqrt{0.5}$	4.3	4.3	∞
3	Hemispherical isotropy	B	9.6	R	$\sqrt{3}$	1	1	4.8	4.8	∞
4	Boundary effect	B	1.1	R	$\sqrt{3}$	1	1	0.6	0.6	∞
5	Linearity	B	4.7	R	$\sqrt{3}$	1	1	2.7	2.7	∞
6	Detection limit	B	1.0	R	$\sqrt{3}$	1	1	0.6	0.6	∞
7	Modulation response	B	4.0	R	$\sqrt{3}$	1	1	2.3	2.3	∞
8	Readout electronics	B	1.0	N	1	1	1	1.0	1.0	∞
9	Response time	B	0.8	R	$\sqrt{3}$	1	1	0.5	0.5	∞
10	Integration time	B	1.7	R	$\sqrt{3}$	1	1	1.0	1.0	∞
11	RF ambient conditions-noise	B	3.0	R	$\sqrt{3}$	1	1	1.7	1.7	∞
12	RF ambient conditions-reflection	B	3.0	R	$\sqrt{3}$	1	1	1.7	1.7	∞
13	Probe positioned mech. restrictions	B	0.35	R	$\sqrt{3}$	1	1	0.2	0.2	∞
14	Probe positioning with respect to phantom shell	B	2.9	R	$\sqrt{3}$	1	1	1.7	1.7	∞
15	Post-processing	B	1.0	R	$\sqrt{3}$	1	1	0.6	0.6	∞
<b>Test sample related</b>										
16	Test sample positioning	A	3.3	N	1	1	1	3.3	3.3	5
17	Device holder uncertainty	A	3.4	N	1	1	1	3.4	3.4	5
18	Drift of output power	B	5.0	R	$\sqrt{3}$	1	1	2.9	2.9	∞
<b>Phantom and set-up</b>										
19	Phantom uncertainty	B	1.0	R	$\sqrt{3}$	1	1	0.6	0.6	∞
20	Liquid conductivity (target)	B	5.0	R	$\sqrt{3}$	0.64	0.43	1.8	1.2	∞
21	Liquid conductivity (meas.)	A	1.3	N	1	0.64	0.43	0.83	0.56	9
22	Liquid permittivity (target)	B	5.0	R	$\sqrt{3}$	0.6	0.49	1.7	1.4	∞
23	Liquid permittivity (meas.)	A	1.6	N	1	0.6	0.49	0.96	0.78	9
Combined standard uncertainty		$u_c = \sqrt{\sum_{i=1}^{23} c_i^2 u_i^2}$						11.3	11.2	95.5
Expanded uncertainty (Confidence interval of 95 %)		$u_e = 2u_c$						22.6	22.4	

**15.2. Measurement Uncertainty for Normal SAR Tests (3GHz~6GHz)**

No.	Error Description	Type	Uncertainty value	Probably Distribution	Div.	(Ci) 1g	(Ci) 10g	Std. Unc. (1g)	Std. Unc. (10g)	Degree of freedom
<b>Measurement system</b>										
1	Probe calibration	B	13.1	N	2	1	1	6.65	6.65	∞
2	Axial isotropy	B	4.7	R	$\sqrt{3}$	$\sqrt{0.5}$	$\sqrt{0.5}$	4.3	4.3	∞
3	Hemispherical isotropy	B	9.6	R	$\sqrt{3}$	1	1	4.8	4.8	∞
4	Boundary effect	B	1.1	R	$\sqrt{3}$	1	1	0.6	0.6	∞
5	Linearity	B	4.7	R	$\sqrt{3}$	1	1	2.7	2.7	∞
6	Detection limit	B	1.0	R	$\sqrt{3}$	1	1	0.6	0.6	∞
7	modulation response	B	4.0	R	$\sqrt{3}$	1	1	2.3	2.3	∞
8	Readout electronics	B	1.0	N	1	1	1	1.0	1.0	∞
9	Response time	B	0.0	R	$\sqrt{3}$	1	1	0.0	0.0	∞
10	Integration time	B	1.7	R	$\sqrt{3}$	1	1	1.0	1.0	∞
11	RF ambient conditions-noise	B	3.0	R	$\sqrt{3}$	1	1	1.7	1.7	∞
12	RF ambient conditions-reflection	B	3.0	R	$\sqrt{3}$	1	1	1.7	1.7	∞
13	Probe positioned mech. Restrictions	B	0.35	R	$\sqrt{3}$	1	1	0.2	0.2	∞
14	Probe positioning with respect to phantom shell	B	2.9	R	$\sqrt{3}$	1	1	1.7	1.7	∞
15	Post-processing	B	1.0	R	$\sqrt{3}$	1	1	0.6	0.6	∞
<b>Test sample related</b>										
16	Test sample positioning	A	3.3	N	1	1	1	3.3	3.3	5
17	Device holder uncertainty	A	3.4	N	1	1	1	3.4	3.4	5
18	Drift of output power	B	5.0	R	$\sqrt{3}$	1	1	2.9	2.9	∞
<b>Phantom and set-up</b>										
19	Phantom uncertainty	B	1.0	R	$\sqrt{3}$	1	1	0.6	0.6	∞
20	Liquid conductivity (target)	B	5.0	R	$\sqrt{3}$	0.64	0.43	1.8	1.2	∞
21	Liquid conductivity (meas.)	A	1.3	N	1	0.64	0.43	0.83	0.56	43
22	Liquid permittivity (target)	B	5.0	R	$\sqrt{3}$	0.6	0.49	1.7	1.4	∞
23	Liquid permittivity (meas.)	A	1.6	N	1	0.6	0.49	0.96	0.78	521
Combined standard uncertainty		$u_c = \sqrt{\sum_{i=1}^{22} c_i^2 u_i^2}$						11.6	11.5	257
Expanded uncertainty (Confidence interval of 95 %)		$u_e = 2u_c$						23.2	23.0	

## 16. Main Test Instruments

**Table 16.1: List of Main Instruments**

No.	Name	Type	Serial Number	Calibration Date	Valid Period
01	Network analyzer	E5071C	MY46103759	2021-11-15	One year
02	Dielectric probe	85070E	MY44300317	/	/
03	Power meter	E4418B	MY50000366	2021-12-12	One year
04	Power sensor	E9304A	MY50000188	2021-12-12	One year
05	Power meter	NRP	101260	2021-12-30	One year
06	Power sensor	NRP-Z91	102211	2021-12-30	One year
07	Signal Generator	E8257D	MY47461211	2022-01-14	One year
08	Amplifier	VTL5400	0404	/	/
09	DAE	DAE4	1527	2022-06-21	One year
10	E-field Probe	EX3DV4	7621	2022-05-06	One year
11	Dipole Validation Kit	D750V3	1163	2022-08-22	Three years
12	Dipole Validation Kit	D835V2	4d057	2021-10-18	Three years
13	Dipole Validation Kit	D1750V2	1152	2022-08-22	Three years
14	Dipole Validation Kit	D1900V2	5d088	2021-10-18	Three years
15	Dipole Validation Kit	D2450V2	873	2021-10-21	Three years
16	Dipole Validation Kit	D2550V2	1010	2021-05-21	Three years
17	Dipole Validation Kit	D5GHzV2	1238	2022-08-17	Three years
18	BTS	E5515C	GB46110722	2022-01-14	One year
19	BTS	MT8820C	6201341853	2022-01-14	One year
20	BTS	CMW500	152499	2022-07-15	One year
21	Software	DASY5	/	/	/

## ANNEX A: Graph Results

### GSM850 Head

Date: 2022-9-9

Electronics: DAE4 Sn1527

Medium: Head 835MHz

Medium parameters used (interpolated):  $f = 836.6$  MHz;  $\sigma = 0.919$  S/m;  $\epsilon_r = 40.583$ ;  $\rho = 1000$  kg/m<sup>3</sup>

Communication System: UID 0, GSM (0) Frequency: 836.6 MHz Duty Cycle: 1:8.3

Probe: EX3DV4 - SN7621 ConvF (11.12, 11.12, 11.12)

**Left Cheek Middle/Area Scan (61x61x1):** Interpolated grid:  $dx=1.500$  mm,  $dy=1.500$  mm

Maximum value of SAR (interpolated) = 0.268 W/kg

**Left Cheek Middle/Zoom Scan (5x5x7)/Cube 0:** Measurement grid:  $dx=8$ mm,  $dy=8$ mm,  $dz=5$ mm

Reference Value = 3.522 V/m; Power Drift = 0.05 dB

Peak SAR (extrapolated) = 0.296 W/kg

**SAR(1 g) = 0.228 W/kg; SAR(10 g) = 0.171 W/kg**

Maximum value of SAR (measured) = 0.265 W/kg

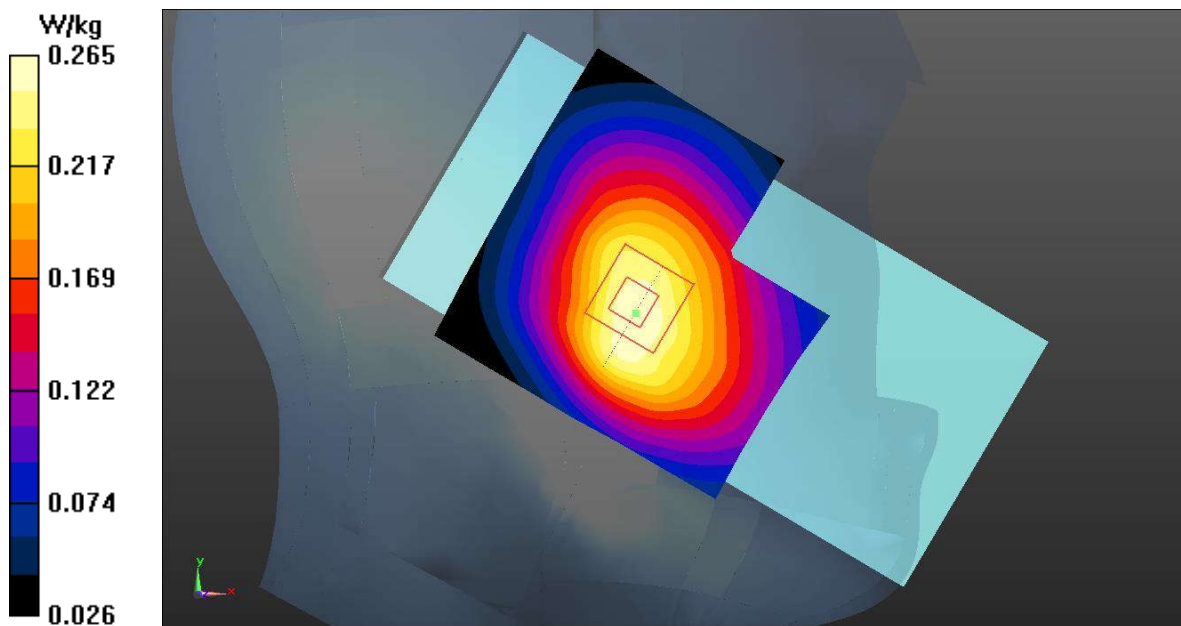

Fig.1 GSM850 Head

**GSM850 Body**

Date: 2022-9-9

Electronics: DAE4 Sn1527

Medium: Head 835MHz

Medium parameters used (interpolated):  $f = 836.6$  MHz;  $\sigma = 0.919$  S/m;  $\epsilon_r = 40.583$ ;  $\rho = 1000$  kg/m<sup>3</sup>

Communication System: UID 0, 2 slot GPRS (0) Frequency: 836.6 MHz Duty Cycle: 1:4

Probe: EX3DV4 - SN7621 ConvF (11.12, 11.12, 11.12)

**Rear Side Middle/Area Scan (61x111x1):** Interpolated grid: dx=1.500 mm, dy=1.500 mm

Maximum value of SAR (interpolated) = 0.361 W/kg

**Rear Side Middle/Zoom Scan (5x5x7)/Cube 0:** Measurement grid: dx=8mm, dy=8mm, dz=5mm

Reference Value = 17.87 V/m; Power Drift = -0.03 dB

Peak SAR (extrapolated) = 0.396 W/kg

**SAR(1 g) = 0.309 W/kg; SAR(10 g) = 0.233 W/kg**

Maximum value of SAR (measured) = 0.357 W/kg

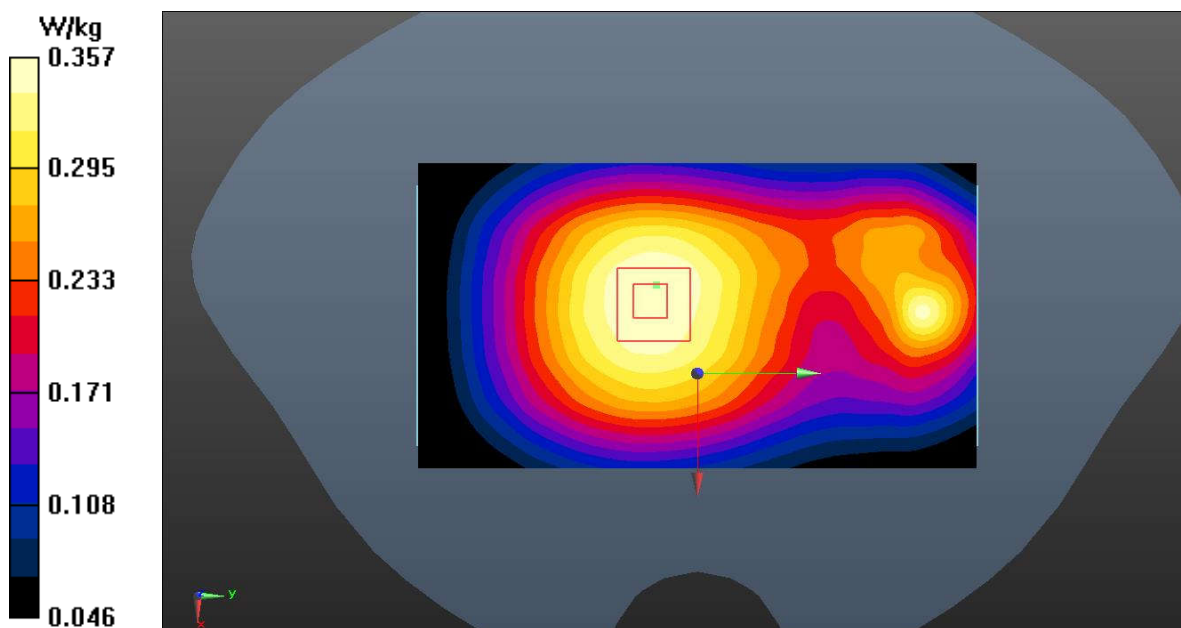

Fig.2 GSM850 Body

**GSM1900 Head**

Date: 2022-9-1

Electronics: DAE4 Sn1527

Medium: Head 1900MHz

Medium parameters used:  $f = 1880$  MHz;  $\sigma = 1.367$  S/m;  $\epsilon_r = 40.445$ ;  $\rho = 1000$  kg/m<sup>3</sup>

Communication System: UID 0, GSM (0) Frequency: 1880 MHz Duty Cycle: 1:8.3

Probe: EX3DV4 - SN7621 ConvF (8.90, 8.90, 8.90)

**Right Cheek Middle/Area Scan (61x61x1):** Interpolated grid:  $dx=1.500$  mm,  $dy=1.500$  mm  
Maximum value of SAR (interpolated) = 0.370 W/kg**Right Cheek Middle/Zoom Scan (5x5x7)/Cube 0:** Measurement grid:  $dx=8$ mm,  $dy=8$ mm,  $dz=5$ mm

Reference Value = 6.544 V/m; Power Drift = 0.04 dB

Peak SAR (extrapolated) = 0.453 W/kg

**SAR(1 g) = 0.259 W/kg; SAR(10 g) = 0.142 W/kg**

Maximum value of SAR (measured) = 0.352 W/kg

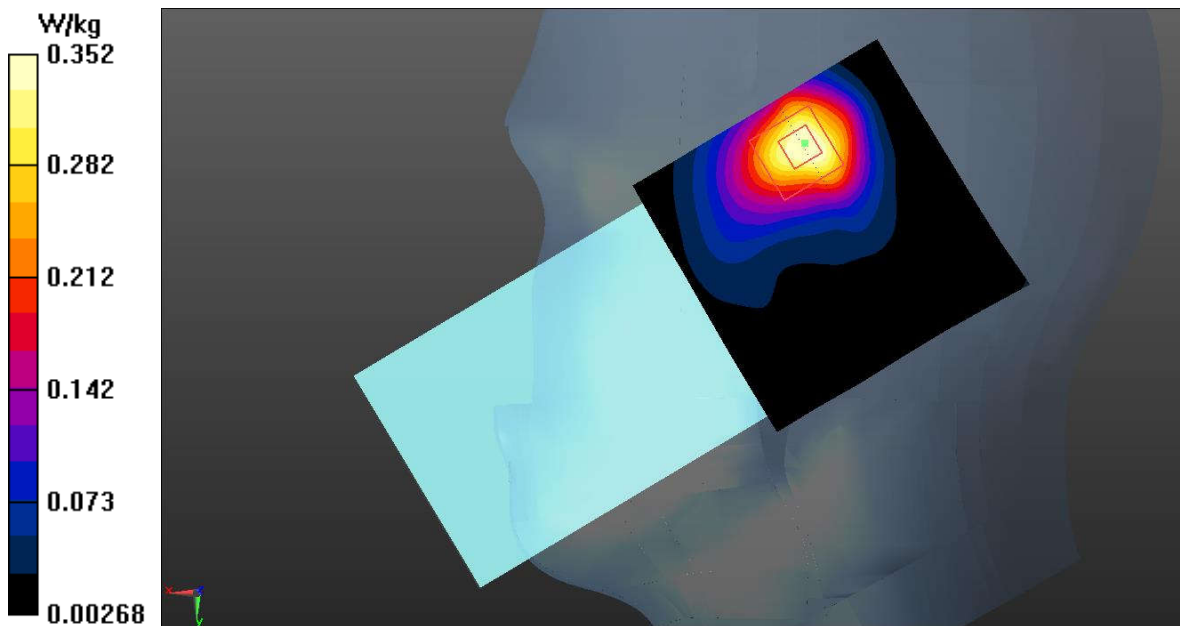

Fig.3 GSM1900 Head



**GSM1900 Body**

Date: 2022-9-1

Electronics: DAE4 Sn1527

Medium: Head 1900MHz

Medium parameters used:  $f = 1880$  MHz;  $\sigma = 1.367$  S/m;  $\epsilon_r = 40.445$ ;  $\rho = 1000$  kg/m<sup>3</sup>

Communication System: UID 0, 2 slot GPRS (0) Frequency: 1880 MHz Duty Cycle: 1:4

Probe: EX3DV4 - SN7621 ConvF (8.90, 8.90, 8.90)

**Rear Side Middle/Area Scan (71x61x1):** Interpolated grid:  $dx=1.500$  mm,  $dy=1.500$  mm  
Maximum value of SAR (interpolated) = 0.153 W/kg**Rear Side Middle/Zoom Scan (5x5x7)/Cube 0:** Measurement grid:  $dx=8$ mm,  $dy=8$ mm,  $dz=5$ mm  
Reference Value = 5.273 V/m; Power Drift = -0.04 dB

Peak SAR (extrapolated) = 0.199 W/kg

**SAR(1 g) = 0.113 W/kg; SAR(10 g) = 0.064 W/kg**

Maximum value of SAR (measured) = 0.156 W/kg

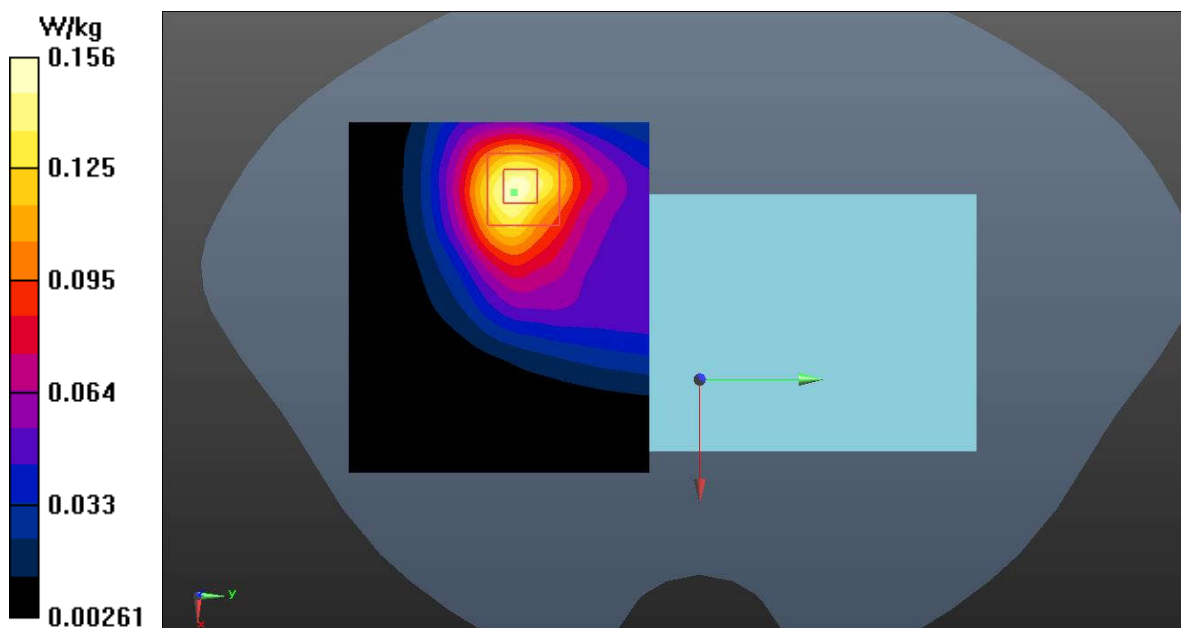

Fig.4 GSM1900 Body

**WCDMA Band 2 Head**

Date: 2022-9-1

Electronics: DAE4 Sn1527

Medium: Head 1900MHz

Medium parameters used:  $f = 1880$  MHz;  $\sigma = 1.367$  S/m;  $\epsilon_r = 40.445$ ;  $\rho = 1000$  kg/m<sup>3</sup>

Communication System: UID 0, WCDMA (0) Frequency: 1880 MHz Duty Cycle: 1:1

Probe: EX3DV4 - SN7621 ConvF (8.90, 8.90, 8.90)

**Right Cheek Middle/Area Scan (61x61x1):** Interpolated grid: dx=1.500 mm, dy=1.500 mm  
Maximum value of SAR (interpolated) = 1.06 W/kg**Right Cheek Middle/Zoom Scan (5x5x7)/Cube 0:** Measurement grid: dx=8mm, dy=8mm, dz=5mm

Reference Value = 12.33 V/m; Power Drift = -0.06 dB

Peak SAR (extrapolated) = 1.24 W/kg

**SAR(1 g) = 0.718 W/kg; SAR(10 g) = 0.391 W/kg**

Maximum value of SAR (measured) = 0.973 W/kg

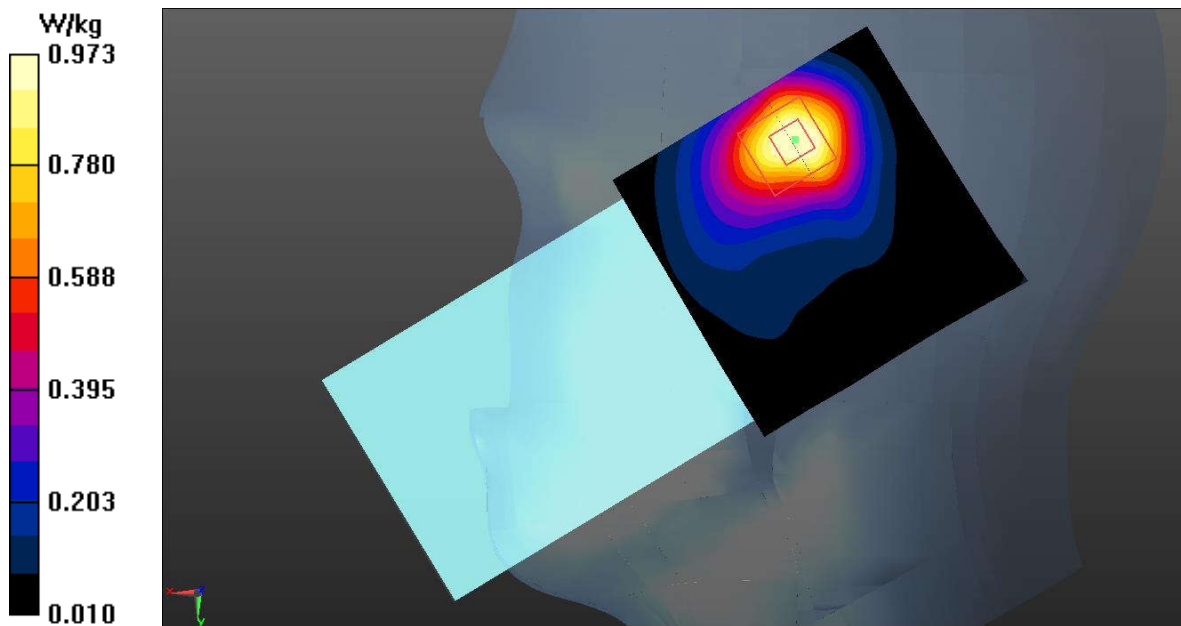

Fig.5 WCDMA Band 2 Head

**WCDMA Band 2 Body**

Date: 2022-9-1

Electronics: DAE4 Sn1527

Medium: Head 1900MHz

Medium parameters used:  $f = 1880$  MHz;  $\sigma = 1.367$  S/m;  $\epsilon_r = 40.445$ ;  $\rho = 1000$  kg/m<sup>3</sup>

Communication System: UID 0, WCDMA (0) Frequency: 1880 MHz Duty Cycle: 1:1

Probe: EX3DV4 - SN7621 ConvF (8.90, 8.90, 8.90)

**Rear Side Middle/Area Scan (61x61x1):** Interpolated grid:  $dx=1.500$  mm,  $dy=1.500$  mm  
Maximum value of SAR (interpolated) = 0.325 W/kg**Rear Side Middle/Zoom Scan (5x5x7)/Cube 0:** Measurement grid:  $dx=8$ mm,  $dy=8$ mm,  $dz=5$ mm  
Reference Value = 6.985 V/m; Power Drift = 0.04 dB

Peak SAR (extrapolated) = 0.399 W/kg

**SAR(1 g) = 0.224 W/kg; SAR(10 g) = 0.127 W/kg**

Maximum value of SAR (measured) = 0.303 W/kg

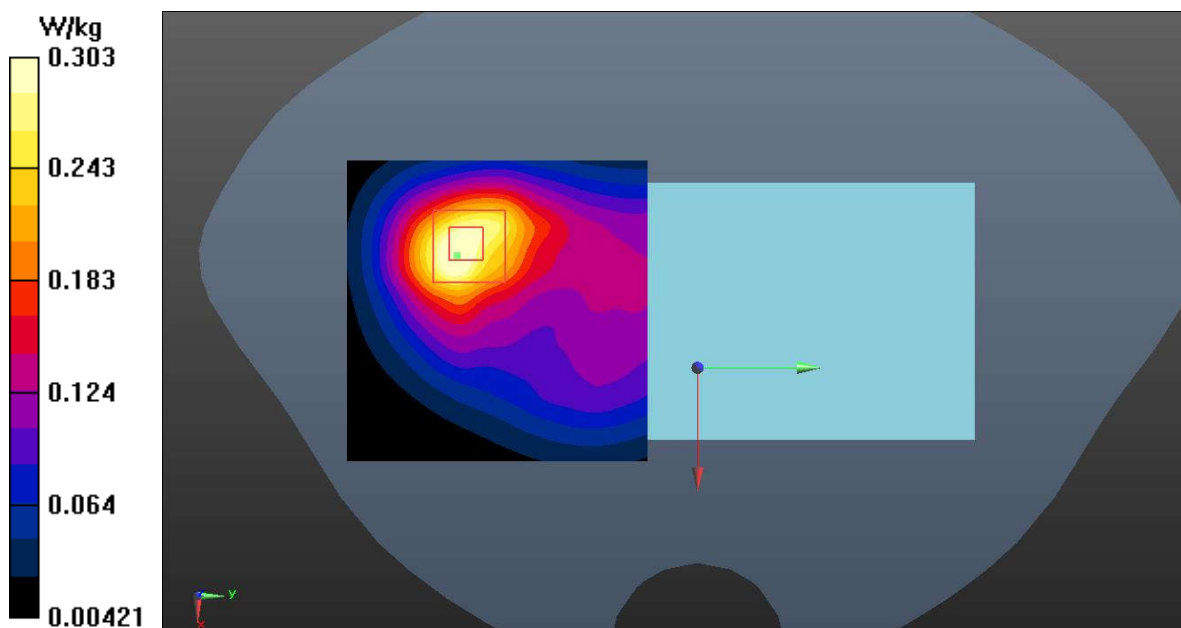

Fig.6 WCDMA Band 2 Body

**WCDMA Band 4 Head**

Date: 2022-9-2

Electronics: DAE4 Sn1527

Medium: Head 1750MHz

Medium parameters used:  $f = 1733$  MHz;  $\sigma = 1.348$  S/m;  $\epsilon_r = 40.619$ ;  $\rho = 1000$  kg/m<sup>3</sup>

Communication System: UID 0, WCDMA (0) Frequency: 1732.6 MHz Duty Cycle: 1:1

Probe: EX3DV4 - SN7621 ConvF (9.22, 9.22, 9.22)

**Right Cheek Middle/Area Scan (61x61x1):** Interpolated grid:  $dx=1.500$  mm,  $dy=1.500$  mm  
Maximum value of SAR (interpolated) = 0.250 W/kg**Right Cheek Middle/Zoom Scan (5x5x7)/Cube 0:** Measurement grid:  $dx=8$ mm,  $dy=8$ mm,  $dz=5$ mm

Reference Value = 5.634 V/m; Power Drift = 0.02 dB

Peak SAR (extrapolated) = 0.315 W/kg

**SAR(1 g) = 0.168 W/kg; SAR(10 g) = 0.092 W/kg**

Maximum value of SAR (measured) = 0.227 W/kg

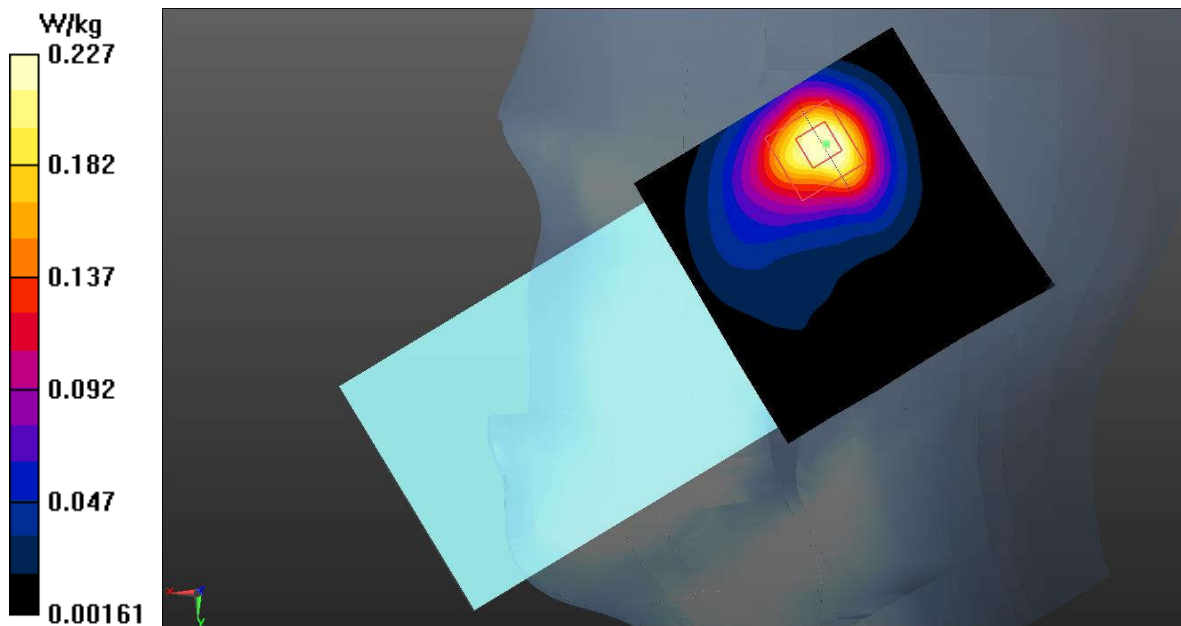

Fig.7 WCDMA Band 4 Head

**WCDMA Band 4 Body**

Date: 2022-9-2

Electronics: DAE4 Sn1527

Medium: Head 1750MHz

Medium parameters used:  $f = 1733$  MHz;  $\sigma = 1.348$  S/m;  $\epsilon_r = 40.619$ ;  $\rho = 1000$  kg/m<sup>3</sup>

Communication System: UID 0, WCDMA (0) Frequency: 1732.6 MHz Duty Cycle: 1:1

Probe: EX3DV4 - SN7621 ConvF (9.22, 9.22, 9.22)

**Rear Side Middle/Area Scan (61x61x1):** Interpolated grid: dx=1.500 mm, dy=1.500 mm  
Maximum value of SAR (interpolated) = 0.0542 W/kg**Rear Side Middle/Zoom Scan (5x5x7)/Cube 0:** Measurement grid: dx=8mm, dy=8mm, dz=5mm  
Reference Value = 3.419 V/m; Power Drift = 0.18 dB

Peak SAR (extrapolated) = 0.0750 W/kg

**SAR(1 g) = 0.040 W/kg; SAR(10 g) = 0.022 W/kg**

Maximum value of SAR (measured) = 0.0561 W/kg

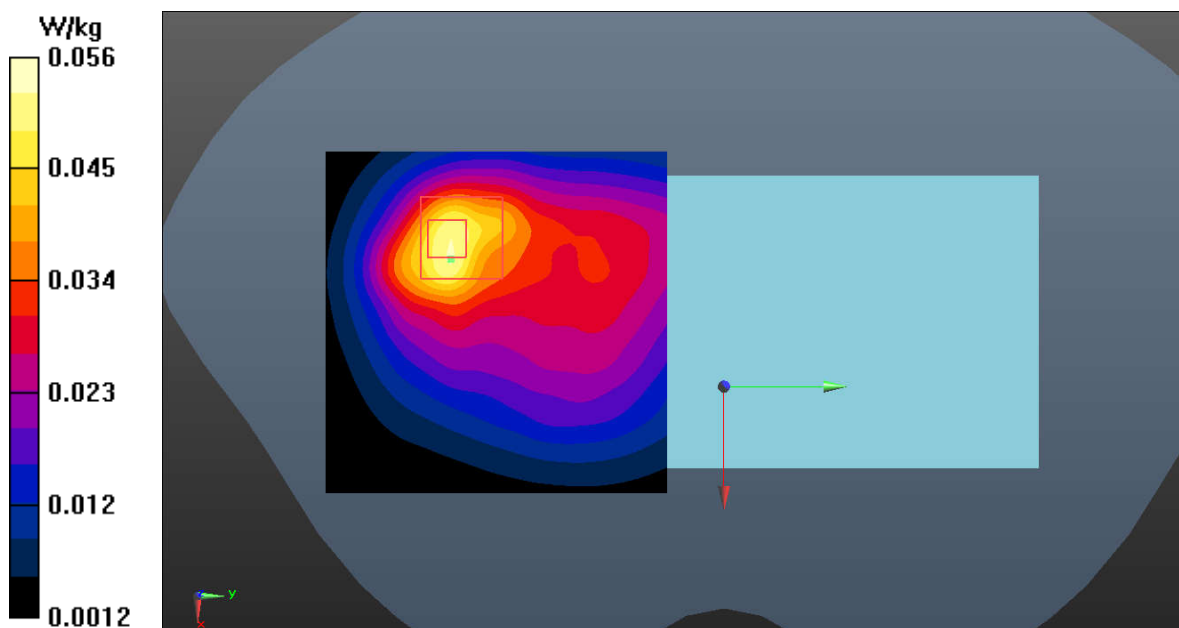

Fig.8 WCDMA Band 4 Body

**WCDMA Band 5 Head**

Date: 2022-9-9

Electronics: DAE4 Sn1527

Medium: Head 835MHz

Medium parameters used (interpolated):  $f = 836.6$  MHz;  $\sigma = 0.919$  S/m;  $\epsilon_r = 40.583$ ;  $\rho = 1000$  kg/m<sup>3</sup>

Communication System: UID 0, WCDMA (0) Frequency: 836.6 MHz Duty Cycle: 1:1

Probe: EX3DV4 - SN7621 ConvF (11.12, 11.12, 11.12)

**Right Cheek Middle/Area Scan (61x61x1):** Interpolated grid:  $dx=1.500$  mm,  $dy=1.500$  mm  
Maximum value of SAR (interpolated) = 0.189 W/kg**Right Cheek Middle/Zoom Scan (5x5x7)/Cube 0:** Measurement grid:  $dx=8$ mm,  $dy=8$ mm,  $dz=5$ mm

Reference Value = 3.532 V/m; Power Drift = 0.06 dB

Peak SAR (extrapolated) = 0.204 W/kg

**SAR(1 g) = 0.163 W/kg; SAR(10 g) = 0.126 W/kg**

Maximum value of SAR (measured) = 0.185 W/kg

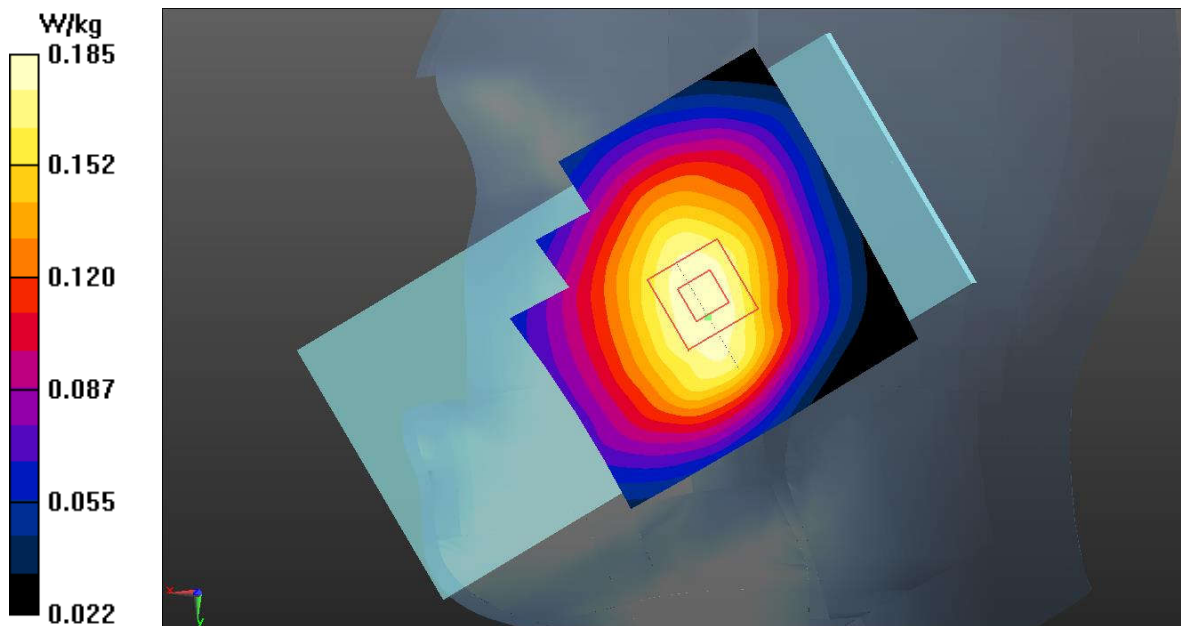

Fig.9 WCDMA Band 5 Head

**WCDMA Band 5 Body**

Date: 2022-9-9

Electronics: DAE4 Sn1527

Medium: Head 835MHz

Medium parameters used (interpolated):  $f = 836.6$  MHz;  $\sigma = 0.919$  S/m;  $\epsilon_r = 40.583$ ;  $\rho = 1000$  kg/m<sup>3</sup>

Communication System: UID 0, WCDMA (0) Frequency: 836.6 MHz Duty Cycle: 1:1

Probe: EX3DV4 - SN7621 ConvF (11.12, 11.12, 11.12)

**Rear Side Middle/Area Scan (61x111x1):** Interpolated grid: dx=1.500 mm, dy=1.500 mm

Maximum value of SAR (interpolated) = 0.221 W/kg

**Rear Side Middle/Zoom Scan (5x5x7)/Cube 0:** Measurement grid: dx=8mm, dy=8mm, dz=5mm

Reference Value = 14.06 V/m; Power Drift = 0.00 dB

Peak SAR (extrapolated) = 0.245 W/kg

**SAR(1 g) = 0.192 W/kg; SAR(10 g) = 0.144 W/kg**

Maximum value of SAR (measured) = 0.222 W/kg

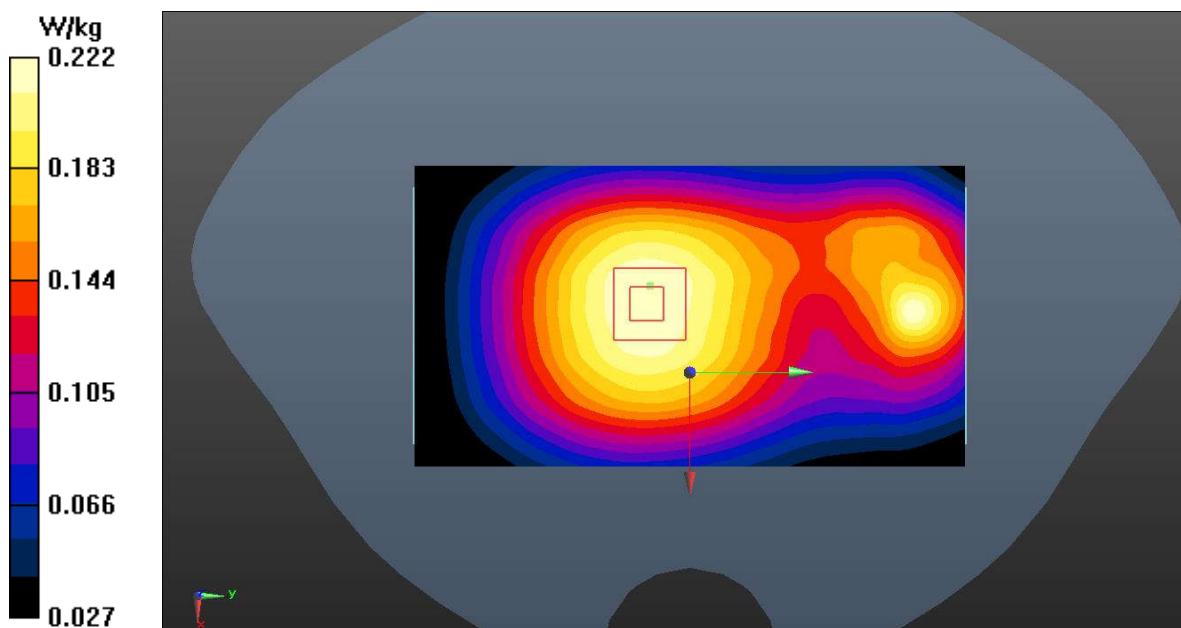

Fig.10 WCDMA Band 5 Body

**LTE Band 2 Head**

Date: 2022-9-1

Electronics: DAE4 Sn1527

Medium: Head 1900MHz

Medium parameters used:  $f = 1880$  MHz;  $\sigma = 1.367$  S/m;  $\epsilon_r = 40.445$ ;  $\rho = 1000$  kg/m<sup>3</sup>

Communication System: UID 0, LTE\_FDD (0) Frequency: 1880 MHz Duty Cycle: 1:1

Probe: EX3DV4 - SN7621 ConvF (8.90, 8.90, 8.90)

**Right Cheek Middle 50RB25/Area Scan (61x61x1):** Interpolated grid: dx=1.500 mm, dy=1.500 mm

Maximum value of SAR (interpolated) = 0.746 W/kg

**Right Cheek Middle 50RB25/Zoom Scan (5x5x7)/Cube 0:** Measurement grid: dx=8mm, dy=8mm, dz=5mm

Reference Value = 9.295 V/m; Power Drift = -0.04 dB

Peak SAR (extrapolated) = 0.902 W/kg

**SAR(1 g) = 0.538 W/kg; SAR(10 g) = 0.297 W/kg**

Maximum value of SAR (measured) = 0.733 W/kg

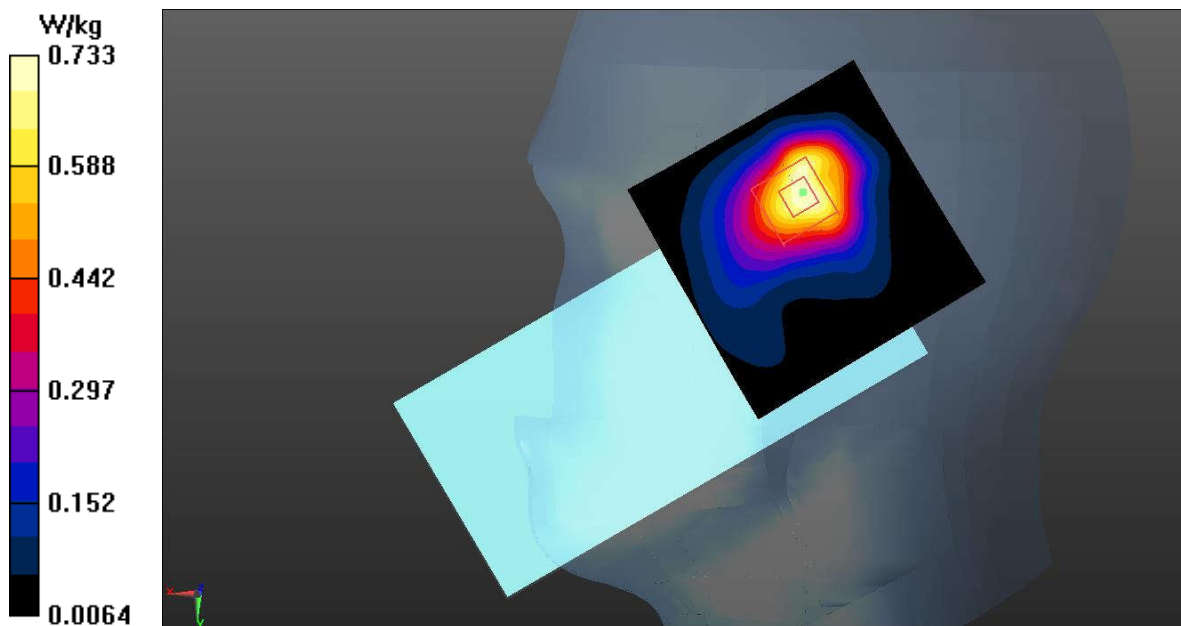

Fig.11 LTE Band 2 Head



**LTE Band 2 Body**

Date: 2022-9-1

Electronics: DAE4 Sn1527

Medium: Head 1900MHz

Medium parameters used:  $f = 1880$  MHz;  $\sigma = 1.367$  S/m;  $\epsilon_r = 40.445$ ;  $\rho = 1000$  kg/m<sup>3</sup>

Communication System: UID 0, LTE\_FDD (0) Frequency: 1880 MHz Duty Cycle: 1:1

Probe: EX3DV4 - SN7621 ConvF (8.90, 8.90, 8.90)

**Rear Side Middle 50RB25/Area Scan (61x61x1):** Interpolated grid: dx=1.500 mm, dy=1.500 mm  
Maximum value of SAR (interpolated) = 0.314 W/kg**Rear Side Middle 50RB25/Zoom Scan (5x5x7)/Cube 0:** Measurement grid: dx=8mm, dy=8mm, dz=5mm

Reference Value = 6.662 V/m; Power Drift = -0.05 dB

Peak SAR (extrapolated) = 0.405 W/kg

**SAR(1 g) = 0.225 W/kg; SAR(10 g) = 0.125 W/kg**

Maximum value of SAR (measured) = 0.312 W/kg

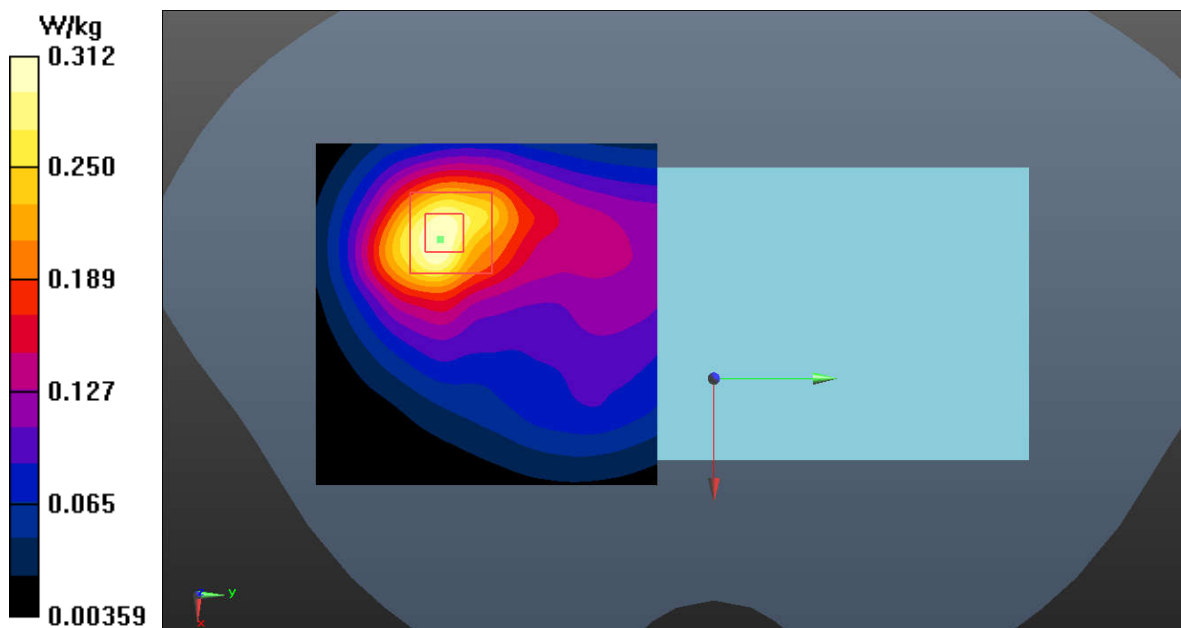
**Fig.12 LTE Band 2 Body**

**LTE Band 4 Head**

Date: 2022-9-2

Electronics: DAE4 Sn1527

Medium: Head 1750MHz

Medium parameters used (interpolated):  $f = 1732.5$  MHz;  $\sigma = 1.348$  S/m;  $\epsilon_r = 40.621$ ;  $\rho = 1000$  kg/m<sup>3</sup>

Communication System: UID 0, LTE\_FDD (0) Frequency: 1732.5 MHz Duty Cycle: 1:1

Probe: EX3DV4 - SN7621 ConvF (9.22, 9.22, 9.22)

**Right Cheek Middle 50RB25/Area Scan (61x61x1):** Interpolated grid: dx=1.500 mm, dy=1.500 mm

Maximum value of SAR (interpolated) = 0.663 W/kg

**Right Cheek Middle 50RB25/Zoom Scan (5x5x7)/Cube 0:** Measurement grid: dx=8mm, dy=8mm, dz=5mm

Reference Value = 9.566 V/m; Power Drift = 0.05 dB

Peak SAR (extrapolated) = 0.821 W/kg

**SAR(1 g) = 0.465 W/kg; SAR(10 g) = 0.258 W/kg**

Maximum value of SAR (measured) = 0.629 W/kg

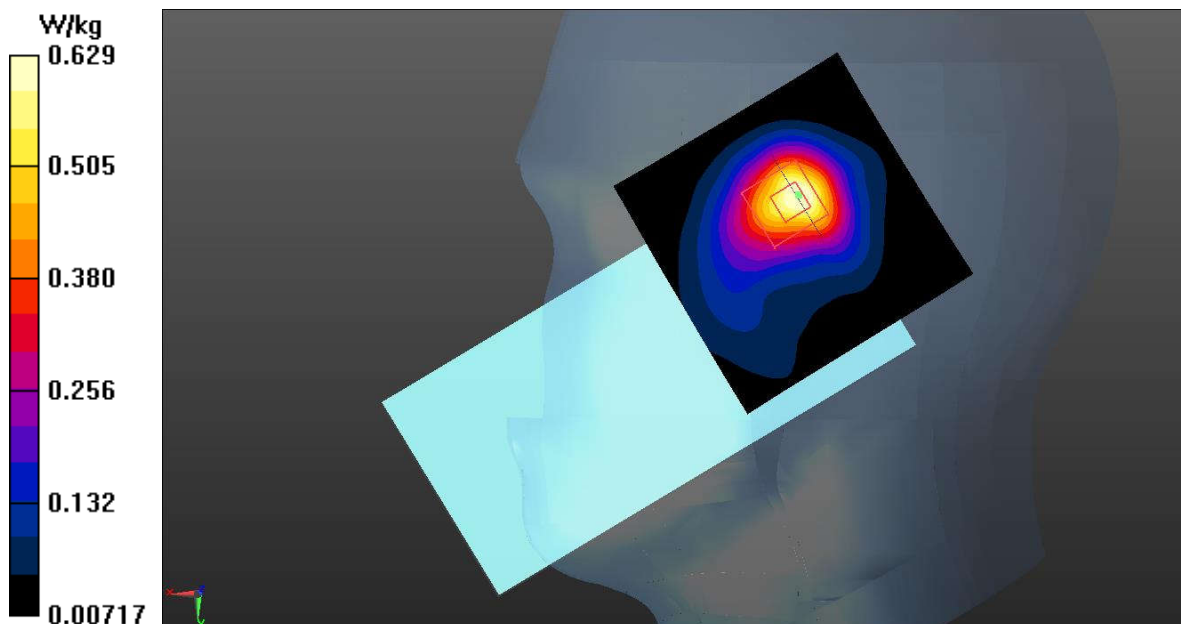
**Fig.13 LTE Band 4 Head**

**LTE Band 4 Body**

Date: 2022-9-2

Electronics: DAE4 Sn1527

Medium: Head 1750MHz

Medium parameters used (interpolated):  $f = 1732.5$  MHz;  $\sigma = 1.348$  S/m;  $\epsilon_r = 40.621$ ;  $\rho = 1000$  kg/m<sup>3</sup>

Communication System: UID 0, LTE\_FDD (0) Frequency: 1732.5 MHz Duty Cycle: 1:1

Probe: EX3DV4 - SN7621 ConvF (9.22, 9.22, 9.22)

**Rear Side Middle 50RB25/Area Scan (61x61x1):** Interpolated grid: dx=1.500 mm, dy=1.500 mm

Maximum value of SAR (interpolated) = 0.227 W/kg

**Rear Side Middle 50RB25/Zoom Scan (5x5x7)/Cube 0:** Measurement grid: dx=8mm, dy=8mm, dz=5mm

Reference Value = 5.028 V/m; Power Drift = 0.04 dB

Peak SAR (extrapolated) = 0.323 W/kg

**SAR(1 g) = 0.175 W/kg; SAR(10 g) = 0.099 W/kg**

Maximum value of SAR (measured) = 0.241 W/kg

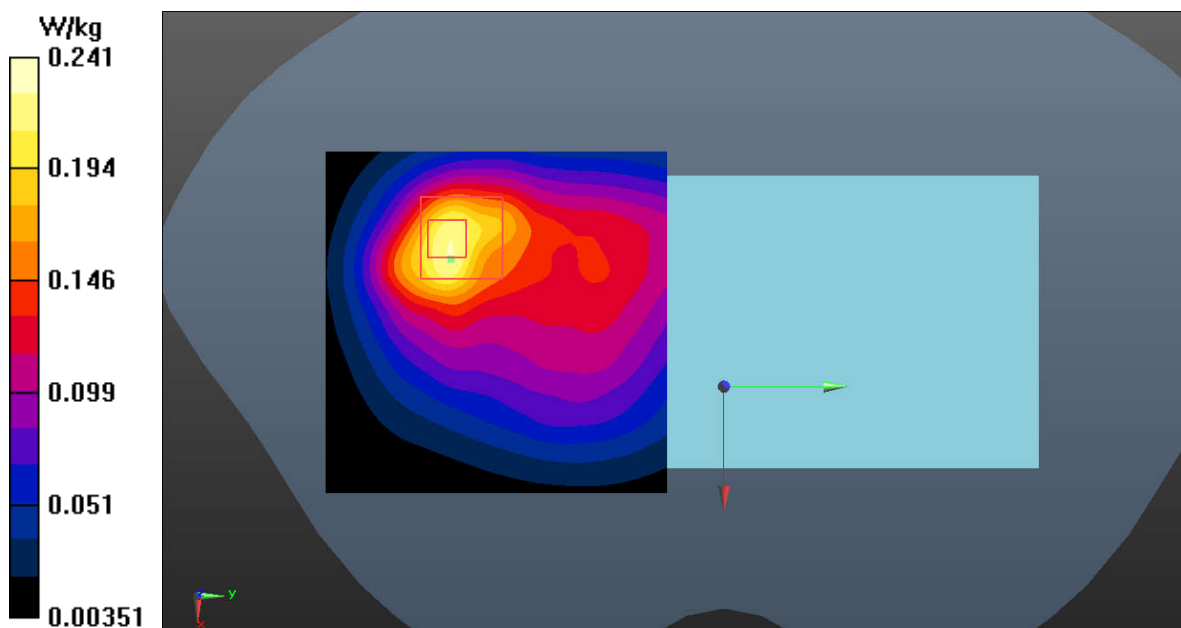
**Fig.14 LTE Band 4 Body**

**LTE Band 5 Head**

Date: 2022-9-9

Electronics: DAE4 Sn1527

Medium: Head 835MHz

Medium parameters used:  $f = 844$  MHz;  $\sigma = 0.926$  S/m;  $\epsilon_r = 40.494$ ;  $\rho = 1000$  kg/m<sup>3</sup>

Communication System: UID 0, LTE\_FDD (0) Frequency: 844 MHz Duty Cycle: 1:1

Probe: EX3DV4 - SN7621 ConvF (11.12, 11.12, 11.12)

**Left Cheek High 1RB49/Area Scan (61x61x1):** Interpolated grid: dx=1.500 mm, dy=1.500 mm  
Maximum value of SAR (interpolated) = 0.210 W/kg**Left Cheek High 1RB49/Zoom Scan (5x5x7)/Cube 0:** Measurement grid: dx=8mm, dy=8mm, dz=5mm

Reference Value = 3.586 V/m; Power Drift = 0.07 dB

Peak SAR (extrapolated) = 0.234 W/kg

**SAR(1 g) = 0.181 W/kg; SAR(10 g) = 0.137 W/kg**

Maximum value of SAR (measured) = 0.208 W/kg

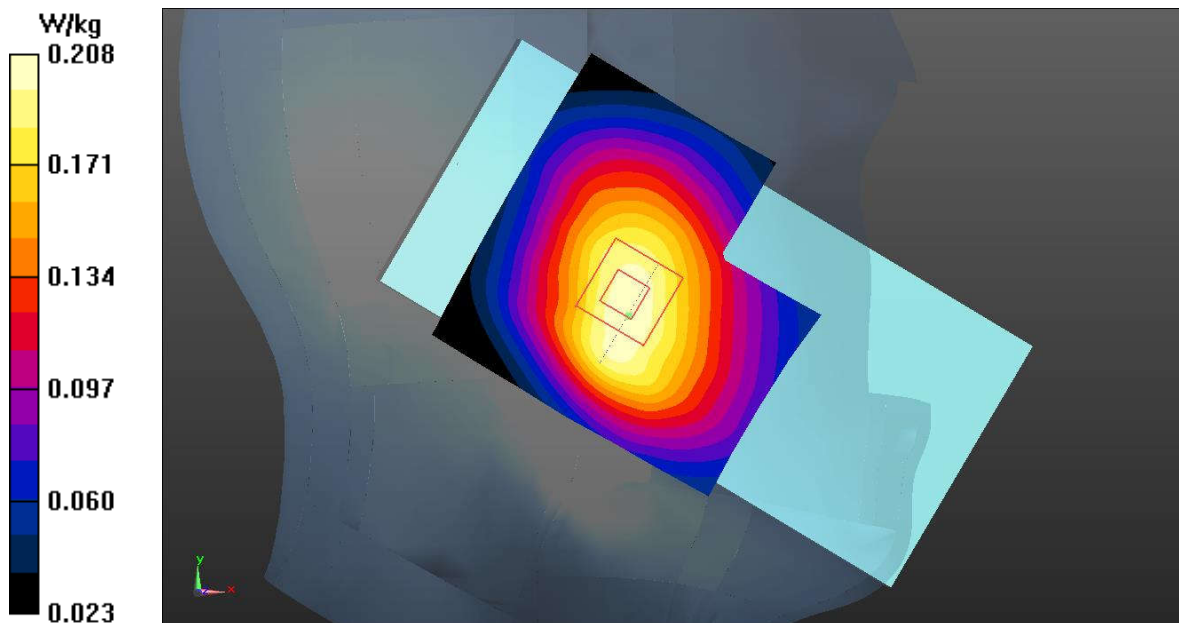
**Fig.15 LTE Band 5 Head**

**LTE Band 5 Body**

Date: 2022-9-9

Electronics: DAE4 Sn1527

Medium: Head 835MHz

Medium parameters used:  $f = 844$  MHz;  $\sigma = 0.926$  S/m;  $\epsilon_r = 40.494$ ;  $\rho = 1000$  kg/m<sup>3</sup>

Communication System: UID 0, LTE\_FDD (0) Frequency: 844 MHz Duty Cycle: 1:1

Probe: EX3DV4 - SN7621 ConvF (11.12, 11.12, 11.12)

**Rear Side High 1RB49/Area Scan (71x91x1):** Interpolated grid: dx=1.500 mm, dy=1.500 mm  
Maximum value of SAR (interpolated) = 0.271 W/kg**Rear Side High 1RB49/Zoom Scan (5x5x7)/Cube 0:** Measurement grid: dx=8mm, dy=8mm, dz=5mm

Reference Value = 14.58 V/m; Power Drift = 0.11 dB

Peak SAR (extrapolated) = 0.298 W/kg

**SAR(1 g) = 0.231 W/kg; SAR(10 g) = 0.174 W/kg**

Maximum value of SAR (measured) = 0.255 W/kg

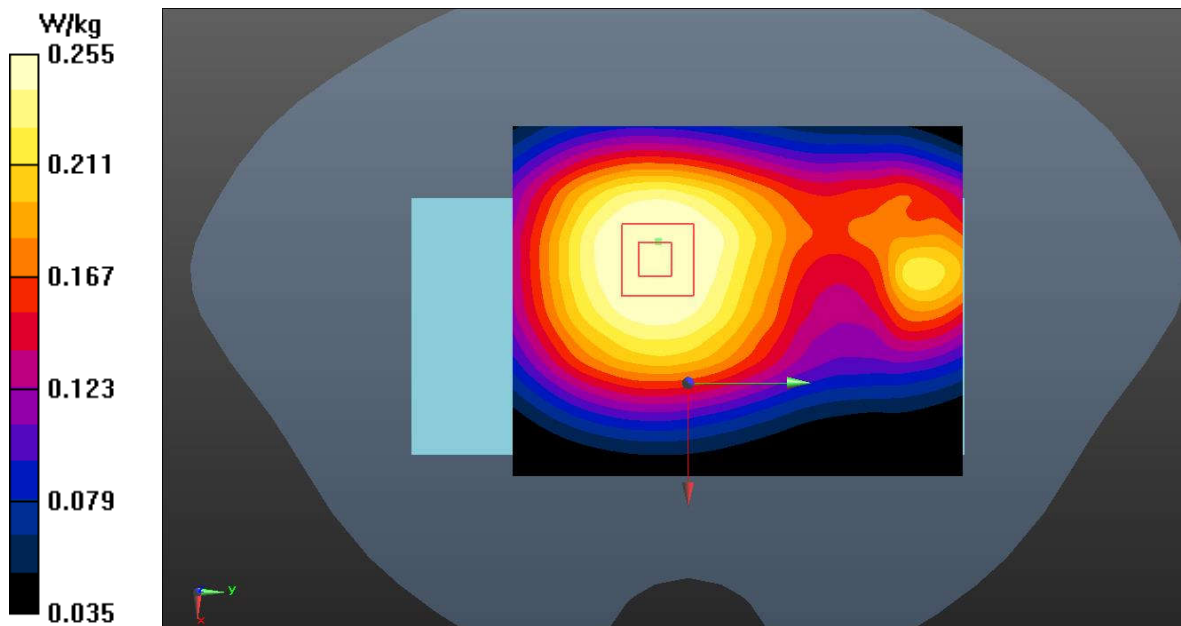
**Fig.16 LTE Band 5 Body**

**LTE Band 7 Head**

Date: 2022-9-30

Electronics: DAE4 Sn1527

Medium: Head 2550MHz

Medium parameters used (interpolated):  $f = 2535$  MHz;  $\sigma = 1.928$  S/m;  $\epsilon_r = 38.234$ ;  $\rho = 1000$  kg/m<sup>3</sup>

Communication System: UID 0, LTE\_FDD (0) Frequency: 2535 MHz Duty Cycle: 1:1

Probe: EX3DV4 - SN7621 ConvF (8.17, 8.17, 8.17)

**Right Tilt Middle 1RB99/Area Scan (91x91x1):** Interpolated grid: dx=1.000 mm, dy=1.000 mm  
Maximum value of SAR (interpolated) = 1.29 W/kg**Right Tilt Middle 1RB99/Zoom Scan (7x7x7)/Cube 0:** Measurement grid: dx=5mm, dy=5mm, dz=5mm

Reference Value = 5.364 V/m; Power Drift = 0.08 dB

Peak SAR (extrapolated) = 1.92 W/kg

**SAR(1 g) = 0.759 W/kg; SAR(10 g) = 0.311 W/kg**

Maximum value of SAR (measured) = 1.27 W/kg

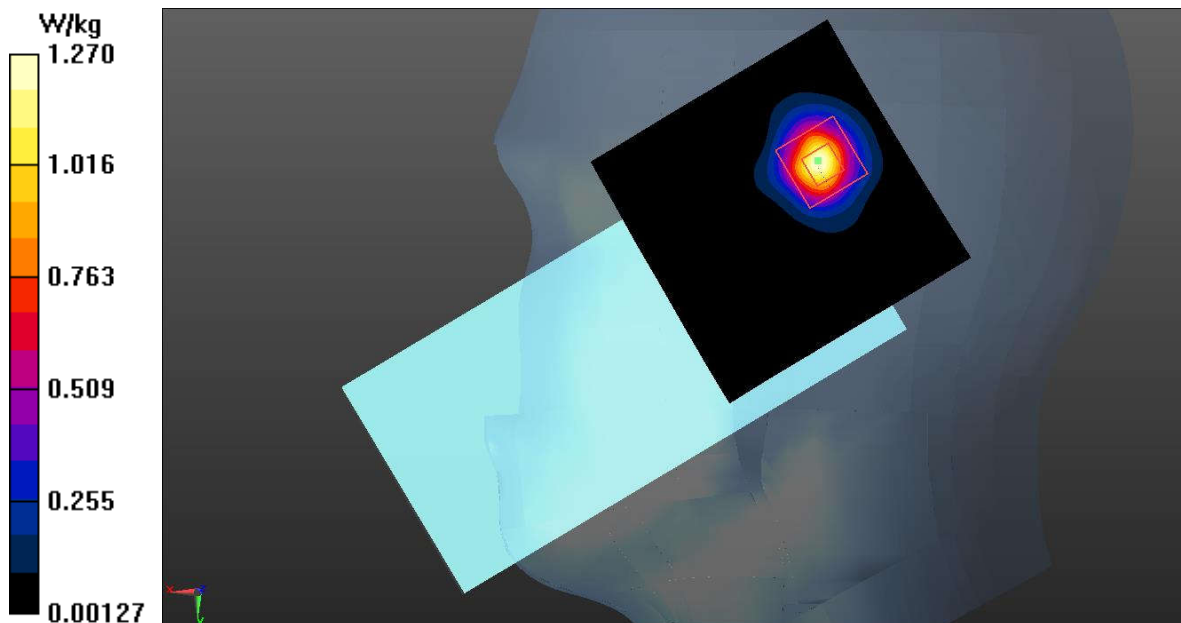

Fig.17 LTE Band 7 Head

**LTE Band 7 Body**

Date: 2022-9-30

Electronics: DAE4 Sn1527

Medium: Head 2550MHz

Medium parameters used:  $f = 2510$  MHz;  $\sigma = 1.899$  S/m;  $\epsilon_r = 38.316$ ;  $\rho = 1000$  kg/m<sup>3</sup>

Communication System: UID 0, LTE\_FDD (0) Frequency: 2510 MHz Duty Cycle: 1:1

Probe: EX3DV4 - SN7621 ConvF (8.17, 8.17, 8.17)

**Rear Side Low 1RB99/Area Scan (91x111x1):** Interpolated grid: dx=1.000 mm, dy=1.000 mm  
Maximum value of SAR (interpolated) = 0.307 W/kg**Rear Side Low 1RB99/Zoom Scan (7x7x7)/Cube 0:** Measurement grid: dx=5mm, dy=5mm, dz=5mm

Reference Value = 2.590 V/m; Power Drift = 0.04 dB

Peak SAR (extrapolated) = 0.457 W/kg

**SAR(1 g) = 0.275 W/kg; SAR(10 g) = 0.118 W/kg**

Maximum value of SAR (measured) = 0.316 W/kg

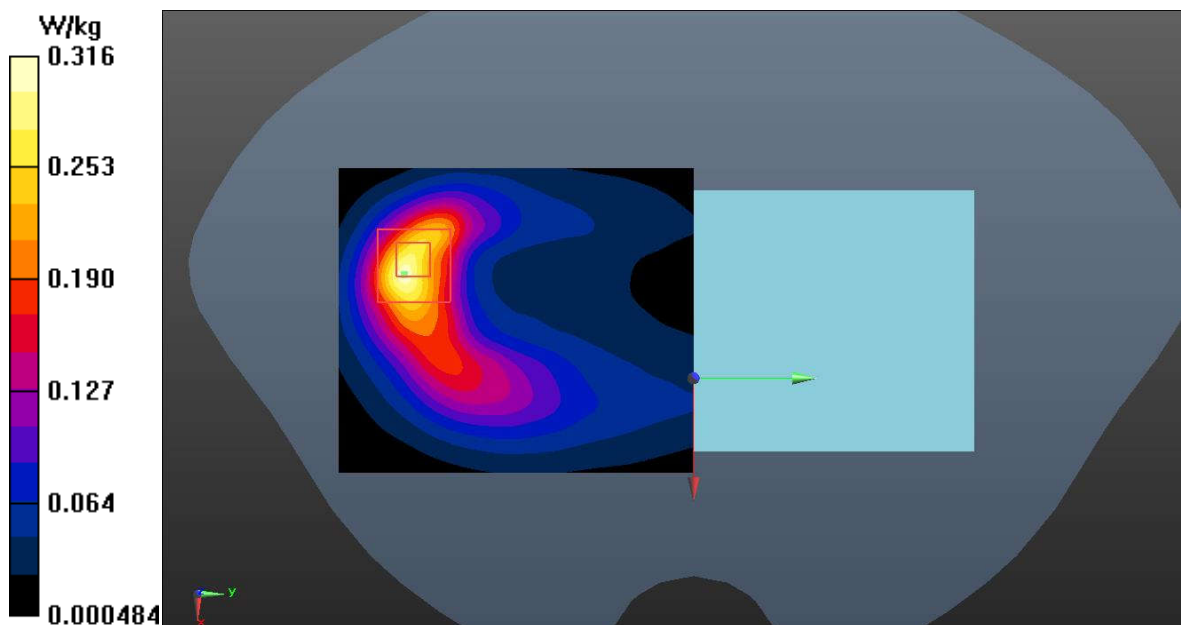

Fig.18 LTE Band 7 Body

**LTE Band 12 Head**

Date: 2022-9-10

Electronics: DAE4 Sn1527

Medium: Head 750MHz

Medium parameters used:  $f = 704$  MHz;  $\sigma = 0.875$  S/m;  $\epsilon_r = 41.434$ ;  $\rho = 1000$  kg/m<sup>3</sup>

Communication System: UID 0, LTE\_FDD (0) Frequency: 704 MHz Duty Cycle: 1:1

Probe: EX3DV4 - SN7621 ConvF (11.12, 11.12, 11.12)

**Left Cheek Low 1RB49/Area Scan (61x61x1):** Interpolated grid: dx=1.500 mm, dy=1.500 mm  
Maximum value of SAR (interpolated) = 0.200 W/kg**Left Cheek Low 1RB49/Zoom Scan (5x5x7)/Cube 0:** Measurement grid: dx=8mm, dy=8mm, dz=5mm

Reference Value = 4.211 V/m; Power Drift = 0.04 dB

Peak SAR (extrapolated) = 0.217 W/kg

**SAR(1 g) = 0.175 W/kg; SAR(10 g) = 0.137 W/kg**

Maximum value of SAR (measured) = 0.196 W/kg

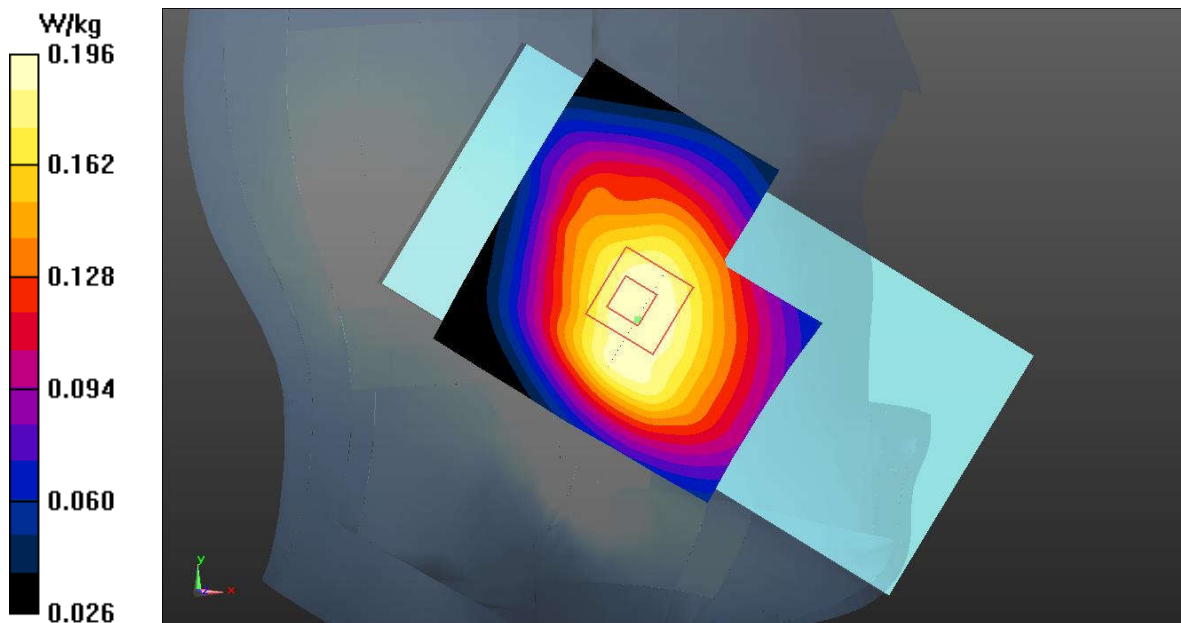
**Fig.19 LTE Band 12 Head**



**LTE Band 12 Body**

Date: 2022-9-10

Electronics: DAE4 Sn1527

Medium: Head 750MHz

Medium parameters used:  $f = 704$  MHz;  $\sigma = 0.875$  S/m;  $\epsilon_r = 41.434$ ;  $\rho = 1000$  kg/m<sup>3</sup>

Communication System: UID 0, LTE\_FDD (0) Frequency: 704 MHz Duty Cycle: 1:1

Probe: EX3DV4 - SN7621 ConvF (11.12, 11.12, 11.12)

**Rear Side Low 1RB49/Area Scan (71x91x1):** Interpolated grid: dx=1.500 mm, dy=1.500 mm  
Maximum value of SAR (interpolated) = 0.382 W/kg**Rear Side Low 1RB49/Zoom Scan (5x5x7)/Cube 0:** Measurement grid: dx=8mm, dy=8mm, dz=5mm

Reference Value = 13.80 V/m; Power Drift = 0.03 dB

Peak SAR (extrapolated) = 0.426 W/kg

**SAR(1 g) = 0.358 W/kg; SAR(10 g) = 0.258 W/kg**

Maximum value of SAR (measured) = 0.391 W/kg

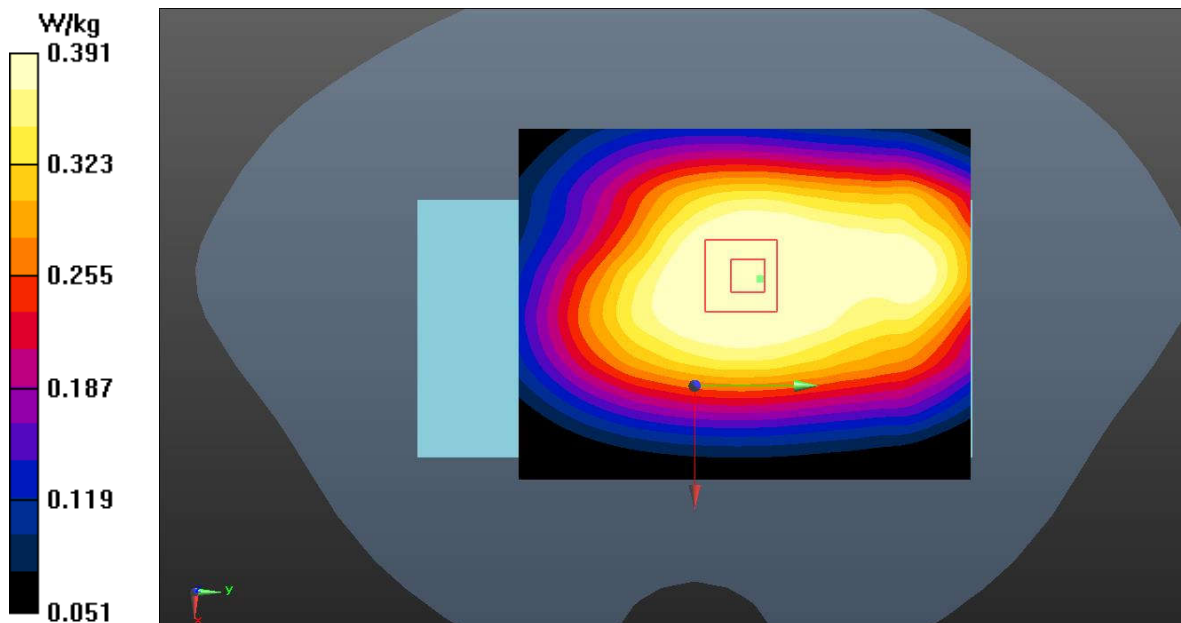

Fig.20 LTE Band 12 Body

**LTE Band 26 Head**

Date: 2022-9-9

Electronics: DAE4 Sn1527

Medium: Head 835MHz

Medium parameters used:  $f = 842$  MHz;  $\sigma = 0.924$  S/m;  $\epsilon_r = 40.518$ ;  $\rho = 1000$  kg/m<sup>3</sup>

Communication System: UID 0, LTE\_FDD (0) Frequency: 841.5 MHz Duty Cycle: 1:1

Probe: EX3DV4 - SN7621 ConvF (11.12, 11.12, 11.12)

**Left Cheek High 1RB74/Area Scan (61x61x1):** Interpolated grid: dx=1.500 mm, dy=1.500 mm  
Maximum value of SAR (interpolated) = 0.210 W/kg**Left Cheek High 1RB74/Zoom Scan (5x5x7)/Cube 0:** Measurement grid: dx=8mm, dy=8mm, dz=5mm

Reference Value = 3.661 V/m; Power Drift = 0.06 dB

Peak SAR (extrapolated) = 0.233 W/kg

**SAR(1 g) = 0.181 W/kg; SAR(10 g) = 0.138 W/kg**

Maximum value of SAR (measured) = 0.209 W/kg

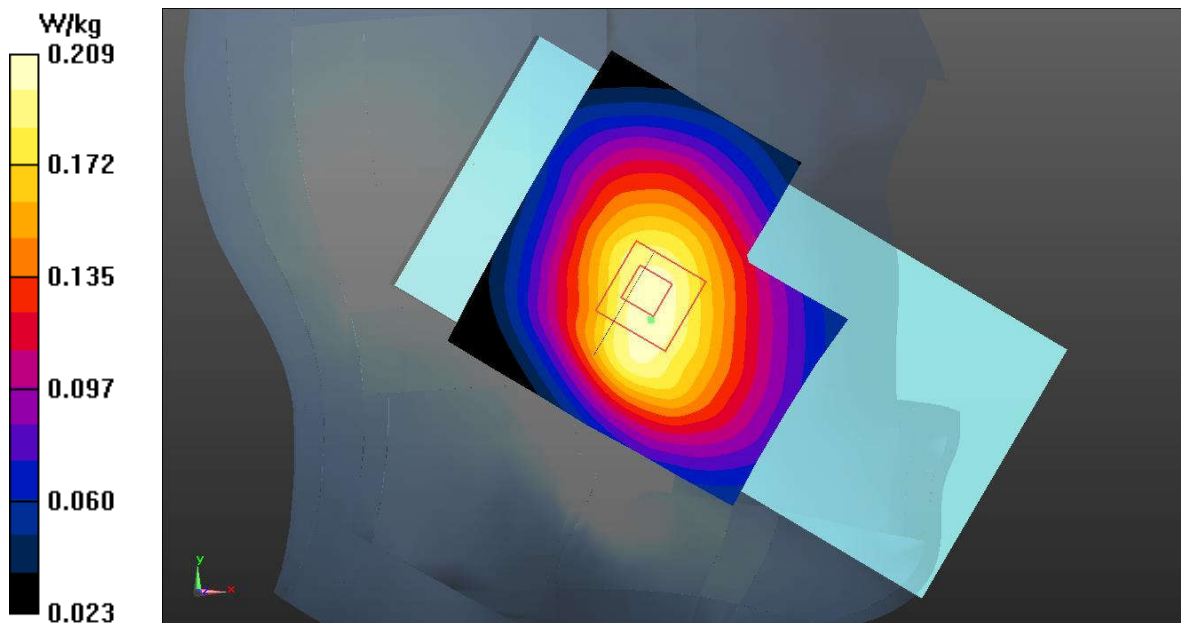
**Fig.21 LTE Band 26 Head**

**LTE Band 26 Body**

Date: 2022-9-9

Electronics: DAE4 Sn1527

Medium: Head 835MHz

Medium parameters used:  $f = 842$  MHz;  $\sigma = 0.924$  S/m;  $\epsilon_r = 40.518$ ;  $\rho = 1000$  kg/m<sup>3</sup>

Communication System: UID 0, LTE\_FDD (0) Frequency: 841.5 MHz Duty Cycle: 1:1

Probe: EX3DV4 - SN7621 ConvF (11.12, 11.12, 11.12)

**Rear Side High 1RB74/Area Scan (71x91x1):** Interpolated grid: dx=1.500 mm, dy=1.500 mm  
Maximum value of SAR (interpolated) = 0.290 W/kg**Rear Side High 1RB74/Zoom Scan (5x5x7)/Cube 0:** Measurement grid: dx=8mm, dy=8mm, dz=5mm

Reference Value = 14.86 V/m; Power Drift = 0.02 dB

Peak SAR (extrapolated) = 0.318 W/kg

**SAR(1 g) = 0.246 W/kg; SAR(10 g) = 0.185 W/kg**

Maximum value of SAR (measured) = 0.271 W/kg

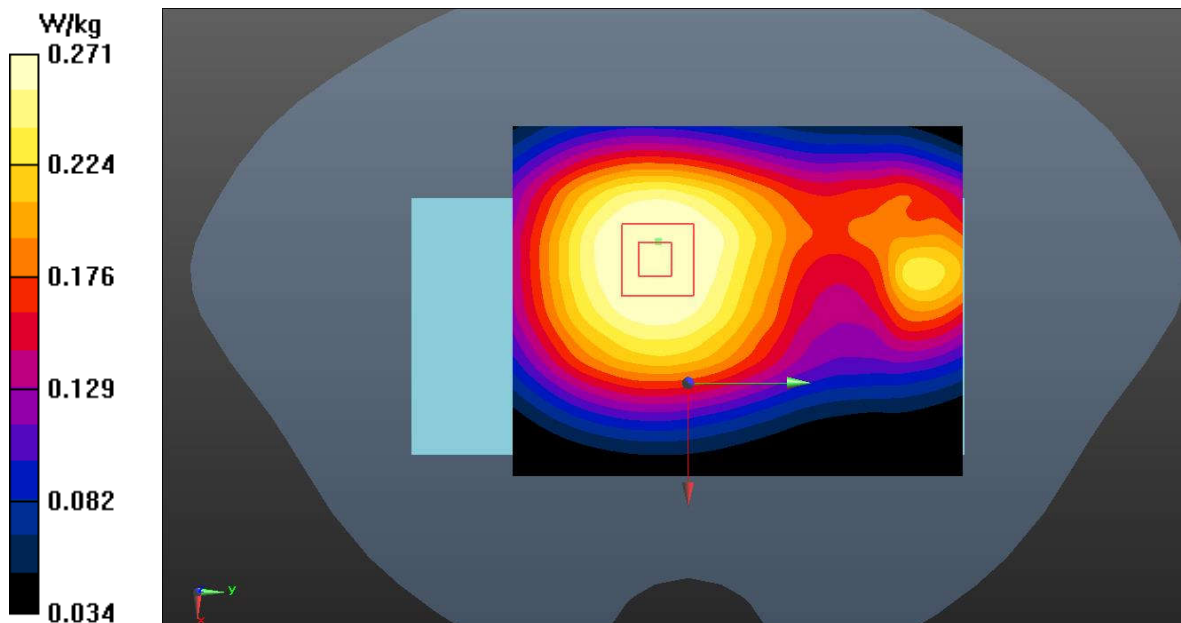

Fig.22 LTE Band 26 Body

**Bluetooth Head**

Date: 2022-9-27

Electronics: DAE4 Sn1527

Medium: Head 2450MHz

Medium parameters used:  $f = 2402$  MHz;  $\sigma = 1.775$  S/m;  $\epsilon_r = 38.594$ ;  $\rho = 1000$  kg/m<sup>3</sup>

Communication System: UID 0, BT (0) Frequency: 2402 MHz Duty Cycle: 1:1

Probe: EX3DV4 - SN7621 ConvF (8.17, 8.17, 8.17)

**Left Cheek Ch.0/Area Scan (91x91x1):** Interpolated grid: dx=1.000 mm, dy=1.000 mm

Maximum value of SAR (interpolated) = 0.0392 W/kg

**Left Cheek Ch.0/Zoom Scan (7x7x7)/Cube 0:** Measurement grid: dx=5mm, dy=5mm, dz=5mm

Reference Value = 1.679 V/m; Power Drift = 0.05 dB

Peak SAR (extrapolated) = 0.0460 W/kg

**SAR(1 g) = 0.020 W/kg; SAR(10 g) = 0.011 W/kg**

Maximum value of SAR (measured) = 0.0286 W/kg

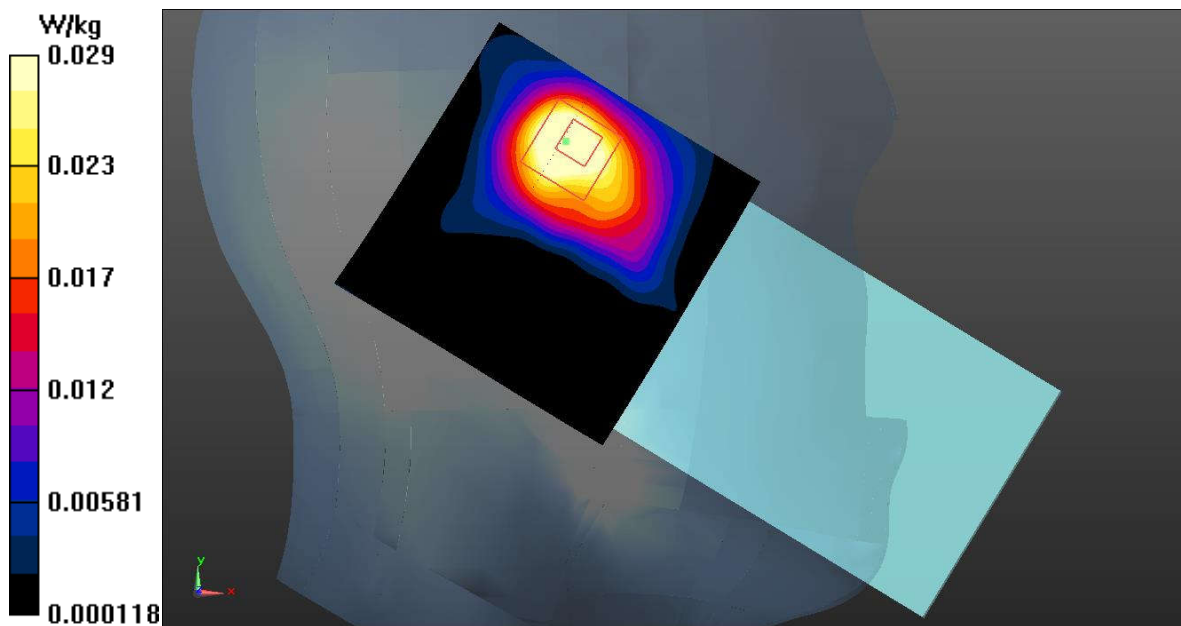

Fig.23 Bluetooth Head

**Bluetooth Body**

Date: 2022-9-27

Electronics: DAE4 Sn1527

Medium: Head 2450MHz

Medium parameters used:  $f = 2402$  MHz;  $\sigma = 1.775$  S/m;  $\epsilon_r = 38.594$ ;  $\rho = 1000$  kg/m<sup>3</sup>

Communication System: UID 0, BT (0) Frequency: 2402 MHz Duty Cycle: 1:1

Probe: EX3DV4 - SN7621 ConvF (8.17, 8.17, 8.17)

**Rear Side Ch.0/Area Scan (61x151x1):** Interpolated grid: dx=1.000 mm, dy=1.000 mm

Maximum value of SAR (interpolated) = 0.0415 W/kg

**Rear Side Ch.0/Zoom Scan (7x7x7)/Cube 0:** Measurement grid: dx=5mm, dy=5mm, dz=5mm

Reference Value = 0.8250 V/m; Power Drift = 0.03 dB

Peak SAR (extrapolated) = 0.0580 W/kg

**SAR(1 g) = 0.044 W/kg; SAR(10 g) = 0.024 W/kg**

Maximum value of SAR (measured) = 0.0415 W/kg

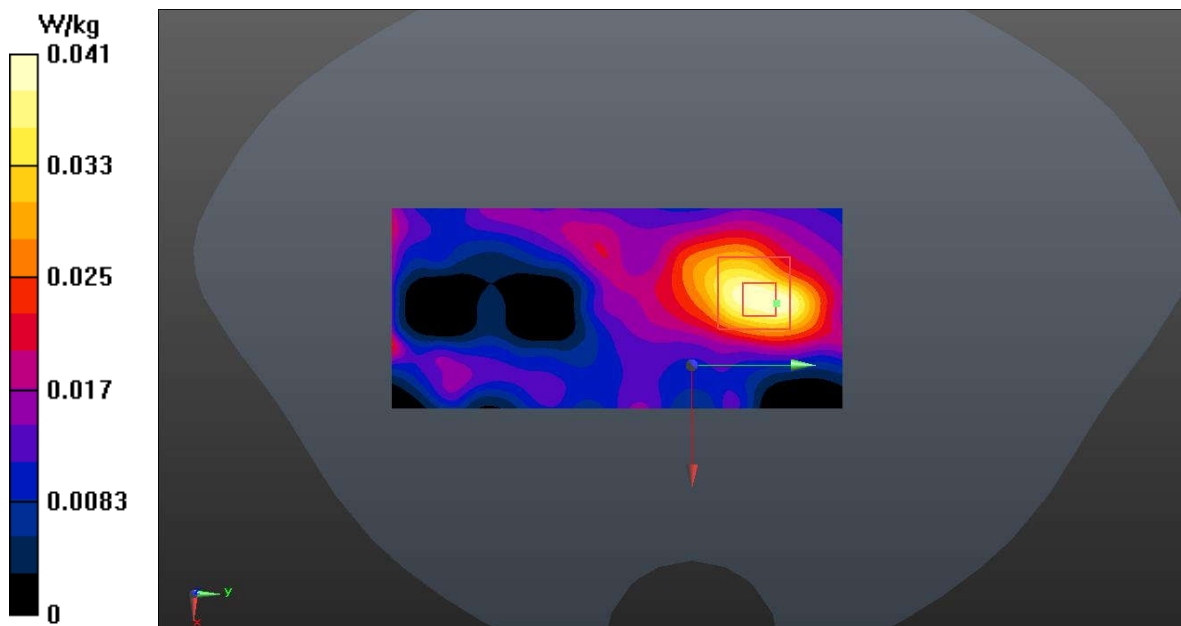

Fig.24 Bluetooth Body

**WLAN 2.4GHz Head**

Date: 2022-9-27

Electronics: DAE4 Sn1527

Medium: Head 2450MHz

Medium parameters used (interpolated):  $f = 2437$  MHz;  $\sigma = 1.817$  S/m;  $\epsilon_r = 38.479$ ;  $\rho = 1000$  kg/m<sup>3</sup>

Communication System: UID 0, WLAN (0) Frequency: 2437 MHz Duty Cycle: 1:1

Probe: EX3DV4 - SN7621 ConvF (8.17, 8.17, 8.17)

**Left Cheek Ch.6/Area Scan (91x91x1):** Interpolated grid: dx=1.000 mm, dy=1.000 mm

Maximum value of SAR (interpolated) = 0.281 W/kg

**Left Cheek Ch.6/Zoom Scan (7x7x7)/Cube 0:** Measurement grid: dx=5mm, dy=5mm, dz=5mm

Reference Value = 5.680 V/m; Power Drift = 0.08 dB

Peak SAR (extrapolated) = 0.387 W/kg

**SAR(1 g) = 0.169 W/kg; SAR(10 g) = 0.089 W/kg**

Maximum value of SAR (measured) = 0.248 W/kg

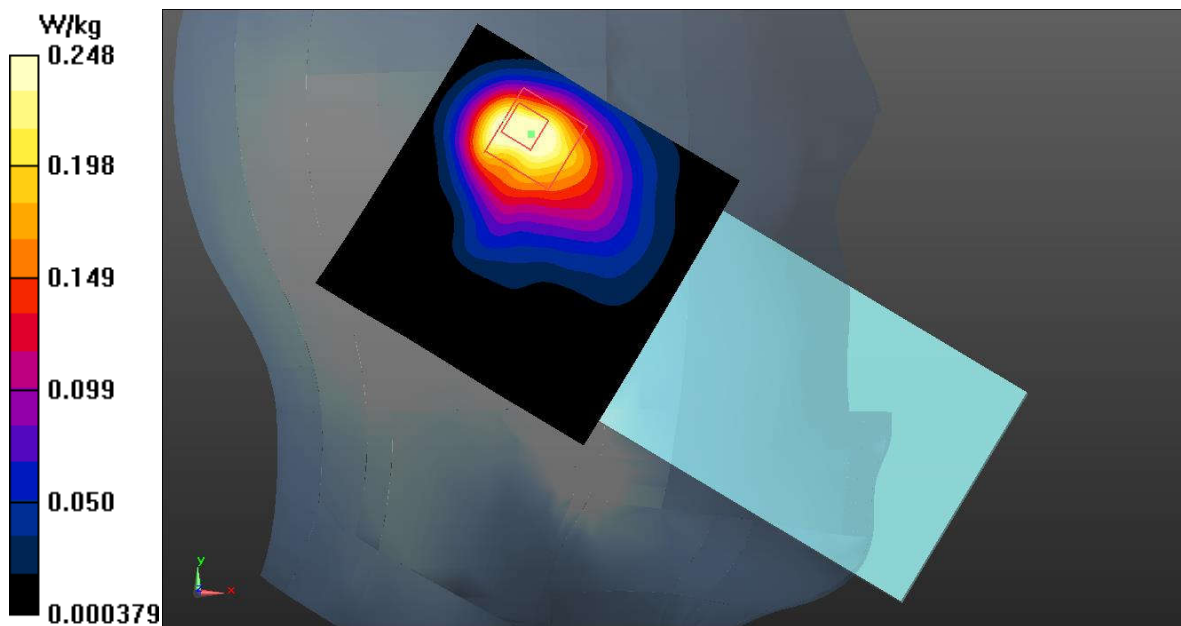

Fig.25 WLAN 2.4GHz Head

**WLAN 2.4GHz Body**

Date: 2022-9-27

Electronics: DAE4 Sn1527

Medium: Head 2450MHz

Medium parameters used (interpolated):  $f = 2437$  MHz;  $\sigma = 1.817$  S/m;  $\epsilon_r = 38.479$ ;  $\rho = 1000$  kg/m<sup>3</sup>

Communication System: UID 0, WLAN (0) Frequency: 2437 MHz Duty Cycle: 1:1

Probe: EX3DV4 - SN7621 ConvF (8.17, 8.17, 8.17)

**Right Side Ch.6/Area Scan (61x141x1):** Interpolated grid: dx=1.000 mm, dy=1.000 mm

Maximum value of SAR (interpolated) = 0.0791 W/kg

**Right Side Ch.6/Zoom Scan (7x7x7)/Cube 0:** Measurement grid: dx=5mm, dy=5mm, dz=5mm

Reference Value = 4.551 V/m; Power Drift = 0.12 dB

Peak SAR (extrapolated) = 0.102 W/kg

**SAR(1 g) = 0.054 W/kg; SAR(10 g) = 0.028 W/kg**

Maximum value of SAR (measured) = 0.0758 W/kg

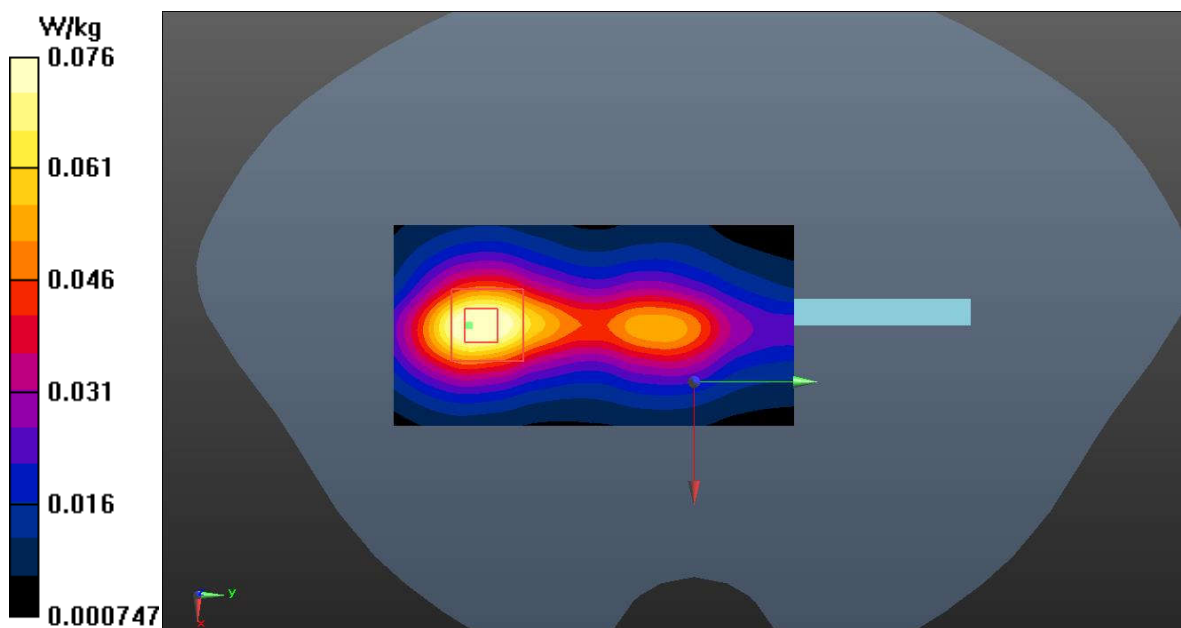

Fig.26 WLAN 2.4GHz Body

**WLAN 5GHz Head**

Date: 2022-9-17

Electronics: DAE4 Sn1527

Medium: Head 5250MHz

Medium parameters used:  $f = 5300$  MHz;  $\sigma = 4.855$  S/m;  $\epsilon_r = 34.856$ ;  $\rho = 1000$  kg/m<sup>3</sup>

Communication System: UID 0, WLAN 5G (0) Frequency: 5300 MHz Duty Cycle: 1:1

Probe: EX3DV4 - SN7621 ConvF (5.98, 5.98, 5.98)

**Left Tilt Ch.60/Area Scan (91x91x1):** Interpolated grid: dx=1.000 mm, dy=1.000 mm

Maximum value of SAR (interpolated) = 1.17 W/kg

**Left Tilt Ch.60/Zoom Scan (8x8x21)/Cube 0:** Measurement grid: dx=4mm, dy=4mm, dz=1.4mm

Reference Value = 4.898 V/m; Power Drift = 0.00 dB

Peak SAR (extrapolated) = 2.46 W/kg

**SAR(1 g) = 0.545 W/kg; SAR(10 g) = 0.165 W/kg**

Maximum value of SAR (measured) = 1.25 W/kg

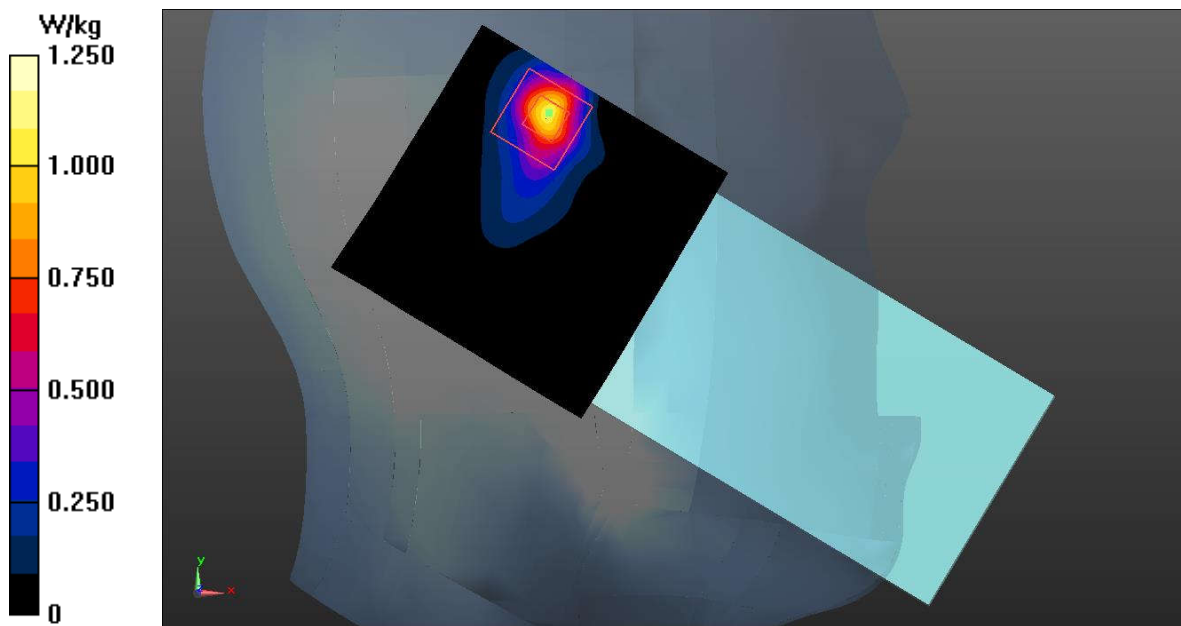

Fig.27 WLAN 5GHz Head



**WLAN 5GHz Body**

Date: 2022-9-17

Electronics: DAE4 Sn1527

Medium: Head 5250MHz

Medium parameters used:  $f = 5180$  MHz;  $\sigma = 4.693$  S/m;  $\epsilon_r = 35.18$ ;  $\rho = 1000$  kg/m<sup>3</sup>

Communication System: UID 0, WLAN 5G (0) Frequency: 5180 MHz Duty Cycle: 1:1

Probe: EX3DV4 - SN7621 ConvF (5.98, 5.98, 5.98)

**Rear Side Ch.36/Area Scan (91x111x1):** Interpolated grid: dx=1.000 mm, dy=1.000 mm  
Maximum value of SAR (interpolated) = 0.560 W/kg**Rear Side Ch.36/Zoom Scan (8x8x21)/Cube 0:** Measurement grid: dx=4mm, dy=4mm, dz=1.4mm  
Reference Value = 0.5310 V/m; Power Drift = 0.04 dB

Peak SAR (extrapolated) = 1.25 W/kg

**SAR(1 g) = 0.335 W/kg; SAR(10 g) = 0.114 W/kg**

Maximum value of SAR (measured) = 0.615 W/kg

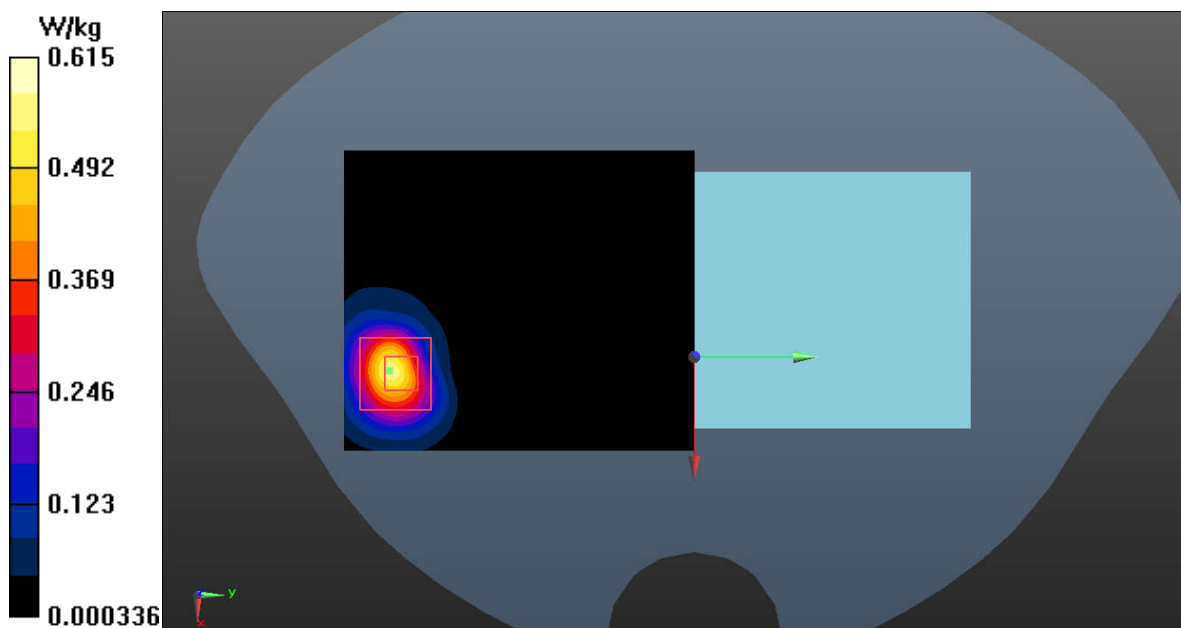

Fig.28 WLAN 5GHz Body

**WLAN 5GHz Extremity**

Date: 2022-9-17

Electronics: DAE4 Sn1527

Medium: Head 5600MHz

Medium parameters used:  $f = 5500$  MHz;  $\sigma = 5.034$  S/m;  $\epsilon_r = 35.003$ ;  $\rho = 1000$  kg/m<sup>3</sup>

Communication System: UID 0, WLAN 5G (0) Frequency: 5500 MHz Duty Cycle: 1:1

Probe: EX3DV4 - SN7621 ConvF (5.47, 5.47, 5.47)

**Rear Side Ch.100/Area Scan (101x101x1):** Interpolated grid: dx=1.000 mm, dy=1.000 mm  
Maximum value of SAR (interpolated) = 3.81 W/kg**Rear Side Ch.100/Zoom Scan (8x8x21)/Cube 0:** Measurement grid: dx=4mm, dy=4mm, dz=1.4mm

Reference Value = 0.7890 V/m; Power Drift = -0.12 dB

Peak SAR (extrapolated) = 19.3 W/kg

**SAR(1 g) = 3.20 W/kg; SAR(10 g) = 0.686 W/kg**

Maximum value of SAR (measured) = 6.55 W/kg

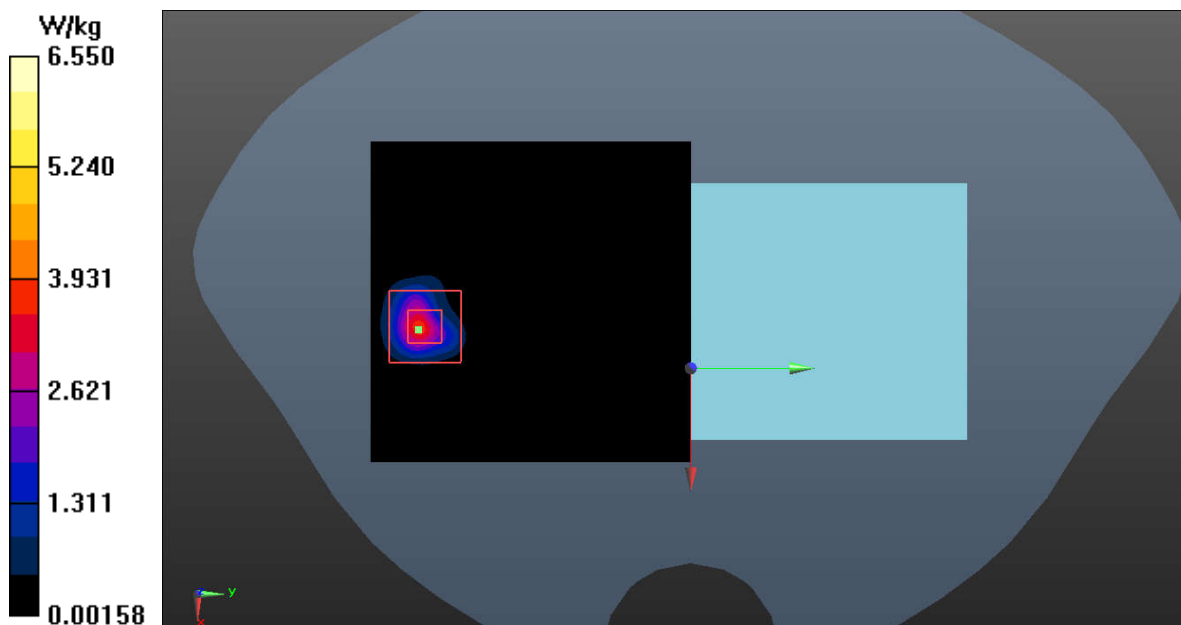
**Fig.29 WLAN 5GHz Extremity**

## ANNEX B: SystemVerification Results

### 750MHz

Date: 2022-9-10

Electronics: DAE4 Sn1527

Medium: Head 750MHz

Medium parameters used:  $f = 750 \text{ MHz}$ ;  $\sigma = 0.904 \text{ S/m}$ ;  $\epsilon_r = 40.882$ ;  $\rho = 1000 \text{ kg/m}^3$

Communication System: CW\_TMC Frequency: 750 MHz Duty Cycle: 1:1

Probe: EX3DV4 - SN7621 ConvF (11.12, 11.12, 11.12)

**System Validation/Area Scan (81x161x1):** Interpolated grid:  $dx=1.000 \text{ mm}$ ,  $dy=1.000 \text{ mm}$

Reference Value = 60.842 V/m; Power Drift = 0.11 dB

**SAR(1 g) = 2.15 W/kg; SAR(10 g) = 1.41 W/kg**

Maximum value of SAR (interpolated) = 2.82 W/kg

**System Validation/Zoom Scan (7x7x7)/Cube 0:** Measurement grid:  $dx=5\text{mm}$ ,  $dy=5\text{mm}$ ,  $dz=5\text{mm}$

Reference Value = 60.842 V/m; Power Drift = 0.11 dB

Peak SAR (extrapolated) = 3.25 W/kg

**SAR(1 g) = 2.19 W/kg; SAR(10 g) = 1.43 W/kg**

Maximum value of SAR (measured) = 2.86 W/kg

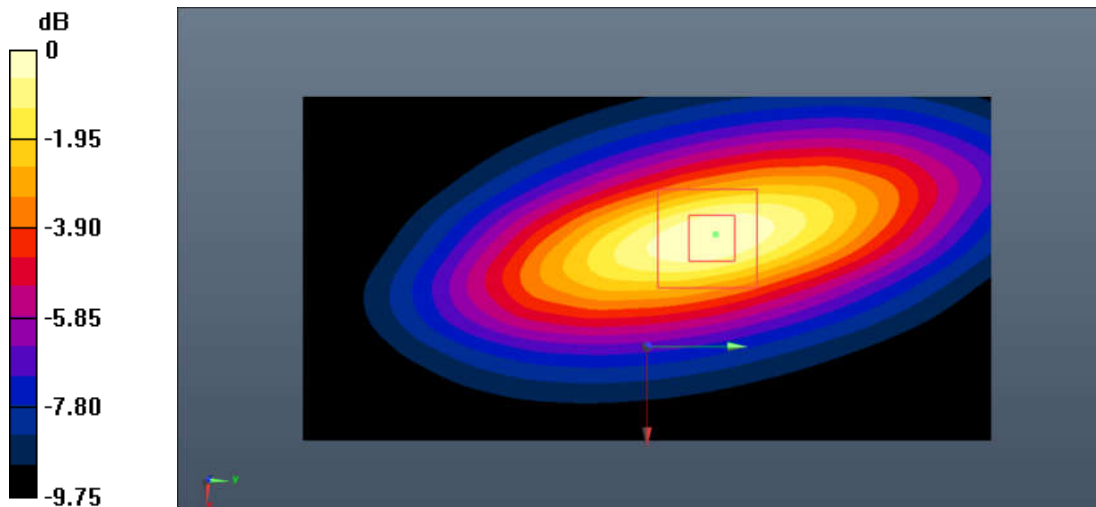

0 dB = 2.86 W/kg = 4.56 dB W/kg

**Fig.B.1. Validation 750MHz 250mW**

**835MHz**

Date: 2022-9-9

Electronics: DAE4 Sn1527

Medium: Head 835MHz

Medium parameters used:  $f = 835$  MHz;  $\sigma = 0.918$  S/m;  $\epsilon_r = 40.602$ ;  $\rho = 1000$  kg/m<sup>3</sup>

Communication System: CW\_TMC Frequency: 835 MHz Duty Cycle: 1:1

Probe: EX3DV4 - SN7621 ConvF (11.12, 11.12, 11.12)

**System Validation/Area Scan (91x161x1):** Interpolated grid: dx=1.000 mm, dy=1.000 mm

Reference Value = 64.005 V/m; Power Drift = 0.07 dB

**SAR(1 g) = 2.47 W/kg; SAR(10 g) = 1.59 W/kg**

Maximum value of SAR (interpolated) = 3.66 W/kg

**System Validation/Zoom Scan (7x7x7)/Cube 0:** Measurement grid: dx=5mm, dy=5mm, dz=5mm

Reference Value = 64.005 V/m; Power Drift = 0.07 dB

Peak SAR (extrapolated) = 4.48 W/kg

**SAR(1 g) = 2.52 W/kg; SAR(10 g) = 1.62 W/kg**

Maximum value of SAR (measured) = 3.69 W/kg

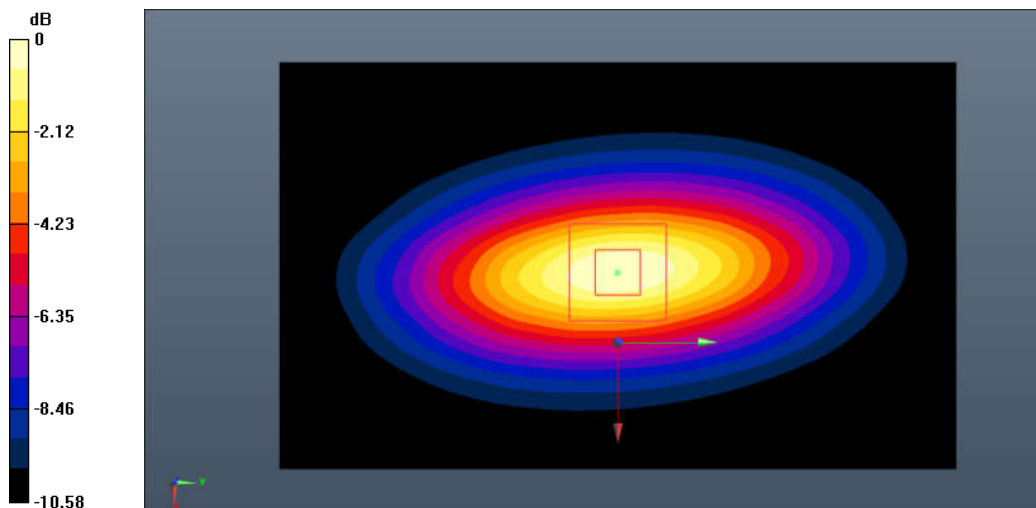

0 dB = 3.69 W/kg = 5.67 dB W/kg

**Fig.B.2. Validation 835MHz 250mW**

**1750MHz**

Date: 2022-9-2

Electronics: DAE4 Sn1527

Medium: Head 1750MHz

Medium parameters used:  $f = 1750$  MHz;  $\sigma = 1.363$  S/m;  $\epsilon_r = 40.553$ ;  $\rho = 1000$  kg/m<sup>3</sup>

Communication System: CW\_TMC Frequency: 1750 MHz Duty Cycle: 1:1

Probe: EX3DV4 - SN7621 ConvF (9.22, 9.22, 9.22)

**System Validation/Area Scan (81x121x1):** Interpolated grid: dx=1.000 mm, dy=1.000 mm

Reference Value = 79.248 V/m; Power Drift = -0.08 dB

**SAR(1 g) = 9.05 W/kg; SAR(10 g) = 4.91 W/kg**

Maximum value of SAR (interpolated) = 11.0 W/kg

**System Validation/Zoom Scan (7x7x7)/Cube0:** Measurement grid: dx=5mm, dy=5mm, dz=5mm

Reference Value = 79.248 V/m; Power Drift = -0.08 dB

Peak SAR (extrapolated) = 21.2 W/kg

**SAR(1 g) = 8.73 W/kg; SAR(10 g) = 4.79 W/kg**

Maximum value of SAR (measured) = 10.8 W/kg

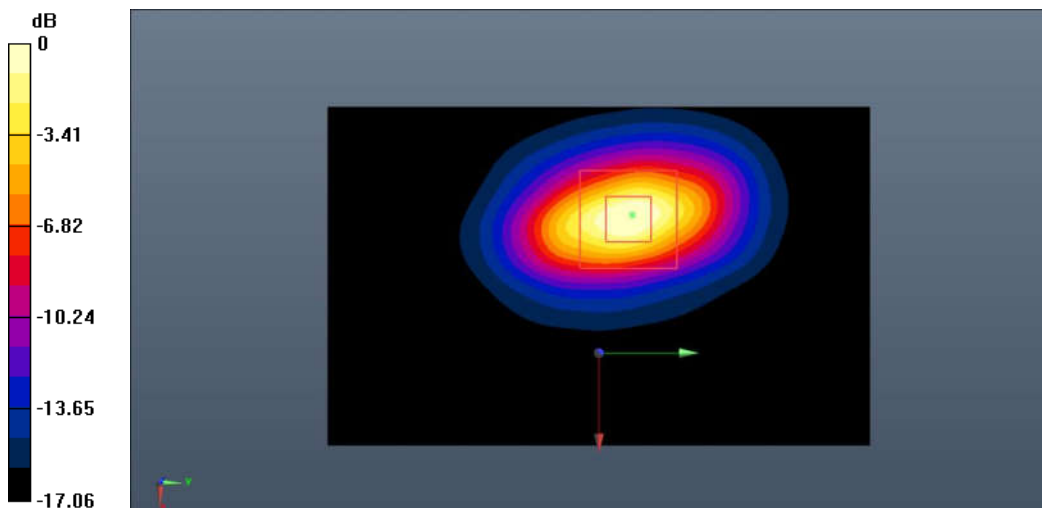

0 dB = 10.8 W/kg = 10.33 dB W/kg

**Fig.B.3. Validation 1750MHz 250mW**

**1900MHz**

Date: 2022-9-1

Electronics: DAE4 Sn1527

Medium: Head 1900MHz

Medium parameters used:  $f = 1900$  MHz;  $\sigma = 1.385$  S/m;  $\epsilon_r = 40.367$ ;  $\rho = 1000$  kg/m<sup>3</sup>

Communication System: CW\_TMC Frequency: 1900 MHz Duty Cycle: 1:1

Probe: EX3DV4 - SN7621 ConvF (8.90, 8.90, 8.90)

**System Validation/Area Scan (91x91x1):** Interpolated grid: dx=1.000 mm, dy=1.000 mm

Reference Value = 81.379 V/m; Power Drift = -0.03 dB

**SAR(1 g) = 10.0 W/kg; SAR(10 g) = 5.15 W/kg**

Maximum value of SAR (interpolated) = 12.1 W/kg

**System Validation/Zoom Scan (7x7x7)/Cube0:** Measurement grid: dx=5mm, dy=5mm, dz=5mm

Reference Value = 81.379 V/m; Power Drift = -0.03 dB

Peak SAR (extrapolated) = 24.7 W/kg

**SAR(1 g) = 9.80 W/kg; SAR(10 g) = 5.04 W/kg**

Maximum value of SAR (measured) = 11.8 W/kg

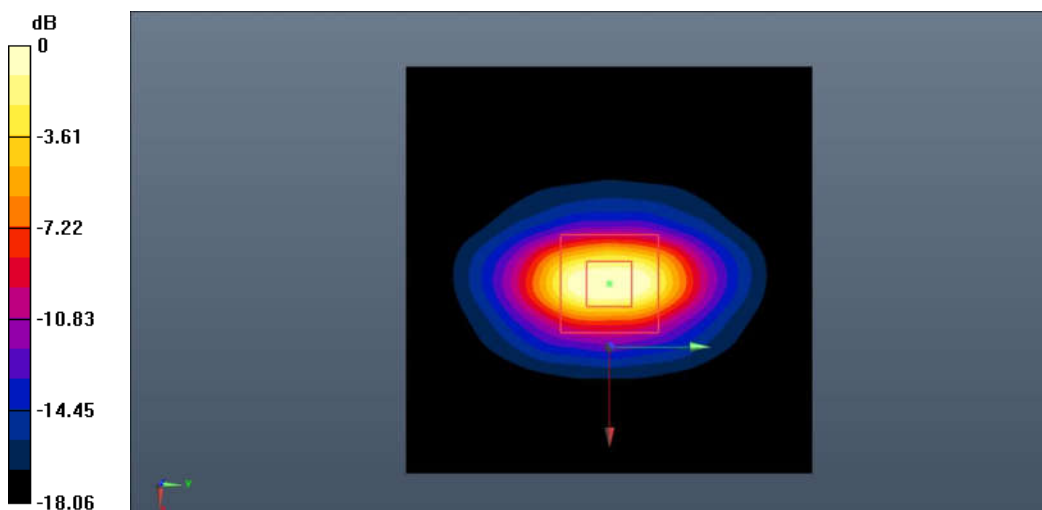

0 dB = 11.8 W/kg = 10.72 dB W/kg

**Fig.B.4. Validation 1900MHz 250mW**

**2450MHz**

Date: 2022-9-27

Electronics: DAE4 Sn1527

Medium: Head 2450MHz

Medium parameters used:  $f = 2450 \text{ MHz}$ ;  $\sigma = 1.832 \text{ S/m}$ ;  $\epsilon_r = 38.436$ ;  $\rho = 1000 \text{ kg/m}^3$

Communication System: CW\_TMC Frequency: 2450 MHz Duty Cycle: 1:1

Probe: EX3DV4 - SN7621 ConvF (8.17, 8.17, 8.17)

**System Validation/Area Scan (81x121x1):** Interpolated grid:  $dx=1.000 \text{ mm}$ ,  $dy=1.000 \text{ mm}$

Reference Value = 91.554 V/m; Power Drift = 0.06 dB

**SAR(1 g) = 13.4 W/kg; SAR(10 g) = 6.06 W/kg**

Maximum value of SAR (interpolated) = 15.4 W/kg

**System Validation/Zoom Scan (7x7x7)/Cube0:** Measurement grid:  $dx=5\text{mm}$ ,  $dy=5\text{mm}$ ,  $dz=5\text{mm}$

Reference Value = 91.554 V/m; Power Drift = 0.06 dB

Peak SAR (extrapolated) = 36.3 W/kg

**SAR(1 g) = 13.7 W/kg; SAR(10 g) = 6.15 W/kg**

Maximum value of SAR (measured) = 15.8 W/kg

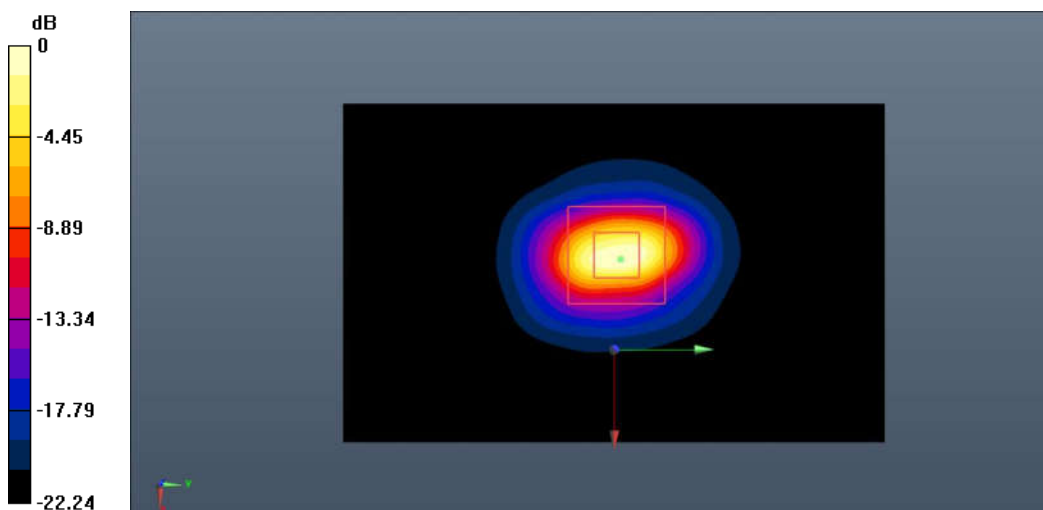

0 dB = 15.8 W/kg = 11.99 dB W/kg

**Fig.B.5. Validation 2450MHz 250mW**

**2550MHz**

Date: 2022-9-30

Electronics: DAE4 Sn1527

Medium: Head 2550MHz

Medium parameters used:  $f = 2550$  MHz;  $\sigma = 1.946$  S/m;  $\epsilon_r = 38.184$ ;  $\rho = 1000$  kg/m<sup>3</sup>

Communication System: CW\_TMC Frequency: 2550 MHz Duty Cycle: 1:1

Probe: EX3DV4 - SN7621 ConvF (8.17, 8.17, 8.17)

**System Validation/Area Scan (91x91x1):** Interpolated grid: dx=1.000 mm, dy=1.000 mm

Reference Value = 94.556 V/m; Power Drift = 0.12 dB

**SAR(1 g) = 14.1 W/kg; SAR(10 g) = 6.29 W/kg**

Maximum value of SAR (interpolated) = 16.0 W/kg

**System Validation/Zoom Scan (7x7x7)/Cube0:** Measurement grid: dx=5mm, dy=5mm, dz=5mm

Reference Value = 94.556 V/m; Power Drift = 0.12 dB

Peak SAR (extrapolated) = 37.6 W/kg

**SAR(1 g) = 14.4 W/kg; SAR(10 g) = 6.42 W/kg**

Maximum value of SAR (measured) = 16.3 W/kg

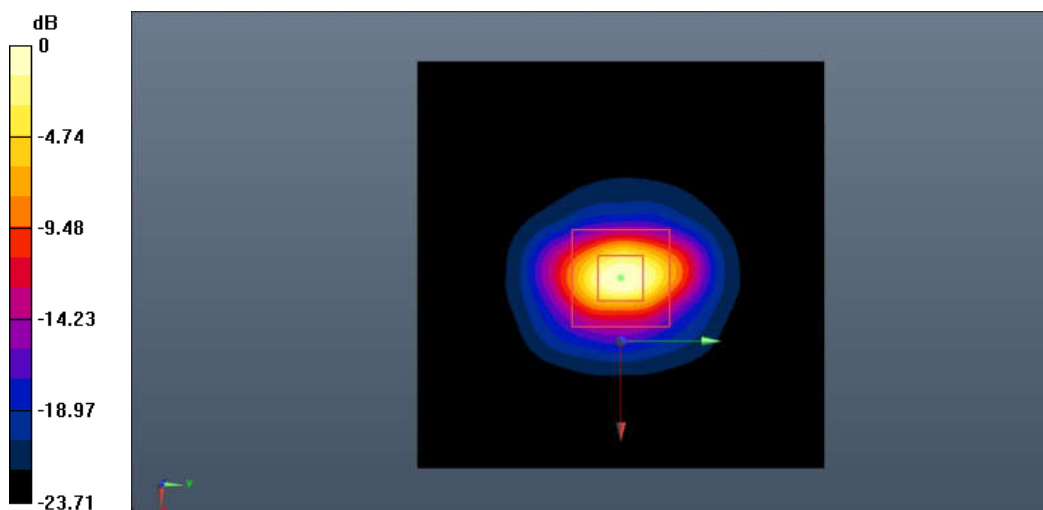

0 dB = 16.3 W/kg = 12.12 dB W/kg

**Fig.B.6. Validation 2550MHz 250mW**



**5250MHz**

Date: 2022-9-17

Electronics: DAE4 Sn1527

Medium: Head 5250MHz

Medium parameters used:  $f = 5250$  MHz;  $\sigma = 4.787$  S/m;  $\epsilon_r = 34.991$ ;  $\rho = 1000$  kg/m<sup>3</sup>

Communication System: CW\_TMC Frequency: 5250 MHz Duty Cycle: 1:1

Probe: EX3DV4 - SN7621 ConvF (5.98, 5.98, 5.98)

**System Validation/Area Scan (61x91x1):** Interpolated grid: dx=1.000 mm, dy=1.000 mm

Reference Value = 68.456 V/m; Power Drift = 0.13 dB

**SAR(1 g) = 8.05 W/kg; SAR(10 g) = 2.29 W/kg**

Maximum value of SAR (interpolated) = 10.1 W/kg

**System Validation/Zoom Scan (8x8x21)/Cube0:** Measurement grid: dx=4mm, dy=4mm, dz=1.4mm

Reference Value = 68.456 V/m; Power Drift = 0.13 dB

Peak SAR (extrapolated) = 26.6 W/kg

**SAR(1 g) = 8.28 W/kg; SAR(10 g) = 2.34 W/kg**

Maximum value of SAR (measured) = 10.3 W/kg

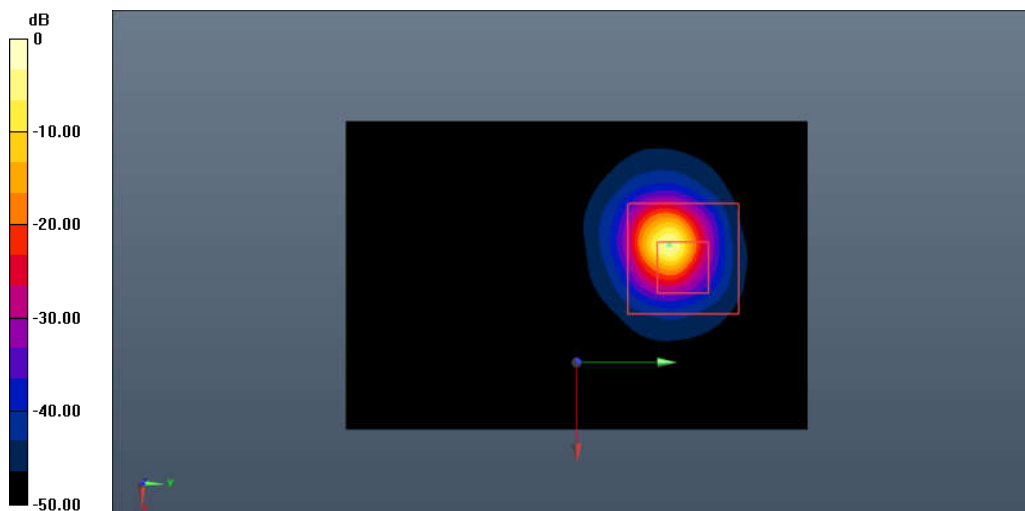

0 dB = 10.3 W/kg = 10.13 dB W/kg

**Fig.B.7. Validation 5250MHz 100mW**

**5600MHz**

Date: 2022-9-17

Electronics: DAE4 Sn1527

Medium: Head 5600MHz

Medium parameters used:  $f = 5600$  MHz;  $\sigma = 5.169$  S/m;  $\epsilon_r = 34.733$ ;  $\rho = 1000$  kg/m<sup>3</sup>

Communication System: CW\_TMC Frequency: 5600 MHz Duty Cycle: 1:1

Probe: EX3DV4 - SN7621 ConvF (5.47, 5.47, 5.47)

**System Validation/Area Scan (61x91x1):** Interpolated grid: dx=1.000 mm, dy=1.000 mm

Reference Value = 68.252 V/m; Power Drift = 0.09 dB

**SAR(1 g) = 8.36 W/kg; SAR(10 g) = 2.34 W/kg**

Maximum value of SAR (interpolated) = 10.3 W/kg

**System Validation/Zoom Scan (8x8x21)/Cube0:** Measurement grid: dx=4mm, dy=4mm, dz=1.4mm

Reference Value = 68.252 V/m; Power Drift = 0.09 dB

Peak SAR (extrapolated) = 28.0 W/kg

**SAR(1 g) = 8.60 W/kg; SAR(10 g) = 2.42 W/kg**

Maximum value of SAR (measured) = 10.5 W/kg

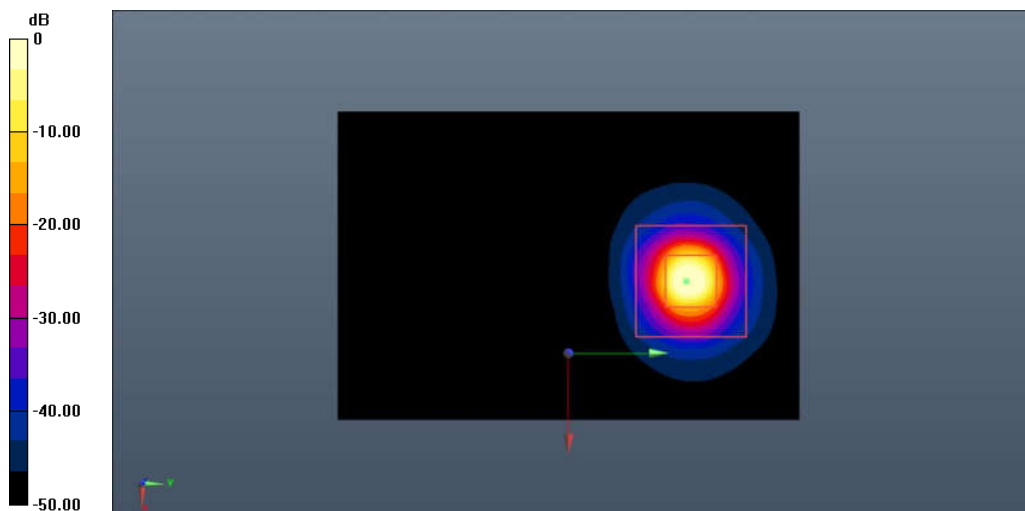

0 dB = 10.5 W/kg = 10.21 dB W/kg

**Fig.B.8. Validation 5600MHz 100mW**

**5750MHz**

Date: 2022-9-17

Electronics: DAE4 Sn1527

Medium: Head 5750MHz

Medium parameters used:  $f = 5750$  MHz;  $\sigma = 5.111$  S/m;  $\epsilon_r = 36.345$ ;  $\rho = 1000$  kg/m<sup>3</sup>

Communication System: CW\_TMC Frequency: 5750 MHz Duty Cycle: 1:1

Probe: EX3DV4 - SN7621 ConvF (5.40, 5.40, 5.40)

**System Validation/Area Scan (61x91x1):** Interpolated grid: dx=1.000 mm, dy=1.000 mm

Reference Value = 64.456 V/m; Power Drift = -0.05 dB

**SAR(1 g) = 7.82 W/kg; SAR(10 g) = 2.20 W/kg**

Maximum value of SAR (interpolated) = 9.96 W/kg

**System Validation/Zoom Scan (8x8x21)/Cube0:** Measurement grid: dx=4mm, dy=4mm, dz=1.4mm

Reference Value = 64.456 V/m; Power Drift = -0.05 dB

Peak SAR (extrapolated) = 26.8 W/kg

**SAR(1 g) = 7.59 W/kg; SAR(10 g) = 2.17 W/kg**

Maximum value of SAR (measured) = 9.91 W/kg

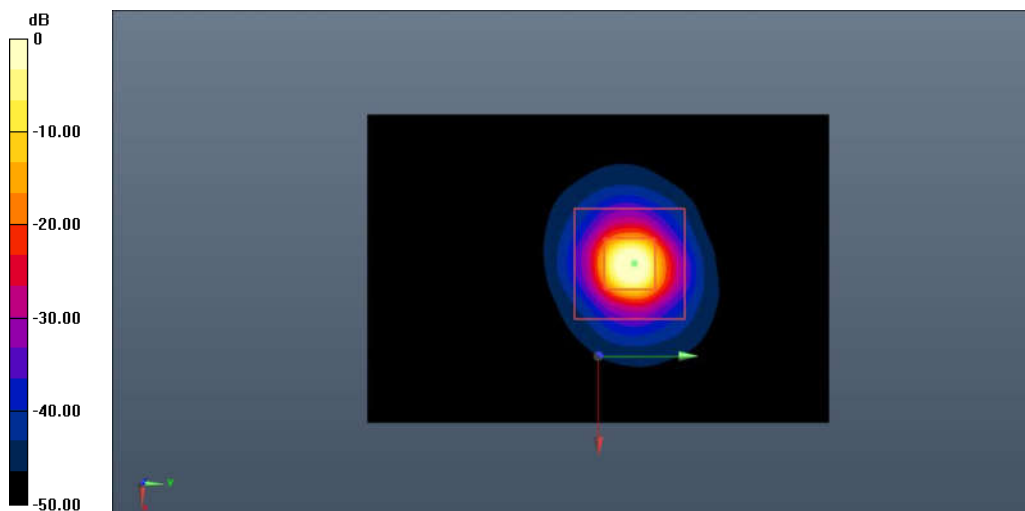

0 dB = 9.91 W/kg = 9.96 dB W/kg

**Fig.B.9. Validation 5750MHz 100mW**

## ANNEX C: SAR Measurement Setup

### C.1. Measurement Set-up

DASY5 system for performing compliance tests is illustrated above graphically. This system consists of the following items:

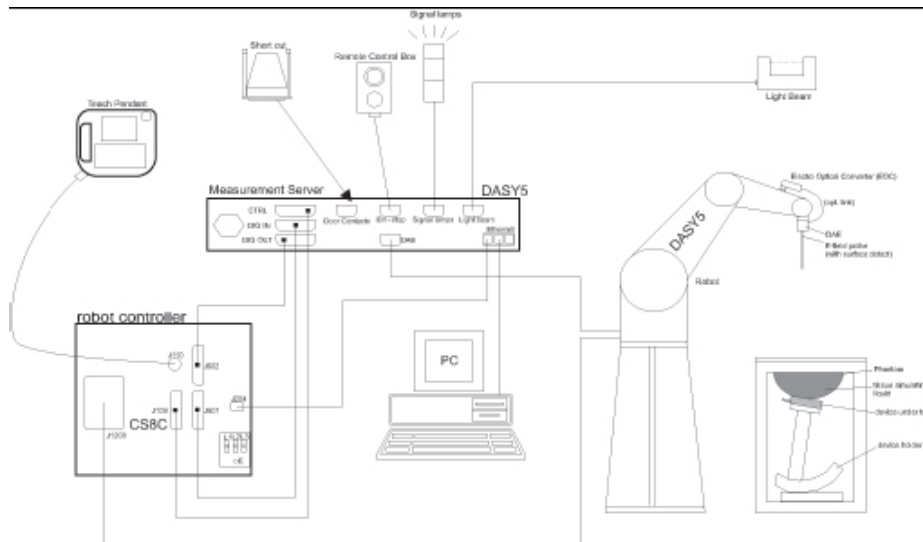

Picture C.1 SAR Lab Test Measurement Set-up

- A standard high precision 6-axis robot (Stäubli TX=RX family) with controller, teach pendant and software. An arm extension for accommodating the data acquisition electronics (DAE).
- An isotropic field probe optimized and calibrated for the targeted measurement.
- A data acquisition electronics (DAE) which performs the signal amplification, signal multiplexing, AD-conversion, offset measurements, mechanical surface detection, collision detection, etc. The unit is battery powered with standard or rechargeable batteries. The signal is optically transmitted to the EOC.
- The Electro-optical converter (EOC) performs the conversion from optical to electrical signals for the digital communication to the DAE. To use optical surface detection, a special version of the EOC is required. The EOC signal is transmitted to the measurement server.
- The function of the measurement server is to perform the time critical tasks such as signal filtering, control of the robot operation and fast movement interrupts.
- The Light Beam used is for probe alignment. This improves the (absolute) accuracy of the probe positioning.
- A computer running WinXP and the DASY5 software.
- Remote control and teach pendant as well as additional circuitry for robot safety such as warning lamps, etc.
- The phantom, the device holder and other accessories according to the targeted measurement.

## C.2. DASY5 E-field Probe System

The SAR measurements were conducted with the dosimetric probe designed in the classical triangular configuration and optimized for dosimetric evaluation. The probe is constructed using the thick film technique; with printed resistive lines on ceramic substrates. The probe is equipped with an optical multifiber line ending at the front of the probe tip. It is connected to the EOC box on the robot arm and provides an automatic detection of the phantom surface. Half of the fibers are connected to a pulsed infrared transmitter, the other half to a synchronized receiver. As the probe approaches the surface, the reflection from the surface produces a coupling from the transmitting to the receiving fibers. This reflection increases first during the approach, reaches maximum and then decreases. If the probe is flatly touching the surface, the coupling is zero. The distance of the coupling maximum to the surface is independent of the surface reflectivity and largely independent of the surface to probe angle. The DASY5 software reads the reflection during a software approach and looks for the maximum using 2<sup>nd</sup> order curve fitting. The approach is stopped at reaching the maximum.

### Probe Specifications:

<b>Model:</b>	<b>ES3DV3, EX3DV4</b>
<b>Frequency</b>	<b>10MHz — 6.0GHz(EX3DV4)</b>
<b>Range:</b>	<b>10MHz — 4GHz(ES3DV3)</b>
<b>Calibration:</b>	<b>In head and body simulating tissue at Frequencies from 835 up to 5800MHz</b>
<b>Linearity:</b>	<b>± 0.2 dB(30 MHz to 6 GHz) for EX3DV4 ± 0.2 dB(30 MHz to 4 GHz) for ES3DV3</b>
<b>Dynamic Range:</b>	<b>10 mW/kg — 100W/kg</b>
<b>Probe Length:</b>	<b>330 mm</b>
<b>Probe Tip</b>	
<b>Length:</b>	<b>20 mm</b>
<b>Body Diameter:</b>	<b>12 mm</b>
<b>Tip Diameter:</b>	<b>2.5 mm (3.9 mm for ES3DV3)</b>
<b>Tip-Center:</b>	<b>1 mm (2.0mm for ES3DV3)</b>
<b>Application:</b>	<b>SAR Dosimetry Testing Compliance tests of mobile phones Dosimetry in strong gradient fields</b>



Picture C.2 Near-field Probe



Picture C.3 E-field Probe



### C.3. E-field Probe Calibration

Each E-Probe/Probe Amplifier combination has unique calibration parameters. A TEM cell calibration procedure is conducted to determine the proper amplifier settings to enter in the probe parameters. The amplifier settings are determined for a given frequency by subjecting the probe to a known E-field density ( $1 \text{ mW/cm}^2$ ) using an RF Signal generator, TEM cell, and RF Power Meter.

The free space E-field from amplified probe outputs is determined in a test chamber. This calibration can be performed in a TEM cell if the frequency is below 1 GHz and in a waveguide or other methodologies above 1 GHz for free space. For the free space calibration, the probe is placed in the volumetric center of the cavity and at the proper orientation with the field. The probe is then rotated 360 degrees until the three channels show the maximum reading. The power density readings equates to  $1 \text{ mW/cm}^2$ .

E-field temperature correlation calibration is performed in a flat phantom filled with the appropriate simulated brain tissue. The E-field in the medium correlates with the temperature rise in the dielectric medium. For temperature correlation calibration a RF transparent thermistor-based temperature probe is used in conjunction with the E-field probe.

$$SAR = C \frac{\Delta T}{\Delta t}$$

Where:

$\Delta t$  = Exposure time (30 seconds),

C = Heat capacity of tissue (brain or muscle),

$\Delta T$  = Temperature increase due to RF exposure.

$$SAR = \frac{|E|^2 \cdot \sigma}{\rho}$$

Where:

$\sigma$  = Simulated tissue conductivity,

$\rho$  = Tissue density ( $\text{kg/m}^3$ ).

## C.4. Other Test Equipment

### C.4.1. Data Acquisition Electronics (DAE)

The data acquisition electronics consist of a highly sensitive electrometer-grade preamplifier with auto-zeroing, a channel and gain-switching multiplexer, a fast 16 bit AD-converter and a command decoder with a control logic unit. Transmission to the measurement server is accomplished through an optical downlink for data and status information, as well as an optical uplink for commands and the clock.

The mechanical probe mounting device includes two different sensor systems for frontal and sideways probe contacts. They are used for mechanical surface detection and probe collision detection.

The input impedance of the DAE is 200 MOhm; the inputs are symmetrical and floating. Common mode rejection is above 80 dB.



PictureC.4: DAE

### C.4.2. Robot

The SPEAG DASY system uses the high precision robots (DASY5: RX160L) type from Stäubli SA (France). For the 6-axis controller system, the robot controller version from Stäubli is used. The Stäubli robot series have many features that are important for our application:

- High precision (repeatability 0.02mm)
- High reliability (industrial design)
- Low maintenance costs (virtually maintenance free due to direct drive gears; no belt drives)
- Jerk-free straight movements (brushless synchron motors; no stepper motors)
- Low ELF interference (motor control fields shielded via the closed metallic construction shields)



Picture C.5 DASY 5

### C.4.3. Measurement Server

The Measurement server is based on a PC/104 CPU board with CPU (DASY5: 400 MHz, Intel Celeron), chipdisk (DASY5:128MB), RAM (DASY5:128MB). The necessary circuits for communication with the DAE electronic box, as well as the 16 bit AD converter system for optical detection and digital I/O interface are contained on the DASY I/O board, which is directly connected to the PC/104 bus of the CPU board.

The measurement server performs all real-time data evaluation of field measurements and surface detection, controls robot movements and handles safety operation. The PC operating system cannot interfere with these time critical processes. All connections are supervised by a watchdog, and disconnection of any of the cables to the measurement server will automatically disarm the robot and disable all program-controlled robot movements. Furthermore, the measurement server is equipped with an expansion port which is reserved for future applications. Please note that this expansion port does not have a standardized pinout, and therefore only devices provided by SPEAG can be connected. Devices from any other supplier could seriously damage the measurement server.



Picture C.6 Server for DASY 5

### C.4.4. Device Holder for Phantom

The SAR in the phantom is approximately inversely proportional to the square of the distance between the source and the liquid surface. For a source at 5mm distance, a positioning uncertainty of  $\pm 0.5\text{mm}$  would produce a SAR uncertainty of  $\pm 20\%$ . Accurate device positioning is therefore crucial for accurate and repeatable measurements. The positions in which the devices must be measured are defined by the standards.

The DASY device holder is designed to cope with the different positions given in the standard. It has two scales for device rotation (with respect to the body axis) and device inclination (with respect to the line between the ear reference points). The rotation centers for both scales is the ear reference point (ERP). Thus the device needs no repositioning when changing the angles.

The DASY device holder is constructed of low-loss POM material having the following dielectric

parameters: relative permittivity  $\varepsilon = 3$  and loss tangent  $\delta = 0.02$ . The amount of dielectric material has been reduced in the closest vicinity of the device, since measurements have suggested that the influence of the clamp on the test results could thus be lowered.

<Laptop Extension Kit>

The extension is lightweight and made of POM, acrylic glass and foam. It fits easily on the upper part of the Mounting Device in place of the phone positioner. The extension is fully compatible with the Twin-SAM and ELI phantoms.





**Picture C.7-1: Device Holder**

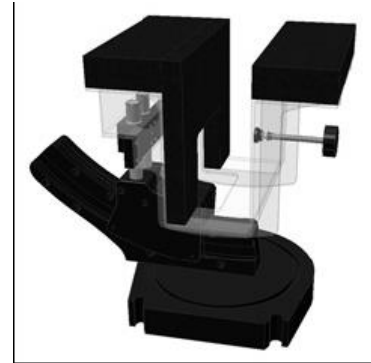

**Picture C.7-2: Laptop Extension Kit**

#### **C.4.5. Phantom**

The SAM Twin Phantom V4.0 is constructed of a fiberglass shell integrated in a table. The shape of the shell is based on data from an anatomical study designed to represent the 90<sup>th</sup> percentile of the population. The phantom enables the dissymmetric evaluation of SAR for both left and right handed handset usage, as well as body-worn usage using the flat phantom region. Reference markings on the Phantom allow the complete setup of all predefined phantom positions and measurement grids by manually teaching three points in the robot. The shell phantom has a 2mm shell thickness (except the ear region where shell thickness increases to 6 mm).

Shell Thickness:  $2 \pm 0.2$  mm  
Filling Volume: Approx. 25 liters  
Dimensions: 810 x 1000 x 500 mm (H x L x W)  
Available: Special



**Picture C.8: SAM Twin Phantom**

## ANNEX D: Position of the wireless device in relation to the phantom

### D.1. General considerations

This standard specifies two handset test positions against the head phantom – the “cheek” position and the “tilt” position.

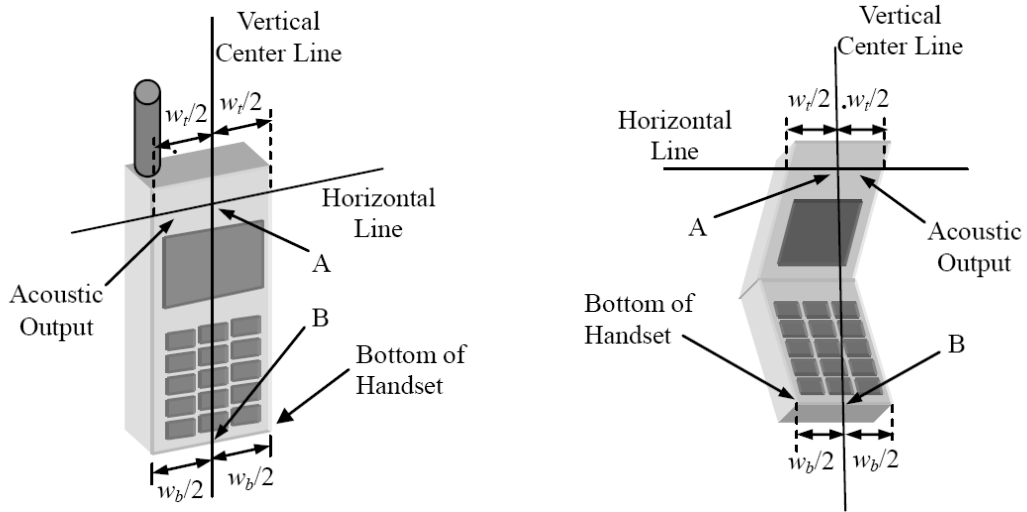

- $w_t$  Width of the handset at the level of the acoustic
- $w_b$  Width of the bottom of the handset
- A Midpoint of the width  $w_t$  of the handset at the level of the acoustic output
- B Midpoint of the width  $w_b$  of the bottom of the handset

Picture D.1-a Typical “fixed” case handset    Picture D.1-b Typical “clam-shell” case handset

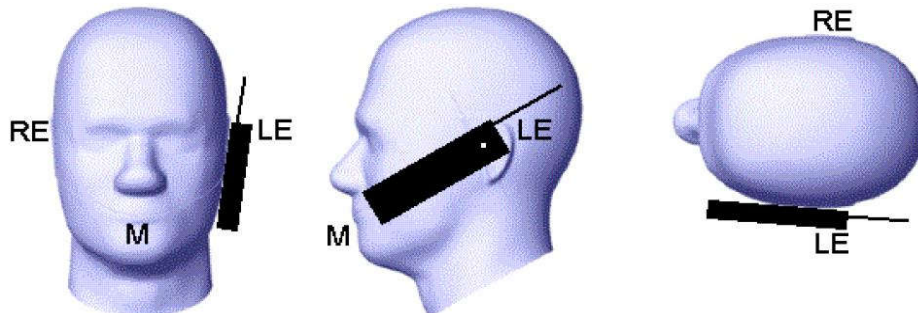

Picture D.2 Cheek position of the wireless device on the left side of SAM

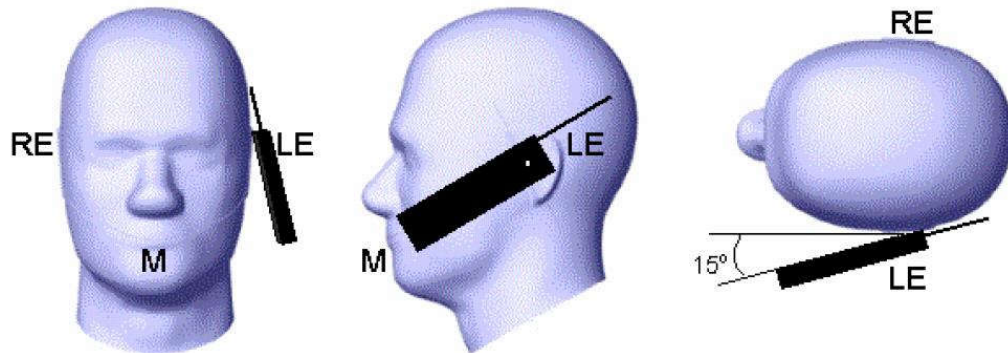

Picture D.3 Tilt position of the wireless device on the left side of SAM

## D.2. Body-worn device

A typical example of a body-worn device is a mobile phone, wireless enabled PDA or other battery operated wireless device with the ability to transmit while mounted on a person's body using a carry accessory approved by the wireless device manufacturer.

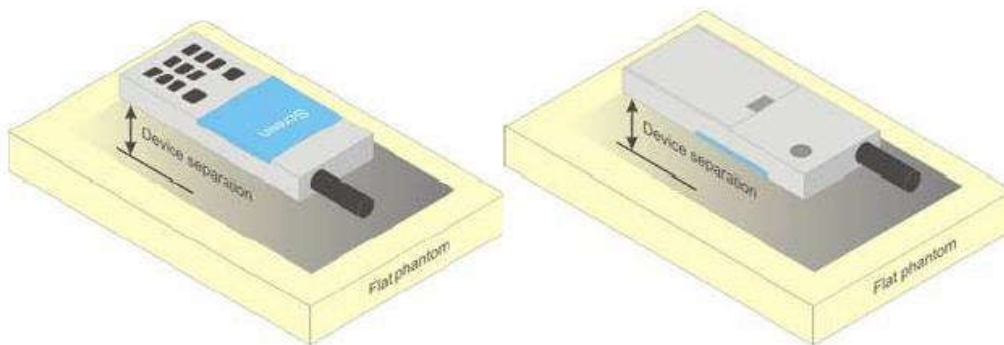

Picture D.4 Test positions for body-worn devices

## D.3. Desktop device

A typical example of a desktop device is a wireless enabled desktop computer placed on a table or desk when used.

The DUT shall be positioned at the distance and in the orientation to the phantom that corresponds to the intended use as specified by the manufacturer in the user instructions. For devices that employ an external antenna with variable positions, tests shall be performed for all antenna positions specified. Picture 8.5 show positions for desktop device SAR tests. If the intended use is not specified, the device shall be tested directly against the flat phantom.

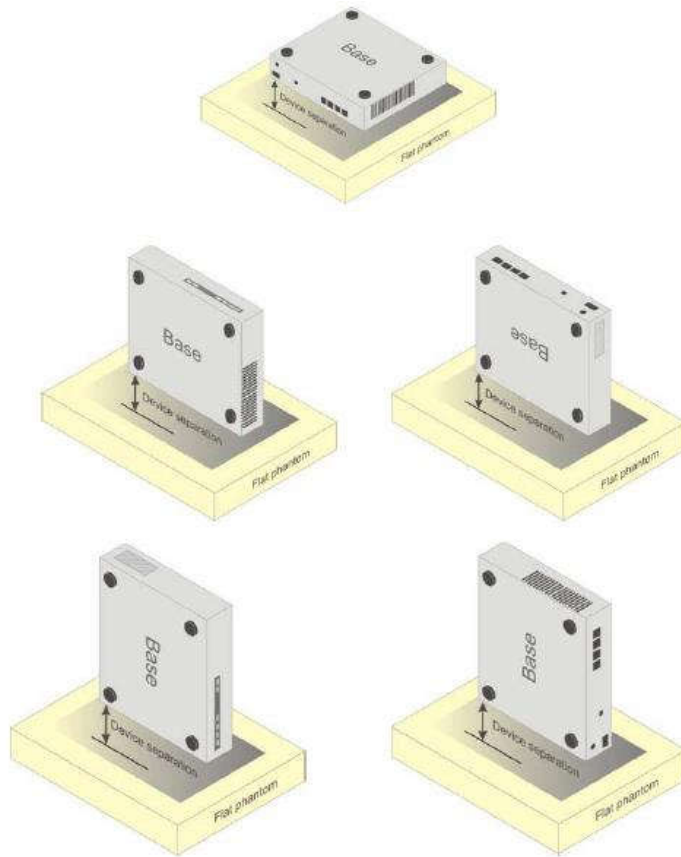

Picture D.5 Test positions for desktop devices

#### D.4. DUT Setup Photos



Picture D.6

## ANNEX E: Equivalent Media Recipes

The liquid used for the frequency range of 700-6000 MHz consisted of water, sugar, salt, preventol, glycol monobutyl and Cellulose. The liquid has been previously proven to be suited for worst-case. The Table E.1 shows the detail solution. It's satisfying the latest tissue dielectric parameters requirements proposed by the IEEE 1528 and IEC 62209.

**Table E.1: Composition of the Tissue Equivalent Matter**

Frequency (MHz)	835	1750	1900	2450	2600	5200	5800
Water	41.45	55.242	55.242	58.79	58.79	65.53	66.10
Sugar	56.0	/	/	/	/	/	/
Salt	1.45	0.306	0.306	0.06	0.06		
Preventol	0.1	/	/	/	/	17.24	16.95
Cellulose	1.0	/	/	/	/	17.24	16.95
Glycol Monobutyl	/	44.452	44.452	41.15	41.15	/	/
Diethylenglycol monohexylether	/	/	/	/	/	/	/
Triton X-100	/	/	/	/	/	/	/
Dielectric Parameters Target Value	$\epsilon=41.5$ $\sigma=0.90$	$\epsilon=40.08$ $\sigma=1.37$	$\epsilon=40.0$ $\sigma=1.40$	$\epsilon=39.20$ $\sigma=1.80$	$\epsilon=39.01$ $\sigma=1.96$	$\epsilon=35.99$ $\sigma=4.66$	$\epsilon=35.30$ $\sigma=5.27$

**Note: There is a little adjustment respectively for 750, 5300 and 5600, based on the recipe of closest frequency in table E.1**

## ANNEX F: System Validation

The SAR system must be validated against its performance specifications before it is deployed. When SAR probes, system components or software are changed, upgraded or recalibrated, these must be validated with the SAR system(s) that operates with such components.

**Table F.1: System Validation**

Probe SN.	Liquid name (MHz)	Validation date	Frequency point	CW Validation	Modulation Signal Validation		
					Modulation Type	Duty Factor	PAR
7621	Head 750	2022-05-09	750MHz	Pass	N/A	N/A	N/A
7621	Head 835	2022-05-09	835MHz	Pass	GMSK	Pass	N/A
7621	Head 1750	2022-05-09	1750MHz	Pass	N/A	N/A	N/A
7621	Head 1900	2022-05-09	1900MHz	Pass	GMSK	Pass	N/A
7621	Head 2450	2022-05-08	2450MHz	Pass	OFDM/TDD	Pass	Pass
7621	Head 2550	2022-05-08	2550MHz	Pass	TDD	Pass	N/A
7621	Head 3500	2022-05-10	3500MHz	Pass	TDD	Pass	N/A
7621	Head 3700	2022-05-10	3700MHz	Pass	TDD	Pass	N/A
7621	Head 3900	2022-05-10	3900MHz	Pass	TDD	Pass	N/A
7621	Head 5250	2022-05-08	5250MHz	Pass	OFDM	N/A	Pass
7621	Head 5600	2022-05-08	5600MHz	Pass	OFDM	N/A	Pass
7621	Head 5750	2022-05-08	5750MHz	Pass	OFDM	N/A	Pass



### ANNEX G: DAE Calibration Certificate

Calibration Laboratory of  
Schmid & Partner  
Engineering AG  
Zeughausstrasse 43, 8004 Zurich, Switzerland



S Schweizerischer Kalibrierdienst  
S Service suisse d'étalonnage  
S Servizio svizzero di taratura  
S Swiss Calibration Service

Accredited by the Swiss Accreditation Service (SAS)  
The Swiss Accreditation Service is one of the signatories to the EA  
Multilateral Agreement for the recognition of calibration certificates

Accreditation No.: SCS 0108

Client **Saict-SZ (Auden)**

Certificate No: **DAE4-1527\_Jun22**

CALIBRATION CERTIFICATE																							
Object	DAE4 - SD 000 D04 BM - SN: 1527																						
Calibration procedure(s)	QA CAL-06.V30 Calibration procedure for the data acquisition electronics (DAE)																						
Calibration date:	June 21, 2022																						
<p>This calibration certificate documents the traceability to national standards, which realize the physical units of measurements (SI). The measurements and the uncertainties with confidence probability are given on the following pages and are part of the certificate.</p> <p>All calibrations have been conducted in the closed laboratory facility: environment temperature (22 ± 3)°C and humidity &lt; 70%.</p> <p>Calibration Equipment used (M&amp;TE critical for calibration)</p> <table border="1"> <thead> <tr> <th>Primary Standards</th> <th>ID #</th> <th>Cal Date (Certificate No.)</th> <th>Scheduled Calibration</th> </tr> </thead> <tbody> <tr> <td>Keithley Multimeter Type 2001</td> <td>SN: 6810278</td> <td>31-Aug-21 (No:31366)</td> <td>Aug-22</td> </tr> <tr> <th>Secondary Standards</th> <th>ID #</th> <th>Check Date (in house)</th> <th>Scheduled Check</th> </tr> <tr> <td>Auto DAE Calibration Unit</td> <td>SE UWS 053 AA 1001</td> <td>24-Jan-22 (in house check)</td> <td>In house check: Jan-23</td> </tr> <tr> <td>Calibrator Box V2.1</td> <td>SE UMS 056 AA 1002</td> <td>24-Jan-22 (in house check)</td> <td>In house check: Jan-23</td> </tr> </tbody> </table>				Primary Standards	ID #	Cal Date (Certificate No.)	Scheduled Calibration	Keithley Multimeter Type 2001	SN: 6810278	31-Aug-21 (No:31366)	Aug-22	Secondary Standards	ID #	Check Date (in house)	Scheduled Check	Auto DAE Calibration Unit	SE UWS 053 AA 1001	24-Jan-22 (in house check)	In house check: Jan-23	Calibrator Box V2.1	SE UMS 056 AA 1002	24-Jan-22 (in house check)	In house check: Jan-23
Primary Standards	ID #	Cal Date (Certificate No.)	Scheduled Calibration																				
Keithley Multimeter Type 2001	SN: 6810278	31-Aug-21 (No:31366)	Aug-22																				
Secondary Standards	ID #	Check Date (in house)	Scheduled Check																				
Auto DAE Calibration Unit	SE UWS 053 AA 1001	24-Jan-22 (in house check)	In house check: Jan-23																				
Calibrator Box V2.1	SE UMS 056 AA 1002	24-Jan-22 (in house check)	In house check: Jan-23																				
Calibrated by:	Name Adrian Gehring	Function Laboratory Technician	Signature 																				
Approved by:	Sven Kühn	Technical Manager																					
			Issued: June 21, 2022																				
This calibration certificate shall not be reproduced except in full without written approval of the laboratory.																							

**Calibration Laboratory of**  
Schmid & Partner  
Engineering AG  
Zeughausstrasse 43, 8004 Zurich, Switzerland



**S** Schweizerischer Kalibrierdienst  
**C** Service suisse d'étalonnage  
**S** Servizio svizzero di taratura  
**S** Swiss Calibration Service

Accredited by the Swiss Accreditation Service (SAS)  
The Swiss Accreditation Service is one of the signatories to the EA  
Multilateral Agreement for the recognition of calibration certificates

Accreditation No.: **SCS 0108**

### Glossary

**DAE** data acquisition electronics  
**Connector angle** information used in DASY system to align probe sensor X to the robot coordinate system.

### Methods Applied and Interpretation of Parameters

- **DC Voltage Measurement:** Calibration Factor assessed for use in DASY system by comparison with a calibrated instrument traceable to national standards. The figure given corresponds to the full scale range of the voltmeter in the respective range.
- **Connector angle:** The angle of the connector is assessed measuring the angle mechanically by a tool inserted. Uncertainty is not required.
- The following parameters as documented in the Appendix contain technical information as a result from the performance test and require no uncertainty.
  - **DC Voltage Measurement Linearity:** Verification of the Linearity at +10% and -10% of the nominal calibration voltage. Influence of offset voltage is included in this measurement.
  - **Common mode sensitivity:** Influence of a positive or negative common mode voltage on the differential measurement.
  - **Channel separation:** Influence of a voltage on the neighbor channels not subject to an input voltage.
  - **AD Converter Values with inputs shorted:** Values on the internal AD converter corresponding to zero input voltage
  - **Input Offset Measurement:** Output voltage and statistical results over a large number of zero voltage measurements.
  - **Input Offset Current:** Typical value for information; Maximum channel input offset current, not considering the input resistance.
  - **Input resistance:** Typical value for information: DAE input resistance at the connector, during internal auto-zeroing and during measurement.
  - **Low Battery Alarm Voltage:** Typical value for information. Below this voltage, a battery alarm signal is generated.
  - **Power consumption:** Typical value for information. Supply currents in various operating modes.





**DC Voltage Measurement**

A/D - Converter Resolution nominal

High Range: 1LSB = 6.1 $\mu$ V, full range = -100...+300 mV  
Low Range: 1LSB = 61nV, full range = -1.....+3mV

DASY measurement parameters: Auto Zero Time: 3 sec; Measuring time: 3 sec

Calibration Factors	X	Y	Z
High Range	403.865 $\pm$ 0.02% (k=2)	403.595 $\pm$ 0.02% (k=2)	403.805 $\pm$ 0.02% (k=2)
Low Range	3.95898 $\pm$ 1.50% (k=2)	3.98939 $\pm$ 1.50% (k=2)	3.96763 $\pm$ 1.50% (k=2)

**Connector Angle**

Connector Angle to be used in DASY system	61.0 $^{\circ}$ $\pm$ 1 $^{\circ}$
---	------------------------------------

**Appendix (Additional assessments outside the scope of SCS0108)**
**1. DC Voltage Linearity**

High Range	Reading ( $\mu\text{V}$ )	Difference ( $\mu\text{V}$ )	Error (%)
Channel X + Input	200037.59	1.98	0.00
Channel X + Input	20007.61	1.34	0.01
Channel X - Input	-20004.09	1.79	-0.01
Channel Y + Input	200037.45	1.53	0.00
Channel Y + Input	20002.68	-3.42	-0.02
Channel Y - Input	-20007.17	-1.14	0.01
Channel Z + Input	200037.73	2.17	0.00
Channel Z + Input	20005.72	-0.34	-0.00
Channel Z - Input	-20006.63	-0.49	0.00

Low Range	Reading ( $\mu\text{V}$ )	Difference ( $\mu\text{V}$ )	Error (%)
Channel X + Input	2001.36	-0.15	-0.01
Channel X + Input	201.70	0.16	0.08
Channel X - Input	-198.10	0.49	-0.24
Channel Y + Input	2001.44	0.07	0.00
Channel Y + Input	201.07	-0.21	-0.11
Channel Y - Input	-199.86	-0.98	0.50
Channel Z + Input	2001.52	0.21	0.01
Channel Z + Input	200.81	-0.41	-0.20
Channel Z - Input	-199.00	-0.15	0.07

**2. Common mode sensitivity**

DASYS measurement parameters: Auto Zero Time: 3 sec; Measuring time: 3 sec

	Common mode Input Voltage (mV)	High Range Average Reading ( $\mu\text{V}$ )	Low Range Average Reading ( $\mu\text{V}$ )
Channel X	200	-3.95	-5.31
	-200	5.96	4.97
Channel Y	200	-16.18	-16.25
	-200	14.41	14.34
Channel Z	200	3.01	2.86
	-200	-3.93	-4.13

**3. Channel separation**

DASYS measurement parameters: Auto Zero Time: 3 sec; Measuring time: 3 sec

	Input Voltage (mV)	Channel X ( $\mu\text{V}$ )	Channel Y ( $\mu\text{V}$ )	Channel Z ( $\mu\text{V}$ )
Channel X	200	-	-0.68	-2.76
Channel Y	200	5.43	-	-0.31
Channel Z	200	10.73	3.29	-

**4. AD-Converter Values with inputs shorted**

DASY measurement parameters: Auto Zero Time: 3 sec; Measuring time: 3 sec

	High Range (LSB)	Low Range (LSB)
Channel X	16059	17078
Channel Y	15965	16219
Channel Z	15888	13556

**5. Input Offset Measurement**

DASY measurement parameters: Auto Zero Time: 3 sec; Measuring time: 3 sec

Input 10M $\Omega$

	Average ( $\mu$ V)	min. Offset ( $\mu$ V)	max. Offset ( $\mu$ V)	Std. Deviation ( $\mu$ V)
Channel X	1.40	0.30	2.25	0.35
Channel Y	-0.62	-1.30	0.47	0.33
Channel Z	-0.18	-0.90	0.60	0.31

**6. Input Offset Current**

Nominal input circuitry offset current on all channels: <25fA

**7. Input Resistance** (Typical values for information)

	Zeroing (kOhm)	Measuring (MOhm)
Channel X	200	200
Channel Y	200	200
Channel Z	200	200

**8. Low Battery Alarm Voltage** (Typical values for information)

Typical values	Alarm Level (VDC)
Supply (+ Vcc)	+7.9
Supply (- Vcc)	-7.6

**9. Power Consumption** (Typical values for information)

Typical values	Switched off (mA)	Stand by (mA)	Transmitting (mA)
Supply (+ Vcc)	+0.01	+6	+14
Supply (- Vcc)	-0.01	-8	-9



### ANNEX H: Probe Calibration Certificate



In Collaboration with  
**s p e a g**  
CALIBRATION LABORATORY

Add: No.52 HuaYuanBei Road, Haidian District, Beijing, 100191, China  
Tel: +86-10-62304633-2117  
E-mail: cttl@chinattl.com    http://www.caict.ac.cn



中国认可  
国际互认  
校准  
CALIBRATION  
CNAS L0570

**CAICT**

Client **SAICT**
Certificate No: **Z22-60124**

**CALIBRATION CERTIFICATE**

Object: EX3DV4 - SN : 7621

Calibration Procedure(s): FF-Z11-004-02  
Calibration Procedures for Dosimetric E-field Probes

Calibration date: May 06, 2022

This calibration Certificate documents the traceability to national standards, which realize the physical units of measurements(SI). The measurements and the uncertainties with confidence probability are given on the following pages and are part of the certificate.

All calibrations have been conducted in the closed laboratory facility: environment temperature(22±3)°C and humidity<70%.

Calibration Equipment used (M&TE critical for calibration)

Primary Standards	ID #	Cal Date(Calibrated by, Certificate No.)	Scheduled Calibration
Power Meter NRP2	101919	15-Jun-21(CTTL, No.J21X04466)	Jun-22
Power sensor NRP-Z91	101547	15-Jun-21(CTTL, No.J21X04466)	Jun-22
Power sensor NRP-Z91	101548	15-Jun-21(CTTL, No.J21X04466)	Jun-22
Reference 10dBAttenuator	18N50W-10dB	20-Jan-21(CTTL, No.J21X00486)	Jan-23
Reference 20dBAttenuator	18N50W-20dB	20-Jan-21(CTTL, No.J21X00485)	Jan-23
Reference Probe EX3DV4	SN 7464	26-Jan-22(SPEAG, No.EX3-7464_Jan22)	Jan-23
DAE4	SN 1555	20-Aug-21(SPEAG, No.DAE4-1555_Aug21/2)	Aug-22

Secondary Standards	ID #	Cal Date(Calibrated by, Certificate No.)	Scheduled Calibration
SignalGenerator MG3700A	6201052605	16-Jun-21(CTTL, No.J21X04467)	Jun-22
Network Analyzer E5071C	MY46110673	14-Jan-22(CTTL, No.J22X00406)	Jan-23

	Name	Function	Signature
Calibrated by:	Yu Zongying	SAR Test Engineer	
Reviewed by:	Lin Hao	SAR Test Engineer	
Approved by:	Qi Dianyuan	SAR Project Leader	

Issued: May 23, 2022

This calibration certificate shall not be reproduced except in full without written approval of the laboratory.



Add: No.52 HuaYuanBei Road, Haidian District, Beijing, 100191, China  
Tel: +86-10-62304633-2117  
E-mail: [ctl@chinattl.com](mailto:ctl@chinattl.com) <http://www.caict.ac.cn>

#### Glossary:

TSL	tissue simulating liquid
NORM <sub>x,y,z</sub>	sensitivity in free space
ConvF	sensitivity in TSL / NORM <sub>x,y,z</sub>
DCP	diode compression point
CF	crest factor (1/duty_cycle) of the RF signal
A,B,C,D	modulation dependent linearization parameters
Polarization $\Phi$	$\Phi$ rotation around probe axis
Polarization $\theta$	$\theta$ rotation around an axis that is in the plane normal to probe axis (at measurement center), $\theta=0$ is normal to probe axis

Connector Angle: information used in DASY system to align probe sensor X to the robot coordinate system

#### Calibration is performed according to the following standards:

- IEEE Std 1528-2013, "IEEE Recommended Practice for Determining the Peak Spatial-Averaged Specific Absorption Rate (SAR) in the Human Head from Wireless Communications Devices: Measurement Techniques", June 2013
- IEC 62209-1, "Measurement procedure for the assessment of Specific Absorption Rate (SAR) from hand-held and body-mounted devices used next to the ear (frequency range of 300 MHz to 6 GHz)", July 2016
- IEC 62209-2, "Procedure to determine the Specific Absorption Rate (SAR) for wireless communication devices used in close proximity to the human body (frequency range of 30 MHz to 6 GHz)", March 2010
- KDB 865664, "SAR Measurement Requirements for 100 MHz to 6 GHz"

#### Methods Applied and Interpretation of Parameters:

- NORM<sub>x,y,z</sub>**: Assessed for E-field polarization  $\theta=0$  ( $f \leq 900$  MHz in TEM-cell;  $f > 1800$  MHz: waveguide). NORM<sub>x,y,z</sub> are only intermediate values, i.e., the uncertainties of NORM<sub>x,y,z</sub> does not effect the  $E^2$ -field uncertainty inside TSL (see below ConvF).
- NORM(f)<sub>x,y,z</sub> = NORM<sub>x,y,z</sub> \* frequency\_response** (see Frequency Response Chart). This linearization is implemented in DASY4 software versions later than 4.2. The uncertainty of the frequency response is included in the stated uncertainty of ConvF.
- DCP<sub>x,y,z</sub>**: DCP are numerical linearization parameters assessed based on the data of power sweep (no uncertainty required). DCP does not depend on frequency nor media.
- PAR**: PAR is the Peak to Average Ratio that is not calibrated but determined based on the signal characteristics.
- A<sub>x,y,z</sub>; B<sub>x,y,z</sub>; C<sub>x,y,z</sub>; VR<sub>x,y,z</sub>; A,B,C** are numerical linearization parameters assessed based on the data of power sweep for specific modulation signal. The parameters do not depend on frequency nor media. VR is the maximum calibration range expressed in RMS voltage across the diode.
- ConvF and Boundary Effect Parameters**: Assessed in flat phantom using E-field (or Temperature Transfer Standard for  $f \leq 800$  MHz) and inside waveguide using analytical field distributions based on power measurements for  $f > 800$  MHz. The same setups are used for assessment of the parameters applied for boundary compensation (alpha, depth) of which typical uncertainty valued are given. These parameters are used in DASY4 software to improve probe accuracy close to the boundary. The sensitivity in TSL corresponds to NORM<sub>x,y,z</sub> \* ConvF whereby the uncertainty corresponds to that given for ConvF. A frequency dependent ConvF is used in DASY version 4.4 and higher which allows extending the validity from  $\pm 50$  MHz to  $\pm 100$  MHz.
- Spherical isotropy (3D deviation from isotropy)**: in a field of low gradients realized using a flat phantom exposed by a patch antenna.
- Sensor Offset**: The sensor offset corresponds to the offset of virtual measurement center from the probe tip (on probe axis). No tolerance required.
- Connector Angle**: The angle is assessed using the information gained by determining the NORM<sub>x</sub> (no uncertainty required).



Add: No.52 HuaYuanBei Road, Haidian District, Beijing, 100191, China  
Tel: +86-10-62304633-2117  
E-mail: ttl@chinatitl.com http://www.caict.ac.cn

### DASY/EASY – Parameters of Probe: EX3DV4 – SN:7621

#### Basic Calibration Parameters

	Sensor X	Sensor Y	Sensor Z	Unc (k=2)
Norm( $\mu\text{V}/(\text{V}/\text{m})^2$ ) <sup>A</sup>	0.71	0.71	0.56	$\pm 10.0\%$
DCP(mV) <sup>B</sup>	111.7	111.8	115.7	

#### Modulation Calibration Parameters

UID	Communication System Name		A dB	B dB· $\mu\text{V}$	C	D dB	VR mV	Unc <sup>E</sup> (k=2)
0	CW	X	0.0	0.0	1.0	0.00	210.8	$\pm 3.5\%$
		Y	0.0	0.0	1.0		218.6	
		Z	0.0	0.0	1.0		190.8	

The reported uncertainty of measurement is stated as the standard uncertainty of Measurement multiplied by the coverage factor  $k=2$ , which for a normal distribution corresponds to a coverage probability of approximately 95%.

<sup>A</sup> The uncertainties of Norm X, Y, Z do not affect the E<sup>2</sup>-field uncertainty inside TSL (see Page 4).  
<sup>B</sup> Numerical linearization parameter: uncertainty not required.  
<sup>E</sup> Uncertainty is determined using the max. deviation from linear response applying rectangular distribution and is expressed for the square of the field value.



Add: No.52 HuaYuanBei Road, Haidian District, Beijing, 100191, China  
 Tel: +86-10-62304633-2117  
 E-mail: cttl@chinattl.com http://www.caict.ac.cn

## DASY/EASY – Parameters of Probe: EX3DV4 – SN:7621

### Calibration Parameter Determined in Head Tissue Simulating Media

f [MHz] <sup>C</sup>	Relative Permittivity <sup>F</sup>	Conductivity (S/m) <sup>F</sup>	ConvF X	ConvF Y	ConvF Z	Alpha <sup>G</sup>	Depth <sup>G</sup> (mm)	Unct. (k=2)
750	41.9	0.89	11.12	11.12	11.12	0.18	1.14	±12.1%
900	41.5	0.97	10.68	10.68	10.68	0.14	1.14	±12.1%
1450	40.5	1.20	9.65	9.65	9.65	0.21	0.91	±12.1%
1750	40.1	1.37	9.22	9.22	9.22	0.31	0.90	±12.1%
1900	40.0	1.40	8.90	8.90	8.90	0.35	0.84	±12.1%
2100	39.8	1.49	8.95	8.95	8.95	0.23	1.13	±12.1%
2300	39.5	1.67	8.60	8.60	8.60	0.44	0.78	±12.1%
2450	39.2	1.80	8.17	8.17	8.17	0.49	0.78	±12.1%
2600	39.0	1.96	7.93	7.93	7.93	0.51	0.75	±12.1%
3300	38.2	2.71	7.74	7.74	7.74	0.45	0.92	±13.3%
3500	37.9	2.91	7.56	7.56	7.56	0.44	1.00	±13.3%
3700	37.7	3.12	7.18	7.18	7.18	0.38	1.05	±13.3%
3900	37.5	3.32	7.26	7.26	7.26	0.35	1.35	±13.3%
4100	37.2	3.53	7.21	7.21	7.21	0.25	1.30	±13.3%
4400	36.9	3.84	7.01	7.01	7.01	0.25	1.55	±13.3%
4600	36.7	4.04	6.90	6.90	6.90	0.30	1.72	±13.3%
4800	36.4	4.25	6.79	6.79	6.79	0.30	1.85	±13.3%
4950	36.3	4.40	6.44	6.44	6.44	0.30	1.80	±13.3%
5250	35.9	4.71	5.98	5.98	5.98	0.35	1.63	±13.3%
5600	35.5	5.07	5.47	5.47	5.47	0.40	1.55	±13.3%
5750	35.4	5.22	5.40	5.40	5.40	0.40	1.55	±13.3%

<sup>C</sup> Frequency validity above 300 MHz of ±100MHz only applies for DASY v4.4 and higher (Page 2), else it is restricted to ±50MHz. The uncertainty is the RSS of ConvF uncertainty at calibration frequency and the uncertainty for the indicated frequency band. Frequency validity below 300 MHz is ± 10, 25, 40, 50 and 70 MHz for ConvF assessments at 30, 64, 128, 150 and 220 MHz respectively. Above 5 GHz frequency validity can be extended to ± 110 MHz.

<sup>F</sup> At frequency below 3 GHz, the validity of tissue parameters ( $\epsilon$  and  $\sigma$ ) can be relaxed to ±10% if liquid compensation formula is applied to measured SAR values. At frequencies above 3 GHz, the validity of tissue parameters ( $\epsilon$  and  $\sigma$ ) is restricted to ±5%. The uncertainty is the RSS of the ConvF uncertainty for indicated target tissue parameters.

<sup>G</sup> Alpha/Depth are determined during calibration. SPEAG warrants that the remaining deviation due to the boundary effect after compensation is always less than ± 1% for frequencies below 3 GHz and below ± 2% for the frequencies between 3-6 GHz at any distance larger than half the probe tip diameter from the boundary.



Add: No.52 HuaYuanBei Road, Haidian District, Beijing, 100191, China  
Tel: +86-10-62304633-2117  
E-mail: cttl@chinattl.com      <http://www.caict.ac.cn>

### Frequency Response of E-Field (TEM-Cell: ifi110 EXX, Waveguide: R22)

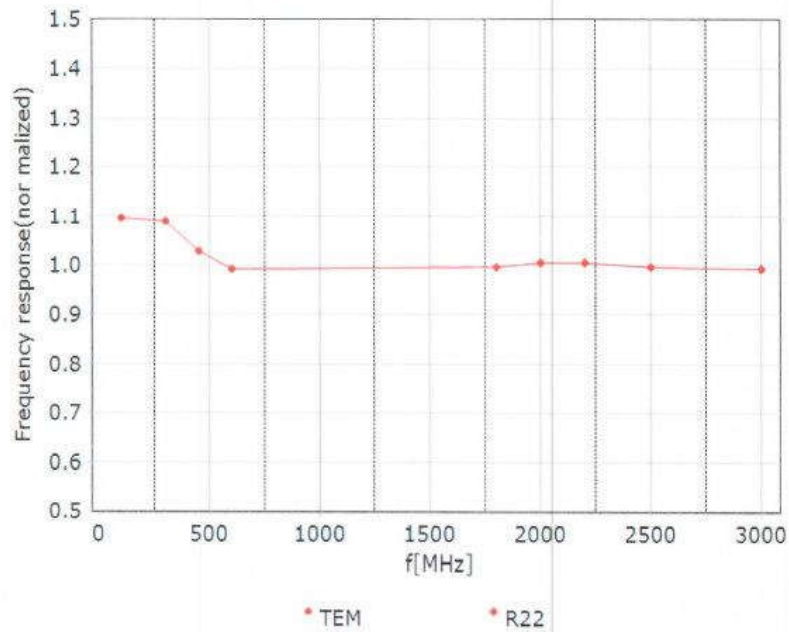

Uncertainty of Frequency Response of E-field:  $\pm 7.4\%$  ( $k=2$ )





Add: No.52 HuaYuanBei Road, Haidian District, Beijing, 100191, China  
Tel: +86-10-62304633-2117  
E-mail: cttl@chinattl.com http://www.caict.ac.cn

### Receiving Pattern ( $\Phi$ ), $\theta=0^\circ$

f=600 MHz, TEM

f=1800 MHz, R22

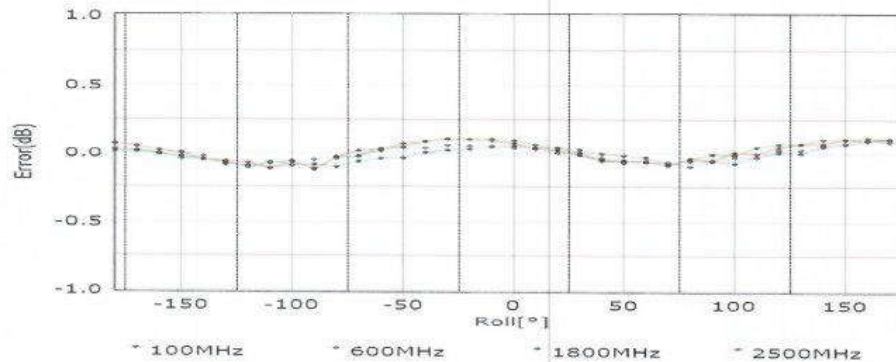
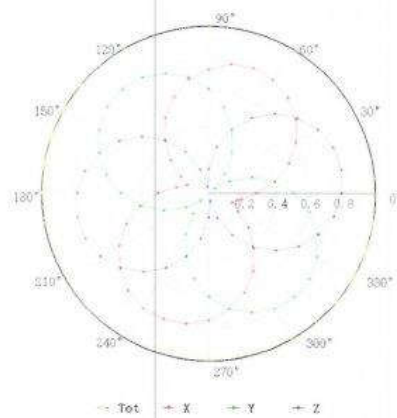
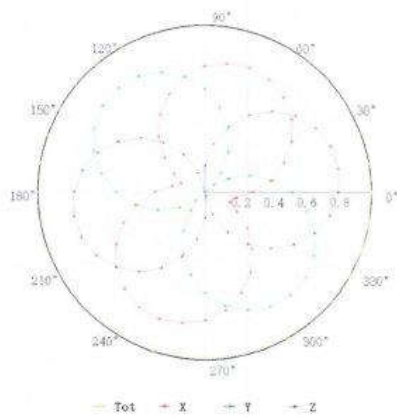

Uncertainty of Axial Isotropy Assessment:  $\pm 1.2\%$  ( $k=2$ )

### Dynamic Range f(SAR<sub>head</sub>) (TEM cell, f = 900 MHz)

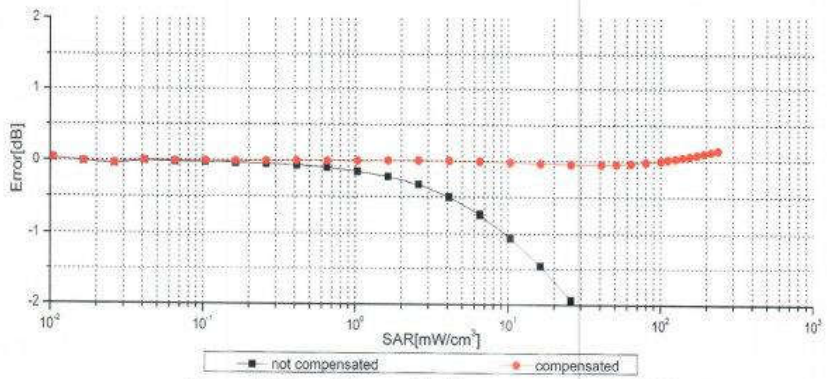
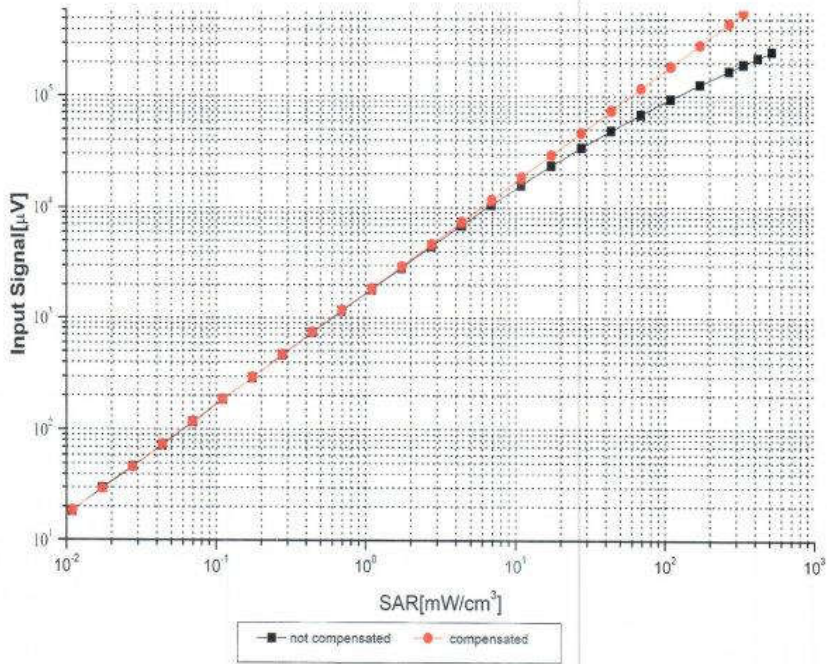

Uncertainty of Linearity Assessment: ±0.9% (k=2)



Add: No.52 HuaYuanBei Road, Haidian District, Beijing, 100191, China  
Tel: +86-10-62304633-2117  
E-mail: cttl@chinattl.com http://www.caict.ac.cn

### Conversion Factor Assessment

f=750 MHz,WGLS R9(H\_convF)

f=1750 MHz,WGLS R22(H\_convF)

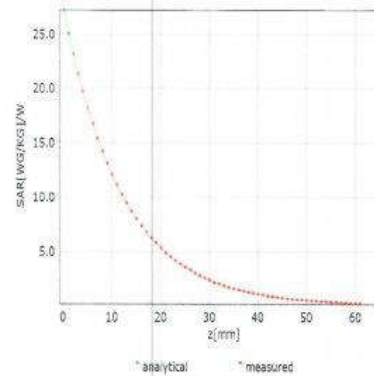
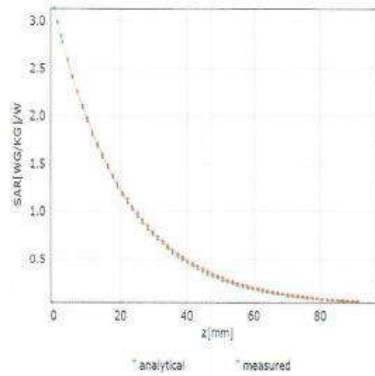

### Deviation from Isotropy in Liquid

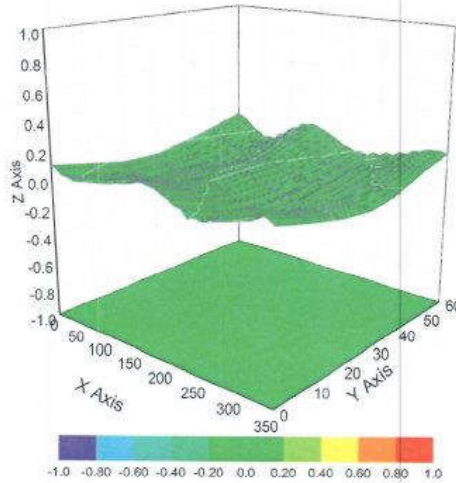

Uncertainty of Spherical Isotropy Assessment:  $\pm 3.2\%$  ( $k=2$ )

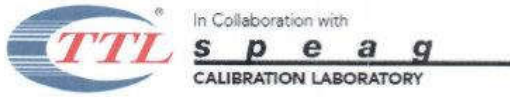

Add: No.52 HuaYuanBei Road, Haidian District, Beijing, 100191, China  
Tel: +86-10-62304633-2117  
E-mail: cttl@chinattl.com      <http://www.caict.ac.cn>

### DASY/EASY – Parameters of Probe: EX3DV4 – SN:7621

#### Other Probe Parameters

Sensor Arrangement	Triangular
Connector Angle (°)	95.4
Mechanical Surface Detection Mode	enabled
Optical Surface Detection Mode	disable
Probe Overall Length	337mm
Probe Body Diameter	10mm
Tip Length	9mm
Tip Diameter	2.5mm
Probe Tip to Sensor X Calibration Point	1mm
Probe Tip to Sensor Y Calibration Point	1mm
Probe Tip to Sensor Z Calibration Point	1mm
Recommended Measurement Distance from Surface	1.4mm



# ANNEX I: Dipole Calibration Certificate

## 750MHz Dipole



Add: No.52 HuaYuanBei Road, Haidian District, Beijing, 100191  
Tel: +86-10-62304633-2117  
E-mail: emf@caict.ac.cn http://www.caict.ac.cn



Client SAICT

Certificate No: Z22-60333

CALIBRATION CERTIFICATE			
Object	D750V3 - SN: 1163		
Calibration Procedure(s)	FF-Z11-003-01 Calibration Procedures for dipole validation kits		
Calibration date:	August 22, 2022		
<p>This calibration Certificate documents the traceability to national standards, which realize the physical units of measurements (SI). The measurements and the uncertainties with confidence probability are given on the following pages and are part of the certificate.</p> <p>All calibrations have been conducted in the closed laboratory facility: environment temperature (22±3)°C and humidity&lt;70%.</p> <p>Calibration Equipment used (M&amp;TE critical for calibration)</p>			
Primary Standards	ID #	Cal Date (Calibrated by, Certificate No.)	Scheduled Calibration
Power Meter NRP2	106277	24-Sep-21 (CTTL, No.J21X08326)	Sep-22
Power sensor NRP8S	104291	24-Sep-21 (CTTL, No.J21X08326)	Sep-22
Reference Probe EX3DV4	SN 7464	26-Jan-22(SPEAG,No.EX3-7464_Jan22)	Jan-23
DAE4	SN 1556	12-Jan-22(CTTL-SPEAG,No.Z22-60007)	Jan-23
Secondary Standards	ID #	Cal Date (Calibrated by, Certificate No.)	Scheduled Calibration
Signal Generator E4438C	MY49071430	13-Jan-22 (CTTL, No.J22X00409)	Jan-23
Network Analyzer E5071C	MY46110673	14-Jan-22 (CTTL, No.J22X00406)	Jan-23
Calibrated by:	Name Zhao Jing	Function SAR Test Engineer	Signature 
Reviewed by:	Name Lin Hao	Function SAR Test Engineer	Signature 
Approved by:	Name Qi Dianyuan	Function SAR Project Leader	Signature 
Issued: August 26, 2022			
This calibration certificate shall not be reproduced except in full without written approval of the laboratory.			



Add: No.52 HuaYuanBei Road, Haidian District, Beijing, 100191, China  
Tel: +86-10-62304633-2117  
E-mail: emf@caict.ac.cn http://www.caict.ac.cn

**Glossary:**

TSL	tissue simulating liquid
ConvF	sensitivity in TSL / NORM <sub>x,y,z</sub>
N/A	not applicable or not measured

**Calibration is Performed According to the Following Standards:**

- a) IEC/IEEE 62209-1528, "Measurement Procedure for The Assessment of Specific Absorption Rate of Human Exposure to Radio Frequency Fields from Hand-held and Body-mounted Wireless Communication Devices- Part 1528: Human Models, Instrumentation and Procedures (Frequency range of 4 MHz to 10 GHz)", October 2020
- b) KDB 865664, "SAR Measurement Requirements for 100 MHz to 6 GHz"

**Additional Documentation:**

- c) DASy4/5 System Handbook

**Methods Applied and Interpretation of Parameters:**

- *Measurement Conditions:* Further details are available from the Validation Report at the end of the certificate. All figures stated in the certificate are valid at the frequency indicated.
- *Antenna Parameters with TSL:* The dipole is mounted with the spacer to position its feed point exactly below the center marking of the flat phantom section, with the arms oriented parallel to the body axis.
- *Feed Point Impedance and Return Loss:* These parameters are measured with the dipole positioned under the liquid filled phantom. The impedance stated is transformed from the measurement at the SMA connector to the feed point. The Return Loss ensures low reflected power. No uncertainty required.
- *Electrical Delay:* One-way delay between the SMA connector and the antenna feed point. No uncertainty required.
- *SAR measured:* SAR measured at the stated antenna input power.
- *SAR normalized:* SAR as measured, normalized to an input power of 1 W at the antenna connector.
- *SAR for nominal TSL parameters:* The measured TSL parameters are used to calculate the nominal SAR result.

The reported uncertainty of measurement is stated as the standard uncertainty of Measurement multiplied by the coverage factor  $k=2$ , which for a normal distribution Corresponds to a coverage probability of approximately 95%.



Add: No.52 HuaYuanBei Road, Haidian District, Beijing, 100191, China  
 Tel: +86-10-62304633-2117  
 E-mail: emfi@caict.ac.cn http://www.caict.ac.cn

### Measurement Conditions

DASY system configuration, as far as not given on page 1.

DASY Version	DASY52	V52.10.4
Extrapolation	Advanced Extrapolation	
Phantom	Triple Flat Phantom 5.1C	
Distance Dipole Center - TSL	15 mm	with Spacer
Zoom Scan Resolution	dx, dy, dz = 5 mm	
Frequency	750 MHz $\pm$ 1 MHz	

### Head TSL parameters

The following parameters and calculations were applied.

	Temperature	Permittivity	Conductivity
Nominal Head TSL parameters	22.0 °C	42.0	0.90 mho/m
Measured Head TSL parameters	(22.0 $\pm$ 0.2) °C	41.3 $\pm$ 6 %	0.90 mho/m $\pm$ 6 %
Head TSL temperature change during test	<1.0 °C	---	---

### SAR result with Head TSL

SAR averaged over 1 cm <sup>3</sup> (1 g) of Head TSL	Condition	
SAR measured	250 mW input power	2.15 W/kg
SAR for nominal Head TSL parameters	normalized to 1W	<b>8.48 W/kg <math>\pm</math> 18.8 % (k=2)</b>
SAR averaged over 10 cm <sup>3</sup> (10 g) of Head TSL	Condition	
SAR measured	250 mW input power	1.42 W/kg
SAR for nominal Head TSL parameters	normalized to 1W	<b>5.62 W/kg <math>\pm</math> 18.7 % (k=2)</b>