FCC PART 90S TEST REPORT

Report Number	BWTR-2105-NAPCE
FCC ID	2ADOBHLTE233E
Applicant	Hisense International Co., Ltd.
Product Name	Mobile Phone
Marketing Name	Hisense H50 Lite
Brand Name	Hisense
Model Name	HLTE233E
Serial Number	No.1 (1 st Source): 860598050001603 No.2 (2 nd Source): 860598050000381
Test Standard	FCC 47 CFR Part 90 Subpart S
Tested Date	Jan. 28, 2021 - Feb. 09, 2021

CONTENTS

1	Summary of Test Result	4
2	General Information	5
2.1	Applicant.....	5
2.2	Manufacturer	5
2.3	Product Feature of Equipment Under Test	5
2.4	Ancillary Equipment.....	5
2.5	Description of Test Modes	6
2.6	Applicable Standards	7
2.7	Test Facilities.....	7
3	Test Result	8
3.1	RF Output Power and Effective Radiated Power	8
3.2	Peak to Average Power Ratio (PAPR).....	14
3.3	Occupied Bandwidth	25
3.4	Spurious Emission at Antenna Terminal.....	37
3.5	Field Strength of Spurious Radiation.....	38
3.6	Band Edge	41
3.7	Frequency Stability.....	45
4	Test Instruments	47

Revision History

Revision	Description	Issued Date
A	Initial issue of report	2021/02/19

1 Summary of Test Result

Report Section	FCC Section	Description	Result
3.1	90.635 (b)	RF Output Power and Effective Radiated Power	Pass
3.2	KDB 971168 D01 - 5.7	Peak to Average Power Ratio (PAPR)	Pass
3.3	90.209 (a)	Occupied Bandwidth	Pass
3.4	90.691	Spurious Emission at Antenna Terminal	Pass
3.5	90.691	Field Strength of Spurious Radiation	Pass
3.6	90.691	Band Edge	Pass
3.7	90.213	Frequency Stability	Pass

We, Beijing Boomwave Test Service Co. Ltd., would like to declare that the tested sample has been evaluated and in compliance with the requirements of applicable standards.

Prepared by:  2021.02.19
13:10:50 +08'00'

Reviewed by:  2021.02.19
14:10:15 +08'00'

Approved by:  2021.02.19
20:02:50 +08'00'

Rationale:

The test results in this report apply exclusively to the tested model / sample.

The electrical copy of test report is invalid without the signatures. The hard copy is invalid without seal.

The test report shall not be modified, republished or copied without the written authorization of the laboratory.

2 General Information

2.1 Applicant

Hisense International Co., Ltd.
Floor 22, Hisense Tower, 17 Donghai Xi Road, Qingdao, 266071, China

2.2 Manufacturer

Hisense Communications Co., Ltd.
218 Qianwangang Road, Qingdao Economic & Technological Development Zone, Qingdao, China

2.3 Product Feature of Equipment Under Test

Product Name	Mobile Phone
Marketing Name	Hisense H50 Lite
Model Name	HLTE233E
Sample Status	Production
Operating Frequency Range	814MHz~824MHz
Type of Wireless Technology	FDD LTE - Band 26
Modulation Type	QPSK, 16QAM, 64QAM
Channel Bandwidth	1.4MHz, 3MHz, 5MHz, 10MHz
Antenna Type	Internal Antenna
Antenna Gain	-0.94dBi
Extreme Operating Temperature	Minimum: -30°C
	Maximum: +50°C
Power Supply	Normal Voltage: 3.80V
	Lowest Voltage: 3.50V
	Highest Voltage: 4.35V
Hardware Version	FS185-MB-V0.2
Software Version	Hisense_HLTE233E_10_S01_01_02_MX05_debug_KS 233C_0003853_20210115_1121
Sample Received Date	2021/01/25

2.4 Ancillary Equipment

The EUT has been tested as an independent unit together with other necessary accessories or support units. The following ancillary equipment were used to form a representative test configuration during the tests.

Support Unit	Li-Lon Battery
Manufacturer	Shenzhen Aerospace Electronic Co.,Ltd.
Model Name	PLG496590
Capacity	5000mAh
Nominal Voltage	4.4V
Serial Number	---

2.5 Description of Test Modes

The EUT has two sources whose differences are LCD touch panel, camera and memory. So all tests in this test report were performed with EUT No.1 (1st Source), except for section 3.5 Field Strength of Spurious Radiation.

The EUT was linked by base station simulator to work in continuous transmitting and receiving mode. Pre-Scan has been conducted to determine the worst-case mode from all possible combinations between available modulations, bandwidth, resource block (RB) and RB offset.

Following channels were selected for test:

Channel Bandwidth	Low Channel		Mid Channel		High Channel	
	Frequency (MHz)	Channel No.	Frequency (MHz)	Channel No.	Frequency (MHz)	Channel No.
1.4MHz	814.7	26697	819.0	26740	823.3	26783
3MHz	815.5	26705	819.0	26740	822.5	26775
5MHz	816.5	26715	819.0	26740	821.5	26765
10MHz	---		819.0	26740	---	

Following modes were selected as the worst case configuration for each test:

Test Items	Channel	BW (MHz)	RB Size	RB Offset	Modulation	Antenna Orientation
RF Output Power	L\M\H	1.4	1\3\6	0\3\5\1	QPSK, 16QAM, 64QAM	N/A
		3	1\8\15	0\8\14\4\7		
		5	1\12\25	0\12\24\7\13		
		10	1\25\50	0\25\49\12		
Peak to Average Power Ratio	L\M\H	1.4	1\6	5\0	QPSK, 16QAM, 64QAM	N/A
		3	1\15	14\0		
		5	1\25	24\0		
		10	1\50	49\0		
Effective Radiated Power	L\M\H	1.4\3\5\10	1	0	QPSK, 16QAM, 64QAM	N/A
Occupied Bandwidth	L\M\H	1.4	6	0	QPSK, 16QAM, 64QAM	N/A
		3	15			
		5	25			
		10	50			
Spurious Emission at Antenna Terminal	M	10	1	0	QPSK	N/A
Field Strength of Spurious Radiation	M	10	1	0	QPSK	X axis
Band Edge	L\H	1.4	1\6	0\5	QPSK	N/A
		3	1\15	0\14		
		5	1\25	0\24		
		10	1\50	0\49		
Frequency Stability	L\H	1.4\3\5\10	1	0	QPSK	N/A

2.6 Applicable Standards

Standard	Version	Title
FCC 47 CFR Part 90 Subpart S	2019	Regulations Governing Licensing and Use of Frequencies in the 806-824, 851-869, 896-901, and 935-940 MHz Bands
ANSI C63.26	2015	American National Standard for Compliance Testing of Transmitters Used in Licensed Radio Services

2.7 Test Facilities

Company Name: Beijing Boomwave Test Service Co. Ltd

Address: EMC Building, No.1 Wang Jing East Road, Chao Yang District Beijing, P.R. China 100102

FCC Test Firm Registration Number: 613197

ISED Canada Registration No.: 24289 (CAB Identifier: CN0010)

VCCI Registration No.: R-20062, G-20063, C-20050, T-20049

Test Site	Description	Dimension	Ground Plane Size
<input type="checkbox"/> SAC10	10m semi-anechoic chamber	19.5m×12.9m×8.6m	4m×4m
<input checked="" type="checkbox"/> SAC3	3m semi-anechoic chamber	9.6m×6.4m×6.0m	9.6m×6.4m
<input type="checkbox"/> SR#1	Shielding Room for EMS test	8.1m×4.05m×2.755m	8.1m×4.05m
<input checked="" type="checkbox"/> SR#2	Shielding Room for RF test	8.1m×4.05m×2.755m	---

3 Test Result

3.1 RF Output Power and Effective Radiated Power

3.1.1. Limit

FCC 47 CFR Part 90 Subpart S - §90.635(b)

The maximum output power of the transmitter for mobile station is 100 watts (20dBw).

3.1.2. Test Setup

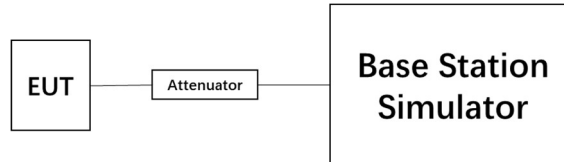

3.1.3. Test Procedures

- 1) The measurement procedure of RF output power follows ANSI C63.26-2015, clause 5.2.
- 2) The RF output of EUT and BS simulator are connected via a sufficient attenuation.
- 3) EUT is configured to transmit the maximum output power while the measurement is performed.
- 4) Then ERP is calculated following the procedure of KDB 971168 D01 – Section 5.6 as:

$$ERP = P_{Meas} + G_T - L_C$$

where:

ERP = effective radiated power, respectively (expressed in same units as P_{Meas}, typically dBW or dBm)

P_{Meas}: measured transmitter output power or PSD, in dBm or dBW

G_T: gain of the transmitting antenna, in dBd

L_C: signal attenuation in the connecting cable between the transmitter and antenna, in dB

3.1.4. Test Result

Test Engineer	Xu Dongxu	Test Date	2021/01/28
Temperature	20.8°C	Relative Humidity	47.6%
Pressure	105.1kPa	Test Sample Selected	No.1

Modulation Type	Frequency (MHz)	BW (MHz)	RB Size	RB Offset	Output Power (dBm)
QPSK	814.7	1.4	1	0	23.28
			1	3	23.26
			1	5	23.20
			3	0	22.70
			3	1	22.72
			3	3	22.70
	819.0		6	0	21.67
			1	0	23.32
			1	3	23.20
			1	5	23.33
			3	0	22.87
			3	1	22.89
	823.3		3	3	22.88
			6	0	21.88
			1	0	23.20
			1	3	23.20
			1	5	23.19
			3	0	22.75
			3	1	22.77
			3	3	22.76
			6	0	22.19

Modulation Type	Frequency (MHz)	BW (MHz)	RB Size	RB Offset	Output Power (dBm)
16QAM	814.7	1.4	1	0	22.56
			1	3	22.76
			1	5	22.63
			3	0	21.90
			3	1	21.90
			3	3	21.99
			6	0	20.99
	819.0		1	0	22.44
			1	3	22.34
			1	5	22.31
			3	0	21.58
			3	1	21.62
			3	3	21.68
			6	0	20.79
	823.3		1	0	22.27
			1	3	22.33
			1	5	22.38
			3	0	21.91
			3	1	21.88
			3	3	22.31
			6	0	21.38
64QAM	814.7	1.4	1	0	21.44
			1	3	21.38
			1	5	21.41
			3	0	21.04
			3	1	21.04
			3	3	20.96
			6	0	20.86
	819.0		1	0	21.79
			1	3	21.75
			1	5	21.98
			3	0	20.79
			3	1	20.74
			3	3	20.73
			6	0	20.69
	823.3		1	0	21.38
			1	3	21.28
			1	5	21.20
			3	0	20.98
			3	1	20.68
			3	3	20.64
			6	0	20.55

Modulation Type	Frequency (MHz)	BW (MHz)	RB Size	RB Offset	Output Power (dBm)
QPSK	815.5	3	1	0	23.27
			1	8	23.24
			1	14	23.23
			8	0	21.77
			8	4	21.74
			8	7	21.74
	15		0	21.84	
	1		0	23.26	
	1		8	23.21	
	1		14	23.25	
	8		0	21.73	
	8		4	21.79	
	8		7	21.79	
	15		0	21.77	
	1		0	23.20	
	1		8	23.21	
	1		14	23.20	
	8		0	22.14	
8	4	22.16			
8	7	22.15			
15	0	22.15			
16QAM	815.5	3	1	0	22.60
			1	8	22.54
			1	14	22.54
			8	0	21.04
			8	4	21.51
			8	7	21.51
	15		0	20.83	
	1		0	22.83	
	1		8	22.15	
	1		14	22.18	
	8		0	22.75	
	8		4	20.75	
	8		7	20.83	
	15		0	20.78	
	1		0	22.20	
	1		8	22.25	
	1		14	22.25	
	8		0	21.21	
8	4	21.23			
8	7	21.24			
15	0	21.28			
822.5	822.5	3	1	0	22.20
			1	8	22.25
			1	14	22.25
			8	0	21.21
			8	4	21.23
			8	7	21.24
15	0		21.28		

Modulation Type	Frequency (MHz)	BW (MHz)	RB Size	RB Offset	Output Power (dBm)
64QAM	815.5	3	1	0	21.84
			1	8	21.80
			1	14	21.77
			8	0	20.82
			8	4	20.77
			8	7	20.76
	15		0	20.56	
	819.0		1	0	21.79
			1	8	21.74
			1	14	21.71
			8	0	20.66
			8	4	20.68
			8	7	20.73
	822.5		15	0	20.58
			1	0	21.28
			1	8	21.34
			1	14	21.31
			8	0	20.68
8		4	20.66		
QPSK	816.5	5	8	7	20.61
			15	0	20.58
			1	0	23.26
			1	12	23.30
			1	24	23.28
			12	0	21.80
	12		7	21.72	
	819.0		12	13	21.72
			25	0	21.82
			1	0	23.29
			1	12	23.26
			1	24	23.25
			12	0	21.76
	821.5		12	7	22.12
			12	13	22.11
			25	0	21.80
			1	0	23.24
			1	12	23.13
1		24	23.11		
821.5	12	0	22.20		
	12	7	22.20		
	12	13	22.22		
	25	0	22.25		

Modulation Type	Frequency (MHz)	BW (MHz)	RB Size	RB Offset	Output Power (dBm)
16QAM	816.5	5	1	0	21.43
			1	12	21.62
			1	24	21.73
			12	0	20.68
			12	7	21.18
			12	13	21.17
			25	0	21.31
	819.0		1	0	22.30
			1	12	22.64
			1	24	22.63
			12	0	21.15
			12	7	21.26
			12	13	21.25
			25	0	20.70
	821.5		1	0	22.29
			1	12	22.53
			1	24	22.70
			12	0	21.18
			12	7	21.22
			12	13	21.23
			25	0	21.29
64QAM	816.5	1	0	21.35	
		1	12	21.32	
		1	24	21.24	
		12	0	20.34	
		12	7	20.34	
		12	13	20.36	
		25	0	20.35	
	819.0	1	0	21.70	
		1	12	21.69	
		1	24	21.68	
		12	0	20.66	
		12	7	20.65	
		12	13	20.65	
		25	0	20.65	
	821.5	1	0	21.71	
		1	12	21.71	
		1	24	21.66	
		12	0	21.62	
		12	7	21.17	
		12	13	21.20	
		25	0	21.19	

Modulation Type	Frequency (MHz)	BW (MHz)	RB Size	RB Offset	Output Power (dBm)
QPSK	819.0	10	1	0	23.23
			1	25	23.13
			1	49	23.13
			25	0	22.45
			25	12	22.65
			25	25	22.64
			50	0	22.44
16QAM	819.0	10	1	0	22.61
			1	25	22.73
			1	49	22.74
			25	0	21.74
			25	12	21.63
			25	25	21.63
			50	0	21.19
64QAM	819.0	10	1	0	21.76
			1	25	21.74
			1	49	21.71
			25	0	20.80
			25	12	20.67
			25	25	20.71
			50	0	20.59

Modulation	BW (MHz)	Frequency (MHz)	RB/RB offset	Output Power (dBm)	EIRP/ERP (dBm)	EIRP/ERP (W)
QPSK	1.4	814.7	1#0	23.28	20.19	0.10
QPSK	1.4	819.0	1#0	23.32	20.23	0.11
QPSK	1.4	823.3	1#0	23.20	20.11	0.10
16QAM	1.4	814.7	1#0	22.56	19.47	0.09
16QAM	1.4	819.0	1#0	22.44	19.35	0.09
16QAM	1.4	823.3	1#0	22.27	19.18	0.08
64QAM	1.4	814.7	1#0	21.44	18.35	0.07
64QAM	1.4	819.0	1#0	21.79	18.70	0.07
64QAM	1.4	823.3	1#0	21.38	18.29	0.07
QPSK	3	815.5	1#0	23.27	20.18	0.10
QPSK	3	819.0	1#0	23.26	20.17	0.10
QPSK	3	822.5	1#0	23.20	20.11	0.10
16QAM	3	815.5	1#0	22.60	19.51	0.09
16QAM	3	819.0	1#0	22.83	19.74	0.09
16QAM	3	822.5	1#0	22.20	19.11	0.08
64QAM	3	815.5	1#0	21.84	18.75	0.08
64QAM	3	819.0	1#0	21.79	18.70	0.07
64QAM	3	822.5	1#0	21.28	18.19	0.07
QPSK	5	816.5	1#0	23.26	20.17	0.10
QPSK	5	819.0	1#0	23.29	20.20	0.11
QPSK	5	821.5	1#0	23.24	20.15	0.10
16QAM	5	816.5	1#0	21.43	18.34	0.07
16QAM	5	819.0	1#0	22.30	19.21	0.08
16QAM	5	821.5	1#0	22.29	19.20	0.08
64QAM	5	816.5	1#0	21.35	18.26	0.07
64QAM	5	819.0	1#0	21.70	18.61	0.07
64QAM	5	821.5	1#0	21.71	18.62	0.07
QPSK	10	819.0	1#0	23.23	20.14	0.10
16QAM	10	819.0	1#0	22.61	19.52	0.09
64QAM	10	819.0	1#0	21.76	18.67	0.07

3.1.5. Uncertainty

$$U_{lab}=1.48\text{dB} (k=2)$$

3.2 Peak to Average Power Ratio (PAPR)

3.2.1. Limit

In measuring transmissions in this band using an average power technique, the peak-to-average ratio (PAR) of the transmission may not exceed 13dB.

3.2.2. Test Setup

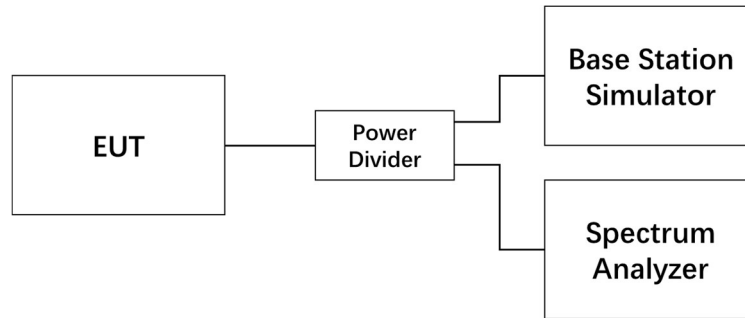

3.2.3. Test Procedures

- 1) The measurement procedure follows ANSI C63.26-2015, clause 5.2.6.
- 2) The RF output of the EUT, BS simulator and spectrum analyzer are connected via a power divider.
- 3) Measure the total peak power and record as P_{pk} .
- 4) Measure the total average power and record as P_{Avg} .
- 5) Calculate the PAPR from: $PAPR (dB) = P_{pk} (dBm) - P_{Avg} (dBm)$.

3.2.4. Test Result

Test Engineer	Xu Dongxu	Test Date	2021/01/29
Temperature	20.1°C	Relative Humidity	46.8%
Pressure	105.2kPa	Test Sample Selected	No.1

Frequency (MHz)	Channel No.	BW (MHz)	RB Size	RB Offset	QPSK	16-QAM	64-QAM
814.7	26697	1.4	1	5	Fig.1	Fig.2	Fig.3
814.7	26697	1.4	6	0	Fig.4	Fig.5	Fig.6
819	26740	1.4	1	5	Fig.7	Fig.8	Fig.9
819	26740	1.4	6	0	Fig.10	Fig.11	Fig.12
823.3	26783	1.4	1	5	Fig.13	Fig.14	Fig.15
823.3	26783	1.4	6	0	Fig.16	Fig.17	Fig.18
815.5	26705	3	1	14	Fig.19	Fig.20	Fig.21
815.5	26705	3	15	0	Fig.22	Fig.23	Fig.24
819	26740	3	1	14	Fig.25	Fig.26	Fig.27
819	26740	3	15	0	Fig.28	Fig.29	Fig.30
822.5	26775	3	1	14	Fig.31	Fig.32	Fig.33
822.5	26775	3	15	0	Fig.34	Fig.35	Fig.36
816.5	26715	5	1	24	Fig.37	Fig.38	Fig.39
816.5	26715	5	25	0	Fig.40	Fig.41	Fig.42
819	26740	5	1	24	Fig.43	Fig.44	Fig.45
819	26740	5	25	0	Fig.46	Fig.47	Fig.48
821.5	26765	5	1	24	Fig.49	Fig.50	Fig.51
821.5	26765	5	25	0	Fig.52	Fig.53	Fig.54
819	26740	10	1	49	Fig.55	Fig.56	Fig.57
819	26740	10	50	0	Fig.58	Fig.59	Fig.60

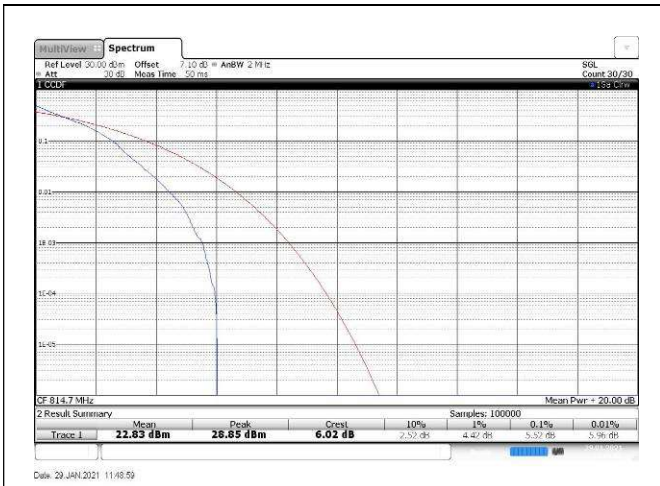

Fig.1

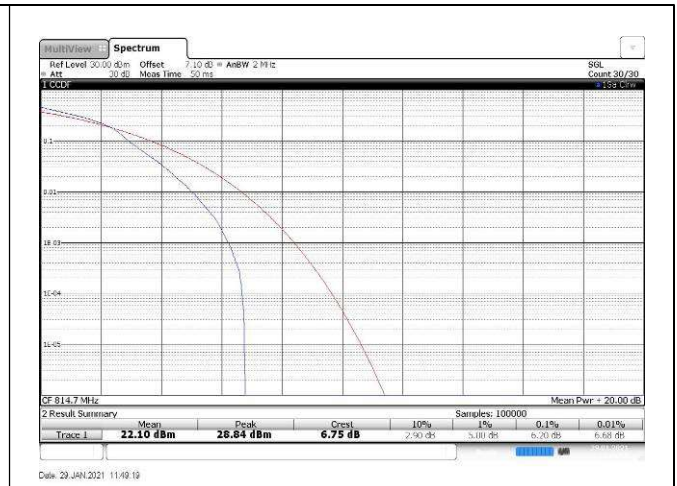

Fig.2

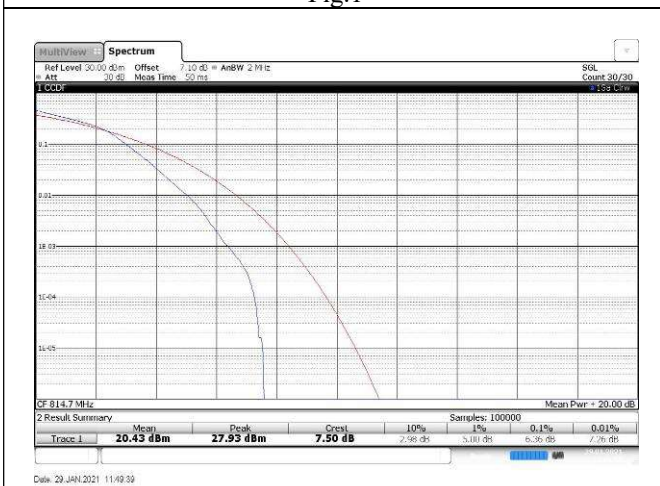

Fig.3

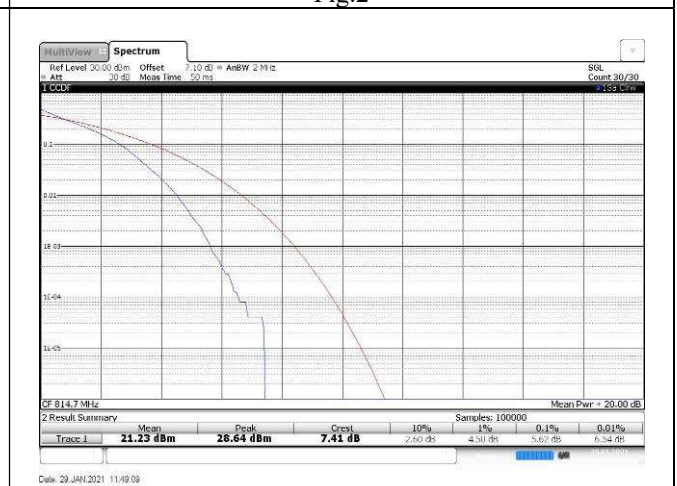

Fig.4

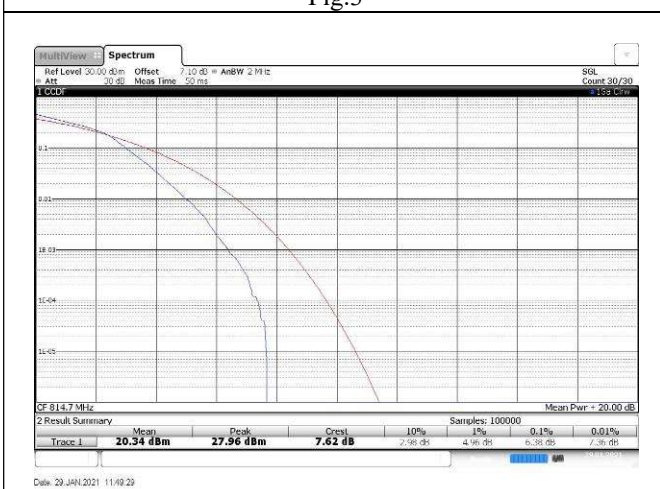

Fig.5

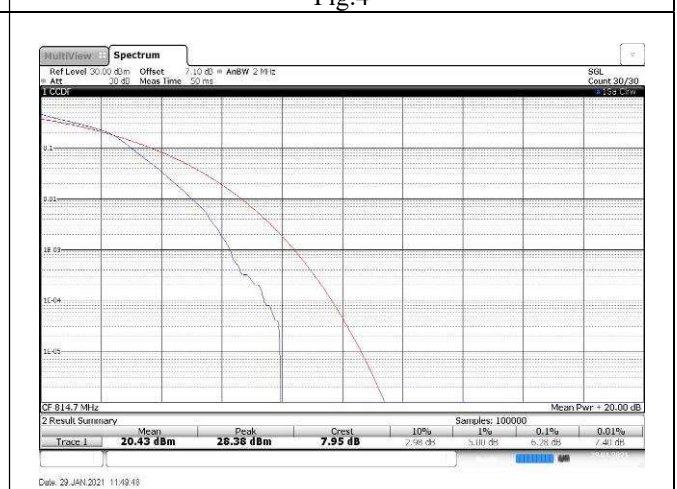

Fig.6

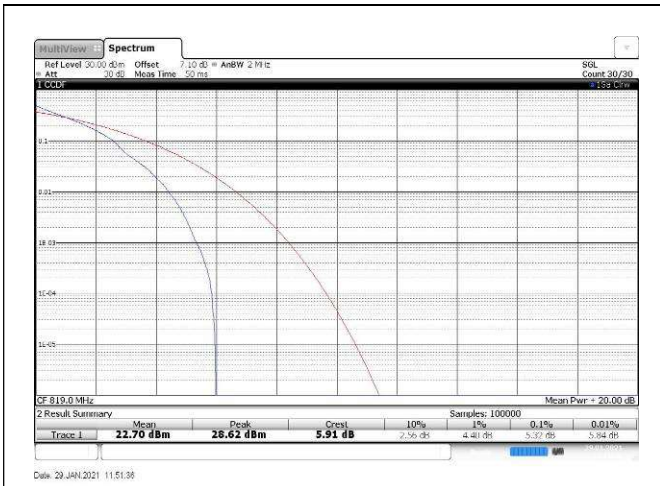

Fig.7

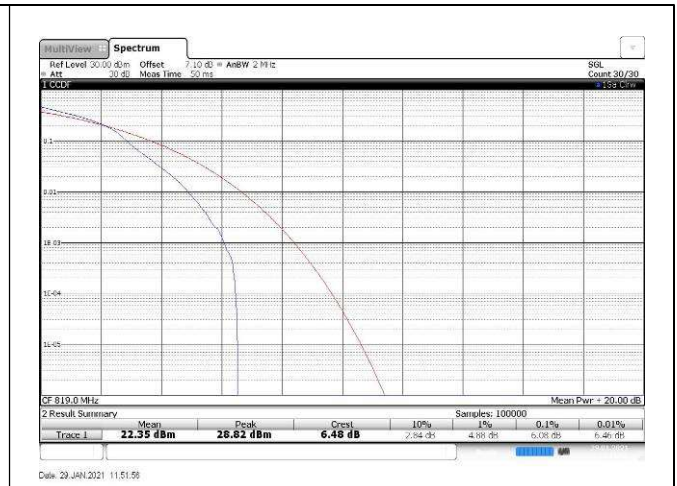

Fig.8

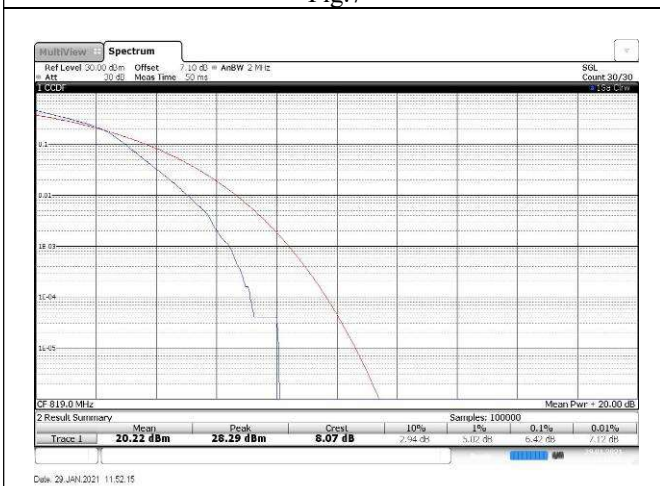

Fig.9

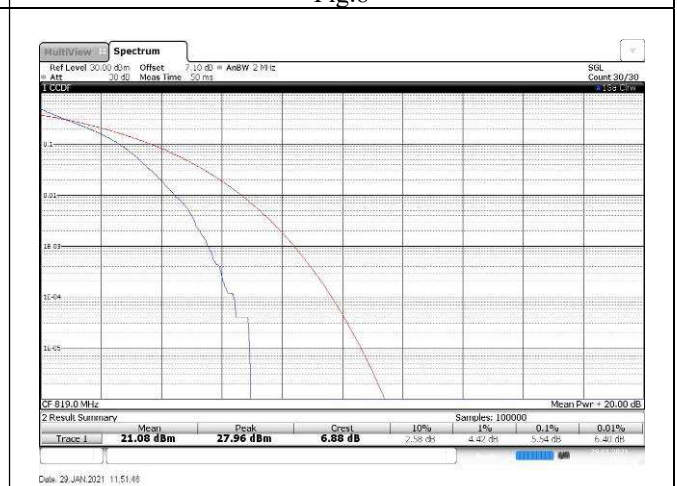

Fig.10

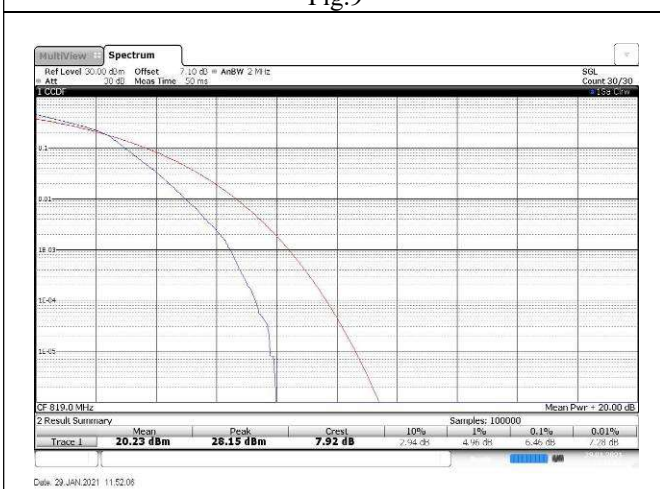

Fig.11

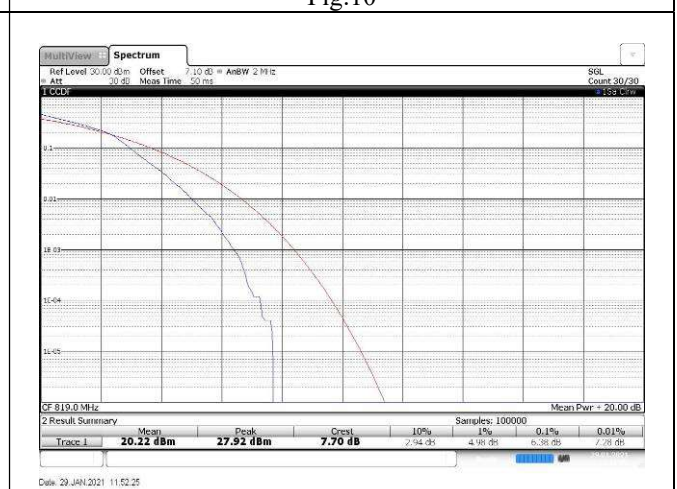

Fig.12

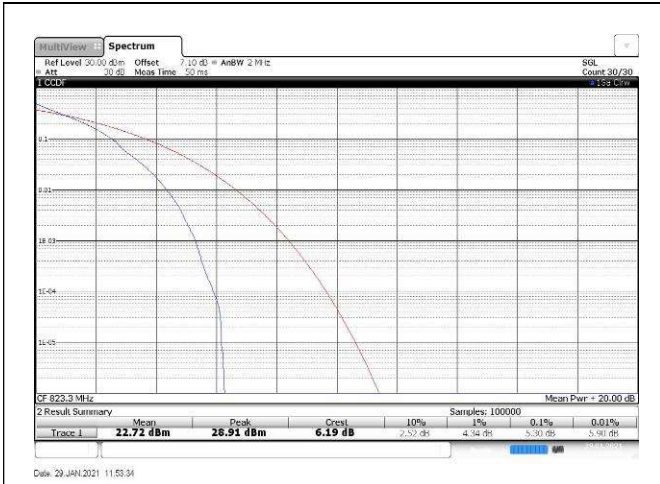

Fig.13

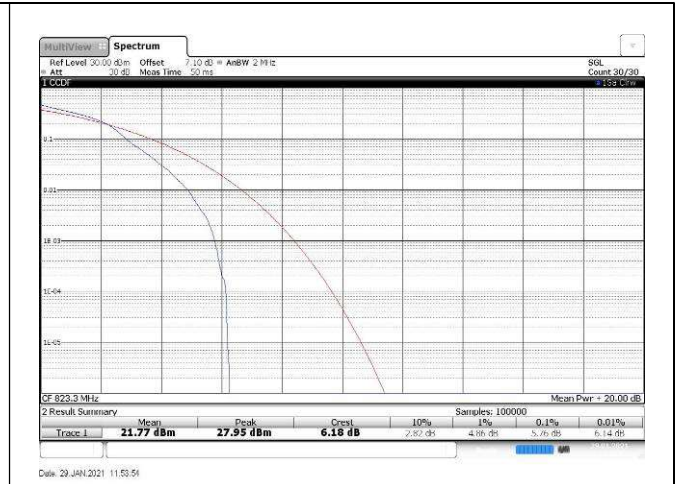

Fig.14

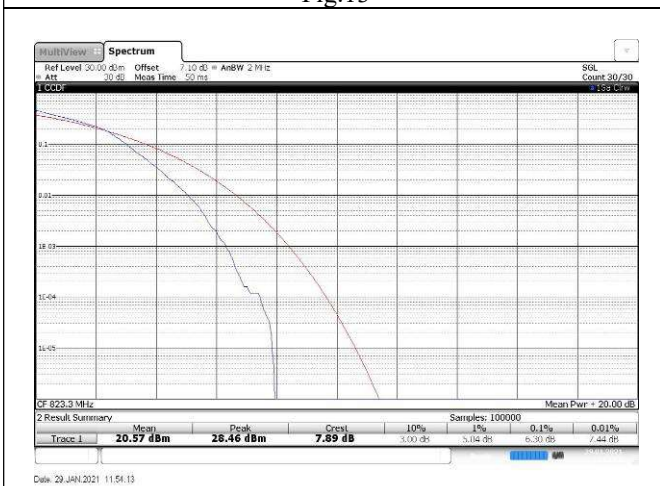

Fig.15

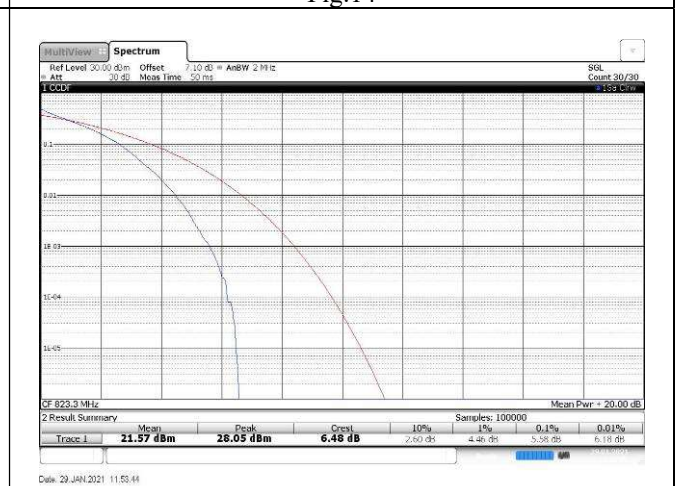

Fig.16

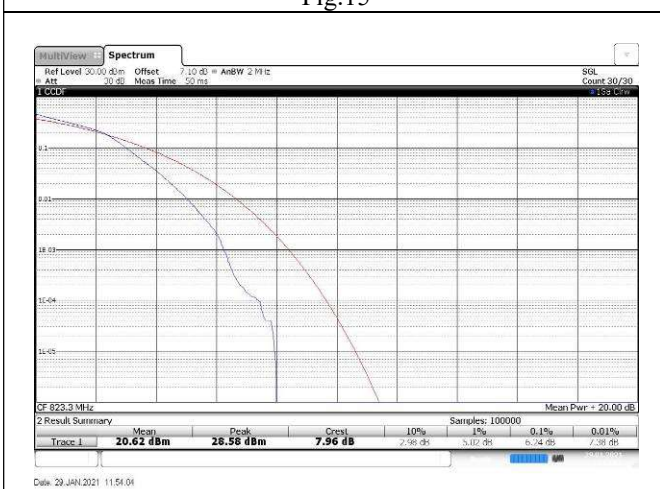

Fig.17

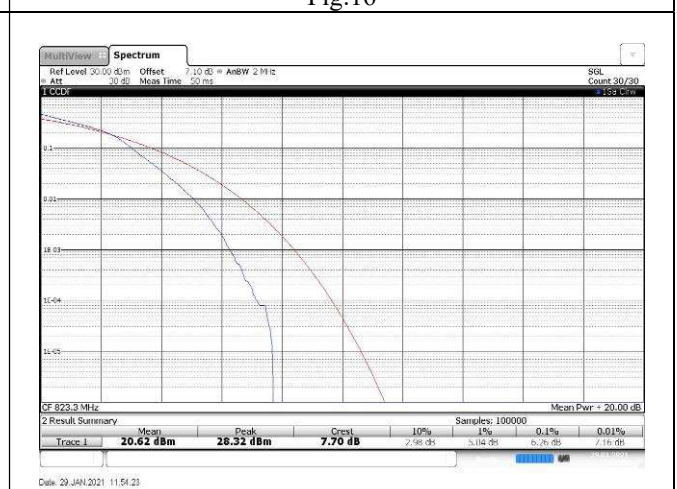

Fig.18

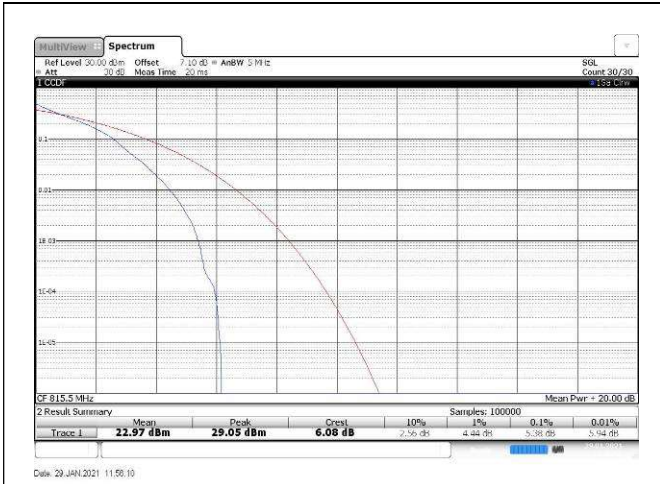

Fig.19

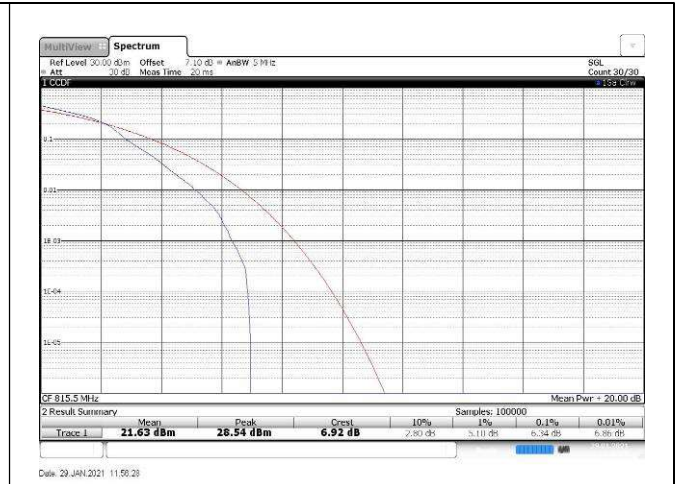

Fig.20

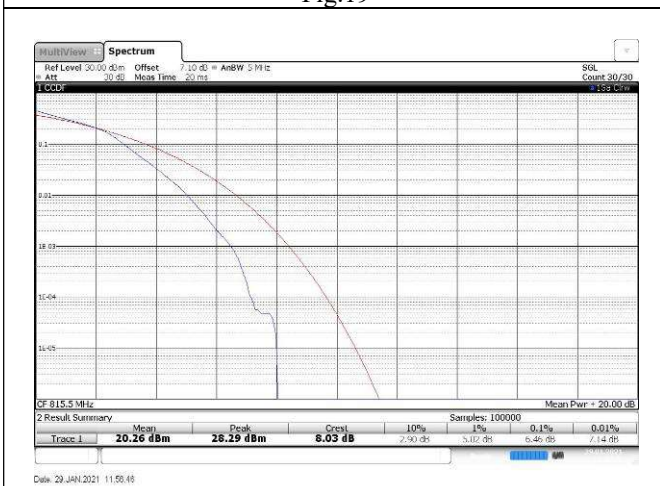

Fig.21

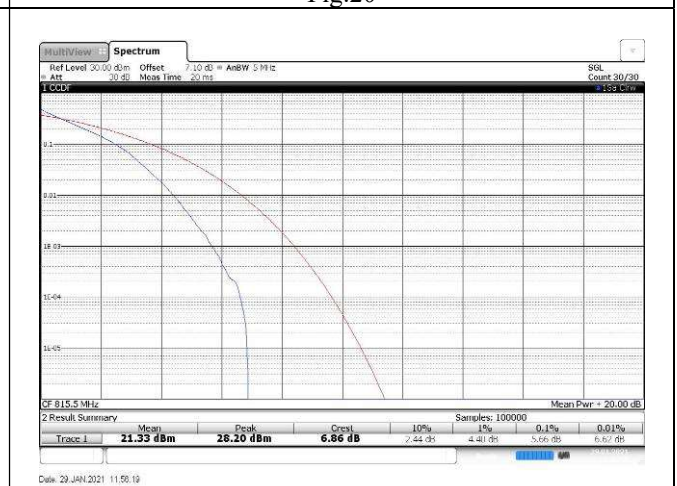

Fig.22

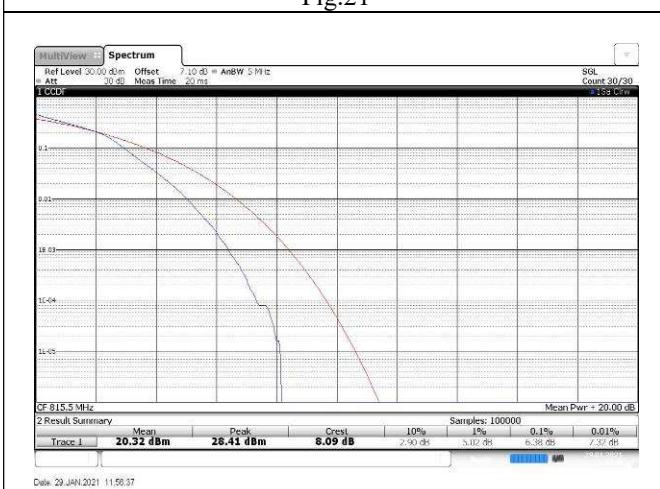

Fig.23

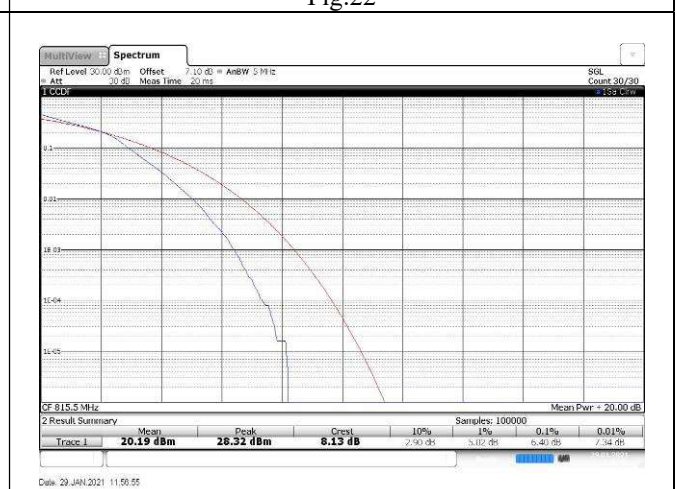

Fig.24

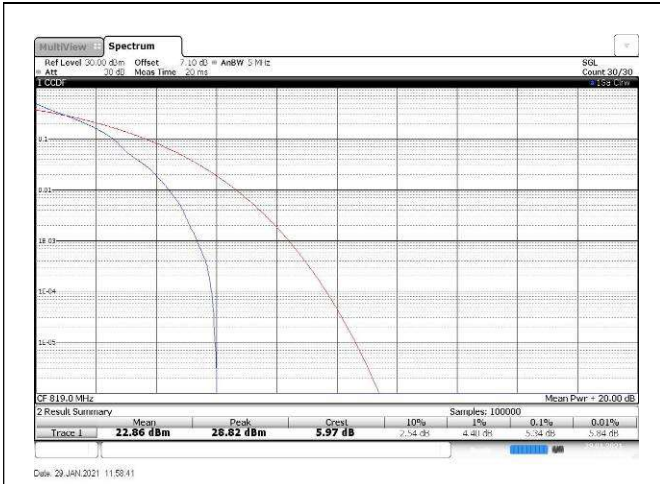

Fig.25

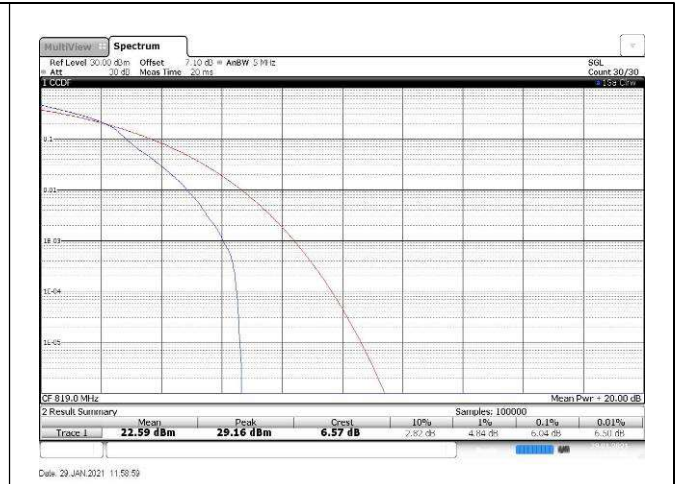

Fig.26

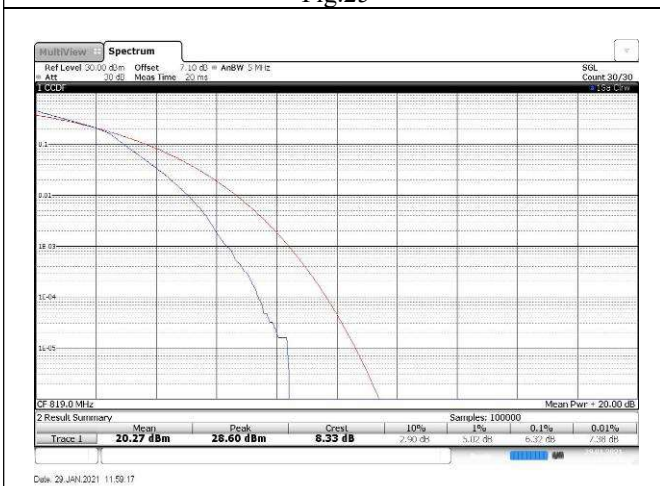

Fig.27

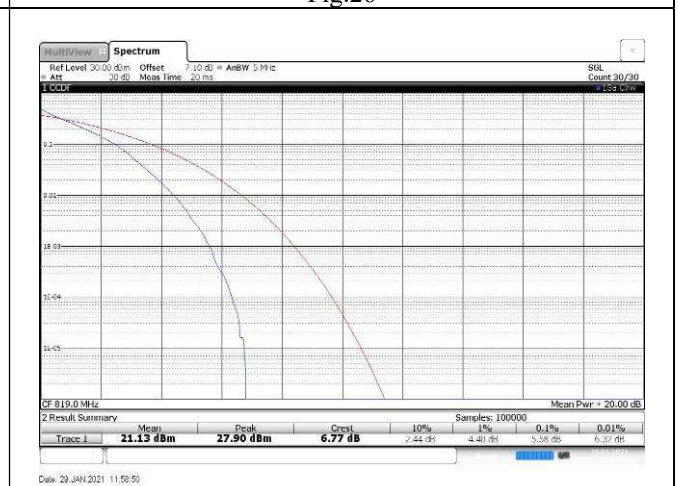

Fig.28

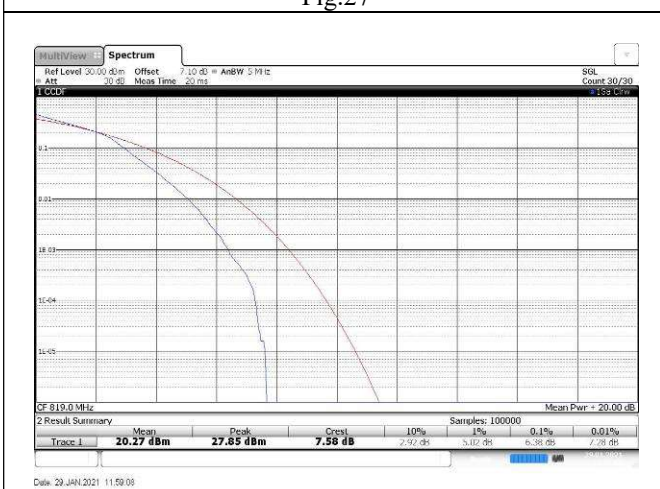

Fig.29

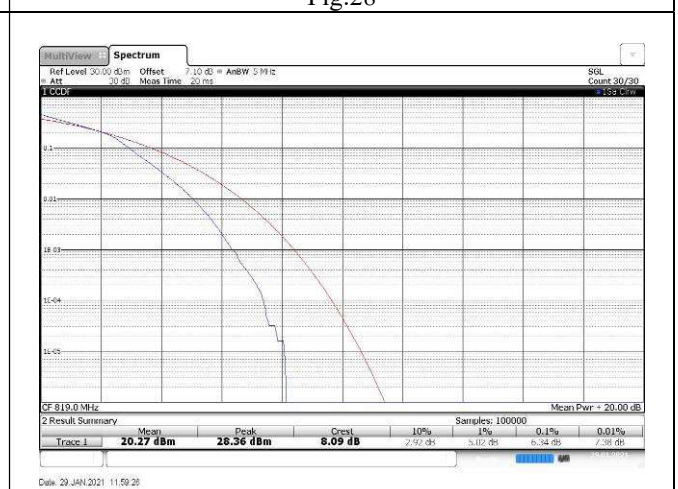

Fig.30

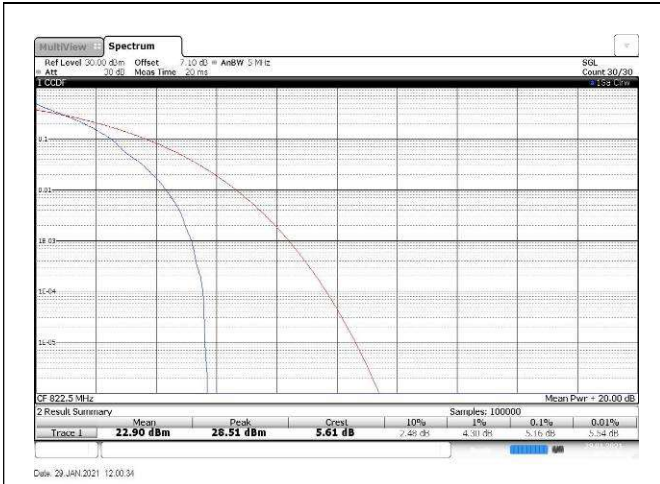

Fig.31

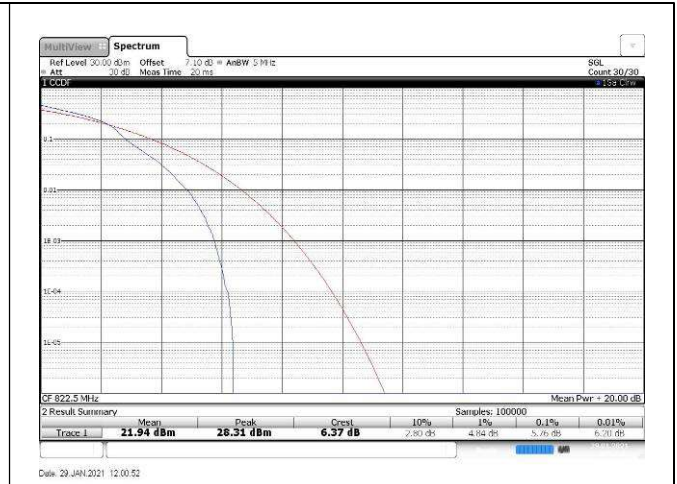

Fig.32

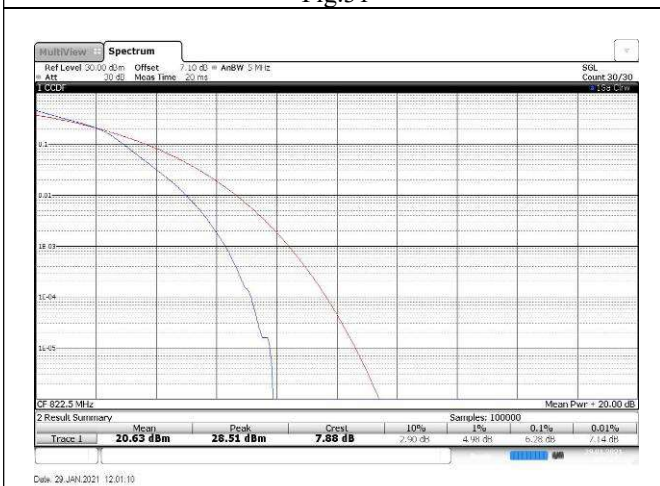

Fig.33

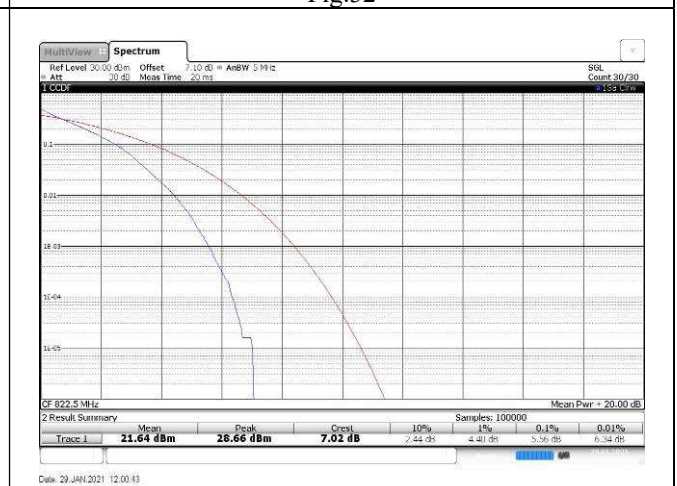

Fig.34

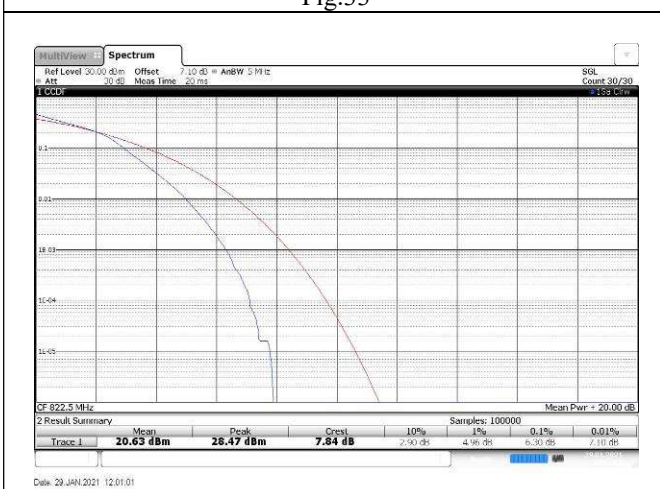

Fig.35

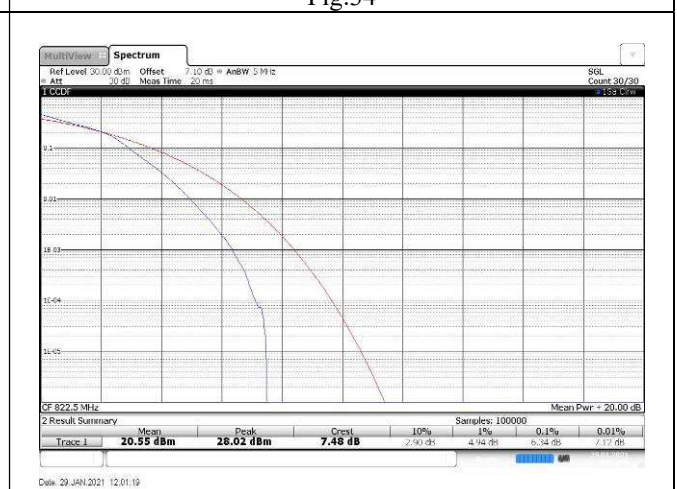

Fig.36

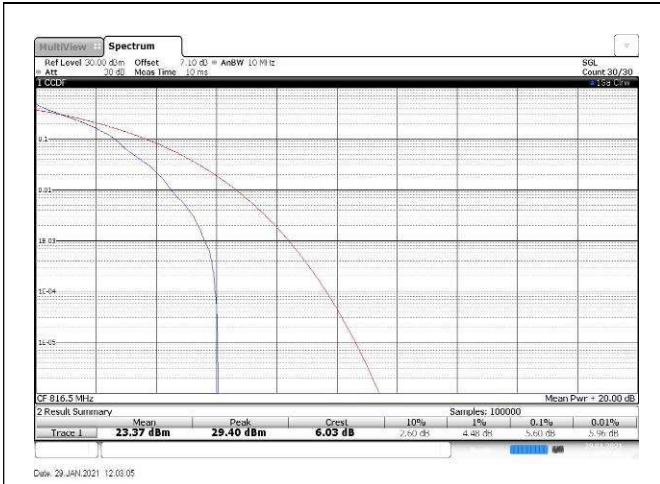

Fig.37

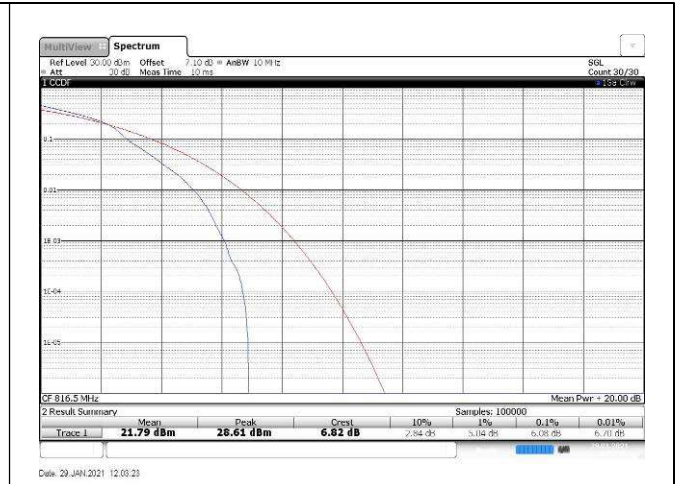

Fig.38

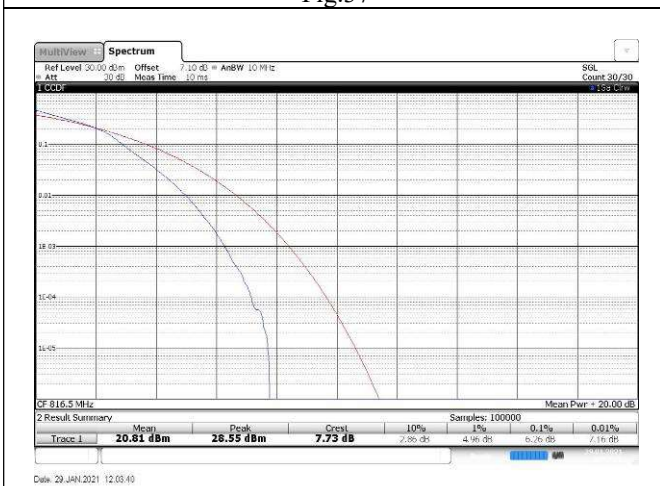

Fig.39

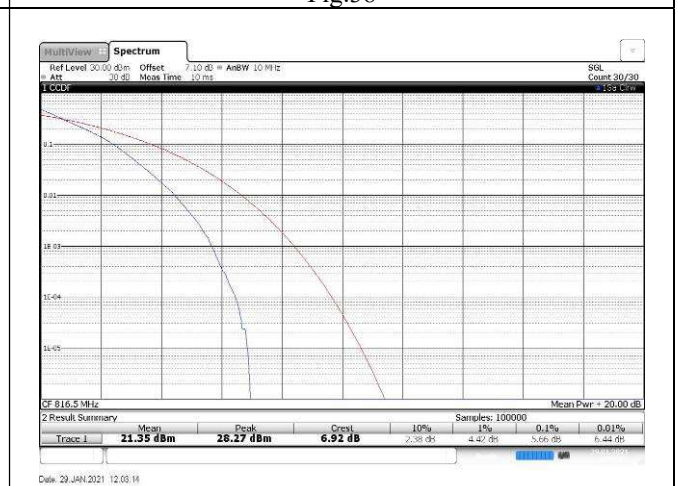

Fig.40

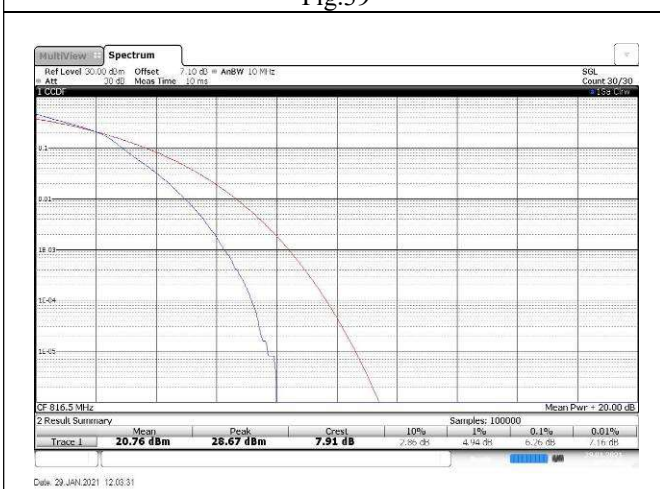

Fig.41

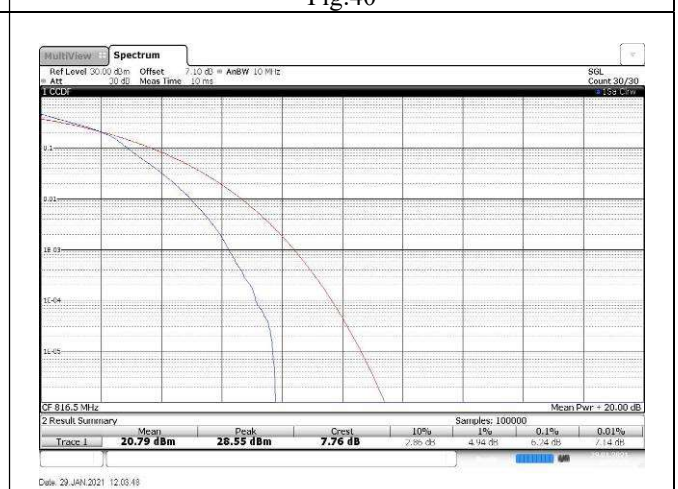

Fig.42

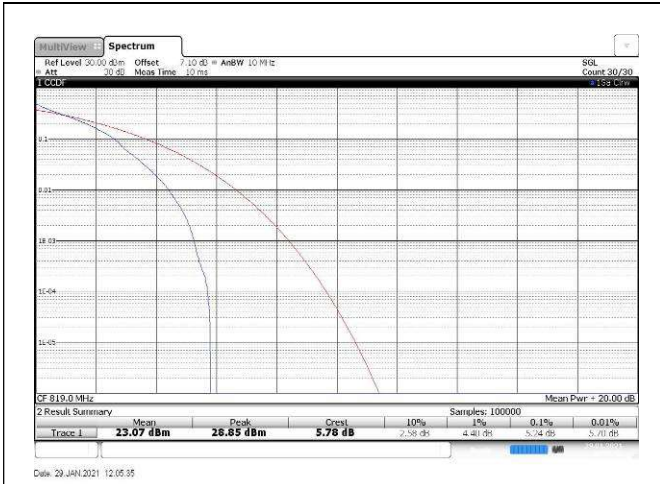

Fig.43

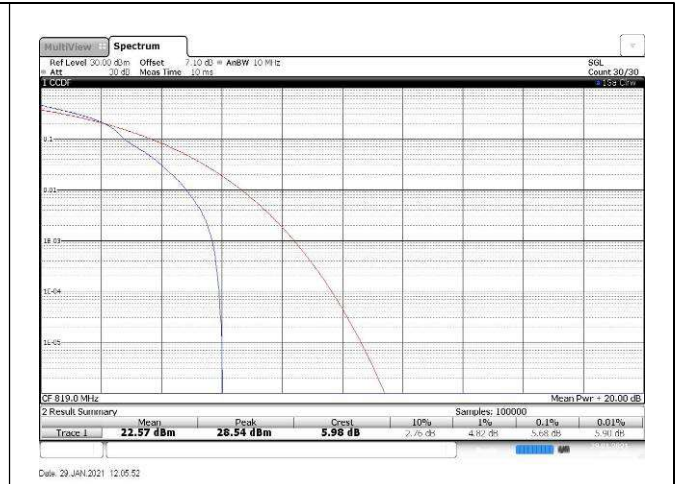

Fig.44

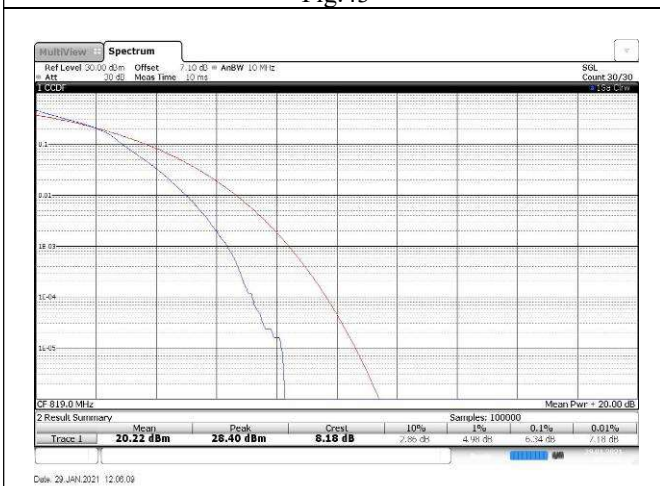

Fig.45

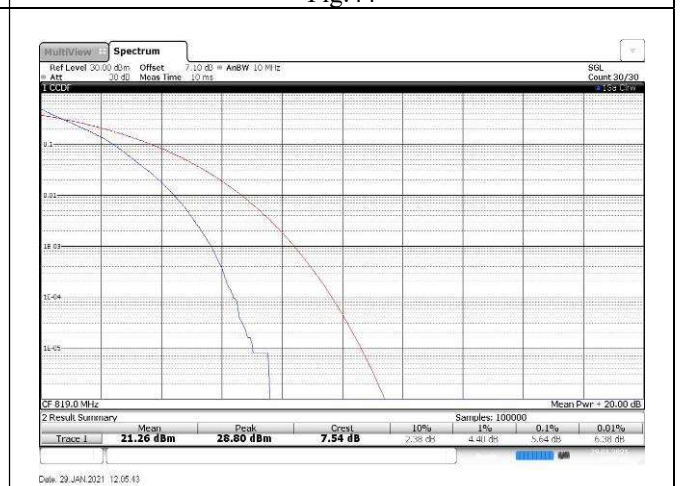

Fig.46

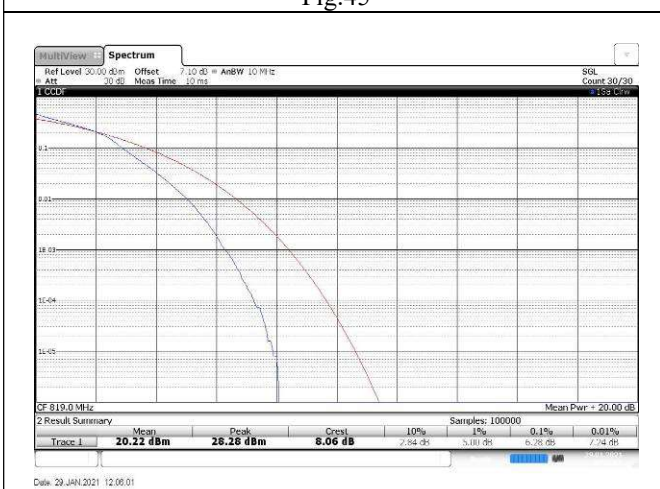

Fig.47

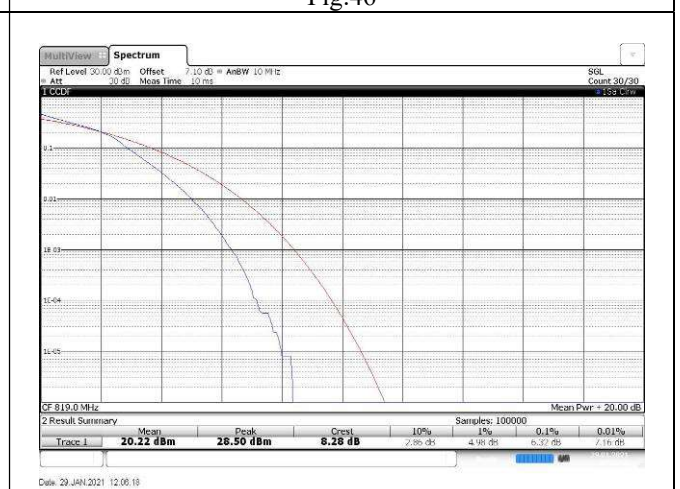

Fig.48

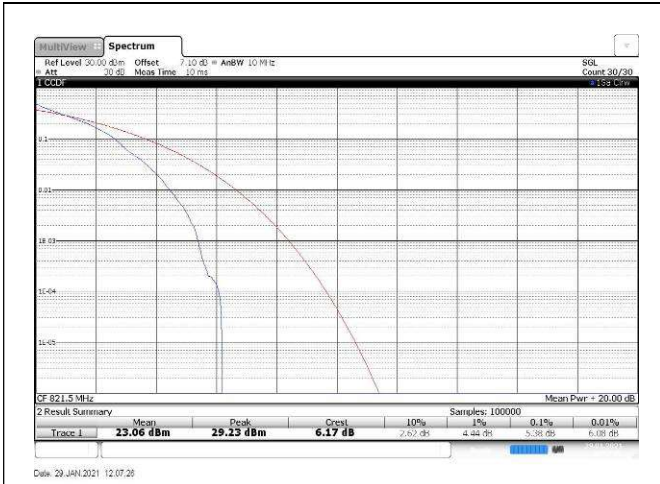

Fig.49

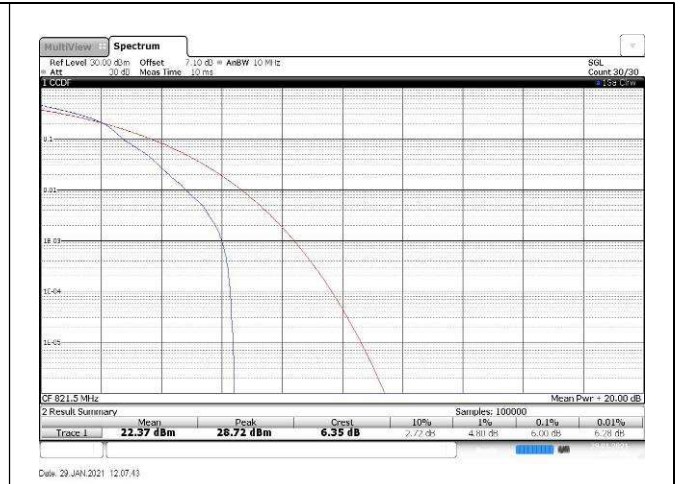

Fig.50

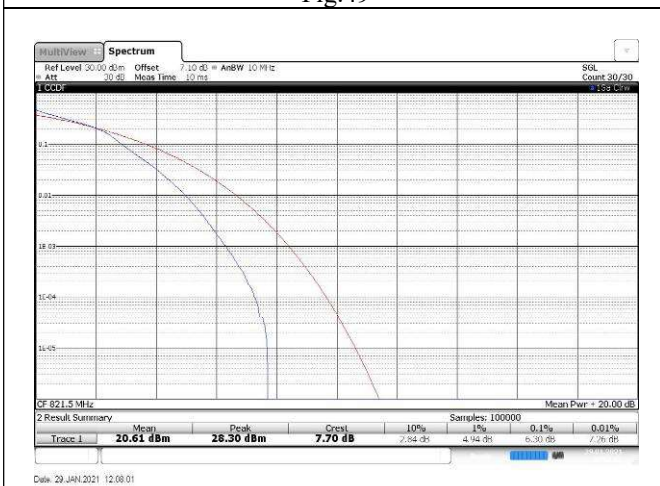

Fig.51

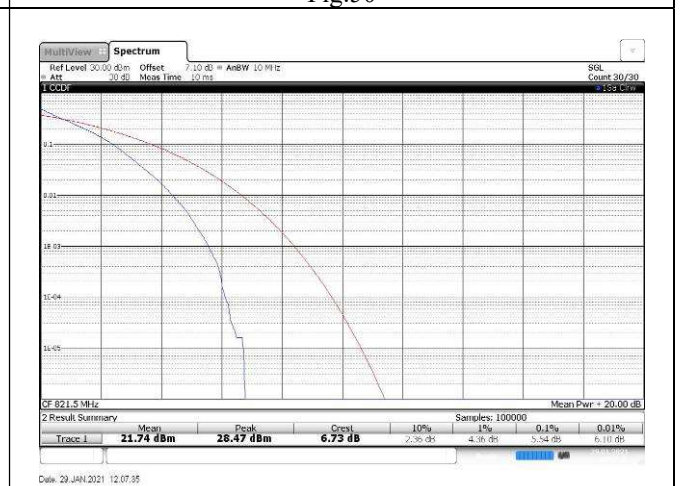

Fig.52

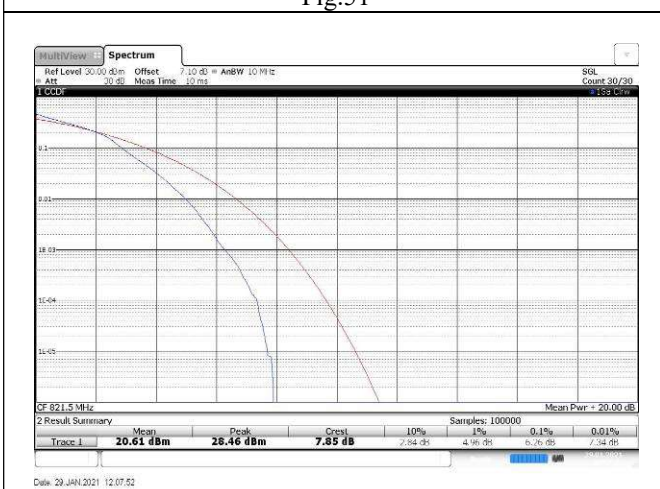

Fig.53

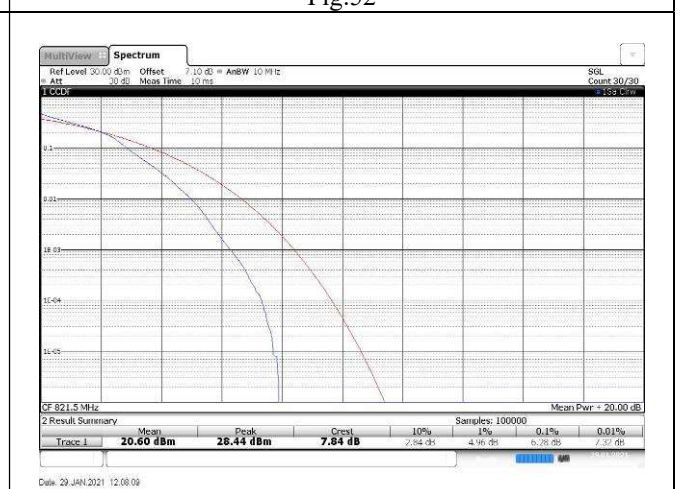

Fig.54

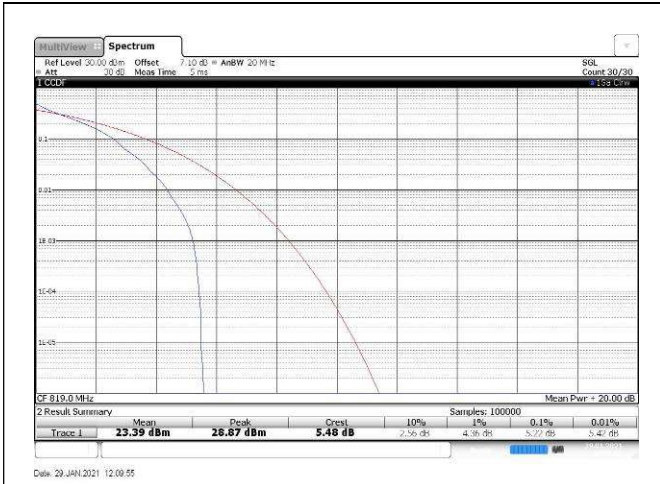

Fig.55

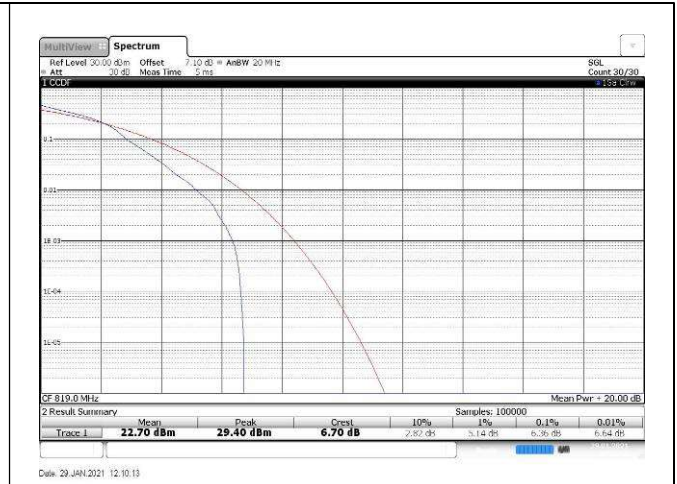

Fig.56

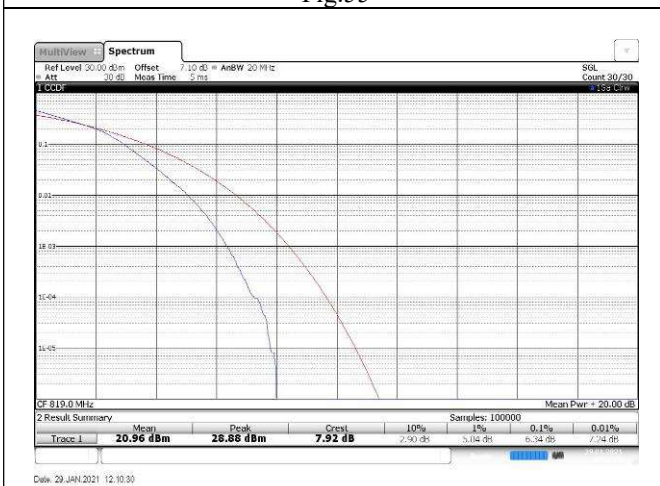

Fig.57

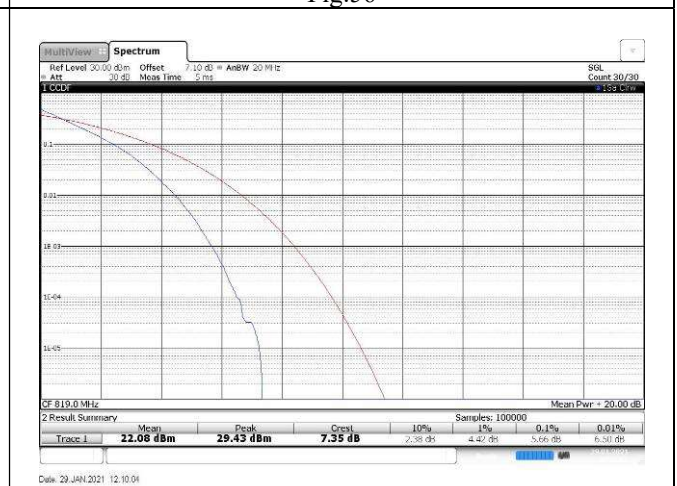

Fig.58

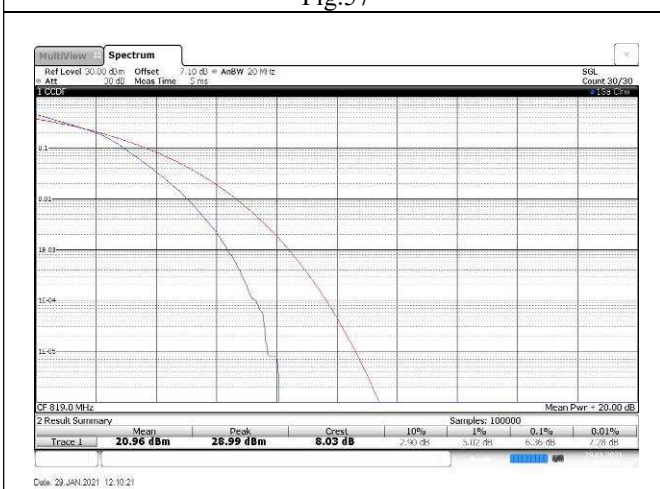

Fig.59

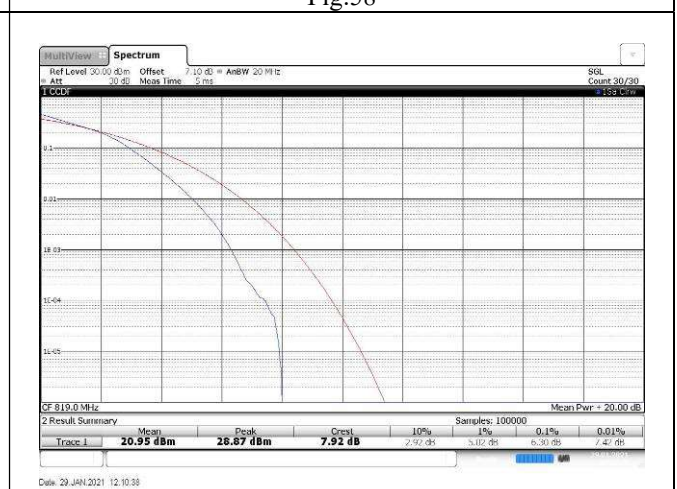

Fig.60

3.2.5. Uncertainty

$$U_{lab}=2.46\text{dB} (k=2)$$