TEST REPORT

Report No.: SRTC2020-9003(F)-0081
Product Name: Mobile phone
Model Name: HLTE233E
Applicant: Hisense International Co., Ltd.
Manufacturer: Hisense Communications Co., Ltd.
Specification: FCC Part15B (Certification)
(2020 edition)
FCC ID: 2ADOBHLTE233E

The State Radio_monitoring_center Testing Center (SRTC)
15th Building, No.30 Shixing Street, Shijingshan District,
Beijing, China

Tel: 86-10-57996183 Fax: 86-10-57996388

CONTENTS

1. General information	3
1.1 Notes of the test report	3
1.2 Information about the testing laboratory	3
1.3 Applicant's details	3
1.4 Manufacturer's details	3
1.5 Application details	4
1.6 Reference specification	4
1.7 Information of EUT	4
1.7.1 General information	4
1.7.2 EUT details	5
1.7.3 Auxiliary equipment details	5
2. Test information	7
2.1 Summary of the test results	7
2.2 Test result	8
2.2.1 Conducted Emissions-FCC Part15.107	8
2.2.2 Radiated Emissions-FCC Part15.109	14
2.3. List of test equipments	23

1. General information

1.1 Notes of the test report

The test report may only be reproduced or published in full. Reproduction or publication of extracts from the report requires the prior written permission of The State Radio_monitoring_center Testing Center (SRTC).

The test results relate only to individual items of the samples which have been tested.

1.2 Information about the testing laboratory

Company: The State Radio_monitoring_center Testing Center (SRTC)
Address: 15th Building, No.30 Shixing Street, Shijingshan District
Testing location: No.80, Zhaojiachang, BeizangCun, Daxing District, Beijing, China.
City: Beijing
Country or Region: China
Contacted person: Liu Jia
Tel: +86 10 57996183
Fax: +86 10 57996388
Email: liujiaf@srtc.org.cn

1.3 Applicant's details

Company: Hisense International Co., Ltd.
Address: Floor 22, Hisense Tower, 17 Donghai Xi Road, Qingdao, 266071, China
City: Qingdao
Country or Region: China
Contacted person: Geng Ruifeng
Tel: 86-532-80877742
Email: gengruifeng@hisense.com

1.4 Manufacturer's details

Company: Hisense Communications Co., Ltd.
Address: 218 Qianwangang Road, Qingdao Economic & Technological Development Zone, Qingdao, China
City: Qingdao
Country or Region: China
Contacted person: Deng Tingting
Tel: 86-532-55753708
Email: dengtingting@hisense.com

1.5 Application details

Date of reception of test sample: 25th Jan. 2021

Date of test: 25th Jan. 2021 to 30th Jan. 2021

1.6 Reference specification

FCC Part 15B, 2020 (Certification)

1.7 Information of EUT

1.7.1 General information

Name of EUT	Mobile phone
Model Name	HLTE233E
FCC ID	2ADOBHLTE233E
Frequency Range	GSM: GSM850/PCS1900 WCDMA: FDD II / FDD IV / FDD V LTE:FDD 2/ FDD 4/ FDD 5/ FDD 7/ FDD 12/ FDD 26 Bluetooth: 2.4~2.4835GHz WiFi: 2.4~2.4835GHz/ 5.15-5.25GHz/5.25-5.35GHz 5.475-5.725GHz/5.725-5.85GHz
Equipment Class	Class B
Power Supply	Battery or Charger
Rated Power Supply Voltage	3.8V
Extreme Temperature	Lowest: -30°C Highest: +50°C
Extreme Voltage	Minimum: 3.5V Maximum: 4.35V
HW Version	FS185-MB-V0.2
SW Version	Hisense_HLTE233E_10_S01_01_02_MX05_ debug_KS233C_0003853_20210115_ 1121

1.7.2 EUT details

	Product Name	Model Name	IMEI
EUT1	Mobile phone	HLTE233E	860598050000290
EUT2	Mobile phone	HLTE233E	860598050001611

Note1: The EUT has two supplies, and the differences are shown in the table below.

Main Supply(EUT1)

Part Name	Model	Supplier(Brand)	Description
LCD touch panel	FT8006S-AA	WANCHANGLONG ELECTRONICS TECHNOLOGY (SHENZHEN) CO., LTD	6.55
Camera	imx586	GXW	imx586 COB
Memory	KMDH6001D M-B422	SAMSUNG(AA)	64+4

Secondary Supply(EUT2)

Part Name	Model Name	supplier	Remark
LCD touch panel	ILI9882N	WANCHANGLONG ELECTRONICS TECHNOLOGY (SHENZHEN) CO., LTD	6.55
Camera	OV48B2Q	DD	OV48B2Q COB
Memory	KMDH6001D A-B422	SAMSUNG(AA)	64+4

1.7.3 Auxiliary equipment details

AE (Auxiliary Equipment) 1#: Laptop

Manufacturer	Lenovo
Model Number	E40-70
S/N	MP06WE9U
Input Voltage	100V-240V AC

AE (Auxiliary Equipment) 2#: USB Cable

Manufacturer	kelinDongguan Keling Electronic Technology Co., Ltd
Model Number	KS232D

AE (Auxiliary Equipment) 3#: Battery

Type	Li-Lon
Manufacturer	ShenzhenAerospaceElectronic Co.,Ltd.
Model Number	PLG496590

AE (Auxiliary Equipment) 4#: Headset

Manufacturer	kelinDongguan Keling Electronic Technology Co., Ltd
Model Number	KS232D

AE (Auxiliary Equipment) 5#: Charger

Manufacturer	SHENZHENTIANYIN ELECTRONICS CO., LTD.
Model Number	TPA-46050200UU
S/N	/
Input Voltage	100V-240VAC 0.3A
Output Voltage	5.0VDC 2000mA

Note2: As the information described in these above tables, the relevant tests have been performed in order to verify in which supply would have the worst features. When the EUT2 exercised with 2# USB Cable, 3# Battery, 4# Headset, 5# Charger is the worst feature, and record the results in the test report.

Note3: AE1# Laptop was selected by testing laboratory and was only cooperated with this test, not for sale.

2. Test information

2.1 Summary of the test results

No.	Test case	FCC reference	Verdict
1	Conducted emissions	15.107	Pass
2	Radiated emissions	15.109	Pass

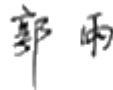
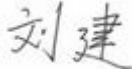
Approved By: Mr. Liu Wei Director of the test department 	Checked By: Mr. Guo Yu Vice director of the test department 
Tested by: Mr. Liu Jian Test engineer 	Issued date: 2021.1.30

2.2 Test result

2.2.1 Conducted Emissions-FCC Part15.107

Ambient condition:

Temperature	Relative humidity	Pressure
24.5°C	41.6%	101.2kPa

Test Setup with laptop:

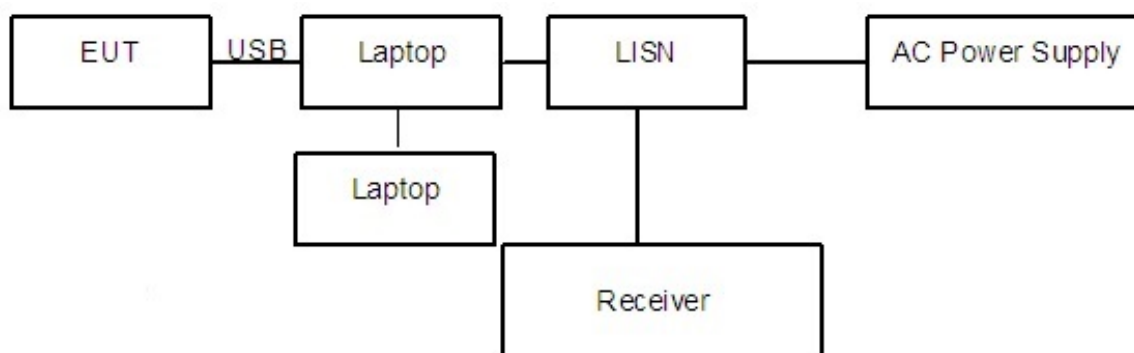

Figure 1

Test Procedure:

The EUT is placed on a non-metallic table 0.8m above the horizontal metal reference ground plane. The accessories of the EUT are connected with the EUT such as headset etc. The EUT was connected with a laptop via the USB cable and transferred the data by copying large files from laptop to the EUT. The laptop's LAN port is connected with another laptop via cable. And the data transferring between two laptops is maintained.

The AC main power supply of the laptop is connected to LISN and LISN is connected to the reference ground. The test set-up and the test methods are performed according to ANSI C63.4:2014.

Then start the test software EMC32. Sweep the whole frequency band through the range from 150 KHz to 30 MHz with RBW 9kHz, VBW 30kHz. The measurement should be done for both L line and N line. During pre-test, the receiver uses both peak detector and average detector. And the final test, the receiver uses both average detector and Quasi-peak detector.

The data of cable loss has been calibrated in full testing frequency range before the testing.

Test Setup with charger:

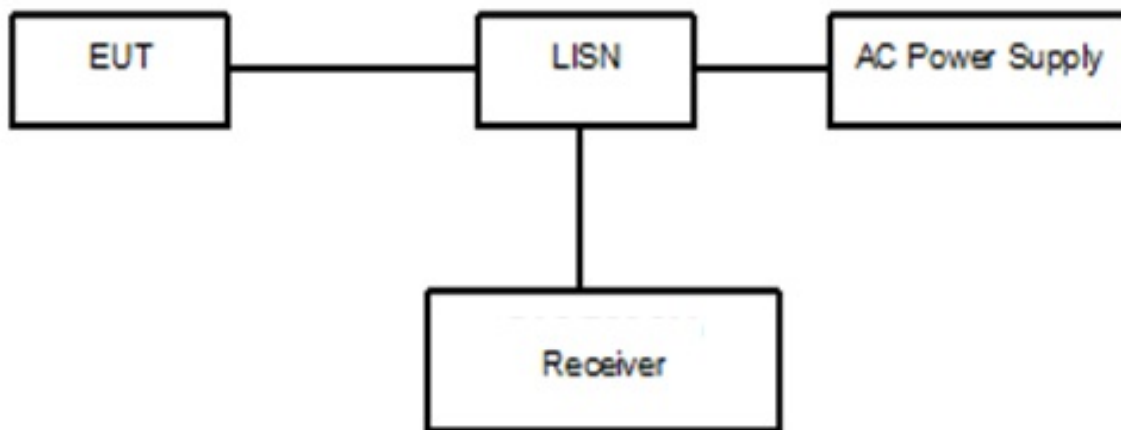

Figure 2

Test Procedure:

The EUT is placed on a non-metallic table 0.8m above the horizontal metal reference ground plane. The EUT is connected with LISN via the charger. The LISN is connected to the reference ground. The accessories of the EUT are connected with the EUT such as headset etc. Open the following functions of EUT: Camera, flash lamp, FM, GPS and video.

The test set-up and the test methods are performed according to ANSI C63.4:2014. Then start the test software EMC32. Sweep the whole frequency band through the range from 150 KHz to 30 MHz with RBW 9kHz, VBW 30kHz. The measurement should be done for both L line and N line. During pre-test, the receiver uses both peak detector and average detector. And the final test, the receiver uses both average detector and Quasi-peak detector.

The data of cable loss has been calibrated in full testing frequency range before the testing.

A "reference path loss" Corr.(dB) is established and the $L_{cable} + ATT + VDF$ is the attenuation of "reference path loss", and including the cable loss, the attenuation of the attenuator, the voltage division factor of AMN.

The measurement results are obtained as described below:

$$P_{result} = P_{mea} + Corr.(dB)$$

Sample calculation: $(25.62dB\mu V) = (-4.08dB\mu V) + (29.7dB)$, the corresponding frequency is 0.171321MHz.

Limit:

Frequency of Emission(MHz)	Limits(dB μ V)	
	Quasi-peak	Average
0.15~0.5	66 to 56*	56 to 46*
0.5~5	56	46
5~30	60	50

Note: * Decreases with the logarithm of the frequency

Test result:

Noise Level of the Measuring Instrument

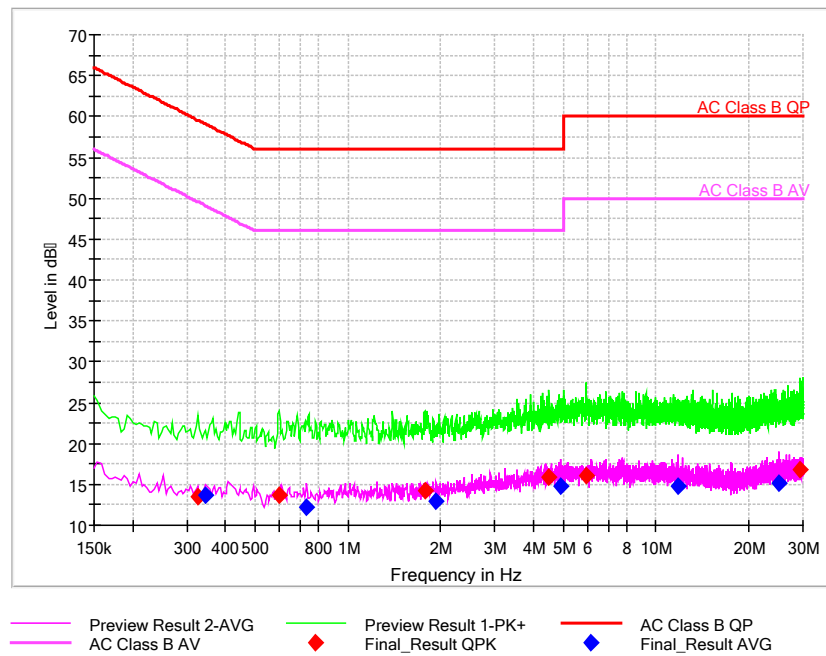

Pic1. Conducted emission L and N Line

EUT + Charger: AC240V

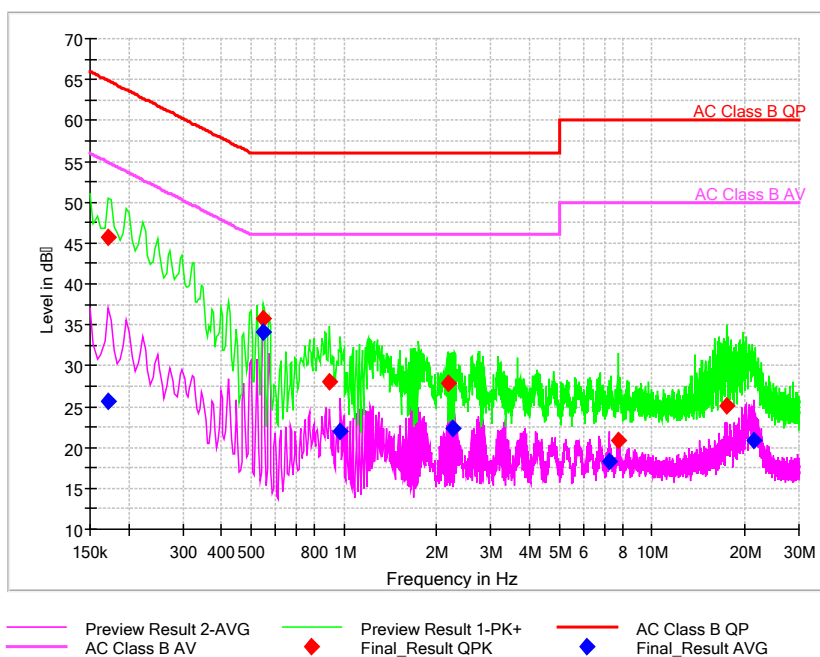

Pic2. Conducted emission L&N Line

Frequency (MHz)	QuasiPeak (dBμV)	Average (dBμV)	Limit (dBμV)	Margin (dB)	Line	Corr. (dB)	Pmea QuasiPeak (dBμV)	Pmea Average (dBμV)
0.171321	---	25.62	54.90	29.28	L1	29.7	---	-4.08
0.171321	45.70	---	64.90	19.20	L1	29.7	16	---
0.546579	---	34.03	46.00	11.97	N	29.7	---	4.33
0.546579	35.76	---	56.00	20.24	L1	29.7	6.06	---
0.900514	27.97	---	56.00	28.03	L1	29.8	-1.83	---
0.973007	---	22.03	46.00	23.97	N	29.8	---	-7.77
2.171271	27.77	---	56.00	28.23	L1	29.8	-2.03	---
2.269350	---	22.36	46.00	23.64	L1	29.8	---	-7.44
7.288414	---	18.30	50.00	31.70	L1	29.9	---	-11.6
7.808657	20.90	---	60.00	39.10	L1	29.9	-9	---
17.497114	25.01	---	60.00	34.99	N	30.1	-5.09	---
21.501279	---	20.85	50.00	29.15	L1	30.3	---	-9.45

EUT + Charger: AC120V

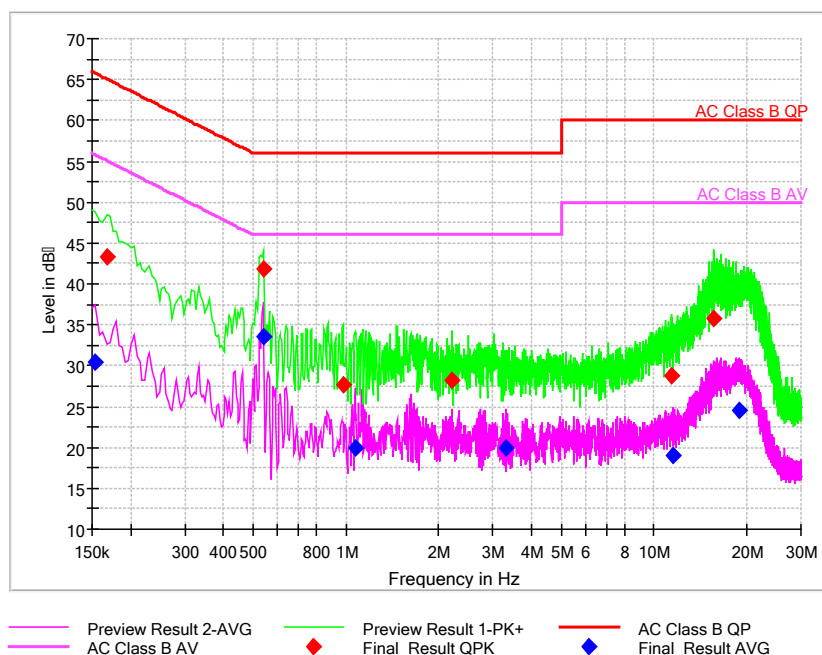

Pic3. Conducted emission L&N Line

Frequency (MHz)	QuasiPeak (dBμV)	Average (dBμV)	Limit (dBμV)	Margin (dB)	Line	Corr. (dB)	Pmea QuasiPeak (dBμV)	Pmea Average (dBμV)
0.154264	---	30.34	55.77	25.43	L1	29.7	---	0.64
0.167057	43.39	---	65.11	21.72	L1	29.7	13.69	---
0.538050	---	33.63	46.00	12.37	N	29.7	---	3.93
0.538050	41.78	---	56.00	14.22	L1	29.7	12.08	---
0.977271	27.62	---	56.00	28.38	L1	29.8	-2.18	---
1.071086	---	19.95	46.00	26.05	L1	29.8	---	-9.85
2.213914	28.21	---	56.00	27.79	L1	29.8	-1.59	---
3.318364	---	19.86	46.00	26.14	L1	29.8	---	-9.94
11.446093	28.78	---	60.00	31.22	L1	29.9	-1.12	---
11.480207	---	18.94	50.00	31.06	L1	29.9	---	-10.96
15.654943	35.68	---	60.00	24.32	N	30.1	5.58	---
18.891536	---	24.62	50.00	25.38	L1	30.1	---	-5.48

EUT + Laptop:

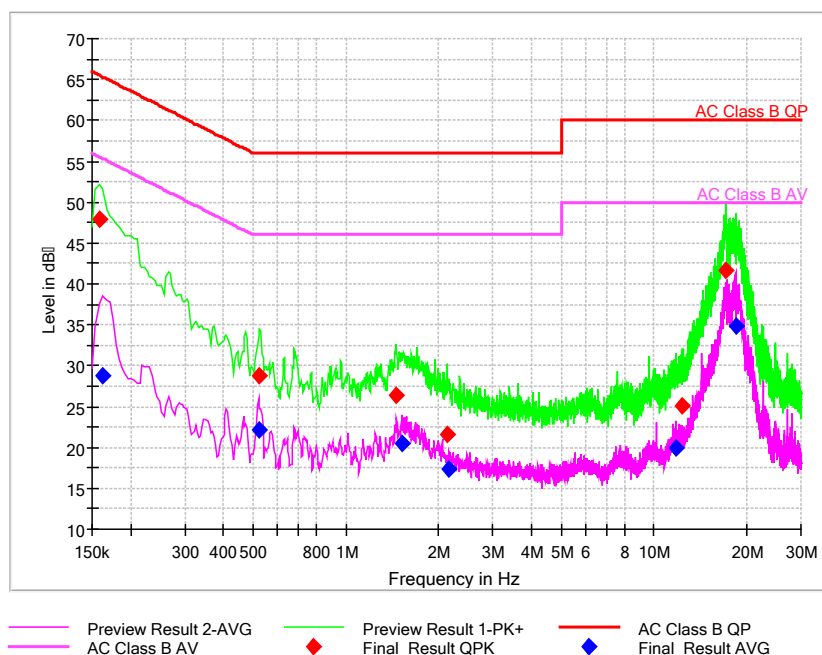

Pic4. Conducted emission L&N Line

Frequency (MHz)	QuasiPeak (dB μ V)	Average (dB μ V)	Limit (dB μ V)	Margin (dB)	Line	Corr. (dB)	Pmea QuasiPeak (dB μ V)	Pmea Average (dB μ V)
0.158529	47.91	---	65.54	17.63	L1	29.7	18.21	---
0.162793	---	28.69	55.32	26.63	L1	29.7	---	-1.01
0.520993	---	22.23	46.00	23.77	L1	29.7	---	-7.47
0.525257	28.80	---	56.00	27.20	L1	29.7	-0.9	---
1.454871	26.31	---	56.00	29.69	L1	29.8	-3.49	---
1.518836	---	20.54	46.00	25.46	N	29.8	---	-9.26
2.128629	21.63	---	56.00	34.37	L1	29.8	-8.17	---
2.167007	---	17.30	46.00	28.70	L1	29.8	---	-12.5
11.817086	---	19.89	50.00	30.11	L1	29.9	---	-10.01
12.337329	25.05	---	60.00	34.95	N	30.0	-4.95	---
17.126121	41.67	---	60.00	18.33	L1	30.1	11.57	---
18.392614	---	34.76	50.00	15.24	L1	30.1	---	4.66

2.2.2 Radiated Emissions-FCC Part15.109

Ambient condition:

Temperature	Relative humidity	Pressure
24.4°C	41.8%	101.2kPa

Test Setup:

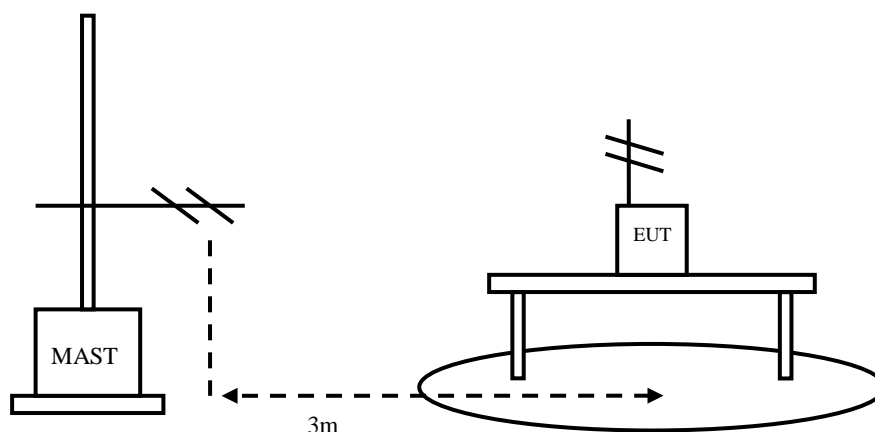

Figure 3

Test Procedure:

EUT+Laptop:

The EUT should be placed on a non-metallic table 80cm above the ground plane. The receive antennas shall be moved from 1 to 4 meters. The distance between EUT and receive antenna should be 3 meters.

The accessories of the EUT are connected with the EUT such as headset etc. The EUT was connected with a laptop via the USB cable and transferred the data by copying large files from laptop to the EUT. The test set-up and the test methods are performed according to ANSI C63.4:2014

Then start the test software EMC32. Sweep the whole frequency band through the range from 30MHz to 1GHz, using receive log period antenna VULB 9163.

During the test, the height of receive antenna shall be moved from 1 to 4 meters, and the antenna shall be performed under horizontal and vertical polarization. The turn table shall be rotated from 0 to 360 degrees for detecting the maximum of radiated spurious signal level. The measurements shall be repeated with orthogonal polarization of the test antenna. The EUT is laid in two modes as follow:
1. put the EUT in horizontal direction; 2. put the EUT in vertical direction.

The data of cable loss and antenna factor have been calibrated in full testing frequency range before the testing.

EUT + Charger:

The EUT should be placed on a non-metallic table 80cm above the ground plane. The receive antennas shall be moved from 1 to 4 meters. The distance between EUT and receive antenna should be 3 meters.

The EUT should work in idle mode. The accessories of the EUT are connected with the EUT such as headset etc. Open the following functions of EUT: Camera, flash lamp, FM, GPS and video. The test set-up and the test methods are performed according to ANSI C63.4:2014.

Then start the test software EMC32. Sweep the whole frequency band through the range from 30MHz to 1GHz, using receive log period antenna VULB 9163.

During the test, the height of receive antenna shall be moved from 1 to 4 meters, and the antenna shall be performed under horizontal and vertical polarization. The turn table shall be rotated from 0 to 360 degrees for detecting the maximum of radiated spurious signal level. The measurements shall be repeated with orthogonal polarization of the test antenna. The EUT is laid in two modes as follow:
1. put the EUT in horizontal direction; 2. put the EUT in vertical direction.

The data of cable loss and antenna factor have been calibrated in full testing frequency range before the testing. All test results are performed with max hold at the horizontal and vertical polarity.

RBW=120kHz, VBW=300kHz, when the test frequency: 30MHz<f<1GHz

RBW=1MHz, VBW=3MHz, when the test frequency: f>1GHz

A “reference path loss” is established and the A_{Rpl} is the attenuation of “reference path loss”, and including the gain of receive antenna, the gain of the preamplifier, the cable loss.

The measurement results are obtained as described below:

$$\text{Result} = P_{\text{mea}} + A_{Rpl}$$

Limit:

Frequency of Emission(MHz)	Limits	
	Detector	Unit (dB μ V/m)
30~88	Quasi-peak	40
88~216	Quasi-peak	43.5
216~960	Quasi-peak	46
960~1000	Quasi-peak	54
1000~5th harmonic of the highest frequency or 40GHz, whichever is lower	Average	54
	Peak	74

Test result:

Sample calculation: $(20.08\text{dB}\mu\text{V}/\text{m}) = (38.38\text{dB}\mu\text{V}/\text{m}) + (-18.3\text{dB})$, the corresponding frequency is 59.411MHz.

EUT + Laptop:

Frequency(MHz)	Result(dB μ V/m)	Limit (dB μ V/m)	ARpl (dB)	Pmea (dB μ V/m)	Polarity
59.411	20.08	40.00	-18.3	38.38	V
75.7955	25.06	40.00	-23	48.06	V
79.878	23.3	40.00	-23.9	47.2	V
83.952	22.23	40.00	-22.6	44.83	V
258.723	25.1	46.00	-16.2	41.3	V
799.7405	28.55	46.00	-3.4	31.95	V

EUT + Charger:

Frequency(MHz)	Result(dB μ V/m)	Limit (dB μ V/m)	ARpl (dB)	Pmea (dB μ V/m)	Polarity
52.9145	21.03	40.00	-17.5	38.53	V
67.137	22.78	40.00	-20.7	43.48	V
98.2135	22.22	43.50	-18.9	41.12	V
215.09	11.23	43.50	-18	29.23	V
480.003	14.76	46.00	-9.8	24.56	V
950.8895	20.71	46.00	-0.9	21.61	V

EUT + Laptop: refer to Pic5, Pic6, Pic7, Pic8, Pic9

Full Spectrum

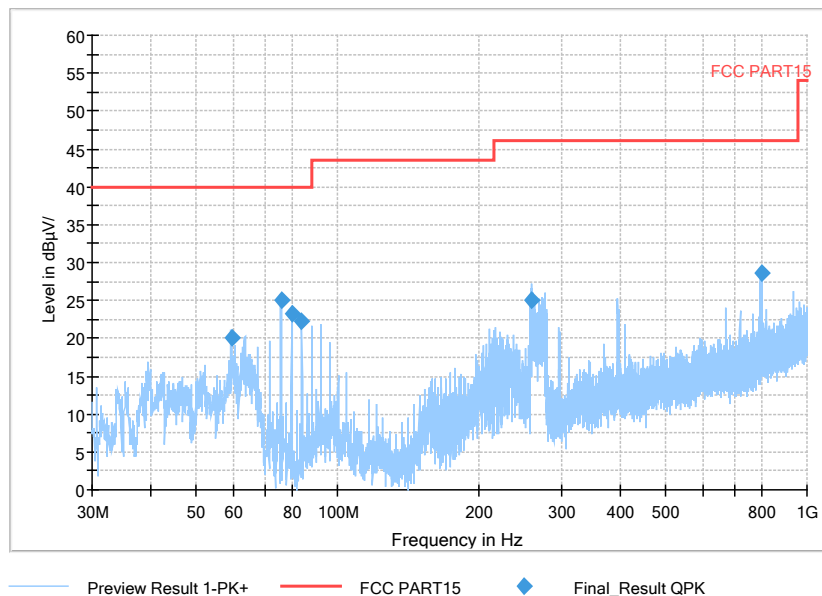

Pic5. Radiated emission(30MHz – 1GHz)

Note: The test data in the graph includes two polarizations: horizontal and vertical

Full Spectrum

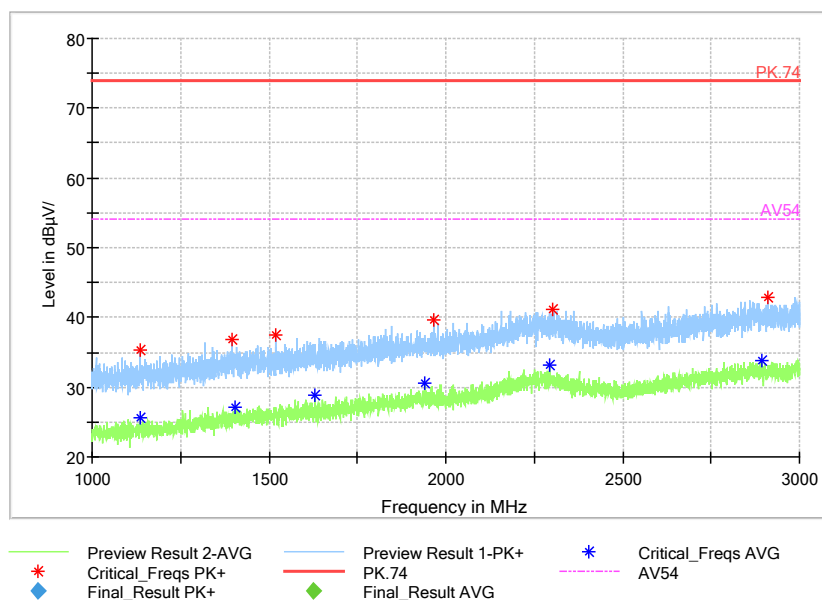

Pic6. Radiated emission (1GHz –3GHz)

Note: The test data in the graph includes two polarizations: horizontal and vertical.

Full Spectrum

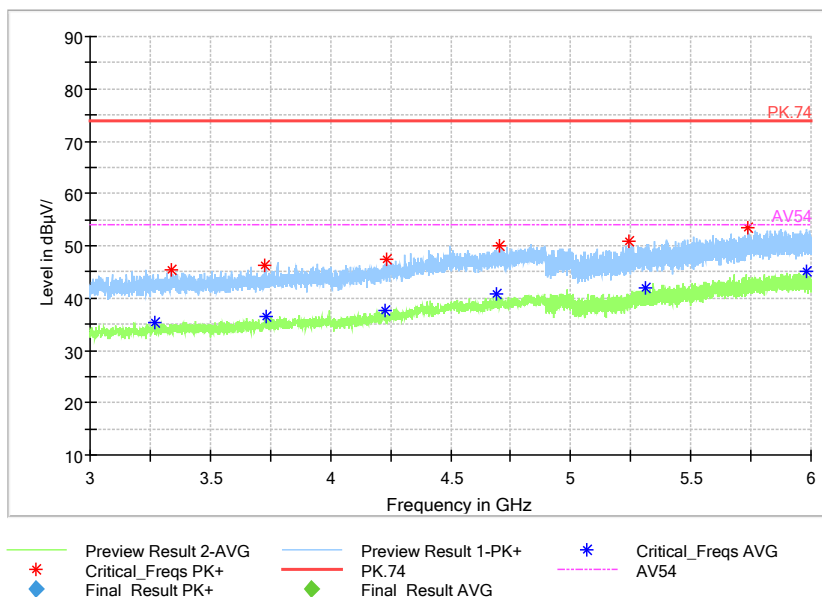

Pic7. Radiated emission (3GHz –6GHz)

Note: The test data in the graph includes two polarizations: horizontal and vertical.

Full Spectrum

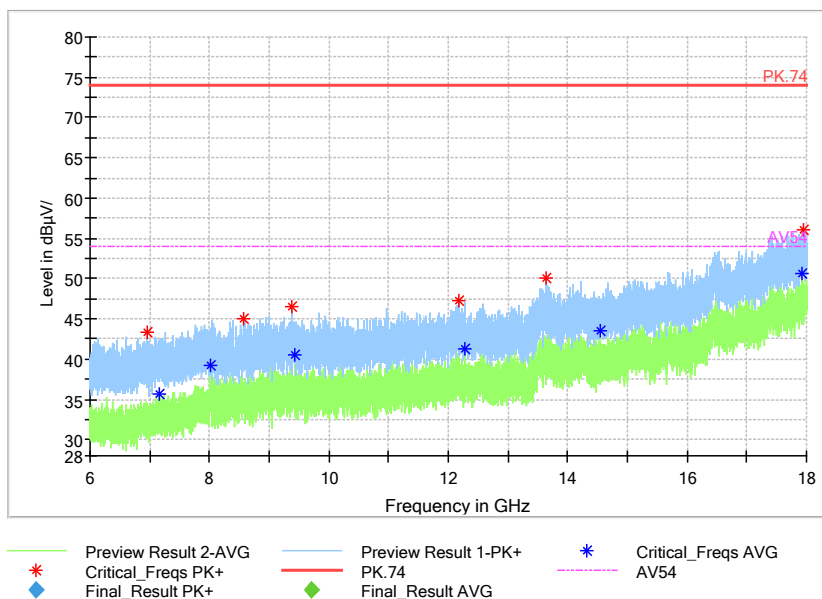

Pic8. Radiated emission (6GHz –18GHz)

Note: The test data in the graph includes two polarizations: horizontal and vertical.

Full Spectrum

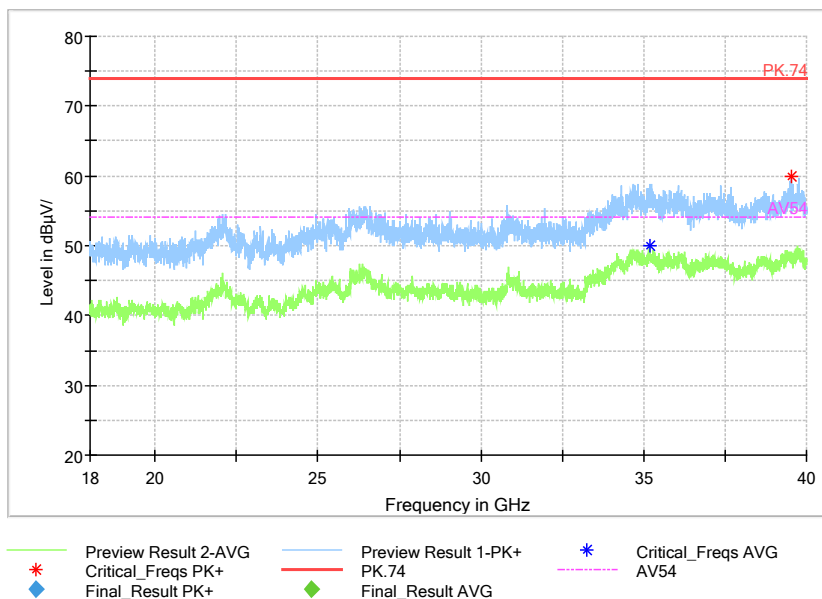

Pic9. Radiated emission (18GHz – 40GHz)

Note: The test data in the graph includes two polarizations: horizontal and vertical.

EUT + Charger: refer to Pic10, Pic11, Pic12, Pic13, Pic14

Full Spectrum

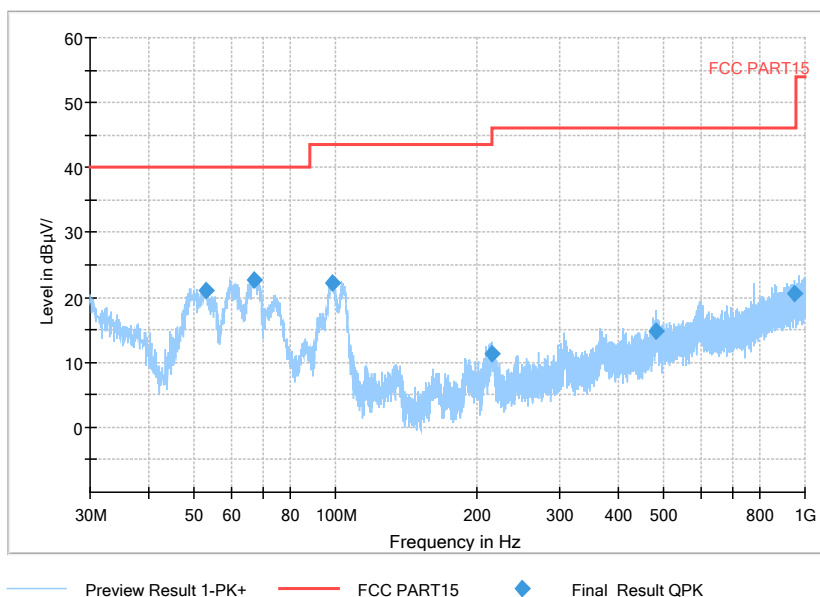

Pic10. Radiated emission(30MHz – 1GHz)

Note: The test data in the graph includes two polarizations: horizontal and vertical

Full Spectrum

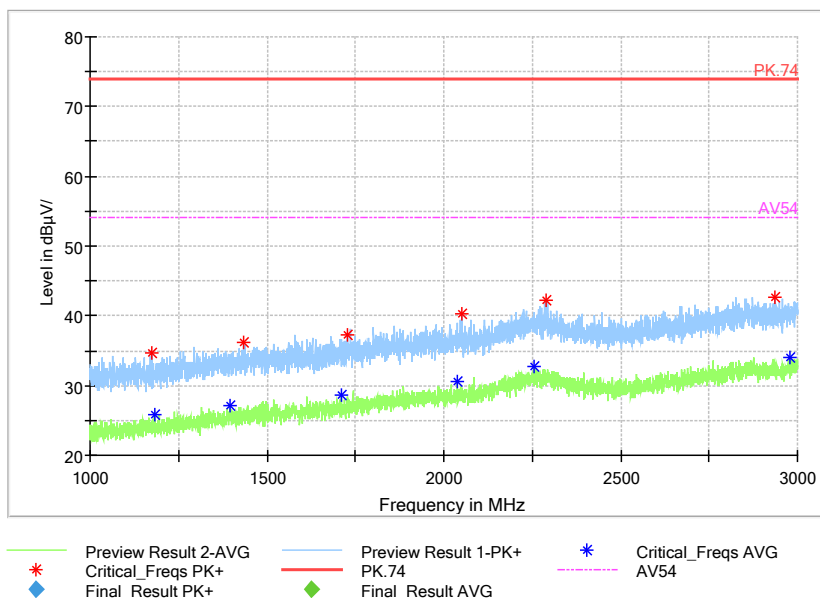

Pic11. Radiated emission (1GHz –3GHz)

Note: The test data in the graph includes two polarizations: horizontal and vertical.

Full Spectrum

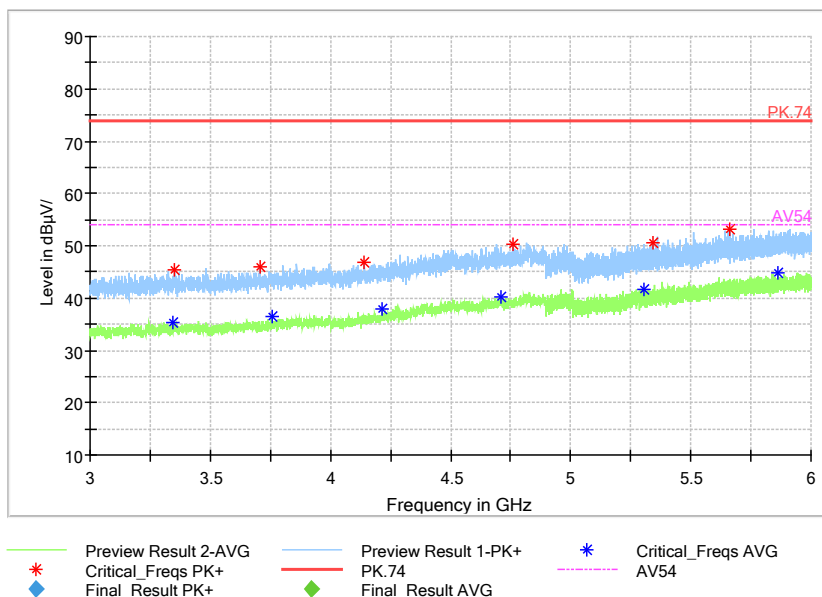

Pic12. Radiated emission (3GHz –6GHz)

Note: The test data in the graph includes two polarizations: horizontal and vertical.

Full Spectrum

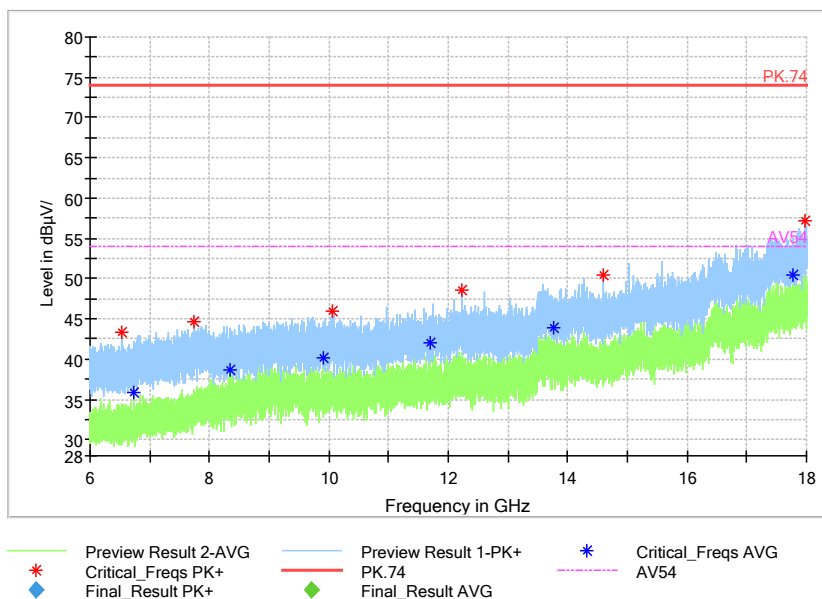

Pic13. Radiated emission (6GHz –18GHz)

Note: The test data in the graph includes two polarizations: horizontal and vertical.

Full Spectrum

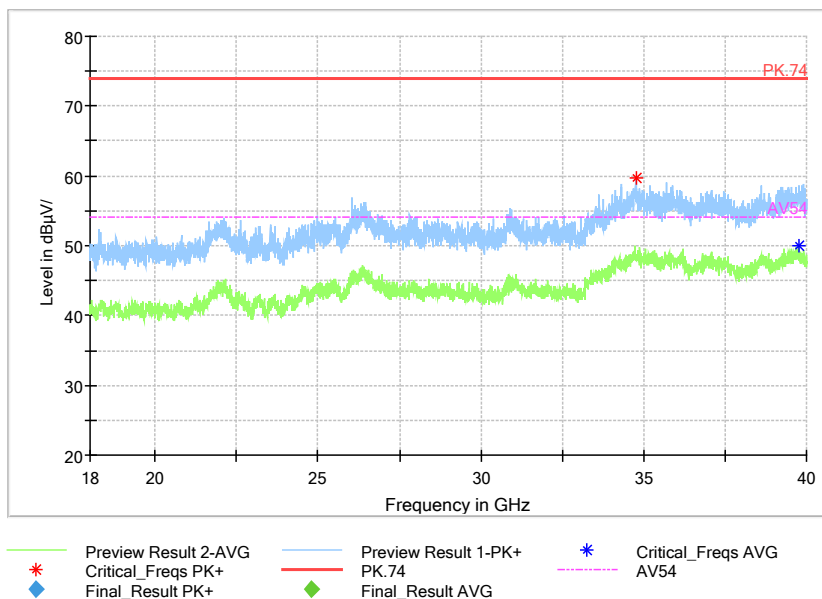

Pic14. Radiated emission (18GHz – 40GHz)

Note: The test data in the graph includes two polarizations: horizontal and vertical.

2.3. List of test equipments

No.	Name/Model	Manufacturer	S/N	Calibration Due Date	Calibration Date
1	23.18m×16.88m×9.60mS emi-AnechoicChamber	FRANKONIA	-----	5th Sep. 2021	6th Sep. 2016
2	ESW EMI test receiver	R&S	101574	20th Aug. 2021	20th Aug. 2020
3	ESR3EMI test receiver	R&S	102361	21th Apr. 2021	21th Apr. 2020
4	9.080m×5.255m×3.525m Shielding room	FRANKONIA	-----	5th Sep. 2021	6th Sep. 2016
5	VULB 9163 Ultra log test antenna	schwarzbeck	867	25th Mar. 2021	25th Mar. 2020
6	HF 907 Double-Ridged Waveguide Horn Antenna	R&S	100512	25th Mar. 2021	25th Mar. 2020
7	SAS-574 Horn Antenna	schwarzbeck	535	20th Aug. 2021	20th Aug. 2020
8	ENV216 AMN	R&S	3560.6550. 12	20th Aug. 2021	20th Aug. 2020
9	EMC32EMI test software	R&S	-----	-----	-----