

TEST REPORT

Report No.: SRTC2020-9003(F)-0057
Product Name: Mobile phone
Model Name: HLTE232E
Applicant: Hisense International Co., Ltd.
Manufacturer: Hisense Communications Co., Ltd.
Specification: FCC Part15B (Certification)
(2020 edition)
ANSI C63.4-2014
FCC ID: 2ADOBHLTE232E

The State Radio_monitoring_center Testing Center (SRTC)

15th Building, No.30 Shixing Street, Shijingshan District,

Beijing, China

Tel: 86-10-57996183 Fax: 86-10-57996388

CONTENTS

1. General information	3
1.1 Notes of the test report	3
1.2 Information about the testing laboratory.....	3
1.3 Applicant's details	3
1.4 Manufacturer's details.....	3
1.5 Application details	4
1.6 Reference specification.....	4
1.7 Information of EUT	4
1.7.1 General information.....	4
1.7.2EUT details	5
1.7.3 Auxiliary equipment details.....	5
2. Test information	7
2.1 Summary of the test results	7
2.2 Test result.....	8
2.2.1Conducted Emissions-FCC Part15.107	8
2.2.2Radiated Emissions-FCC Part15.109.....	15
2.3. List of test equipments	25

1. General information

1.1 Notes of the test report

The test report may only be reproduced or published in full. Reproduction or publication of extracts from the report requires the prior written permission of The State Radio_monitoring_center Testing Center (SRTC).

The test results relate only to individual items of the samples which have been tested.

1.2 Information about the testing laboratory

Company: The State Radio_monitoring_center Testing Center (SRTC)
Address: 15th Building, No.30 Shixing Street, Shijingshan District
Testing location: No.80, Zhaojiachang, BeizangCun, Daxing District, Beijing, China.
City: Beijing
Country or Region: China
Contacted person: Liu Jia
Tel: +86 10 57996183
Fax: +86 10 57996388
Email: liujiaf@srtc.org.cn

1.3 Applicant's details

Company: Hisense International Co., Ltd.
Address: Floor 22, Hisense Tower, 17 Donghai Xi Road, Qingdao, 266071, China
City: Qingdao
Country or Region: China
Contacted person: Geng Ruifeng
Tel: +86-532-80877742
Email: gengruifeng@hisense.com

1.4 Manufacturer's details

Company: Hisense Communications Co., Ltd.
Address: 218 Qianwangang Road, Qingdao Economic & Technological Development Zone, Qingdao, China
City: Qingdao
Country or Region: China
Contacted person: Deng Tingting
Tel: +86-532-55753708
Email: dengtingting@hisense.com

1.5 Application details

Date of reception of test sample: 11th Nov. 2020

Date of test: 11th Nov. 2020 to 20th Nov. 2020

1.6 Reference specification

FCC Part 15B, 2020 (Certification)

1.7 Information of EUT

1.7.1 General information

Product Name of EUT	Mobile phone
Model of EUT	HLTE232E
Marketing Name of EUT	Hisense E50
FCC ID	2ADOBHLTE232E
Frequency Range	GSM850/PCS1900 WCDMA Band 2 / WCDMA Band 4 / WCDMA Band 5 LTE band 2/ LTE band 4 / LTE band 5 / LTE band 7/ LTE band 12/ LTE band 26 Bluetooth: 2.4~2.4835GHz WiFi: 2.4~2.4835GHz
Power Supply	Charger/Battery
Nominal Voltage	3.8V
Extreme Temperature	Lowest: 0°C Highest: +55°C
Extreme Voltage	Minimum: 3.5V Maximum: 4.35V
HW Version	FS185-MB-V5.0
SW Version	Hisense_HLTE232E_10_S01_01_01_MX05_debug _KS232D_0003673_20201107_0713

1.7.2 EUT details

No.	Product Name	Model Name	IMEI
EUT1	Mobile phone	HLTE232E	869130050000392
EUT2	Mobile phone	HLTE232E	869130050001465

Note1: Hisense Communications Co., Ltd. declares that this two Mobile phone is different on the supplier of Camera, Battery and fingerprint.

Note2: In this report, we have test the radiated emissions for both two Mobile phone.

1.7.3 Auxiliary equipment details

AE (Auxiliary Equipment) 1#: Charger

Manufacturer	SHENZHENTIANYIN ELECTRONICS CO., LTD.
Model Number	TPA-46050200UU
Input Voltage	100V-240V AC
Output Voltage	5V DC

AE (Auxiliary Equipment) 2#: Battery

Manufacturer	ShenzhenAerospaceElectronic Co.,Ltd.
Model Number	PLG496590
Capacity	5000mAh
Nominal Voltage	4.4V

AE (Auxiliary Equipment) 3#: Battery

Manufacturer	DONGGUAN MILEY ELECTRONICS CO.,LTD
Model Number	496588P5000
Capacity	5000mAh
Nominal Voltage	4.4V

AE (Auxiliary Equipment) 4#: USB cable

Manufacturer	kelinDongguan Keling Electronic Technology Co., Ltd
Model Number	KS232D

AE (Auxiliary Equipment) 5#: Headset



Manufacturer	kelinDongguan Keling Electronic Technology Co., Ltd
Model Number	KS232D

Note: In this report, EUT1 exercised by the charger AE1, the Battery AE2 , the Usb cable AE4 and the headset AE5 while EUT2 exercised by the charger AE1, the Battery AE3 , the Usb cable AE4 and the headset AE5.

2. Test information

2.1 Summary of the test results

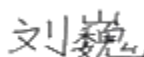
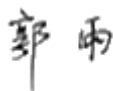
No.	Test case	FCC reference	Verdict
1	Conducted emissions	15.107	Pass
2	Radiated emissions	15.109	Pass

Approved By: Liu Wei Director of the test department 	Checked By: Guo Yu Vice director of the test department 
Tested by: Mr. Lv Youyou Test engineer 	Issued date: 2020.11.20

2.2 Test result

2.2.1 Conducted Emissions-FCC Part15.107

Ambient condition:

Temperature	Relative humidity	Pressure
23.1°C	41.2%	100.8kPa

Test Setup with charger:

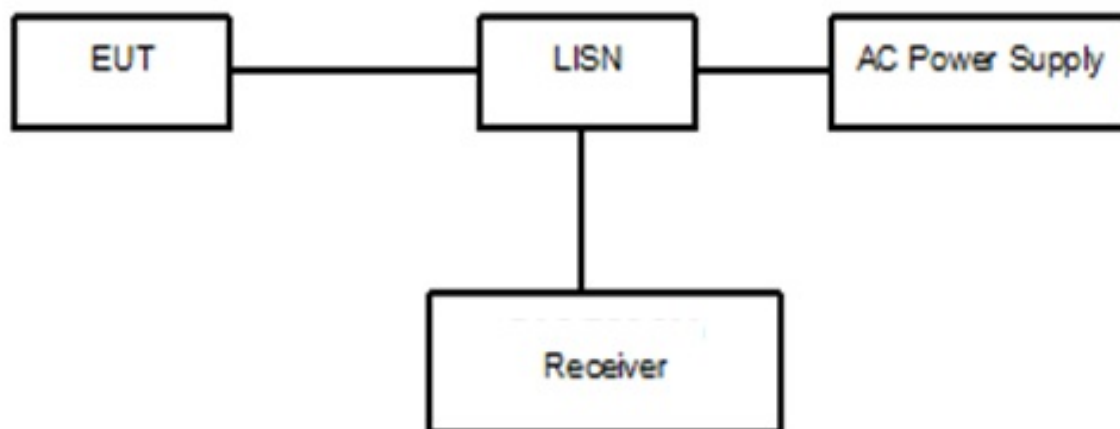

Figure 1

Test Procedure:

The EUT is placed on a non-metallic table 0.8m above the horizontal metal reference ground plane. The EUT is connected with LISN via the charger. The LISN is connected to the reference ground.

The test set-up and the test methods are performed according to ANSI C63.4:2014. Then start the test software EMC32. Sweep the whole frequency band through the range from 150 KHz to 30 MHz with RBW 9kHz, VBW 30kHz. The measurement should be done for both L line and N line. During pre-test, the receiver uses both peak detector and average detector. And the final test, the receiver uses both average detector and Quasi-peak detector.

The data of cable loss has been calibrated in full testing frequency range before the testing.

Test Setup with laptop:

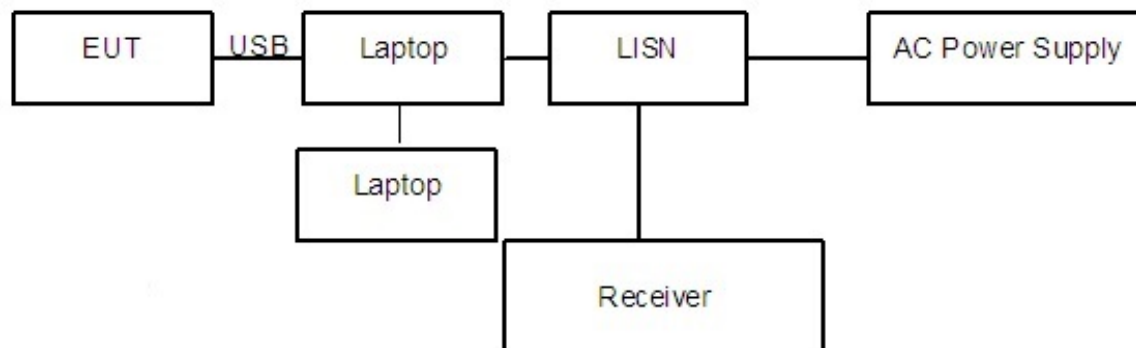

Figure 2

Test Procedure:

The EUT is placed on a non-metallic table 0.8m above the horizontal metal reference ground plane. The accessories of the EUT are connected with the EUT such as headset etc. The EUT was connected with a laptop via the USB cable and was charged. The laptop's LAN port is connected with another laptop via cable. And the data transferring between two laptops is maintained.

The AC main power supply of the laptop is connected to LISN and LISN is connected to the reference ground. The test set-up and the test methods are performed according to ANSI C63.4:2014.

Then start the test software EMC32. Sweep the whole frequency band through the range from 150 KHz to 30 MHz. The measurement should be done for both L line and N line. During pre-test, the receiver uses both peak detector and average detector. And the final test, the receiver uses both average detector and Quasi-peak detector.

The data of cable loss has been calibrated in full testing frequency range before the testing.

A "reference path loss" Corr.(dB) is established and the $L_{cable}+ATT+VDF$ is the attenuation of "reference path loss", and including the cable loss, the attenuation of the attenuator, the voltage division factor of AMN.

The measurement results are obtained as described below:

$$P_{result}=P_{mea}+Corr.(dB)$$

Sample calculation: $(43.90dB\mu V) = (14.3 dB\mu V) + (29.6 dB)$, the corresponding frequency is 0.182648MHz.

Limit:

Frequency of Emission(MHz)	Limits(dB μ V)	
	Quasi-peak	Average
0.15~0.5	66 to 56*	56 to 46*
0.5~5	56	46
5~30	60	50

Note: * Decreases with the logarithm of the frequency

Test result:

Noise Level of the Measuring Instrument

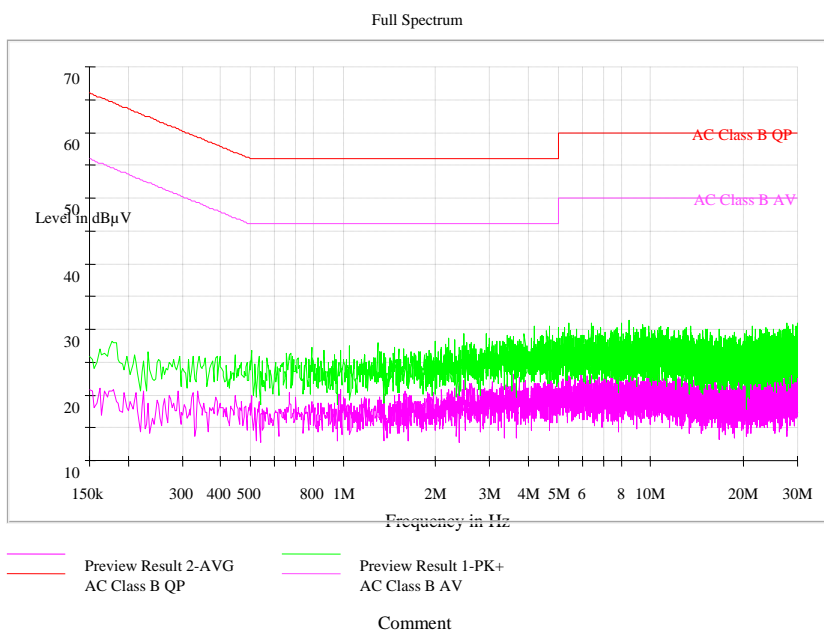

Pic1. Conducted emission L and N Line

EUT1+ charger:

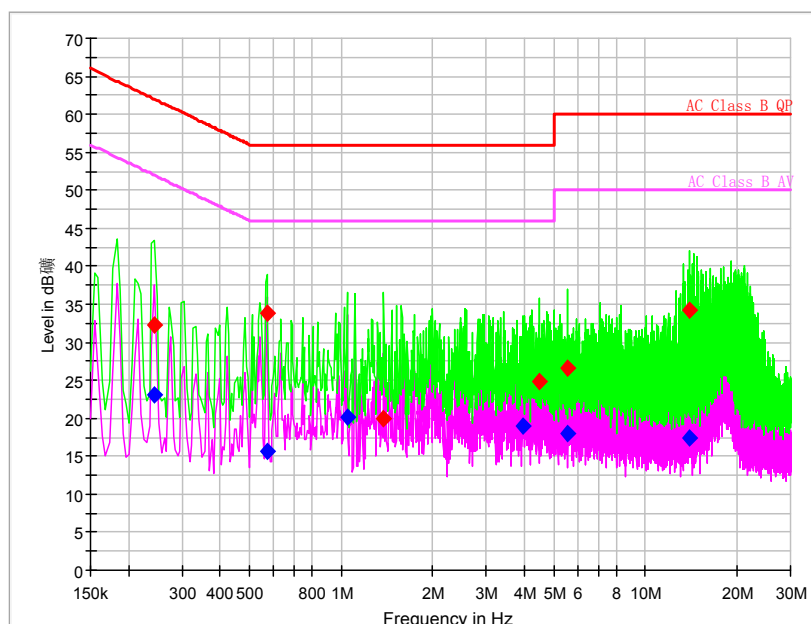

Pic2. Conducted emission L&N Line Voltage: 120VAC

Frequency (MHz)	QuasiPeak (dBµV)	Average (dBµV)	Limit (dBµV)	Margin (dB)	Line	Corr. (dB)	P _{mea} QuasiPeak (dBm)	P _{mea} Average (dBm)
0.243281	---	22.99	51.98	28.99	L1	29.6	---	-6.61
0.243281	32.34	---	61.98	29.65	L1	29.6	2.74	---
0.569766	---	15.62	46.00	30.38	L1	29.6	---	-13.9
0.569766	33.74	---	56.00	22.26	L1	29.6	4.14	---
1.045500	---	20.22	46.00	25.78	L1	29.7	---	-9.48
1.381312	19.87	---	56.00	36.13	L1	29.7	-9.83	---
3.946547	---	18.91	46.00	27.09	L1	29.7	---	-10.7
4.487578	24.78	---	56.00	31.22	L1	29.7	-4.92	---
5.560312	26.51	---	60.00	33.49	L1	29.7	-3.19	---
5.560312	---	18.02	50.00	31.98	L1	29.7	---	-11.6
13.950961	---	17.44	50.00	32.56	L1	29.8	---	-12.3
13.950961	34.18	---	60.00	25.82	N	29.8	4.38	---

EUT1+ charger:

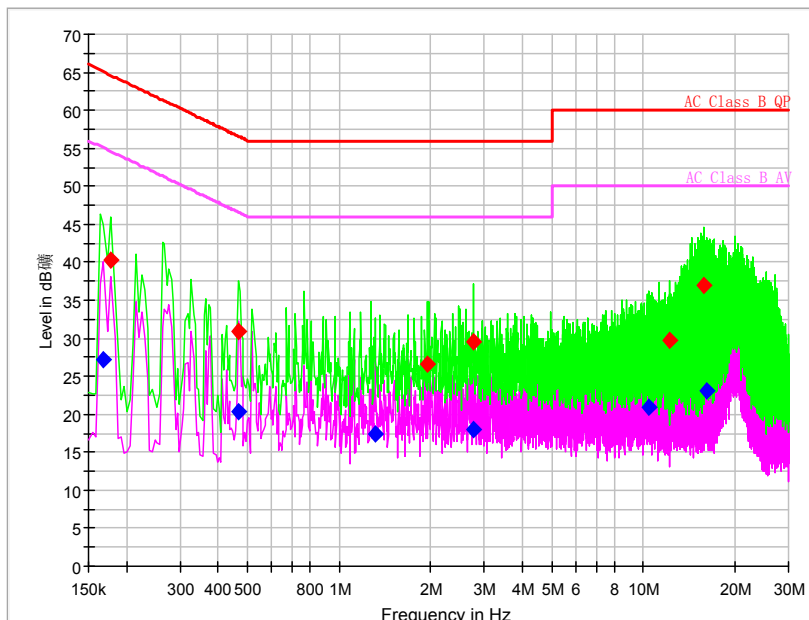

Pic3. Conducted emission L&N Line Voltage: 240VAC

Frequency (MHz)	QuasiPeak (dBµV)	Average (dBµV)	Limit (dBµV)	Margin (dB)	Line	Corr. (dB)	P _{mea} QuasiPeak (dBµV)	P _{mea} Average (dBµV)
0.168656	---	27.21	55.03	27.82	L1	29.6	---	-2.39
0.177984	40.22	---	64.58	24.36	L1	29.6	10.6	---
0.467156	---	20.41	46.56	26.15	L1	29.6	---	-9.19
0.467156	30.85	---	56.56	25.71	L1	29.6	1.25	---
1.316016	---	17.47	46.00	28.53	L1	29.7	---	-12.2
1.954992	26.66	---	56.00	29.34	L1	29.7	-3.04	---
2.761875	29.58	---	56.00	26.42	L1	29.7	-0.12	---
2.761875	---	17.93	46.00	28.07	N	29.7	---	-11.7
10.471570	---	20.83	50.00	29.17	L1	29.7	---	-8.87
12.164625	29.70	---	60.00	30.30	L1	29.8	-0.1	---
15.797930	36.96	---	60.00	23.04	L1	29.8	7.16	---
16.245680	---	23.15	50.00	26.85	N	29.8	---	-6.65

EUT1+Laptop:

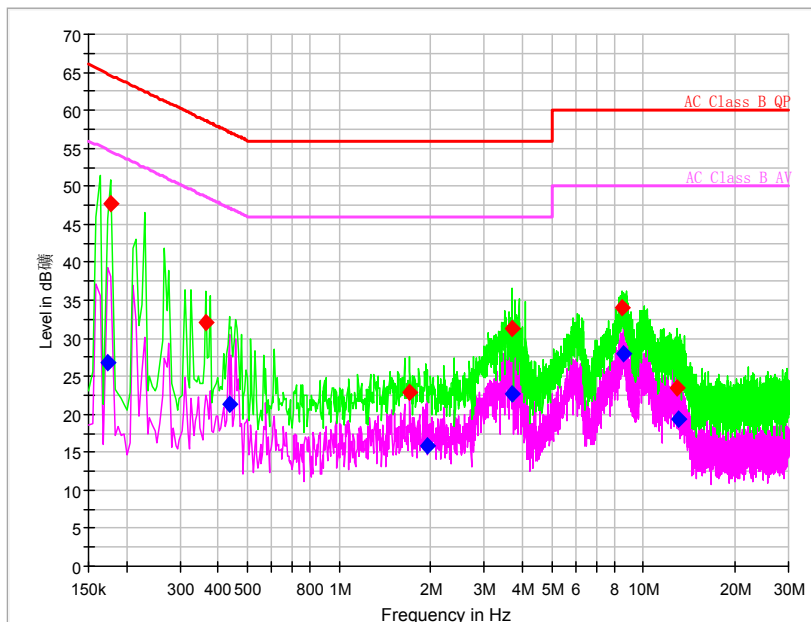

Pic4. Conducted emission L&N Line

Frequency (MHz)	QuasiPeak (dBμV)	Average (dBμV)	Limit (dBμV)	Margin (dB)	Line	Corr. (dB)	Pmea QuasiPeak	Pmea Average
0.173320	---	26.75	54.80	28.05	L1	29.6	---	-2.85
0.177984	47.62	---	64.58	16.96	L1	29.6	18.02	---
0.364547	31.98	---	58.62	26.64	N	29.6	2.38	---
0.434508	---	21.31	47.17	25.86	L1	29.6	---	-8.29
1.707797	22.79	---	56.00	33.21	L1	29.7	-6.91	---
1.954992	---	15.85	46.00	30.16	N	29.7	---	-13.85
3.699352	31.25	---	56.00	24.75	L1	29.7	1.55	---
3.699352	---	22.65	46.00	23.35	N	29.7	---	-7.05
8.535984	34.09	---	60.00	25.91	L1	29.7	4.39	---
8.638594	---	27.92	50.00	22.08	N	29.7	---	-1.78
12.892219	23.37	---	60.00	36.63	L1	29.8	-6.43	---
13.041469	---	19.33	50.00	30.67	L1	29.8	---	-10.47

2.2.2 Radiated Emissions-FCC Part15.109

Ambient condition:

Temperature	Relative humidity	Pressure
22.7°C	41.2%	100.8kPa

Test Setup:

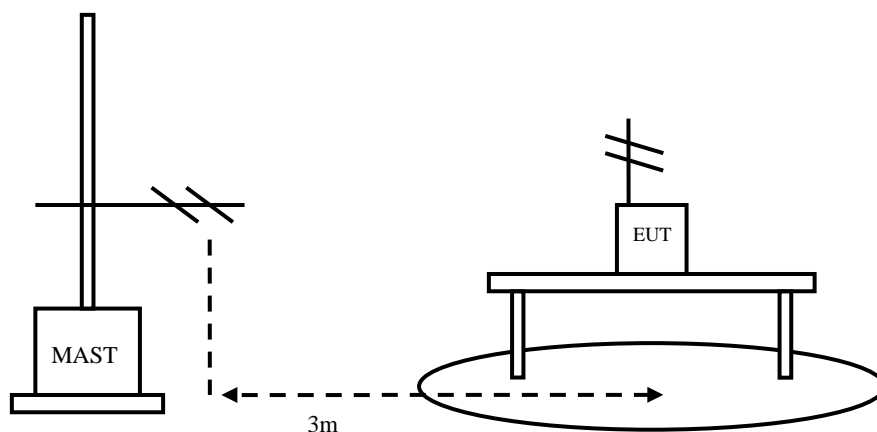

Figure 3

Test Procedure:

EUT+Charger:

The EUT should be placed on a non-metallic table 80cm above the ground plane. The receive antennas shall be moved from 1 to 4 meters. The distance between EUT and receive antenna should be 3 meters.

The EUT should work in idle mode. The function of FM has been open for standby without connect. The test set-up and the test methods are performed according to

ANSI C63.4:2014.

Then start the test software EMC32. Sweep the whole frequency band through the range from 30MHz to 1GHz, using receive log period antenna VULB 9163.

During the test, the height of receive antenna shall be moved from 1 to 4 meters, and the antenna shall be performed under horizontal and vertical polarization. The turn table shall be rotated from 0 to 360 degrees for detecting the maximum of radiated spurious signal level. The measurements shall be repeated with orthogonal polarization of the test antenna. The EUT is laid in two modes as follow:
1. put the EUT in horizontal direction; 2. put the EUT in vertical direction.

The data of cable loss and antenna factor have been calibrated in full testing frequency range before the testing. All test results are performed with max hold at the horizontal and vertical polarity.

RBW=120kHz, VBW=300kHz, when the test frequency: 30MHz<f<1GHz

RBW=1MHz, VBW=3MHz, when the test frequency: f>1GHz

EUT+Laptop:

The EUT should be placed on a non-metallic table 80cm above the ground plane. The receive antennas shall be moved from 1 to 4 meters. The distance between EUT and receive antenna should be 3 meters.

The accessories of the EUT are connected with the EUT such as headset etc. The EUT was connected with a laptop via the USB cable and was charged. The laptop's LAN port is connected with another laptop via cable. And the data transferring between two laptops is maintained. The test set-up and the test methods are performed according to ANSI C63.4:2014

Then start the test software EMC32. Sweep the whole frequency band through the range from 30MHz to 1GHz, using receive log period antenna VULB 9163.

During the test, the height of receive antenna shall be moved from 1 to 4 meters, and the antenna shall be performed under horizontal and vertical polarization. The turn table shall be rotated from 0 to 360 degrees for detecting the maximum of radiated spurious signal level. The measurements shall be repeated with orthogonal polarization of the test antenna. The EUT is laid in two modes as follow:
1. put the EUT in horizontal direction; 2. put the EUT in vertical direction.

The data of cable loss and antenna factor have been calibrated in full testing frequency range before the testing.

A "reference path loss" is established and the A_{Rpl} is the attenuation of "reference path loss", and including the gain of receive antenna, the gain of the preamplifier, the cable loss.

The measurement results are obtained as described below:

Result= $P_{mea} + A_{Rpl}$

Sample calculation: (24.90 dB μ V/m) = (45.8dB μ V) + (-20.9dB/m), the corresponding frequency is 67.599000MHz.

Limit:

Frequency of Emission(MHz)	Limits	
	Detector	Unit (dB μ V/m)
30~88	Quasi-peak	40
88~216	Quasi-peak	43.5
216~960	Quasi-peak	46
960~1000	Quasi-peak	54
1000~5th harmonic of the highest frequency or 40GHz, whichever is lower	Average Peak	54 74

Test result:

EUT1+Charger:

Frequency(MHz)	Result(dBuV/m)	A _{Rpl} (dB/m)	P _{mea} (dBuV)	Polarity
34.219500	25.37	-19.9	45.27	V
82.525500	18.77	-23.1	41.87	V
100.761500	22.73	-18.7	41.43	V
211.390000	13.96	-18.0	31.96	V
526.979500	17.07	-8.6	25.67	V
927.492500	22.35	-1.1	23.45	V

EUT1+Laptop:

Frequency(MHz)	Result(dBuV/m)	A _{Rpl} (dB/m)	P _{mea} (dBuV)	Polarity
51.631000	19.36	-17.3	36.66	V
56.917500	17.78	-18.0	35.78	V
215.997500	26.33	-18.0	44.33	V
263.964000	29.25	-16.1	45.35	V
359.994000	31.99	-13.1	45.09	V
935.543500	23.04	-1.0	24.04	V

EUT2+Charger:

Frequency(MHz)	Result(dBuV/m)	A _{Rpl} (dB/m)	P _{mea} (dBuV)	Polarity
41.494500	20.36	-18.0	38.36	V
59.342500	17.50	-18.3	35.80	V
109.831000	15.89	-19.6	35.49	V
221.090000	18.20	-17.9	36.10	V
550.550500	16.59	-7.9	24.49	V
904.891500	22.23	-1.4	23.63	V

EUT2+Laptop:

Frequency(MHz)	Result(dBuV/m)	A _{Rpl} (dB/m)	P _{mea} (dBuV)	Polarity
53.425500	9.57	-17.6	27.17	V
58.275500	15.37	-18.2	33.57	V
173.172000	13.38	-20.5	33.88	V
263.964000	31.88	-16.1	47.98	V
359.994000	34.12	-13.1	47.22	V
597.935000	27.62	-6.7	34.32	V

EUT1+ charger: refer to Pic5,Pic6 and Pic7

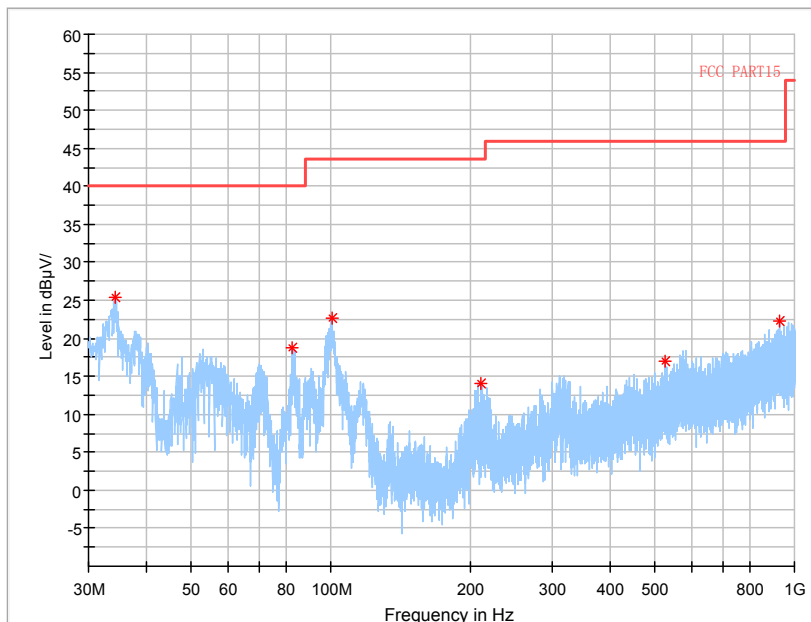

Pic5. Radiated emission (30MHz – 1GHz)

Note: The test data in the graph includes two polarizations: horizontal and vertical

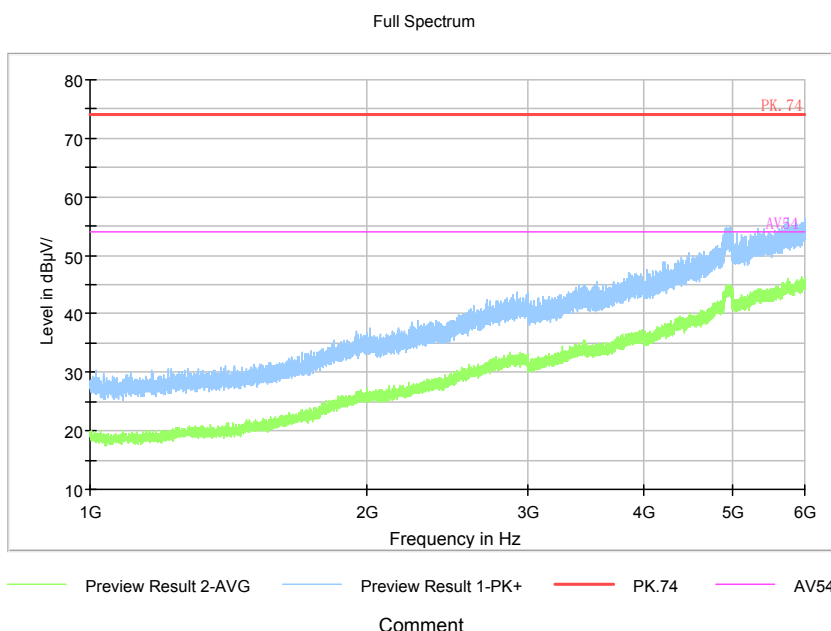

Pic6. Radiated emission (1GHz –6GHz)

Note: The test data in the graph includes two polarizations: horizontal and vertical

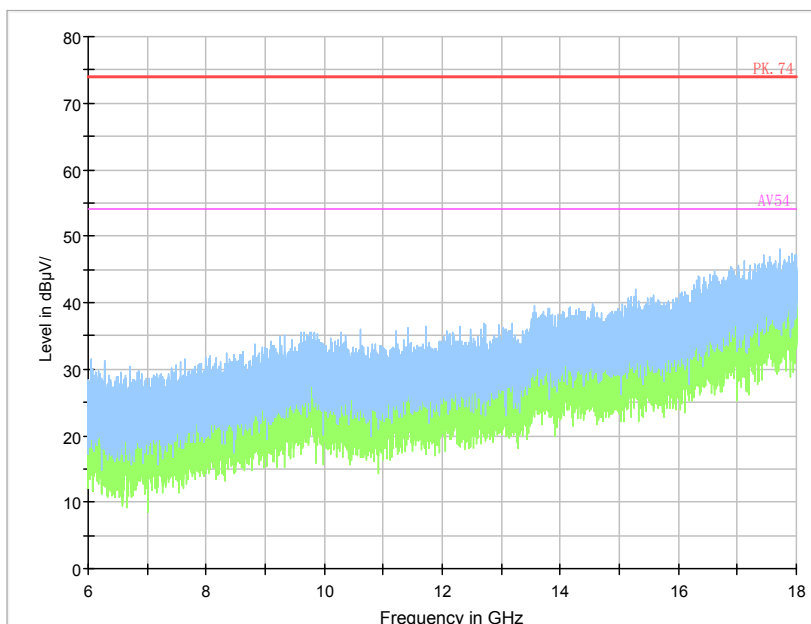

Pic7. Radiated emission (6GHz –18GHz)

Note: The test data in the graph includes two polarizations: horizontal and vertical

EUT1+Laptop: refer to Pic8,Pic9 and Pic10

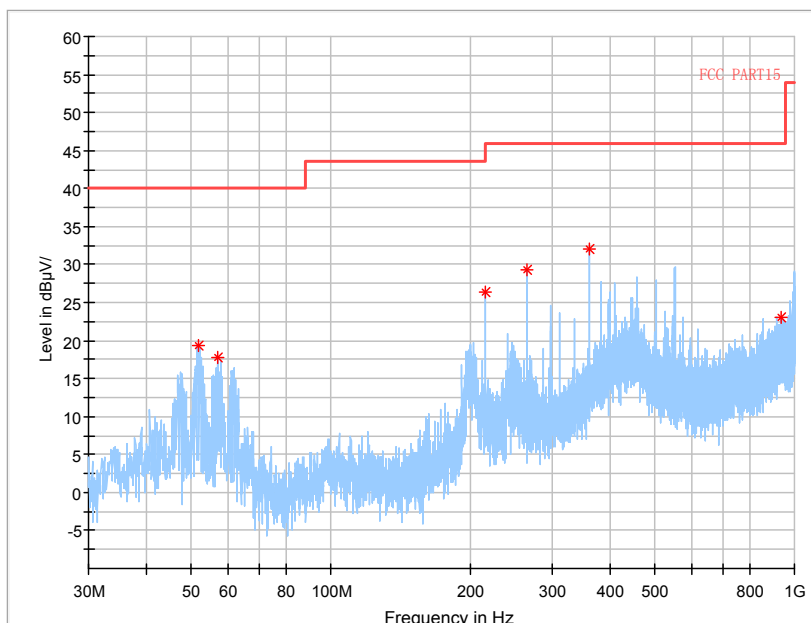

Pic8. Radiated emission(30MHz – 1GHz)

Note: The test data in the graph includes two polarizations: horizontal and vertical

Full Spectrum

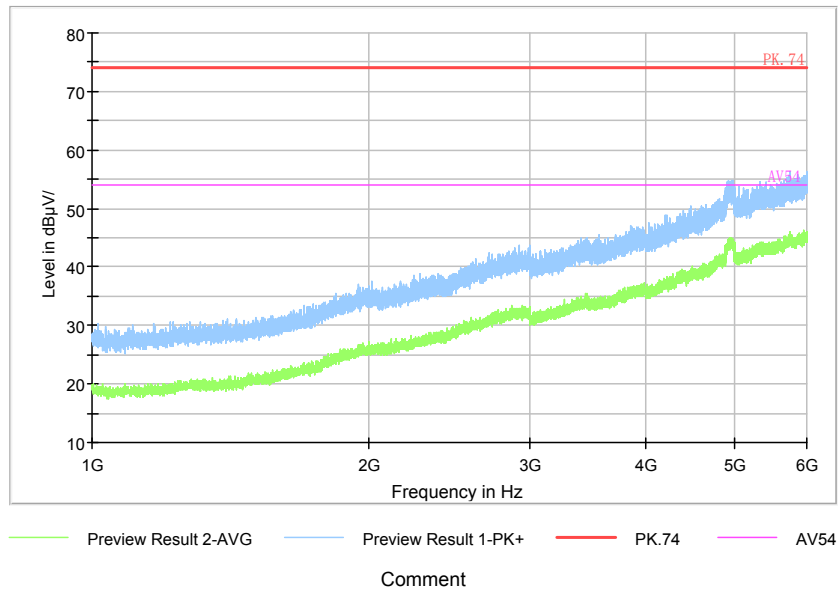

Pic9. Radiated emission (1GHz –6GHz)

Note: The test data in the graph includes two polarizations: horizontal and vertical

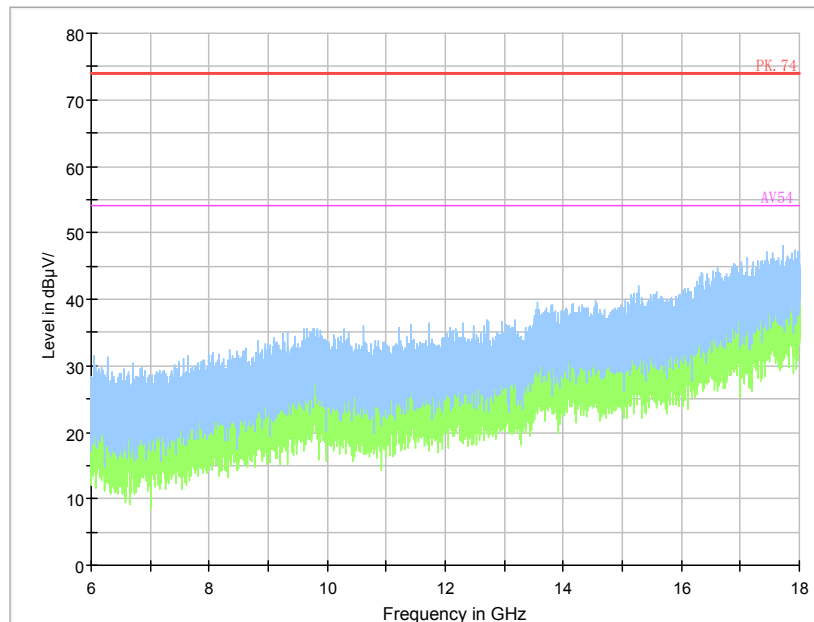

Pic10. Radiated emission (6GHz –18GHz)

Note: The test data in the graph includes two polarizations: horizontal and vertical

EUT2+ charger: refer to Pic11,Pic12 and Pic13

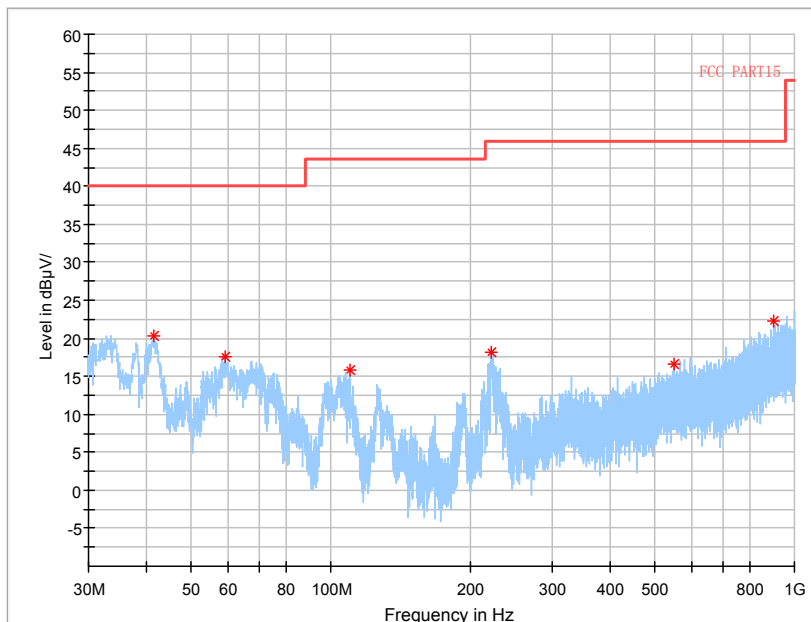

Pic11. Radiated emission (30MHz – 1GHz)

Note: The test data in the graph includes two polarizations: horizontal and vertical

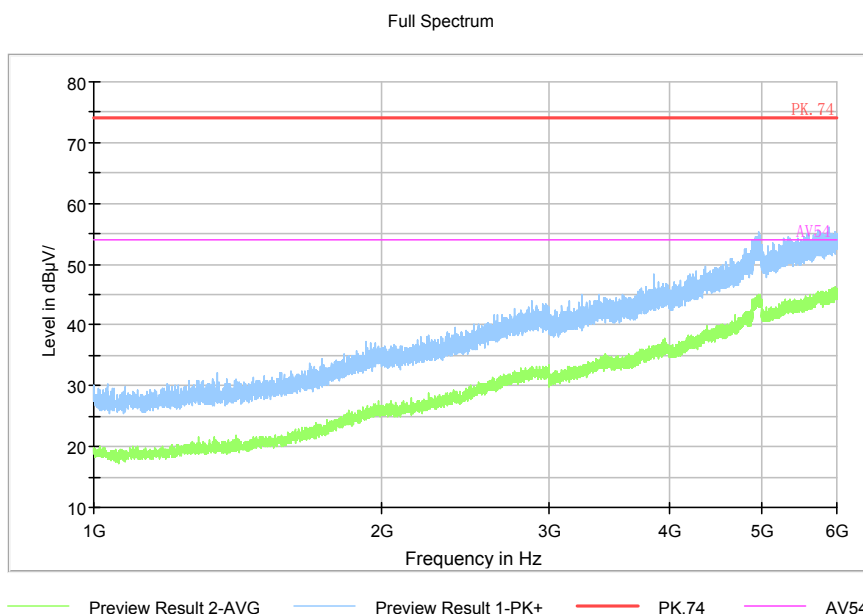

Comment

Pic12. Radiated emission (1GHz –6GHz)

Note: The test data in the graph includes two polarizations: horizontal and vertical

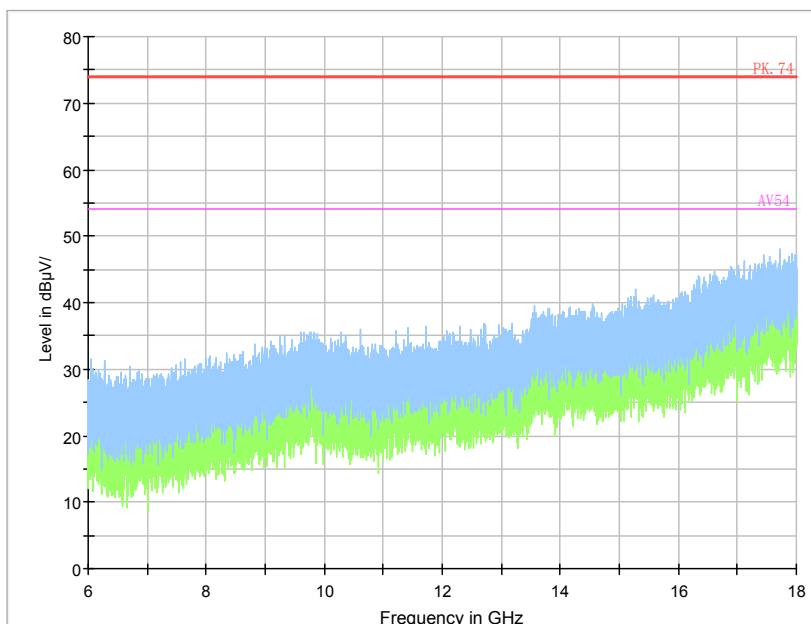

Pic13. Radiated emission (6GHz –18GHz)

Note: The test data in the graph includes two polarizations: horizontal and vertical

EUT2+Laptop: refer to Pic14,Pic15 and Pic16

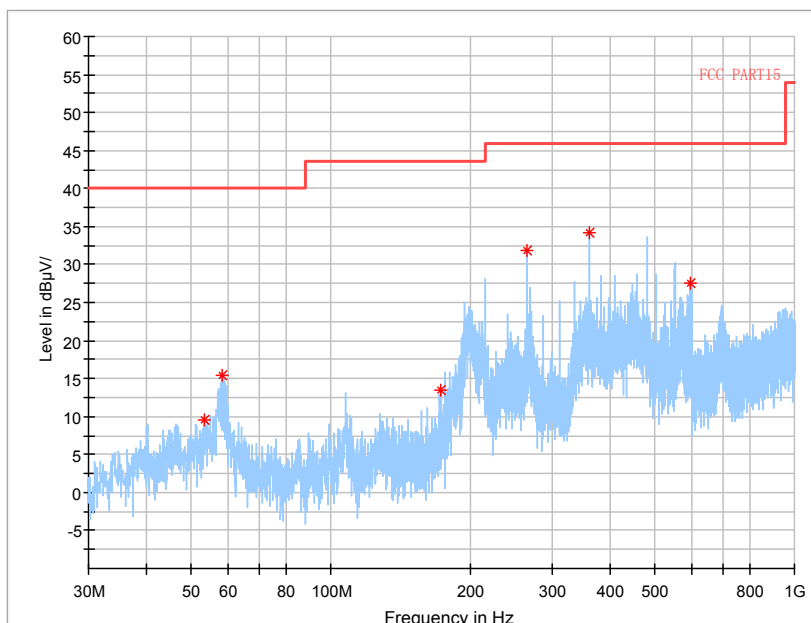

Pic14. Radiated emission (30MHz – 1GHz)

Note: The test data in the graph includes two polarizations: horizontal and vertical

Full Spectrum

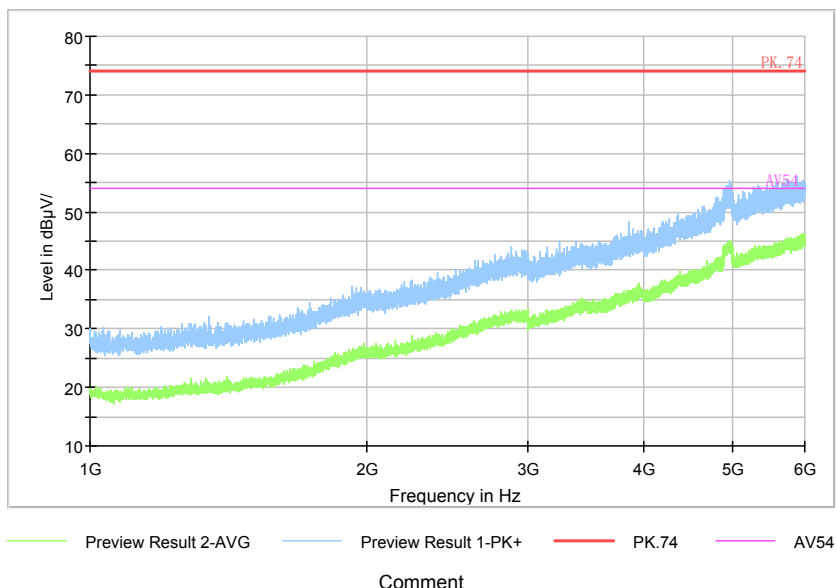

Comment

Pic15. Radiated emission (1GHz –6GHz)

Note: The test data in the graph includes two polarizations: horizontal and vertical

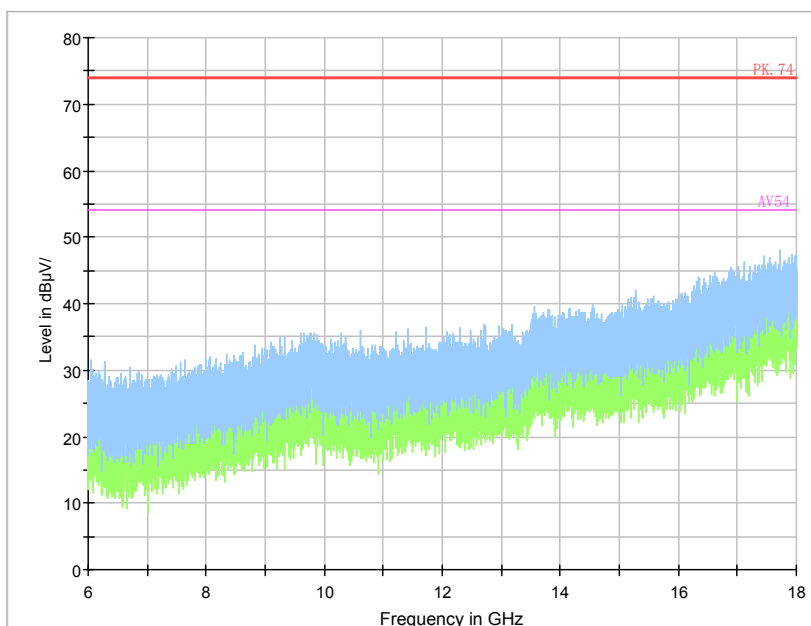

Pic16. Radiated emission (6GHz –18GHz)

Note: The test data in the graph includes two polarizations: horizontal and vertical

2.3. List of test equipments

No.	Name/Model	Manufacturer	S/N	Calibration Due Date	Calibration Date
1	23.18m×16.88m×9.60mS emi-AnechoicChamber	FRANKONIA	-----	5th Sep. 2021	6th Sep. 2016
2	ESW EMI test receiver	R&S	101574	20th Aug. 2021	20th Aug. 2020
3	CMW500 Mobile Station Tester	R&S	160132	20th Aug. 2021	20th Aug. 2020
4	9.080m×5.255m×3.525m Shielding room	FRANKONIA	-----	5th Sep. 2021	6th Sep. 2016
5	ESIB7 EMI test receiver	R&S	100280	20th Aug. 2021	20th Aug. 2020
6	VULB 9163Ultra log test antenna	R&S	867	20th Aug. 2021	20th Aug. 2020
7	ENV216 AMN	R&S	3560.6550. 12	20th Aug. 2021	20th Aug. 2020
8	HF 907 Double-Ridged Waveguide Horn Antenna	R&S	100512	20th Aug. 2021	20th Aug. 2020
9	PS2000 Turn Table	FRANKONIA	-----	-----	-----
10	MA260 Antenna Master	FRANKONIA	-----	-----	-----
11	EMC32EMI test software	R&S	-----	-----	-----

-----The end-----