

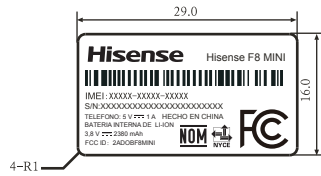

NO.	REVISION DESCRIPTION	DRAWN	APPROVED	DATE
A				
B				



NO.	DESCRIPTION	MAT'L	DRAWING NO.	QTY	REMARK
			TITLE HANDSET Label		
			DRAWING NO.		SHEET
			A4-		
			Hisense		REV.
	JIANG Yimin				

NO.	REVISION DESCRIPTION	DRAWN	APPROVED	DATE
A				
B				

80 mm

<p>IMPORTADOR: Hisense México S. de R.L. de C.V. Bld. Miguel de Cervantes Saavedra, No. 301 Torre Norte, Piso 2, Col. Ampliación Granada, Municipio o Demarcación Territorial Miguel Hidalgo, C.P. 11520, Ciudad de México, R.F.C. HME1105121Y3</p> <p>MARCA: HISENSE MODELO: Hisense F8 MINI</p> <p>CARACTERISTICAS ELECTRICAS: TELEFONO: 5 V \Rightarrow 1 A BATERIA RECARGABLE 3,8 V \Rightarrow 2380 mAh HECHO EN CHINA</p>  <p>6 9 4 1 7 8 5 1 7 0 8 7 5 7 1</p> <p>SIN: 1MH75CW9MX1CN0XXXXXXXXXX</p>	<p>INCLUYE: ADAPTADOR MARCA: HISENSE Hisense F8 MINI Color:NEGRO MODELO: A31-501000 FCC ID:2AD0BF8MINI</p> <p>ENT: 100-240 V ~ 50/60 Hz 0,15 A SAL: 5,0 V \Rightarrow 1 A</p> <p>BATERIA RECARGABLE MARCA: HISENSE MODELO: LIW38238 3,8 V \Rightarrow 2380 mAh Hisense Communications Co., Ltd.</p> <p>AURICULAR MANOS LIBRES SIN MARCA SIN MODELO</p> <p>El equipo que esta comprando esta bloqueado y sólo puede utilizarse en la red de AT&T. Para tramitar su desbloqueo acude a tu tienda AT&T más cercana.</p>
--	---

Modelo:Hisense F8 MINI Color:NEGRO



IMEI: XXXX-XXXX-XXXX

Modelo:Hisense F8 MINI Color:NEGRO



IMEI: XXXX-XXXX-XXXX

Modelo:Hisense F8 MINI Color:NEGRO



IMEI: XXXX-XXXX-XXXX

NO.	DESCRIPTION	MAT'L	DRAWING NO.	Q'TY	REMARK
MAT'L		TITLE Giftbox Label			
FINISH					
SCALE	DATE	UNIT	DRAWING NO.		SHEET
		mm	A4-		
DRAWN	CHECKED	APPROVED	Hisense		REV.
JIANG Yimin					

NO.	REVISION DESCRIPTION	DRAWN	APPROVED	DATE
A				
B				

IMPORTADOR:
Hisense México S. de R.L. de C.V.
Bld. Miguel de Cervantes Saavedra,
No. 301 Torre Norte, Piso 2,
Col. Ampliación Granada,
Municipio o Demarcación Territorial
Miguel Hidalgo,
C.P. 11520, Ciudad de México,
R.F.C. HME1105121Y3

MARCA: HISENSE
MODELO: Hisense F8 MINI

CARACTERISTICAS ELECTRICAS:
TELEFONO: 5 V \Rightarrow 1 A
BATERIA RECARGABLE
3,8 V \Rightarrow 2380 mAh
HECHO EN CHINA



6 1941785117091501

SIN: 1MH75CW9MX1DC0XXXXXXXXXX

INCLUYE:
ADAPTADOR
MARCA: HISENSE
MODELO: A31-501000
ENT: 100-240 V ~ 50/60 Hz 0,15 A
SAL: 5,0 V \Rightarrow 1 A



BATERIA RECARGABLE
MARCA: HISENSE
MODELO: LIW38238
3,8 V \Rightarrow 2380 mAh

AURICULAR MANOS LIBRES
SIN MARCA
SIN MODELO

El equipo que esta comprando esta
bloqueado y sólo puede utilizarse en la
red de AT&T. Para tramitar su desbloqueo
acude a tu tienda AT&T más cercana.



Hisense F8 MINI Color:ROSA
FCC ID:2AD0BF8MINI





Modelo:Hisense F8 MINI Color:ROSA



IMEI: XXXX-XXXX-XXXX

Modelo:Hisense F8 MINI Color:ROSA



IMEI: XXXX-XXXX-XXXX

Modelo:Hisense F8 MINI Color:ROSA



IMEI: XXXX-XXXX-XXXX

80 mm

55 mm

15 mm

15 mm

NO.	DESCRIPTION	MAT'L	DRAWING NO.	Q'TY	REMARK
MAT'L		TITLE Giftbox Label			
FINISH					
SCALE	DATE	UNIT	DRAWING NO.		SHEET
		mm	A4-		
DRAWN	CHECKED	APPROVED	Hisense		REV.
JIANG Yimin					

NO.	REVISION DESCRIPTION	DRAWN	APPROVED	DATE
				
				

Hisense Modelo:Hisense F8 MINI Color:NEGRO
 Ctd:20 PZS Hecho en China

Peso Neto: KG
 Dimensiones: 43.0×35.6×22.8 CM

Caja ID: F8MINIXXXXXXXXXX



6 941785 708757



IMEI:XXXXXXXXXXXXXXXX



IMEI:XXXXXXXXXXXXXXXX



IMEI:XXXXXXXXXXXXXXXX



IMEI:XXXXXXXXXXXXXXXX



IMEI:XXXXXXXXXXXXXXXX



IMEI:XXXXXXXXXXXXXXXX



IMEI:XXXXXXXXXXXXXXXX



IMEI:XXXXXXXXXXXXXXXX



IMEI:XXXXXXXXXXXXXXXX



IMEI:XXXXXXXXXXXXXXXX



IMEI:XXXXXXXXXXXXXXXX



IMEI:XXXXXXXXXXXXXXXX



IMEI:XXXXXXXXXXXXXXXX



IMEI:XXXXXXXXXXXXXXXX



IMEI:XXXXXXXXXXXXXXXX



IMEI:XXXXXXXXXXXXXXXX



IMEI:XXXXXXXXXXXXXXXX



IMEI:XXXXXXXXXXXXXXXX



IMEI:XXXXXXXXXXXXXXXX



IMEI:XXXXXXXXXXXXXXXX



IMEI:XXXXXXXXXXXXXXXX

4*4cm 二维码

SIZE:TBD

NO.	DESCRIPTION	MAT'L	DRAWING NO.	QTY	REMARK
			TITLE Carton Box Label		
			DRAWING NO.		SHEET
			A4-		
			Hisense		REV.
JIANG Yimin					

NO.	REVISION DESCRIPTION	DRAWN	APPROVED	DATE
△				
△				













Hisense Modelo:Hisense F8 MINI Color:ROSA
Ctd: 20 PZS Hecho en China















Peso Neto: KG
Dimensiones: 43.0×35.6×22.8 CM

Caja ID: F8MINIXXXXXXXXXX

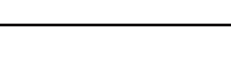

6 1941785 1709150

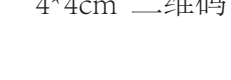

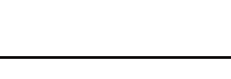

4*4cm 二维码

SIZE:TBD

NO.	DESCRIPTION	MAT'L	DRAWING NO.	QTY	REMARK
MAT'L		TITLE			
FINISH		Carton Box Label			
SCALE	DATE	UNIT	DRAWING NO.		SHEET
		mm	A4-		
DRAWN	CHECKED	APPROVED	Hisense		REV.
JIANG Yimin					





























NO.	REVISION DESCRIPTION	DRAWN	APPROVED	DATE
				
				

Hisense



N° TARIMA: 78700000001



CLIENTE: AT&T
 N° ORDEN: 100XXXXXX
 MODELO: Hisense F8 MINI
 COLOR: NEGRO
 CANTIDAD: 600 PZS
 PESO: KGS

 675000001001	 675000001016
 675000001002	 675000001017
 675000001003	 675000001018
 675000001004	 675000001019
 675000001005	 675000001020
 675000001006	 675000001021
 675000001007	 675000001022
 675000001008	 675000001023
 675000001009	 675000001024
 675000001010	 675000001025
 675000001011	 675000001026
 675000001012	 675000001027
 675000001013	 675000001028
 675000001014	 675000001029
 675000001015	 675000001030

托盘标贴中的箱号以市场输入为准

SIZE: TBD

NO.	DESCRIPTION	MAT'L	DRAWING NO.	QTY	REMARK
MAT'L		TITLE			
FINISH		Pallet Label			
SCALE	DATE	UNIT	DRAWING NO.		SHEET
		mm	A4-		
DRAWN	CHECKED	APPROVED	Hisense		REV.
JIANG Yimin					





























NO.	REVISION DESCRIPTION	DRAWN	APPROVED	DATE
				
				

Hisense



N° TARIMA: 787000000001

CLIENTE: AT&T
 N° ORDEN: 100XXXXXX
 MODELO: Hisense F8 MINI
 COLOR: ROSA
 CANTIDAD: 600 PZS
 PESO: KGS

 675000001001	 675000001016
 675000001002	 675000001017
 675000001003	 675000001018
 675000001004	 675000001019
 675000001005	 675000001020
 675000001006	 675000001021
 675000001007	 675000001022
 675000001008	 675000001023
 675000001009	 675000001024
 675000001010	 675000001025
 675000001011	 675000001026
 675000001012	 675000001027
 675000001013	 675000001028
 675000001014	 675000001029
 675000001015	 675000001030

托盘标贴中的箱号以市场输入为准

SIZE: TBD

NO.	DESCRIPTION	MAT'L	DRAWING NO.	QTY	REMARK
MAT'L		TITLE			
FINISH		Pallet Label			
SCALE	DATE	UNIT	DRAWING NO.		SHEET
		mm	A4-		
DRAWN	CHECKED	APPROVED	Hisense		REV.
JIANG Yimin					