



*Full*

# TEST REPORT

**No. I18D00198-SRD06**

*For*

**Client : Hisense International Co., Ltd.**

**Production : Mobile Phone**

**Model Name : Hisense F23 PLUS**

**FCC ID: 2AD0BF23PLUS**

**Hardware Version: YK736-MB-V0.2**

**Software Version: Hisense\_F17\_4G\_10\_S01\_20180118**

**Issued date: 2018-10-12**

**Note:**

The test results in this test report relate only to the devices specified in this report. This report shall not be reproduced except in full without the written approval of ECIT Shanghai.

**Test Laboratory:**

ECIT Shanghai, East China Institute of Telecommunications

Add: 7-8F, G Area, No.668, Beijing East Road, Huangpu District, Shanghai, P. R. China

Tel: (+86)-021-63843300, E-Mail: [welcome@ecit.org.cn](mailto:welcome@ecit.org.cn)



# RF Test Report

Report No.: I18D00198-SRD06

## Revision Version

Report Number	Revision	Date	Memo
I18D00198-SRD06	00	2018-10-12	Initial creation of test report

**CONTENTS**

<b>1. TEST LABORATORY.....</b>	<b>5</b>
<b>1.1. TESTING LOCATION.....</b>	<b>5</b>
<b>1.2. TESTING ENVIRONMENT.....</b>	<b>5</b>
<b>1.3. PROJECT DATA.....</b>	<b>5</b>
<b>1.4. SIGNATURE.....</b>	<b>5</b>
<b>2. CLIENT INFORMATION.....</b>	<b>6</b>
<b>2.1. APPLICANT INFORMATION.....</b>	<b>6</b>
<b>2.2. MANUFACTURER INFORMATION.....</b>	<b>6</b>
<b>3. EQUIPMENT UNDER TEST (EUT) AND ANCILLARY EQUIPMENT (AE).....</b>	<b>7</b>
<b>3.1. ABOUT EUT.....</b>	<b>7</b>
<b>3.2. INTERNAL IDENTIFICATION OF EUT USED DURING THE TEST.....</b>	<b>7</b>
<b>3.3. INTERNAL IDENTIFICATION OF AE USED DURING THE TEST.....</b>	<b>7</b>
<b>4. REFERENCE DOCUMENTS.....</b>	<b>8</b>
<b>4.1. REFERENCE DOCUMENTS FOR TESTING.....</b>	<b>8</b>
<b>5. SUMMARY OF TEST RESULTS.....</b>	<b>9</b>
<b>5.1. NOTES.....</b>	<b>10</b>
<b>5.2. STATEMENTS.....</b>	<b>10</b>
<b>6. TEST RESULT.....</b>	<b>11</b>
<b>6.1. MEASUREMENT METHOD.....</b>	<b>11</b>
<b>6.2. MAXIMUM OUTPUT POWER.....</b>	<b>12</b>
<b>6.3. PEAK POWER SPECTRAL DENSITY (CONDUCTED).....</b>	<b>13</b>
<b>6.4. OCCUPIED 26DB BANDWIDTH(CONDUCTED).....</b>	<b>14</b>
<b>6.5 99% OCCUPIED BANDWIDTH(CONDUCTED).....</b>	<b>20</b>
<b>6.6. BAND EDGES COMPLIANCE.....</b>	<b>28</b>
<b>6.6.1 BAND EDGES - CONDUCTED.....</b>	<b>28</b>



**6.6.2 BAND EDGES - RADIATED..... 30**

**6.7. TRANSMITTER SPURIOUS EMISSION..... 35**

**6.8. CONDUCTED EMISSION (150KHZ- 30MHZ).....51**

**6.9 DFS.....53**

**6.10. FREQUENCY STABILITY.....56**

**6.11. POWER CONTROL.....56**

**7. TEST EQUIPMENT AND ANCILLARIES USED FOR TESTS..... 57**

**8. TEST ENVIRONMENT..... 58**

**ANNEX A. ACCREDITATION CERTIFICATE..... 59**

## 1. Test Laboratory

### 1.1. Testing Location

Company Name:	ECIT Shanghai, East China Institute of Telecommunications
Address:	7-8F, G Area, No. 668, Beijing East Road, Huangpu District, Shanghai, P. R. China
Postal Code:	200001
Telephone:	(+86)-021-63843300
Fax:	(+86)-021-63843301

### 1.2. Testing Environment

Normal Temperature:	15-35°C
Extreme Temperature:	-30/+50°C
Relative Humidity:	20-75%

### 1.3. Project data

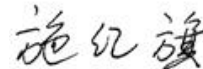
Project Leader:	Xu Yuting
Testing Start Date:	2018-02-02
Testing End Date:	2018-03-22

### 1.4. Signature



Yang Dejun

(Prepared this test report)



Shi Hongqi

(Reviewed this test report)



Zheng Zhongbin

(Approved this test report)

## 2. Client Information

### 2.1. Applicant Information

Company Name: Hisense International Co., Ltd.  
Address: Floor 22, Hisense Tower, 17 Donghai Xi Road, Qingdao, 266071,  
China  
Telephone: NA  
Postcode: 266010

### 2.2. Manufacturer Information

Company Name: Hisense Communications Co., Ltd.  
Address: 218 Qianwangang Road, Economic & Technological Development  
Zone, Qingdao, Shandong Province, P.R. China  
Telephone: NA  
Postcode: 266510

### 3. Equipment Under Test (EUT) and Ancillary Equipment (AE)

#### 3.1. About EUT

EUT Description	Mobile Phone
Model name	Hisense F23 PLUS
WLAN Frequency Range	ISM Bands: 5150MHz~5350MHz 5725MHz~5850MHz
WLAN type of modulation	OFDM
DFS	Client Without Radar Detection
Extreme Temperature	-30/+50°C
Nominal Voltage	3.8V
Extreme High Voltage	4.35V
Extreme Low Voltage	3.5V

Note: Photographs of EUT are shown in ANNEX A of this test report.

#### 3.2. Internal Identification of EUT used during the test

EUT ID*	SN or IMEI	HW Version	SW Version	Date of receipt
N14(secondary supply)	86185403932006 2	YK736-MB-V0.2	Hisense_F17_4G_10_ S01_20180118	2018-01-24
N09(main supply)	86185403932006 2	YK736-MB-V0.2	Hisense_F17_4G_10_ S01_20180118	2018-01-24
N08(main supply)	NA	YK736-MB-V0.2	Hisense_F17_4G_10_ S01_20180118	2018-01-24

\*EUT ID: is used to identify the test sample in the lab internally.

#### 3.3. Internal Identification of AE used during the test

AE ID*	Description	SN
AE1	RF cable	---
AE2	---	---

\*AE ID: is used to identify the test sample in the lab internally.

## 4. Reference Documents

### 4.1. Reference Documents for testing

The following documents listed in this section are referred for testing.

Reference	Title	Version
FCC Part15	Title 47 of the Code of Federal Regulations; Chapter I Part 15 - Radio frequency devices	2017
ANSI 63.10	Methods of Measurement of Radio-Noise Emissions from Low-Voltage Electrical and Electronic Equipment in the Range of 9 kHz to 40 GHz	2013
UNII: KDB 789033	Information Infrastructure (U-NII) Devices - Part 15, Subpart E	2017
KDB905462	COMPLIANCE MEASUREMENT PROCEDURES FOR UNLICENSED-NATIONAL INFORMATION INFRASTRUCTURE DEVICES OPERATING IN THE 5250-5350 MHz AND 5470-5725 MHz BANDS INCORPORATING DYNAMIC FREQUENCY SELECTION	2016



## 5. Summary of Test Results

A brief summary of the tests carried out is shown as following.

<b>SUMMARY OF MEASUREMENT RESULTS</b>	<b>Sub-clause of Part15E</b>	<b>Sub-clause of IC</b>	<b>Verdict</b>
Maximum Output Power	15.407	/	<b>P</b>
Power Spectral Density	15.407	/	<b>P</b>
Occupied 26dB Bandwidth	15.407	/	<b>P</b>
99% Occupied Bandwidth	15.407	/	<b>P</b>
Band edge compliance	15.407	/	<b>P</b>
Transmitter spurious emissions radiated	15.407	/	<b>P</b>
Conducted Emission	15.407	/	<b>P</b>
DFS	15.407	/	<b>P</b>
Frequency Stability	15.407	/	<b>NA</b>
Transmit Power Control	15.407	/	<b>NA</b>

Please refer to section 6 for detail.

Terms used in Verdict column

P	Pass, the EUT complies with the essential requirements in the standard.
NP	Not Perform, the test was not performed by ECIT.
NA	Not Applicable, the test was not applicable.
F	Fail, the EUT does not comply with the essential requirements in the standard.

Test Conditions

Tnom	Normal temperature
Tmin	Low Temperature
Tmax	High Temperature
Vnom	Normal Voltage
Vmin	Low Voltage
Vmax	High Voltage
Hnom	Norm Humidity
Anom	Norm Air Pressure

For this report, all the test case listed above are tested under Normal Temperature and Normal Voltage, and also under norm humidity, the specific conditions as following:

Temperature	Tnom	22°C
Voltage	Vnom	3.8V
Humidity	Hnom	47%

**5.1. Notes**

All reported tests were carried out on a sample equipment to demonstrate limited compliance with section 3.

The test results of this test report relate exclusively to the item(s) tested as specified in section 5.

**5.2. Statements**

The Hisense F23 PLUS, supporting GSM/GPRS/EDGE/WCDMA/LTE/WLAN/BT/BLE, manufactured by Hisense Communications Co., Ltd., which is a variant product for testing. The content of these changes are LCD Module /camera(back and front)/fingerprint module. According to the Product Change Description, the alterations do not affect any performance,so all the test results please refer to the Original test report I18D00020-SRD06. which was prepared by East China Institute of Telecommunications.

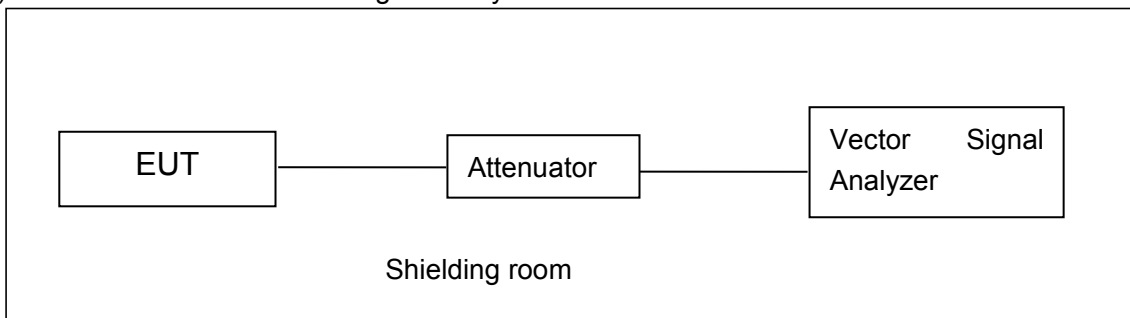
ECIT has verified that the compliance of the tested device specified in section 5 of this test report is successfully evaluated according to the procedure and test methods as defined in type certification requirement listed in section 5 of this test report.

## 6. Test result

### 6.1. Measurement Method

#### 6.1.1. Conducted Measurements

- 1). Connect the EUT to the test system correctly.
- 2). Set the EUT to the required work mode.
- 3). Set the EUT to the required channel.
- 4). Set the spectrum analyzer to start measurement.
- 5). Record the values. Vector Signal Analyzer

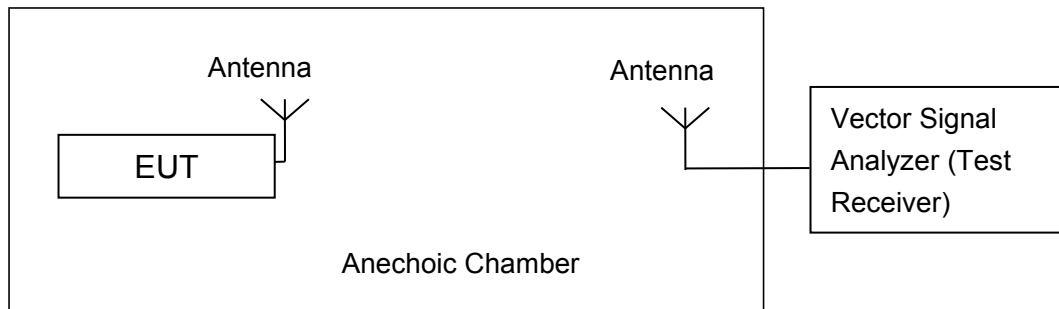


#### 6.1.2. Radiated Emission Measurements

In the case of radiated emission, the used settings are as follows,

Sweep frequency from 30 MHz to 1GHz, RBW = 100 kHz, VBW = 300 kHz;

Sweep frequency from 1 GHz to 26GHz, RBW = 1MHz, VBW = 10Hz;



The measurement is made according to KDB 789033

The radiated emission test is performed in semi-anechoic chamber. The distance from the EUT to the reference point of measurement antenna is 3m. The test is carried out on both vertical and horizontal polarization and only maximization result of both polarizations is kept. During the test, the turntable is rotated 360° and the measurement antenna is moved from 1m to 4m to get the maximization result.

## 6.2. Maximum output Power

**Measurement Limit and Method:**

Standard	Frequency (MHz)	Limit (dBm)
FCC CRF Part 15.407(a)	5150MHz~5250MHz	24dBm
	5250MHz~5350MHz	24dBm or 11+10logB
	5470MHz~5725MHz	24dBm or 11+10logB

Limit use the less value, and B is the 26dB bandwidth.

The measurement method SA-1 is made according to KDB 789033

**Measurement Results:**
**802.11a mode**
**U-NII-1**

Mode	Data Rate(Mbps)	Teat Result(dBm)		
		5180MHz(Ch36)	5200MHz(Ch44)	5240MHz(Ch48)
802.11a	6	12.25	12.02	12.19

**U-NII-2**

Mode	Data Rate(Mbps)	Teat Result(dBm)		
		5260MHz(Ch52)	5300MHz(Ch60)	5320MHz(Ch64)
802.11a	6	12.51	12.31	12.22

The data rate MCS0 is selected as worse condition, and the following cases are performed with this condition.

**802.11n-HT20 mode**
**U-NII-1**

Mode	Data Rate(Index)	Teat Result(dBm)		
		5180MHz	5200MHz	5240MHz
802.11n(20MHz)	MCS0	11.17	10.97	11.35

**U-NII-2A**

Mode	Data Rate(Index)	Teat Result(dBm)		
		5260MHz	5300MHz	5320MHz
802.11n(20MHz)	MCS0	11.66	11.6	11.58

The data rate MCS0 is selected as worse condition, and the following cases are performed with this condition.

### 6.3. Peak Power Spectral Density (conducted)

**Measurement Limit:**

Standard	Frequency (MHz)	Limit (dBm/MHz)
FCC CRF Part 15.407(a)	5150MHz~5250MHz	11
	5250MHz~5350MHz	11

The output power measurement method SA-1 is made according to KDB 789033

**Measurement Results:**

Mode	Channel	Power Spectral Density (dBm/MHz)	Conclusion
802.11a	5180 MHz	-3.343	P
	5200 MHz	-4.243	P
	5240 MHz	-4.010	P
	5260 MHz	2.175	P
	5300 MHz	-4.447	P
	5320 MHz	-4.518	P
802.11n HT20	5180 MHz	-3.235	P
	5200 MHz	-2.965	P
	5240 MHz	-2.879	P
	5260 MHz	-8.262	P
	5300 MHz	-7.449	P
	5320 MHz	-6.612	P

**Conclusion: PASS**

## 6.4. Occupied 26dB Bandwidth(conducted)

**Measurement Limit:**

Standard	Limit (kHz)
FCC 47 CFR Part 15.407 (e)	/

The measurement is made according to KDB 789033

**Measurement Uncertainty:**

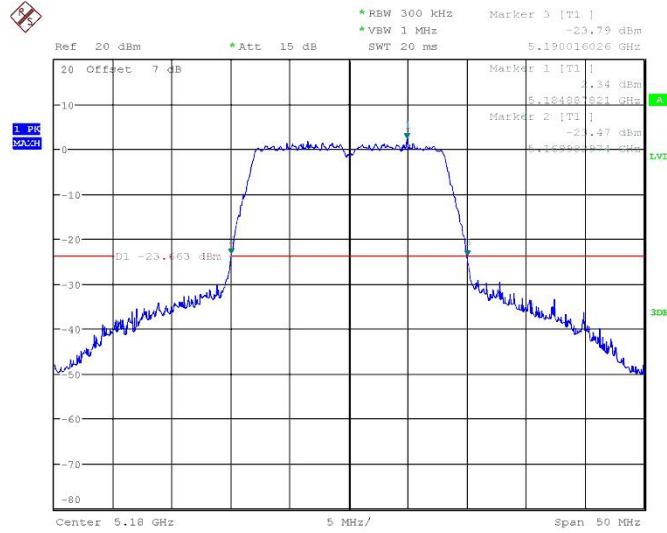
Measurement Uncertainty	60.80Hz
-------------------------	---------

**Measurement Result:**

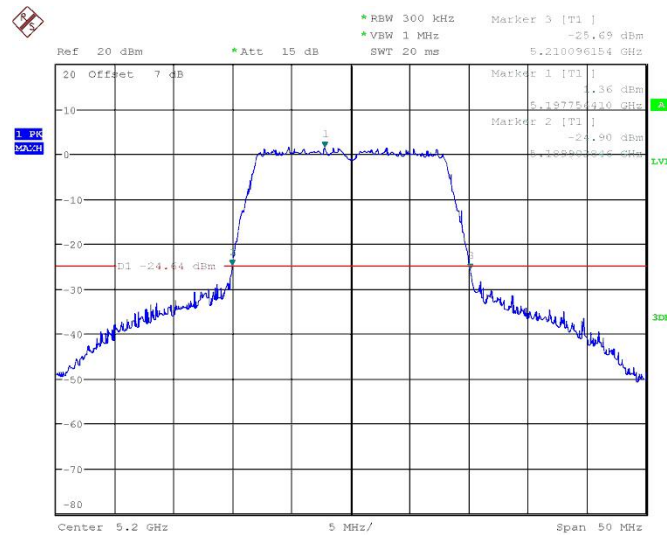
Mode	Channel	Occupied 26dB Bandwidth ( MHz)		conclusion
		Fig.	Value	
802.11a	5180 MHz	Fig.1	20.03	P
	5200 MHz	Fig.2	20.19	P
	5240 MHz	Fig.3	20.11	P
	5260 MHz	Fig.4	20.03	P
	5300 MHz	Fig.5	19.95	P
	5320 MHz	Fig.6	19.79	P
802.11n HT20	5180 MHz	Fig.7	20.11	P
	5200 MHz	Fig.8	20.11	P
	5240 MHz	Fig.9	20.11	P
	5260 MHz	Fig.10	20.11	P
	5300 MHz	Fig.11	20.11	P
	5320 MHz	Fig.12	20.19	P

**Conclusion: PASS**

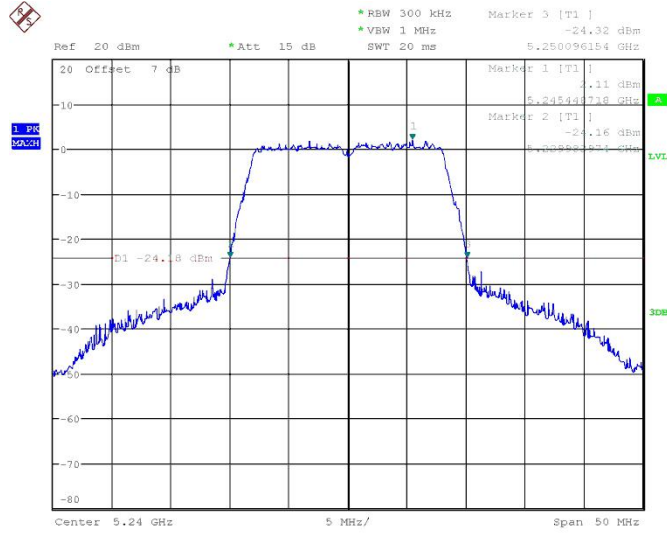
**Test graphs as below:**



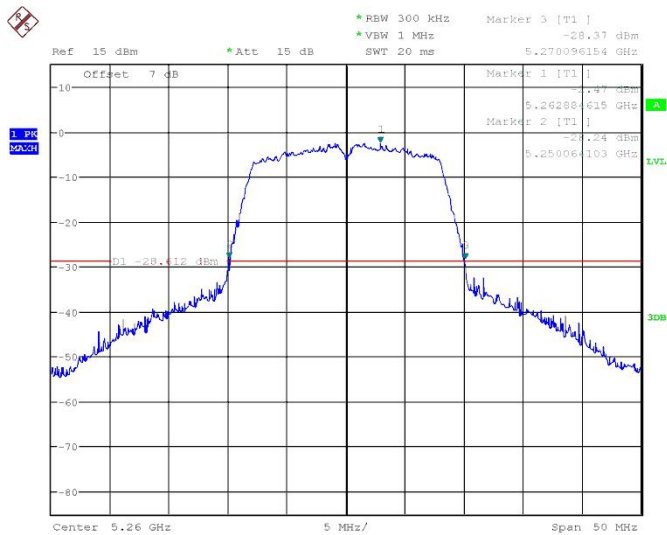
**Fig. 1 Occupied 26dB Bandwidth (802.11a, 5180MHz)**



**Fig. 2 Occupied 26dB Bandwidth (802.11a, 5200MHz)**

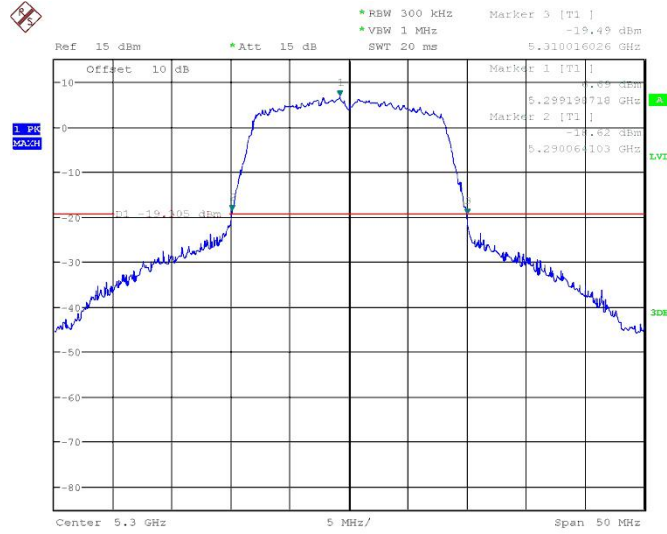


**Fig. 3 Occupied 26dB Bandwidth (802.11a, 5240MHz)**

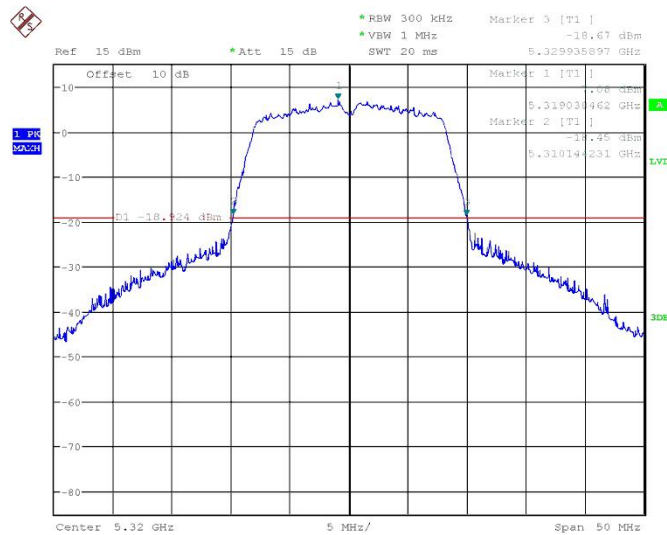


**Fig. 4 Occupied 26dB Bandwidth (802.11a, 5260MHz)**

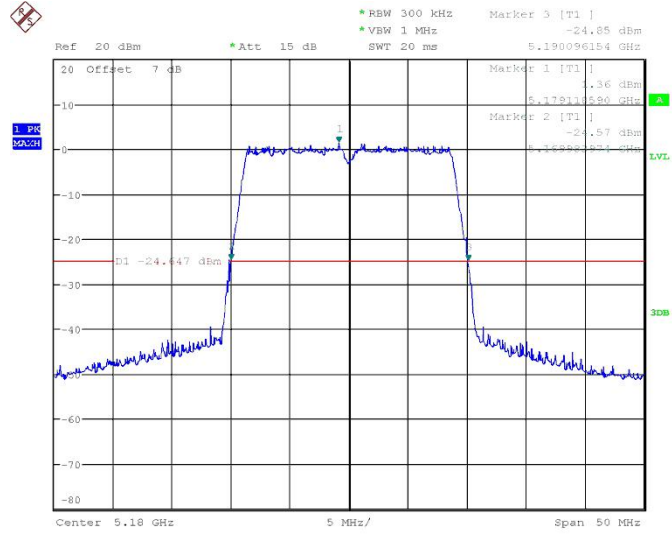




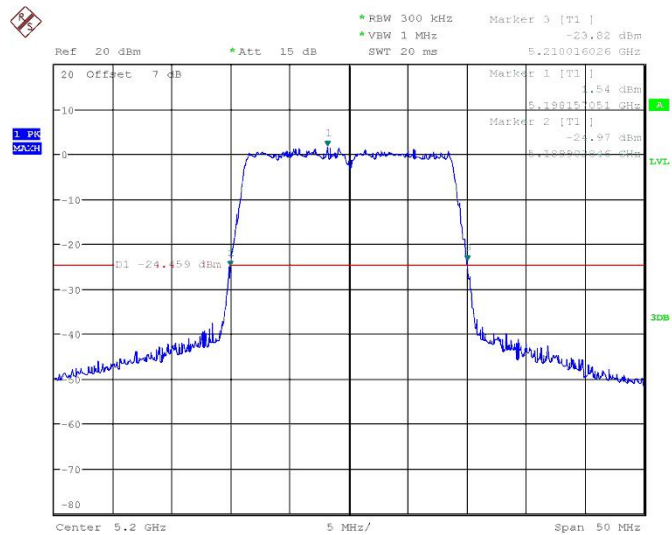
**Fig. 5 Occupied 26dB Bandwidth (802.11a, 5300MHz)**



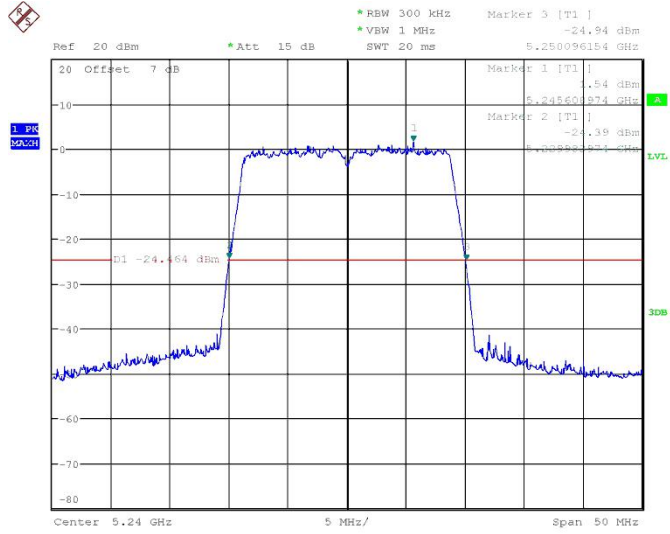
**Fig. 6 Occupied 26dB Bandwidth (802.11a, 5320MHz)**



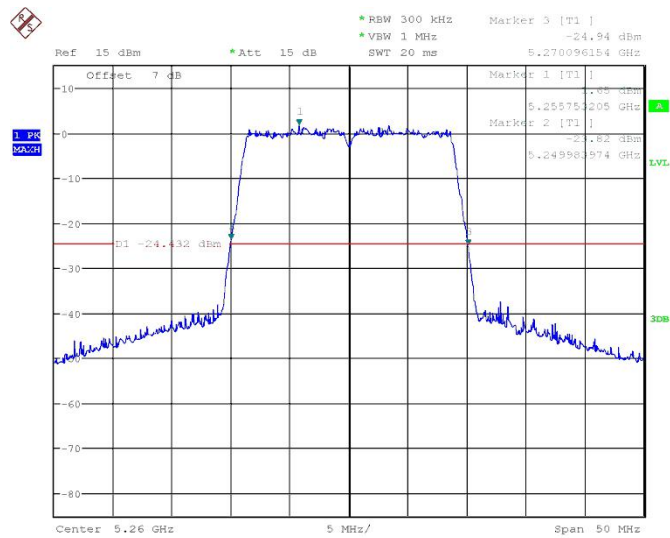
**Fig. 7 Occupied 26dB Bandwidth (802.11n-HT20, 5180MHz)**



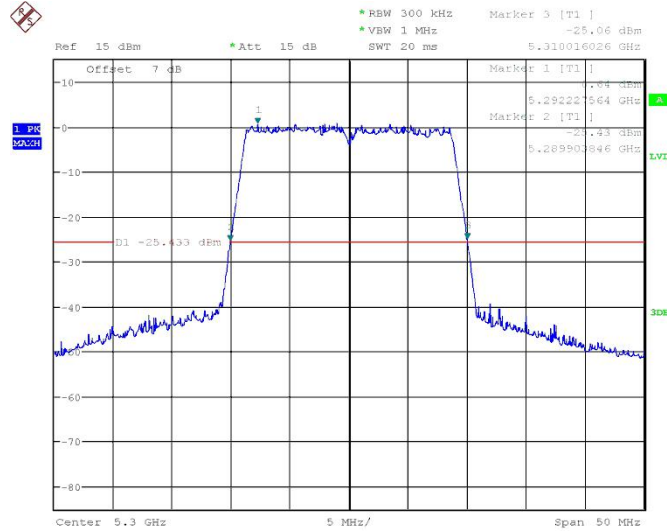
**Fig. 8 Occupied 26dB Bandwidth (802.11n-HT20, 5200MHz)**



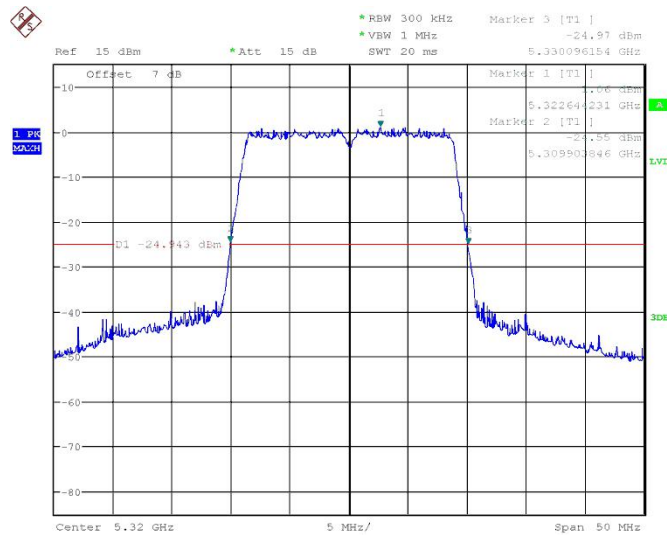
**Fig. 9 Occupied 26dB Bandwidth (802.11n-HT20, 5240MHz)**



**Fig. 10 Occupied 26dB Bandwidth (802.11n-HT20, 5260MHz)**



**Fig. 11 Occupied 26dB Bandwidth (802.11n-HT20, 5300MHz)**



**Fig. 12 Occupied 26dB Bandwidth (802.11n-HT20, 5320MHz)**

## 6.5 99% Occupied Bandwidth(conducted)

### Measurement Limit:

Standard	Limit (MHz)
FCC 47 CFR Part 15.407 (e)	/

The measurement is made according to KDB 789033

### Measurement Uncertainty:

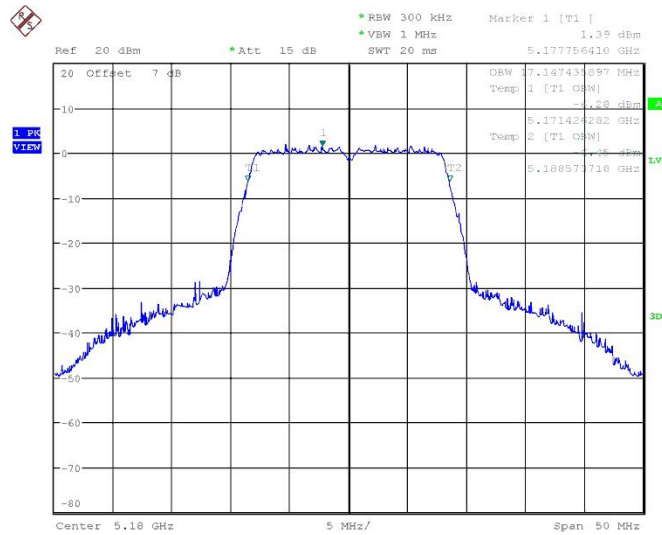
Measurement Uncertainty	60.80Hz
-------------------------	---------

**Measurement Result:**

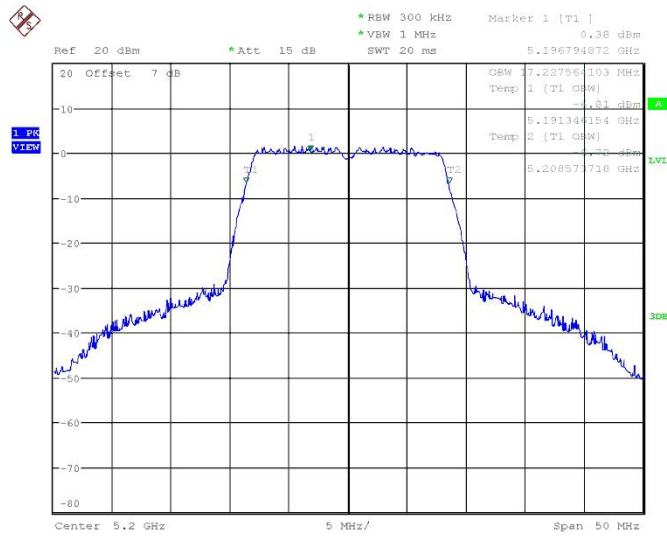
Mode	Channel	99% Occupied Bandwidth ( MHz)		conclusion
802.11a	5180 MHz	Fig.13	17.14	P
	5200 MHz	Fig.14	17.22	P
	5240 MHz	Fig.15	17.22	P
	5260 MHz	Fig.16	17.62	P
	5300 MHz	Fig.17	16.98	P
	5320 MHz	Fig.18	16.90	P
802.11n HT20	5180 MHz	Fig.19	17.94	P
	5200 MHz	Fig.20	17.86	P
	5240 MHz	Fig.21	17.86	P
	5260 MHz	Fig.22	17.86	P
	5300 MHz	Fig.23	17.94	P
	5320 MHz	Fig.24	17.94	P

**Conclusion: PASS**

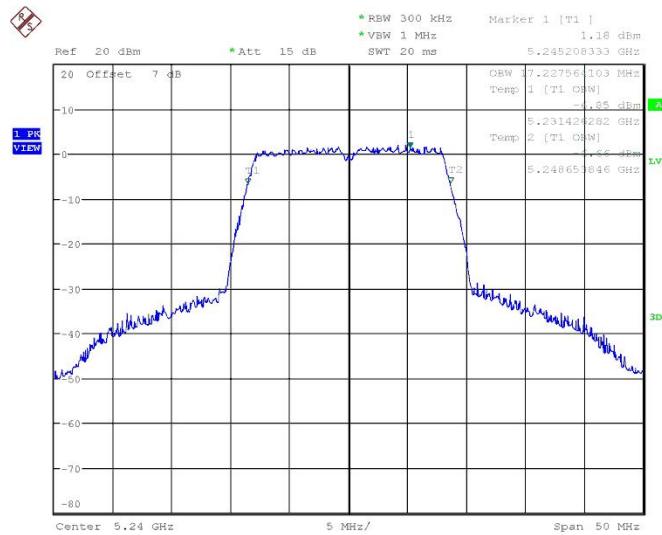
**Test graphs as below:**



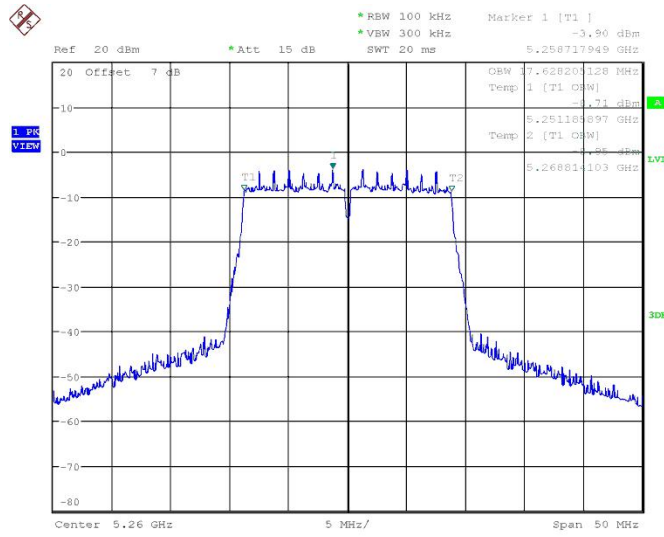
**Fig. 13 99% Occupied Bandwidth (802.11a, 5180MHz)**



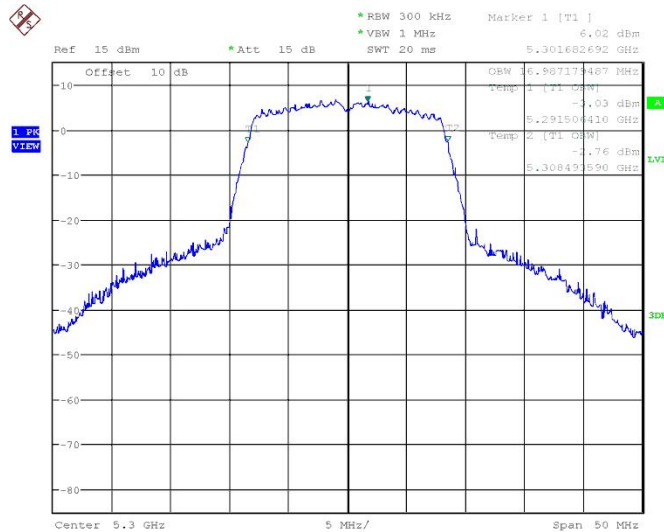
**Fig. 14 99% Occupied Bandwidth (802.11a, 5200MHz)**



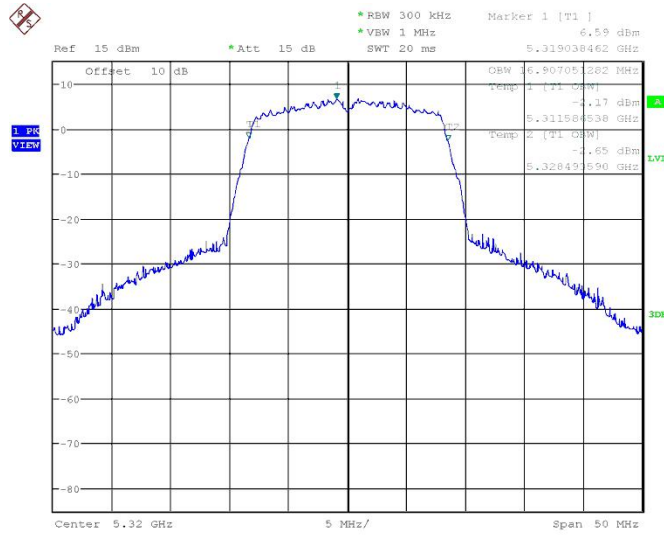
**Fig. 15 99% Occupied Bandwidth (802.11a, 5240MHz)**



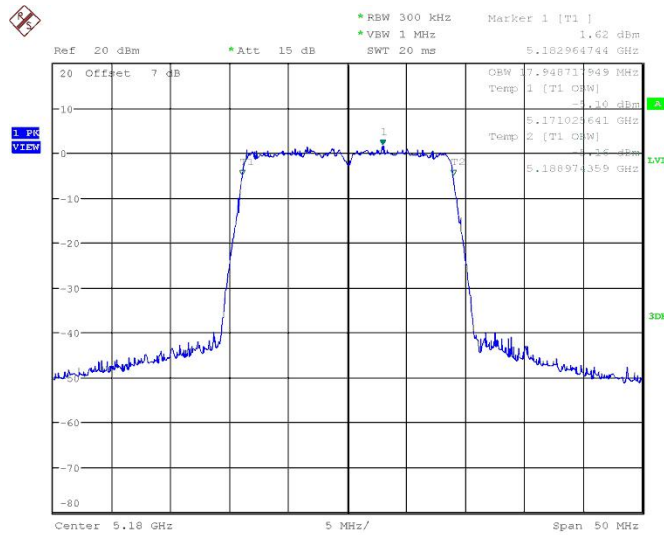
**Fig. 16 99% Occupied Bandwidth (802.11a, 5260MHz)**



**Fig. 17 99% Occupied Bandwidth (802.11a, 5300MHz)**

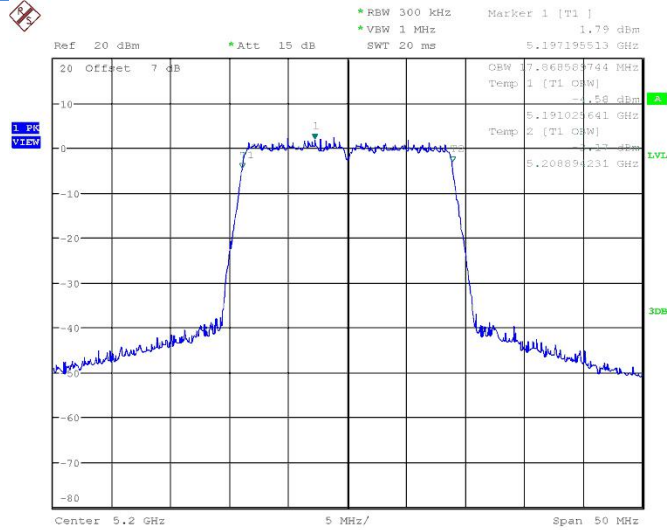


**Fig. 18 99% Occupied Bandwidth (802.11a, 5320MHz)**

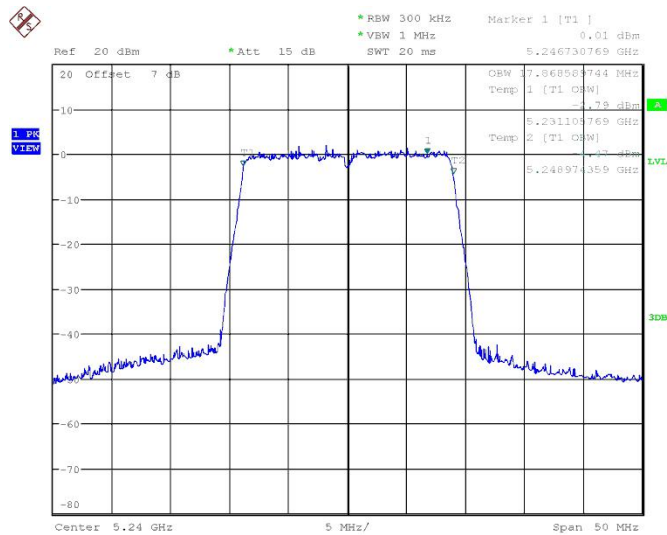


**Fig. 19 99% Occupied Bandwidth (802.11n-HT20, 5180MHz)**

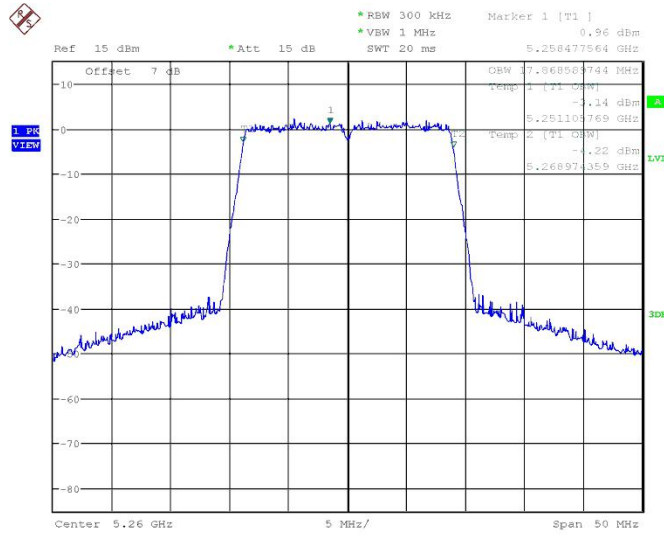




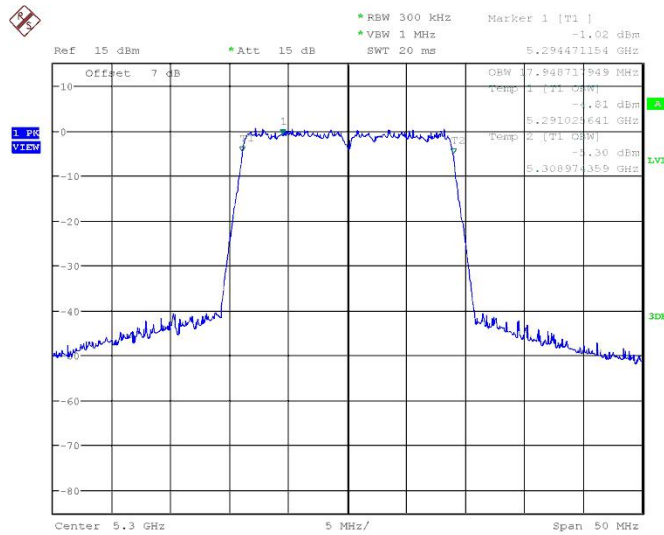
**Fig. 20 99% Occupied Bandwidth (802.11n-HT20, 5200MHz)**



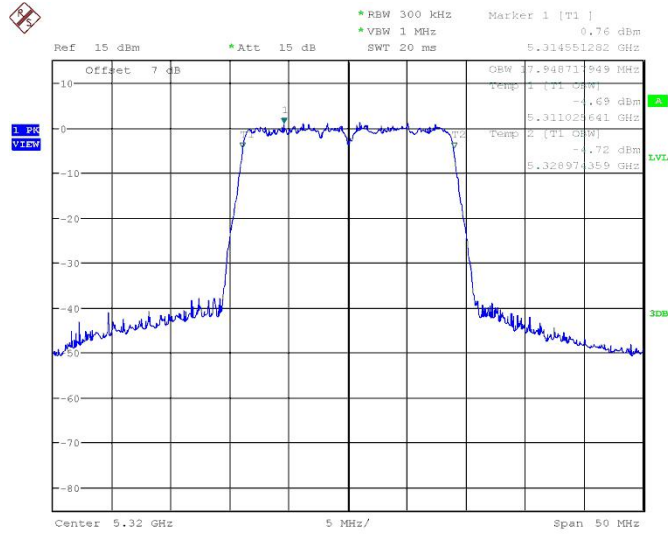
**Fig. 21 99% Occupied Bandwidth (802.11n-HT20, 5240MHz)**



**Fig. 22 99% Occupied Bandwidth (802.11n-HT20, 5260MHz)**



**Fig. 23 99% Occupied Bandwidth (802.11n-HT20, 5300MHz)**



**Fig. 24 99% Occupied Bandwidth (802.11n-HT20, 5320MHz)**

## 6.6. Band Edges Compliance

### 6.6.1 Band Edges - conducted

**Measurement Limit:**

Standard	Limit (dBm/MHz)
FCC 47 CFR Part 15.407	< -27

The measurement is made according to KDB 789033

**Measurement Uncertainty:**

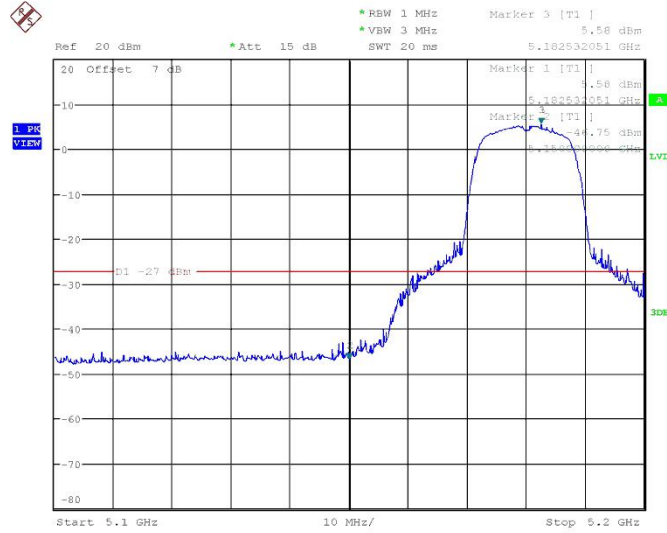
Measurement Uncertainty	0.75dB
-------------------------	--------

**Measurement Result:**

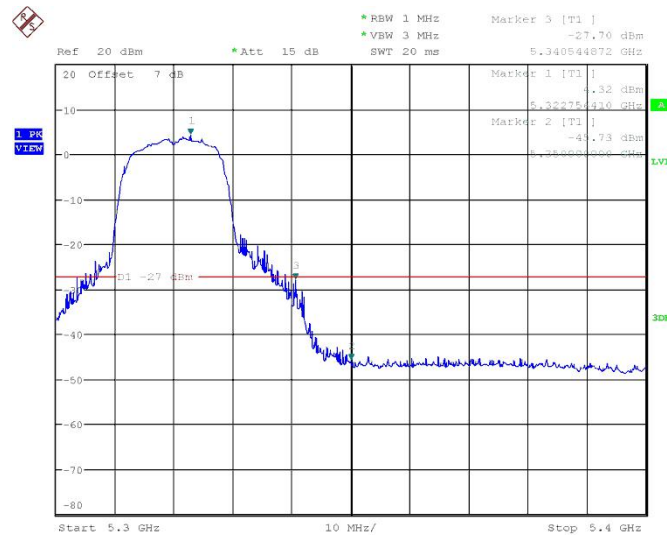
Mode	Channel	Test Results	Conclusion
802.11a	5180 MHz	Fig.25	P
	5320 MHz	Fig.26	P
802.11n HT20	5180 MHz	Fig.27	P
	5320 MHz	Fig.28	P

**Conclusion: PASS**

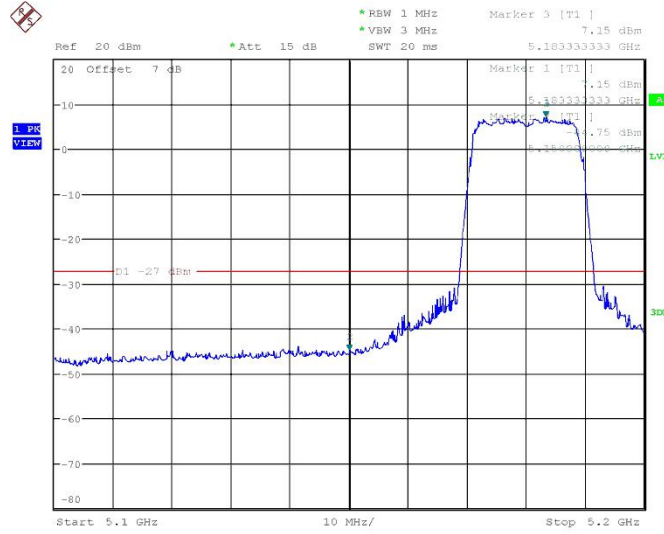
**Test graphs as below:**



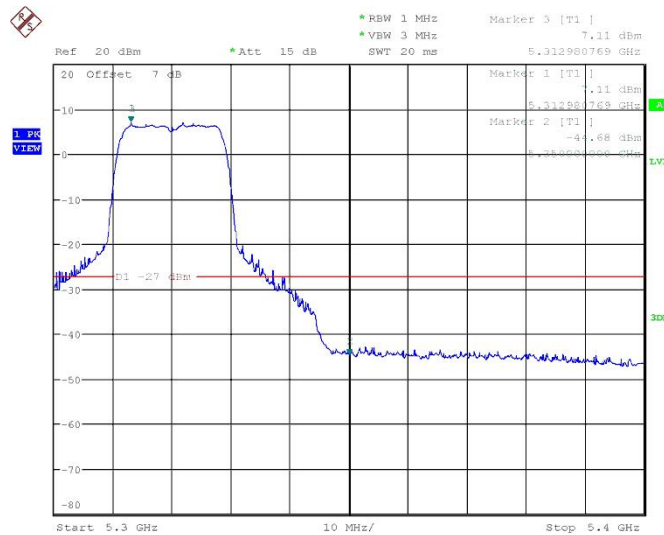
**Fig. 25 Band Edges (802.11a, 5180MHz)**



**Fig. 26 Band Edges (802.11a, 5320MHz)**



**Fig. 27 Band Edges (802.11n-HT20, 5180MHz)**



**Fig. 28 Band Edges (802.11n-HT20, 5320MHz)**

### 6.6.2 Band Edges - Radiated

**Measurement Limit:**

Standard	Limit (dB $\mu$ V/m)	
FCC 47 CFR Part 15.209	Peak	74
	Average	54

The measurement is made according to KDB 789033

In addition, radiated emissions which fall in the restricted bands, as defined in § 15.205(a), must also comply with the radiated emission limits specified in § 15.209(a) (see § 15.205(c)).

**Measurement Uncertainty:**

Measurement Uncertainty	0.75dB
-------------------------	--------

**Measurement Result:**

**First supply**

Mode	Channel	Test Results	Conclusion
802.11a	5180 MHz	Fig.29	P
	5320 MHz	Fig.30	P
802.11n HT20	5180 MHz	Fig.31	P
	5320 MHz	Fig.32	P

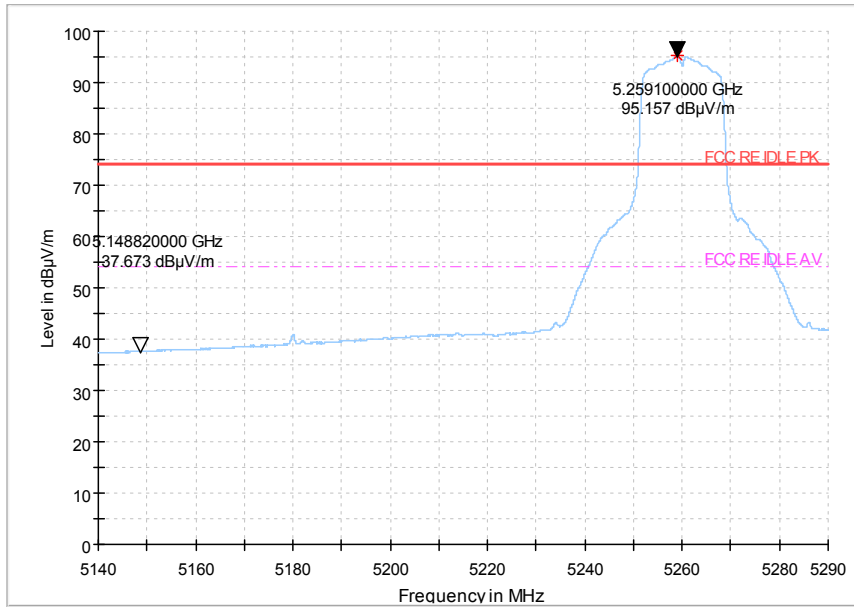
**Second supply**

Mode	Channel	Test Results	Conclusion
802.11a	5180 MHz	Fig.33	P
802.11n HT20	5180 MHz	Fig.34	P

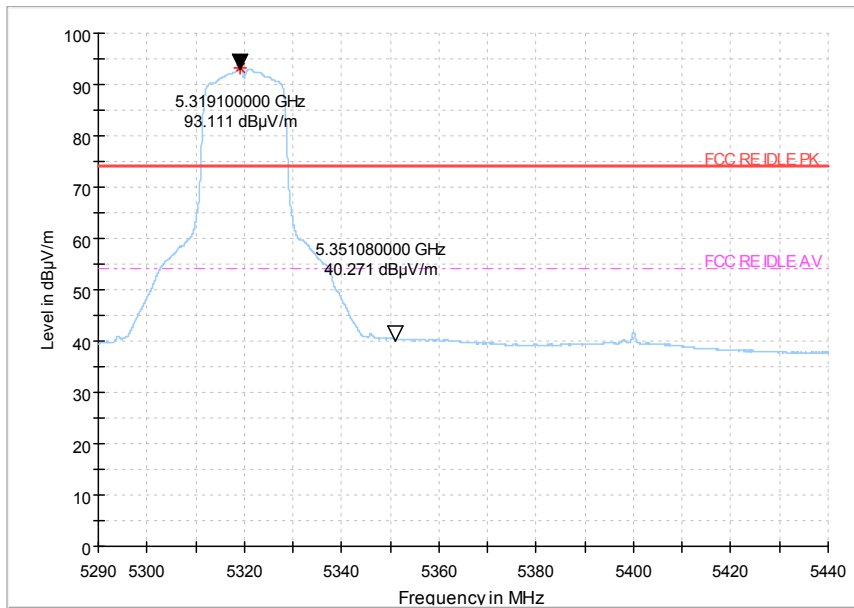
**Conclusion: PASS**

**Test graphs as below:**

**First supply**

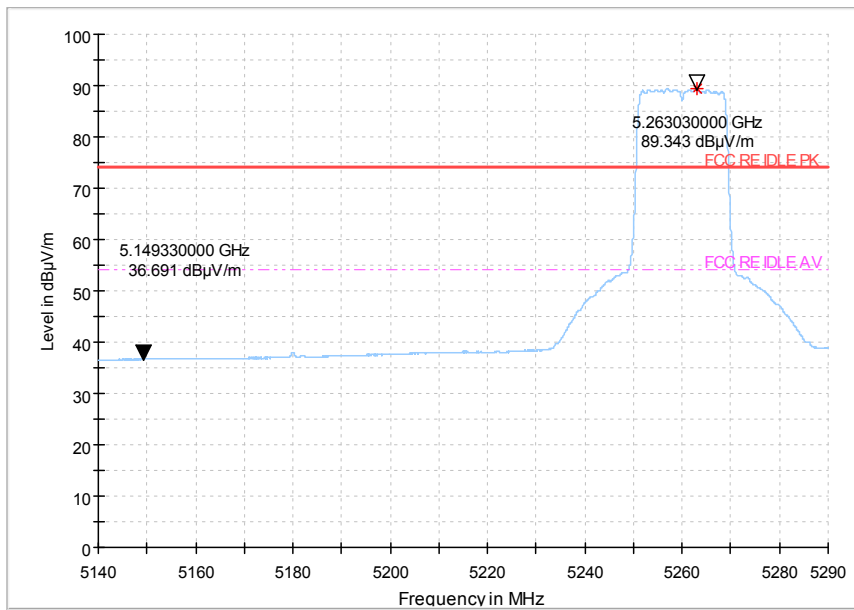


**Fig. 29 Band Edges (802.11a, 5180MHz)**

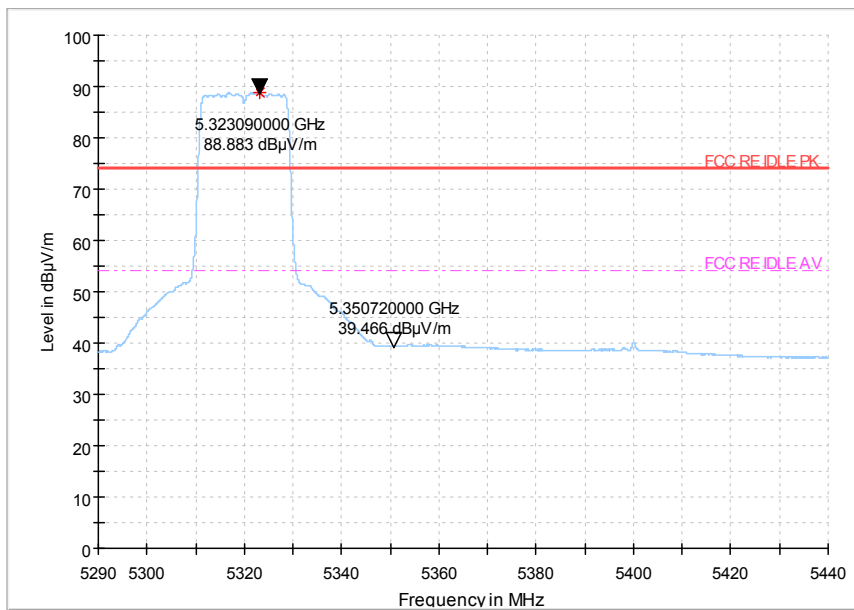


**Fig. 30 Band Edges (802.11a, 5320MHz)**



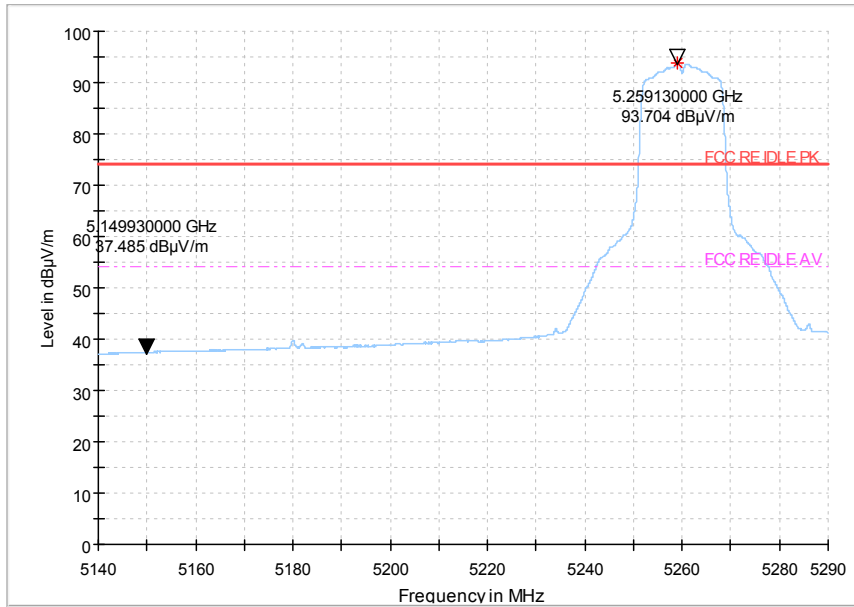


**Fig. 31 Band Edges (802.11n-HT20, 5180MHz)**

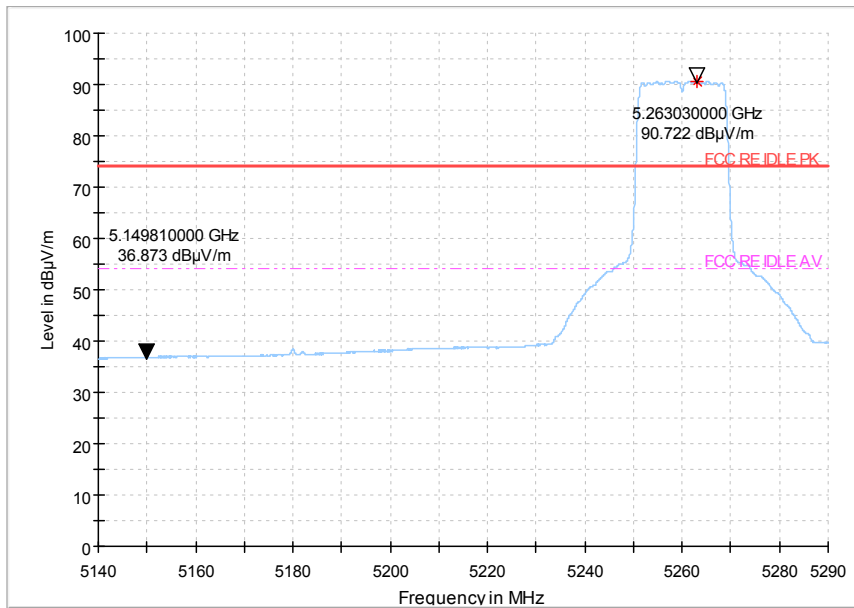


**Fig. 32 Band Edges (802.11n-HT20, 5320MHz)**

**Second supply**



**Fig. 33 Band Edges (802.11a, 5180MHz)**



**Fig. 34 Band Edges (802.11n-HT20, 5180MHz)**

## 6.7. Transmitter Spurious Emission

**Measurement Limit:**

Standard	Limit
FCC 47 CFR Part 15.407	-27 dBm/MHz

The measurement is made according to KDB 789033

In addition, radiated emissions which fall in the restricted bands, as defined in § 15.205(a), must also comply with the radiated emission limits specified in § 15.209(a) (see § 15.205(c)).

**Limit in restricted band:**

Frequency of emission (MHz)	Field strength(dBμV/m)	Measurement distance(m)
30-88	40.0	3
88-216	43.5	3
216-960	46.0	3
Above 960	54.0	3

Note: for frequency range below 960MHz, the limit in 15.209 is defined in 10m test distance. The limit used above is calculated from 10m to 3m

**Measurement uncertainty:**

Expanded measurement uncertainty for this test item is U =3.9 dB, k=2.

**Measurement Results:**
**First supply**
**802.11a mode**

Mode	Channel	Frequency Range	Test Results	Conclusion
802.11a	52(5260MHz)	1 GHz ~ 8 GHz	Fig.35	P
		8 GHz ~ 18 GHz	Fig.36	P
		18 GHz ~ 26.5 GHz	Fig.37	
		26.5 GHz ~ 40 GHz	Fig.38	P
	64(5320MHz)	30MHz ~ 1 GHz	Fig.39	P
		1 GHz ~ 8 GHz	Fig.40	P
		8 GHz ~ 18 GHz	Fig.41	P
		18 GHz ~ 26.5 GHz	Fig.42	
		26.5 GHz ~ 40 GHz	Fig.43	P

**802.11n-HT20 mode**

Mode	Channel	Frequency Range	Test Results	Conclusion
802.11n	52(5260MHz)	1 GHz ~ 8 GHz	Fig.44	P

HT20		8 GHz ~ 18 GHz	Fig.45	P
		18 GHz ~ 26.5 GHz	Fig.46	
		26.5 GHz ~ 40 GHz	Fig.47	P
	64(5320MHz)	30MHz ~ 1 GHz	Fig.48	P
		1 GHz ~ 8 GHz	Fig.49	P
		8 GHz ~ 18 GHz	Fig.50	
		18 GHz ~ 26.5 GHz	Fig.51	P
	26.5 GHz ~ 40 GHz	Fig.52	P	

**Second supply**
**802.11a mode**

Mode	Channel	Frequency Range	Test Results	Conclusion
802.11a	52(5260MHz)	30MHz ~ 1 GHz	Fig.53	P
		1 GHz ~ 8 GHz	Fig.54	P
		8 GHz ~ 18 GHz	Fig.55	P
		18 GHz ~ 26.5 GHz	Fig.56	
		26.5 GHz ~ 40 GHz	Fig.57	P

**Conclusion: PASS**
**Note:**

A "reference path loss" is established and the  $A_{Rpl}$  is the attenuation of "reference path loss", and including the gain of receive antenna, the gain of the preamplifier, the cable loss.

$P_{Mea}$  is the field strength recorded from the instrument.

The measurement results are obtained as described below:

Result= $P_{Mea}+A_{Rpl}= P_{Mea}+Cable Loss+Antenna Factor$

**First supply**
**802.11a**

Channel 52 (Peak)

Frequency(MHz)	Result(dBuV/m)	ARpl (dB)	PMea(dBuV/m)	Polarity
5034.4	43.50	2.3	41.2	H
7818.8	48.21	8.5	39.71	V
13694.6	54.57	18.8	35.77	V
17781.0	56.99	24.5	32.49	H
20766.75	32.10	-4.3	36.4	H
26063.95	36.99	-2.0	38.99	V
27967.45	43.83	-0.3	44.13	H



## RF Test Report

Report No.: I18D00198-SRD06

38639.2	47.96	3.0	44.96	V
---------	-------	-----	-------	---

Channel 52 (Average)

Frequency(MHz)	Result(dBuV/m)	ARpl (dB)	PMea(dBuV/m)	Polarity
13694.6	42.38	18.8	23.58	V
17781.0	44.70	24.5	20.2	H

Channel 64 (Peak)

Frequency(MHz)	Result(dBuV/m)	ARpl (dB)	PMea(dBuV/m)	Polarity
34.06	14.25	-22.0	36.25	V
591.09	18.22	-14.8	33.02	V
5745.0	44.97	4.7	40.27	H
7767.2	48.01	8.5	39.51	H
14898.2	54.07	20.1	33.97	H
17809.0	57.48	23.3	34.18	V
19252.9	29.41	-5.7	35.11	V
25531.85	35.49	-2.8	38.29	V
27914.8	45.76	-0.3	46.06	H
38320.6	46.46	2.1	44.36	H

Channel 64 (Average)

Frequency(MHz)	Result(dBuV/m)	ARpl (dB)	PMea(dBuV/m)	Polarity
14898.2	42.24	20.1	22.14	H
17809.0	42.24	23.3	18.94	V

### 802.11n-HT20

Channel 52 (Peak)

Frequency(MHz)	Result(dBuV/m)	ARpl (dB)	PMea(dBuV/m)	Polarity
3719.6	40.47	0.2	40.27	V
7946.4	47.89	9.1	38.79	V



## RF Test Report

Report No.: I18D00198-SRD06

16183.0	56.40	22.4	34	V
17846.2	56.69	24.4	32.29	H
18855.95	30.35	-5.4	35.75	V
24912.2	34.95	-2.4	37.35	V
27856.75	43.96	-0.4	44.36	V
36885.55	46.44	1.9	44.54	V

Channel 52 (Average)

Frequency(MHz)	Result(dBuV/m)	ARpl (dB)	PMea(dBuV/m)	Polarity
16183.0	43.89	22.4	21.49	V
17846.2	45.10	24.4	20.7	H

Channel 64 (Peak)

Frequency(MHz)	Result(dBuV/m)	ARpl (dB)	PMea(dBuV/m)	Polarity
6010.0	49.86	4.6	45.26	V
7862.4	53.81	8.6	45.21	V
15189.8	55.34	20.7	34.64	H
17637.4	58.27	24.5	33.77	V
19252.9	29.41	-5.7	35.11	V
25531.85	35.49	-2.8	38.29	V
27669.1	44.63	-0.7	45.33	V
39049.6	49.49	4.2	45.29	V

Channel 64 (Average)

Frequency(MHz)	Result(dBuV/m)	ARpl (dB)	PMea(dBuV/m)	Polarity
15189.8	42.94	20.7	22.24	H
17637.4	45.12	24.5	20.62	V

### Second supply

802.11a

Channel 52

Frequency(MHz)	Result(dBuV/m)	ARpl (dB)	PMea(dBuV/m)	Polarity
----------------	----------------	-----------	--------------	----------



# RF Test Report

Report No.: I18D00198-SRD06

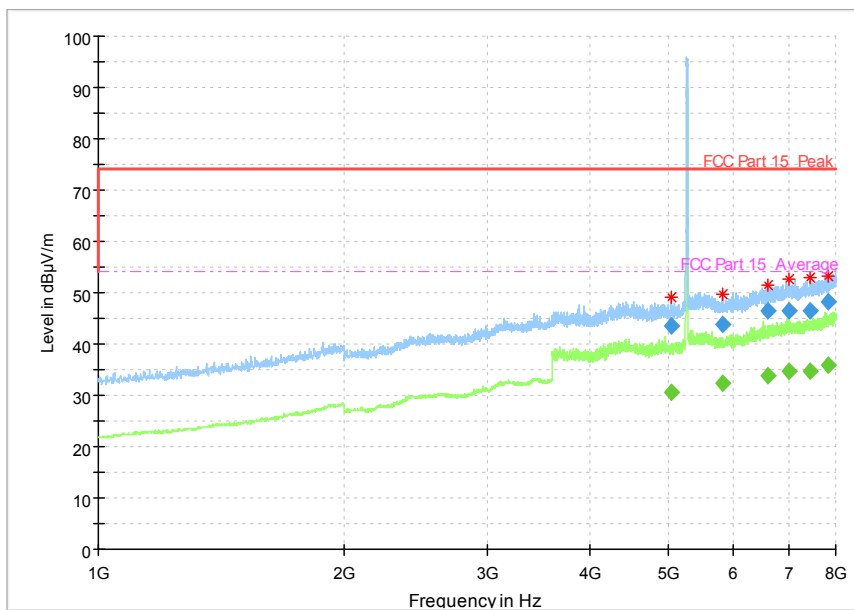
34.52	14.51	-22.0	36.51	V
856.48	22.37	-10.5	32.87	H
3667.8	41.64	0.2	41.44	H
7451.0	46.73	7.3	39.43	H
16152.6	56.90	22.4	34.5	V
17635.0	57.16	24.5	32.66	V
19427.15	30.33	-5.5	35.83	H
24918.15	35.69	-2.4	38.09	H
28165.9	43.79	-0.3	44.09	V
36877.45	46.39	2.0	44.39	H

Channel 52 (Average)

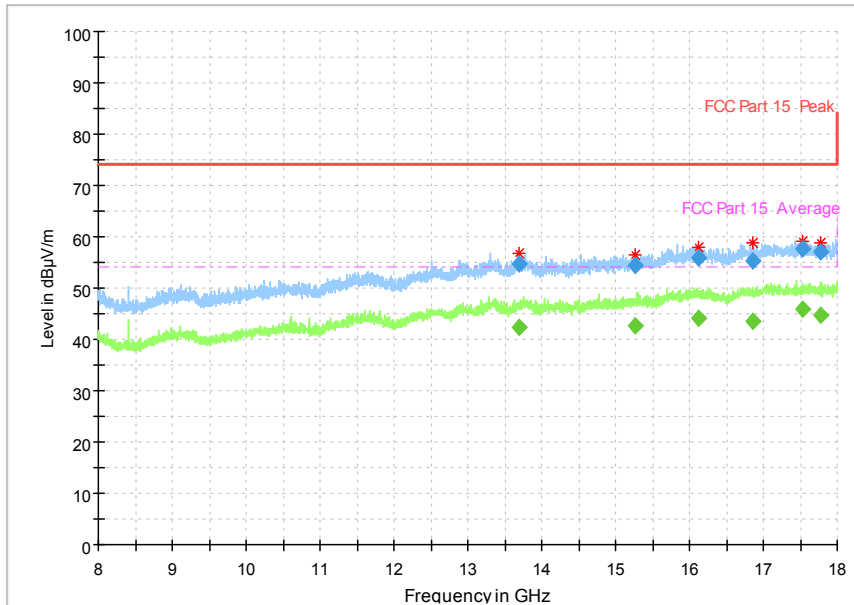
Frequency(MHz)	Result(dBuV/m)	ARpl (dB)	PMea(dBuV/m)	Polarity
16152.6	44.26	22.4	21.86	V
17635.0	45.06	24.5	20.56	V

Test graphs as below:

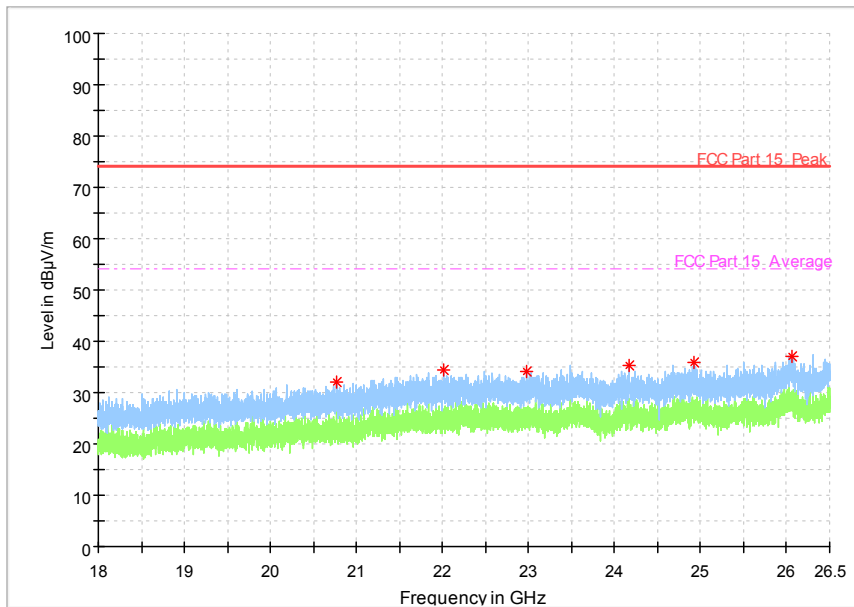
First supply



**Fig. 35 Radiated Spurious Emission (802.11a, ch52, 1 GHz-8 GHz)**

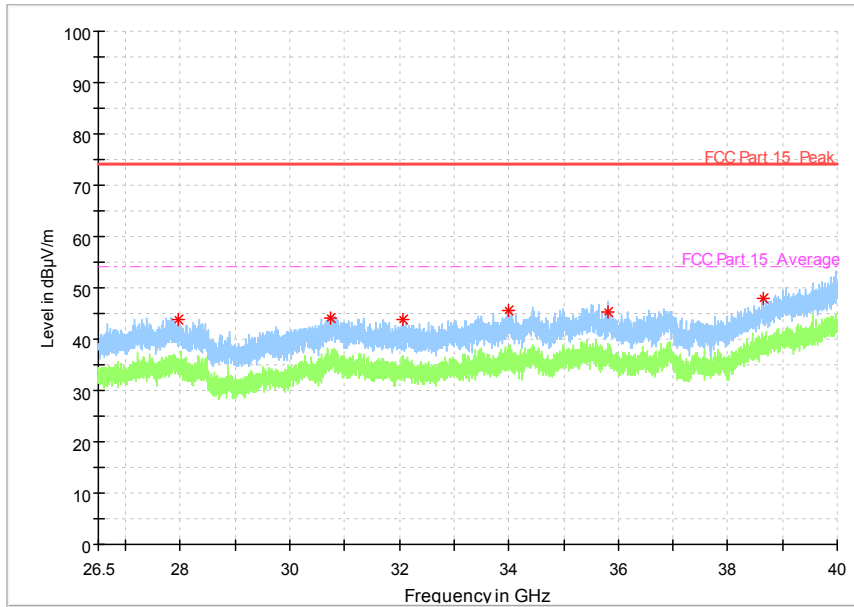


**Fig. 36 Radiated Spurious Emission (802.11a, ch52, 8 GHz-18 GHz)**

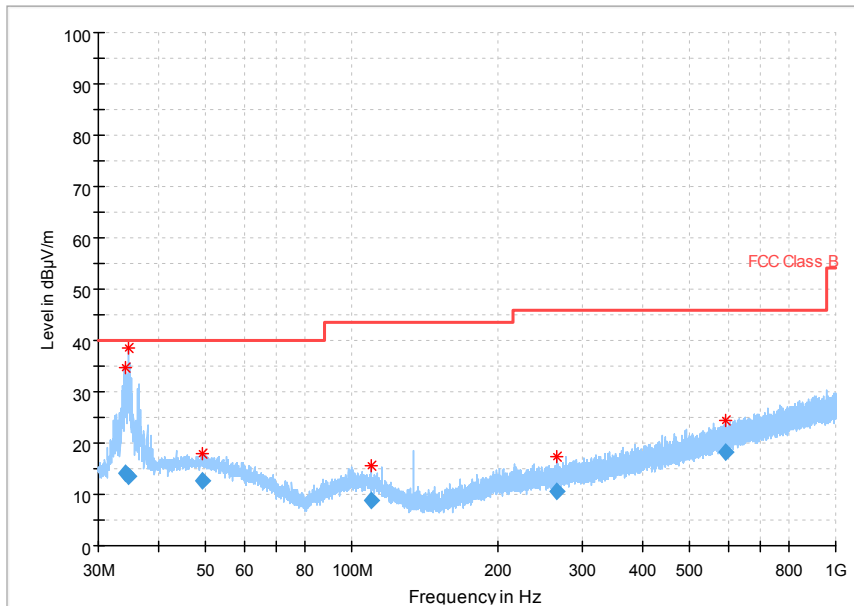


**Fig. 37 Radiated Spurious Emission (802.11a, ch52, 18 GHz-26.5 GHz)**

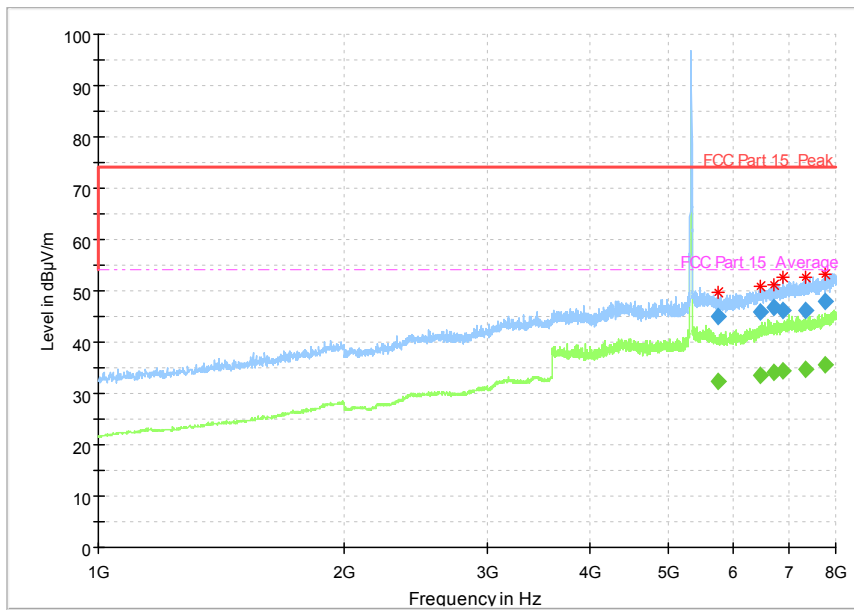




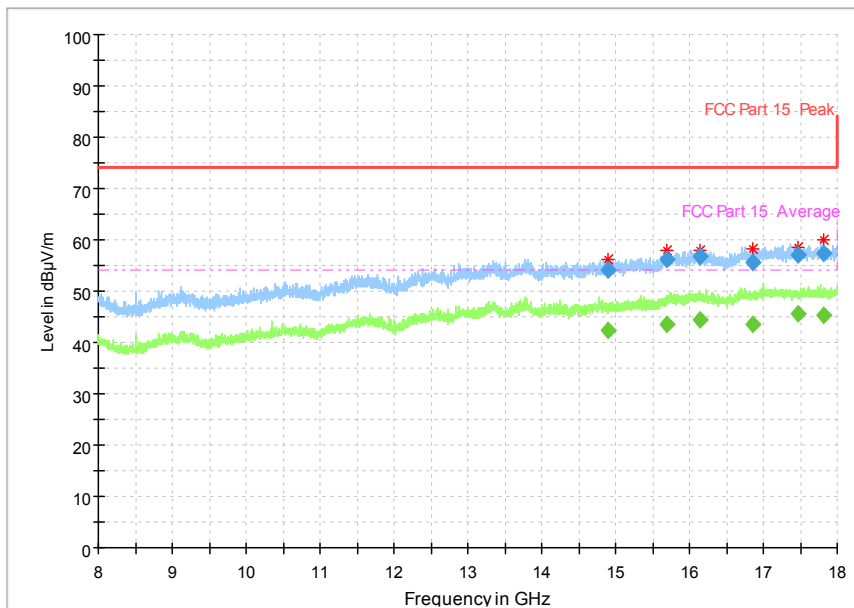
**Fig. 38 Radiated Spurious Emission (802.11a, ch52, 26.5 GHz-40 GHz)**



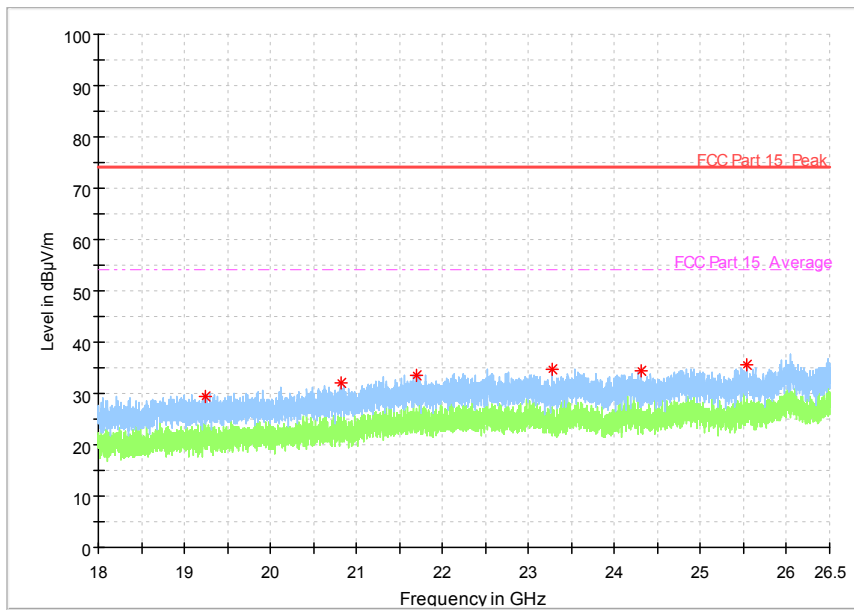
**Fig. 39 Radiated Spurious Emission (802.11a, ch64, 30 MHz-1 GHz)**



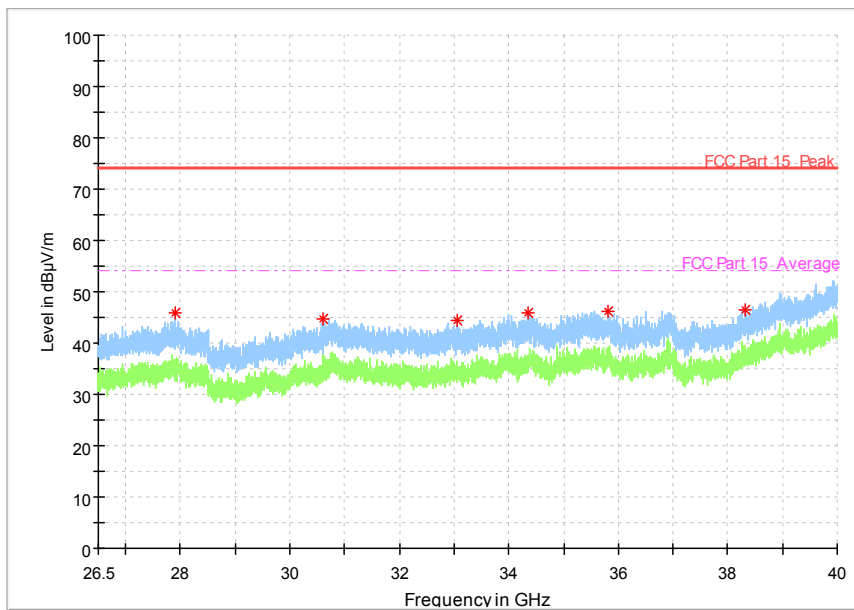
**Fig. 40 Radiated Spurious Emission (802.11a, ch64, 1 GHz-8 GHz)**



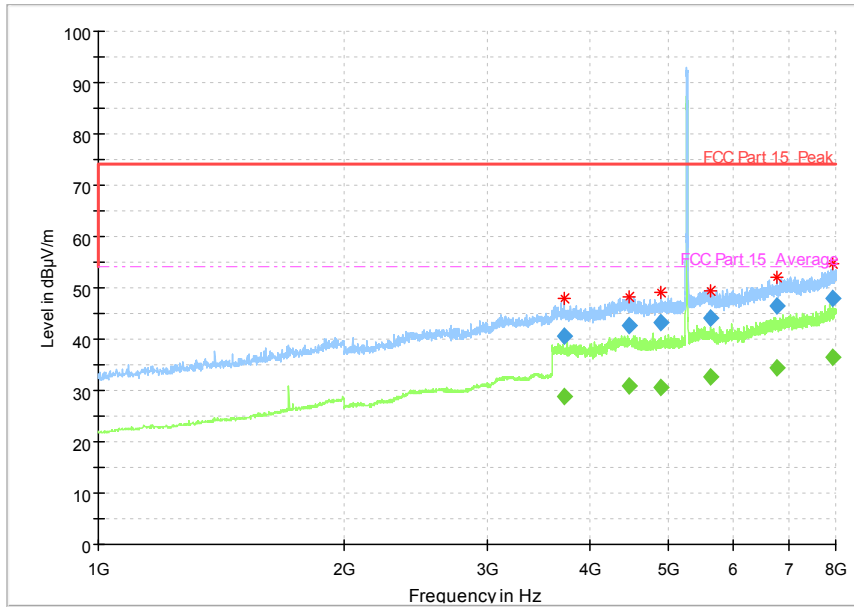
**Fig. 41 Radiated Spurious Emission (802.11a, ch64, 8 GHz-18 GHz)**



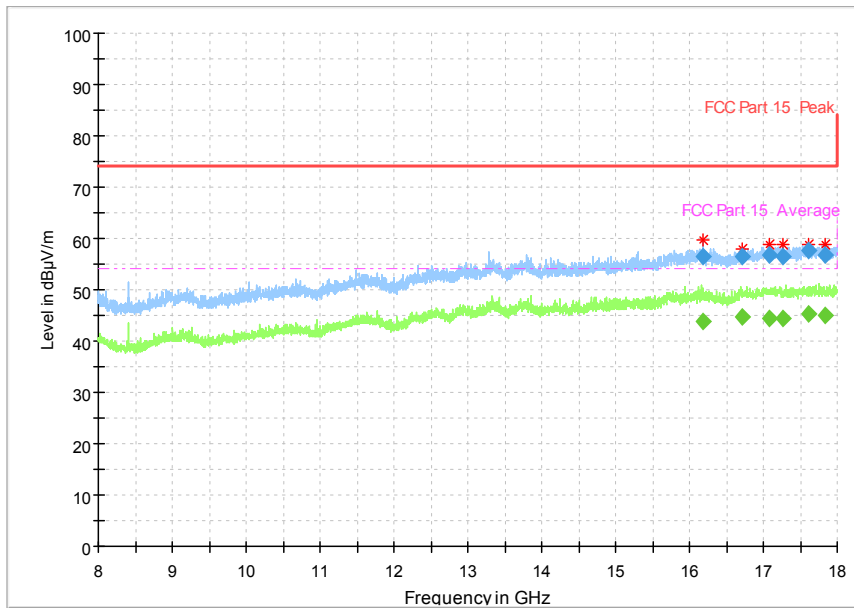
**Fig. 42 Radiated Spurious Emission (802.11a, ch64, 18 GHz-26.5 GHz)**



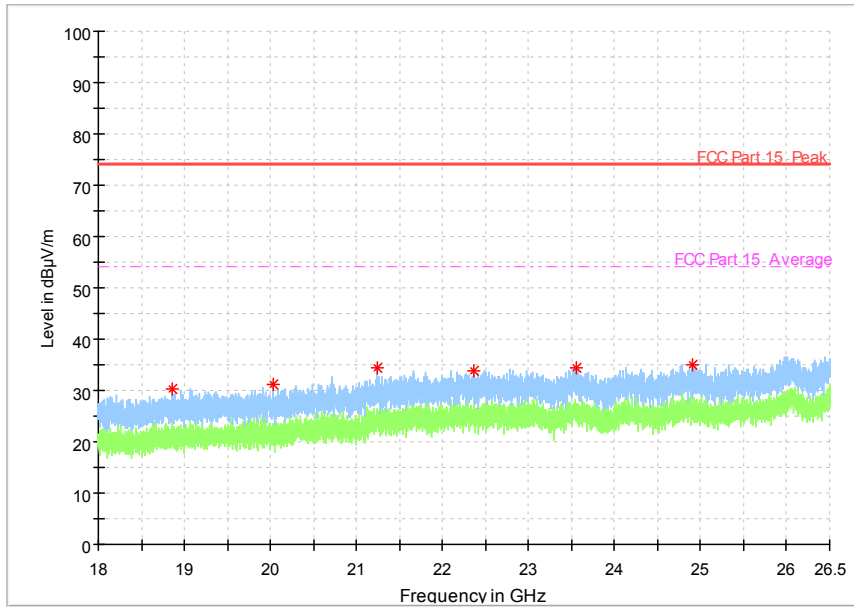
**Fig. 43 Radiated Spurious Emission (802.11a, ch64, 26.5 GHz-40 GHz)**



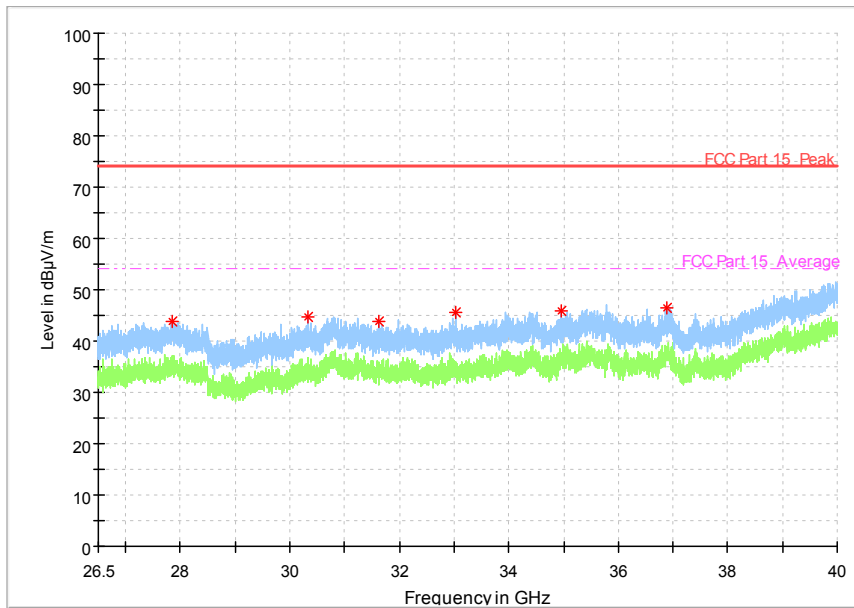
**Fig. 44 Radiated Spurious Emission (802.11 n-HT20, ch52, 1 GHz-8 GHz)**



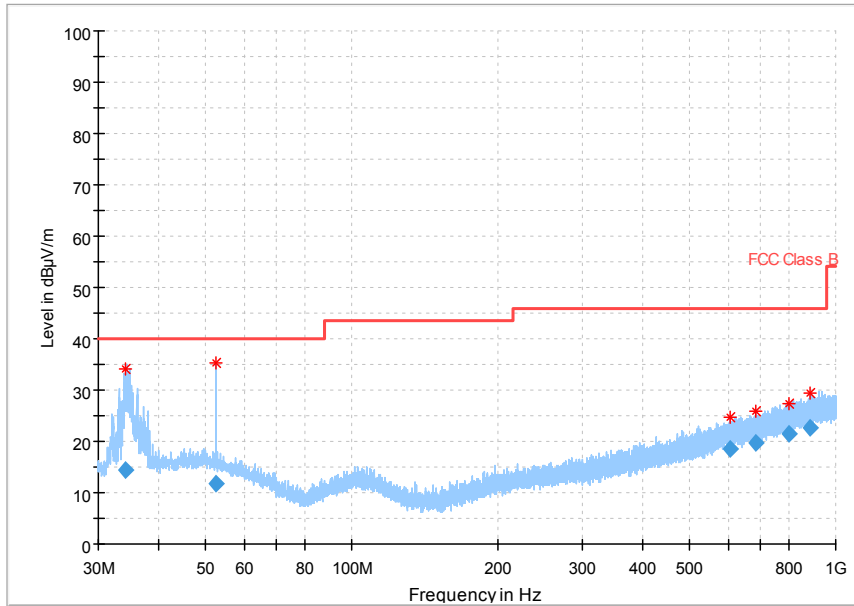
**Fig. 45 Radiated Spurious Emission (802.11 n-HT20, ch52, 8 GHz-18 GHz)**



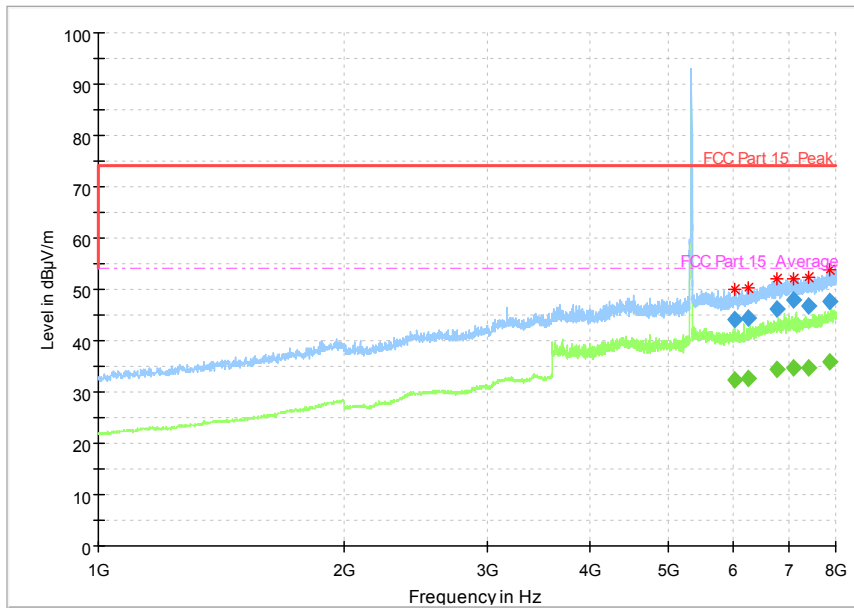
**Fig. 46 Radiated Spurious Emission (802.11 n-HT20, ch52, 18 GHz-26.5 GHz)**



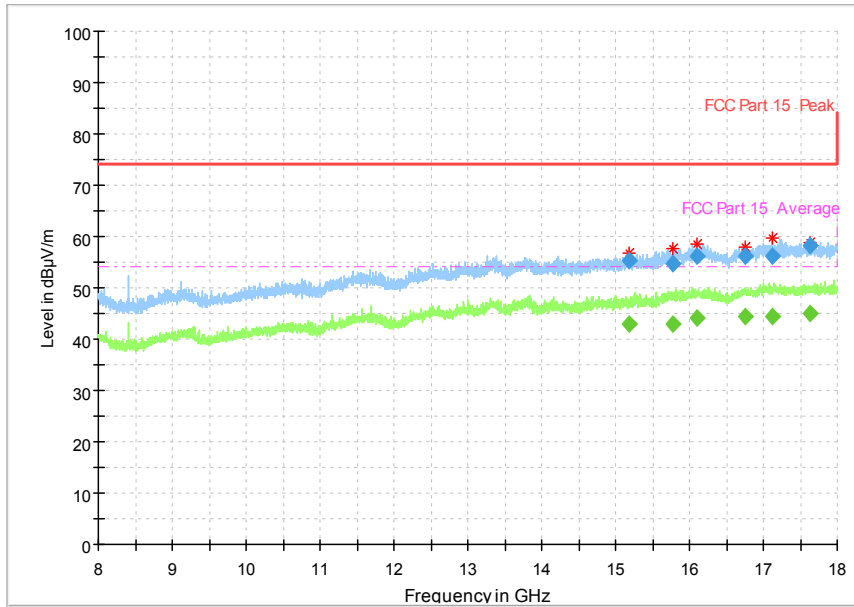
**Fig. 47 Radiated Spurious Emission (802.11 n-HT20, ch52, 26.5 GHz-40 GHz)**



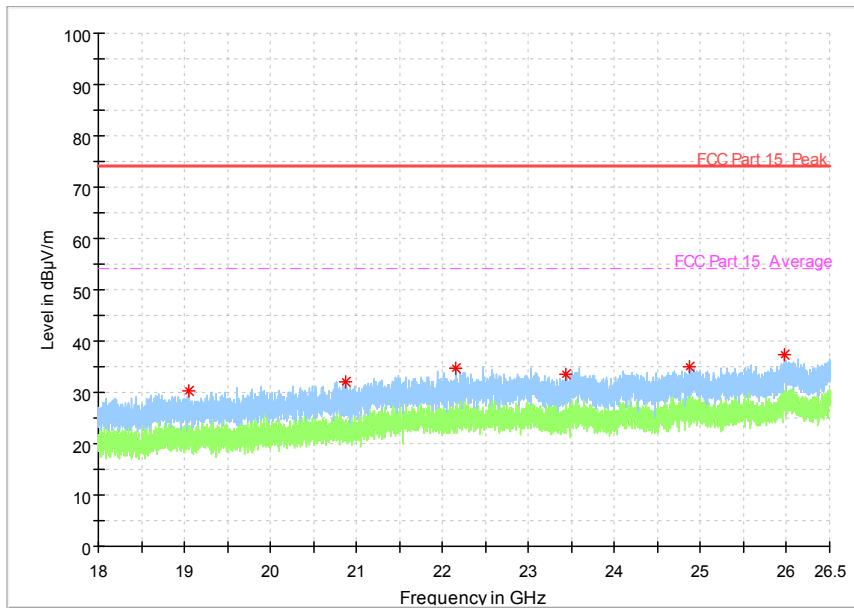
**Fig. 48 Radiated Spurious Emission (802.11 n-HT20, ch64, 30 MHz-1 GHz)**



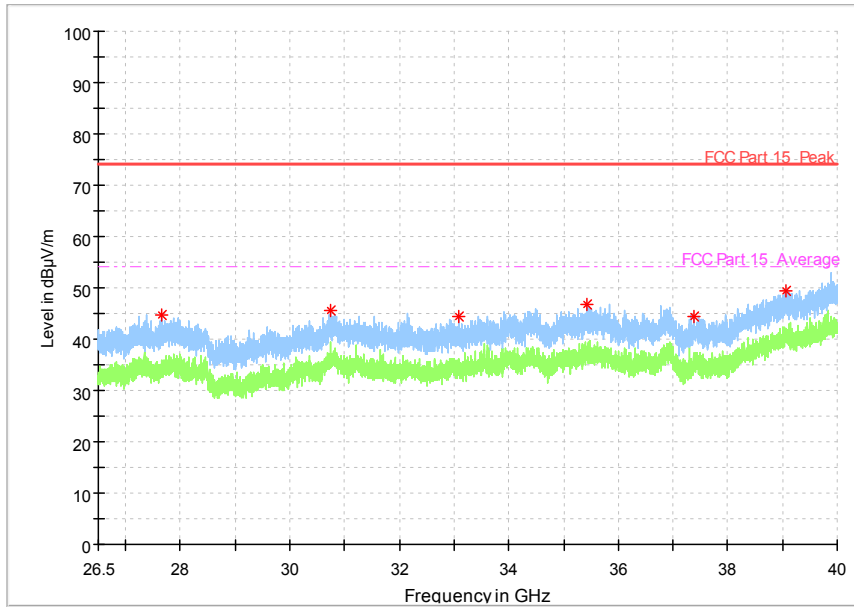
**Fig. 49 Radiated Spurious Emission (802.11 n-HT20, ch64, 1 GHz-8 GHz)**



**Fig. 50 Radiated Spurious Emission (802.11 n-HT20, ch64, 8 GHz-18 GHz)**

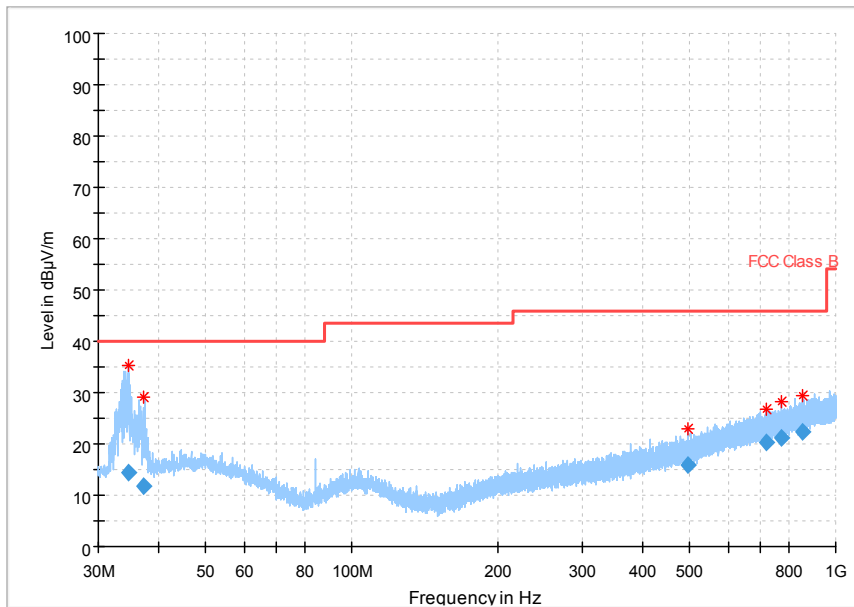


**Fig. 51 Radiated Spurious Emission (802.11 n-HT20, ch64, 18 GHz-26.5 GHz)**



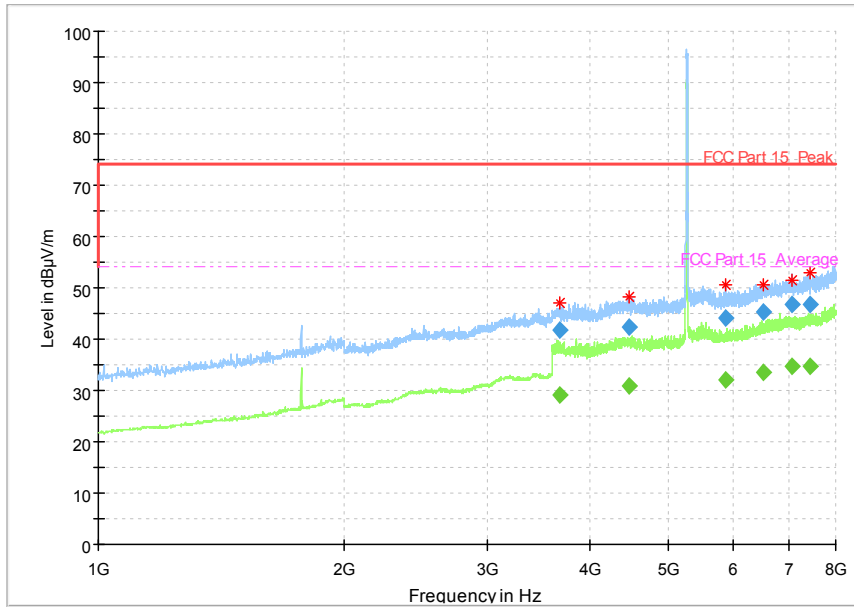
**Fig. 52 Radiated Spurious Emission (802.11 n-HT20, ch64, 26.5 GHz-40 GHz)**

**Second supply**

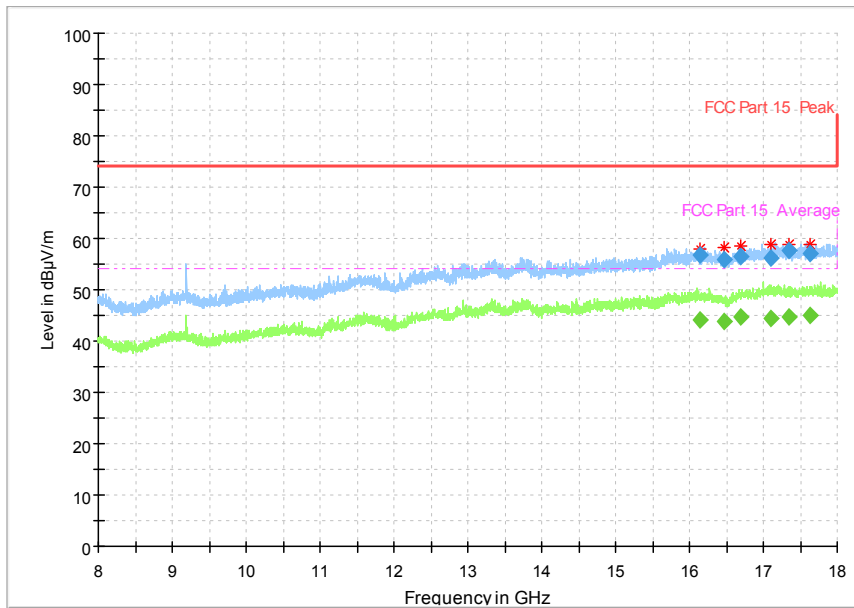


**Fig. 53 Radiated Spurious Emission (802.11a, ch52, 30 MHz-1 GHz)**

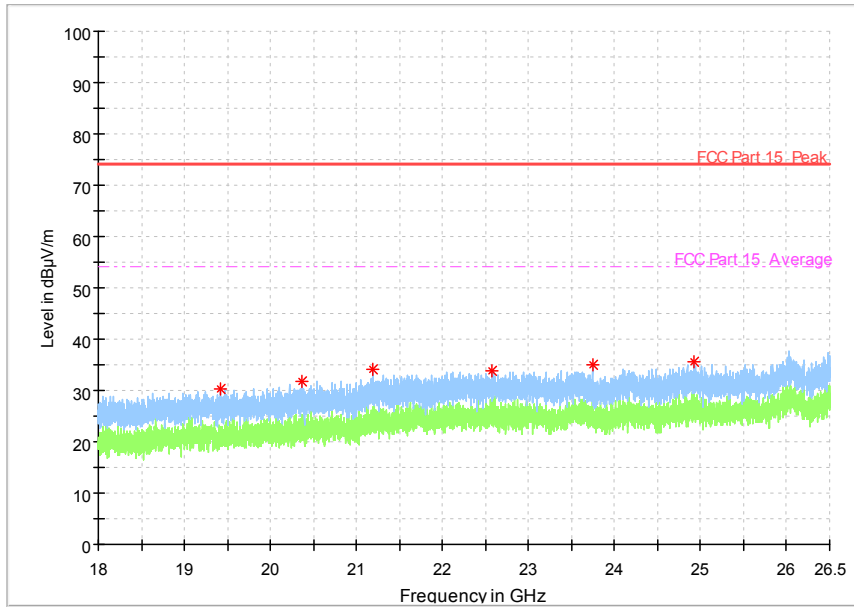




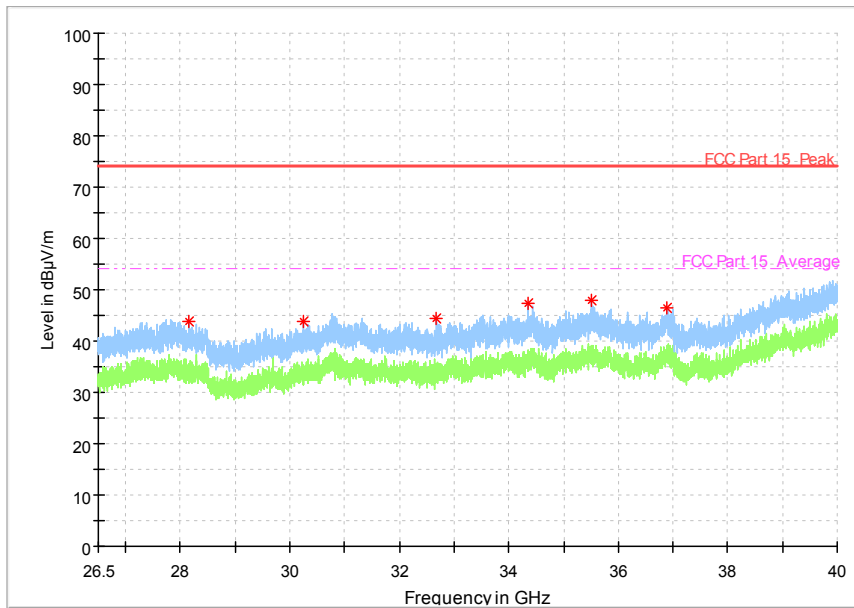
**Fig. 54 Radiated Spurious Emission (802.11a, ch52, 1 GHz-8 GHz)**



**Fig. 55 Radiated Spurious Emission (802.11a, ch52, 8 GHz-18 GHz)**



**Fig. 56 Radiated Spurious Emission (802.11a, ch52, 18 GHz-26.5 GHz)**



**Fig. 57 Radiated Spurious Emission (802.11a, ch52, 26.5 GHz-40 GHz)**

## 6.8. Conducted Emission (150kHz- 30MHz)

**Test Condition:**

Voltage (V)	Frequency (Hz)
120	60

**Measurement uncertainty:**

Expanded measurement uncertainty for this test item is U =3.2dB, k=2.

**Measurement Result and limit:**

WLAN (Quasi-peak Limit)

Frequency range (MHz)	Quasi-peak Limit (dB $\mu$ V)	Result (dB $\mu$ V)		Conclusion
		With charger		
		11a mode		
0.15 to 0.5	66 to 56	Fig. 46		P
0.5 to 5	56			
5 to 30	60			

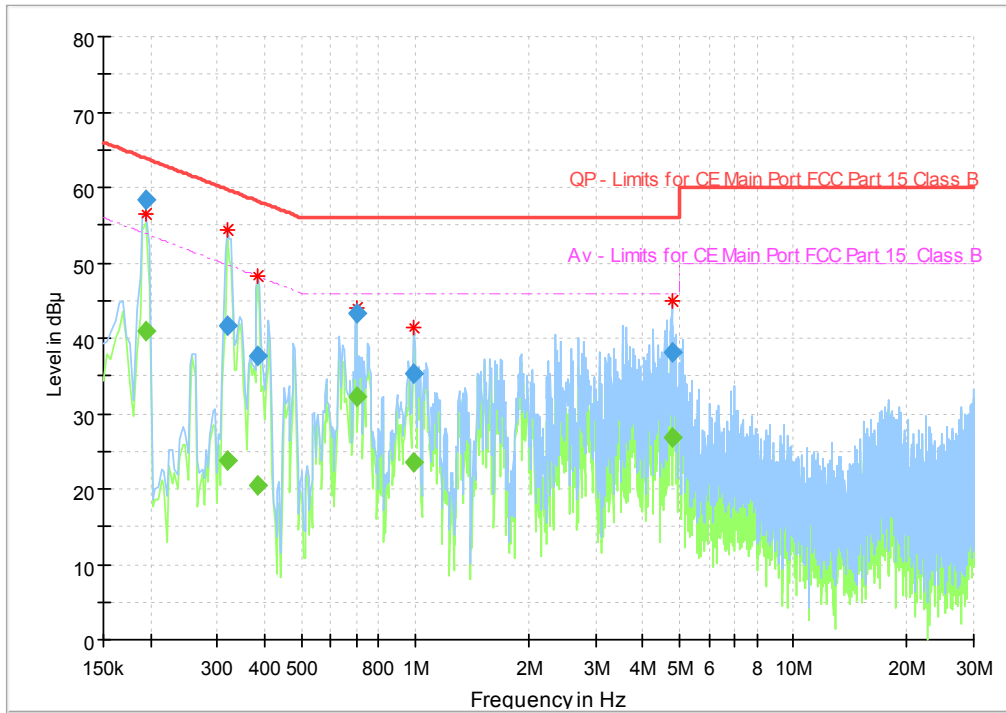
NOTE: The limit decreases linearly with the logarithm of the frequency in the range 0.15 MHz to 0.5 MHz.

WLAN (Average Limit)

Frequency range (MHz)	Average Limit (dB $\mu$ V)	Result (dB $\mu$ V)		Conclusion
		With charger		
		11a mode		
0.15 to 0.5	56 to 46	Fig. 46		P
0.5 to 5	46			
5 to 30	50			

NOTE: The limit decreases linearly with the logarithm of the frequency in the range 0.15 MHz to 0.5 MHz.

**Conclusion: PASS**
**Test graphs as below:**



**Fig. 58 Conducted Emission(802.11a, TX)**

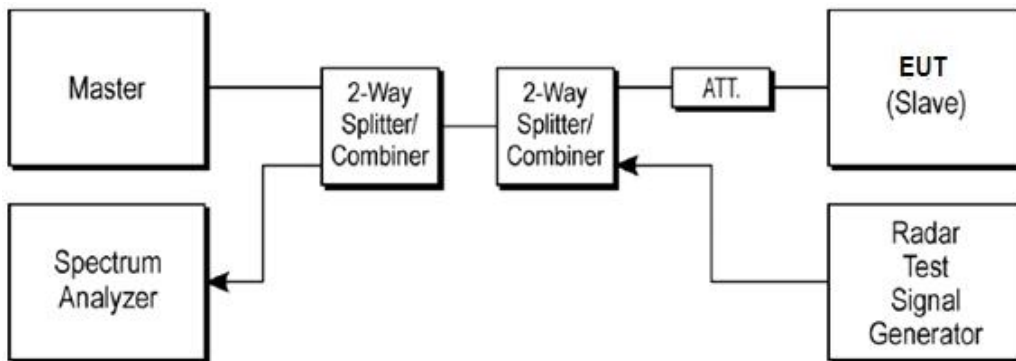
Measurement Result:

Frequency (MHz)	QuasiPeak (dB $\mu$ V)	Average (dB $\mu$ V)	Limit (dB $\mu$ )	Margin (dB)	Meas. Time	Bandwidth (kHz)	Line	Filter	Corr. (dB)
0.194775	---	41.02	53.83	12.81	1000.0	9.000	N	ON	9.6
0.194775	58.34	---	63.83	5.49	1000.0	9.000	N	ON	9.6
0.317906	41.75	---	59.76	18.01	1000.0	9.000	L1	ON	9.6
0.317906	---	23.87	49.76	25.89	1000.0	9.000	L1	ON	9.6
0.385069	37.61	---	58.17	20.56	1000.0	9.000	N	ON	9.7
0.385069	---	20.49	48.17	27.68	1000.0	9.000	N	ON	9.7
0.698494	43.22	---	56.00	12.78	1000.0	9.000	L1	ON	9.7
0.698494	---	32.15	46.00	13.85	1000.0	9.000	L1	ON	9.7
0.993262	35.31	---	56.00	20.69	1000.0	9.000	L1	ON	9.7
0.993262	---	23.56	46.00	22.44	1000.0	9.000	L1	ON	9.7
4.769288	---	26.77	46.00	19.23	1000.0	9.000	N	ON	9.7
4.769288	38.02	---	56.00	17.98	1000.0	9.000	N	ON	9.7

## 6.9 DFS

### Measurement Method:

The below figure shows the DFS setup, where the EUT is a RLAN device operating in slave mode, without Radar Interference Detection function. This setup also contains a device operating in master mode. The radar test signals are injected into the master device. The EUT (slave device) is associated with the master device. WLAN traffic is generated by streaming the mpeg file from the master to the slave in full monitor video mode using the media player.

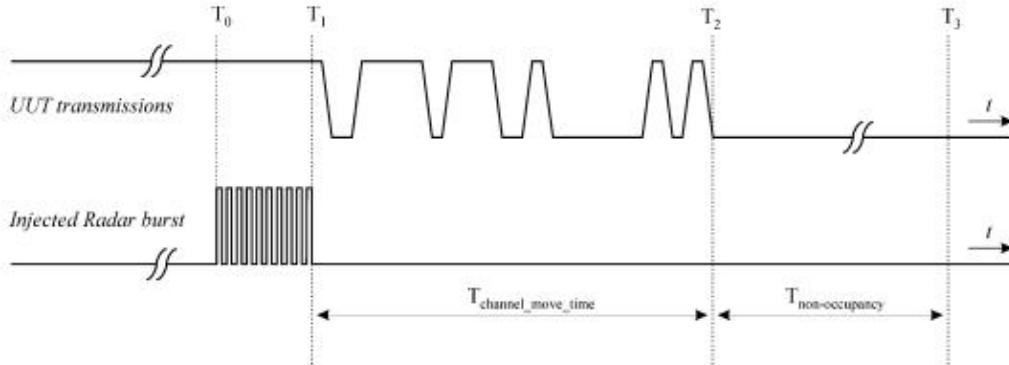


### Testing Process:

- a) One frequency will be chosen from the Operating Channels of the UUT within the 5250-5350 MHz or 5470-5725 MHz bands. For 802.11 devices, the test frequency must contain control signals. This can be verified by disabling channel loading and monitoring the spectrum analyzer. If no control signals are detected, another frequency must be selected within the emission bandwidth where control signals are detected.
- b) In case the UUT is a U-NII device operating as a Client Device (with or without DFS), a U-NII device operating as a Master Device will be used to allow the UUT (Client device) to Associate with the Master Device. In case the UUT is a Master Device, a U-NII device operating as a Client Device will be used and it is assumed that the Client will Associate with the UUT (Master). In both cases for conducted tests, the Radar Waveform generator will be connected to the Master Device. For radiated tests, the emissions of the Radar Waveform generator will be directed towards the Master Device. If the Master Device has antenna gain, the main beam of the antenna will be directed toward the radar emitter. Vertical polarization is used for testing.
- c) Stream the channel loading test file from the Master Device to the Client Device on the test Channel for the entire period of the test.
- d) At time T0 the Radar Waveform generator sends a Burst of pulses for one of the Radar Type 0 in Table 5 at levels defined in Table 3, on the Operating Channel. An additional 1 dB is added to the radar test signal to ensure it is at or above the DFS Detection Threshold, accounting for equipment variations/errors.
- e) Observe the transmissions of the UUT at the end of the radar Burst on the Operating Channel for duration greater than 10 seconds. Measure and record the transmissions from the UUT during the observation time (Channel Move Time). Measure and record the Channel Move Time and Channel Closing Transmission Time if radar detection occurs.

Figure 17 illustrates Channel Closing Transmission Time.

- f) When operating as a Master Device, monitor the UUT for more than 30 minutes following instant T2 to verify that the UUT does not resume any transmissions on this Channel. Perform this test once and record the measurement result.
- g) In case the UUT is a U-NII device operating as a Client Device with In-Service Monitoring, perform steps a) to f).



Note:

- 1) All Measurements are performed with the EUT's narrowest channel bandwidth.
- 2) The master device information is as follows  
 Vendor: Cisco  
 Model: AIR-CAP3702E-A-K9  
 FCC ID: LDK102087
- 3) The software of radar signal generator (R&S SMU200A) is completely designed based on KDB 905462 requirement.

**Channel Loading**

System testing will be performed with channel-loading using means appropriate to the data types that are used by the unlicensed device. The following requirements apply:

- a) The data file must be of a type that is typical for the device (i.e., MPEG-2, MPEG-4, WAV, MP3, MP4, AVI, etc.) and must generally be transmitting in a streaming mode.
- b) Software to ping the client is permitted to simulate data transfer but must have random ping intervals.
- c) Timing plots are required with calculations demonstrating a minimum channel loading of approximately 17% or greater. For example, channel loading can be estimated by setting the spectrum analyzer for zero span and approximate the Time On/ (Time On + Off Time). This can be done with any appropriate channel BW and modulation type.
- d) Unicast or Multicast protocols are preferable but other protocols may be used. The appropriate protocol used must be described in the test procedures.

**Measurement uncertainty:**

Item	Measurement Uncertainty
Time	0.70 ms
Power	0.75 dBm

**Measurement Limit:**

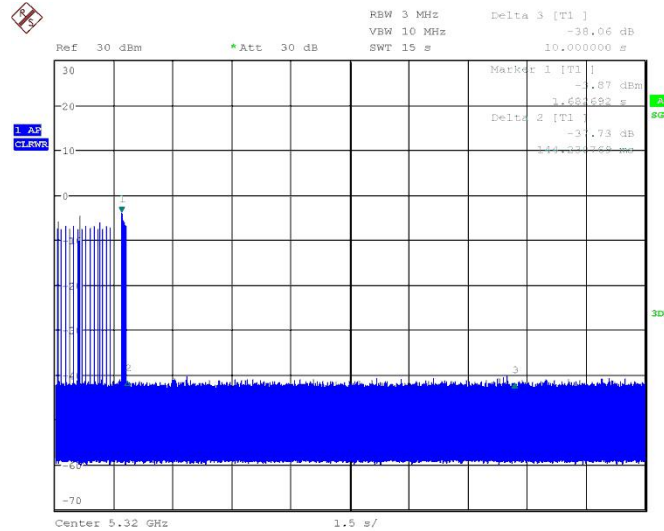
Test Items	Limit
------------	-------

channel closing transmission time	< 200 ms + 60 ms
Channel move time	< 10 s

**Measurement Results:**

**Channel move time and channel closing transmission time**

**HT20 Frequency Band: 5250MHz ~ 5350MHz**



The channel move time is as the figure. It shows the time of the radar and the client pulses. The figure shows that the client stops transmission within 10 seconds, and no transmissions occur after 10 seconds later of the radar burst signal. The closing transmission time is as the figure, and the result is 114.23ms

**Conclusion: PASS**

## 6.10. Frequency Stability

Manufacturers ensured the EUT meet the requirement of frequency stability, such that an emission is maintained within the band of operation under all conditions of normal operation as specified in the user's manual.

## 6.11. Power control

A Transmission Power Control mechanism is not required for systems with an e.i.r.p. of less than 27dBm (500 mW).



## 7. Test Equipment and Ancillaries Used For Tests

The test equipment and ancillaries used are as follows.

### Conducted test system

No.	Equipment	Model	Serial Number	Manufacturer	Calibration date	Cal.interval
1	Vector Signal Analyzer	FSQ40	200063	Rohde&Schwarz	2017-12-17	1 Year
2	DC Power Supply	ZUP60-14	LOC-220Z006-0007	TDL-Lambda	2017-05-11	1 Year
3	Signal Generator	SMU200 A	104684	Rohde&Schwarz	2017-05-11	1 Year

### Radiated emission test system

No.	Equipment	Model	Serial Number	Manufacturer	Calibration date	Cal.interval
1	Universal Radio Communication Tester	CMU200	123123	R&S	2017-05-11	1 Year
2	EMI Test Receiver	ESU40	100307	R&S	2017-05-11	1 Year
3	TRILOG Broadband Antenna	VULB9163	VULB9163-515	Schwarzbeck	2017-02-25	3 Year
4	Double-ridged Waveguide Antenna	ETS-3117	00135890	ETS	2017-01-11	3 Year
5	2-Line V-Network	ENV216	101380	R&S	2017-05-11	1 Year

### Anechoic chamber

Fully anechoic chamber by Frankonia German.

## 8. Test Environment

**Shielding Room1** (6.0 meters×3.0 meters×2.7 meters) did not exceed following limits along the conducted RF performance testing:

Temperature	Min. = 15 °C, Max. = 35 °C
Relative humidity	Min. = 20 %, Max. = 75 %
Shielding effectiveness	> 100 dB
Ground system resistance	< 0.5

**Control room** did not exceed following limits along the EMC testing:

Temperature	Min. = 15 °C, Max. = 35 °C
Relative humidity	Min. =25 %, Max. = 75 %
Shielding effectiveness	> 100 dB
Electrical insulation	> 10 k
Ground system resistance	< 0.5

**Fully-anechoic chamber1** (6.9 meters×10.9 meters×5.4 meters) did not exceed following limits along the EMC testing:

Temperature	Min. = 15 °C, Max. = 35 °C
Relative humidity	Min. = 25 %, Max. = 75 %
Shielding effectiveness	> 100 dB
Electrical insulation	> 10 k
Ground system resistance	< 0.5
VSWR	Between 0 and 6 dB, from 1GHz to 18GHz
Site Attenuation Deviation	Between -4 and 4 dB,30MHz to 1GHz
Uniformity of field strength	Between 0 and 6 dB, from 80MHz to 3000 MHz

**ANNEX A. Accreditation Certificate**



**Accredited Laboratory**

A2LA has accredited

**EAST CHINA INSTITUTE OF TELECOMMUNICATIONS**

*Shanghai, People's Republic of China*

for technical competence in the field of

**Electrical Testing**

This laboratory is accredited in accordance with the recognized International Standard ISO/IEC 17025:2005 *General requirements for the competence of testing and calibration laboratories*. This accreditation demonstrates technical competence for a defined scope and the operation of a laboratory quality management system (refer to joint ISO-ILAC-IAF Communiqué dated 8 January 2009).



Presented this 15<sup>th</sup> day of March 2017.

  
President and CEO  
For the Accreditation Council  
Certificate Number 3682.01  
Valid to February 28, 2019

*For the tests to which this accreditation applies, please refer to the laboratory's Electrical Scope of Accreditation.*



\*\*\*\*\*END OF REPORT\*\*\*\*\*