

Picture D.3 Tilt position of the wireless device on the left side of SAM

D.2. Body-worn device

A typical example of a body-worn device is a mobile phone, wireless enabled PDA or other battery operated wireless device with the ability to transmit while mounted on a person's body using a carry accessory approved by the wireless device manufacturer.

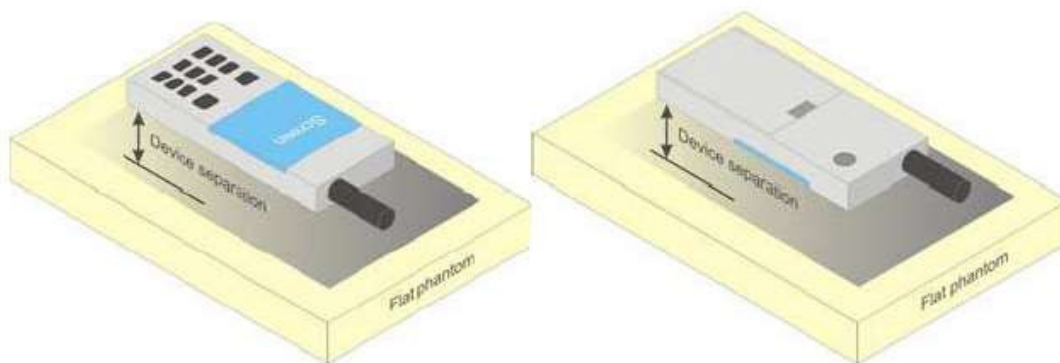

Picture D.4 Test positions for body-worn devices

D.3. Desktop device

A typical example of a desktop device is a wireless enabled desktop computer placed on a table or desk when used.

The DUT shall be positioned at the distance and in the orientation to the phantom that corresponds to the intended use as specified by the manufacturer in the user instructions. For devices that employ an external antenna with variable positions, tests shall be performed for all antenna positions specified. Picture 8.5 show positions for desktop device SAR tests. If the intended use is not specified, the device shall be tested directly against the flat phantom.

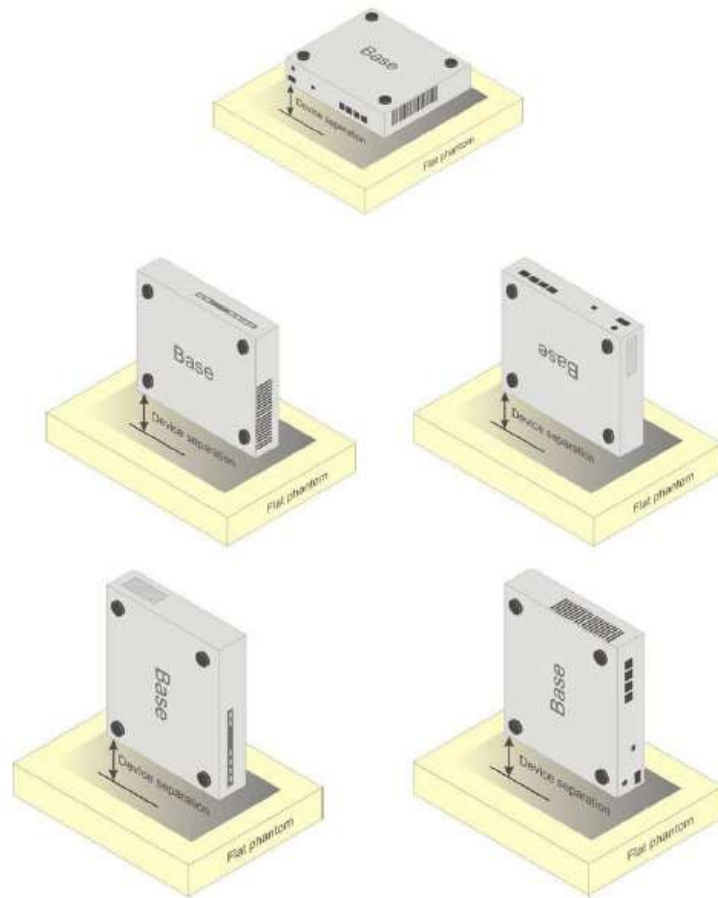

Picture D.5 Test positions for desktop devices

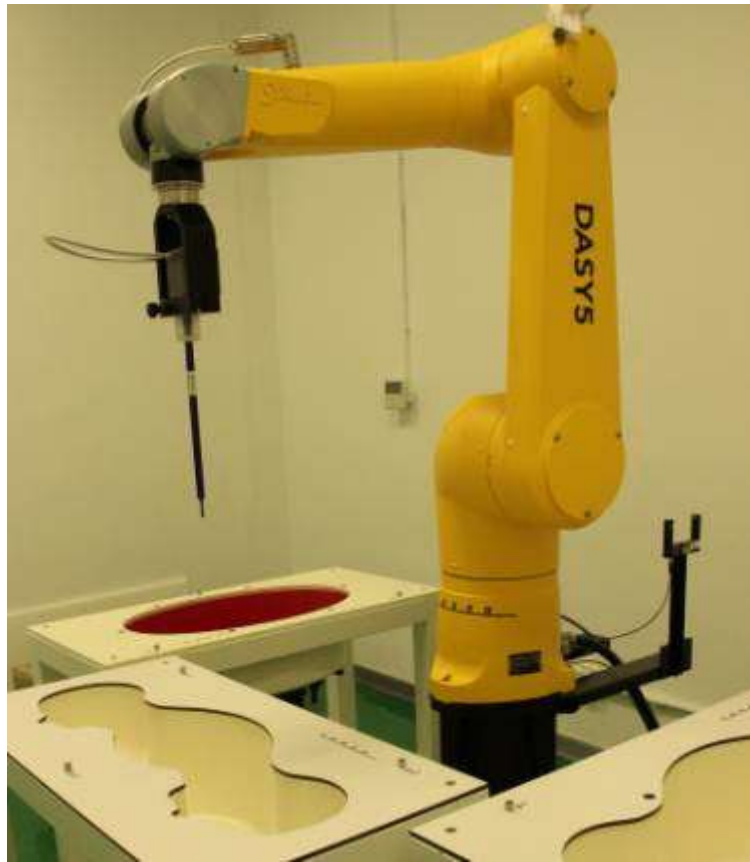
D.4. DUT Setup Photos**Picture D.6 DSY5 system Set-up****Note:**

The photos of test sample and test positions show in additional document.

ANNEX E. Equivalent Media Recipes

The liquid used for the frequency range of 800-3000 MHz consisted of water, sugar, salt, preventol, glycol monobutyl and Cellulose. The liquid has been previously proven to be suited for worst-case. The Table E.1 shows the detail solution. It's satisfying the latest tissue dielectric parameters requirements proposed by the IEEE 1528 and IEC 62209.

Table E.1: Composition of the Tissue Equivalent Matter

Frequency (MHz)	835 Head	835 Body	1900 Head	1900 Body	2450 Head	2450 Body
Ingredients (% by weight)						
Water	41.45	52.5	55.242	69.91	58.79	72.60
Sugar	56.0	45.0	\	\	\	\
Salt	1.45	1.4	0.306	0.13	0.06	0.18
Preventol	0.1	0.1	\	\	\	\
Cellulose	1.0	1.0	\	\	\	\
Glycol Monobutyl	\	\	44.452	29.96	41.15	27.22
Dielectric Parameters	$\epsilon=41.5$	$\epsilon=55.2$	$\epsilon=40.0$	$\epsilon=53.3$	$\epsilon=39.2$	$\epsilon=52.7$
Target Value	$\sigma=0.90$	$\sigma=0.97$	$\sigma=1.40$	$\sigma=1.52$	$\sigma=1.80$	$\sigma=1.95$

ANNEX F. System Validation

The SAR system must be validated against its performance specifications before it is deployed. When SAR probes, system components or software are changed, upgraded or recalibrated, these must be validated with the SAR system(s) that operates with such components.

Table F.1: System Validation Part 1

System No.	Probe SN.	Liquid name	Validation date	Frequency point	Permittivity ϵ	Conductivity σ (S/m)
1	3252	Head 750MHz	Feb 2, 2018	750 MHz	43.156	0.858
2	3252	Head 835MHz	Feb 3, 2018	835 MHz	42.971	0.939
3	3252	Head 1800MHz	Feb 4, 2018	1800 MHz	40.544	1.375
4	3252	Head 1900MHz	Feb 5, 2018	1900 MHz	38.788	1.349
5	3252	Head 2450MHz	Feb 11, 2018	2450 MHz	40.902	1.821
6	3252	Head 2600MHz	Mar 4, 2018	2600 MHz	38.249	2.035
7	7350	Head 5300MHz	Feb 6, 2018	5300 MHz	36.988	4.697
8	7350	Head 5800MHz	Feb 6, 2018	5800 MHz	36.059	5.243
9	3252	Body 750MHz	Feb 2, 2018	750 MHz	57.684	0.945
10	3252	Body 835MHz	Feb 3, 2018	835 MHz	56.695	0.998
11	3252	Body 1750MHz	Feb 4, 2018	1800 MHz	55.0	1.473
12	3252	Body 1900MHz	Feb 5, 2018	1900 MHz	54.596	1.576
13	3252	Body 2450MHz	Feb 11, 2018	2450 MHz	53.002	1.976
14	3252	Body 2600MHz	Mar 4, 2018	2600 MHz	52.858	2.083
15	7350	Body 5300MHz	Feb 6, 2018	5300 MHz	49.847	5.333
16	7350	Body 5800MHz	Feb 6, 2018	5800 MHz	48.828	6.051

Table F.2: System Validation Part 2

CW Validation	Sensitivity	PASS	PASS
	Probe linearity	PASS	PASS
	Probe Isotropy	PASS	PASS
Mod Validation	MOD.type	GMSK	GMSK
	MOD.type	OFDM	OFDM
	Duty factor	PASS	PASS
	PAR	PASS	PASS

ANNEX G. Probe and DAE Calibration Certificate

In Collaboration with

CALIBRATION LABORATORY

中国认可
国际互认
校准
CALIBRATION
CNAS L0570

Add: No.51 Xueyuan Road, Haidian District, Beijing, 100191, China
 Tel: +86-10-62304633-2218 Fax: +86-10-62304633-2209
 E-mail: cttl@chinattl.com Http://www.chinattl.cn

Client : **ECIT** Certificate No: **Z17-97266**

CALIBRATION CERTIFICATE

Object: **DAE4 - SN: 1244**

Calibration Procedure(s): **FF-Z11-002-01
Calibration Procedure for the Data Acquisition Electronics (DAEx)**

Calibration date: **December 04, 2017**

This calibration Certificate documents the traceability to national standards, which realize the physical units of measurements(SI). The measurements and the uncertainties with confidence probability are given on the following pages and are part of the certificate.

All calibrations have been conducted in the closed laboratory facility; environment temperature(22±3)°C and humidity<70%.

Calibration Equipment used (M&TE critical for calibration)

Primary Standards	ID #	Cal Date(Calibrated by, Certificate No.)	Scheduled Calibration
Process Calibrator 753	1971018	27-Jun-17 (CTTL, No.J17X05859)	June-18

	Name	Function	Signature
Calibrated by:	Yu Zongying	SAR Test Engineer	
Reviewed by:	Lin Hao	SAR Test Engineer	
Approved by:	Qi Dianyuan	SAR Project Leader	

Issued: December 05, 2017

This calibration certificate shall not be reproduced except in full without written approval of the laboratory.

Certificate No: Z17-97266
Page 1 of 3



Add: No.51 Xueyuan Road, Haidian District, Beijing, 100191, China
Tel: +86-10-62304633-2218 Fax: +86-10-62304633-2209
E-mail: cntl@chinantl.com Http://www.chinantl.cn

Glossary:

DAE data acquisition electronics
Connector angle information used in DASY system to align probe sensor X to the robot coordinate system.

Methods Applied and Interpretation of Parameters:

- *DC Voltage Measurement:* Calibration Factor assessed for use in DASY system by comparison with a calibrated instrument traceable to national standards. The figure given corresponds to the full scale range of the voltmeter in the respective range.
- *Connector angle:* The angle of the connector is assessed measuring the angle mechanically by a tool inserted. Uncertainty is not required.
- The report provide only calibration results for DAE, it does not contain other performance test results.



In Collaboration with
TTL Speaq
CALIBRATION LABORATORY
 Add: No.51 Xueyuan Road, Haidian District, Beijing, 100191, China
 Tel: +86-10-62304633-2218 Fax: +86-10-62304633-2209
 E-mail: cttl@chinattl.com Http://www.chinattl.cn

DC Voltage Measurement

A/D - Converter Resolution nominal
 High Range: 1LSB = 6.1 μ V, full range = -100...+300 mV
 Low Range: 1LSB = 61nV, full range = -1.....+3mV
 DASY measurement parameters: Auto Zero Time: 3 sec; Measuring time: 3 sec

Calibration Factors	X	Y	Z
High Range	403.862 \pm 0.15% (k=2)	403.603 \pm 0.15% (k=2)	404.516 \pm 0.15% (k=2)
Low Range	3.95366 \pm 0.7% (k=2)	3.96972 \pm 0.7% (k=2)	3.97929 \pm 0.7% (k=2)

Connector Angle

Connector Angle to be used in DASY system	22.5° \pm 1°
---	----------------



In Collaboration with
 Add: No.51 Xueyuan Road, Haidian District, Beijing, 100191, China
 Tel: +86-10-62304633-2218 Fax: +86-10-62304633-2209
 E-mail: ctt@chinattl.com Http://www.chinattl.cn



中国认可
 国际互认
 校准
 CALIBRATION
 CNAS L0570

Client **ECIT** Certificate No: **Z17-97112**

CALIBRATION CERTIFICATE				
Object	ES3DV3 - SN:3252			
Calibration Procedure(s)	FF-Z11-004-01 Calibration Procedures for Dosimetric E-field Probes			
Calibration date:	August 31, 2017			
<p>This calibration Certificate documents the traceability to national standards, which realize the physical units of measurements(SI). The measurements and the uncertainties with confidence probability are given on the following pages and are part of the certificate.</p> <p>All calibrations have been conducted in the closed laboratory facility; environment temperature(22±3)°C and humidity<70%.</p> <p>Calibration Equipment used (M&TE critical for calibration)</p>				
Primary Standards	ID #	Cal Date(Calibrated by, Certificate No.)		Scheduled Calibration
Power Meter NRP2	101919	27-Jun-17 (CTTL, No.J17X05857)		Jun-18
Power sensor NRP-Z91	101547	27-Jun-17 (CTTL, No.J17X05857)		Jun-18
Power sensor NRP-Z91	101548	27-Jun-17 (CTTL, No.J17X05857)		Jun-18
Reference10dBAttenuator	18N50W-10dB	13-Mar-16(CTTL, No.J16X01547)		Mar-18
Reference20dBAttenuator	18N50W-20dB	13-Mar-16(CTTL, No.J16X01548)		Mar-18
Reference Probe EX3DV4	SN 7433	26-Sep-16(SPEAG, No EX3-7433_Sep16)		Sep-17
DAE4	SN 549	13-Dec-16(SPEAG, No.DAE4-549_Dec16)		Dec -17
Secondary Standards	ID #	Cal Date(Calibrated by, Certificate No.)		Scheduled Calibration
SignalGeneratorMG3700A	6201052605	27-Jun-17 (CTTL, No.J17X05858)		Jun-18
Network Analyzer E5071C	MY46110673	13-Jan-17 (CTTL, No.J17X00285)		Jan -18
Calibrated by:	Name	Function	Signature	
	Yu Zongying	SAR Test Engineer		
Reviewed by:	Lin Hao	SAR Test Engineer		
Approved by:	Qi Dianyuan	SAR Project Leader		
Issued: September 01, 2017				
This calibration certificate shall not be reproduced except in full without written approval of the laboratory.				



Add: No.51 Xueyuan Road, Haidian District, Beijing, 100191, China
Tel: +86-10-62304633-2218 Fax: +86-10-62304633-2209
E-mail: cttl@chinattl.com <http://www.chinattl.cn>

Glossary:

TSL	tissue simulating liquid
NORM _{x,y,z}	sensitivity in free space
ConvF	sensitivity in TSL / NORM _{x,y,z}
DCP	diode compression point
CF	crest factor (1/duty_cycle) of the RF signal
A,B,C,D	modulation dependent linearization parameters
Polarization Φ	Φ rotation around probe axis
Polarization θ	θ rotation around an axis that is in the plane normal to probe axis (at measurement center), $\theta=0$ is normal to probe axis

Connector Angle information used in DASY system to align probe sensor X to the robot coordinate system

Calibration is Performed According to the Following Standards:

- IEEE Std 1528-2013, "IEEE Recommended Practice for Determining the Peak Spatial-Averaged Specific Absorption Rate (SAR) in the Human Head from Wireless Communications Devices: Measurement Techniques", June 2013
- IEC 62209-1, "Measurement procedure for the assessment of Specific Absorption Rate (SAR) from hand-held and body-mounted devices used next to the ear (frequency range of 300 MHz to 6 GHz)", July 2016
- IEC 62209-2, "Procedure to determine the Specific Absorption Rate (SAR) for wireless communication devices used in close proximity to the human body (frequency range of 30 MHz to 6 GHz)", March 2010
- KDB 865664, "SAR Measurement Requirements for 100 MHz to 6 GHz"

Methods Applied and Interpretation of Parameters:

- NORM_{x,y,z}**: Assessed for E-field polarization $\theta=0$ ($f \leq 900$ MHz in TEM-cell; $f > 1800$ MHz: waveguide). NORM_{x,y,z} are only intermediate values, i.e., the uncertainties of NORM_{x,y,z} does not effect the E^2 -field uncertainty inside TSL (see below ConvF).
- NORM(f)_{x,y,z} = NORM_{x,y,z} * frequency_response** (see Frequency Response Chart). This linearization is implemented in DASY4 software versions later than 4.2. The uncertainty of the frequency response is included in the stated uncertainty of ConvF.
- DCP_{x,y,z}**: DCP are numerical linearization parameters assessed based on the data of power sweep (no uncertainty required). DCP does not depend on frequency nor media.
- PAR**: PAR is the Peak to Average Ratio that is not calibrated but determined based on the signal characteristics.
- A_{x,y,z}; B_{x,y,z}; C_{x,y,z}; VR_{x,y,z}; A,B,C** are numerical linearization parameters assessed based on the data of power sweep for specific modulation signal. The parameters do not depend on frequency nor media. VR is the maximum calibration range expressed in RMS voltage across the diode.
- ConvF and Boundary Effect Parameters**: Assessed in flat phantom using E-field (or Temperature Transfer Standard for $f > 800$ MHz) and inside waveguide using analytical field distributions based on power measurements for $f > 800$ MHz. The same setups are used for assessment of the parameters applied for boundary compensation (alpha, depth) of which typical uncertainty valued are given. These parameters are used in DASY4 software to improve probe accuracy close to the boundary. The sensitivity in TSL corresponds to NORM_{x,y,z} * ConvF whereby the uncertainty corresponds to that given for ConvF. A frequency dependent ConvF is used in DASY version 4.4 and higher which allows extending the validity from ± 50 MHz to ± 100 MHz.
- Spherical isotropy (3D deviation from isotropy)**: in a field of low gradients realized using a flat phantom exposed by a patch antenna.
- Sensor Offset**: The sensor offset corresponds to the offset of virtual measurement center from the probe tip (on probe axis). No tolerance required.
- Connector Angle**: The angle is assessed using the information gained by determining the NORM_x (no uncertainty required).



Add: No.51 Xueyuan Road, Haidian District, Beijing, 100191, China
Tel: +86-10-62304633-2218 Fax: +86-10-62304633-2209
E-mail: cttl@chinattl.com <http://www.chinattl.cn>

Glossary:

TSL	tissue simulating liquid
NORM _{x,y,z}	sensitivity in free space
ConvF	sensitivity in TSL / NORM _{x,y,z}
DCP	diode compression point
CF	crest factor (1/duty_cycle) of the RF signal
A,B,C,D	modulation dependent linearization parameters
Polarization Φ	Φ rotation around probe axis
Polarization θ	θ rotation around an axis that is in the plane normal to probe axis (at measurement center), $\theta=0$ is normal to probe axis

Connector Angle information used in DASY system to align probe sensor X to the robot coordinate system

Calibration is Performed According to the Following Standards:

- IEEE Std 1528-2013, "IEEE Recommended Practice for Determining the Peak Spatial-Averaged Specific Absorption Rate (SAR) in the Human Head from Wireless Communications Devices: Measurement Techniques", June 2013
- IEC 62209-1, "Measurement procedure for the assessment of Specific Absorption Rate (SAR) from hand-held and body-mounted devices used next to the ear (frequency range of 300 MHz to 6 GHz)", July 2016
- IEC 62209-2, "Procedure to determine the Specific Absorption Rate (SAR) for wireless communication devices used in close proximity to the human body (frequency range of 30 MHz to 6 GHz)", March 2010
- KDB 865664, "SAR Measurement Requirements for 100 MHz to 6 GHz"

Methods Applied and Interpretation of Parameters:

- NORM_{x,y,z}**: Assessed for E-field polarization $\theta=0$ ($f \leq 900$ MHz in TEM-cell; $f > 1800$ MHz: waveguide). NORM_{x,y,z} are only intermediate values, i.e., the uncertainties of NORM_{x,y,z} does not effect the E^2 -field uncertainty inside TSL (see below ConvF).
- NORM(f)_{x,y,z} = NORM_{x,y,z} * frequency_response** (see Frequency Response Chart). This linearization is implemented in DASY4 software versions later than 4.2. The uncertainty of the frequency response is included in the stated uncertainty of ConvF.
- DCP_{x,y,z}**: DCP are numerical linearization parameters assessed based on the data of power sweep (no uncertainty required). DCP does not depend on frequency nor media.
- PAR**: PAR is the Peak to Average Ratio that is not calibrated but determined based on the signal characteristics.
- A_{x,y,z}; B_{x,y,z}; C_{x,y,z}; VR_{x,y,z}; A,B,C** are numerical linearization parameters assessed based on the data of power sweep for specific modulation signal. The parameters do not depend on frequency nor media. VR is the maximum calibration range expressed in RMS voltage across the diode.
- ConvF and Boundary Effect Parameters**: Assessed in flat phantom using E-field (or Temperature Transfer Standard for $f > 800$ MHz) and inside waveguide using analytical field distributions based on power measurements for $f > 800$ MHz. The same setups are used for assessment of the parameters applied for boundary compensation (alpha, depth) of which typical uncertainty valued are given. These parameters are used in DASY4 software to improve probe accuracy close to the boundary. The sensitivity in TSL corresponds to NORM_{x,y,z} * ConvF whereby the uncertainty corresponds to that given for ConvF. A frequency dependent ConvF is used in DASY version 4.4 and higher which allows extending the validity from ± 50 MHz to ± 100 MHz.
- Spherical isotropy (3D deviation from isotropy)**: in a field of low gradients realized using a flat phantom exposed by a patch antenna.
- Sensor Offset**: The sensor offset corresponds to the offset of virtual measurement center from the probe tip (on probe axis). No tolerance required.
- Connector Angle**: The angle is assessed using the information gained by determining the NORM_x (no uncertainty required).



In Collaboration with
TTL speag
 CALIBRATION LABORATORY
 Add: No.51 Xueyuan Road, Haidian District, Beijing, 100191, China
 Tel: +86-10-62304633-2218 Fax: +86-10-62304633-2209
 E-mail: ttl@chinant.com <http://www.chinant.com>

DASY/EASY – Parameters of Probe: ES3DV3 - SN: 3252

Basic Calibration Parameters

	Sensor X	Sensor Y	Sensor Z	Unc (k=2)
Norm($\mu\text{V}/(\text{V}/\text{m})^2$) ^A	1.32	1.40	1.37	±10.0%
DCP(mV) ^B	101.5	101.9	101.5	

Modulation Calibration Parameters

UID	Communication System Name		A dB	B dB- μV	C	D dB	VR mV	Unc ^E (k=2)
0	CW	X	0.0	0.0	1.0	0.00	278.4	±2.5%
		Y	0.0	0.0	1.0		287.4	
		Z	0.0	0.0	1.0		284.8	

The reported uncertainty of measurement is stated as the standard uncertainty of Measurement multiplied by the coverage factor k=2, which for a normal distribution Corresponds to a coverage probability of approximately 95%.

^A The uncertainties of Norm X, Y, Z do not affect the E²-field uncertainty inside TSL (see Page 5 and Page 6).
^B Numerical linearization parameter: uncertainty not required.
^E Uncertainty is determined using the max. deviation from linear response applying rectangular distribution and is expressed for the square of the field value.



In Collaboration with
 Add: No.51 Xueyuan Road, Haidian District, Beijing, 100191, China
 Tel: +86-10-62304633-2218 Fax: +86-10-62304633-2209
 E-mail: cttl@chinant.com <http://www.chinantl.cn>

DASY/EASY – Parameters of Probe: ES3DV3 - SN: 3252

Calibration Parameter Determined in Head Tissue Simulating Media

f [MHz] ^c	Relative Permittivity ^f	Conductivity (S/m) ^f	ConvF X	ConvF Y	ConvF Z	Alpha ^g	Depth ^g (mm)	Unct. (k=2)
750	41.9	0.89	6.25	6.25	6.25	0.50	1.25	±12.1%
835	41.5	0.90	6.19	6.19	6.19	0.32	1.66	±12.1%
900	41.5	0.97	6.16	6.16	6.16	0.36	1.62	±12.1%
1750	40.1	1.37	5.30	5.30	5.30	0.42	1.62	±12.1%
1900	40.0	1.40	5.11	5.11	5.11	0.73	1.18	±12.1%
2000	40.0	1.40	4.97	4.97	4.97	0.76	1.19	±12.1%
2300	39.5	1.67	4.90	4.90	4.90	0.90	1.10	±12.1%
2450	39.2	1.80	4.75	4.75	4.75	0.90	1.10	±12.1%
2600	39.0	1.96	4.44	4.44	4.44	0.90	1.15	±12.1%

^c Frequency validity above 300 MHz of ±100MHz only applies for DASY v4.4 and higher (Page 2), else it is restricted to ±50MHz. The uncertainty is the RSS of ConvF uncertainty at calibration frequency and the uncertainty for the indicated frequency band. Frequency validity below 300 MHz is ± 10, 25, 40, 50 and 70 MHz for ConvF assessments at 30, 64, 128, 150 and 220 MHz respectively. Above 5 GHz frequency validity can be extended to ± 110 MHz.

^f At frequency below 3 GHz, the validity of tissue parameters (ϵ and σ) can be relaxed to ±10% if liquid compensation formula is applied to measured SAR values. At frequencies above 3 GHz, the validity of tissue parameters (ϵ and σ) is restricted to ±5%. The uncertainty is the RSS of the ConvF uncertainty for indicated target tissue parameters.

^g Alpha/Depth are determined during calibration. SPEAG warrants that the remaining deviation due to the boundary effect after compensation is always less than ± 1% for frequencies below 3 GHz and below ± 2% for the frequencies between 3-6 GHz at any distance larger than half the probe tip diameter from the boundary.



Add: No.51 Xueyuan Road, Haidian District, Beijing, 100191, China
 Tel: +86-10-62304633-2218 Fax: +86-10-62304633-2209
 E-mail: ttl@chinattl.com <http://www.chinattl.cn>

DASY/EASY – Parameters of Probe: ES3DV3 - SN: 3252

Calibration Parameter Determined in Body Tissue Simulating Media

f [MHz] ^C	Relative Permittivity ^E	Conductivity (S/m) ^F	ConvF X	ConvF Y	ConvF Z	Alpha ^G	Depth ^G (mm)	Unct. (k=2)
750	55.5	0.96	6.34	6.34	6.34	0.60	1.20	±12.1%
850	55.2	0.99	6.14	6.14	6.14	0.38	1.63	±12.1%
900	55.0	1.05	6.06	6.06	6.06	0.46	1.49	±12.1%
1750	53.4	1.49	4.95	4.95	4.95	0.49	1.52	±12.1%
1900	53.3	1.52	4.69	4.69	4.69	0.67	1.33	±12.1%
2000	53.3	1.52	4.89	4.89	4.89	0.69	1.25	±12.1%
2300	52.9	1.81	4.58	4.58	4.58	0.57	1.65	±12.1%
2450	52.7	1.95	4.42	4.42	4.42	0.68	1.42	±12.1%
2600	52.5	2.16	4.22	4.22	4.22	0.56	1.66	±12.1%

^C Frequency validity above 300 MHz of ±100MHz only applies for DASY v4.4 and higher (Page 2), else it is restricted to ±50MHz. The uncertainty is the RSS of ConvF uncertainty at calibration frequency and the uncertainty for the indicated frequency band. Frequency validity below 300 MHz is ± 10, 25, 40, 50 and 70 MHz for ConvF assessments at 30, 64, 128, 150 and 220 MHz respectively. Above 5 GHz frequency validity can be extended to ± 110 MHz.

^E At frequency below 3 GHz, the validity of tissue parameters (ϵ and σ) can be relaxed to ±10% if liquid compensation formula is applied to measured SAR values. At frequencies above 3 GHz, the validity of tissue parameters (ϵ and σ) is restricted to ±5%. The uncertainty is the RSS of the ConvF uncertainty for indicated target tissue parameters.

^G Alpha/Depth are determined during calibration. SPEAG warrants that the remaining deviation due to the boundary effect after compensation is always less than ± 1% for frequencies below 3 GHz and below ± 2% for the frequencies between 3-6 GHz at any distance larger than half the probe tip diameter from the boundary.



Add: No.51 Xueyuan Road, Haidian District, Beijing, 100191, China
Tel: +86-10-62304633-2218 Fax: +86-10-62304633-2209
E-mail: ant@chinant.com <http://www.chinantl.cn>

Frequency Response of E-Field (TEM-Cell: ifi110 EXX, Waveguide: R22)

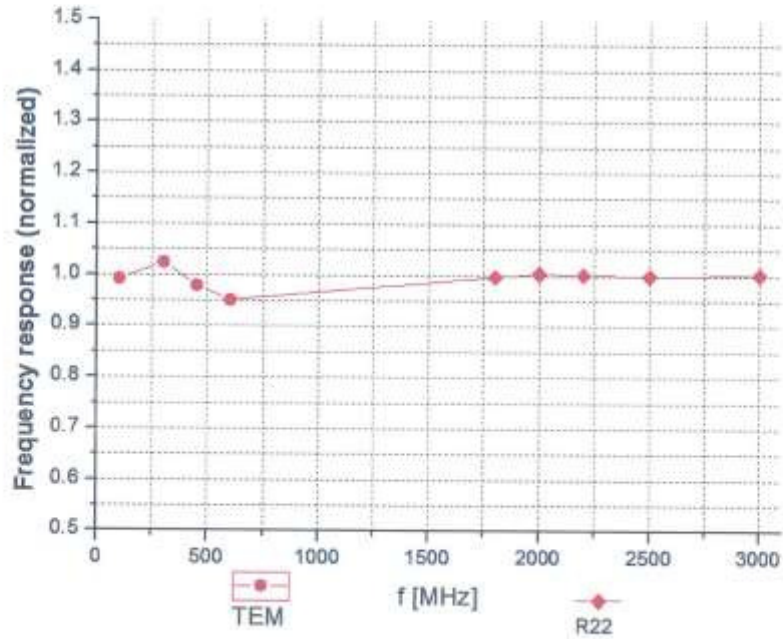

Uncertainty of Frequency Response of E-field: $\pm 7.4\%$ (k=2)



Add: No.51 Xueyuan Road, Haidian District, Beijing, 100191, China
Tel: +86-10-62304633-2218 Fax: +86-10-62304633-2209
E-mail: cttl@chinatf.com <http://www.chinatf.cn>

Receiving Pattern (Φ), $\theta=0^\circ$

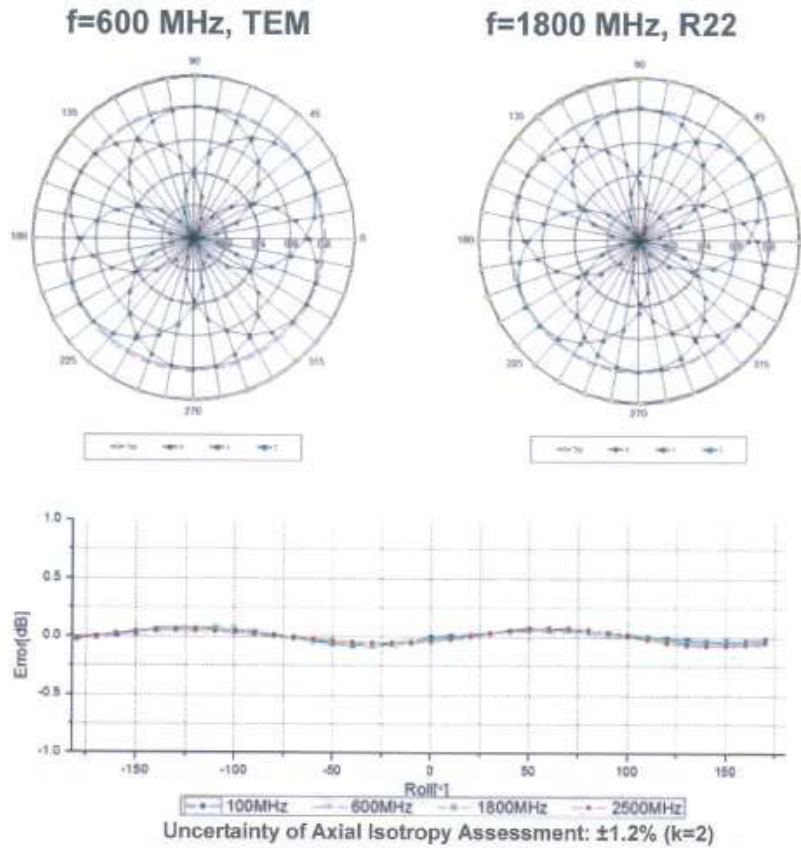



In Collaboration with
TTL speaq
 CALIBRATION LABORATORY
 Add: No.51 Xueyuan Road, Haidian District, Beijing, 100191, China
 Tel: +86-10-62304633-2218 Fax: +86-10-62304633-2209
 E-mail: cti@chinant.com [Http://www.chinant.cn](http://www.chinant.cn)

Dynamic Range f(SAR_{head}) (TEM cell, f = 900 MHz)

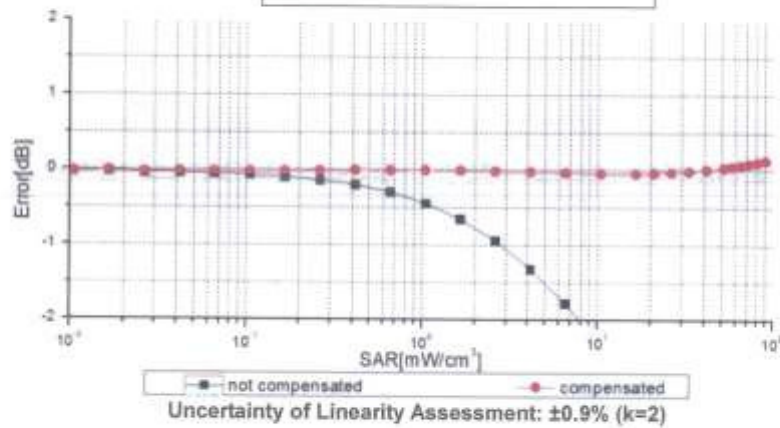
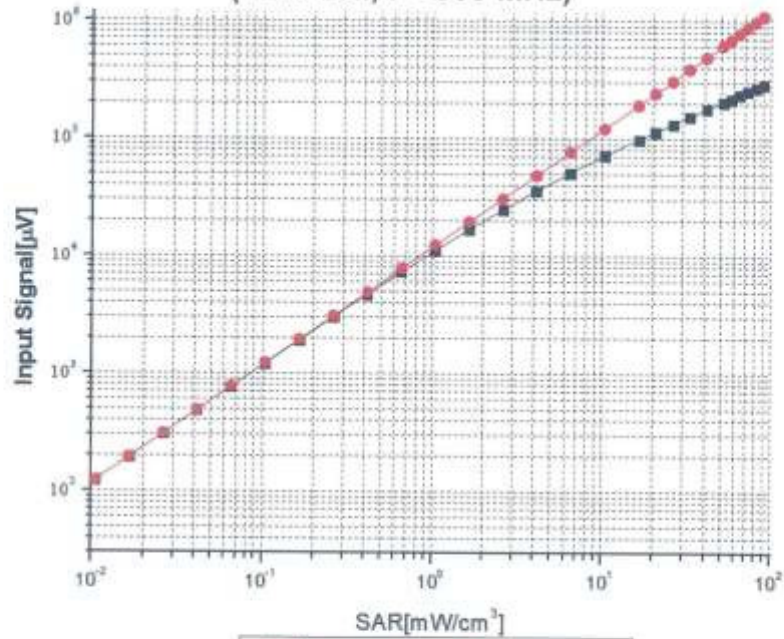



In Collaboration with
TTLspeaq
 CALIBRATION LABORATORY
 Add: No.51 Xueyuan Road, Haidian District, Beijing, 100191, China
 Tel: +86-10-62304633-2218 Fax: +86-10-62304633-2209
 E-mail: cntl@chinattl.com <http://www.chinattl.cn>

Conversion Factor Assessment

f=835 MHz, WGLS R9(H_convF)

f=1750 MHz, WGLS R22(H_convF)

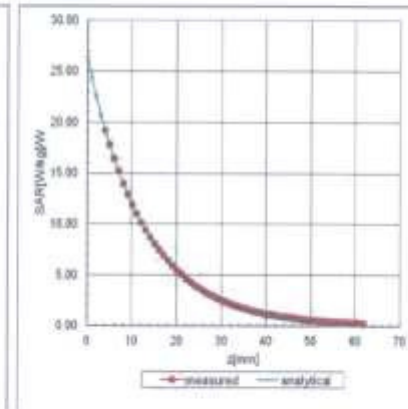
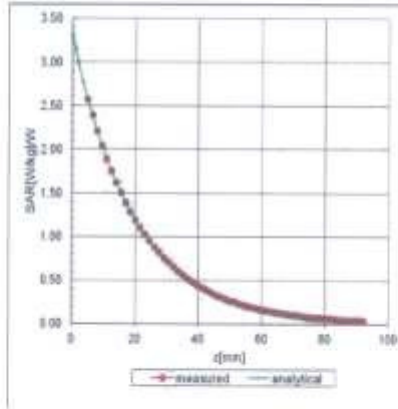

Deviation from Isotropy in Liquid

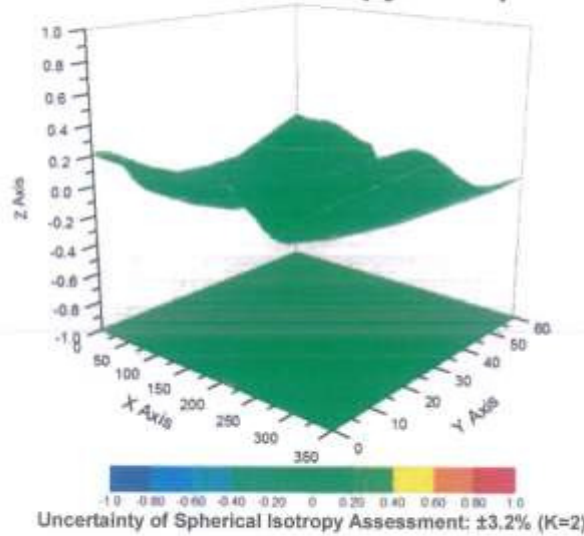



Add: No.51 Xueyuan Road, Haidian District, Beijing, 100191, China
Tel: +86-10-62304633-2218 Fax: +86-10-62304633-2209
E-mail: cnl@chinattl.com <http://www.chinattl.cn>

DASY/EASY – Parameters of Probe: ES3DV3 - SN: 3252

Other Probe Parameters

Sensor Arrangement	Triangular
Connector Angle (°)	130.2
Mechanical Surface Detection Mode	enabled
Optical Surface Detection Mode	disable
Probe Overall Length	337mm
Probe Body Diameter	10mm
Tip Length	10mm
Tip Diameter	4mm
Probe Tip to Sensor X Calibration Point	2mm
Probe Tip to Sensor Y Calibration Point	2mm
Probe Tip to Sensor Z Calibration Point	2mm
Recommended Measurement Distance from Surface	3mm

**Calibration Laboratory of
Schmid & Partner
Engineering AG**
Zeughausstrasse 43, 8004 Zurich, Switzerland



S Schweizerischer Kalibrierdienst
C Service suisse d'étalonnage
S Servizio svizzero di taratura
S Swiss Calibration Service

Accredited by the Swiss Accreditation Service (SAS)
The Swiss Accreditation Service is one of the signatories to the EA
Multilateral Agreement for the recognition of calibration certificates

Accreditation No.: **SCS 0108**

Client **Auden**

Certificate No: **EX3-7350_Dec17**

CALIBRATION CERTIFICATE

Object **EX3DV4 - SN:7350**

Calibration procedure(s) **QA CAL-01.v9, QA CAL-14.v4, QA CAL-23.v5, QA CAL-25.v6
Calibration procedure for dosimetric E-field probes**



Calibration date **December 21, 2017**

This calibration certificate documents the traceability to national standards, which realize the physical units of measurements (SI).
The measurements and the uncertainties with confidence probability are given on the following pages and are part of the certificate.

All calibrations have been conducted in the closed laboratory facility: environment temperature (22 ± 3)°C and humidity < 70%.

Calibration Equipment used (M&TE critical for calibration)

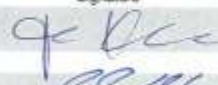
Primary Standards	ID	Cal Date (Certificate No.)	Scheduled Calibration
Power meter NRP	SN: 104778	04-Apr-17 (No. 217-02521/02522)	Apr-18
Power sensor NRP-Z91	SN: 103244	04-Apr-17 (No. 217-02521)	Apr-18
Power sensor NRP-Z91	SN: 103245	04-Apr-17 (No. 217-02526)	Apr-18
Reference 20 dB Attenuator	SN: 55277 (20x)	07-Apr-17 (No. 217-02528)	Apr-18
Reference Probe ES3DV2	SN: 3013	31-Dec-16 (No. ES3-3013_Dec16)	Dec-17
DAE4	SN: 654	24-Jul-17 (No. DAE4-654_Jul17)	Jul-18
Secondary Standards	ID	Check Date (in house)	Scheduled Check
Power meter E4419G	SN: GB41293874	06-Apr-16 (in house check Jun-16)	in house check: Jun-18
Power sensor E4412A	SN: MY41490087	06-Apr-16 (in house check Jun-16)	in house check: Jun-18
Power sensor E4412A	SN: 000110210	06-Apr-16 (in house check Jun-16)	in house check: Jun-18
RF generator HP 8648C	SN: US3642UD1700	04-Aug-99 (in house check Jun-16)	in house check: Jun-18
Network Analyzer HP 8753E	SN: US37390585	18-Oct-01 (in house check Oct-17)	in house check: Oct-18

	Name	Function	Signature
Calibrated by:	Jeton Kastres	Laboratory Technician	
Approved by:	Katja Pokovic	Technical Manager	

Issued: December 21, 2017

This calibration certificate shall not be reproduced except in full without written approval of the laboratory.

**Calibration Laboratory of
Schmid & Partner
Engineering AG**
Zeughausstrasse 43, 8004 Zurich, Switzerland



S Schweizerischer Kalibrierdienst
C Service suisse d'étalonnage
S Servizio svizzero di taratura
Swiss Calibration Service

Accredited by the Swiss Accreditation Service (SAS)
The Swiss Accreditation Service is one of the signatories to the EA
Multilateral Agreement for the recognition of calibration certificates

Accreditation No.: **SCS 0108**

Glossary:

TSL	tissue simulating liquid
NORM _{x,y,z}	sensitivity in free space
ConvF	sensitivity in TSL / NORM _{x,y,z}
DCP	diode compression point
CF	crest factor (1/duty_cycle) of the RF signal
A, B, C, D	modulation dependent linearization parameters
Polarization ϕ	ϕ rotation around probe axis
Polarization θ	θ rotation around an axis that is in the plane normal to probe axis (at measurement center), i.e., $\theta = 0$ is normal to probe axis
Connector Angle	information used in DASY system to align probe sensor X to the robot coordinate system

Calibration is Performed According to the Following Standards:

- IEEE Std 1528-2013, "IEEE Recommended Practice for Determining the Peak Spatial-Averaged Specific Absorption Rate (SAR) in the Human Head from Wireless Communications Devices: Measurement Techniques", June 2013
- IEC 62209-1, "Measurement procedure for the assessment of Specific Absorption Rate (SAR) from hand-held and body-mounted devices used next to the ear (frequency range of 300 MHz to 6 GHz)", July 2016
- IEC 62209-2, "Procedure to determine the Specific Absorption Rate (SAR) for wireless communication devices used in close proximity to the human body (frequency range of 30 MHz to 6 GHz)", March 2010
- KDB 865664, "SAR Measurement Requirements for 100 MHz to 6 GHz"

Methods Applied and Interpretation of Parameters:

- NORM_{x,y,z}: Assessed for E-field polarization $\theta = 0$ ($f \leq 900$ MHz in TEM-cell; $f > 1800$ MHz: R22 waveguide). NORM_{x,y,z} are only intermediate values, i.e., the uncertainties of NORM_{x,y,z} does not affect the E²-field uncertainty inside TSL (see below ConvF).
- NORM(f)_{x,y,z} = NORM_{x,y,z} * frequency_response (see Frequency Response Chart). This linearization is implemented in DASY4 software versions later than 4.2. The uncertainty of the frequency response is included in the stated uncertainty of ConvF.
- DCP_{x,y,z}: DCP are numerical linearization parameters assessed based on the data of power sweep with CW signal (no uncertainty required). DCP does not depend on frequency nor media.
- PAR: PAR is the Peak to Average Ratio that is not calibrated but determined based on the signal characteristics.
- A_{x,y,z}; B_{x,y,z}; C_{x,y,z}; D_{x,y,z}; VR_{x,y,z}: A, B, C, D are numerical linearization parameters assessed based on the data of power sweep for specific modulation signal. The parameters do not depend on frequency nor media. VR is the maximum calibration range expressed in RMS voltage across the diode.
- ConvF and Boundary Effect Parameters: Assessed in flat phantom using E-field (or Temperature Transfer Standard for $f \leq 800$ MHz) and inside waveguide using analytical field distributions based on power measurements for $f > 800$ MHz. The same setups are used for assessment of the parameters applied for boundary compensation (alpha, depth) of which typical uncertainty values are given. These parameters are used in DASY4 software to improve probe accuracy close to the boundary. The sensitivity in TSL corresponds to NORM_{x,y,z} * ConvF whereby the uncertainty corresponds to that given for ConvF. A frequency dependent ConvF is used in DASY version 4.4 and higher which allows extending the validity from ± 50 MHz to ± 100 MHz.
- Spherical isotropy (3D deviation from isotropy): in a field of low gradients realized using a flat phantom exposed by a patch antenna.
- Sensor Offset: The sensor offset corresponds to the offset of virtual measurement center from the probe tip (on probe axis). No tolerance required.
- Connector Angle: The angle is assessed using the information gained by determining the NORM_x (no uncertainty required).

EX3DV4 – SN:7350

December 21, 2017

Probe EX3DV4

SN:7350

Manufactured: October 13, 2014
Repaired: December 14, 2017
Calibrated: December 21, 2017

Calibrated for DASY/EASY Systems
(Note: non-compatible with DASY2 system!)

EX3DV4- SN-7350

December 21, 2017

DASY/EASY - Parameters of Probe: EX3DV4 - SN:7350

Basic Calibration Parameters

	Sensor X	Sensor Y	Sensor Z	Unc (k=2)
Norm ($\mu\text{V}/(\text{V}/\text{m})^2$) ^a	0.56	0.55	0.45	± 10.1 %
DCP (mV) ^b	96.5	98.6	99.5	

Modulation Calibration Parameters

UID	Communication System Name		A	B	C	D	VR	Unc ^c
			dB	dB√μV		dB	mV	(k=2)
0	CW	X	0.0	0.0	1.0	0.00	133.8	±3.5 %
		Y	0.0	0.0	1.0		130.0	
		Z	0.0	0.0	1.0		136.5	

The reported uncertainty of measurement is stated as the standard uncertainty of measurement multiplied by the coverage factor k=2, which for a normal distribution corresponds to a coverage probability of approximately 95%.

^a The uncertainties of Norm X,Y,Z do not affect the E²-field uncertainty inside TSL (see Pages 5 and 6).

^b Numerical linearization parameter: uncertainty not required.

^c Uncertainty is determined using the max. deviation from linear response applying rectangular distribution and is expressed for the square of the field value.

EX3DV4- SN:7350

December 21, 2017

DASY/EASY - Parameters of Probe: EX3DV4 - SN:7350

Calibration Parameter Determined in Head Tissue Simulating Media

f (MHz) ^c	Relative Permittivity ^e	Conductivity (S/m) ^f	ConvF X	ConvF Y	ConvF Z	Alpha ^g	Depth ^h (mm)	Unc (k=2)
750	41.9	0.89	10.29	10.29	10.29	0.50	0.80	± 12.0 %
835	41.5	0.90	9.87	9.87	9.87	0.52	0.80	± 12.0 %
900	41.5	0.97	9.70	9.70	9.70	0.53	0.80	± 12.0 %
1450	40.5	1.20	8.65	8.65	8.65	0.38	0.80	± 12.0 %
1750	40.1	1.37	8.52	8.52	8.52	0.38	0.80	± 12.0 %
1900	40.0	1.40	8.12	8.12	8.12	0.42	0.80	± 12.0 %
2100	39.8	1.49	8.47	8.47	8.47	0.36	0.80	± 12.0 %
2300	39.5	1.67	7.85	7.85	7.85	0.33	0.80	± 12.0 %
2450	39.2	1.80	7.53	7.53	7.53	0.34	0.83	± 12.0 %
2600	39.0	1.96	7.39	7.39	7.39	0.41	0.85	± 12.0 %
3500	37.9	2.91	7.06	7.06	7.06	0.32	1.20	± 13.1 %
5200	36.0	4.66	5.34	5.34	5.34	0.40	1.80	± 13.1 %
5300	35.9	4.76	5.15	5.15	5.15	0.40	1.80	± 13.1 %
5500	35.6	4.96	4.78	4.78	4.78	0.40	1.80	± 13.1 %
5600	35.5	5.07	4.68	4.68	4.68	0.40	1.80	± 13.1 %
5800	35.3	5.27	4.80	4.80	4.80	0.40	1.80	± 13.1 %

^c Frequency validity above 300 MHz of ± 100 MHz only applies for DASY v4.4 and higher (see Page 2), else it is restricted to ± 50 MHz. The uncertainty is the RSS of the ConvF uncertainty at calibration frequency and the uncertainty for the indicated frequency band. Frequency validity below 300 MHz is ± 10, 25, 40, 50 and 70 MHz for ConvF assessments at 30, 64, 128, 150 and 220 MHz respectively. Above 5 GHz frequency validity can be extended to ± 110 MHz.

^e At frequencies below 3 GHz, the validity of tissue parameters (ϵ and σ) can be relaxed to ± 10% if liquid compensation formula is applied to measured SAR values. At frequencies above 3 GHz, the validity of tissue parameters (ϵ and σ) is restricted to ± 5%. The uncertainty is the RSS of the ConvF uncertainty for indicated target tissue parameters.

^g Alpha/Depth are determined during calibration. SPEAG warrants that the remaining deviation due to the boundary effect after compensation is always less than ± 1% for frequencies below 3 GHz and below ± 2% for frequencies between 3-6 GHz at any distance larger than half the probe tip diameter from the boundary.

EX3DV4- SN:7350

December 21, 2017

DASY/EASY - Parameters of Probe: EX3DV4 - SN:7350

Calibration Parameter Determined in Body Tissue Simulating Media

f (MHz) ^c	Relative Permittivity ^f	Conductivity (S/m) ^f	ConvF X	ConvF Y	ConvF Z	Alpha ^g	Depth ^h (mm)	Unc (k=2)
750	55.5	0.96	10.46	10.46	10.46	0.58	0.83	± 12.0 %
835	55.2	0.97	10.15	10.15	10.15	0.48	0.88	± 12.0 %
900	55.0	1.05	10.11	10.11	10.11	0.49	0.85	± 12.0 %
1450	54.0	1.30	8.83	8.83	8.83	0.39	0.80	± 12.0 %
1750	53.4	1.49	8.45	8.45	8.45	0.38	0.88	± 12.0 %
1900	53.3	1.52	8.06	8.06	8.06	0.40	0.80	± 12.0 %
2100	53.2	1.62	8.40	8.40	8.40	0.44	0.85	± 12.0 %
2300	52.9	1.81	7.82	7.82	7.82	0.44	0.80	± 12.0 %
2450	52.7	1.95	7.70	7.70	7.70	0.46	0.85	± 12.0 %
2600	52.5	2.16	7.45	7.45	7.45	0.32	0.95	± 12.0 %
3500	51.3	3.31	6.87	6.87	6.87	0.30	1.25	± 13.1 %
5200	49.0	5.30	4.98	4.98	4.98	0.40	1.90	± 13.1 %
5300	48.9	5.42	4.78	4.78	4.78	0.40	1.90	± 13.1 %
5500	48.6	5.65	4.32	4.32	4.32	0.45	1.90	± 13.1 %
5600	48.5	5.77	4.13	4.13	4.13	0.45	1.90	± 13.1 %
5800	48.2	6.00	4.32	4.32	4.32	0.45	1.90	± 13.1 %

^c Frequency validity above 300 MHz of ± 100 MHz only applies for DASY v4.4 and higher (see Page 2), else it is restricted to ± 50 MHz. The uncertainty is the RSS of the ConvF uncertainty at calibration frequency and the uncertainty for the indicated frequency band. Frequency validity below 300 MHz is ± 10, 25, 40, 50 and 70 MHz for ConvF assessments at 30, 64, 128, 150 and 220 MHz respectively. Above 5 GHz frequency validity can be extended to ± 110 MHz.

^f At frequencies below 3 GHz, the validity of tissue parameters (ε and σ) can be relaxed to ± 10% if liquid compensation formula is applied to measured SAR values. At frequencies above 3 GHz, the validity of tissue parameters (ε and σ) is restricted to ± 5%. The uncertainty is the RSS of the ConvF uncertainty for indicated target tissue parameters.

^g Alpha/Depth are determined during calibration. SPEAG warrants that the remaining deviation due to the boundary effect after compensation is always less than ± 1% for frequencies below 3 GHz and below ± 2% for frequencies between 3-6 GHz at any distance larger than half the probe tip diameter from the boundary.

EX3DV4- SN:7350

December 21, 2017

Frequency Response of E-Field (TEM-Cell:ifi110 EXX, Waveguide: R22)

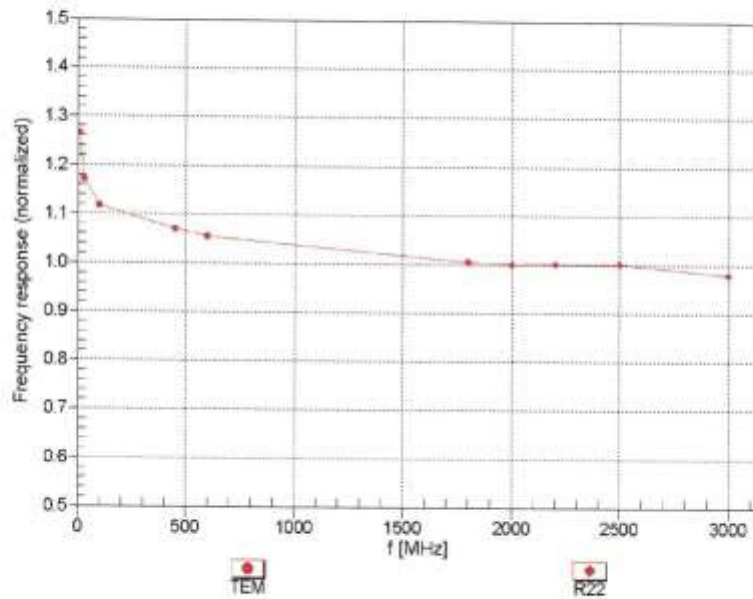
Uncertainty of Frequency Response of E-field: $\pm 6.3\%$ ($k=2$)

EX3DV4- SN:7350

December 21, 2017

Receiving Pattern (ϕ), $\theta = 0^\circ$

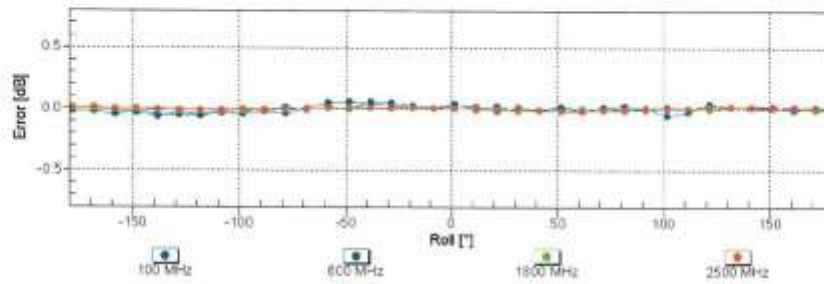
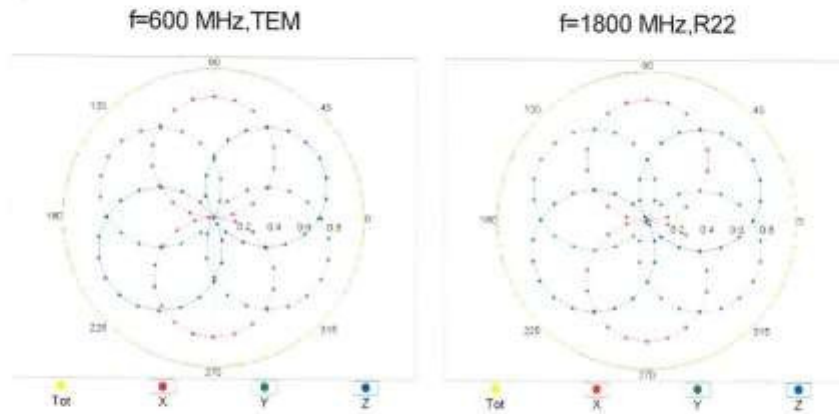

Uncertainty of Axial Isotropy Assessment: $\pm 0.5\%$ (k=2)

EX3DV4- SN:7350

December 21, 2017

Dynamic Range f(SAR_{head}) (TEM cell , f_{eval} = 1900 MHz)

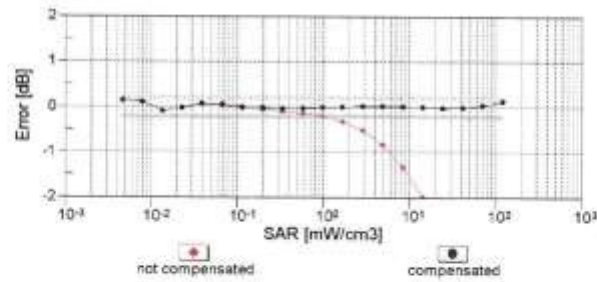
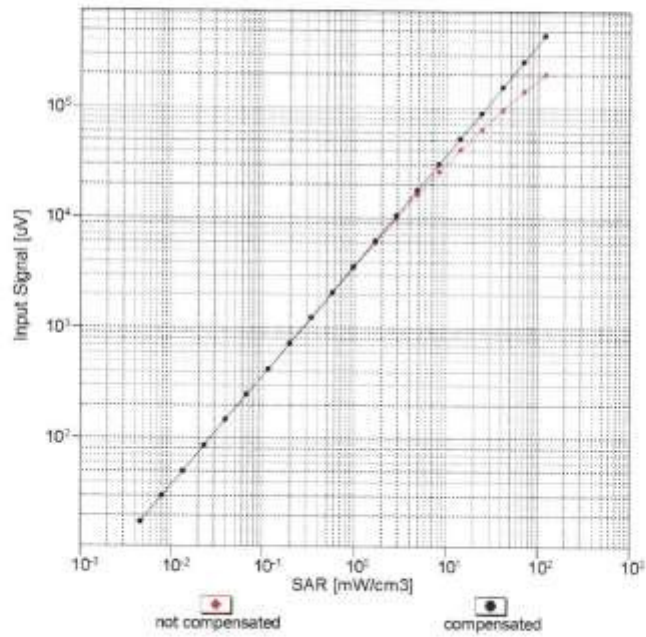

Uncertainty of Linearity Assessment: ± 0.6% (k=2)

EX3DV4- SN:7350

December 21, 2017

Conversion Factor Assessment

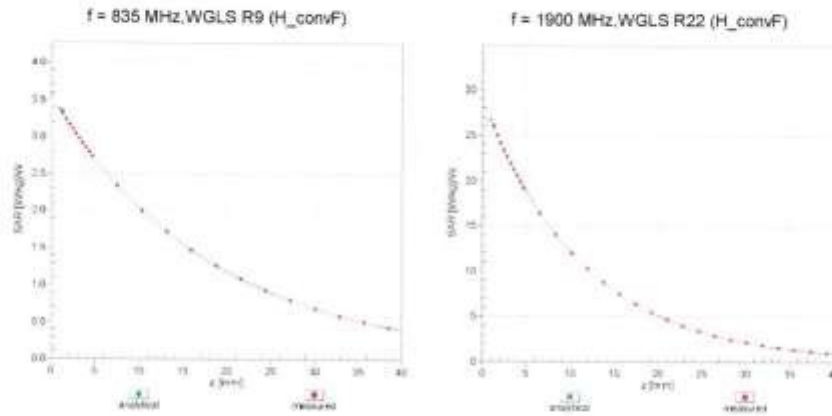

Deviation from Isotropy in Liquid
Error (ϕ , θ), f = 900 MHz

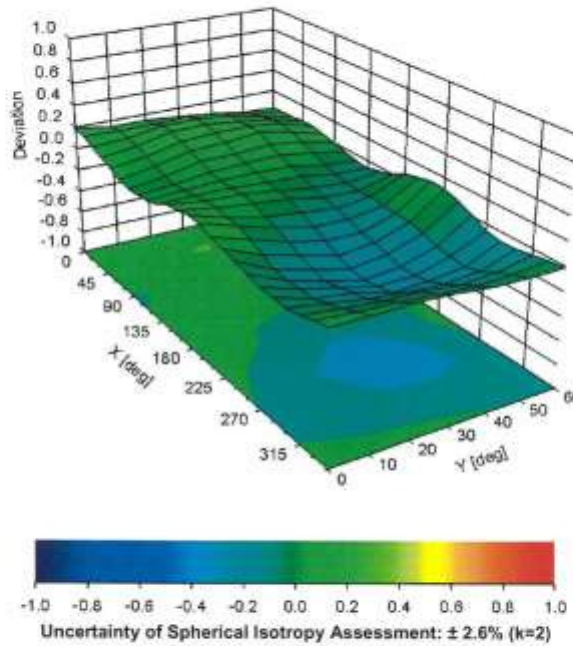

EX3DV4- SN:7350

December 21, 2017

DASY/EASY - Parameters of Probe: EX3DV4 - SN:7350**Other Probe Parameters**

Sensor Arrangement	Triangular
Connector Angle (°)	131.6
Mechanical Surface Detection Mode	enabled
Optical Surface Detection Mode	disabled
Probe Overall Length	337 mm
Probe Body Diameter	10 mm
Tip Length	9 mm
Tip Diameter	2.5 mm
Probe Tip to Sensor X Calibration Point	1 mm
Probe Tip to Sensor Y Calibration Point	1 mm
Probe Tip to Sensor Z Calibration Point	1 mm
Recommended Measurement Distance from Surface	1.4 mm

**Calibration Laboratory of
Schmid & Partner
Engineering AG**
Zeughausstrasse 43, 8004 Zurich, Switzerland



S Schweizerischer Kalibrierdienst
S Service suisse d'étalonnage
C Servizio svizzero di taratura
S Swiss Calibration Service

Accredited by the Swiss Accreditation Service (SAS)
The Swiss Accreditation Service is one of the signatories to the EA
Multilateral Agreement for the recognition of calibration certificates

Accreditation No.: **SCS 0108**

Client **TMC-SH (Auden)**

Certificate No: **D750V3-1144_Aug15**

CALIBRATION CERTIFICATE

Object **D750V3 - SN: 1144**

Calibration procedure(s) **QA CAL-05.v9
Calibration procedure for dipole validation kits above 700 MHz**

Calibration date: **August 03, 2015**

This calibration certificate documents the traceability to national standards, which realize the physical units of measurements (SI).
The measurements and the uncertainties with confidence probability are given on the following pages and are part of the certificate.

All calibrations have been conducted in the closed laboratory facility; environment temperature (22 ± 3)°C and humidity < 70%.

Calibration Equipment used (M&E critical for calibration)

Primary Standards	ID #	Cal Date (Certificate No.)	Scheduled Calibration
Power meter EPM-442A	GB37480704	07-Oct-14 (No. 217-02020)	Oct-15
Power sensor HP 8481A	US37292783	07-Oct-14 (No. 217-02020)	Oct-15
Power sensor HP 8481A	MY41092317	07-Oct-14 (No. 217-02021)	Oct-15
Reference 20 dB Attenuator	SN: 5058 (20k)	01-Apr-15 (No. 217-02131)	Mar-16
Type-N mismatch combination	SN: 5047.2 / 06327	01-Apr-15 (No. 217-02134)	Mar-16
Reference Probe ES3DV3	SN: 3205	30-Dec-14 (No. ES3-3205_Dec14)	Dec-15
DAE4	SN: 601	18-Aug-14 (No. DAE4-601_Aug14)	Aug-15
Secondary Standards	ID #	Check Date (In house)	Scheduled Check
RF generator R&S SMT-06	100005	04-Aug-99 (in house check Oct-13)	In house check; Oct-16
Network Analyzer HP 8753E	US37390585 S4206	18-Oct-01 (in house check Oct-14)	In house check; Oct-15

	Name	Function	Signature
Calibrated by:	Michael Weber	Laboratory Technician	
Approved by:	Katja Pokovic	Technical Manager	

Issued: August 5, 2015

This calibration certificate shall not be reproduced except in full without written approval of the laboratory.

Calibration Laboratory of
Schmid & Partner
Engineering AG
Zeughausstrasse 43, 8004 Zurich, Switzerland



S Schweizerischer Kalibrierdienst
C Service suisse d'étalonnage
S Servizio svizzero di taratura
S Swiss Calibration Service

Accredited by the Swiss Accreditation Service (SAS)
The Swiss Accreditation Service is one of the signatories to the EA
Multilateral Agreement for the recognition of calibration certificates

Accreditation No.: **SCS 0108**

Glossary:

TSL	tissue simulating liquid
ConvF	sensitivity in TSL / NORM x,y,z
N/A	not applicable or not measured

Calibration is Performed According to the Following Standards:

- IEEE Std 1528-2013, "IEEE Recommended Practice for Determining the Peak Spatial-Averaged Specific Absorption Rate (SAR) in the Human Head from Wireless Communications Devices: Measurement Techniques", June 2013
- IEC 62209-1, "Procedure to measure the Specific Absorption Rate (SAR) for hand-held devices used in close proximity to the ear (frequency range of 300 MHz to 3 GHz)", February 2005
- IEC 62209-2, "Procedure to determine the Specific Absorption Rate (SAR) for wireless communication devices used in close proximity to the human body (frequency range of 30 MHz to 6 GHz)", March 2010
- KDB 865664, "SAR Measurement Requirements for 100 MHz to 6 GHz"

Additional Documentation:

- DASY4/5 System Handbook

Methods Applied and Interpretation of Parameters:

- Measurement Conditions:** Further details are available from the Validation Report at the end of the certificate. All figures stated in the certificate are valid at the frequency indicated.
- Antenna Parameters with TSL:** The dipole is mounted with the spacer to position its feed point exactly below the center marking of the flat phantom section, with the arms oriented parallel to the body axis.
- Feed Point Impedance and Return Loss:** These parameters are measured with the dipole positioned under the liquid filled phantom. The impedance stated is transformed from the measurement at the SMA connector to the feed point. The Return Loss ensures low reflected power. No uncertainty required.
- Electrical Delay:** One-way delay between the SMA connector and the antenna feed point. No uncertainty required.
- SAR measured:** SAR measured at the stated antenna input power.
- SAR normalized:** SAR as measured, normalized to an input power of 1 W at the antenna connector.
- SAR for nominal TSL parameters:** The measured TSL parameters are used to calculate the nominal SAR result.

The reported uncertainty of measurement is stated as the standard uncertainty of measurement multiplied by the coverage factor $k=2$, which for a normal distribution corresponds to a coverage probability of approximately 95%.

Measurement Conditions

DASY system configuration, as far as not given on page 1.

DASY Version	DASY5	V52.8.8
Extrapolation	Advanced Extrapolation	
Phantom	Modular Flat Phantom	
Distance Dipole Center - TSL	15 mm	with Spacer
Zoom Scan Resolution	dx, dy, dz = 5 mm	
Frequency	750 MHz ± 1 MHz	

Head TSL parameters

The following parameters and calculations were applied.

	Temperature	Permittivity	Conductivity
Nominal Head TSL parameters	22.0 °C	41.9	0.89 mho/m
Measured Head TSL parameters	(22.0 ± 0.2) °C	42.1 ± 6 %	0.91 mho/m ± 6 %
Head TSL temperature change during test	< 0.5 °C	---	---

SAR result with Head TSL

SAR averaged over 1 cm ³ (1 g) of Head TSL	Condition	
SAR measured	250 mW input power	2.05 W/kg
SAR for nominal Head TSL parameters	normalized to 1W	8.07 W/kg ± 17.0 % (k=2)

SAR averaged over 10 cm ³ (10 g) of Head TSL	condition	
SAR measured	250 mW input power	1.34 W/kg
SAR for nominal Head TSL parameters	normalized to 1W	5.29 W/kg ± 16.5 % (k=2)

Body TSL parameters

The following parameters and calculations were applied.

	Temperature	Permittivity	Conductivity
Nominal Body TSL parameters	22.0 °C	55.5	0.96 mho/m
Measured Body TSL parameters	(22.0 ± 0.2) °C	56.3 ± 6 %	1.00 mho/m ± 6 %
Body TSL temperature change during test	< 0.5 °C	---	---

SAR result with Body TSL

SAR averaged over 1 cm ³ (1 g) of Body TSL	Condition	
SAR measured	250 mW input power	2.21 W/kg
SAR for nominal Body TSL parameters	normalized to 1W	8.60 W/kg ± 17.0 % (k=2)

SAR averaged over 10 cm ³ (10 g) of Body TSL	condition	
SAR measured	250 mW input power	1.46 W/kg
SAR for nominal Body TSL parameters	normalized to 1W	5.71 W/kg ± 16.5 % (k=2)

Appendix (Additional assessments outside the scope of SCS 0108)**Antenna Parameters with Head TSL**

Impedance, transformed to feed point	54.4 Ω - 1.5 $\mu\Omega$
Return Loss	- 27.0 dB

Antenna Parameters with Body TSL

Impedance, transformed to feed point	49.9 Ω - 3.3 $\mu\Omega$
Return Loss	- 29.5 dB

General Antenna Parameters and Design

Electrical Delay (one direction)	1.032 ns
----------------------------------	----------

After long term use with 100W radiated power, only a slight warming of the dipole near the feedpoint can be measured.

The dipole is made of standard semirigid coaxial cable. The center conductor of the feeding line is directly connected to the second arm of the dipole. The antenna is therefore short-circuited for DC-signals. On some of the dipoles, small end caps are added to the dipole arms in order to improve matching when loaded according to the position as explained in the "Measurement Conditions" paragraph. The SAR data are not affected by this change. The overall dipole length is still according to the Standard.

No excessive force must be applied to the dipole arms, because they might bend or the soldered connections near the feedpoint may be damaged.

Additional EUT Data

Manufactured by	SPEAG
Manufactured on	January 28, 2015

DASY5 Validation Report for Head TSL

Date: 03.08.2015

Test Laboratory: SPEAG, Zurich, Switzerland

DUT: Dipole 750 MHz; Type: D750V3; Serial: D750V3 - SN: 1144

Communication System: UID 0 - CW; Frequency: 750 MHz

Medium parameters used: $f = 750$ MHz; $\sigma = 0.91$ S/m; $\epsilon_r = 42.1$; $\rho = 1000$ kg/m³

Phantom section: Flat Section

Measurement Standard: DASY5 (IEEE/IEC/ANSI C63.19-2011)

DASY52 Configuration:

- Probe: ES3DV3 - SN3205; ConvF(6.44, 6.44, 6.44); Calibrated: 30.12.2014;
- Sensor-Surface: 3mm (Mechanical Surface Detection)
- Electronics: DAE4 Sn601; Calibrated: 18.08.2014
- Phantom: Flat Phantom 4.9L; Type: QD000P49AA; Serial: 1001
- DASY52 52.8.8(1222); SEMCAD X 14.6.10(7331)

Dipole Calibration for Head Tissue/Pin=250 mW, d=15mm/Zoom Scan (7x7x7)/Cube 0:

Measurement grid: dx=5mm, dy=5mm, dz=5mm

Reference Value = 52.93 V/m; Power Drift = 0.01 dB

Peak SAR (extrapolated) = 3.05 W/kg

SAR(1 g) = 2.05 W/kg; SAR(10 g) = 1.34 W/kg

Maximum value of SAR (measured) = 2.40 W/kg

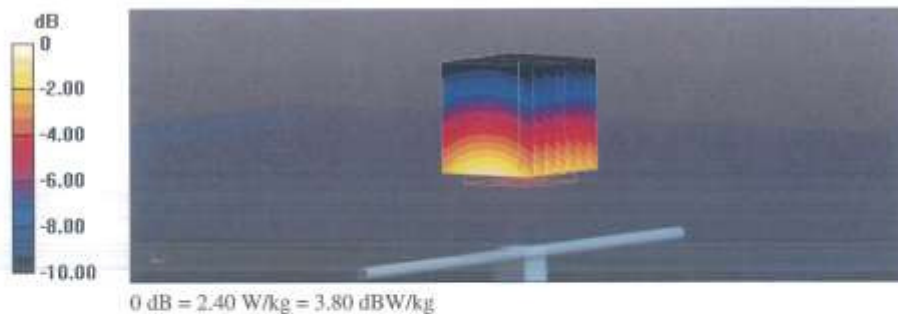

Impedance Measurement Plot for Head TSL

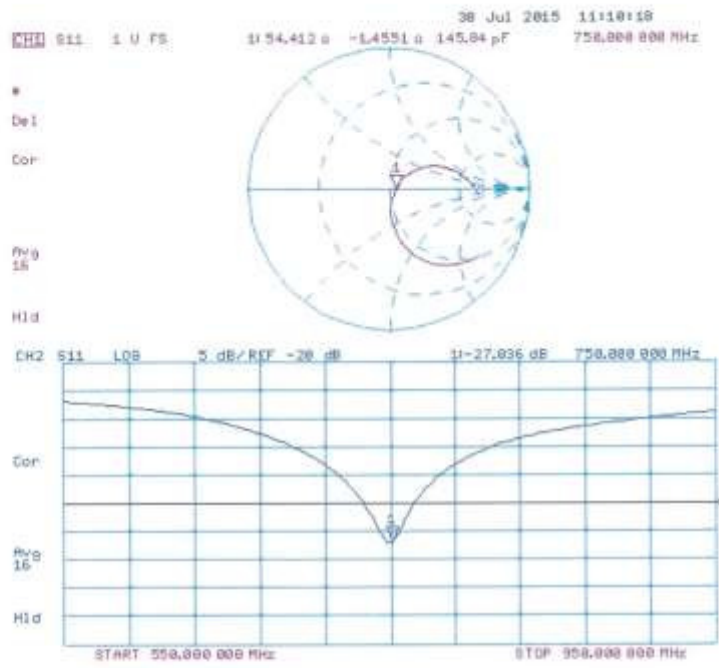

DASY5 Validation Report for Body TSL

Date: 03.08.2015

Test Laboratory: SPEAG, Zurich, Switzerland

DUT: Dipole 750 MHz; Type: D750V3; Serial: D750V3 - SN: 1144

Communication System: UID 0 - CW; Frequency: 750 MHz

Medium parameters used: $f = 750$ MHz; $\sigma = 1$ S/m; $\epsilon_r = 56.3$; $\rho = 1000$ kg/m³

Phantom section: Flat Section

Measurement Standard: DASY5 (IEEE/IEC/ANSI C63.19-2011)

DASY52 Configuration:

- Probe: ES3DV3 - SN3205; ConvF(6.21, 6.21, 6.21); Calibrated: 30.12.2014;
- Sensor-Surface: 3mm (Mechanical Surface Detection)
- Electronics: DAE4 Sn601; Calibrated: 18.08.2014
- Phantom: Flat Phantom 4.9L; Type: QD000P49AA; Serial: 1001
- DASY52 52.8(1222); SEMCAD X 14.6.10(7331)

Dipole Calibration for Body Tissue/Pin=250 mW, d=15mm/Zoom Scan (7x7x7)/Cube 0:

Measurement grid: dx=5mm, dy=5mm, dz=5mm

Reference Value = 52.55 V/m; Power Drift = -0.01 dB

Peak SAR (extrapolated) = 3.22 W/kg

SAR(1 g) = 2.21 W/kg; SAR(10 g) = 1.46 W/kg

Maximum value of SAR (measured) = 2.57 W/kg

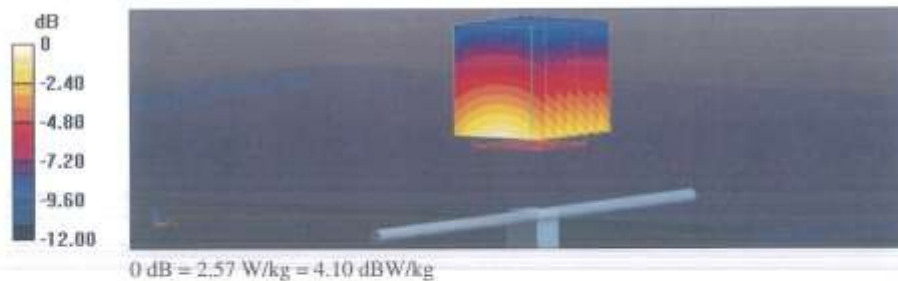

Impedance Measurement Plot for Body TSL

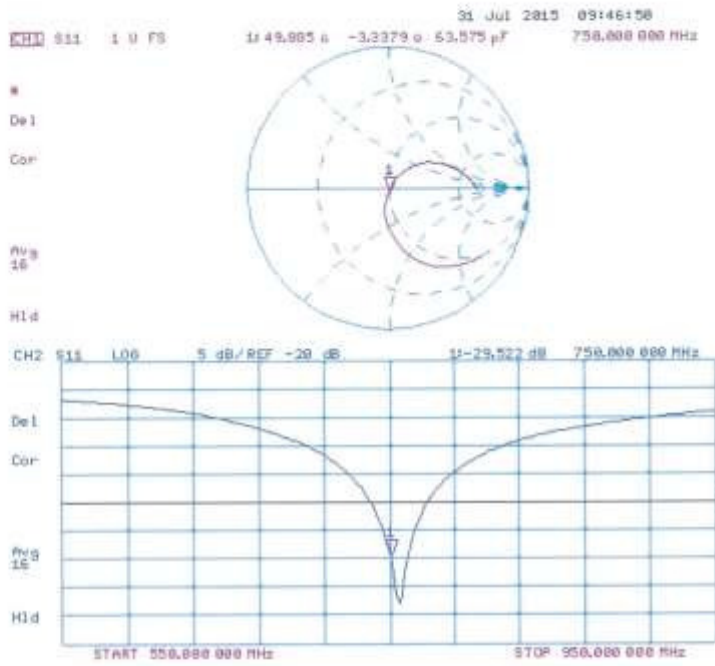

D750V3,Serial No.1144Extended Dipole Calibrations

Per IEEE Std 1528-2013,the dipole should have a return loss better than -20dB at the test frequency to reduce uncertainty in the power measurement.

Per KDB 865664 D01 ,if dipoles are verified in return loss(<-20dB,within 20% of prior calibration),and in impedance (within 5 ohm of prior calibration),the annual calibration is not necessary and the calibration interval can be extended.

Justification of the extended calibration

D750V3 Serial No.1144						
750 Head						
Date of Measurement	Return-Loss (dB)	Delta (%)	Real Impedance (ohm)	Delta (ohm)	Imaginary Impedance (ohm)	Delta (ohm)
08.03.2015	-27.036	--	54.412	--	-1.455	--
08.02.2016	-25.01	7.49	55.936	1.524	0.386	1.841

D750V3 Serial No.1144						
750 Body						
Date of Measurement	Return-Loss (dB)	Delta (%)	Real Impedance (ohm)	Delta (ohm)	Imaginary Impedance (ohm)	Delta (ohm)
08.03.2015	-29.522	--	49.885	--	-3.338	--
08.02.2016	-29.116	1.38	49.671	0.214	-3.456	0.118

The return loss is < -20dB, within 20% of prior calibration; the impedance is within 5 ohm of prior calibration. Therefore the verification result should support extended calibration.

Dipole Verification Data D750V3 Serial No.1144 750MHz-Head

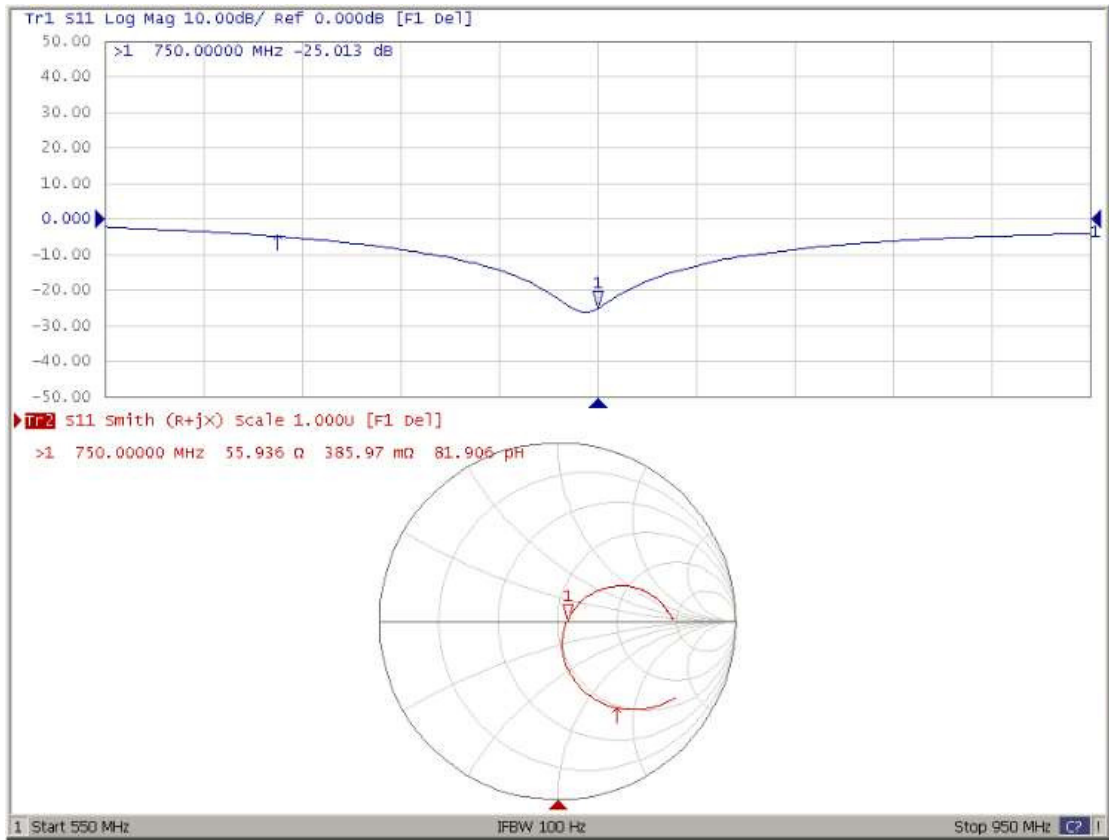

750MHz – Body

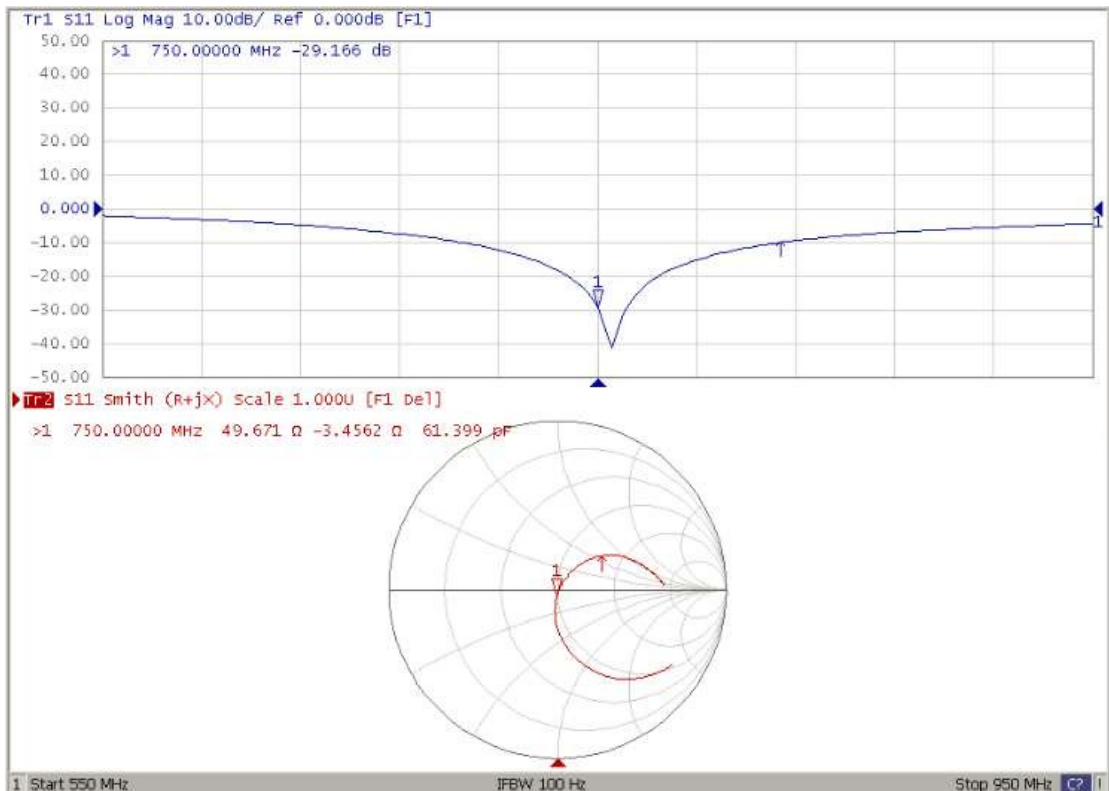

D750V3,Serial No.1144Extended Dipole Calibrations

Per IEEE Std 1528-2013,the dipole should have a return loss better than -20dB at the test frequency to reduce uncertainty in the power measurement.

Per KDB 865664 D01 ,if dipoles are verified in return loss(<-20dB,within 20% of prior calibration),and in impedance (within 5 ohm of prior calibration),the annual calibration is not necessary and the calibration interval can be extended.

Justification of the extended calibration

D750V3 Serial No.1144						
750 Head						
Date of Measurement	Return-Loss (dB)	Delta (%)	Real Impedance (ohm)	Delta (ohm)	Imaginary Impedance (ohm)	Delta (ohm)
08.03.2015	-27.036	--	54.412	--	-1.455	--
08.02.2016	-25.01	7.49	55.936	1.524	0.386	1.841
08.02.2017	-25.662	2.61	55.125	0.811	-1.936	2.322

D750V3 Serial No.1144						
750 Body						
Date of Measurement	Return-Loss (dB)	Delta (%)	Real Impedance (ohm)	Delta (ohm)	Imaginary Impedance (ohm)	Delta (ohm)
08.03.2015	-29.522	--	49.885	--	-3.338	--
08.02.2016	-29.116	1.38	49.671	0.214	-3.456	0.118
08.02.2017	-30.474	4.66	49.189	0.482	-2.859	0.597

The return loss is < -20dB, within 20% of prior calibration; the impedance is within 5 ohm of prior calibration. Therefore the verification result should support extended calibration.

Dipole Verification Data D750V3 Serial No.1144 750MHz-Head

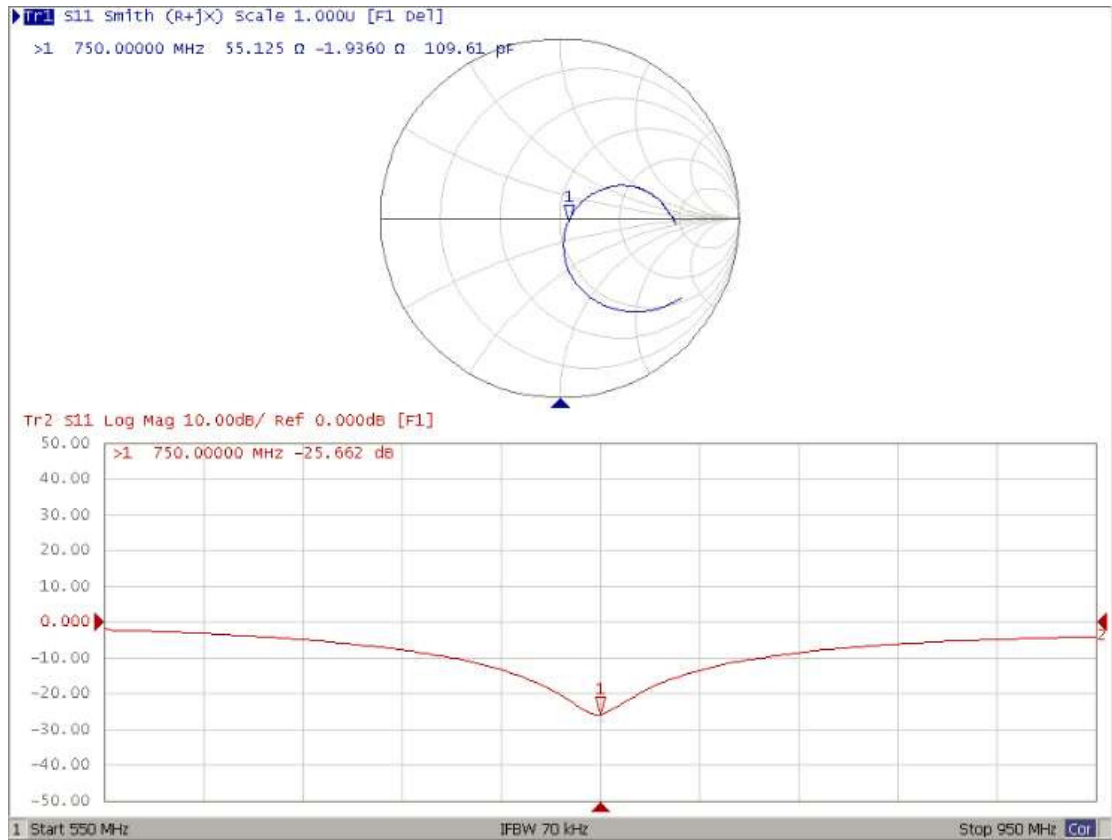

750MHz – Body

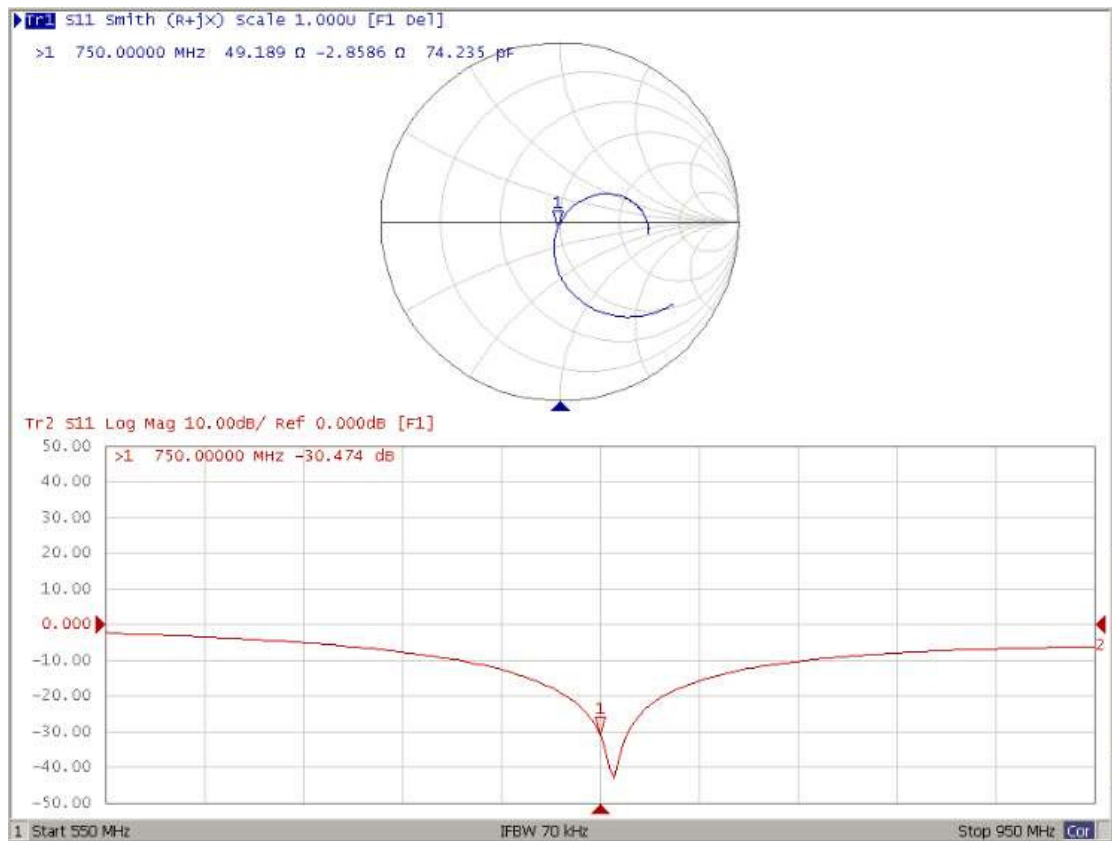



Add: No.51 Xuyuan Road, Haidian District, Beijing, 100191, China
 Tel: +86-10-62304633-2079 Fax: +86-10-62304633-2504
 E-mail: ctt@chinattl.com <http://www.chinattl.cn>



Client: **ECIT** Certificate No.: **Z15-97165**

CALIBRATION CERTIFICATE

Object: **D835V2 - SN: 4d112**

Calibration Procedure(s): **FD-Z11-2-003-01**
Calibration Procedures for dipole validation kits

Calibration date: **October 22, 2015**

This calibration Certificate documents the traceability to national standards, which realize the physical units of measurements(SI). The measurements and the uncertainties with confidence probability are given on the following pages and are part of the certificate.

All calibrations have been conducted in the closed laboratory facility: environment temperature(22±3)°C and humidity<70%.

Calibration Equipment used (M&TE critical for calibration)

Primary Standards	ID #	Cal Date(Calibrated by, Certificate No.)	Scheduled Calibration
Power Meter NRP2	101919	01-Jul-15 (CTTL, No.J15X04256)	Jun-16
Power sensor NRP-Z91	101547	01-Jul-15 (CTTL, No.J15X04256)	Jun-16
Reference Probe EX3DV4	SN 3617	26-Aug-15(SPEAG,No.EX3-3617_Aug15)	Aug -16
DAE4	SN 777	26-Aug-15(SPEAG,No.DAE4-777_Aug15)	Aug -16
Secondary Standards	ID #	Cal Date(Calibrated by, Certificate No.)	Scheduled Calibration
Signal Generator E4438C	MY49071430	02-Feb-15 (CTTL, No.J15X00729)	Feb-16
Network Analyzer E5071C	MY46110673	03-Feb-15 (CTTL, No.J15X00728)	Feb-16

	Name	Function	Signature
Calibrated by:	Zhao Jing	SAR Test Engineer	
Reviewed by:	Qi Dianyuan	SAR Project Leader	
Approved by:	Lu Bingsong	Deputy Director of the laboratory	

Issued: October 26, 2015

This calibration certificate shall not be reproduced except in full without written approval of the laboratory.



Add: No.51 Xueyuan Road, Haidian District, Beijing, 100191, China
Tel: +86-10-62304633-2079 Fax: +86-10-62304633-2504
E-mail: cntl@chinattl.com Http://www.chinattl.cn

Glossary:

TSL	tissue simulating liquid
ConvF	sensitivity in TSL / NORM _{x,y,z}
N/A	not applicable or not measured

Calibration is Performed According to the Following Standards:

- IEEE Std 1528-2013, "IEEE Recommended Practice for Determining the Peak Spatial-Averaged Specific Absorption Rate (SAR) in the Human Head from Wireless Communications Devices: Measurement Techniques", June 2013
- IEC 62209-1, "Procedure to measure the Specific Absorption Rate (SAR) For hand-held devices used in close proximity to the ear (frequency range of 300MHz to 3GHz)", February 2005
- KDB865664, SAR Measurement Requirements for 100 MHz to 6 GHz

Additional Documentation:

- DASY4/5 System Handbook

Methods Applied and Interpretation of Parameters:

- Measurement Conditions:** Further details are available from the Validation Report at the end of the certificate. All figures stated in the certificate are valid at the frequency indicated.
- Antenna Parameters with TSL:** The dipole is mounted with the spacer to position its feed point exactly below the center marking of the flat phantom section, with the arms oriented parallel to the body axis.
- Feed Point Impedance and Return Loss:** These parameters are measured with the dipole positioned under the liquid filled phantom. The impedance stated is transformed from the measurement at the SMA connector to the feed point. The Return Loss ensures low reflected power. No uncertainty required.
- Electrical Delay:** One-way delay between the SMA connector and the antenna feed point. No uncertainty required.
- SAR measured:** SAR measured at the stated antenna input power.
- SAR normalized:** SAR as measured, normalized to an input power of 1 W at the antenna connector.
- SAR for nominal TSL parameters:** The measured TSL parameters are used to calculate the nominal SAR result.

The reported uncertainty of measurement is stated as the standard uncertainty of Measurement multiplied by the coverage factor $k=2$, which for a normal distribution corresponds to a coverage probability of approximately 95%.



Add: No.51 Xueyuan Road, Haidian District, Beijing, 100191, China
 Tel: +86-10-62304633-2079 Fax: +86-10-62304633-2504
 E-mail: ttl@chinatl.com Http://www.chinatl.cn

Measurement Conditions

DASY system configuration, as far as not given on page 1.

DASY Version	DASY52	52.8.8.1222
Extrapolation	Advanced Extrapolation	
Phantom	Triple Flat Phantom 5.1C	
Distance Dipole Center - TSL	15 mm	with Spacer
Zoom Scan Resolution	dx, dy, dz = 5 mm	
Frequency	835 MHz ± 1 MHz	

Head TSL parameters

The following parameters and calculations were applied.

	Temperature	Permittivity	Conductivity
Nominal Head TSL parameters	22.0 °C	41.5	0.90 mho/m
Measured Head TSL parameters	(22.0 ± 0.2) °C	42.2 ± 6 %	0.91 mho/m ± 6 %
Head TSL temperature change during test	<1.0 °C	—	—

SAR result with Head TSL

SAR averaged over 1 cm^3 (1 g) of Head TSL	Condition	
SAR measured	250 mW input power	2.31 mW / g
SAR for nominal Head TSL parameters	normalized to 1W	9.22 mW / g ± 20.8 % (k=2)
SAR averaged over 10 cm^3 (10 g) of Head TSL	Condition	
SAR measured	250 mW input power	1.51 mW / g
SAR for nominal Head TSL parameters	normalized to 1W	6.03 mW / g ± 20.4 % (k=2)

Body TSL parameters

The following parameters and calculations were applied.

	Temperature	Permittivity	Conductivity
Nominal Body TSL parameters	22.0 °C	55.2	0.97 mho/m
Measured Body TSL parameters	(22.0 ± 0.2) °C	55.1 ± 6 %	0.96 mho/m ± 6 %
Body TSL temperature change during test	<1.0 °C	—	—

SAR result with Body TSL

SAR averaged over 1 cm^3 (1 g) of Body TSL	Condition	
SAR measured	250 mW input power	2.37 mW / g
SAR for nominal Body TSL parameters	normalized to 1W	9.57 mW / g ± 20.8 % (k=2)
SAR averaged over 10 cm^3 (10 g) of Body TSL	Condition	
SAR measured	250 mW input power	1.56 mW / g
SAR for nominal Body TSL parameters	normalized to 1W	6.29 mW / g ± 20.4 % (k=2)



Add: No.51 Xueyuan Road, Haidian District, Beijing, 100191, China
 Tel: +86-10-62304633-2079 Fax: +86-10-62304633-2504
 E-mail: ctt@chinattl.com Http://www.chinattl.cn

Appendix

Antenna Parameters with Head TSL

Impedance, transformed to feed point	49.1Ω- 4.20jΩ
Return Loss	- 27.3dB

Antenna Parameters with Body TSL

Impedance, transformed to feed point	46.2Ω- 4.79jΩ
Return Loss	- 23.9dB

General Antenna Parameters and Design

Electrical Delay (one direction)	1.502 ns
----------------------------------	----------

After long term use with 100W radiated power, only a slight warming of the dipole near the feedpoint can be measured.

The dipole is made of standard semirigid coaxial cable. The center conductor of the feeding line is directly connected to the second arm of the dipole. The antenna is therefore short-circuited for DC-signals. On some of the dipoles, small end caps are added to the dipole arms in order to improve matching when loaded according to the position as explained in the "Measurement Conditions" paragraph. The SAR data are not affected by this change. The overall dipole length is still according to the Standard. No excessive force must be applied to the dipole arms, because they might bend or the soldered connections near the feedpoint may be damaged.

Additional EUT Data

Manufactured by	SPEAG
-----------------	-------



Add: No.51 Xixiyuan Road, Haidian District, Beijing, 100191, China
 Tel: +86-10-62304633-2079 Fax: +86-10-62304633-2504
 E-mail: ctd@chinantl.com Http://www.chinantl.cn

DASY5 Validation Report for Head TSL

Date: 10.22.2015

Test Laboratory: CTTL, Beijing, China

DUT: Dipole 835 MHz; Type: D835V2; Serial: D835V2 - SN: 4d112

Communication System: UID 0, CW; Frequency: 835 MHz; Duty Cycle: 1:1

Medium parameters used: $f = 835 \text{ MHz}$; $\sigma = 0.907 \text{ S/m}$; $\epsilon_r = 42.15$; $\rho = 1000 \text{ kg/m}^3$

Phantom section: Center Section

Measurement Standard: DASY5 (IEEE/IEC/ANSI C63.19-2007)

DASY5 Configuration:

- Probe: EX3DV4 - SN3617; ConvF(9.56, 9.56, 9.56); Calibrated: 8/26/2015;
- Sensor-Surface: 2mm (Mechanical Surface Detection)
- Electronics: DAE4 Sn777; Calibrated: 8/26/2015
- Phantom: Triple Flat Phantom 5.1C; Type: QD 000 P51 CA; Serial: 1161/1
- Measurement SW: DASY52, Version 52.8 (8); SEMCAD X Version 14.6.10 (7331)

Dipole Calibration/Zoom Scan (7x7x7) (7x7x7)/Cube 0: Measurement grid: $dx=5\text{mm}$, $dy=5\text{mm}$, $dz=5\text{mm}$

Reference Value = 58.15 V/m; Power Drift = -0.02 dB

Peak SAR (extrapolated) = 3.46 W/kg

SAR(1 g) = 2.31 W/kg; SAR(10 g) = 1.51 W/kg

Maximum value of SAR (measured) = 2.93 W/kg

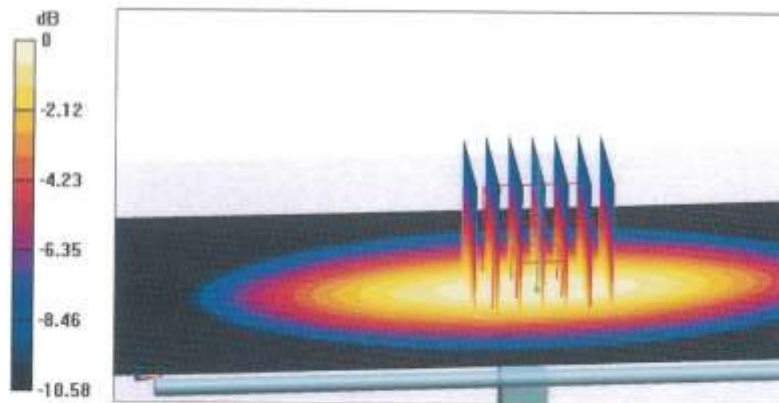

0 dB = 2.93 W/kg = 4.67 dBW/kg

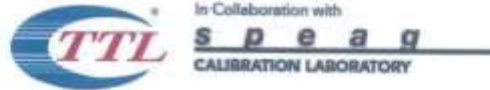

Add: No.51 Xueyuan Road, Haidian District, Beijing, 100191, China
Tel: +86-10-62304633-2079 Fax: +86-10-62304633-2504
E-mail: entl@chinattl.com Http://www.chinattl.cn

Impedance Measurement Plot for Head TSL

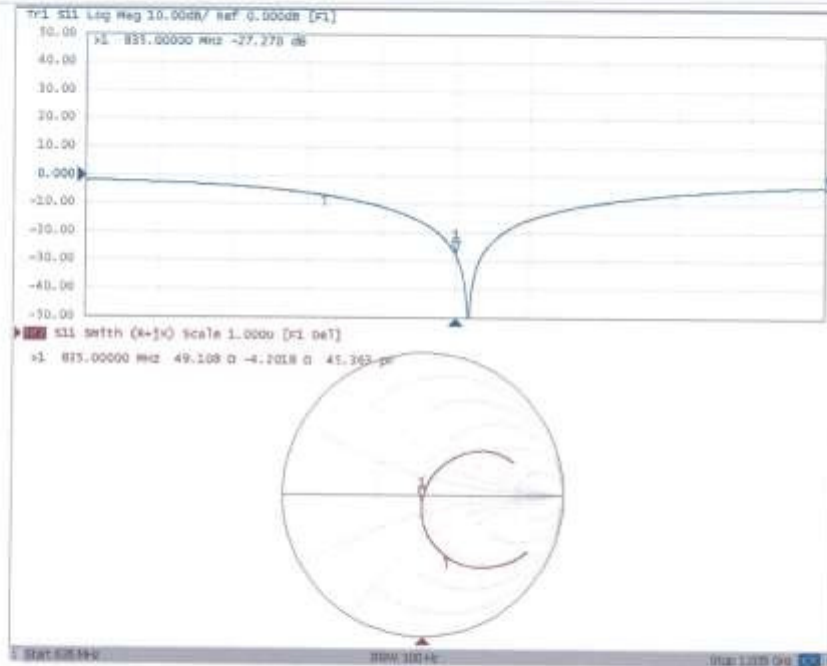



Add: No.51 Xueyuan Road, Haidian District, Beijing, 100191, China
Tel: +86-10-62304633-2079 Fax: +86-10-62304633-2504
E-mail: ctt@chinattl.com Http://www.chinattl.cn

DASY5 Validation Report for Body TSL

Date: 10.22.2015

Test Laboratory: CTTL, Beijing, China

DUT: Dipole 835 MHz; Type: D835V2; Serial: D835V2 - SN: 4d112

Communication System: UID 0, CW; Frequency: 835 MHz; Duty Cycle: 1:1

Medium parameters used: $f = 835$ MHz; $\sigma = 0.958$ S/m; $\epsilon_r = 55.11$; $\rho = 1000$ kg/m³

Phantom section: Right Section

Measurement Standard: DASY5 (IEEE/IEC/ANSI C63.19-2007)

DASY5 Configuration:

- Probe: EX3DV4 - SN3617; ConvF(9.71,9.71, 9.71); Calibrated: 8/26/2015;
- Sensor-Surface: 2mm (Mechanical Surface Detection)
- Electronics: DAE4 Sn777; Calibrated: 8/26/2015
- Phantom: Triple Flat Phantom 5.1C; Type: QD 000 P51 CA; Serial: 1161/1
- Measurement SW: DASY52, Version 52.8 (8); SEMCAD X Version 14.6.10 (7331)

Dipole Calibration/Zoom Scan (7x7x7) (7x7x7)/Cube 0: Measurement grid: dx=5mm, dy=5mm, dz=5mm

Reference Value = 56.68 V/m; Power Drift = 0.01 dB

Peak SAR (extrapolated) = 3.51 W/kg

SAR(1 g) = 2.37 W/kg; SAR(10 g) = 1.56 W/kg

Maximum value of SAR (measured) = 2.99 W/kg

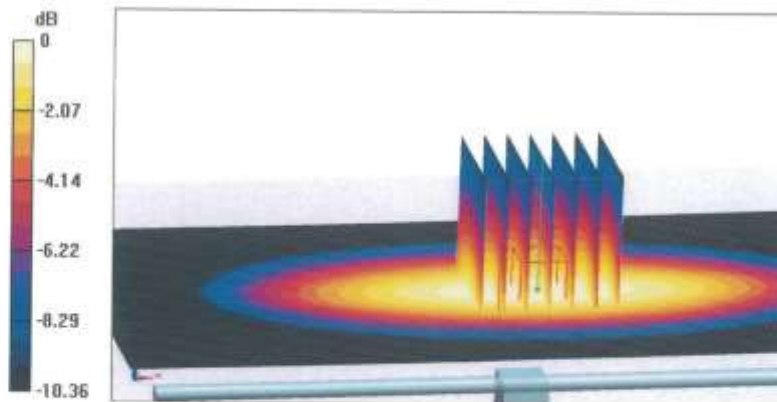

0 dB = 2.99 W/kg = 4.76 dBW/kg



Add: No 51 Xueyuan Road, Haidian District, Beijing, 100191, China
Tel: +86-10-62304633-2079 Fax: +86-10-62304633-2304
E-mail: ctd@chinattl.com Http://www.chinattl.cn

Impedance Measurement Plot for Body TSL

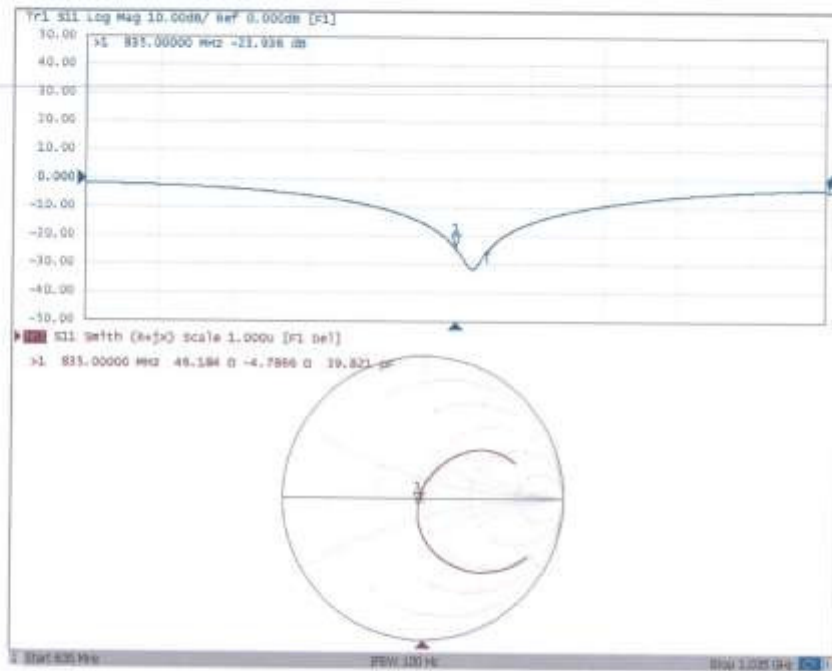

D835V2,Serial No.4d112 Extended Dipole Calibrations

Per IEEE Std 1528-2013,the dipole should have a return loss better than -20dB at the test frequency to reduce uncertainty in the power measurement.

Per KDB 865664 D01 ,if dipoles are verified in return loss(<-20dB,within 20% of prior calibration),and in impedance (within 5 ohm of prior calibration),the annual calibration is not necessary and the calibration interval can be extended.

Justification of the extended calibration

D835V2 Serial No.4d112						
835 Head						
Date of Measurement	Return-Loss (dB)	Delta (%)	Real Impedance (ohm)	Delta (ohm)	Imaginary Impedance (ohm)	Delta (ohm)
10.22.2015	-27.27	--	49.108	--	-4.2018	--
10.21.2016	-29.019	6.41	50.108	1	-2.1757	2.0261

D835V2 Serial No.4d112						
835 Body						
Date of Measurement	Return-Loss (dB)	Delta (%)	Real Impedance (ohm)	Delta (ohm)	Imaginary Impedance (ohm)	Delta (ohm)
10.22.2015	-23.036	--	46.184	--	-4.7866	--
10.21.2016	-23.131	0.56	47.003	0.819	-2.9072	1.8794

The return loss is < -20dB, within 20% of prior calibration; the impedance is within 5 ohm of prior calibration. Therefore the verification result should support extended calibration.

Dipole Verification Data D835V2 Serial No.4d112 835MHz-Head

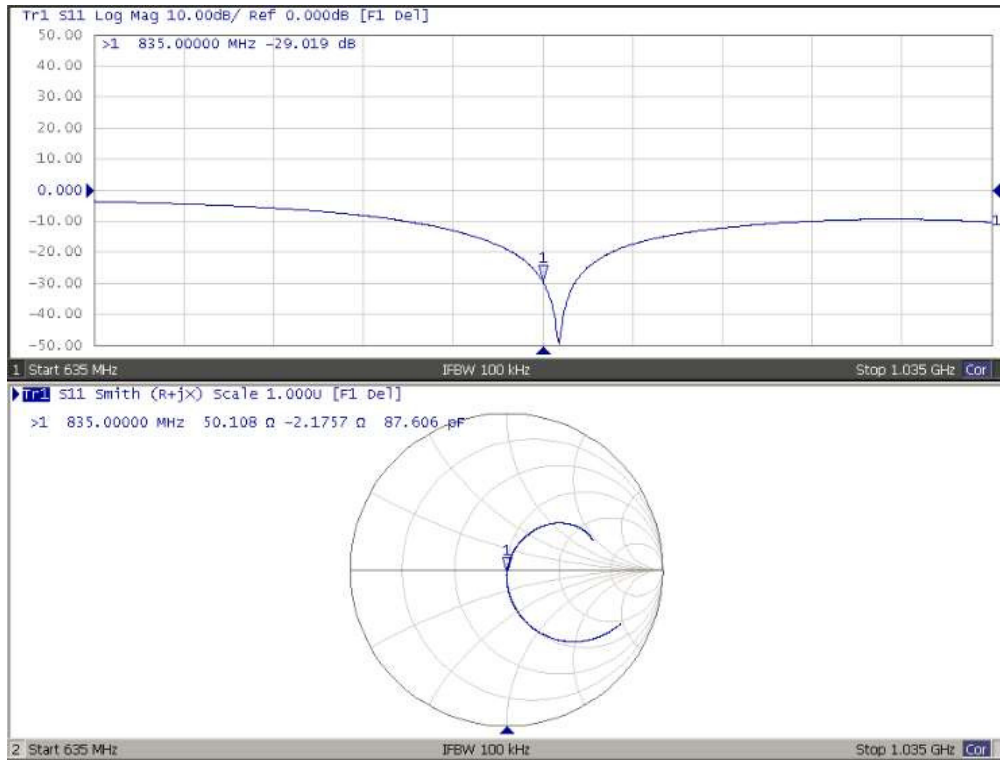

835MHz - Body

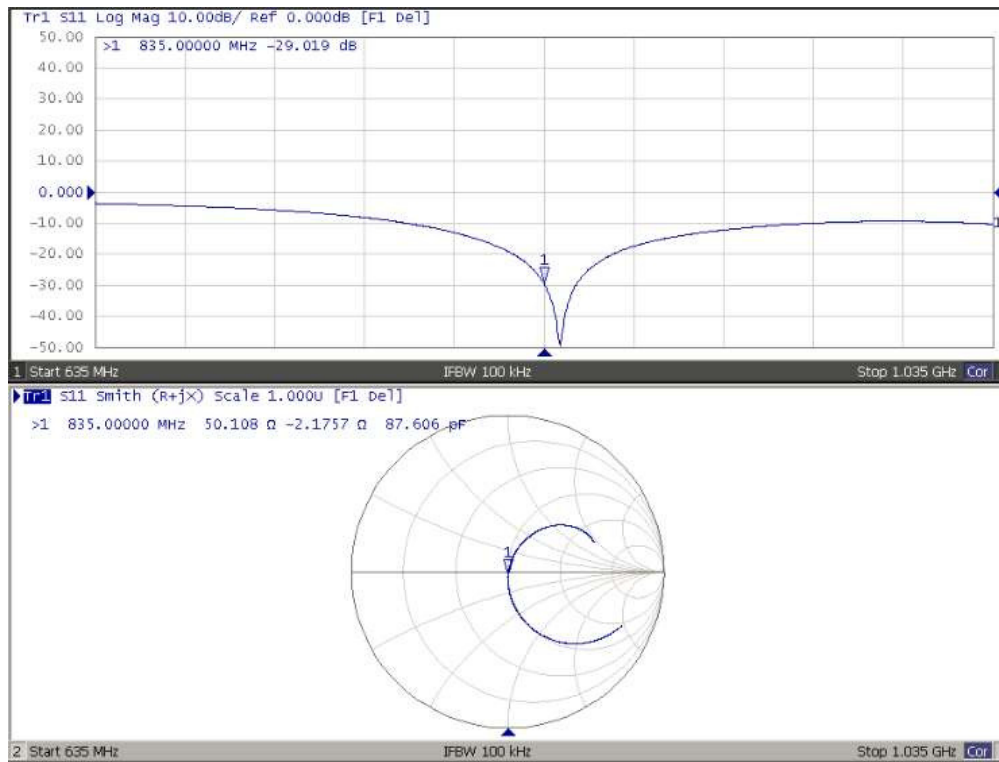

Justification of the extended calibration

D835V2 Serial No.4d112						
835 Head						
Date of Measurement	Return-Loss (dB)	Delta (%)	Real Impedance (ohm)	Delta (ohm)	Imaginary Impedance (ohm)	Delta (ohm)
10.22.2015	-27.27	--	49.108	--	-4.2018	--
10.21.2016	-29.019	6.41	50.108	1	-2.1757	2.0261
10.20.2017	-28.040	3.37	49.98	0.128	-3.965	1.789

D835V2 Serial No.4d112						
835 Body						
Date of Measurement	Return-Loss (dB)	Delta (%)	Real Impedance (ohm)	Delta (ohm)	Imaginary Impedance (ohm)	Delta (ohm)
10.22.2015	-23.036	--	46.184	--	-4.7866	--
10.21.2016	-23.131	0.56	47.003	0.819	-2.9072	1.8794
10.20.2017	-24.962	7.92	47.613	0.61	-4.977	2.07

The return loss is < -20dB, within 20% of prior calibration; the impedance is within 5 ohm of prior calibration. Therefore the verification result should support extended calibration.

Dipole Verification Data D835V2 Serial No.4d112 835MHz-Head

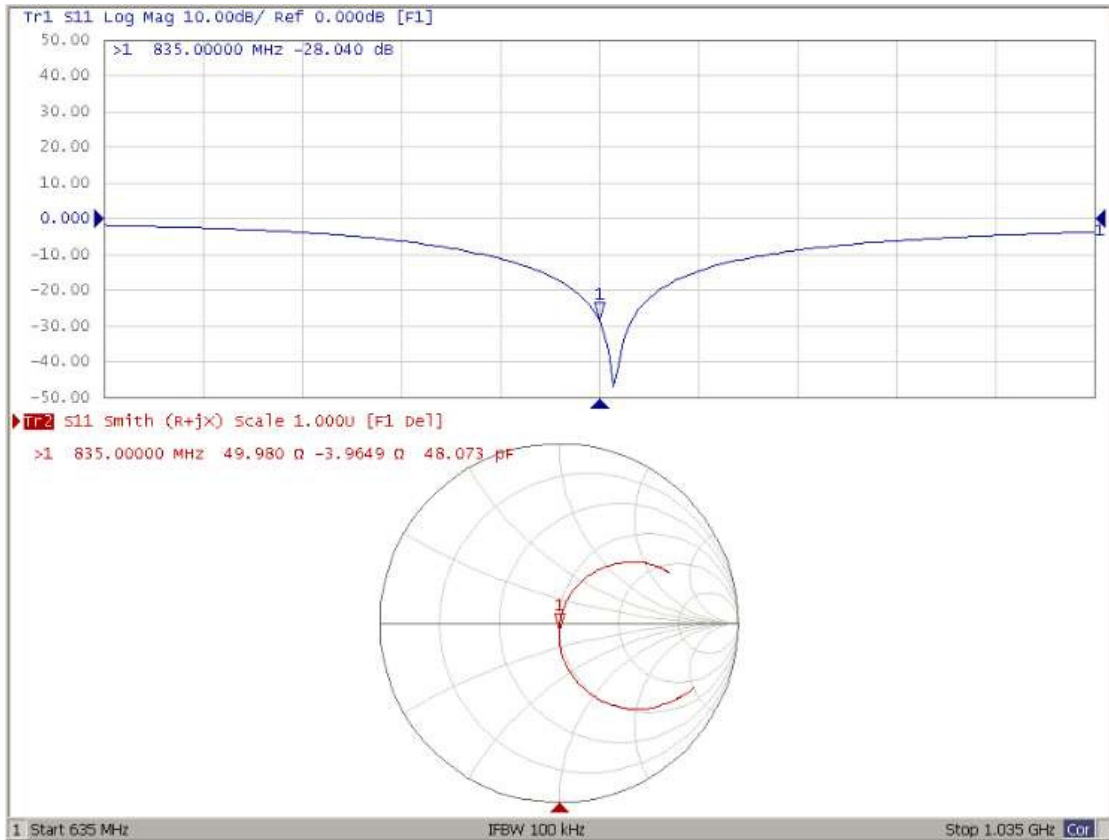

835MHz - Body

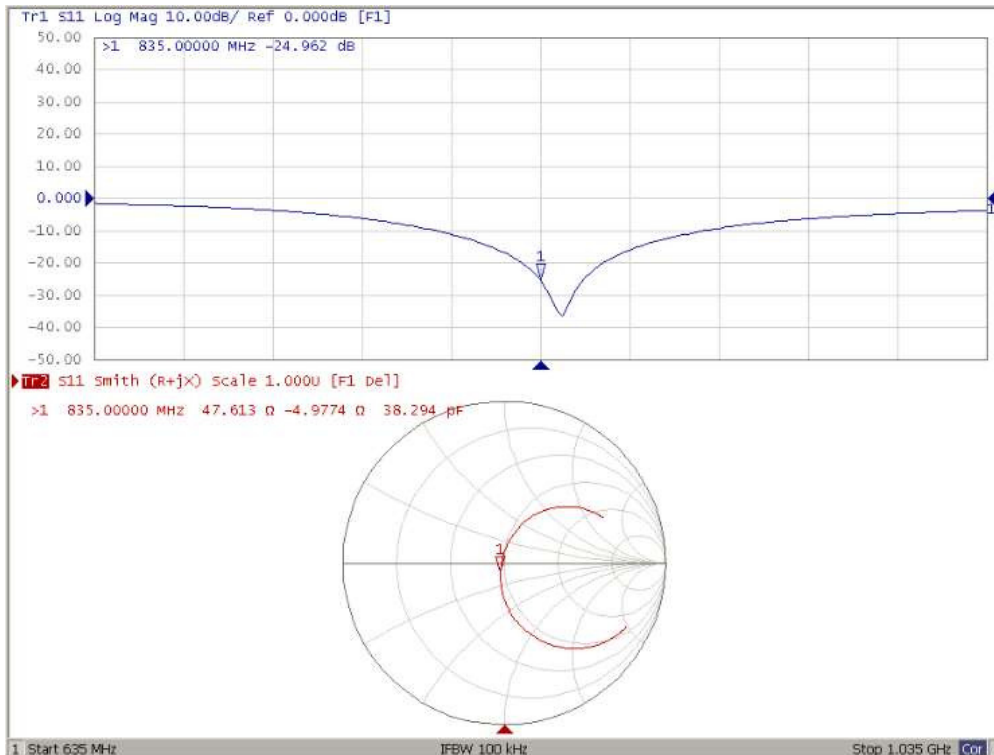



Add: No.51 Xueyuan Road, Haidian District, Beijing, 100191, China
 Tel: +86-10-62304633-2079 Fax: +86-10-62304633-2504
 E-mail: cml@chinantl.com [Http://www.chinantl.cn](http://www.chinantl.cn)



Client **ECIT** Certificate No: **Z15-97167**

CALIBRATION CERTIFICATE

Object **D1750V2 - SN: 1044**

Calibration Procedure(s) **FD-Z11-2-003-01**
Calibration Procedures for dipole validation kits

Calibration date: **November 3, 2015**

This calibration Certificate documents the traceability to national standards, which realize the physical units of measurements(SI). The measurements and the uncertainties with confidence probability are given on the following pages and are part of the certificate.

All calibrations have been conducted in the closed laboratory facility: environment temperature:(22±3)°C and humidity<70%.

Calibration Equipment used (M&TE critical for calibration)

Primary Standards	ID #	Cal Date(Calibrated by, Certificate No.)	Scheduled Calibration
Power Meter NRP2	101919	01-Jul-15 (CTTL, No.J15X04256)	Jun-16
Power sensor NRP-Z91	101547	01-Jul-15 (CTTL, No.J15X04256)	Jun-16
Reference Probe EX3DV4 DAE4	SN 3617	26-Aug-15(SPEAG,No.EX3-3617_Aug15)	Aug -16
	SN 777	26-Aug-15(SPEAG,No.DAE4-777_Aug15)	Aug -16
Secondary Standards	ID #	Cal Date(Calibrated by, Certificate No.)	Scheduled Calibration
Signal Generator E4438C	MY49071430	02-Feb-15 (CTTL, No.J15X00729)	Feb-16
Network Analyzer E5071C	MY46110673	03-Feb-15 (CTTL, No.J15X00728)	Feb-16

	Name	Function	Signature
Calibrated by:	Zhao Jing	SAR Test Engineer	
Reviewed by:	Qi Dianyuan	SAR Project Leader	
Approved by:	Lu Bingsong	Deputy Director of the laboratory	

Issued: November 6, 2015

This calibration certificate shall not be reproduced except in full without written approval of the laboratory.



Add: No.51 Xueyuan Road, Haidian District, Beijing, 100191, China
Tel: +86-10-62304633-2079 Fax: +86-10-62304633-2504
E-mail: ttl@chinattl.com Http://www.chinattl.cn

Glossary:

TSL	tissue simulating liquid
ConvF	sensitivity in TSL / NORM _{x,y,z}
N/A	not applicable or not measured

Calibration is Performed According to the Following Standards:

- IEEE Std 1528-2013, "IEEE Recommended Practice for Determining the Peak Spatial-Averaged Specific Absorption Rate (SAR) in the Human Head from Wireless Communications Devices: Measurement Techniques", June 2013
- IEC 62209-1, "Procedure to measure the Specific Absorption Rate (SAR) For hand-held devices used in close proximity to the ear (frequency range of 300MHz to 3GHz)", February 2005
- KDB865664, SAR Measurement Requirements for 100 MHz to 6 GHz

Additional Documentation:

- DASY4/5 System Handbook

Methods Applied and Interpretation of Parameters:

- Measurement Conditions:** Further details are available from the Validation Report at the end of the certificate. All figures stated in the certificate are valid at the frequency indicated.
- Antenna Parameters with TSL:** The dipole is mounted with the spacer to position its feed point exactly below the center marking of the flat phantom section, with the arms oriented parallel to the body axis.
- Feed Point Impedance and Return Loss:** These parameters are measured with the dipole positioned under the liquid filled phantom. The impedance stated is transformed from the measurement at the SMA connector to the feed point. The Return Loss ensures low reflected power. No uncertainty required.
- Electrical Delay:** One-way delay between the SMA connector and the antenna feed point. No uncertainty required.
- SAR measured:** SAR measured at the stated antenna input power.
- SAR normalized:** SAR as measured, normalized to an input power of 1 W at the antenna connector.
- SAR for nominal TSL parameters:** The measured TSL parameters are used to calculate the nominal SAR result.

The reported uncertainty of measurement is stated as the standard uncertainty of Measurement multiplied by the coverage factor $k=2$, which for a normal distribution corresponds to a coverage probability of approximately 95%.



In Collaboration with
speag
 CALIBRATION LABORATORY
 Add: No.51 Xueyuan Road, Haidian District, Beijing, 100191, China
 Tel: +86-10-62304633-2079 Fax: +86-10-62304633-2504
 E-mail: ttl@chinatvl.com Http://www.chinatvl.cn

Measurement Conditions

DASY system configuration, as far as not given on page 1.

DASY Version	DASY52	52.8.8.1222
Extrapolation	Advanced Extrapolation	
Phantom	Triple Flat Phantom 5.1C	
Distance Dipole Center - TSL	10 mm	with Spacer
Zoom Scan Resolution	dx, dy, dz = 5 mm	
Frequency	1750 MHz ± 1 MHz	

Head TSL parameters

The following parameters and calculations were applied.

	Temperature	Permittivity	Conductivity
Nominal Head TSL parameters	22.0 °C	40.1	1.37 mho/m
Measured Head TSL parameters	(22.0 ± 0.2) °C	39.7 ± 6 %	1.40 mho/m ± 6 %
Head TSL temperature change during test	<1.0 °C	---	---

SAR result with Head TSL

SAR averaged over 1 cm ³ (1 g) of Head TSL	Condition	
SAR measured	250 mW input power	9.48 mW / g
SAR for nominal Head TSL parameters	normalized to 1W	37.3 mW /g ± 20.8 % (k=2)
SAR averaged over 10 cm ³ (10 g) of Head TSL	Condition	
SAR measured	250 mW input power	5.09 mW / g
SAR for nominal Head TSL parameters	normalized to 1W	20.1 mW /g ± 20.4 % (k=2)

Body TSL parameters

The following parameters and calculations were applied.

	Temperature	Permittivity	Conductivity
Nominal Body TSL parameters	22.0 °C	53.4	1.49 mho/m
Measured Body TSL parameters	(22.0 ± 0.2) °C	54.4 ± 6 %	1.47 mho/m ± 6 %
Body TSL temperature change during test	<1.0 °C	---	---

SAR result with Body TSL

SAR averaged over 1 cm ³ (1 g) of Body TSL	Condition	
SAR measured	250 mW input power	9.30 mW / g
SAR for nominal Body TSL parameters	normalized to 1W	37.5 mW /g ± 20.8 % (k=2)
SAR averaged over 10 cm ³ (10 g) of Body TSL	Condition	
SAR measured	250 mW input power	5.02 mW / g
SAR for nominal Body TSL parameters	normalized to 1W	20.2 mW /g ± 20.4 % (k=2)



Add: No.51 Xuryuan Road, Haidian District, Beijing, 100191, China
 Tel: +86-10-62304633-2079 Fax: +86-10-62304633-2504
 E-mail: ctk@chinattl.com Http://www.chinattl.cn

Appendix

Antenna Parameters with Head TSL

Impedance, transformed to feed point	48.9Ω+ 1.17jΩ
Return Loss	- 35.8dB

Antenna Parameters with Body TSL

Impedance, transformed to feed point	45.5Ω+ 0.58jΩ
Return Loss	- 26.5dB

General Antenna Parameters and Design

Electrical Delay (one direction)	1.319 ns
----------------------------------	----------

After long term use with 100W radiated power, only a slight warming of the dipole near the feedpoint can be measured.

The dipole is made of standard semirigid coaxial cable. The center conductor of the feeding line is directly connected to the second arm of the dipole. The antenna is therefore short-circuited for DC-signals. On some of the dipoles, small end caps are added to the dipole arms in order to improve matching when loaded according to the position as explained in the "Measurement Conditions" paragraph. The SAR data are not affected by this change. The overall dipole length is still according to the Standard. No excessive force must be applied to the dipole arms, because they might bend or the soldered connections near the feedpoint may be damaged.

Additional EUT Data

Manufactured by	SPEAG
-----------------	-------



Add: No.51 Xueyuan Road, Haidian District, Beijing, 100191, China
 Tel: +86-10-62304633-2079 Fax: +86-10-62304633-2504
 E-mail: cnl@chinattl.com Http://www.chinattl.cn

DASY5 Validation Report for Head TSL

Date: 11.03.2015

Test Laboratory: CTTL, Beijing, China

DUT: Dipole 1750 MHz; Type: D1750V2; Serial: D1750V2 - SN: 1044

Communication System: UID 0, CW; Frequency: 1750 MHz; Duty Cycle: 1:1

Medium parameters used: $f = 1750$ MHz; $\sigma = 1.403$ S/m; $\epsilon_r = 39.72$; $\rho = 1000$ kg/m³

Phantom section: Right Section

Measurement Standard: DASY5 (IEEE/IEC/ANSI C63.19-2007)

DASY5 Configuration:

- Probe: EX3DV4 - SN3617; ConvF(8.34, 8.34, 8.34); Calibrated: 8/26/2015;
- Sensor-Surface: 2mm (Mechanical Surface Detection)
- Electronics: DAE4 Sn777; Calibrated: 8/26/2015
- Phantom: Triple Flat Phantom 5.1C; Type: QD 000 P51 CA; Serial: 1161/I
- Measurement SW: DASY52, Version 52.8 (8); SEMCAD X Version 14.6.10 (7331)

System Performance Check/Zoom Scan (7x7x7) (7x7x7)/Cube 0: Measurement grid:

$dx=5$ mm, $dy=5$ mm, $dz=5$ mm

Reference Value = 98.40V/m; Power Drift = -0.04 dB

Peak SAR (extrapolated) = 17.0W/kg

SAR(1 g) = 9.48 W/kg; SAR(10 g) = 5.09 W/kg

Maximum value of SAR (measured) = 13.3 W/kg

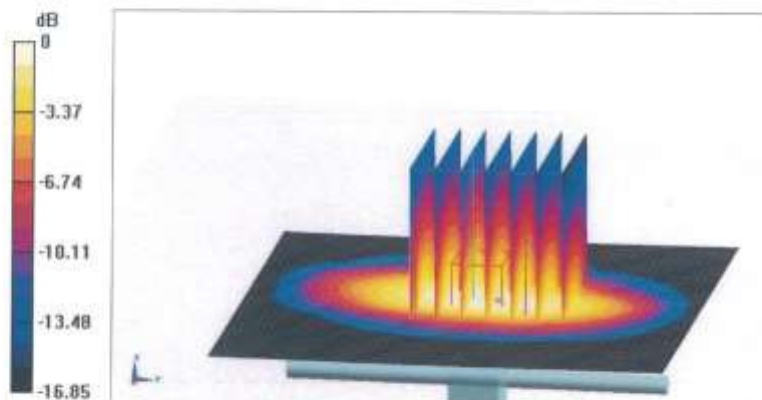

0 dB = 13.3 W/kg = 11.24 dBW/kg



Add: No.51 Xueyuan Road, Haidian District, Beijing, 100191, China
Tel: +86-10-62304633-2079 Fax: +86-10-62304633-2504
E-mail: ttl@chinattl.com Http://www.chinattl.cn

Impedance Measurement Plot for Head TSL

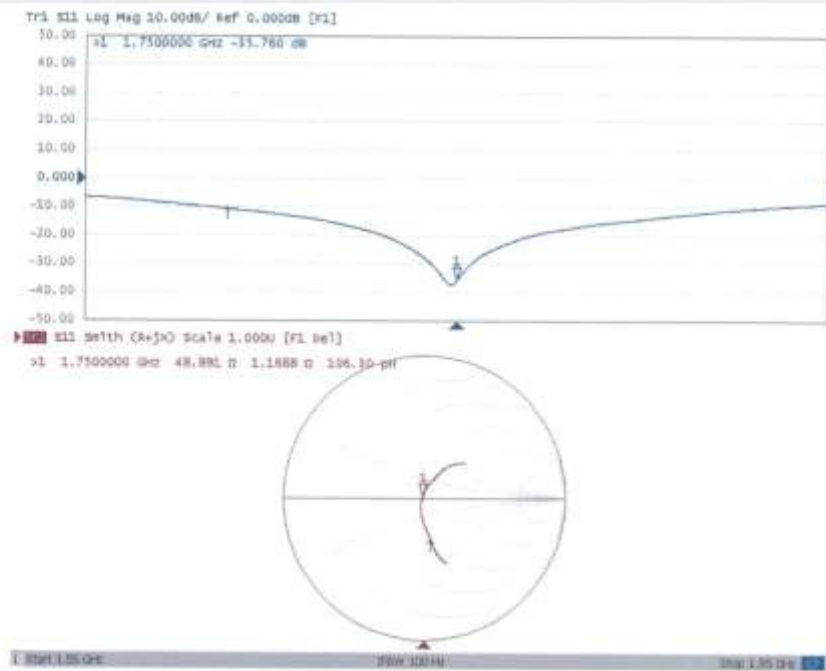



Add: No.51 Xueyun Road, Haidian District, Beijing, 100191, China
Tel: +86-10-62304633-2079 Fax: +86-10-62304633-2504
E-mail: ttl@chinattl.com Http://www.chinattl.cn

DASY5 Validation Report for Body TSL

Date: 11.03.2015

Test Laboratory: CTTL, Beijing, China

DUT: Dipole 1750 MHz; Type: D1750V2; Serial: D1750V2 - SN: 1044

Communication System: UID 0, CW; Frequency: 1750 MHz; Duty Cycle: 1:1

Medium parameters used: $f = 1750$ MHz; $\sigma = 1.474$ S/m; $\epsilon_r = 54.38$; $\rho = 1000$ kg/m³

Phantom section: Center Section

Measurement Standard: DASY5 (IEEE/IEC/ANSI C63.19-2007)

DASY5 Configuration:

- Probe: EX3DV4 - SN3617; ConvF(7.96, 7.96, 7.96); Calibrated: 8/26/2015;
- Sensor-Surface: 2mm (Mechanical Surface Detection)
- Electronics: DAE4 Sn777; Calibrated: 8/26/2015
- Phantom: Triple Flat Phantom 5.1C; Type: QD 000 P51 CA; Serial: 1161/1
- Measurement SW: DASY52, Version 52.8 (8); SEMCAD X Version 14.6.10 (7331)

System Performance Check/Zoom Scan (7x7x7) (7x7x7)/Cube 0: Measurement grid:

dx=5mm, dy=5mm, dz=5mm

Reference Value = 91.33 V/m; Power Drift = 0.00 dB

Peak SAR (extrapolated) = 16.3 W/kg

SAR(1 g) = 9.3 W/kg; SAR(10 g) = 5.02 W/kg

Maximum value of SAR (measured) = 13.1 W/kg

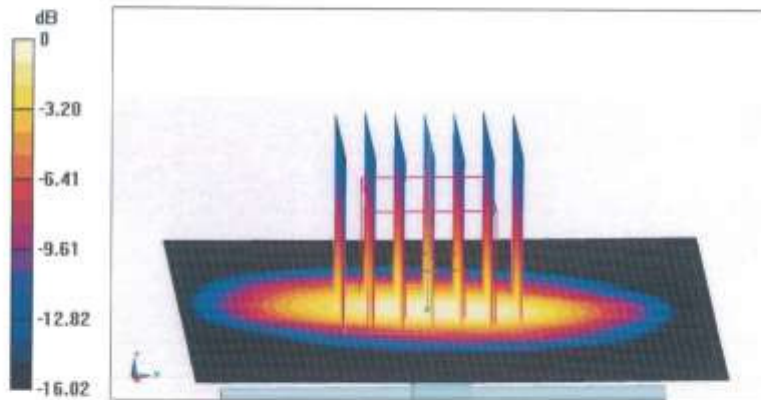
 $0 \text{ dB} = 13.1 \text{ W/kg} = 11.17 \text{ dBW/kg}$



Add: No.31 Xueyuan Road, Haidian District, Beijing, 100191, China
Tel: +86-10-62304633-2079 Fax: +86-10-62304633-2504
E-mail: cth@chinatll.com Http://www.chinatll.cn

Impedance Measurement Plot for Body TSL

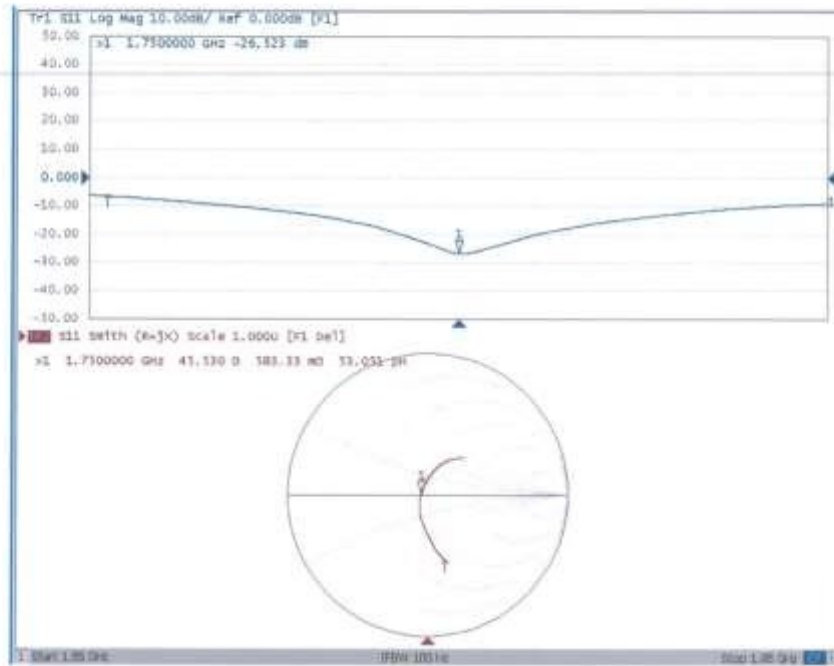

D1750V2,Serial No.1044 Extended Dipole Calibrations

Per IEEE Std 1528-2013,the dipole should have a return loss better than -20dB at the test frequency to reduce uncertainty in the power measurement.

Per KDB 865664 D01 ,if dipoles are verified in return loss(<-20dB,within 20% of prior calibration),and in impedance (within 5 ohm of prior calibration),the annual calibration is not necessary and the calibration interval can be extended.

Justification of the extended calibration

D1750V2 Serial No.1044						
1750 Head						
Date of Measurement	Return-Loss (dB)	Delta (%)	Real Impedance (ohm)	Delta (ohm)	Imaginary Impedance (ohm)	Delta (ohm)
11.03.2015	-36.76	--	48.891	--	1.1688	--
11.02.2016	-36.675	0.23	49.732	0.841	0.738	0.431

D1750V2 Serial No.1044						
1750Body						
Date of Measurement	Return-Loss (dB)	Delta (%)	Real Impedance (ohm)	Delta (ohm)	Imaginary Impedance (ohm)	Delta (ohm)
11.03.2015	-26.523	--	45.53	--	0.583	--
11.02.2016	-25.909	2.31	47.294	1.764	0.219	0.364

The return loss is < -20dB, within 20% of prior calibration; the impedance is within 5 ohm of prior calibration. Therefore the verification result should support extended calibration.

Dipole Verification Data D1750V2 Serial No.1044 1750MHz-Head

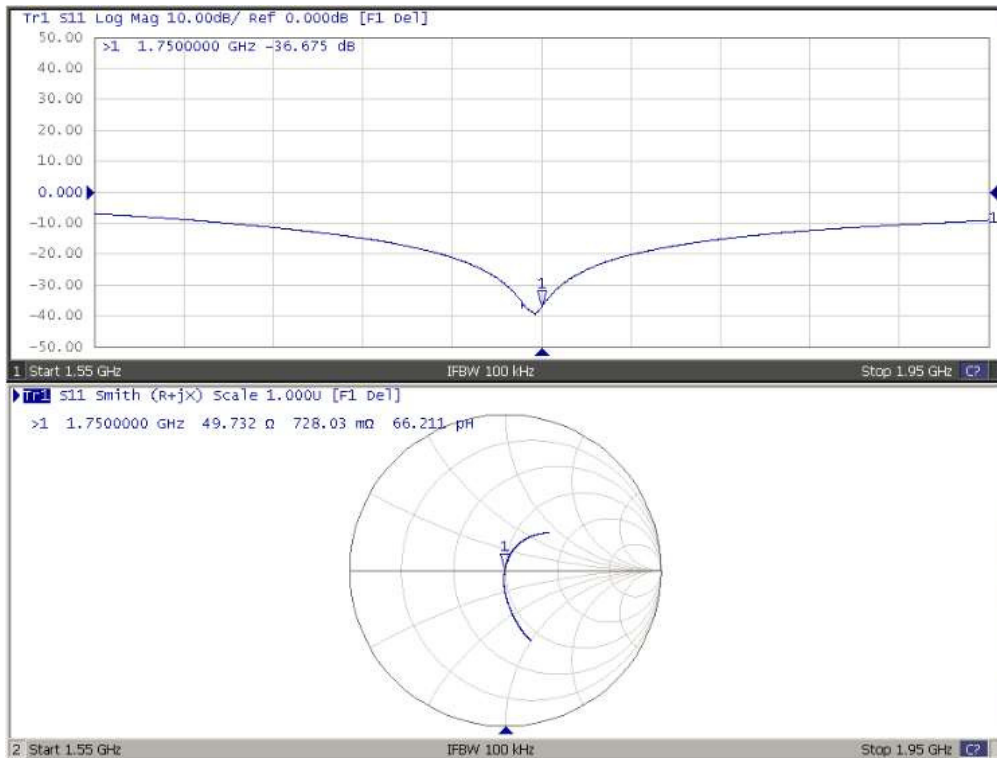

1750MHz - Body

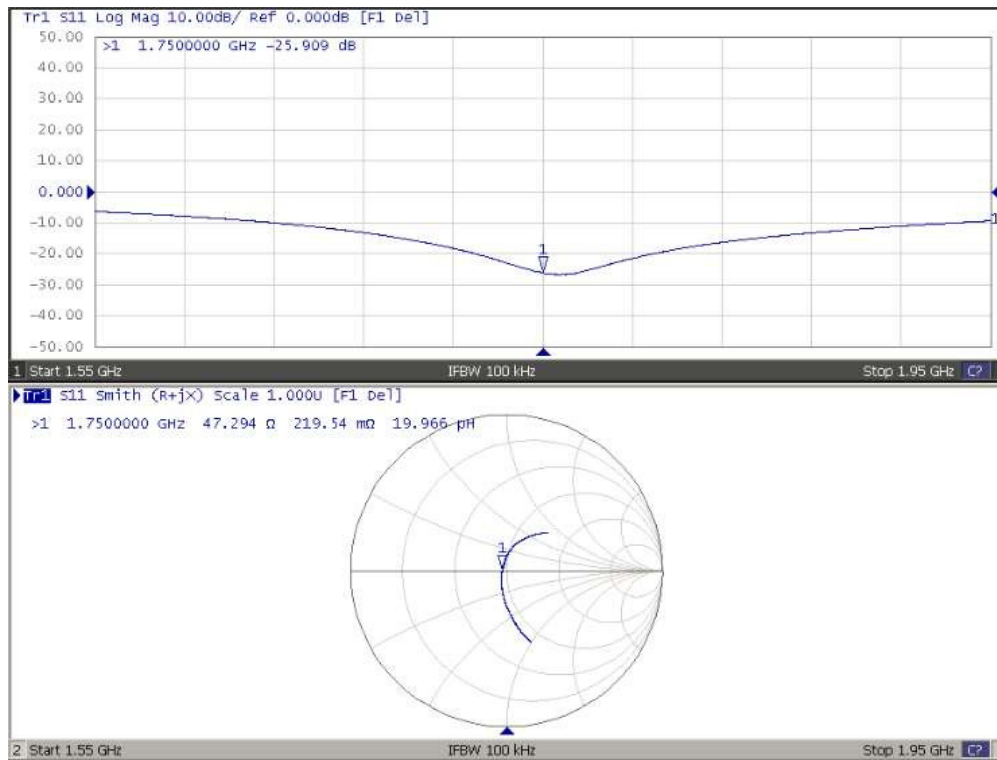

Justification of the extended calibration

D1750V2 Serial No.1044						
1750 Head						
Date of Measurement	Return-Loss (dB)	Delta (%)	Real Impedance (ohm)	Delta (ohm)	Imaginary Impedance (ohm)	Delta (ohm)
11.03.2015	-36.76	--	48.891	--	1.1688	--
11.02.2016	-36.675	0.23	49.732	0.841	0.738	0.431
11.01.2017	-34.452		48.865		1.490	

D1750V2 Serial No.1044						
1750Body						
Date of Measurement	Return-Loss (dB)	Delta (%)	Real Impedance (ohm)	Delta (ohm)	Imaginary Impedance (ohm)	Delta (ohm)
11.03.2015	-26.523	--	45.53	--	0.583	--
11.02.2016	-25.909	2.31	47.294	1.764	0.219	0.364
11.01.2017	-26.065	0.6	45.263	2.031	-0.136	0.355

The return loss is < -20dB, within 20% of prior calibration; the impedance is within 5 ohm of prior calibration. Therefore the verification result should support extended calibration.

Dipole Verification Data D1750V2 Serial No.1044 1750MHz-Head

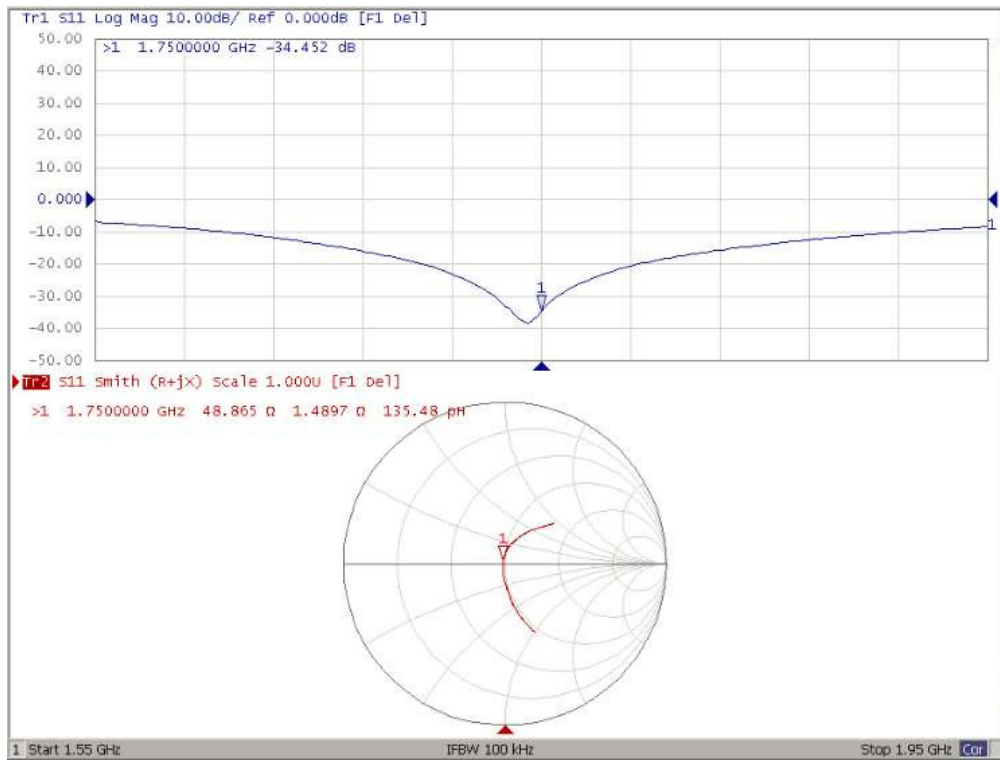

1750MHz - Body

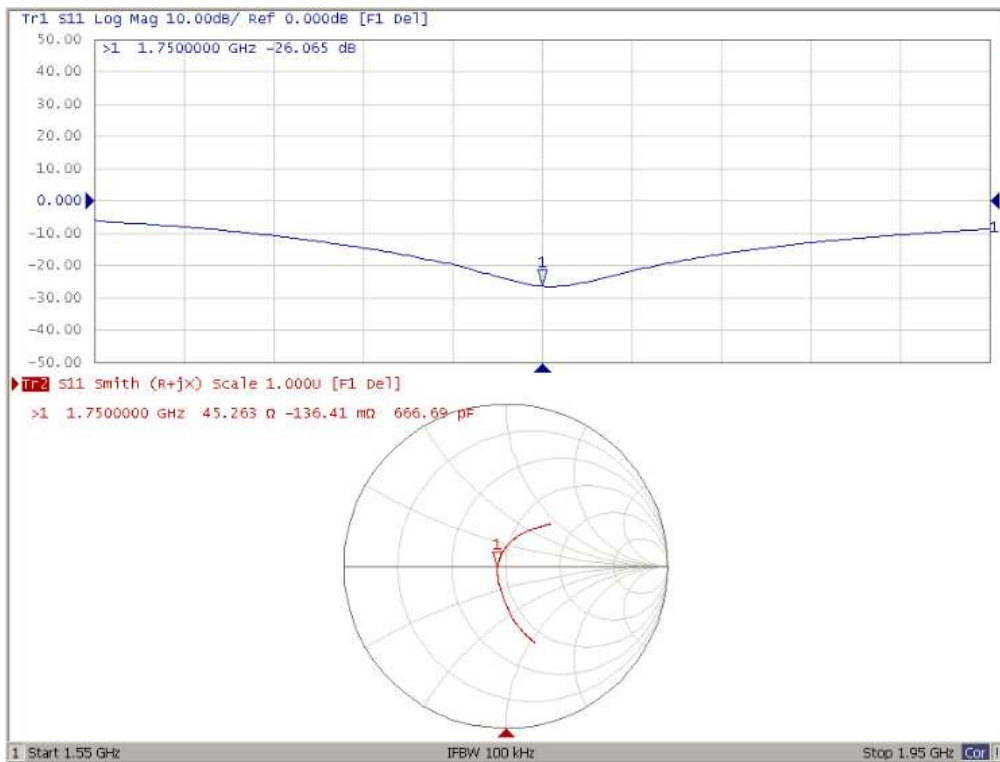



Add: No.51 Xueyuan Road, Haidian District, Beijing, 100191, China
 Tel: +86-10-62304633-2079 Fax: +86-10-62304633-2504
 E-mail: ctk@chinattl.com [Http://www.chinattl.cn](http://www.chinattl.cn)



Client **ECIT** Certificate No: **Z15-97168**

CALIBRATION CERTIFICATE

Object **D1900V2 - SN: 5d134**

Calibration Procedure(s) **FD-Z11-2-003-01**
 Calibration Procedures for dipole validation kits

Calibration date: **November 4, 2015**

This calibration Certificate documents the traceability to national standards, which realize the physical units of measurements(SI). The measurements and the uncertainties with confidence probability are given on the following pages and are part of the certificate.

All calibrations have been conducted in the closed laboratory facility: environment temperature(22±3)°C and humidity<70%.

Calibration Equipment used (M&TE critical for calibration)

Primary Standards	ID #	Cal Date(Calibrated by, Certificate No.)	Scheduled Calibration
Power Meter NRP2	101919	01-Jul-15 (CTTL, No.J15X04256)	Jun-16
Power sensor NRP-Z91	101547	01-Jul-15 (CTTL, No.J15X04256)	Jun-16
Reference Probe EX3DV4	SN 3617	26-Aug-15(SPEAG,No.EX3-3617_Aug15)	Aug-16
DAE4	SN 777	26-Aug-15(SPEAG,No.DAE4-777_Aug15)	Aug-16
Secondary Standards	ID #	Cal Date(Calibrated by, Certificate No.)	Scheduled Calibration
Signal Generator E4438C	MY49071430	02-Feb-15 (CTTL, No.J15X00728)	Feb-16
Network Analyzer E5071C	MY46110673	03-Feb-15 (CTTL, No.J15X00728)	Feb-16

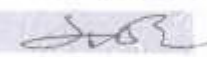
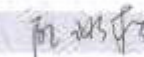
	Name	Function	Signature
Calibrated by:	Zhao Jing	SAR Test Engineer	
Reviewed by:	Qi Dianyuan	SAR Project Leader	
Approved by:	Lu Bingsong	Deputy Director of the laboratory	

Issued: November 8, 2015

This calibration certificate shall not be reproduced except in full without written approval of the laboratory.



Add: No.51 Xueyuan Road, Haidian District, Beijing, 100191, China
Tel: +86-10-62304633-2079 Fax: +86-10-62304633-2504
E-mail: ttl@chinattl.com Http://www.chinattl.cn

Glossary:

TSL	tissue simulating liquid
ConvF	sensitivity in TSL / NORM _{x,y,z}
N/A	not applicable or not measured

Calibration is Performed According to the Following Standards:

- IEEE Std 1528-2013, "IEEE Recommended Practice for Determining the Peak Spatial-Averaged Specific Absorption Rate (SAR) in the Human Head from Wireless Communications Devices: Measurement Techniques", June 2013
- IEC 62209-1, "Procedure to measure the Specific Absorption Rate (SAR) For hand-held devices used in close proximity to the ear (frequency range of 300MHz to 3GHz)", February 2005
- KDB865664, SAR Measurement Requirements for 100 MHz to 6 GHz

Additional Documentation:

- DASY4/5 System Handbook

Methods Applied and Interpretation of Parameters:

- Measurement Conditions:** Further details are available from the Validation Report at the end of the certificate. All figures stated in the certificate are valid at the frequency indicated.
- Antenna Parameters with TSL:** The dipole is mounted with the spacer to position its feed point exactly below the center marking of the flat phantom section, with the arms oriented parallel to the body axis.
- Feed Point Impedance and Return Loss:** These parameters are measured with the dipole positioned under the liquid filled phantom. The impedance stated is transformed from the measurement at the SMA connector to the feed point. The Return Loss ensures low reflected power. No uncertainty required.
- Electrical Delay:** One-way delay between the SMA connector and the antenna feed point. No uncertainty required.
- SAR measured:** SAR measured at the stated antenna input power.
- SAR normalized:** SAR as measured, normalized to an input power of 1 W at the antenna connector.
- SAR for nominal TSL parameters:** The measured TSL parameters are used to calculate the nominal SAR result.

The reported uncertainty of measurement is stated as the standard uncertainty of Measurement multiplied by the coverage factor $k=2$, which for a normal distribution corresponds to a coverage probability of approximately 95%.



Add: No.51 Xueyuan Road, Haidian District, Beijing, 100191, China
 Tel: +86-10-62304633-2079 Fax: +86-10-62304633-2504
 E-mail: cttl@chinattl.com Http://www.chinattl.cn

Measurement Conditions

DASY system configuration, as far as not given on page 1.

DASY Version	DASY52	52.8.8.1222
Extrapolation	Advanced Extrapolation	
Phantom	Triple Flat Phantom 5.1C	
Distance Dipole Center - TSL	10 mm	with Spacer
Zoom Scan Resolution	dx, dy, dz = 5 mm	
Frequency	1900 MHz ± 1 MHz	

Head TSL parameters

The following parameters and calculations were applied.

	Temperature	Permittivity	Conductivity
Nominal Head TSL parameters	22.0 °C	40.0	1.40 mho/m
Measured Head TSL parameters	(22.0 ± 0.2) °C	40.6 ± 6 %	1.39 mho/m ± 6 %
Head TSL temperature change during test	<1.0 °C	—	—

SAR result with Head TSL

SAR averaged over 1 cm ³ (1 g) of Head TSL	Condition	
SAR measured	250 mW input power	10.1 mW / g
SAR for nominal Head TSL parameters	normalized to 1W	40.8 mW / g ± 20.8 % (k=2)
SAR averaged over 10 cm ³ (10 g) of Head TSL	Condition	
SAR measured	250 mW input power	5.22 mW / g
SAR for nominal Head TSL parameters	normalized to 1W	21.0 mW / g ± 20.4 % (k=2)

Body TSL parameters

The following parameters and calculations were applied.

	Temperature	Permittivity	Conductivity
Nominal Body TSL parameters	22.0 °C	53.3	1.52 mho/m
Measured Body TSL parameters	(22.0 ± 0.2) °C	54.1 ± 6 %	1.54 mho/m ± 6 %
Body TSL temperature change during test	<1.0 °C	—	—

SAR result with Body TSL

SAR averaged over 1 cm ³ (1 g) of Body TSL	Condition	
SAR measured	250 mW input power	10.3 mW / g
SAR for nominal Body TSL parameters	normalized to 1W	41.1 mW / g ± 20.8 % (k=2)
SAR averaged over 10 cm ³ (10 g) of Body TSL	Condition	
SAR measured	250 mW input power	5.33 mW / g
SAR for nominal Body TSL parameters	normalized to 1W	21.3 mW / g ± 20.4 % (k=2)



Add: No.51 Xueyuan Road, Haidian District, Beijing, 100191, China
 Tel: +86-10-62304633-2079 Fax: +86-10-62304633-2504
 E-mail: cttl@chinattl.com Http://www.chinattl.cn

Appendix

Antenna Parameters with Head TSL

Impedance, transformed to feed point	51.8Ω+ 6.01jΩ
Return Loss	- 24.2dB

Antenna Parameters with Body TSL

Impedance, transformed to feed point	47.1Ω+ 5.41jΩ
Return Loss	- 24.0dB

General Antenna Parameters and Design

Electrical Delay (one direction)	1.305 ns
----------------------------------	----------

After long term use with 100W radiated power, only a slight warming of the dipole near the feedpoint can be measured.

The dipole is made of standard semirigid coaxial cable. The center conductor of the feeding line is directly connected to the second arm of the dipole. The antenna is therefore short-circuited for DC-signals. On some of the dipoles, small end caps are added to the dipole arms in order to improve matching when loaded according to the position as explained in the "Measurement Conditions" paragraph. The SAR data are not affected by this change. The overall dipole length is still according to the Standard. No excessive force must be applied to the dipole arms, because they might bend or the soldered connections near the feedpoint may be damaged.

Additional EUT Data

Manufactured by	SPEAG
-----------------	-------



Add: No.31 Xueyuan Road, Haidian District, Beijing, 100191, China
 Tel: +86-10-62304633-2079 Fax: +86-10-62304633-2504
 E-mail: ctt@chinattl.com Http://www.chinattl.cn

DASY5 Validation Report for Head TSL

Date: 11.04.2015

Test Laboratory: CTTL, Beijing, China

DUT: Dipole 1900 MHz; Type: D1900V2; Serial: D1900V2 - SN: 5d134

Communication System: UID 0, CW; Frequency: 1900 MHz; Duty Cycle: 1:1

Medium parameters used: $f = 1900$ MHz; $\sigma = 1.385$ S/m; $\epsilon_r = 40.56$; $\rho = 1000$ kg/m³

Phantom-section: Right Section

Measurement Standard: DASY5 (IEEE/IEC/ANSI C63.19-2007)

DASY5 Configuration:

- Probe: EX5DV4 - SN3617; ConvF(8.07, 8.07, 8.07); Calibrated: 8/26/2015;
- Sensor-Surface: 2mm (Mechanical Surface Detection)
- Electronics: DAE4 Sn777; Calibrated: 8/26/2015
- Phantom: Triple Flat Phantom 5.1C; Type: QD 000 P51 CA; Serial: 1161/I
- Measurement SW: DASY52, Version 52.8 (8); SEMCAD X Version 14.6.10 (7331)

System Performance Check/Zoom Scan (7x7x7) (7x7x7)/Cube 0: Measurement grid:

$dx=5$ mm, $dy=5$ mm, $dz=5$ mm

Reference Value = 100.8 V/m; Power Drift = -0.03 dB

Peak SAR (extrapolated) = 18.7W/kg

SAR(1 g) = 10.1 W/kg; SAR(10 g) = 5.22 W/kg

Maximum value of SAR (measured) = 14.5 W/kg

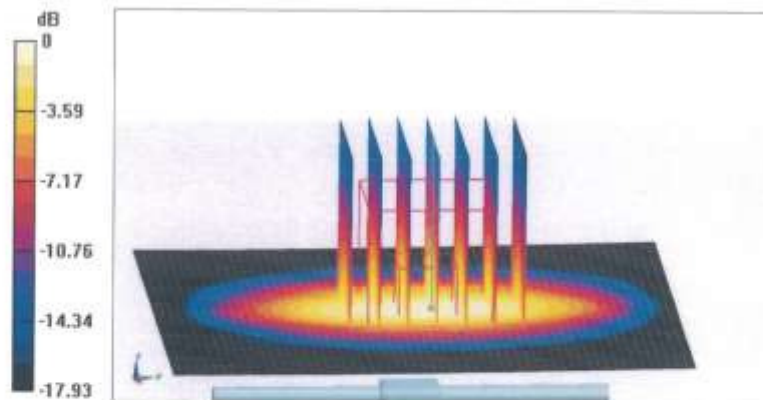

0 dB = 14.5 W/kg = 11.61 dBW/kg



Add: No.51 Xueyuan Road, Haidian District, Beijing, 100191, China
Tel: +86-10-62304633-2079 Fax: +86-10-62304633-2504
E-mail: cml@chinantl.com Http://www.chinantl.cn

Impedance Measurement Plot for Head TSL

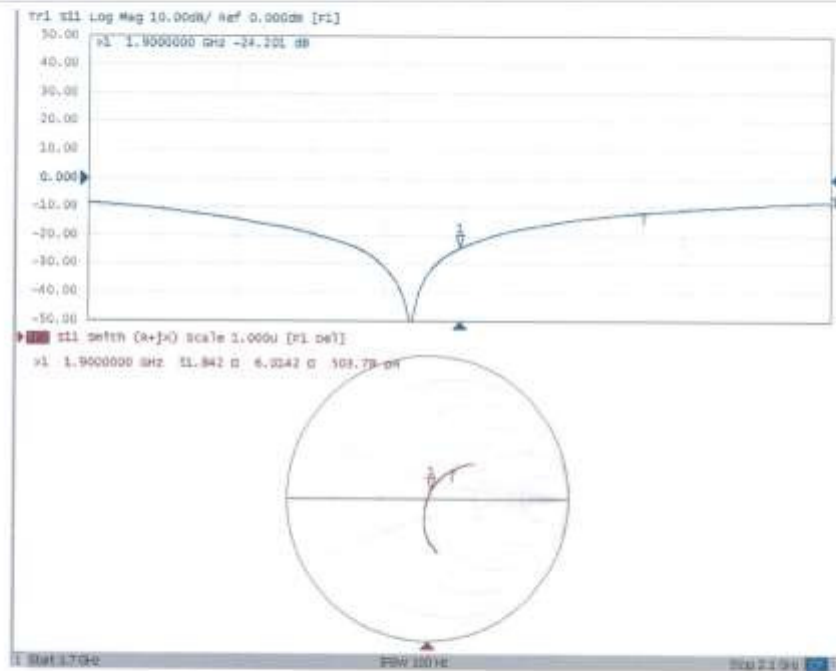



Add: No.51 Xueyuan Road, Haidian District, Beijing, 100191, China
 Tel: +86-10-62304633-2079 Fax: +86-10-62304633-2504
 E-mail: ttl@chinattl.com Http://www.chinattl.cn

DASY5 Validation Report for Body TSL

Date: 11.04.2015

Test Laboratory: CTTL, Beijing, China

DUT: Dipole 1900 MHz; Type: D1900V2; Serial: D1900V2 - SN: 5d134

Communication System: UID 0, CW; Frequency: 1900 MHz; Duty Cycle: 1:1

Medium parameters used: $f = 1900$ MHz; $\sigma = 1.536$ S/m; $\epsilon_r = 54.05$; $\rho = 1000$ kg/m³

Phantom section: Center Section

Measurement Standard: DASY5 (IEEE/IEC/ANSI C63.19-2007)

DASY5 Configuration:

- Probe: EX3DV4 - SN3617; ConvF(7.74, 7.74, 7.74); Calibrated: 8/26/2015;
- Sensor-Surface: 2mm (Mechanical Surface Detection)
- Electronics: DAE4 Sn777; Calibrated: 8/26/2015
- Phantom: Triple Flat Phantom 5.1C; Type: QD 000 P51 CA; Serial: 1161/1
- Measurement SW: DASY52, Version 52.8 (8); SEMCAD X Version 14.6.10 (7331)

System Performance Check/Zoom Scan (7x7x7) (7x7x7)/Cube 0: Measurement grid:

dx=5mm, dy=5mm, dz=5mm

Reference Value = 96.40 V/m; Power Drift = -0.02 dB

Peak SAR (extrapolated) = 19.0 W/kg

SAR(1 g) = 10.3W/kg; SAR(10 g) = 5.33 W/kg

Maximum value of SAR (measured) = 14.8 W/kg

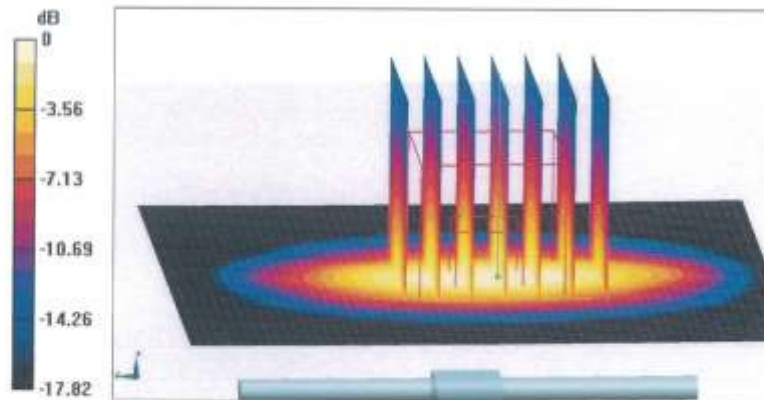

0 dB = 14.8 W/kg = 11.70 dBW/kg



Add: No.51 Xueyuan Road, Haidian District, Beijing, 100191, China
Tel: +86-10-62304633-2079 Fax: +86-10-62304633-2504
E-mail: ttl@chinattl.com Http://www.chinattl.cn

Impedance Measurement Plot for Body TSL

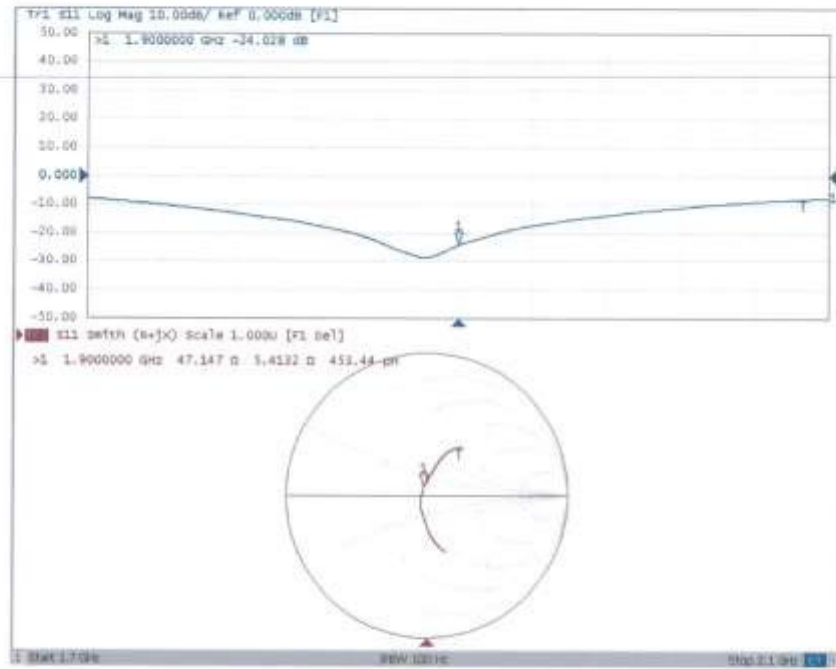

D1900V2,Serial No.5d134 Extended Dipole Calibrations

Per IEEE Std 1528-2013,the dipole should have a return loss better than -20dB at the test frequency to reduce uncertainty in the power measurement.

Per KDB 865664 D01 ,if dipoles are verified in return loss(<-20dB,within 20% of prior calibration),and in impedance (within 5 ohm of prior calibration),the annual calibration is not necessary and the calibration interval can be extended.

Justification of the extended calibration

D1900V2 Serial No.5d134						
1900 Head						
Date of Measurement	Return-Loss (dB)	Delta (%)	Real Impedance (ohm)	Delta (ohm)	Imaginary Impedance (ohm)	Delta (ohm)
11.04.2015	-24.201	--	51.842	--	6.0142	--
11.03.2016	-23.684	2.13	52.246	0.404	6.4699	0.456

D1900V2 Serial No.5d134						
1900 Body						
Date of Measurement	Return-Loss (dB)	Delta (%)	Real Impedance (ohm)	Delta (ohm)	Imaginary Impedance (ohm)	Delta (ohm)
11.04.2015	-24.028	--	47.147	--	5.4132	--
11.03.2016	-23.250	3.24	48.572	1.425	6.1951	0.782

The return loss is < -20dB, within 20% of prior calibration; the impedance is within 5 ohm of prior calibration. Therefore the verification result should support extended calibration.

Dipole Verification Data D1900V2 Serial No.5d134 1900MHz-Head

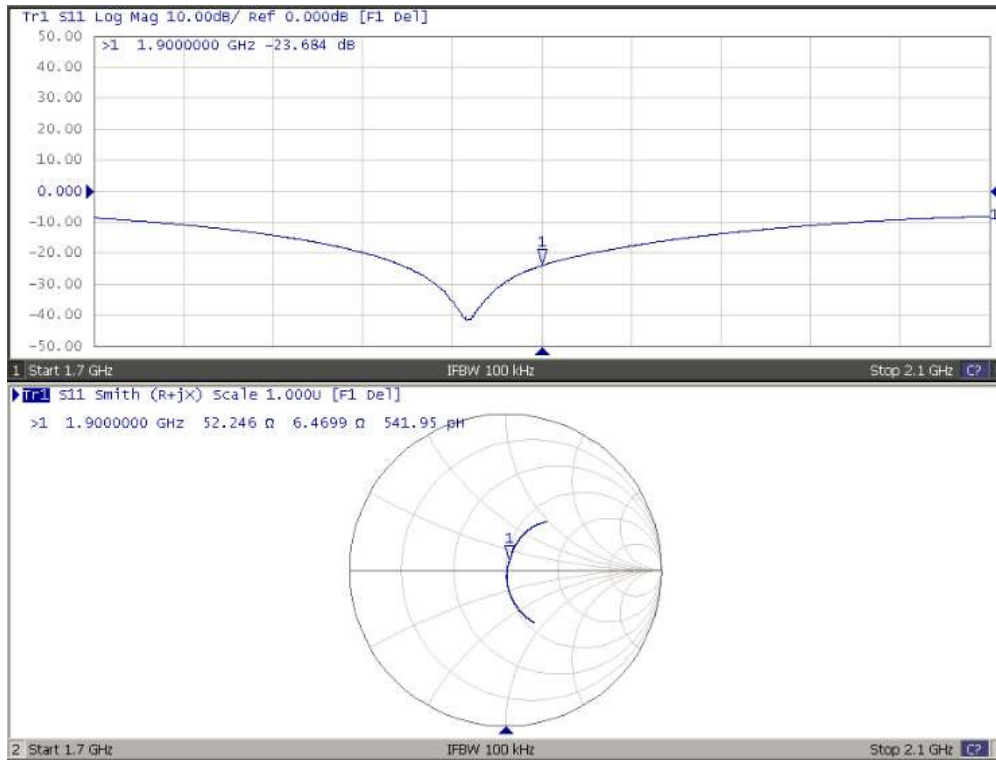

1900MHz - Body

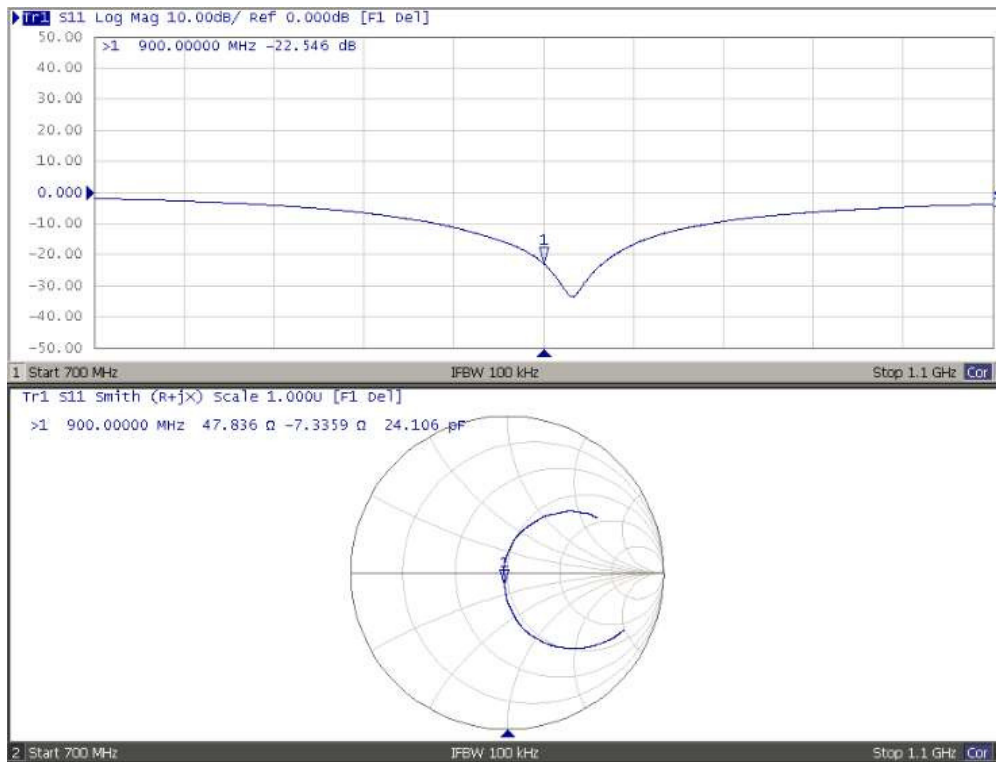

Justification of the extended calibration

D1900V2 Serial No.5d134						
1900 Head						
Date of Measurement	Return-Loss (dB)	Delta (%)	Real Impedance (ohm)	Delta (ohm)	Imaginary Impedance (ohm)	Delta (ohm)
11.04.2015	-24.201	--	51.842	--	6.0142	--
11.03.2016	-23.684	2.13	52.246	0.404	6.4699	0.456
11.02.2017	-24.279	0.595	50.467	1.779	6.1321	0.338

D1900V2 Serial No.5d134						
1900 Body						
Date of Measurement	Return-Loss (dB)	Delta (%)	Real Impedance (ohm)	Delta (ohm)	Imaginary Impedance (ohm)	Delta (ohm)
11.04.2015	-24.028	--	47.147	--	5.4132	--
11.03.2016	-23.250	3.24	48.572	1.425	6.1951	0.782
11.02.2017	-25.512	9.73	47.647	0.925	4.6178	1.577

The return loss is < -20dB, within 20% of prior calibration; the impedance is within 5 ohm of prior calibration. Therefore the verification result should support extended calibration.

Dipole Verification Data D1900V2 Serial No.5d134 1900MHz-Head

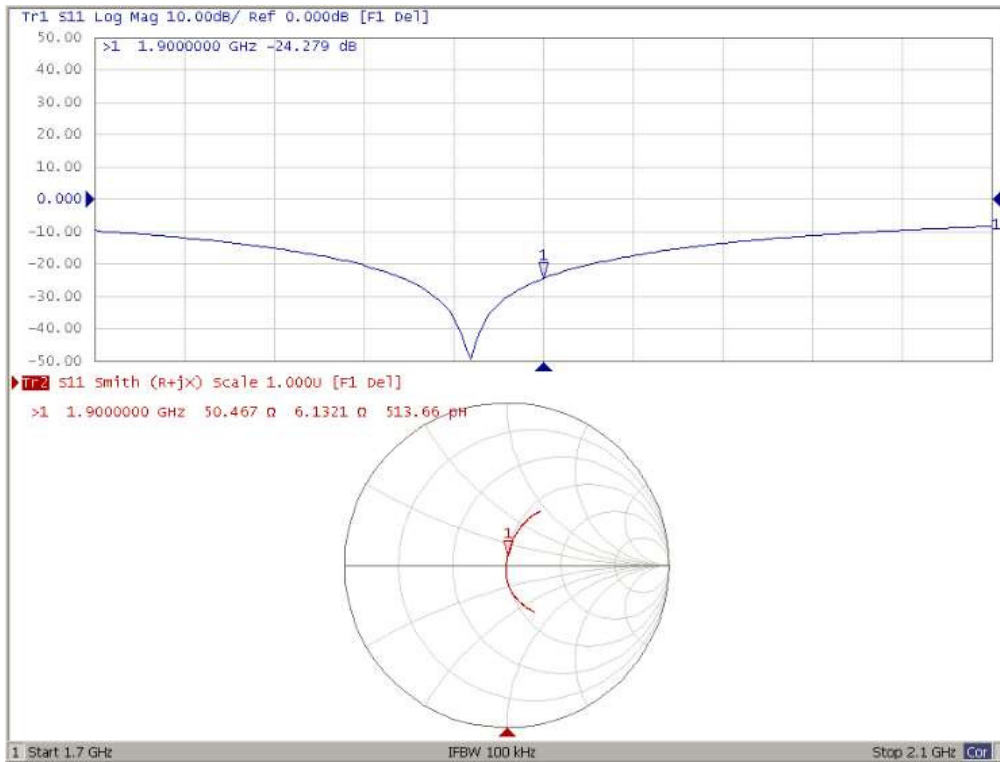

1900MHz - Body

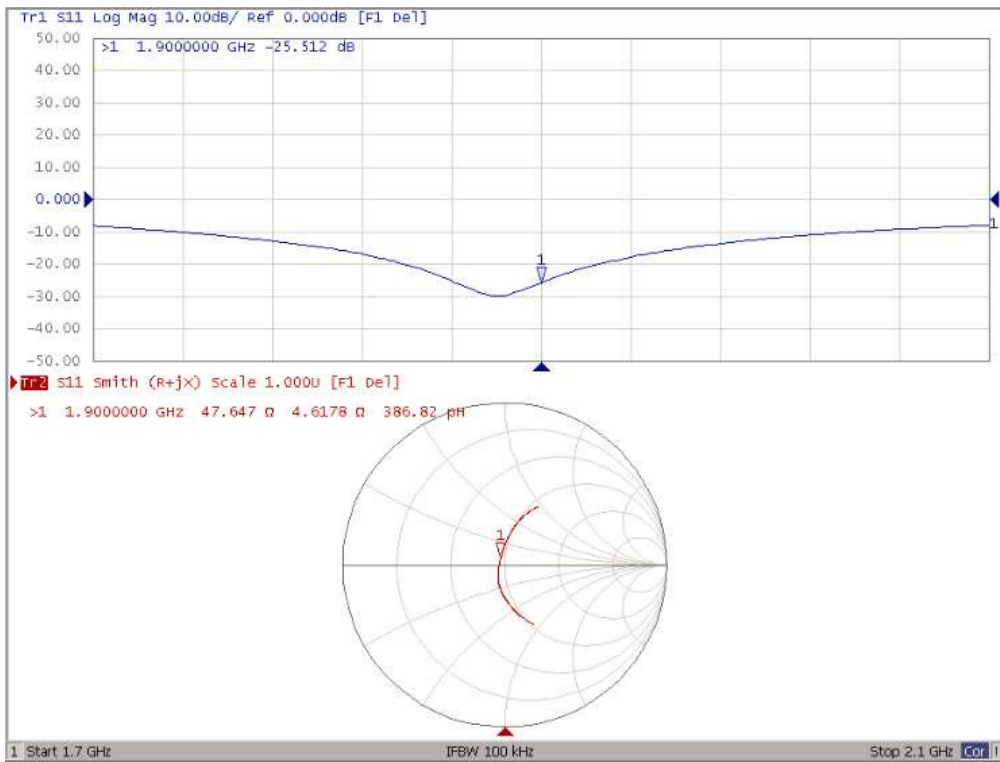



Add: No.51 Xueyuan Road, Haidian District, Beijing, 100191, China
 Tel: +86-10-62304633-2079 Fax: +86-10-62304633-2504
 E-mail: csl@chinantl.com [Http://www.chinantl.cn](http://www.chinantl.cn)



Client **ECIT** Certificate No: **Z15-97171**

CALIBRATION CERTIFICATE

Object: **D2450V2 - SN: 858**

Calibration Procedure(s): **FD-Z11-2-003-01**
 Calibration Procedures for dipole validation kits

Calibration date: **October 30, 2015**

This calibration Certificate documents the traceability to national standards, which realize the physical units of measurements(SI). The measurements and the uncertainties with confidence probability are given on the following pages and are part of the certificate.

All calibrations have been conducted in the closed laboratory facility: environment temperature(22±3)°C and humidity<70%.

Calibration Equipment used (M&TE critical for calibration)

Primary Standards	ID #	Cal Date(Calibrated by, Certificate No.)	Scheduled Calibration
Power Meter NRP2	101919	01-Jul-15 (CTTL, No.J15X04256)	Jun-16
Power sensor NRP-Z91	101547	01-Jul-15 (CTTL, No.J15X04256)	Jun-16
Reference Probe EX3DV4	SN 3617	26-Aug-15(SPEAG,No.EX3-3617_Aug15)	Aug-16
DAE4	SN 777	26-Aug-15(SPEAG,No.DAE4-777_Aug15)	Aug-16
Secondary Standards	ID #	Cal Date(Calibrated by, Certificate No.)	Scheduled Calibration
Signal Generator E4438C	MY49071430	02-Feb-15 (CTTL, No.J15X00729)	Feb-16
Network Analyzer E5071C	MY46110873	03-Feb-15 (CTTL, No.J15X00728)	Feb-16

	Name	Function	Signature
Calibrated by:	Zhao Jing	SAR Test Engineer	
Reviewed by:	Qi Dianyuan	SAR Project Leader	
Approved by:	Lu Bingsong	Deputy Director of the laboratory	

Issued: November 6, 2015

This calibration certificate shall not be reproduced except in full without written approval of the laboratory.



In Collaboration with
s p e a g
CALIBRATION LABORATORY

Add: No.51 Xueyuan Road, Haidian District, Beijing, 100191, China
Tel: +86-10-62304633-2079 Fax: +86-10-62304633-2504
E-mail: cttl@chinantl.com Http://www.chinantl.cn

Glossary:

TSL	tissue simulating liquid
ConvF	sensitivity in TSL / NORM _{x,y,z}
N/A	not applicable or not measured

Calibration is Performed According to the Following Standards:

- IEEE Std 1528-2013, "IEEE Recommended Practice for Determining the Peak Spatial-Averaged Specific Absorption Rate (SAR) in the Human Head from Wireless Communications Devices: Measurement Techniques", June 2013
- IEC 62209-1, "Procedure to measure the Specific Absorption Rate (SAR) For hand-held devices used in close proximity to the ear (frequency range of 300MHz to 3GHz)", February 2005
- KDB865664, SAR Measurement Requirements for 100 MHz to 6 GHz

Additional Documentation:

- DASY4/5 System Handbook

Methods Applied and Interpretation of Parameters:

- Measurement Conditions:** Further details are available from the Validation Report at the end of the certificate. All figures stated in the certificate are valid at the frequency indicated.
- Antenna Parameters with TSL:** The dipole is mounted with the spacer to position its feed point exactly below the center marking of the flat phantom section, with the arms oriented parallel to the body axis.
- Feed Point Impedance and Return Loss:** These parameters are measured with the dipole positioned under the liquid filled phantom. The impedance stated is transformed from the measurement at the SMA connector to the feed point. The Return Loss ensures low reflected power. No uncertainty required.
- Electrical Delay:** One-way delay between the SMA connector and the antenna feed point. No uncertainty required.
- SAR measured:** SAR measured at the stated antenna input power.
- SAR normalized:** SAR as measured, normalized to an input power of 1 W at the antenna connector.
- SAR for nominal TSL parameters:** The measured TSL parameters are used to calculate the nominal SAR result.

The reported uncertainty of measurement is stated as the standard uncertainty of Measurement multiplied by the coverage factor $k=2$, which for a normal distribution corresponds to a coverage probability of approximately 95%.



Add: No.51 Xueyuan Road, Haidian District, Beijing, 100191, China
 Tel: +86-10-62304633-2079 Fax: +86-10-62304633-2504
 E-mail: ttl@chinantl.com Http://www.chinantl.cn

Measurement Conditions

DASY system configuration, as far as not given on page 1

DASY Version	DASY52	52.8.8.1222
Extrapolation	Advanced Extrapolation	
Phantom	Triple Flat Phantom 5.1C	
Distance Dipole Center - TSL	10 mm	with Spacer
Zoom Scan Resolution	dx, dy, dz = 5 mm	
Frequency	2450 MHz ± 1 MHz	

Head TSL parameters

The following parameters and calculations were applied.

	Temperature	Permittivity	Conductivity
Nominal Head TSL parameters	22.0 °C	39.2	1.80 mho/m
Measured Head TSL parameters	(22.0 ± 0.2) °C	40.1 ± 6 %	1.82 mho/m ± 6 %
Head TSL temperature change during test	<1.0 °C	—	—

SAR result with Head TSL

SAR averaged over 1 cm^3 (1 g) of Head TSL	Condition	
SAR measured	250 mW input power	13.2 mW / g
SAR for nominal Head TSL parameters	normalized to 1W	52.9 mW /g ± 20.8 % (k=2)
SAR averaged over 10 cm^3 (10 g) of Head TSL	Condition	
SAR measured	250 mW input power	6.08 mW / g
SAR for nominal Head TSL parameters	normalized to 1W	24.3 mW /g ± 20.4 % (k=2)

Body TSL parameters

The following parameters and calculations were applied.

	Temperature	Permittivity	Conductivity
Nominal Body TSL parameters	22.0 °C	52.7	1.95 mho/m
Measured Body TSL parameters	(22.0 ± 0.2) °C	53.1 ± 6 %	1.94 mho/m ± 6 %
Body TSL temperature change during test	<1.0 °C	—	—

SAR result with Body TSL

SAR averaged over 1 cm^3 (1 g) of Body TSL	Condition	
SAR measured	250 mW input power	13.2 mW / g
SAR for nominal Body TSL parameters	normalized to 1W	53.1 mW /g ± 20.8 % (k=2)
SAR averaged over 10 cm^3 (10 g) of Body TSL	Condition	
SAR measured	250 mW input power	6.16 mW / g
SAR for nominal Body TSL parameters	normalized to 1W	24.7 mW /g ± 20.4 % (k=2)



In Collaboration with
s p e a g
CALIBRATION LABORATORY

Add: No.51 Xueyuan Road, Haidian District, Beijing, 100191, China
Tel: +86-10-62304633-2079 Fax: +86-10-62304633-2504
E-mail: csl@chinattl.com Http://www.chinattl.cn

Appendix

Antenna Parameters with Head TSL

Impedance, transformed to feed point	$53.2\Omega + 6.03j\Omega$
Return Loss	-23.6dB

Antenna Parameters with Body TSL

Impedance, transformed to feed point	$49.9\Omega + 7.39j\Omega$
Return Loss	-22.6dB

General Antenna Parameters and Design

Electrical Delay (one direction)	1.261 ns
----------------------------------	----------

After long term use with 100W radiated power, only a slight warming of the dipole near the feedpoint can be measured.

The dipole is made of standard semirigid coaxial cable. The center conductor of the feeding line is directly connected to the second arm of the dipole. The antenna is therefore short-circuited for DC-signals. On some of the dipoles, small end caps are added to the dipole arms in order to improve matching when loaded according to the position as explained in the "Measurement Conditions" paragraph. The SAR data are not affected by this change. The overall dipole length is still according to the Standard. No excessive force must be applied to the dipole arms, because they might bend or the soldered connections near the feedpoint may be damaged.

Additional EUT Data

Manufactured by	SPEAG
-----------------	-------



In Collaboration with
s p e a g
CALIBRATION LABORATORY

Add: No.51 Xueyuan Road, Haidian District, Beijing, 100191, China
Tel: +86-10-62304633-2079 Fax: +86-10-62304633-2504
E-mail: cntl@chinattl.com Http://www.chinattl.cn

DASY5 Validation Report for Head TSL

Date: 10.30.2015

Test Laboratory: CTTL, Beijing, China

DUT: Dipole 2450 MHz; Type: D2450V2; Serial: D2450V2 - SN: 858

Communication System: UID 0, CW; Frequency: 2450 MHz; Duty Cycle: 1:1

Medium parameters used: $f = 2450$ MHz; $\sigma = 1.816$ S/m; $\epsilon_r = 40.14$; $\rho = 1000$ kg/m³

Phantom section: Left Section

Measurement Standard: DASY5 (IEEE/IEC/ANSI C63.19-2007)

DASY5 Configuration:

- Probe: EX3DV4 - SN3617; ConvF(7.24, 7.24, 7.24); Calibrated: 8/26/2015;
- Sensor-Surface: 2mm (Mechanical Surface Detection)
- Electronics: DAE4 Sn777; Calibrated: 8/26/2015
- Phantom: Triple Flat Phantom 5.1C; Type: QD 000 P51 CA; Serial: 1161/1
- Measurement SW: DASY52, Version 52.8 (8); SEMCAD X Version 14.6.10 (7331)

Dipole Calibration/Zoom Scan (7x7x7) (7x7x7)/Cube 0: Measurement grid: dx=5mm, dy=5mm, dz=5mm

Reference Value = 106.3 V/m; Power Drift = -0.04 dB

Peak SAR (extrapolated) = 27.5 W/kg

SAR(1 g) = 13.2 W/kg; SAR(10 g) = 6.06 W/kg

Maximum value of SAR (measured) = 20.3 W/kg

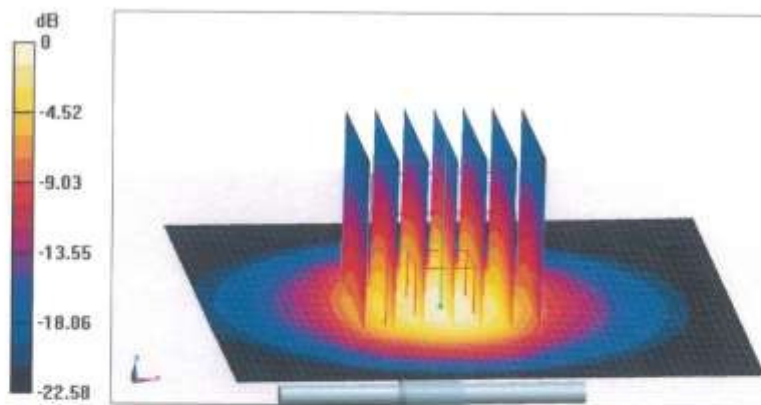

0 dB = 20.3 W/kg = 13.07 dBW/kg



In Collaboration with
s p e a g
CALIBRATION LABORATORY

Add: No.51 Xueyuan Road, Haidian District, Beijing, 100191, China
Tel: +86-10-62304633-2079 Fax: +86-10-62304633-2504
E-mail: cml@chinattl.com Http://www.chinattl.cn

Impedance Measurement Plot for Head TSL

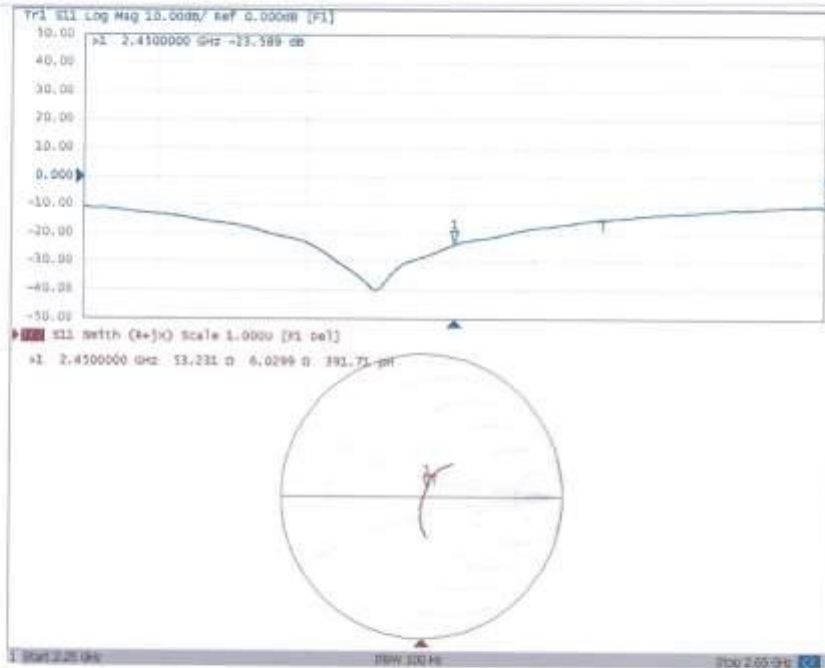



In Collaboration with
s p e a g
CALIBRATION LABORATORY

Add: No.51 Xueyuan Road, Haidian District, Beijing, 100191, China
Tel: +86-10-62304633-2079 Fax: +86-10-62304633-2504
E-mail: cml@chinattl.com Http://www.chinattl.cn

DASY5 Validation Report for Body TSL

Date: 10.30.2015

Test Laboratory: CTTL, Beijing, China

DUT: Dipole 2450 MHz; Type: D2450V2; Serial: D2450V2 - SN: 858

Communication System: UID 0, CW; Frequency: 2450 MHz; Duty Cycle: 1:1

Medium parameters used: $f = 2450$ MHz; $\sigma = 1.936$ S/m; $\epsilon_r = 53.11$; $\rho = 1000$ kg/m³

Phantom section: Center Section

Measurement Standard: DASY5 (IEEE/IEC/ANSI C63.19-2007)

DASY5 Configuration:

- Probe: EX3DV4 - SN3617; ConvF(7.35, 7.35, 7.35); Calibrated: 8/26/2015;
- Sensor-Surface: 2mm (Mechanical Surface Detection)
- Electronics: DAE4 Sn777; Calibrated: 8/26/2015
- Phantom: Triple Flat Phantom 5.1C; Type: QD 000 P51 CA; Serial: 1161/1
- Measurement SW: DASY52, Version 52.8 (8); SEMCAD X Version 14.6.10 (7331)

Dipole Calibration/Zoom Scan (7x7x7) (7x7x7)/Cube 0: Measurement grid: dx=5mm, dy=5mm, dz=5mm

Reference Value = 99.98 V/m; Power Drift = 0.07 dB

Peak SAR (extrapolated) = 26.6 W/kg

SAR(1 g) = 13.2 W/kg; SAR(10 g) = 6.16 W/kg

Maximum value of SAR (measured) = 19.8 W/kg

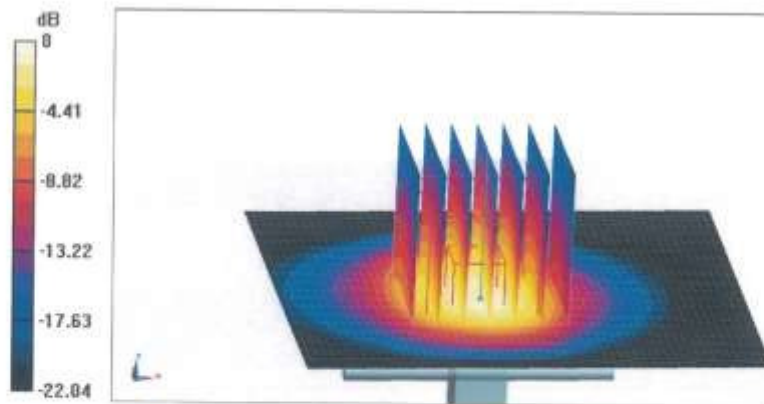

0 dB = 19.8 W/kg = 12.97 dBW/kg



In Collaboration with
s p e a g
CALIBRATION LABORATORY

Add: No.51 Xueyuan Road, Haidian District, Beijing, 100191, China
Tel: +86-10-62304633-2079 Fax: +86-10-62304633-2504
E-mail: cml@chinattl.com Http://www.chinattl.cn

Impedance Measurement Plot for Body TSL

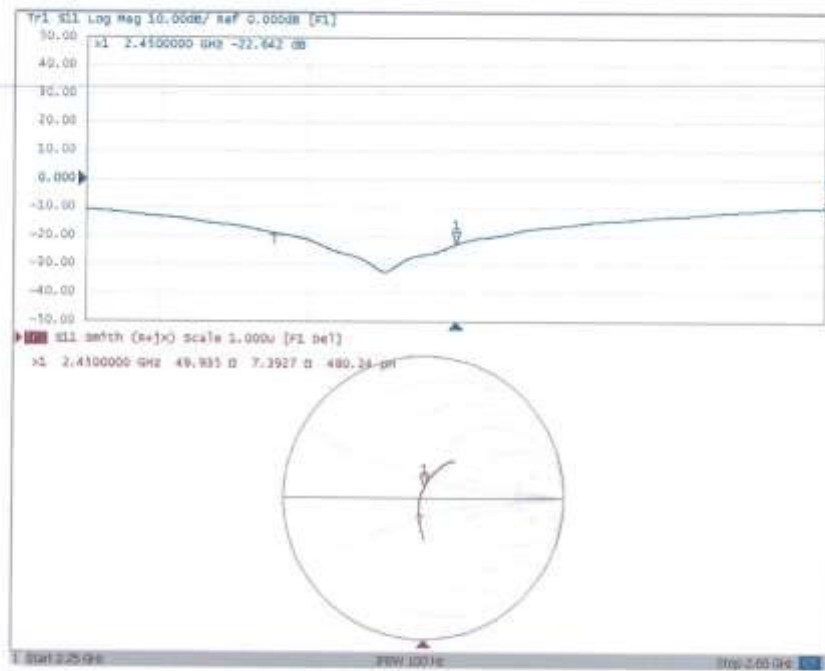

D2450V2,Serial No.858 Extended Dipole Calibrations

Per IEEE Std 1528-2013,the dipole should have a return loss better than -20dB at the test frequency to reduce uncertainty in the power measurement.

Per KDB 865664 D01 ,if dipoles are verified in return loss(<-20dB,within 20% of prior calibration),and in impedance (within 5 ohm of prior calibration),the annual calibration is not necessary and the calibration interval can be extended.

Justification of the extended calibration

D2450V2 Serial No.858						
2450 Head						
Date of Measurement	Return-Loss (dB)	Delta (%)	Real Impedance (ohm)	Delta (ohm)	Imaginary Impedance (ohm)	Delta (ohm)
10.30.2015	-23.589	--	53.231	--	6.0299	--
10.29.2016	-23.466	0.52	50.672	2.559	6.4162	0.386

D2450V2 Serial No.858						
2450 Body						
Date of Measurement	Return-Loss (dB)	Delta (%)	Real Impedance (ohm)	Delta (ohm)	Imaginary Impedance (ohm)	Delta (ohm)
10.30.2015	-22.642	--	49.935	--	7.3927	--
10.29.2016	-23.075	1.91	46.903	3.032	5.6814	1.711

The return loss is < -20dB, within 20% of prior calibration; the impedance is within 5 ohm of prior calibration. Therefore the verification result should support extended calibration.

Dipole Verification Data D2450V2 Serial No.858 2450MHz-Head

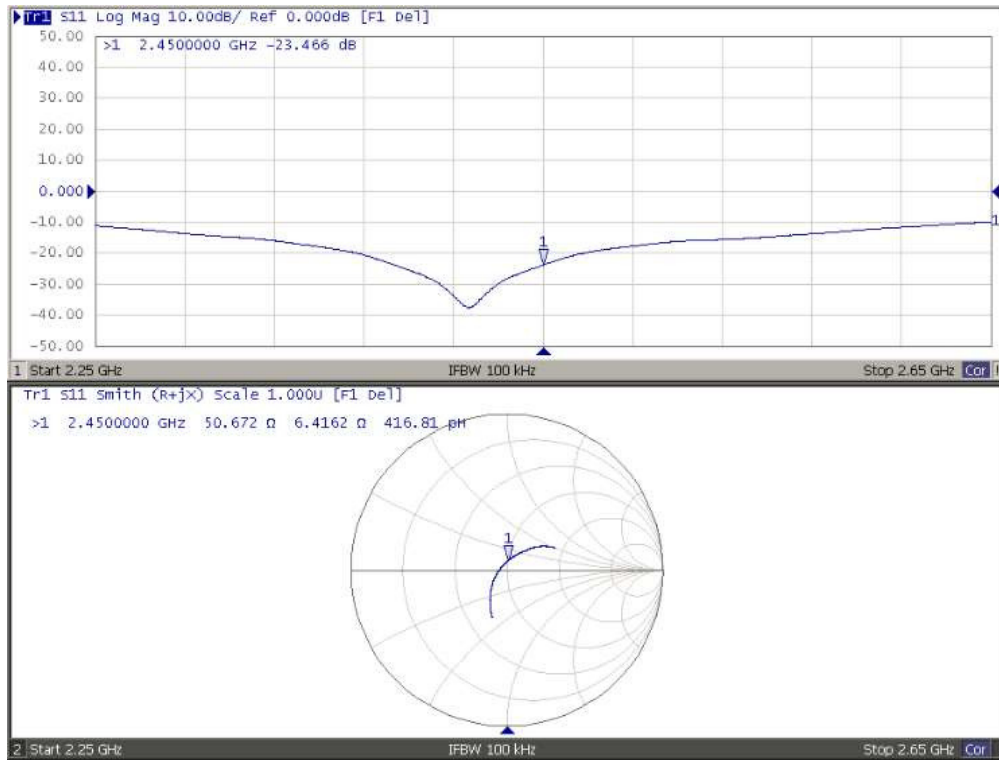

2450MHz - Body

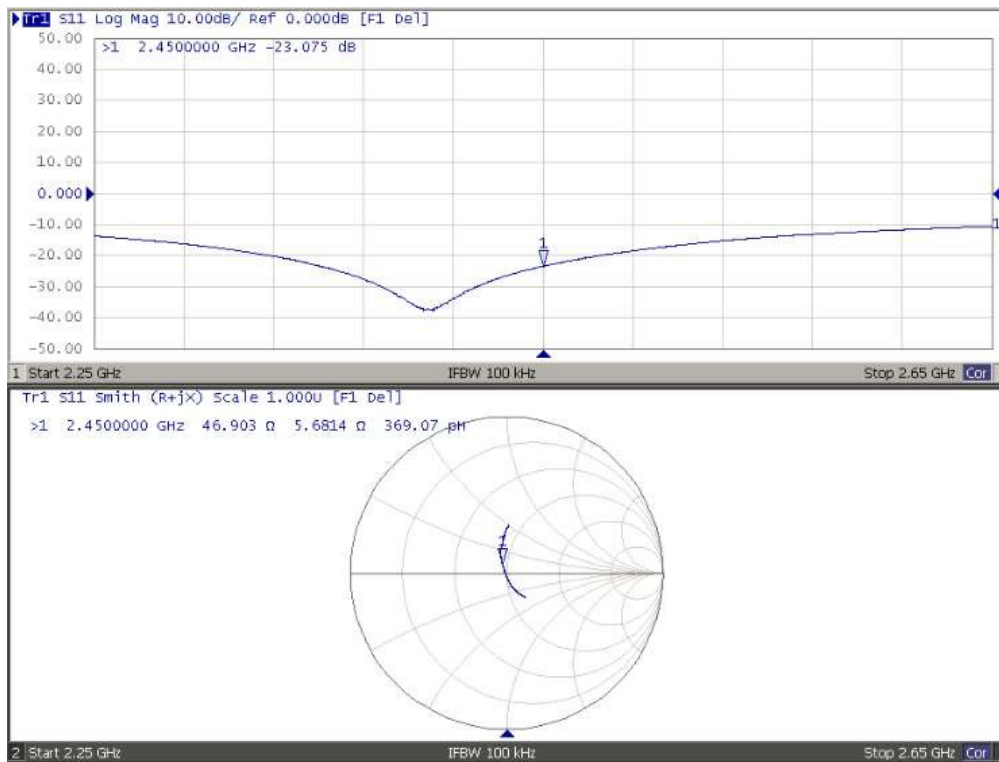

Justification of the extended calibration

D2450V2 Serial No.858						
2450 Head						
Date of Measurement	Return-Loss (dB)	Delta (%)	Real Impedance (ohm)	Delta (ohm)	Imaginary Impedance (ohm)	Delta (ohm)
10.30.2015	-23.589	--	53.231	--	6.0299	--
10.29.2016	-23.466	0.52	50.672	2.559	6.4162	0.386
10.27.2017	-22.956	2.17	52.563	1.891	6.85	0.434

D2450V2 Serial No.858						
2450 Body						
Date of Measurement	Return-Loss (dB)	Delta (%)	Real Impedance (ohm)	Delta (ohm)	Imaginary Impedance (ohm)	Delta (ohm)
10.30.2015	-22.642	--	49.935	--	7.3927	--
10.29.2016	-23.075	1.91	46.903	3.032	5.6814	1.711
10.27.2017	-22.414	2.86	50.694	3.791	7.616	1.935

The return loss is < -20dB, within 20% of prior calibration; the impedance is within 5 ohm of prior calibration. Therefore the verification result should support extended calibration.

Dipole Verification Data D2450V2 Serial No.858 2450MHz-Head

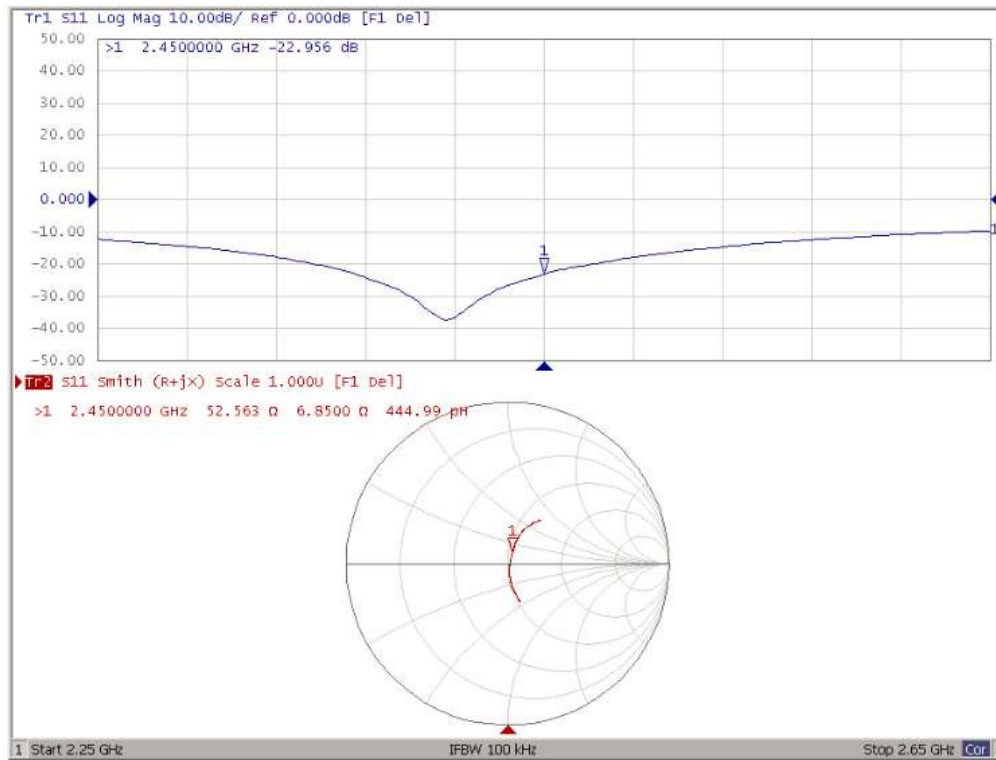

2450MHz – Body

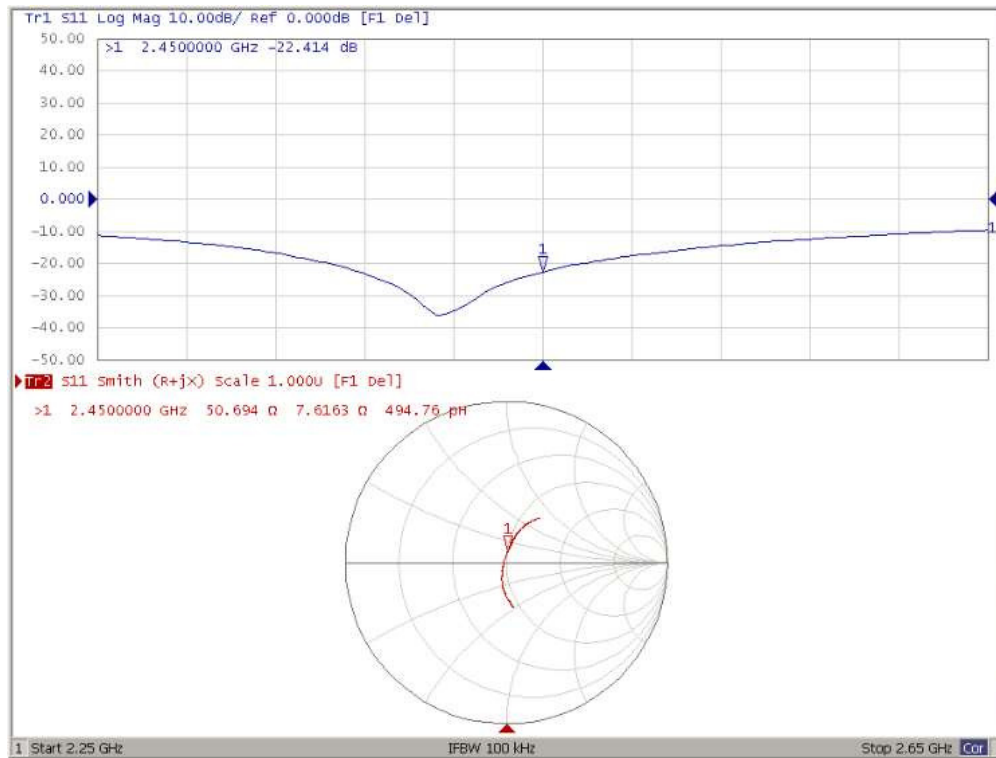





Add: No.51 Xueyuan Road, Haidian District, Beijing, 100191, China
 Tel: +86-10-62304633-2079 Fax: +86-10-62304633-2504
 E-mail: cntl@chinattl.com <http://www.chinattl.cn>

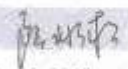

Client: **ECIT** Certificate No: **Z15-97172**

CALIBRATION CERTIFICATE			
Object	D2800V2 - SN: 1031		
Calibration Procedure(s)	FD-Z11-2-003-01 Calibration Procedures for dipole validation kits		
Calibration date:	October 30, 2015		
<p>This calibration Certificate documents the traceability to national standards, which realize the physical units of measurements(SI). The measurements and the uncertainties with confidence probability are given on the following pages and are part of the certificate.</p> <p>All calibrations have been conducted in the closed laboratory facility: environment temperature(22±3)℃ and humidity<70%.</p> <p>Calibration Equipment used (M&TE critical for calibration)</p>			
Primary Standards	ID #	Cal Date(Calibrated by, Certificate No.)	Scheduled Calibration
Power Meter NRP2	101919	01-Jul-15 (CTTL, No.J15X04256)	Jun-16
Power sensor NRP-Z91	101547	01-Jul-15 (CTTL, No.J15X04256)	Jun-16
Reference Probe EX3DV4	SN 3617	26-Aug-15(SPEAG,No.EX3-3617_Aug15)	Aug-16
DAE4	SN 777	26-Aug-15(SPEAG,No.DAE4-777_Aug15)	Aug-16
Secondary Standards	ID #	Cal Date(Calibrated by, Certificate No.)	Scheduled Calibration
Signal Generator E4438C	MY49071430	02-Feb-15 (CTTL, No.J15X00729)	Feb-16
Network Analyzer E5071C	MY46110673	03-Feb-15 (CTTL, No.J15X00728)	Feb-16
Calibrated by:	Name Zhao Jing	Function SAR Test Engineer	Signature 
Reviewed by:	Name Qi Dianyuan	Function SAR Project Leader	Signature 
Approved by:	Name Lu Bingsong	Function Deputy Director of the laboratory	Signature 
Issued: November 6, 2015			
This calibration certificate shall not be reproduced except in full without written approval of the laboratory.			



In Collaboration with
s p e a g
CALIBRATION LABORATORY

Add: No.51 Xueyuan Road, Haidian District, Beijing, 100191, China
Tel: +86-10-62304633-2079 Fax: +86-10-62304633-2304
E-mail: ctt@chinattl.com Http://www.chinattl.cn

Glossary:

TSL	tissue simulating liquid
ConvF	sensitivity in TSL / NORM _{x,y,z}
N/A	not applicable or not measured

Calibration is Performed According to the Following Standards:

- IEEE Std 1528-2013, "IEEE Recommended Practice for Determining the Peak Spatial-Averaged Specific Absorption Rate (SAR) in the Human Head from Wireless Communications Devices: Measurement Techniques", June 2013
- IEC 62209-1, "Procedure to measure the Specific Absorption Rate (SAR) For hand-held devices used in close proximity to the ear (frequency range of 300MHz to 3GHz)", February 2005
- KDB865664, SAR Measurement Requirements for 100 MHz to 6 GHz

Additional Documentation:

- DASY4/5 System Handbook

Methods Applied and interpretation of Parameters:

- Measurement Conditions:** Further details are available from the Validation Report at the end of the certificate. All figures stated in the certificate are valid at the frequency indicated.
- Antenna Parameters with TSL:** The dipole is mounted with the spacer to position its feed point exactly below the center marking of the flat phantom section, with the arms oriented parallel to the body axis.
- Feed Point Impedance and Return Loss:** These parameters are measured with the dipole positioned under the liquid filled phantom. The impedance stated is transformed from the measurement at the SMA connector to the feed point. The Return Loss ensures low reflected power. No uncertainty required.
- Electrical Delay:** One-way delay between the SMA connector and the antenna feed point. No uncertainty required.
- SAR measured:** SAR measured at the stated antenna input power.
- SAR normalized:** SAR as measured, normalized to an input power of 1 W at the antenna connector.
- SAR for nominal TSL parameters:** The measured TSL parameters are used to calculate the nominal SAR result.

The reported uncertainty of measurement is stated as the standard uncertainty of Measurement multiplied by the coverage factor $k=2$, which for a normal distribution corresponds to a coverage probability of approximately 95%.



In Collaboration with
s p e a g
 CALIBRATION LABORATORY

Add: No.51 Xueyuan Road, Haidian District, Beijing, 100191, China
 Tel: +86-10-62304633-2079 Fax: +86-10-62304633-2504
 E-mail: ttl@chinattl.com Http://www.chinattl.cn

Measurement Conditions

DASY system configuration, as far as not given on page 1.

DASY Version	DASY52	52.8.8.1222
Extrapolation	Advanced Extrapolation	
Phantom	Triple Flat Phantom 5.1C	
Distance Dipole Center - TSL	10 mm	with Spacer
Zoom Scan Resolution	dx, dy, dz = 5 mm	
Frequency	2600 MHz ± 1 MHz	

Head TSL parameters

The following parameters and calculations were applied.

	Temperature	Permittivity	Conductivity
Nominal Head TSL parameters	22.0 °C	39.0	1.96 mho/m
Measured Head TSL parameters	(22.0 ± 0.2) °C	39.9 ± 6 %	2.01 mho/m ± 8 %
Head TSL temperature change during test	<1.0 °C	---	---

SAR result with Head TSL

SAR averaged over 1 cm ³ (1 g) of Head TSL	Condition	
SAR measured	250 mW input power	14.6 mW / g
SAR for nominal Head TSL parameters	normalized to 1W	58.0 mW / g ± 20.8 % (k=2)
SAR averaged over 10 cm ³ (10 g) of Head TSL	Condition	
SAR measured	250 mW input power	6.40 mW / g
SAR for nominal Head TSL parameters	normalized to 1W	25.5 mW / g ± 20.4 % (k=2)

Body TSL parameters

The following parameters and calculations were applied.

	Temperature	Permittivity	Conductivity
Nominal Body TSL parameters	22.0 °C	52.5	2.16 mho/m
Measured Body TSL parameters	(22.0 ± 0.2) °C	52.7 ± 6 %	2.14 mho/m ± 8 %
Body TSL temperature change during test	<1.0 °C	---	---

SAR result with Body TSL

SAR averaged over 1 cm ³ (1 g) of Body TSL	Condition	
SAR measured	250 mW input power	14.2 mW / g
SAR for nominal Body TSL parameters	normalized to 1W	57.1 mW / g ± 20.8 % (k=2)
SAR averaged over 10 cm ³ (10 g) of Body TSL	Condition	
SAR measured	250 mW input power	6.33 mW / g
SAR for nominal Body TSL parameters	normalized to 1W	25.4 mW / g ± 20.4 % (k=2)



In Collaboration with
s p e a g
CALIBRATION LABORATORY

Add: No.51 Xueyuan Road, Haidian District, Beijing, 100191, China
Tel: +86-10-62304633-2079 Fax: +86-10-62304633-2504
E-mail: csl@chinattl.com Http://www.chinattl.cn

Appendix

Antenna Parameters with Head TSL

Impedance, transformed to feed point	48.5Ω- 3.48jΩ
Return Loss	- 28.3dB

Antenna Parameters with Body TSL

Impedance, transformed to feed point	45.9Ω- 3.13jΩ
Return Loss	- 25.4dB

General Antenna Parameters and Design

Electrical Delay (one direction)	1.253 ns
----------------------------------	----------

After long term use with 100W radiated power, only a slight warming of the dipole near the feedpoint can be measured.

The dipole is made of standard semirigid coaxial cable. The center conductor of the feeding line is directly connected to the second arm of the dipole. The antenna is therefore short-circuited for DC-signals. On some of the dipoles, small end caps are added to the dipole arms in order to improve matching when loaded according to the position as explained in the "Measurement Conditions" paragraph. The SAR data are not affected by this change. The overall dipole length is still according to the Standard. No excessive force must be applied to the dipole arms, because they might bend or the soldered connections near the feedpoint may be damaged.

Additional EUT Data

Manufactured by	SPEAG
-----------------	-------



In Collaboration with
s p e a q
CALIBRATION LABORATORY

Add: No.51 Xueyuan Road, Haidian District, Beijing, 100191, China
Tel: +86-10-62304633-2079 Fax: +86-10-62304633-2504
E-mail: cttl@chinattl.com Http://www.chinattl.cn

DASY5 Validation Report for Head TSL

Date: 10.30.2015

Test Laboratory: CTTL, Beijing, China

DUT: Dipole 2600 MHz; Type: D2600V2; Serial: D2600V2 - SN: 1031

Communication System: UID 0, CW; Frequency: 2600 MHz; Duty Cycle: 1:1

Medium parameters used: $f = 2600$ MHz; $\sigma = 2.014$ S/m; $\epsilon_r = 39.85$; $\rho = 1000$ kg/m³

Phantom section: Center Section

Measurement Standard: DASY5 (IEEE/IEC/ANSI C63.19-2007)

DASY5 Configuration:

- Probe: EX3DV4 - SN3617; ConvF(7.21, 7.21, 7.21); Calibrated: 8/26/2015;
- Sensor-Surface: 2mm (Mechanical Surface Detection)
- Electronics: DAE4 Sn777; Calibrated: 8/26/2015
- Phantom: Triple Flat Phantom 5.1C; Type: QD 000 P51 CA; Serial: 1161/1
- Measurement SW: DASY52, Version 52.8 (8); SEMCAD X Version 14.6.10 (7331)

Dipole Calibration/Zoom Scan (7x7x7) (7x7x7)/Cube 0; Measurement grid: dx=5mm, dy=5mm, dz=5mm

Reference Value = 106.9 V/m; Power Drift = 0.01 dB

Peak SAR (extrapolated) = 32.1 W/kg

SAR(1 g) = 14.6 W/kg; SAR(10 g) = 6.4 W/kg

Maximum value of SAR (measured) = 23.0 W/kg



0 dB = 23.0 W/kg = 13.62 dBW/kg



In Collaboration with
s p e a g
CALIBRATION LABORATORY

Add: No.51 Xueyuan Road, Haidian District, Beijing, 100191, China
Tel: +86-10-62304633-2079 Fax: +86-10-62304633-2504
E-mail: cntl@chinattl.com Http://www.chinattl.cn

Impedance Measurement Plot for Head TSL

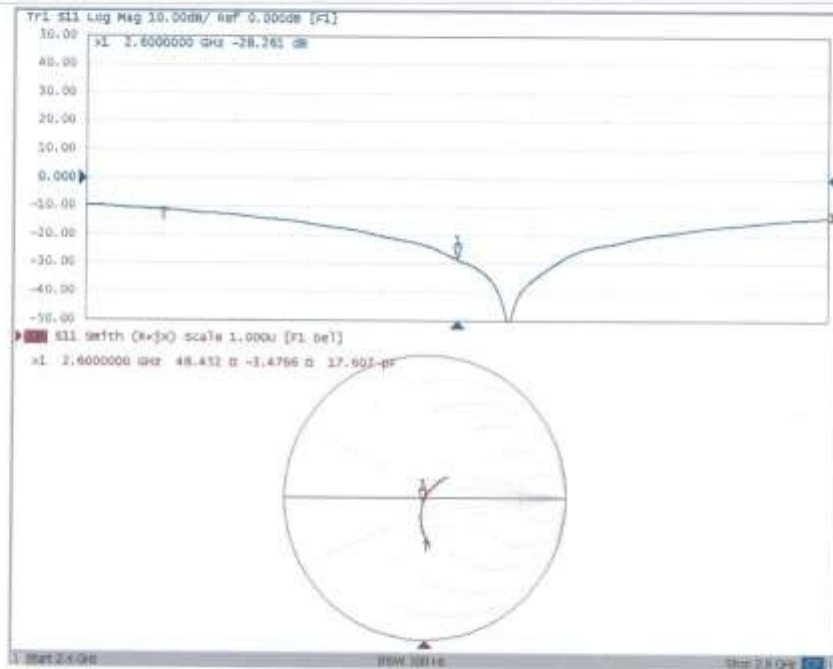



In Collaboration with
s p e a g
CALIBRATION LABORATORY

Add: No.51 Xueyuan Road, Haidian District, Beijing, 100191, China
Tel: +86-10-62304633-2079 Fax: +86-10-62304633-2504
E-mail: ctll@chinattl.com Http://www.chinattl.cn

DASY5 Validation Report for Body TSL

Date: 10.30.2015

Test Laboratory: CTTL, Beijing, China

DUT: Dipole 2600 MHz; Type: D2600V2; Serial: D2600V2 - SN: 1031

Communication System: UID 0, CW; Frequency: 2600 MHz; Duty Cycle: 1:1

Medium parameters used: $f = 2600$ MHz; $\sigma = 2.136$ S/m; $\epsilon_r = 52.7$; $\rho = 1000$ kg/m³

Phantom section: Left Section

Measurement Standard: DASY5 (IEEE/IEC/ANSI C63.19-2007)

DASY5 Configuration:

- Probe: EX3DV4 - SN3617; ConvF(7.2, 7.2, 7.2); Calibrated: 8/26/2015;
- Sensor-Surface: 2mm (Mechanical Surface Detection)
- Electronics: DAE4 Sn777; Calibrated: 8/26/2015
- Phantom: Triple Flat Phantom 5, IC; Type: QD 000 P51 CA; Serial: 1161/1
- Measurement SW: DASY52, Version 52.8 (8); SEMCAD X Version 14.6.10 (7331)

Dipole Calibration/Zoom Scan (7x7x7) (7x7x7)/Cube 0: Measurement grid: dx=5mm, dy=5mm, dz=5mm

Reference Value = 99.48 V/m; Power Drift = 0.03 dB

Peak SAR (extrapolated) = 30.4 W/kg

SAR(1 g) = 14.2 W/kg; SAR(10 g) = 6.33 W/kg

Maximum value of SAR (measured) = 22.2 W/kg

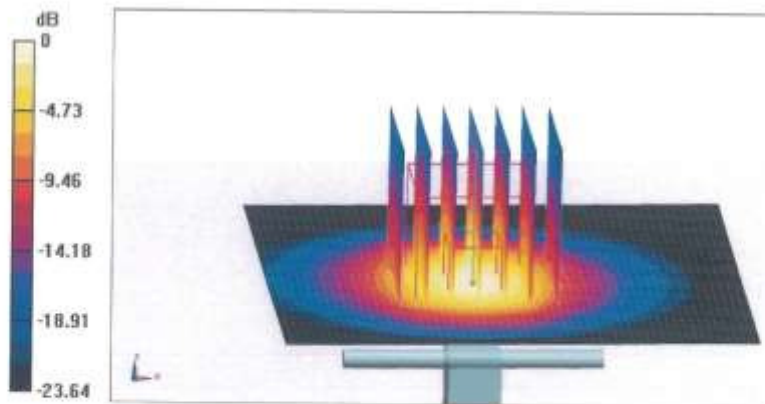

0 dB = 22.2 W/kg = 13.46 dBW/kg



In Collaboration with
s p e a g
CALIBRATION LABORATORY

Add: No.31 Xueyuan Road, Haidian District, Beijing, 100191, China
Tel: +86-10-62304633-2079 Fax: +86-10-62304633-2504
E-mail: cnt@chinattl.com Http://www.chinattl.cn

Impedance Measurement Plot for Body TSL

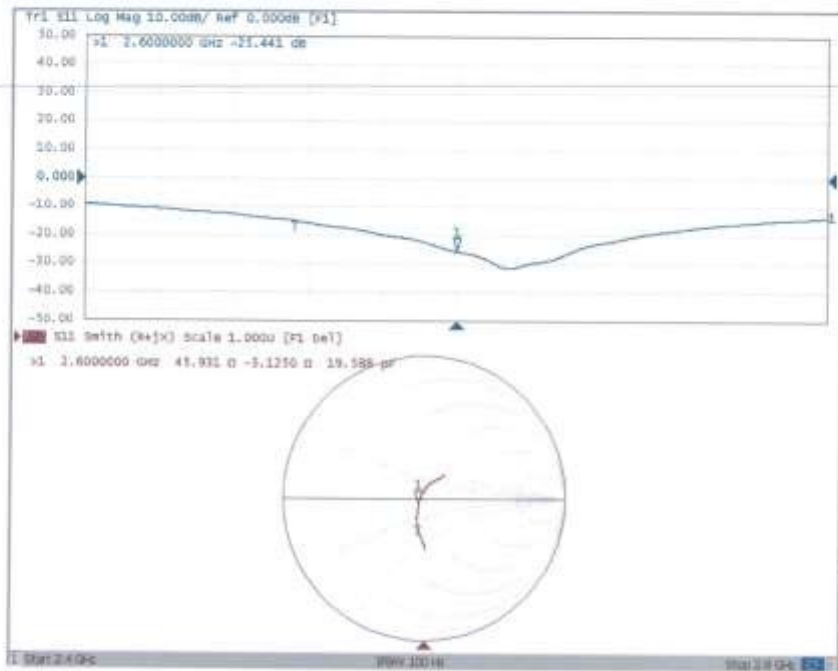

D2600V2,Serial No.1031 Extended Dipole Calibrations

Per IEEE Std 1528-2013,the dipole should have a return loss better than -20dB at the test frequency to reduce uncertainty in the power measurement.

Per KDB 865664 D01,if dipoles are verified in return loss(<-20dB,within 20% of prior calibration),and in impedance (within 5 ohm of prior calibration),the annual calibration is not necessary and the calibration interval can be extended.

Justification of the extended calibration

D2600V2 Serial No.1031						
2600 Head						
Date of Measurement	Return-Loss (dB)	Delta (%)	Real Impedance (ohm)	Delta (ohm)	Imaginary Impedance (ohm)	Delta (ohm)
10.30.2015	-28.261	--	48.452	--	-3.4766	--
10.29.2016	-26.029	7.89	44.630	3.822	-4.4265	0.950

D2600V2 Serial No.1031						
2600 Body						
Date of Measurement	Return-Loss (dB)	Delta (%)	Real Impedance (ohm)	Delta (ohm)	Imaginary Impedance (ohm)	Delta (ohm)
10.30.2015	-25.441	--	45.931	--	-3.125	--
10.29.2016	-25.582	0.54	48.845	2.914	-2.163	0.962

The return loss is < -20dB, within 20% of prior calibration; the impedance is within 5 ohm of prior calibration. Therefore the verification result should support extended calibration.

Dipole Verification Data D2600V2 Serial No.1031 2600MHz-Head

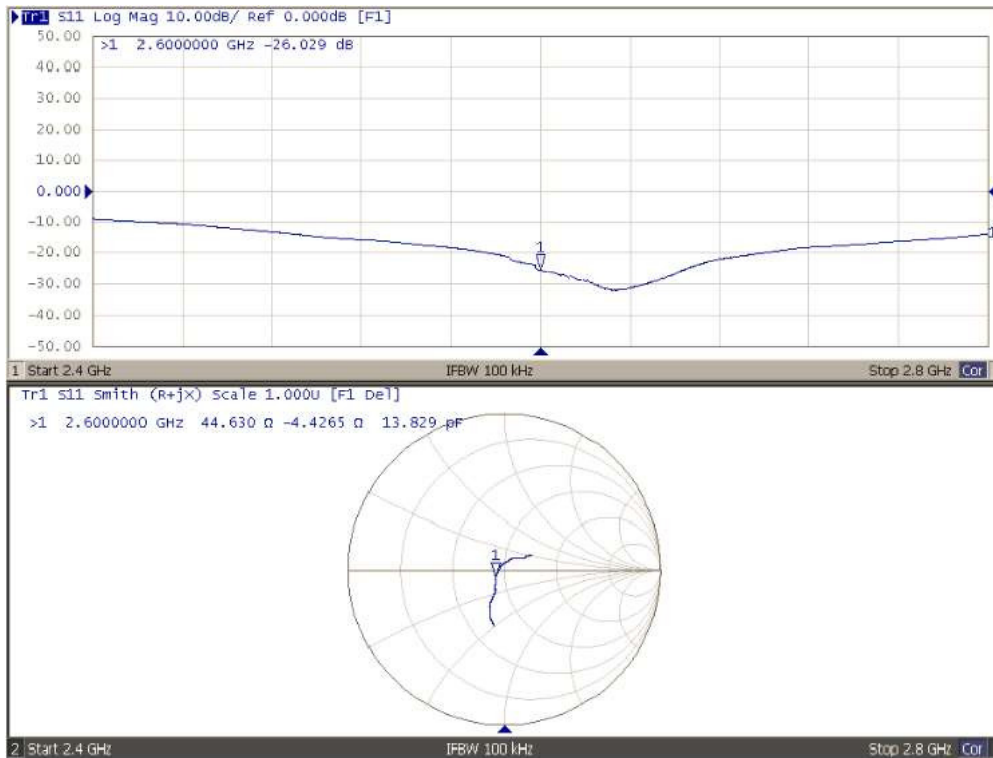

2600MHz - Body

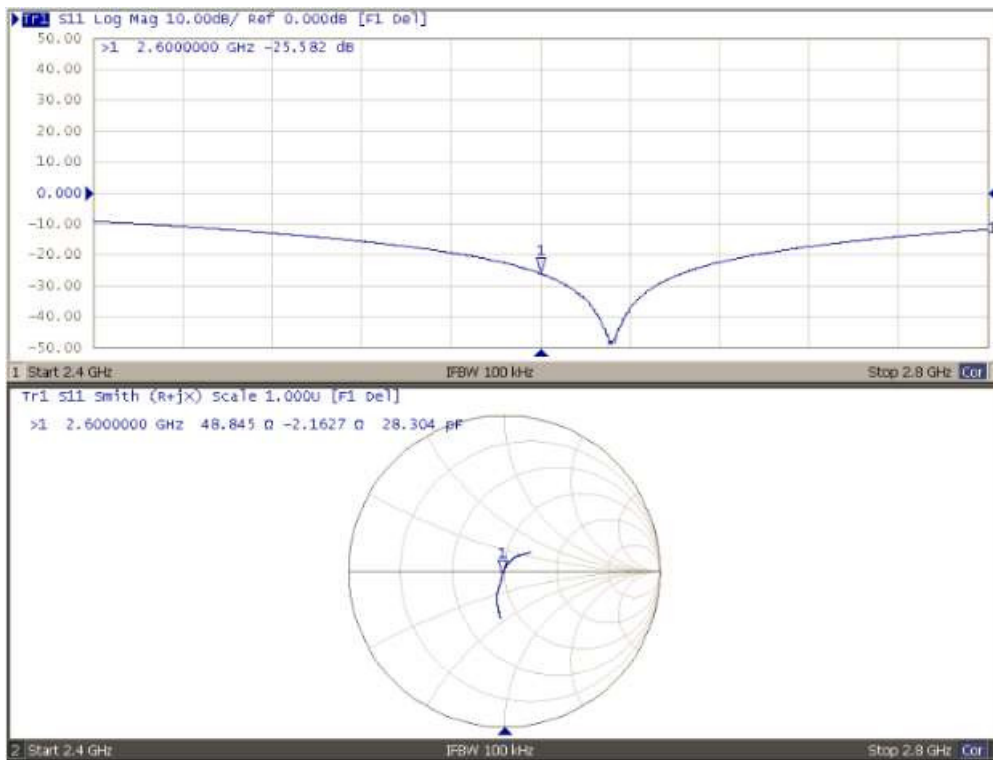

Justification of the extended calibration

D2600V2 Serial No.1031						
2600 Head						
Date of Measurement	Return-Loss (dB)	Delta (%)	Real Impedance (ohm)	Delta (ohm)	Imaginary Impedance (ohm)	Delta (ohm)
10.30.2015	-28.261	--	48.452	--	-3.4766	--
10.29.2016	-26.029	7.89	44.630	3.822	-4.4265	0.950
10.27.2017	-27.350	5.08	48.552	3.922	-3.976	0.451

D2600V2 Serial No.1031						
2600 Body						
Date of Measurement	Return-Loss (dB)	Delta (%)	Real Impedance (ohm)	Delta (ohm)	Imaginary Impedance (ohm)	Delta (ohm)
10.30.2015	-25.441	--	45.931	--	-3.125	--
10.29.2016	-25.582	0.54	48.845	2.914	-2.163	0.962
10.27.2017	-24.611	3.80	45.197	3.648	-2.881	0.718

The return loss is < -20dB, within 20% of prior calibration; the impedance is within 5 ohm of prior calibration. Therefore the verification result should support extended calibration.

Dipole Verification Data D2600V2 Serial No.1031 2600MHz-Head

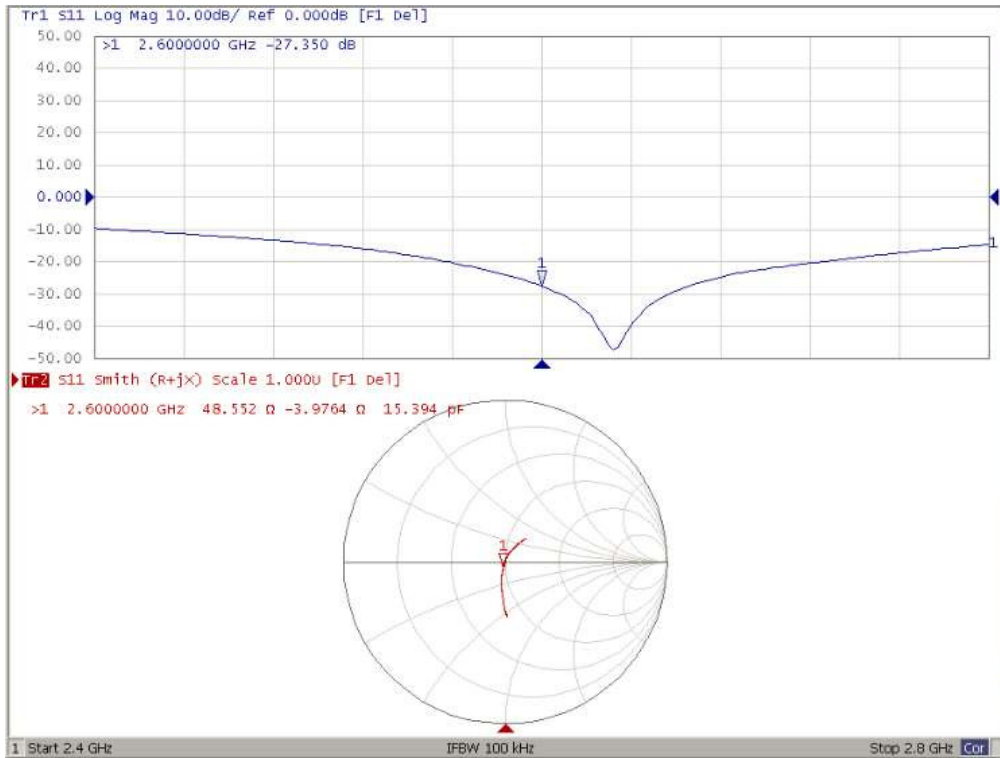

2600MHz - Body

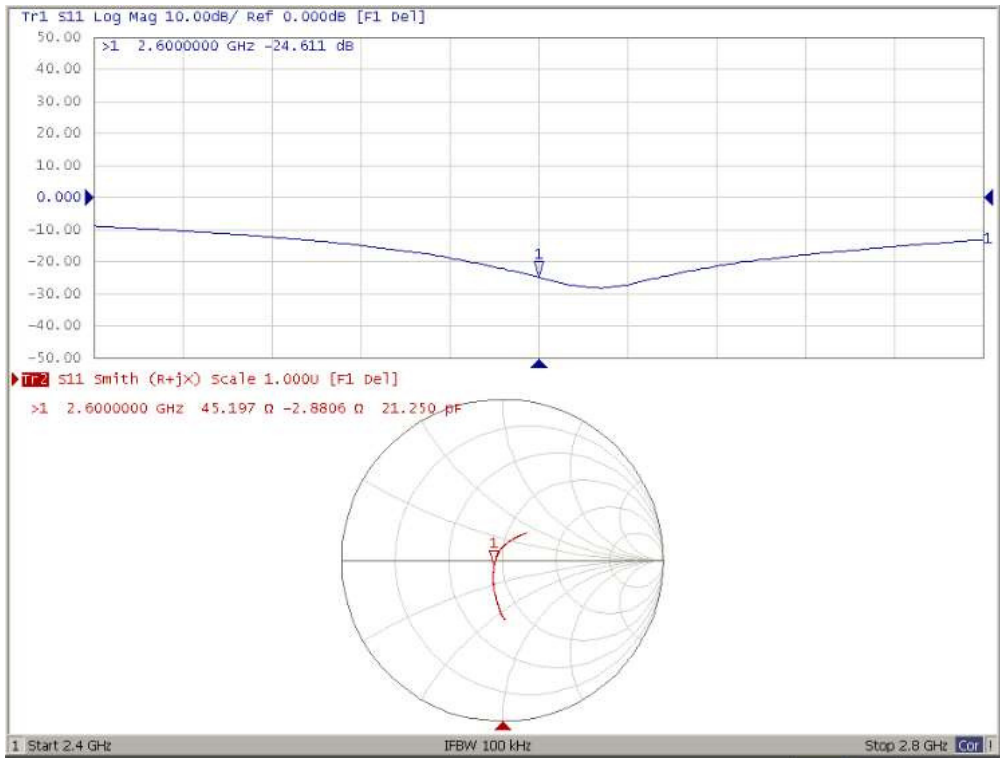

**Calibration Laboratory of
Schmid & Partner
Engineering AG**
Zeughausstrasse 43, 8004 Zurich, Switzerland



S Schweizerischer Kalibrierdienst
C Service suisse d'étalonnage
S Servizio svizzero di taratura
S Swiss Calibration Service

Accredited by the Swiss Accreditation Service (SAS)
The Swiss Accreditation Service is one of the signatories to the EA
Multilateral Agreement for the recognition of calibration certificates

Accreditation No.: SCS 0108

Client **TMC-CQ (Auden)**

Certificate No: **D5GHzV2-1121_Mar17**

CALIBRATION CERTIFICATE

Object: **D5GHzV2 - SN:1121**

Calibration procedure(s): **QA CAL-22.v2
Calibration procedure for dipole validation kits between 3-6 GHz**



Calibration date: **March 24, 2017**

This calibration certificate documents the traceability to national standards, which realize the physical units of measurements (SI).
The measurements and the uncertainties with confidence probability are given on the following pages and are part of the certificate.

All calibrations have been conducted in the closed laboratory facility: environment temperature (22 ± 3)°C and humidity < 70%.

Calibration Equipment used (M&TE critical for calibration)

Primary Standards	ID #	Cal Date (Certificate No.)	Scheduled Calibration
Power meter NRP	SN: 104778	06-Apr-16 (No. 217-02288/02289)	Apr-17
Power sensor NRP-Z91	SN: 103244	06-Apr-16 (No. 217-02288)	Apr-17
Power sensor NRP-Z91	SN: 103245	06-Apr-16 (No. 217-02289)	Apr-17
Reference 20 dB Attenuator	SN: 5056 (20k)	05-Apr-16 (No. 217-02292)	Apr-17
Type-N mismatch combination	SN: 5047.2 / 06327	05-Apr-16 (No. 217-02295)	Apr-17
Reference Probe EX3DV4	SN: 3503	31-Dec-16 (No. EX3-3503_Dec16)	Dec-17
DAE4	SN: 601	04-Jan-17 (No. DAE4-601_Jan17)	Jan-18
DAE4	SN: 660	07-Dec-16 (No. DAE4-601_Dec16)	Dec-17
Secondary Standards	ID #	Check Date (in house)	Scheduled Check
Power meter EPM-442A	SN: G837480704	07-Oct-15 (in house check Oct-16)	In house check: Oct-16
Power sensor HP 8481A	SN: US37292783	07-Oct-15 (in house check Oct-16)	In house check: Oct-16
Power sensor HP 8481A	SN: MY41092317	07-Oct-15 (in house check Oct-16)	In house check: Oct-16
RF generator R&S SMT-06	SN: 100972	15-Jun-15 (in house check Oct-16)	In house check: Oct-16
Network Analyzer HP 8753E	SN: US37390585	18-Oct-01 (in house check Oct-16)	In house check: Oct-17

Calibrated by:	Name Jeton Kastrati	Function Laboratory Technician	Signature 
Approved by:	Name Katja Pokovic	Technical Manager	

Issued: March 24, 2017

This calibration certificate shall not be reproduced except in full without written approval of the laboratory.

Calibration Laboratory of
Schmid & Partner
Engineering AG
Zeughausstrasse 43, 8004 Zurich, Switzerland



S Schweizerischer Kalibrierdienst
C Service suisse d'étalonnage
S Servizio svizzero di taratura
S Swiss Calibration Service

Accredited by the Swiss Accreditation Service (SAS)
The Swiss Accreditation Service is one of the signatories to the EA
Multilateral Agreement for the recognition of calibration certificates

Accreditation No.: **SCS 0108**

Glossary:

TSL	tissue simulating liquid
ConvF	sensitivity in TSL / NORM x,y,z
N/A	not applicable or not measured

Calibration is Performed According to the Following Standards:

- IEEE Std 1528-2013, "IEEE Recommended Practice for Determining the Peak Spatial-Averaged Specific Absorption Rate (SAR) in the Human Head from Wireless Communications Devices: Measurement Techniques", June 2013
- IEC 62209-2, "Procedure to determine the Specific Absorption Rate (SAR) for wireless communication devices used in close proximity to the human body (frequency range of 30 MHz to 6 GHz)", March 2010
- KDB 865664, "SAR Measurement Requirements for 100 MHz to 6 GHz"

Additional Documentation:

- DASY4/5 System Handbook

Methods Applied and Interpretation of Parameters:

- Measurement Conditions:** Further details are available from the Validation Report at the end of the certificate. All figures stated in the certificate are valid at the frequency indicated.
- Antenna Parameters with TSL:** The dipole is mounted with the spacer to position its feed point exactly below the center marking of the flat phantom section, with the arms oriented parallel to the body axis.
- Feed Point Impedance and Return Loss:** These parameters are measured with the dipole positioned under the liquid filled phantom. The impedance stated is transformed from the measurement at the SMA connector to the feed point. The Return Loss ensures low reflected power. No uncertainty required.
- Electrical Delay:** One-way delay between the SMA connector and the antenna feed point. No uncertainty required.
- SAR measured:** SAR measured at the stated antenna input power.
- SAR normalized:** SAR as measured, normalized to an input power of 1 W at the antenna connector.
- SAR for nominal TSL parameters:** The measured TSL parameters are used to calculate the nominal SAR result.

The reported uncertainty of measurement is stated as the standard uncertainty of measurement multiplied by the coverage factor $k=2$, which for a normal distribution corresponds to a coverage probability of approximately 95%.

Measurement Conditions

DASY system configuration, as far as not given on page 1.

DASY Version	DASY5	V52.8.8
Extrapolation	Advanced Extrapolation	
Phantom	Modular Flat Phantom V5.0	
Distance Dipole Center - TSL	10 mm	with Spacer
Zoom Scan Resolution	dx, dy = 4.0 mm, dz = 1.4 mm	Graded Ratio = 1.4 (Z direction)
Frequency	5200 MHz ± 1 MHz 5300 MHz ± 1 MHz 5500 MHz ± 1 MHz 5600 MHz ± 1 MHz 5800 MHz ± 1 MHz	

Head TSL parameters at 5200 MHz

The following parameters and calculations were applied.

	Temperature	Permittivity	Conductivity
Nominal Head TSL parameters	22.0 °C	36.0	4.66 mho/m
Measured Head TSL parameters	(22.0 ± 0.2) °C	35.0 ± 6 %	4.52 mho/m ± 6 %
Head TSL temperature change during test	< 0.5 °C	----	----

SAR result with Head TSL at 5200 MHz

SAR averaged over 1 cm ³ (1 g) of Head TSL	Condition	
SAR measured	100 mW input power	7.91 W/kg
SAR for nominal Head TSL parameters	normalized to 1W	78.6 W/kg ± 19.9 % (k=2)

SAR averaged over 10 cm ³ (10 g) of Head TSL	condition	
SAR measured	100 mW input power	2.26 W/kg
SAR for nominal Head TSL parameters	normalized to 1W	22.4 W/kg ± 19.5 % (k=2)

Head TSL parameters at 5300 MHz

The following parameters and calculations were applied.

	Temperature	Permittivity	Conductivity
Nominal Head TSL parameters	22.0 °C	35.9	4.75 mho/m
Measured Head TSL parameters	(22.0 ± 0.2) °C	34.8 ± 6 %	4.62 mho/m ± 6 %
Head TSL temperature change during test	< 0.5 °C	----	----

SAR result with Head TSL at 5300 MHz

SAR averaged over 1 cm ³ (1 g) of Head TSL	Condition	
SAR measured	100 mW input power	8.40 W/kg
SAR for nominal Head TSL parameters	normalized to 1W	83.4 W / kg ± 19.9 % (k=2)

SAR averaged over 10 cm ³ (10 g) of Head TSL	condition	
SAR measured	100 mW input power	2.41 W/kg
SAR for nominal Head TSL parameters	normalized to 1W	23.9 W/kg ± 19.5 % (k=2)

Head TSL parameters at 5500 MHz

The following parameters and calculations were applied.

	Temperature	Permittivity	Conductivity
Nominal Head TSL parameters	22.0 °C	35.6	4.96 mho/m
Measured Head TSL parameters	(22.0 ± 0.2) °C	34.5 ± 6 %	4.81 mho/m ± 6 %
Head TSL temperature change during test	< 0.5 °C	---	---

SAR result with Head TSL at 5500 MHz

SAR averaged over 1 cm ³ (1 g) of Head TSL	Condition	
SAR measured	100 mW input power	8.40 W/kg
SAR for nominal Head TSL parameters	normalized to 1W	83.4 W/kg ± 19.9 % (k=2)

SAR averaged over 10 cm ³ (10 g) of Head TSL	condition	
SAR measured	100 mW input power	2.38 W/kg
SAR for nominal Head TSL parameters	normalized to 1W	23.6 W/kg ± 19.5 % (k=2)

Head TSL parameters at 5600 MHz

The following parameters and calculations were applied.

	Temperature	Permittivity	Conductivity
Nominal Head TSL parameters	22.0 °C	35.5	5.07 mho/m
Measured Head TSL parameters	(22.0 ± 0.2) °C	34.4 ± 6 %	4.92 mho/m ± 6 %
Head TSL temperature change during test	< 0.5 °C	----	----

SAR result with Head TSL at 5600 MHz

SAR averaged over 1 cm ³ (1 g) of Head TSL	Condition	
SAR measured	100 mW input power	8.42 W/kg
SAR for nominal Head TSL parameters	normalized to 1W	83.6 W/kg ± 19.9 % (k=2)

SAR averaged over 10 cm ³ (10 g) of Head TSL	condition	
SAR measured	100 mW input power	2.40 W/kg
SAR for nominal Head TSL parameters	normalized to 1W	23.8 W/kg ± 19.5 % (k=2)

Head TSL parameters at 5800 MHz

The following parameters and calculations were applied.

	Temperature	Permittivity	Conductivity
Nominal Head TSL parameters	22.0 °C	35.3	5.27 mho/m
Measured Head TSL parameters	(22.0 ± 0.2) °C	34.1 ± 6 %	5.13 mho/m ± 6 %
Head TSL temperature change during test	< 0.5 °C	----	----

SAR result with Head TSL at 5800 MHz

SAR averaged over 1 cm ³ (1 g) of Head TSL	Condition	
SAR measured	100 mW input power	8.10 W/kg
SAR for nominal Head TSL parameters	normalized to 1W	80.3 W/kg ± 19.9 % (k=2)

SAR averaged over 10 cm ³ (10 g) of Head TSL	condition	
SAR measured	100 mW input power	2.30 W/kg
SAR for nominal Head TSL parameters	normalized to 1W	22.8 W/kg ± 19.5 % (k=2)

Body TSL parameters at 5200 MHz

The following parameters and calculations were applied.

	Temperature	Permittivity	Conductivity
Nominal Body TSL parameters	22.0 °C	49.0	5.30 mho/m
Measured Body TSL parameters	(22.0 ± 0.2) °C	48.2 ± 6 %	5.45 mho/m ± 6 %
Body TSL temperature change during test	< 0.5 °C	---	---

SAR result with Body TSL at 5200 MHz

SAR averaged over 1 cm ³ (1 g) of Body TSL	Condition	
SAR measured	100 mW input power	7.25 W/kg
SAR for nominal Body TSL parameters	normalized to 1W	72.3 W/kg ± 19.9 % (k=2)

SAR averaged over 10 cm ³ (10 g) of Body TSL	condition	
SAR measured	100 mW input power	2.03 W/kg
SAR for nominal Body TSL parameters	normalized to 1W	20.2 W/kg ± 19.5 % (k=2)

Body TSL parameters at 5300 MHz

The following parameters and calculations were applied.

	Temperature	Permittivity	Conductivity
Nominal Body TSL parameters	22.0 °C	48.9	5.42 mho/m
Measured Body TSL parameters	(22.0 ± 0.2) °C	48.0 ± 6 %	5.58 mho/m ± 6 %
Body TSL temperature change during test	< 0.5 °C	---	---

SAR result with Body TSL at 5300 MHz

SAR averaged over 1 cm ³ (1 g) of Body TSL	Condition	
SAR measured	100 mW input power	7.66 W/kg
SAR for nominal Body TSL parameters	normalized to 1W	76.4 W/kg ± 19.9 % (k=2)

SAR averaged over 10 cm ³ (10 g) of Body TSL	condition	
SAR measured	100 mW input power	2.14 W/kg
SAR for nominal Body TSL parameters	normalized to 1W	21.3 W/kg ± 19.5 % (k=2)

Body TSL parameters at 5500 MHz

The following parameters and calculations were applied.

	Temperature	Permittivity	Conductivity
Nominal Body TSL parameters	22.0 °C	48.6	5.65 mho/m
Measured Body TSL parameters	(22.0 ± 0.2) °C	47.7 ± 6 %	5.85 mho/m ± 6 %
Body TSL temperature change during test	< 0.5 °C	----	----

SAR result with Body TSL at 5500 MHz

SAR averaged over 1 cm ³ (1 g) of Body TSL	Condition	
SAR measured	100 mW input power	8.02 W/kg
SAR for nominal Body TSL parameters	normalized to 1W	80.0 W/kg ± 19.9 % (k=2)

SAR averaged over 10 cm ³ (10 g) of Body TSL	condition	
SAR measured	100 mW input power	2.23 W/kg
SAR for nominal Body TSL parameters	normalized to 1W	22.2 W/kg ± 19.5 % (k=2)

Body TSL parameters at 5600 MHz

The following parameters and calculations were applied.

	Temperature	Permittivity	Conductivity
Nominal Body TSL parameters	22.0 °C	48.5	5.77 mho/m
Measured Body TSL parameters	(22.0 ± 0.2) °C	47.5 ± 6 %	5.99 mho/m ± 6 %
Body TSL temperature change during test	< 0.5 °C	----	----

SAR result with Body TSL at 5600 MHz

SAR averaged over 1 cm ³ (1 g) of Body TSL	Condition	
SAR measured	100 mW input power	7.96 W/kg
SAR for nominal Body TSL parameters	normalized to 1W	79.4 W/kg ± 19.9 % (k=2)

SAR averaged over 10 cm ³ (10 g) of Body TSL	condition	
SAR measured	100 mW input power	2.24 W/kg
SAR for nominal Body TSL parameters	normalized to 1W	22.3 W/kg ± 19.5 % (k=2)

Body TSL parameters at 5800 MHz

The following parameters and calculations were applied.

	Temperature	Permittivity	Conductivity
Nominal Body TSL parameters	22.0 °C	48.2	6.00 mho/m
Measured Body TSL parameters	(22.0 ± 0.2) °C	47.2 ± 6 %	6.28 mho/m ± 6 %
Body TSL temperature change during test	< 0.5 °C	---	---

SAR result with Body TSL at 5800 MHz

SAR averaged over 1 cm ³ (1 g) of Body TSL	Condition	
SAR measured	100 mW input power	7.66 W/kg
SAR for nominal Body TSL parameters	normalized to 1W	76.4 W/kg ± 19.9 % (k=2)

SAR averaged over 10 cm ³ (10 g) of Body TSL	condition	
SAR measured	100 mW input power	2.13 W/kg
SAR for nominal Body TSL parameters	normalized to 1W	21.2 W/kg ± 19.5 % (k=2)

Appendix (Additional assessments outside the scope of SCS 0108)

Antenna Parameters with Head TSL at 5200 MHz

Impedance, transformed to feed point	50.0 Ω - 7.1 $\mu\Omega$
Return Loss	- 23.0 dB

Antenna Parameters with Head TSL at 5300 MHz

Impedance, transformed to feed point	48.9 Ω - 4.0 $\mu\Omega$
Return Loss	- 27.6 dB

Antenna Parameters with Head TSL at 5500 MHz

Impedance, transformed to feed point	51.8 Ω - 2.3 $\mu\Omega$
Return Loss	- 30.9 dB

Antenna Parameters with Head TSL at 5600 MHz

Impedance, transformed to feed point	54.0 Ω - 0.4 $\mu\Omega$
Return Loss	- 28.2 dB

Antenna Parameters with Head TSL at 5800 MHz

Impedance, transformed to feed point	55.8 Ω - 2.3 $\mu\Omega$
Return Loss	- 24.6 dB

Antenna Parameters with Body TSL at 5200 MHz

Impedance, transformed to feed point	50.5 Ω - 6.2 $\mu\Omega$
Return Loss	- 24.2 dB

Antenna Parameters with Body TSL at 5300 MHz

Impedance, transformed to feed point	49.6 Ω - 3.0 $\mu\Omega$
Return Loss	- 30.4 dB

Antenna Parameters with Body TSL at 5500 MHz

Impedance, transformed to feed point	52.3 Ω - 0.6 $\mu\Omega$
Return Loss	- 32.7 dB

Antenna Parameters with Body TSL at 5600 MHz

Impedance, transformed to feed point	56.3 Ω + 1.6 $j\Omega$
Return Loss	-24.3 dB

Antenna Parameters with Body TSL at 5800 MHz

Impedance, transformed to feed point	56.4 Ω - 1.8 $j\Omega$
Return Loss	-24.1 dB

General Antenna Parameters and Design

Electrical Delay (one direction)	1.203 ns
----------------------------------	----------

After long term use with 100W radiated power, only a slight warming of the dipole near the feedpoint can be measured.

The dipole is made of standard semirigid coaxial cable. The center conductor of the feeding line is directly connected to the second arm of the dipole. The antenna is therefore short-circuited for DC-signals. On some of the dipoles, small end caps are added to the dipole arms in order to improve matching when loaded according to the position as explained in the "Measurement Conditions" paragraph. The SAR data are not affected by this change. The overall dipole length is still according to the Standard.

No excessive force must be applied to the dipole arms, because they might bend or the soldered connections near the feedpoint may be damaged.

Additional EUT Data

Manufactured by	SPEAG
Manufactured on	September 08, 2011

DASY5 Validation Report for Head TSL

Date: 17.03.2017

Test Laboratory: SPEAG, Zurich, Switzerland

DUT: Dipole D5GHzV2; Type: D5GHzV2; Serial: D5GHzV2 - SN:1121

Communication System: UID 0 - CW; Frequency: 5200 MHz, Frequency: 5300 MHz, Frequency: 5500 MHz, Frequency: 5600 MHz, Frequency: 5800 MHz

Medium parameters used: $f = 5200$ MHz; $\sigma = 4.52$ S/m; $\epsilon_r = 35$; $\rho = 1000$ kg/m³,Medium parameters used: $f = 5300$ MHz; $\sigma = 4.62$ S/m; $\epsilon_r = 34.8$; $\rho = 1000$ kg/m³,Medium parameters used: $f = 5500$ MHz; $\sigma = 4.81$ S/m; $\epsilon_r = 34.5$; $\rho = 1000$ kg/m³,Medium parameters used: $f = 5600$ MHz; $\sigma = 4.92$ S/m; $\epsilon_r = 34.4$; $\rho = 1000$ kg/m³,Medium parameters used: $f = 5800$ MHz; $\sigma = 5.13$ S/m; $\epsilon_r = 34.1$; $\rho = 1000$ kg/m³

Phantom section: Flat Section

Measurement Standard: DASY5 (IEEE/IEC/ANSI C63.19-2011)

DASY52 Configuration:

- Probe: EX3DV4 - SN3503; ConvF(5.76, 5.76, 5.76); Calibrated: 31.12.2016, ConvF(5.35, 5.35, 5.35); Calibrated: 31.12.2016, ConvF(5.2, 5.2, 5.2); Calibrated: 31.12.2016, ConvF(5.09, 5.09, 5.09); Calibrated: 31.12.2016, ConvF(5.01, 5.01, 5.01); Calibrated: 31.12.2016;
- Sensor-Surface: 1.4mm (Mechanical Surface Detection)
- Electronics: DAE4 Sn601; Calibrated: 04.01.2017
- Phantom: Flat Phantom 5.0 (front); Type: QD 000 P50 AA; Serial: 1001
- DASY52 52.8.8(1258); SEMCAD X 14.6.10(7372)

Dipole Calibration for Head Tissue/Pin=100mW, dist=10mm, f=5200 MHz/Zoom Scan, dist=1.4mm (8x8x7)/Cube 0:

Measurement grid: dx=4mm, dy=4mm, dz=1.4mm

Reference Value = 72.36 V/m; Power Drift = -0.03 dB

Peak SAR (extrapolated) = 29.1 W/kg

SAR(1 g) = 7.91 W/kg; SAR(10 g) = 2.26 W/kg

Maximum value of SAR (measured) = 18.2 W/kg

Dipole Calibration for Head Tissue/Pin=100mW, dist=10mm, f=5300 MHz/Zoom Scan, dist=1.4mm (8x8x7)/Cube 0:

Measurement grid: dx=4mm, dy=4mm, dz=1.4mm

Reference Value = 74.73 V/m; Power Drift = -0.07 dB

Peak SAR (extrapolated) = 30.4 W/kg

SAR(1 g) = 8.4 W/kg; SAR(10 g) = 2.41 W/kg

Maximum value of SAR (measured) = 19.5 W/kg

Dipole Calibration for Head Tissue/Pin=100mW, dist=10mm, f=5500 MHz/Zoom Scan, dist=1.4mm (8x8x7)/Cube 0:

Measurement grid: dx=4mm, dy=4mm, dz=1.4mm

Reference Value = 73.51 V/m; Power Drift = -0.06 dB

Peak SAR (extrapolated) = 33.2 W/kg

SAR(1 g) = 8.4 W/kg; SAR(10 g) = 2.38 W/kg

Maximum value of SAR (measured) = 19.9 W/kg

Dipole Calibration for Head Tissue/Pin=100mW, dist=10mm, f=5600 MHz/Zoom Scan,

dist=1.4mm (8x8x7)/Cube 0: Measurement grid: dx=4mm, dy=4mm, dz=1.4mm

Reference Value = 73.79 V/m; Power Drift = -0.09 dB

Peak SAR (extrapolated) = 33.3 W/kg

SAR(1 g) = 8.42 W/kg; SAR(10 g) = 2.4 W/kg

Maximum value of SAR (measured) = 20.1 W/kg

Dipole Calibration for Head Tissue/Pin=100mW, dist=10mm, f=5800 MHz/Zoom Scan,

dist=1.4mm (8x8x7)/Cube 0: Measurement grid: dx=4mm, dy=4mm, dz=1.4mm

Reference Value = 71.38 V/m; Power Drift = -0.05 dB

Peak SAR (extrapolated) = 33.4 W/kg

SAR(1 g) = 8.1 W/kg; SAR(10 g) = 2.3 W/kg

Maximum value of SAR (measured) = 19.6 W/kg

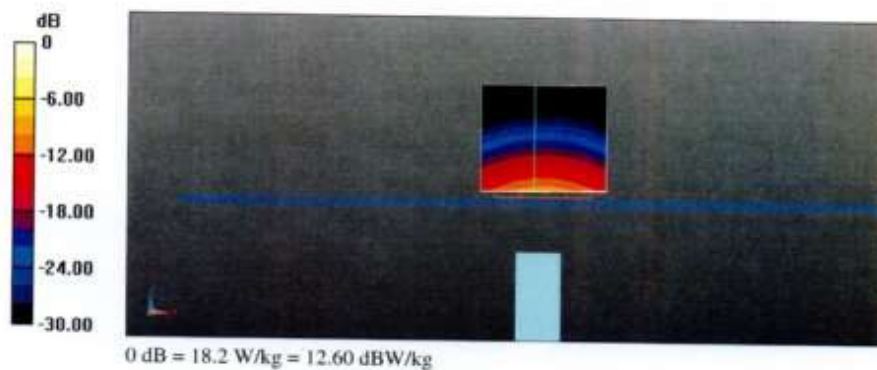

Impedance Measurement Plot for Head TSL

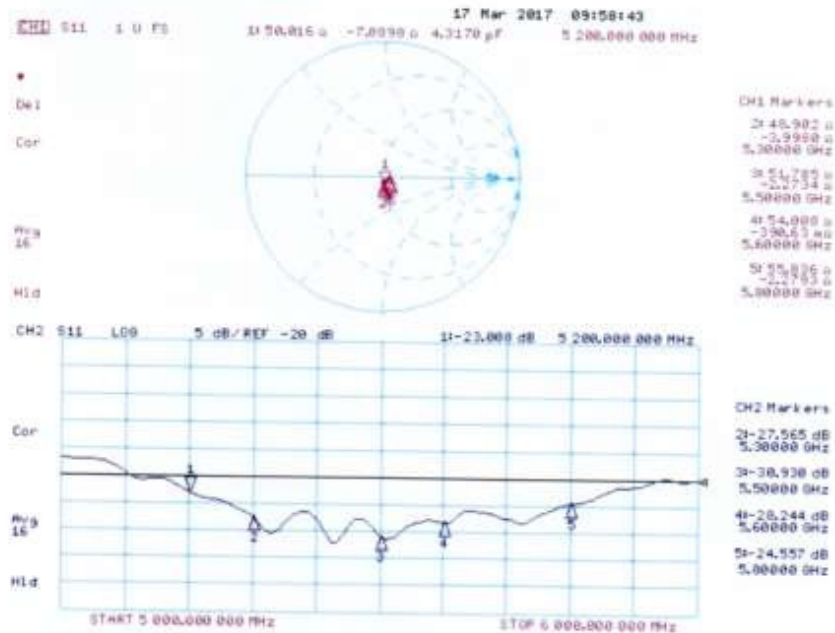

DASY5 Validation Report for Body TSL

Date: 24.03.2017

Test Laboratory: SPEAG, Zurich, Switzerland

DUT: Dipole D5GHzV2; Type: D5GHzV2; Serial: D5GHzV2 - SN:1121

Communication System: UID 0 - CW; Frequency: 5200 MHz, Frequency: 5300 MHz, Frequency: 5500 MHz, Frequency: 5600 MHz, Frequency: 5800 MHz

Medium parameters used: $f = 5200$ MHz; $\sigma = 5.45$ S/m; $\epsilon_r = 48.2$; $\rho = 1000$ kg/m³.Medium parameters used: $f = 5300$ MHz; $\sigma = 5.58$ S/m; $\epsilon_r = 48$; $\rho = 1000$ kg/m³.Medium parameters used: $f = 5500$ MHz; $\sigma = 5.85$ S/m; $\epsilon_r = 47.7$; $\rho = 1000$ kg/m³.Medium parameters used: $f = 5600$ MHz; $\sigma = 5.99$ S/m; $\epsilon_r = 47.5$; $\rho = 1000$ kg/m³.Medium parameters used: $f = 5800$ MHz; $\sigma = 6.28$ S/m; $\epsilon_r = 47.2$; $\rho = 1000$ kg/m³.

Phantom section: Flat Section

Measurement Standard: DASY5 (IEEE/IEC/ANSI C63.19-2011)

DASY52 Configuration:

- Probe: EX3DV4 - SN3503; ConvF(5.29, 5.29, 5.29); Calibrated: 31.12.2016, ConvF(5.04, 5.04, 5.04); Calibrated: 31.12.2016, ConvF(4.62, 4.62, 4.62); Calibrated: 31.12.2016, ConvF(4.57, 4.57, 4.57); Calibrated: 31.12.2016, ConvF(4.48, 4.48, 4.48); Calibrated: 31.12.2016;
- Sensor-Surface: 1.4mm (Mechanical Surface Detection)
- Electronics: DAE4 Sn660; Calibrated: 07.12.2016
- Phantom: Flat Phantom 5.0 (back); Type: QD 000 P50 AA; Serial: 1002
- DASY52 52.8.8(1258); SEMCAD X 14.6.10(7372)

Dipole Calibration for Body Tissue/Pin=100mW, dist=10mm, f=5200 MHz/Zoom Scan, dist=1.4mm (8x8x7)/Cube 0: Measurement grid: dx=4mm, dy=4mm, dz=1.4mm

Reference Value = 65.01 V/m; Power Drift = -0.05 dB

Peak SAR (extrapolated) = 28.2 W/kg

SAR(1 g) = 7.25 W/kg; SAR(10 g) = 2.03 W/kg

Maximum value of SAR (measured) = 17.1 W/kg

Dipole Calibration for Body Tissue/Pin=100mW, dist=10mm, f=5300 MHz/Zoom Scan, dist=1.4mm (8x8x7)/Cube 0: Measurement grid: dx=4mm, dy=4mm, dz=1.4mm

Reference Value = 66.88 V/m; Power Drift = -0.06 dB

Peak SAR (extrapolated) = 30.4 W/kg

SAR(1 g) = 7.66 W/kg; SAR(10 g) = 2.14 W/kg

Maximum value of SAR (measured) = 18.3 W/kg

Dipole Calibration for Body Tissue/Pin=100mW, dist=10mm, f=5500 MHz/Zoom Scan, dist=1.4mm (8x8x7)/Cube 0: Measurement grid: dx=4mm, dy=4mm, dz=1.4mm

Reference Value = 67.16 V/m; Power Drift = -0.06 dB

Peak SAR (extrapolated) = 33.8 W/kg

SAR(1 g) = 8.02 W/kg; SAR(10 g) = 2.23 W/kg

Maximum value of SAR (measured) = 19.4 W/kg

Dipole Calibration for Body Tissue/Pin=100mW, dist=10mm, f=5600 MHz/Zoom Scan, dist=1.4mm (8x8x7)/Cube 0: Measurement grid: dx=4mm, dy=4mm, dz=1.4mm
Reference Value = 66.44 V/m; Power Drift = -0.09 dB
Peak SAR (extrapolated) = 33.9 W/kg
SAR(1 g) = 7.96 W/kg; SAR(10 g) = 2.24 W/kg
Maximum value of SAR (measured) = 19.1 W/kg

Dipole Calibration for Body Tissue/Pin=100mW, dist=10mm, f=5800 MHz/Zoom Scan, dist=1.4mm (8x8x7)/Cube 0: Measurement grid: dx=4mm, dy=4mm, dz=1.4mm
Reference Value = 64.47 V/m; Power Drift = -0.07 dB
Peak SAR (extrapolated) = 34.8 W/kg
SAR(1 g) = 7.66 W/kg; SAR(10 g) = 2.13 W/kg
Maximum value of SAR (measured) = 19.1 W/kg

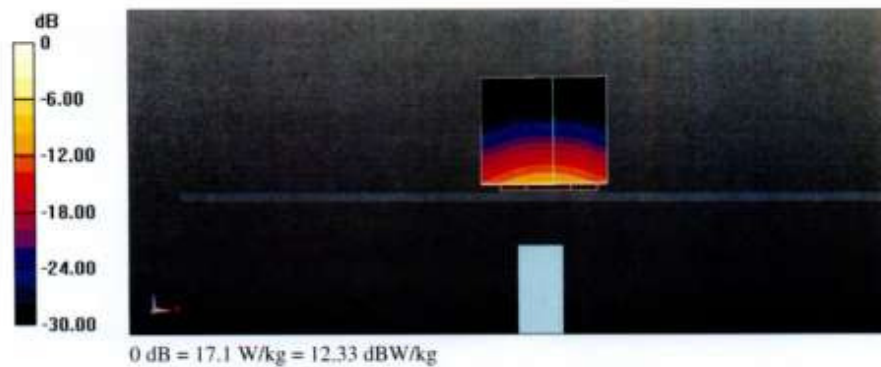

Impedance Measurement Plot for Body TSL

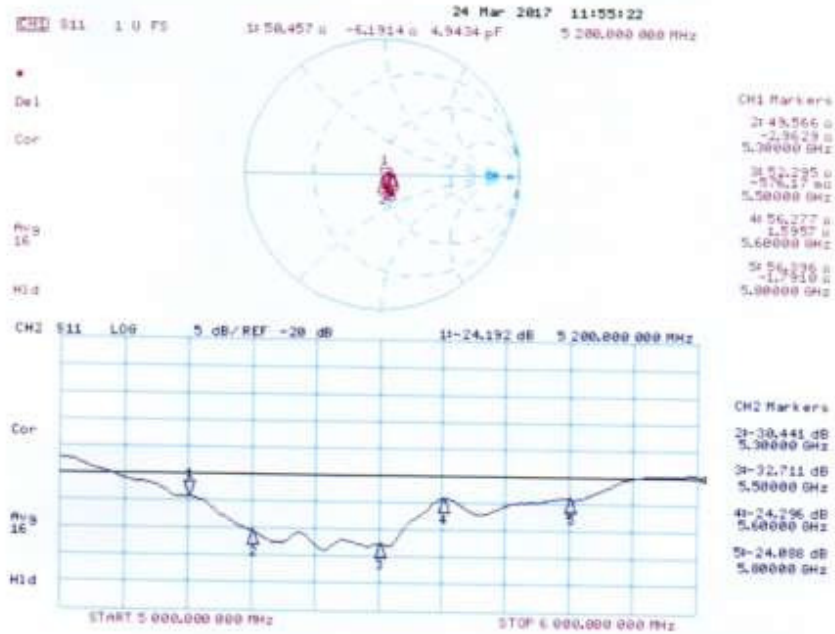



Acceptable Conditions for SAR Measurements Using Probes and Dipoles Calibrated under the SPEAG-TMC Dual-Logo Calibration Program to Support FCC Equipment Certification

The acceptable conditions for SAR measurements using probes, dipoles and DAEs calibrated by TMC (*Telecommunication Metrology Center of MITT in Beijing, China*), under the Dual-Logo Calibration Certificate program and quality assurance (QA) protocols established between SPEAG (*Schmid & Partner Engineering AG, Switzerland*) and TMC, to support FCC (*U.S. Federal Communications Commission*) equipment certification are defined and described in the following.

- 1) The agreement established between SPEAG and TMC is only applicable to calibration services performed by TMC where its clients (companies and divisions of such companies) are headquartered in the Greater China Region, including Taiwan and Hong Kong. This agreement is subject to renewal at the end of each calendar year between SPEAG and TMC. TMC shall inform the FCC of any changes or early termination to the agreement.
- 2) Only a subset of the calibration services specified in the SPEAG-TMC agreement, while it remains valid, are applicable to SAR measurements performed using such equipment for supporting FCC equipment certification. These are identified in the following.
 - a) Calibration of dosimetric (SAR) probes EX3DVx, ET3DVx and ES3DVx.
 - i) Free-space E-field and H-field probes, including those used for HAC (hearing aid compatibility) evaluation, temperature probes, other probes or equipment not identified in this document, when calibrated by TMC, are excluded and cannot be used for measurements to support FCC equipment certification.
 - ii) Signal specific and bundled probe calibrations based on PMR (probe modulation response) characteristics are handled according to the requirements of KDB 865664; that is, "Until standardized procedures are available to make such determination, the applicability of a signal specific probe calibration for testing specific wireless modes and technologies is determined on a case-by-case basis through KDB inquiries, including SAR system verification requirements."
 - b) Calibration of SAR system validation dipoles, excluding HAC dipoles.
 - c) Calibration of data acquisition electronics DAE3Vx, DAE4Vx and DAEasyVx.
 - d) For FCC equipment certification purposes, the frequency range of SAR probe and dipole calibrations is limited to 700 MHz - 6 GHz and provided it is supported by the equipment identified in the TMC QA protocol (a separate attachment to this document).
 - e) The identical system and equipment setup, measurement configurations, hardware, evaluation algorithms, calibration and QA protocols, including the format of calibration certificates and reports used by SPEAG shall be applied by TMC.
 - f) The calibrated items are only applicable to SPEAG DASY 4 and DASY 5 or higher version systems.

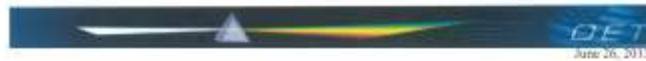

- 3) The SPEAG-TMC agreement includes specific protocols identified in the following to ensure the quality of calibration services provided by TMC under this SPEAG-TMC Dual-Logo calibration agreement are equivalent to the calibration services provided by SPEAG. TMC shall, upon request, provide copies of documentation to the FCC to substantiate program implementation.
 - a) The Inter-laboratory Calibration Evaluation (ILCE) stated in the TMC QA protocol shall be performed between SPEAG and TMC at least once every 12 months. The ILCE acceptance criteria defined in the TMC QA protocol shall be satisfied for the TMC, SPEAG and FCC agreements to remain valid.
 - b) Check of Calibration Certificate (CCC) shall be performed by SPEAG for all calibrations performed by TMC. Written confirmation from SPEAG is required for TMC to issue calibration certificates under the SPEAG-TMC Dual-Logo calibration program. Quarterly reports for all calibrations performed by TMC under the program are also issued by SPEAG.
 - c) The calibration equipment and measurement system used by TMC shall be verified before each calibration service according to the specific reference SAR probes, dipoles, and DAE calibrated by SPEAG. The results shall be reproducible and within the defined acceptance criteria specified in the TMC QA protocol before each actual calibration can commence. TMC shall maintain records of the measurement and calibration system verification results for all calibrations.
 - d) Quality Check of Calibration (QCC) certificates shall be performed by SPEAG at least once every 12 months. SPEAG shall visit TMC facilities to verify the laboratory, equipment, applied procedures and plausibility of randomly selected certificates.
- 4) A copy of this document, to be updated annually, shall be provided to TMC clients that accept calibration services according to the SPEAG-TMC Dual-Logo calibration program, which should be presented to a TCB (*Telecommunication Certification Body*), to facilitate FCC equipment approval.
- 5) TMC shall address any questions raised by its clients or TCBs relating to the SPEAG-TMC Dual-Logo calibration program and inform the FCC and SPEAG of any critical issues.

Change Note: Revised on June 26 to clarify the applicability of PMR and Bundled probe calibrations according to the requirements of KDB 865664.

ANNEX H. Accreditation Certificate



Accredited Laboratory

A2LA has accredited

EAST CHINA INSTITUTE OF TELECOMMUNICATIONS
Shanghai, People's Republic of China

for technical competence in the field of
Electrical Testing

This laboratory is accredited in accordance with the recognized International Standard ISO/IEC 17025:2005 *General requirements for the competence of testing and calibration laboratories*. This accreditation demonstrates technical competence for a defined scope and the operation of a laboratory quality management system (refer to joint ISO-ILAC-IAF Communiqué dated 8 January 2009).



Presented this 15th day of March 2017.



President and CEO
For the Accreditation Council
Certificate Number 3682.01
Valid to February 28, 2019

For the tests to which this accreditation applies, please refer to the laboratory's Electrical Scope of Accreditation.

*******END OF REPORT*******