

FCC Test Report (PART 22)

Report No.: RF160504W010-3

FCC ID: 2ADOBF20

Test Model: Hisense F20

Received Date: May 04, 2016

Test Date: May 05, 2016 ~ Jun. 02, 2016

Issued Date: Jun. 03, 2016

Applicant: Hisense International Co., Ltd.

Address: Floor 22, Hisense Tower, 17 Donghai Xi Road, Qingdao,
266071, China

Issued By: Bureau Veritas Consumer Products Services (H.K.) Ltd.,
Taoyuan Branch

Lab Address: No. 47-2, 14th Ling, Chia Cau Vil., Lin Kou Dist., New Taipei
City, Taiwan (R.O.C.)

Test Location: No. 19, Hwa Ya 2nd Rd., Wen Hwa Tsuen, Kwei Shan Hsiang,
Taoyuan Hsien 333, Taiwan, R.O.C.

This report should not be used by the client to claim product certification, approval, or endorsement by TAF or any government agencies.



This report is for your exclusive use. Any copying or replication of this report to or for any other person or entity, or use of our name or trademark, is permitted only with our prior written permission. This report sets forth our findings solely with respect to the test samples identified herein. The results set forth in this report are not indicative or representative of the quality or characteristics of the lot from which a test sample was taken or any similar or identical product specifically and expressly noted. Our report includes all of the tests requested by you and the results thereof based upon the information that you provided to us. You have 60 days from date of issuance of this report to notify us of any material error or omission caused by our negligence, provided, however, that such notice shall be in writing and shall specifically address the issue you wish to raise. A failure to raise such issue within the prescribed time shall constitute your unqualified acceptance of the completeness of this report, the tests conducted and the correctness of the report contents. Unless specific mention, the uncertainty of measurement has been explicitly taken into account to declare the compliance or non-compliance to the specification. The report must not be used by the client to claim product certification, approval, or endorsement by TAF or any government agencies

TABLE OF CONTENTS

RELEASE CONTROL RECORD 3

1 Certificate of Conformity..... 4

2 Summary of Test Results 5

 2.1 Measurement Uncertainty 5

 2.2 Test Site And Instruments 5

3 General Information..... 7

 3.1 General Description of EUT 7

 3.2 Configuration Of System Under Test..... 9

 3.2.1 Description Of Support Units 9

 3.3 Test Mode Applicability and Tested Channel Detail 10

 3.4 EUT Operating Conditions 13

 3.5 General Description of Applied Standards 13

4 Test Types and Results 14

 4.1 Output Power Measurement 14

 4.1.1 Limits of Output Power Measurement 14

 4.1.2 Test Procedures..... 14

 4.1.3 Test Setup..... 15

 4.1.4 Test Results 16

 4.2 Frequency Stability Measurement..... 23

 4.2.1 Limits of Frequency Stabiliity Measurement..... 23

 4.2.2 Test Procedure 23

 4.2.3 Test Setup..... 23

 4.2.4 Test Results 23

 4.3 Occupied Bandwidth Measurement 25

 4.3.1 Test Procedure 25

 4.3.2 Test Setup..... 25

 4.3.3 Test Result..... 26

 4.4 Band Edge Measurement 32

 4.4.1 Limits of Band Edge Measurement 32

 4.4.2 Test Setup..... 32

 4.4.3 Test Procedures..... 32

 4.4.4 Test Results 33

 4.5 Peak To Average Ratio..... 38

 4.5.1 Limits of Peak To Average Ratio Measurement 38

 4.5.2 Test Setup..... 38

 4.5.3 Test Procedures..... 38

 4.5.4 Test Results 39

 4.6 Conducted Spurious Emissions 42

 4.6.1 Limits of Conducted Spurious Emissions Measurement..... 42

 4.6.2 Test Setup..... 42

 4.6.3 Test Procedure 42

 4.6.4 Test Results 43

 4.7 Radiated Emission Measurement 47

 4.7.1 Limits of Radiated Emission Measurement..... 47

 4.7.2 Test Procedure 47

 4.7.3 Deviation from Test Standard 47

 4.7.4 Test Setup..... 48

 4.7.5 Test Results 49

5 Pictures of Test Arrangements..... 65

Appendix – Information on the Testing Laboratories 66



A D T

RELEASE CONTROL RECORD

Issue No.	Description	Date Issued
RF160517W010-3	Original release	Jun. 03, 2016

1 Certificate of Conformity

Product: Mobile phone

Brand: Hisense

Test Model: Hisense F20

Sample Status: Identical Prototype

Applicant: Hisense International Co., Ltd.

Test Date: May 05, 2016 ~ Jun. 02, 2016

Standards: FCC Part 22, Subpart H

The above equipment has been tested by **Bureau Veritas Consumer Products Services (H.K.) Ltd., Taoyuan Branch**, and found compliance with the requirement of the above standards. The test record, data evaluation & Equipment Under Test (EUT) configurations represented herein are true and accurate accounts of the measurements of the sample's EMC characteristics under the conditions specified in this report.

Prepared by :  _____, **Date:** Jun. 03, 2016

Amyee Qian / Engineer

Approved by :  _____, **Date:** Jun. 03, 2016

William Chung / Manager

2 Summary of Test Results

Applied Standard: FCC Part 22 & Part 2			
FCC Clause	Test Item	Result	Remarks
2.1046 22.913 (a)	Effective radiated power	PASS	Meet the requirement of limit.
---	Peak To Average Ratio	PASS	Meet the requirement of limit.
2.1055 22.355	Frequency Stability	PASS	Meet the requirement of limit.
2.1049 22.917b	Occupied Bandwidth	PASS	Meet the requirement of limit.
22.917	Band Edge Measurements	PASS	Meet the requirement of limit.
2.1051 22.917	Conducted Spurious Emissions	PASS	Meet the requirement of limit.
2.1053 22.917	Radiated Spurious Emissions	PASS	Meet the requirement of limit. Minimum passing margin is -17.36dB at 42.61MHz.

2.1 Measurement Uncertainty

Where relevant, the following measurement uncertainty levels have been estimated for tests performed on the EUT as specified in CISPR 16-4-2:

Measurement	Frequency	Expanded Uncertainty (k=2) (±)
Conducted Emissions at mains ports	150kHz ~ 30MHz	2.44 dB
Radiated Emissions up to 1 GHz	30MHz ~ 200MHz	2.93 dB
	200MHz ~ 1000MHz	2.95 dB
Radiated Emissions above 1 GHz	1GHz ~ 18GHz	2.26 dB
	18GHz ~ 40GHz	1.94 dB

This uncertainty represents an expanded uncertainty expressed at approximately the 95% confidence level using a coverage factor of k=2.

2.2 Test Site And Instruments

Equipment	Manufacturer	Model No.	Serial No.	Last Cal.	Next Cal.
EMI Test Receiver	Rohde&Schwarz	ESR7	101494	Apr. 05,16	Apr. 04,17
Signal and Spectrum Analyzer	Rohde&Schwarz	FSV40	101094	Apr. 05,16	Apr. 04,17
Bilog Antenna 1	Teseq	CBL 6111D	30643	Jun. 25,15	Jun. 24,16
Bilog Antenna 2	Teseq	CBL 6111D	27089	Jun. 25,15	Jun. 24,16
Horn Antenna	ETS-Lindgren	3117	00062558	May 30,14	May 29,17
Horn Antenna (15GHz-40GHz)	SCHWARZBECK	BBHA 9170	BBHA9170147	Jan. 21,14	Jan. 20,17
Amplifier	Burgeon	BPA-530	100220	Apr. 05,16	Apr. 04,17
Pre-Amplifier	HP	8449B	3008A00409	Apr. 24,16	Apr. 23,17
Pre-Amplifier (18GHz-40GHz)	EMCI	EMC 184045	980102	Nov. 11,15	Nov. 10,16
GPS Generator+ Antenna	TOJOIN	GNSS-5000A	E1-010119	Aug. 08, 14	Aug. 07, 16
3m Semi-anechoic Chamber	ETS-LINDGREN	9m*6m*6m	NSEMC003	Mar. 12,16	Mar. 11,18
Test Software	ADT	ADT_Radiated_V7.6.15.9.2	N/A	N/A	N/A
Power Meter	Anritsu	ML2495A	1139001	Feb.19,16	Feb. 18,17
Power Sensor	Anritsu	MA2411B	1126068	Feb.19,16	Feb. 18,17
Power Sensor	Keysight	U2021XA	MY55060016	May 27,15	May 26,17
Power Sensor	Keysight	U2021XA	MY55060018	May 27,15	May 26,17
Digital Multimeter	FLUKE	15B	A1220010DG	Oct. 12, 15	Oct. 11, 16
Humid & Temp Programmable Tester	Haida	HD-2257	110807201	Sep.07,15	Sep. 06,16
Oscilloscope	Agilent	DSO9254A	MY51260160	Nov. 09,15	Nov. 08,16
Signal Analyzer	Rohde & Schwarz	FSV7	102331	Nov. 09,15	Nov. 08,16
Signal Generator	Agilent	N5183A	MY50140980	Apr. 21, 16	Apr. 20, 17
ESG Vector Signal Generator	Agilent	E4438C	MY49072505	Sep. 01,15	Aug. 31,16
BLUETOOTH TESTER	Rohde&Schwarz	CBT32	100811	Oct. 12, 15	Oct. 11, 16

NOTE: 1. The calibration interval of the above test instruments is 12 months and the calibrations are traceable to NML/ROC and NIST/USA.

2. The calibration interval of the loop antenna is 24 months and the calibrations are traceable to NML/ROC and NIST/USA.

3. The test was performed in HwaYa Chamber 4.

4. The horn antenna and HP preamplifier (model: 8449B) are used only for the measurement of emission frequency above 1GHz if tested.

5. The FCC Site Registration No. is 460141.

6. The IC Site Registration No. is IC7450F-4.

3 General Information

3.1 General Description of EUT

PRODUCT	Mobile phone	
BRAND	Hisense	
MODEL NAME	Hisense F20	
POWER SUPPLY	5.0Vdc (adapter or host equipment) 3.8Vdc (battery)	
MODULATION TYPE	GSM/GPRS	GMSK
	EDGE	GMSK, 8PSK
	WCDMA	BPSK
	LTE	QPSK, 16QAM
FREQUENCY RANGE	GSM/GPRS/EDGE	824.2MHz ~ 848.8MHz
	WCDMA	826.4MHz ~ 846.6MHz
	LTE Band 5 (Channel Bandwidth: 1.4MHz)	824.7MHz ~ 848.3MHz
	LTE Band 5 (Channel Bandwidth: 3MHz)	825.5MHz ~ 847.5MHz
	LTE Band 5 (Channel Bandwidth: 5MHz)	826.5MHz ~ 846.5MHz
	LTE Band 5 (Channel Bandwidth: 10MHz)	829MHz ~ 844MHz
MAX. ERP POWER	GSM	503mW
	EDGE	137mW
	WCDMA	24mW
	LTE Band 5 (Channel Bandwidth: 1.4MHz)	223mW
	LTE Band 5 (Channel Bandwidth: 3MHz)	227mW
	LTE Band 5 (Channel Bandwidth: 5MHz)	225mW
	LTE Band 5 (Channel Bandwidth: 10MHz)	190mW
EMISSION DESIGNATOR	GSM	247KGXW
	EDGE	243KG7W
	WCDMA	4M15F9W
	LTE Band 5 (Channel Bandwidth: 1.4MHz)	QPSK: 1M09G7D
		16QAM: 1M09W7D
	LTE Band 5 (Channel Bandwidth: 3MHz)	QPSK: 2M69G7D
		16QAM: 2M69W7D
	LTE Band 5 (Channel Bandwidth: 5MHz)	QPSK: 4M48G7D
16QAM: 4M48W7D		
LTE Band 5 (Channel Bandwidth: 10MHz)	QPSK: 8M96G7D	
	16QAM: 8M94W7D	
ANTENNA TYPE	Fixed Internal antenna with 0.6dBi gain	
HW VERSION	V1.0	

SW VERSION	L1259.6.01.00.MX05
ACCESSORY DEVICE	Refer to note as below
DATA CABLE	USB cable: shielded, detachable, 0.8 m Earphone cable: Unshielded, detachable, 0.8 m

Note:

1. The above EUT information is declared by manufacturer and for more detailed features description, please refer to the manufacturer's specifications or User's Manual.
2. The EUT was powered by the following adapter:

ADAPTER	
BRAND:	Hisense
MODEL:	A31-501000
INPUT:	AC 100-240V, 150mA
OUTPUT:	DC 5V, 1000mA

3. The EUT matched the following USB Cable and Earphone.

USB CABLE	
BRAND:	SHENZHEN FKY-QY HARDWARE ELECTRONIC CO.,LTD
MODEL:	FKYM1-2828L08BKR/FKYM1-2828L08WHR
SIGNAL LINE:	0.8 METER

EARPHONE	
BRAND:	NEW LEADER
MODEL:	NLD-EM116T-055S NLD-EM116T-056S
SIGNAL LINE:	0.8 METER

4. For the test results, the EUT had been tested with all conditions. But only the worst case was shown in test report.

3.2 Configuration of System Under Test

FOR RADIATION EMISSION TEST

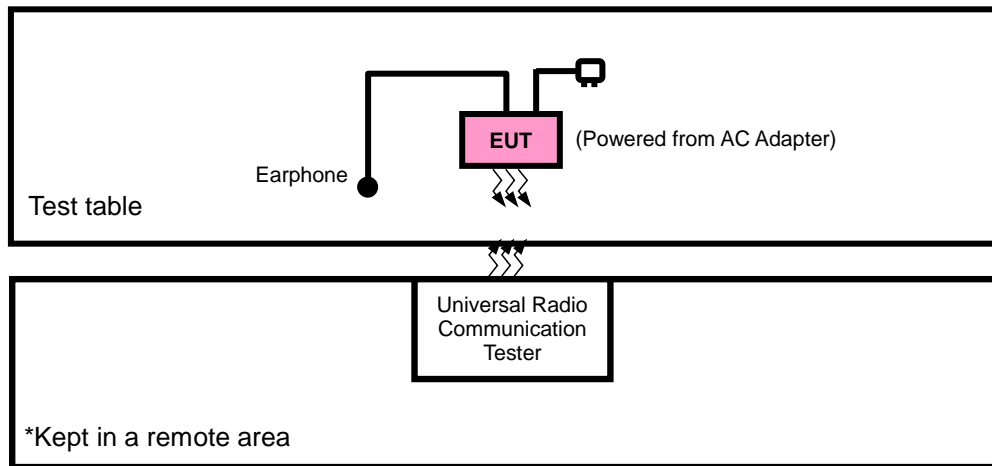

FOR E.R.P. TEST

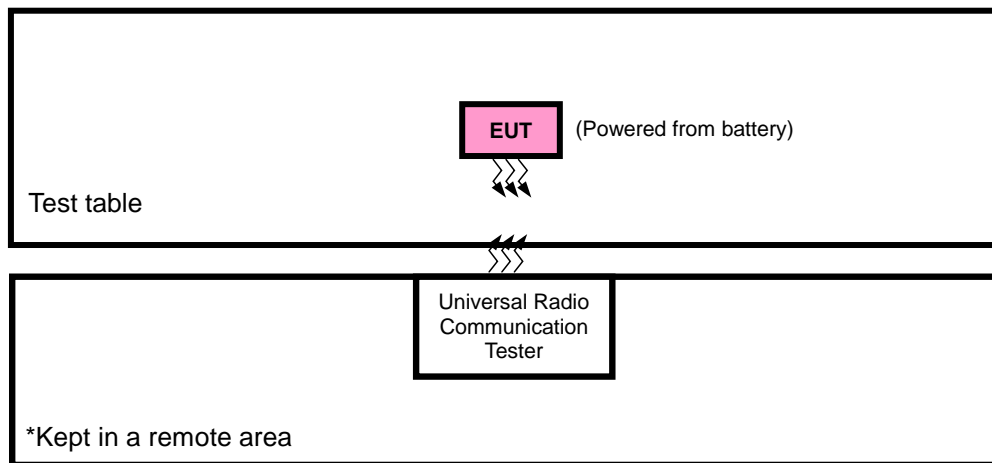

3.2.1 Description Of Support Units

The EUT has been tested as an independent unit together with other necessary accessories or support units. The following support units or accessories were used to form a representative test configuration during the tests.

NO.	PRODUCT	BRAND	MODEL NO.	SERIAL NO.	FCC ID
1	DC source	LONG WEI	PS-6403D	010934269	N/A
2	PC	HP	A6608CN	3CR83825X3	N/A

NO.	SIGNAL CABLE DESCRIPTION OF THE ABOVE SUPPORT UNITS
1	DC Line: Unshielded, Detachable 1.0m
2	AC Line: Unshielded, Detachable 1.5m

NOTE:

1. All power cords of the above support units are non shielded (1.8m).

3.3 Test Mode Applicability and Tested Channel Detail

Pre-Scan has been conducted to determine the worst-case mode from all possible combinations between available modulations, data rates, XYZ axis and antenna ports
 The worst case was found when positioned on Z-plane. Following channel(s) was (were) selected for the final test as listed below:

Test results are presented in the report as below.

Test Mode	Test Condition
A	Power from adapter
B	Power from battery

GSM MODE

EUT Configure Mode	Test Item	Available Channel	Tested Channel	Mode
A	ERP	128 to 251	128, 190, 251	GSM
B	Frequency Stability	128 to 251	190	GSM
A	Occupied Bandwidth	128 to 251	128, 190, 251	GSM, EDGE
A	Band Edge	128 to 251	128, 251	GSM, EDGE
A	Peak To Average Ratio	128 to 251	128, 190, 251	GSM, EDGE
A	Condcudeted Emission	128 to 251	128, 190, 251	GSM, EDGE
A	Radiated Emission Below 1GHz	128 to 251	128	GSM
A	Radiated Emission Above 1GHz	128 to 251	128, 190, 251	GSM

WCDMA MODE

EUT Configure Mode	Test Item	Available Channel	Tested Channel	Mode
A	ERP	4132 to 4233	4132, 4182, 4233	WCDMA
B	Frequency Stability	4132 to 4233	4182	WCDMA
A	Occupied Bandwidth	4132 to 4233	4132, 4182, 4233	WCDMA
A	Band Edge	4132 to 4233	4132, 4233	WCDMA
A	Peak To Average Ratio	4132 to 4233	4132, 4182, 4233	WCDMA
A	Condcudeted Emission	4132 to 4233	4132, 4182, 4233	WCDMA
A	Radiated Emission Below 1GHz	4132 to 4233	4132	WCDMA
A	Radiated Emission Above 1GHz	4132 to 4233	4132, 4182, 4233	WCDMA

LTE BAND 5 MODE

TEST ITEM	Available Channel	Tested Channel	Channel bandwidth	modulation	mode
ERP	20407 to 20643	20407, 20525, 20643	1.4MHz	QPSK,16QAM	1 RB / 0 RB Offset
	20415 to 20635	20415, 20525, 20635	3MHz	QPSK,16QAM	1 RB / 0 RB Offset
	20425 to 20625	20425, 20525, 20625	5MHz	QPSK,16QAM	1 RB / 0 RB Offset
	20450 to 20600	20450, 20525, 20600	10MHz	QPSK,16QAM	1 RB / 0 RB Offset
FREQUENCY STABILITY	20407 to 20643	20525	1.4MHz	QPSK	1 RB / 0 RB Offset
	20415 to 20635	20525	3MHz	QPSK	1 RB / 0 RB Offset
	20425 to 20625	20525	5MHz	QPSK	1 RB / 0 RB Offset
	20450 to 20600	20525	10MHz	QPSK	1 RB / 0 RB Offset
OCCUPIED BANDWIDTH	20407 to 20643	20407, 20525, 20643	1.4MHz	QPSK	6 RB / 0 RB Offset
				16QAM	6 RB / 0 RB Offset
	20415 to 20635	20415, 20525, 20635	3MHz	QPSK	15 RB / 0 RB Offset
				16QAM	15 RB / 0 RB Offset
	20425 to 20625	20425, 20525, 20625	5MHz	QPSK	25 RB / 0 RB Offset
				16QAM	25 RB / 0 RB Offset
	20450 to 20600	20450, 20525, 20600	10MHz	QPSK	50 RB / 0 RB Offset
				16QAM	50 RB / 0 RB Offset

BAND EDGE	20407 to 20643	20407	1.4 MHz	QPSK	1 RB / 0 RB Offset
					6 RB / 0 RB Offset
	20407 to 20643	20643	1.4 MHz	QPSK	1 RB / 5 RB Offset
					6 RB / 0 RB Offset
	20415 to 20635	20415	3 MHz	QPSK	1 RB / 0 RB Offset
					15 RB / 0 RB Offset
	20415 to 20635	20635	3 MHz	QPSK	1 RB / 14 RB Offset
					15 RB / 0 RB Offset
20425 to 20625	20425	5MHz	QPSK	1 RB / 0 RB Offset	
				25 RB / 0 RB Offset	
20425 to 20625	20625	5MHz	QPSK	1 RB / 24 RB Offset	
				25 RB / 0 RB Offset	
20450 to 20600	20450	10MHz	QPSK	1 RB / 0 RB Offset	
				50 RB / 0 RB Offset	
20450 to 20600	20600	10MHz	QPSK	1 RB / 49 RB Offset	
				50 RB / 0 RB Offset	
CONDCUDED EMISSION	20407 to 20643	20525	1.4MHz	QPSK	1 RB / 0 RB Offset
	20415 to 20635	20525	3MHz	QPSK	1 RB / 0 RB Offset
	20425 to 20625	20525	5MHz	QPSK	1 RB / 0 RB Offset
	20450 to 20600	20525	10MHz	QPSK	1 RB / 0 RB Offset
RADIATED EMISSION	20407 to 20643	20525	1.4MHz	QPSK	1 RB / 0 RB Offset
	20415 to 20635	20525	3MHz	QPSK	1 RB / 0 RB Offset
	20425 to 20625	20525	5MHz	QPSK	1 RB / 0 RB Offset
	20450 to 20600	20525	10MHz	QPSK	1 RB / 0 RB Offset

Test Condition:

Test Item	Environmental Conditions	Input Power	Tested By
ERP	23deg. C, 62%RH	DC 3.8V from battery	Yuqiang Yin
Frequency Stability	23deg. C, 62%RH	DC 3.8V from battery	Yuqiang Yin
Occupied Bandwidth	23deg. C, 62%RH	DC 3.8V from battery	Yuqiang Yin
Band Edge	23deg. C, 62%RH	DC 3.8V from battery	Yuqiang Yin
Peak To Average Ratio	23deg. C, 62%RH	DC 3.8V from battery	Yuqiang Yin
Conducuted Emission	25deg. C, 63.6%RH	5Vdc from adapter	Alex Chen
Radiated Emission	23deg. C, 62%RH	DC 3.8V from battery	Yuqiang Yin

3.4 EUT Operating Conditions

The EUT makes a call to the communication simulator. The communication simulator station system controlled a EUT to export maximum output power under transmission mode and specific channel frequency

3.5 General Description of Applied Standards

The EUT is a RF Product. According to the specifications of the manufacturer, it must comply with the requirements of the following standards:

FCC 47 CFR Part 2

FCC 47 CFR Part 22

KDB 971168 D01 Power Meas License Digital Systems v02r02

ANSI/TIA/EIA-603-D

NOTE: All test items have been performed and recorded as per the above standards.

4 Test Types and Results

4.1 Output Power Measurement

4.1.1 Limits of Output Power Measurement

Mobile / Portable station are limited to 7 watts e.r.p.

4.1.2 Test Procedures

EIRP / ERP Measurement:

- a. All measurements were done at low, middle and high operational frequency range. RBW and VBW is 1MHz for GSM, GPRS & EDGE, 5MHz for WCDMA mode, and 10MHz for LTE mode.
- b. Substitution method is used for E.I.R.P measurement. In the semi-anechoic chamber, EUT placed on the 0.8m height of Turn Table, rotated the table around 360 degrees to search the maximum radiation power and receiver antenna shall be rotated vertical and horizontal polarization and moved height from 1m to 4m to find the maximum polar radiated power. The "Read Value" is the spectrum reading the maximum power value.
- c. The substitution horn antenna is substituted for EUT at the same position and signals generator export the CW signal to the substitution antenna via a tx cable. Rotated the Turn Table and moved receiving antenna to find the maximum radiation power. Adjust output power level of S.G to get a Value of spectrum reading equal to "Read Value" of step b. Record the power level of S.G
- d. $EIRP = \text{Output power level of S.G} - \text{TX cable loss} + \text{Antenna gain of substitution horn}$. E.R.P power can be calculated form E.I.R.P power by subtracting the gain of dipole, $E.R.P \text{ power} = E.I.R.P \text{ power} - 2.15\text{dBi}$.

Conducted Power Measurement:

The EUT was set up for the maximum power with GSM, GPRS & WCDMA link data modulation and link up with simulator. Set the EUT to transmit under low, middle and high channel and record the power level shown on simulator.

4.1.3 Test Setup

EIRP / ERP MEASUREMENT:

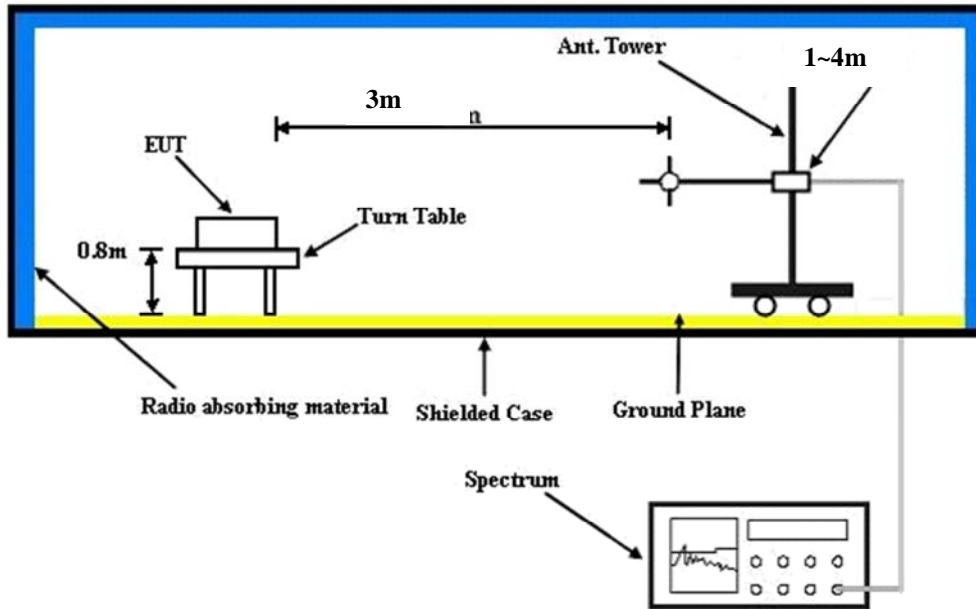

For the actual test configuration, please refer to the attached file (Test Setup Photo).

CONDUCTED POWER MEASUREMENT:



For the actual test configuration, please refer to the attached file (Test Setup Photo).

4.1.4 Test Results

CONDUCTED OUTPUT POWER (dBm)

Band	GSM850		
Channel	128	190	251
Frequency (MHz)	824.2	836.6	848.8
GSM	32.66	32.74	33.06
GPRS 8	32.56	32.55	32.97
GPRS 10	31.14	31.11	31.35
GPRS 11	29.53	29.58	29.71
GPRS 12	27.91	27.86	28.09
EDGE 8 (MCS1)	26.73	26.70	26.80
EDGE 10 (MCS1)	25.66	25.61	25.75
EDGE 11 (MCS9)	24.09	24.04	24.16
EDGE 12 (MCS9)	22.51	22.50	22.60

Band	WCDMA V		
Channel	4132	4182	4233
Frequency (MHz)	826.4	836.4	846.6
RMC 12.2K	23.60	23.64	23.55
HSPA			
HSDPA Subtest-1	22.76	22.71	22.72
HSDPA Subtest-2	22.76	22.70	22.71
HSDPA Subtest-3	22.26	22.22	22.21
HSDPA Subtest-4	22.23	22.25	22.19
HSUPA Subtest-1	22.57	22.59	22.60
HSUPA Subtest-2	20.68	20.69	20.66
HSUPA Subtest-3	21.51	21.45	21.35
HSUPA Subtest-4	20.41	20.28	19.98
HSUPA Subtest-5	22.73	22.74	22.70

Band/BW	Modulation	RB Size	RB Offset	Low CH 20407	Mid CH 20525	High CH 20643	3GPP MPR (dB)
				Frequency 824.7 MHz	Frequency 836.5 MHz	Frequency 848.3 MHz	
5/1.4	QPSK	1	0	23.16	23.02	23.06	0
		1	2	22.92	23.15	23.05	0
		1	5	22.90	22.97	22.87	0
		3	0	23.14	23.00	23.04	0
		3	1	22.90	23.13	23.03	0
		3	3	22.88	22.95	22.85	0
		6	0	22.12	22.01	22.06	1
	16QAM	1	0	22.24	22.11	22.04	1
		1	2	22.11	22.23	22.18	1
		1	5	22.04	22.10	22.20	1
		3	0	22.23	22.10	22.03	1
		3	1	22.10	22.22	22.17	1
		3	3	22.03	22.09	22.19	1
		6	0	20.95	21.02	20.81	2

Band/BW	Modulation	RB Size	RB Offset	Low CH 20415	Mid CH 20525	High CH 20635	3GPP MPR (dB)
				Frequency 825.5 MHz	Frequency 836.5 MHz	Frequency 847.5 MHz	
5/3	QPSK	1	0	23.20	23.06	23.10	0
		1	7	22.96	23.19	23.09	0
		1	14	22.94	23.01	22.91	0
		8	0	22.19	22.02	22.03	1
		8	3	22.10	22.01	22.01	1
		8	7	22.09	21.98	21.93	1
		15	0	22.16	22.05	22.10	1
	16QAM	1	0	22.28	22.15	22.08	1
		1	7	22.15	22.27	22.22	1
		1	14	22.08	22.14	22.24	1
		8	0	21.08	21.14	21.12	2
		8	3	21.02	20.93	21.07	2
		8	7	20.99	20.96	20.92	2
		15	0	20.99	21.06	20.85	2

Band/BW	Modulation	RB Size	RB Offset	Low CH 20425	Mid CH 20525	High CH 20625	3GPP MPR (dB)
				Frequency 826.5 MHz	Frequency 836.5 MHz	Frequency 846.5 MHz	
5/5	QPSK	1	0	23.26	23.12	23.16	0
		1	12	23.02	23.25	23.15	0
		1	24	23.00	23.07	22.97	0
		12	0	22.25	22.08	22.09	1
		12	6	22.16	22.07	22.07	1
		12	13	22.15	22.04	21.99	1
		25	0	22.22	22.11	22.16	1
	16QAM	1	0	22.34	22.21	22.14	1
		1	12	22.21	22.33	22.28	1
		1	24	22.14	22.20	22.30	1
		12	0	21.14	21.20	21.18	2
		12	6	21.08	20.99	21.13	2
		12	13	21.05	21.02	20.98	2
		25	0	21.05	21.12	20.91	2

Band/BW	Modulation	RB Size	RB Offset	Low CH 20450	Mid CH 20525	High CH 20600	3GPP MPR (dB)
				Frequency 829 MHz	Frequency 836.5 MHz	Frequency 844 MHz	
5/10	QPSK	1	0	23.29	23.15	23.19	0
		1	24	23.05	23.28	23.18	0
		1	49	23.03	23.10	23.00	0
		25	0	22.28	22.11	22.12	1
		25	12	22.19	22.10	22.10	1
		25	25	22.18	22.07	22.02	1
		50	0	22.25	22.14	22.19	1
	16QAM	1	0	22.37	22.24	22.17	1
		1	24	22.24	22.36	22.31	1
		1	49	22.17	22.23	22.33	1
		25	0	21.17	21.23	21.21	2
		25	12	21.11	21.02	21.16	2
		25	25	21.08	21.05	21.01	2
		50	0	21.08	21.15	20.94	2

ERP POWER (dBm)
GSM

Channel	Frequency (MHz)	LVL (dBm)	Correction Factor(dB)	ERP(dBm)	ERP(mW)	Polarization (H/V)
128	824.2	-5.09	33.56	26.32	428.45	H
189	836.4	-4.46	33.63	27.02	503.38	H
251	848.8	-5.21	33.57	26.21	417.64	H
128	824.2	-12.59	34.24	19.50	89.04	V
189	836.4	-12.16	34.59	20.28	106.56	V
251	848.8	-11.51	34.62	20.96	124.82	V

EDGE

Channel	Frequency (MHz)	LVL (dBm)	Correction Factor(dB)	ERP(dBm)	ERP(mW)	Polarization (H/V)
128	824.2	-10.79	33.56	20.62	115.32	H
189	836.4	-10.12	33.63	21.36	136.74	H
251	848.8	-11.01	33.57	20.41	109.85	H
128	824.2	-17.96	34.24	14.13	25.86	V
189	836.4	-17.55	34.59	14.89	30.80	V
251	848.8	-17.08	34.62	15.39	34.62	V

WCDMA

Channel	Frequency (MHz)	LVL (dBm)	Correction Factor(dB)	ERP(dBm)	ERP(mW)	Polarization (H/V)
4132	826.4	-17.99	33.56	13.42	21.97	H
4182	836.4	-17.93	33.63	13.55	22.64	H
4233	846.6	-17.63	33.57	13.79	23.92	H
4132	826.4	-22.37	34.24	9.72	9.37	V
4182	836.4	-22.89	34.59	9.55	9.01	V
4233	846.6	-22.51	34.62	9.96	9.92	V

LTE BAND 5

CHANNEL BANDWIDTH: 1.4MHz QPSK

Channel	Frequency (MHz)	LVL (dBm)	Correction Factor(dB)	ERP(dBm)	ERP(mW)	Polarization (H/V)	LIMIT (W)
20407	824.7	-16.85	33.67	14.67	29.33	H	7
20525	836.5	-16.02	33.62	15.45	35.11	H	7
20643	848.3	-15.63	33.65	15.87	38.59	H	7
20407	824.7	-10.23	34.25	21.87	153.74	V	7
20525	836.5	-9.69	34.60	22.76	188.71	V	7
20643	848.3	-8.99	34.63	23.49	223.36	V	7

CHANNEL BANDWIDTH: 1.4MHz 16QAM

Channel	Frequency (MHz)	LVL (dBm)	Correction Factor(dB)	ERP(dBm)	ERP(mW)	Polarization (H/V)	LIMIT (W)
20407	824.7	-17.68	33.67	13.84	24.23	H	7
20525	836.5	-17.04	33.62	14.43	27.76	H	7
20643	848.3	-16.73	33.65	14.77	29.96	H	7
20407	824.7	-11.06	34.25	21.04	127.00	V	7
20525	836.5	-10.71	34.60	21.74	149.21	V	7
20643	848.3	-10.09	34.63	22.39	173.38	V	7

CHANNEL BANDWIDTH: 3MHz QPSK

Channel	Frequency (MHz)	LVL (dBm)	Correction Factor(dB)	ERP(dBm)	ERP(mW)	Polarization (H/V)	LIMIT (W)
20415	825.5	-16.66	33.72	14.91	30.98	H	7
20525	836.5	-15.96	33.62	15.51	35.60	H	7
20635	847.5	-15.50	33.65	16.00	39.80	H	7
20415	825.5	-10.04	34.30	22.11	162.59	V	7
20525	836.5	-9.63	34.60	22.82	191.34	V	7
20635	847.5	-8.86	34.57	23.56	227.04	V	7

CHANNEL BANDWIDTH: 3MHz 16QAM

Channel	Frequency (MHz)	LVL (dBm)	Correction Factor(dB)	ERP(dBm)	ERP(mW)	Polarization (H/V)	LIMIT (W)
20415	825.5	-17.81	33.72	13.76	23.77	H	7
20525	836.5	-17.06	33.62	14.41	27.63	H	7
20635	847.5	-16.66	33.65	14.84	30.47	H	7
20415	825.5	-11.19	34.30	20.96	124.77	V	7
20525	836.5	-10.73	34.60	21.72	148.53	V	7
20635	847.5	-10.02	34.57	22.40	173.82	V	7

CHANNEL BANDWIDTH: 5MHz QPSK

Channel	Frequency (MHz)	LVL (dBm)	Correction Factor(dB)	ERP(dBm)	ERP(mW)	Polarization (H/V)	LIMIT (W)
20425	826.5	-16.67	33.69	14.87	30.72	H	7
20525	836.5	-16.03	33.62	15.44	35.03	H	7
20625	846.5	-15.57	33.66	15.94	39.27	H	7
20425	826.5	-10.05	34.85	22.65	184.03	V	7
20525	836.5	-9.70	34.60	22.75	188.28	V	7
20625	846.5	-8.93	34.59	23.51	224.59	V	7

CHANNEL BANDWIDTH: 5MHz 16QAM

Channel	Frequency (MHz)	LVL (dBm)	Correction Factor(dB)	ERP(dBm)	ERP(mW)	Polarization (H/V)	LIMIT (W)
20425	826.5	-17.53	33.69	14.01	25.20	H	7
20525	836.5	-16.90	33.62	14.57	28.67	H	7
20625	846.5	-16.42	33.66	15.09	32.29	H	7
20425	826.5	-10.91	34.85	21.79	150.97	V	7
20525	836.5	-10.57	34.60	21.88	154.10	V	7
20625	846.5	-9.78	34.59	22.66	184.67	V	7

CHANNEL BANDWIDTH: 10MHz QPSK

Channel	Frequency (MHz)	LVL (dBm)	Correction Factor(dB)	ERP(dBm)	ERP(mW)	Polarization (H/V)	LIMIT (W)
20450	829	-17.25	33.73	14.33	27.07	H	7
20525	836.5	-16.48	33.62	14.99	31.58	H	7
20600	844	-16.15	33.51	15.21	33.21	H	7
20450	829	-10.63	34.54	21.76	149.83	V	7
20525	836.5	-10.15	34.60	22.30	169.75	V	7
20600	844	-9.51	34.46	22.80	190.33	V	7

CHANNEL BANDWIDTH: 10MHz 16QAM

Channel	Frequency (MHz)	LVL (dBm)	Correction Factor(dB)	ERP(dBm)	ERP(mW)	Polarization (H/V)	LIMIT (W)
20450	829	-18.18	33.73	13.40	21.85	H	7
20525	836.5	-17.55	33.62	13.92	24.68	H	7
20600	844	-16.98	33.51	14.38	27.43	H	7
20450	829	-11.56	34.54	20.83	120.95	V	7
20525	836.5	-11.22	34.60	21.23	132.68	V	7
20600	844	-10.34	34.46	21.97	157.22	V	7

REMARKS: 1. ERP Output Power (dBm) = SPA Reading (dBm) + Correction Factor (dB).
 2. Correction factor (dB) = Free Space Loss + Antenna Factor + Cable Loss.

4.2 Frequency Stability Measurement

4.2.1 Limits of Frequency Stability Measurement

1.5 ppm is for base and fixed station. 2.5 ppm is for mobile station.

4.2.2 Test Procedure

- a. Device is placed at the oven room. The oven room could control the temperatures and humidity. Power warm up is at least 15 min and power applied should perform before recording frequency error.
- b. EUT is connected the external power supply to control the DC input power. The test voltage range is from minimum to maximum working voltage. Each step shall be record the frequency error rate.
- c. The temperature range step is 10 degrees in this test items. All temperature levels shall be hold the $\pm 0.5^{\circ}\text{C}$ during the measurement testing. The each temperature step shall be at least 0.5 hours, consider the EUT could be test under the stability condition.

NOTE: The frequency error was recorded frequency error from the communication simulator.

4.2.3 Test Setup

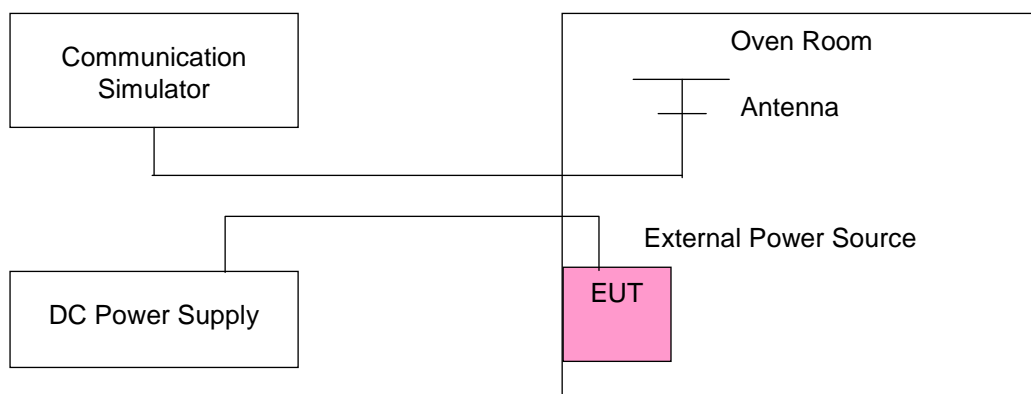

4.2.4 Test Results

FREQUENCY ERROR VS. VOLTAGE

Voltage (Volts)	Frequency Error (ppm)							Limit (ppm)
	GSM	EDGE	WCDMA	LTE Band 5				
				1.4 MHz	3 MHz	5 MHz	10MHz	
3.8	0.0038	0.0030	0.0031	0.0027	0.0025	0.0015	0.0039	2.5
3.55	0.0023	0.0025	0.0023	0.0039	0.0034	0.0039	0.0026	2.5
4.3	0.0027	0.0017	0.0028	0.0034	0.0037	0.0035	0.0048	2.5

NOTE: The applicant defined the normal working voltage of the battery is from 3.55Vdc to 4.3Vdc.

FREQUENCY ERROR vs. TEMPERATURE.

TEMP. (°C)	Frequency Error (ppm)							Limit (ppm)
	GSM	EDGE	WCDMA	LTE Band 5				
				1.4 MHz	3 MHz	5 MHz	10MHz	
-30	0.0113	0.0090	0.0097	0.0105	0.0113	0.0109	0.0103	2.5
-20	0.0098	0.0101	0.0086	0.0086	0.0100	0.0099	0.0085	2.5
-10	0.0077	0.0082	0.0078	0.0078	0.0093	0.0084	0.0069	2.5
0	0.0086	0.0087	0.0070	0.0066	0.0078	0.0078	0.0050	2.5
10	0.0075	0.0108	0.0059	0.0052	0.0065	0.0064	0.0060	2.5
20	0.0048	0.0050	0.0077	0.0046	0.0054	0.0052	0.0038	2.5
30	0.0035	0.0040	0.0056	0.0032	0.0038	0.0038	0.0025	2.5
40	0.0054	0.0058	0.0060	0.0028	0.0029	0.0036	0.0022	2.5
50	0.0072	0.0060	0.0073	0.0013	0.0019	0.0021	0.0008	2.5
60	0.0059	0.0032	0.0040	0.0004	0.0008	0.0008	0.0001	2.5

4.3 Occupied Bandwidth Measurement

4.3.1 Test Procedure

The EUT makes a call to the communication simulator. All measurements were done at low, middle and high operational frequency range. The communication simulator station system controlled a EUT to export maximum output power under transmission mode and specific channel frequency. Use OBW measurement function of Spectrum analyzer to measure 99 % occupied bandwidth.

4.3.2 Test Setup

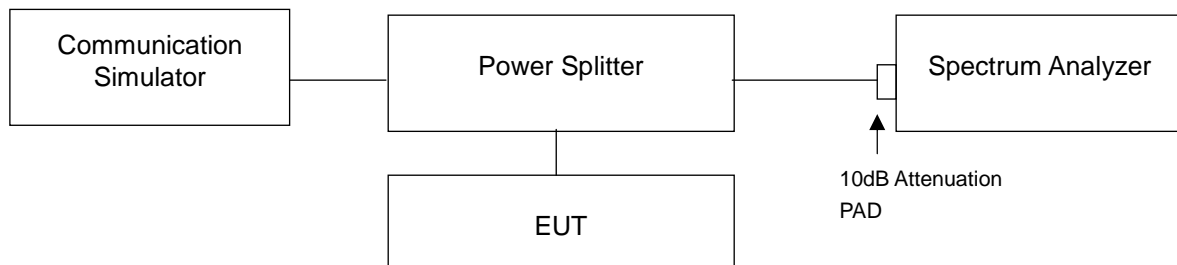

4.3.3 Test Result

Channel	Frequency (MHz)	99% Occupied Bandwidth (kHz)		Channel	FREQ. (MHz)	99% Occupied Bandwidth (MHz)
		GSM	EDGE			WCDMA
128	824.2	246.00	243.00	4132	826.4	4.14
190	836.6	247.00	241.00	4182	836.6	4.14
251	848.8	247.00	242.00	4233	846.6	4.15

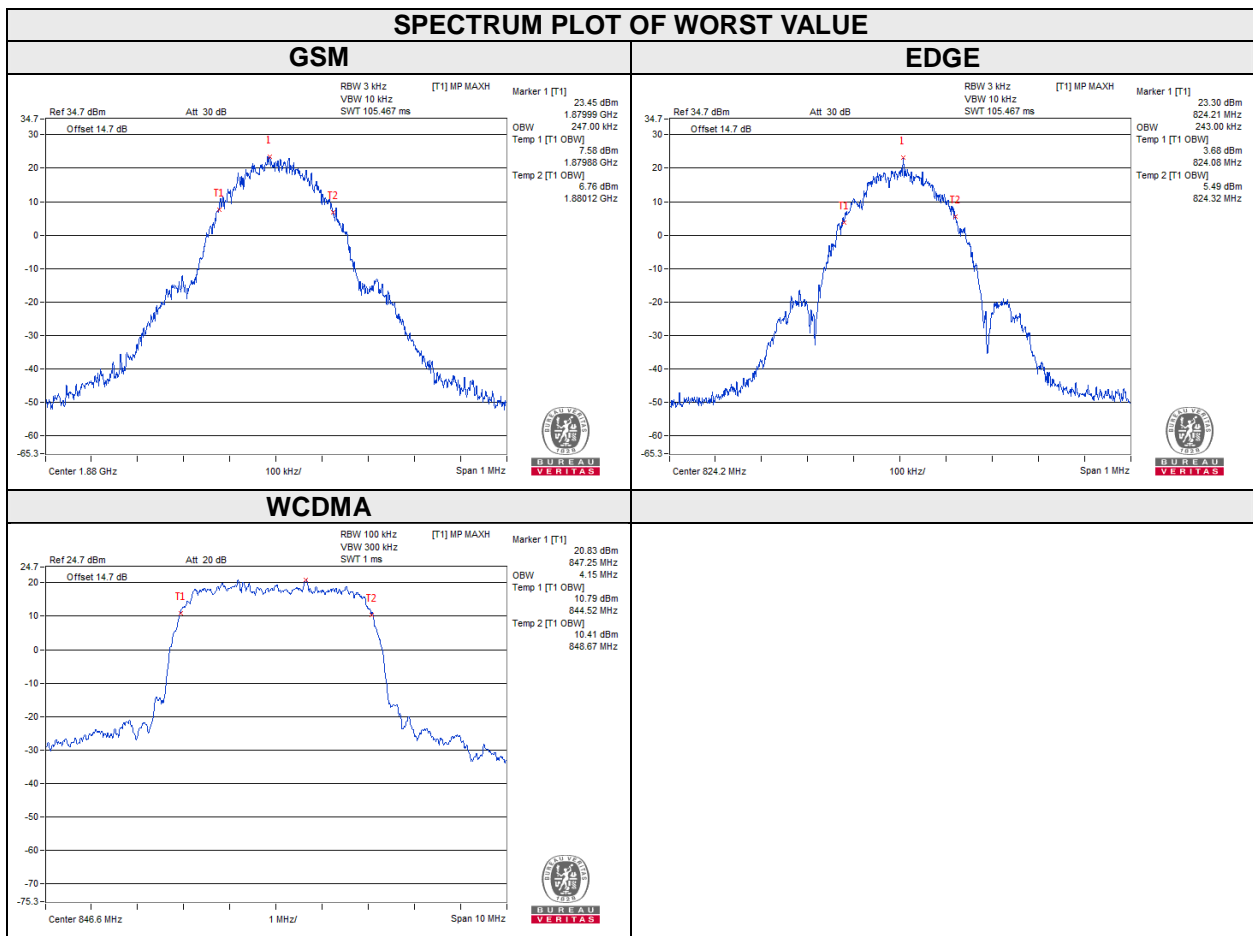

CHANNEL	Frequency (MHz)	26dB Bandwidth (kHz)		CHANNEL	Frequency (MHz)	26dB Bandwidth (MHz)
		GSM	EDGE			WCDMA
128	824.2	320.50	318.54	4132	826.4	4.75
190	836.6	316.48	309.19	4182	836.4	4.72
251	848.8	315.97	312.95	4233	846.6	4.73

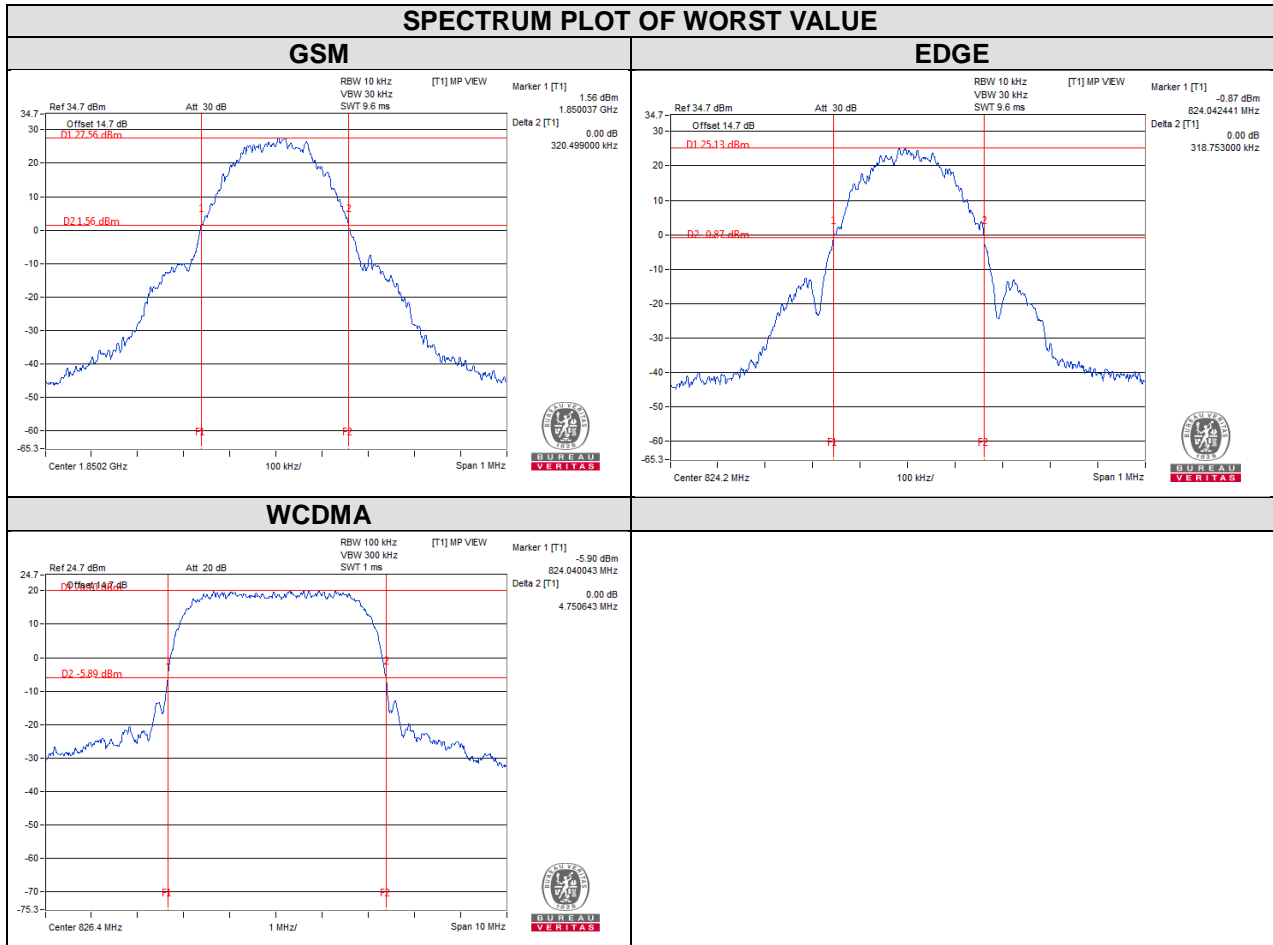

LTE band 5							
Channel Bandwidth : 1.4MHz							
Channel	Frequency (MHz)	99% Occupied bandwidth (MHz)		Channel	Frequency (MHz)	26 dB bandwidth (MHz)	
		QPSK	16QAM			QPSK	16QAM
20407	824.7	1.09	1.09	20407	824.7	1.26	1.27
20525	836.5	1.09	1.08	20525	836.5	1.26	1.26
20643	848.3	1.08	1.09	20643	848.3	1.25	1.28

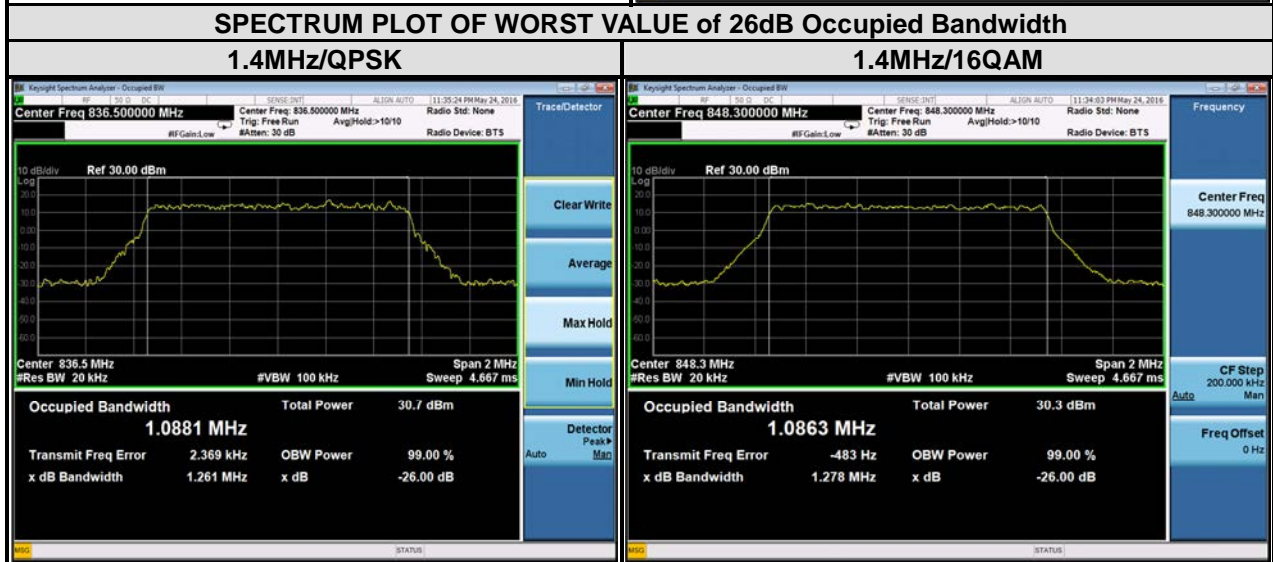
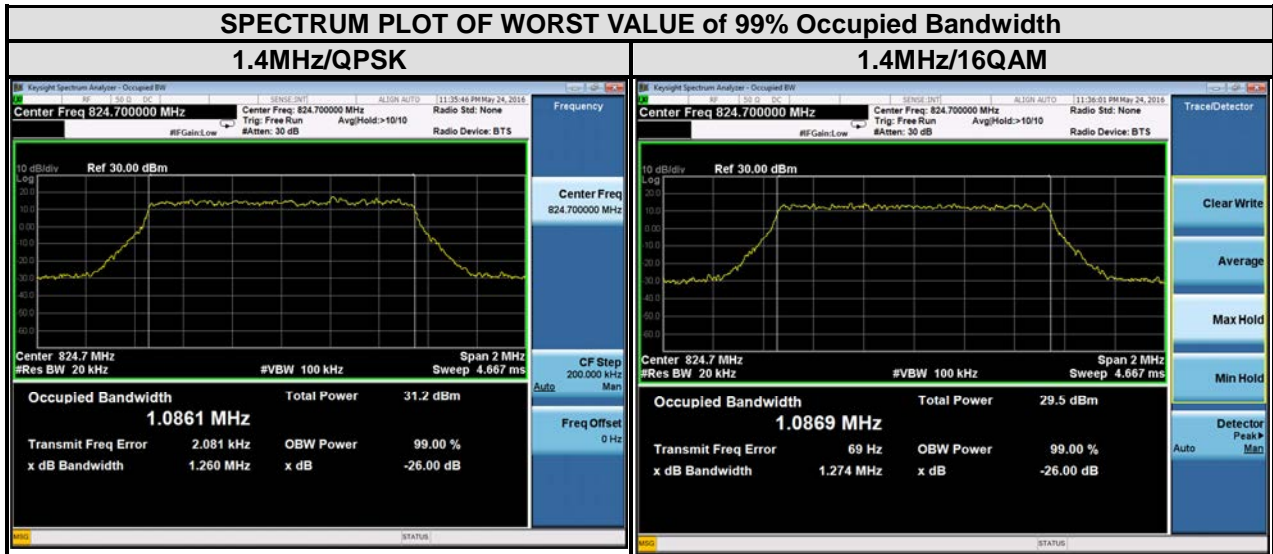

LTE band 5							
Channel Bandwidth : 3MHz							
Channel	Frequency (MHz)	99% Occupied bandwidth (MHz)		Channel	Frequency (MHz)	26 dB bandwidth (MHz)	
		QPSK	16QAM			QPSK	16QAM
20415	825.5	2.69	2.68	20415	825.5	2.92	2.91
20525	836.5	2.69	2.69	20525	836.5	2.92	2.93
20635	847.5	2.69	2.69	20635	847.5	2.92	2.92

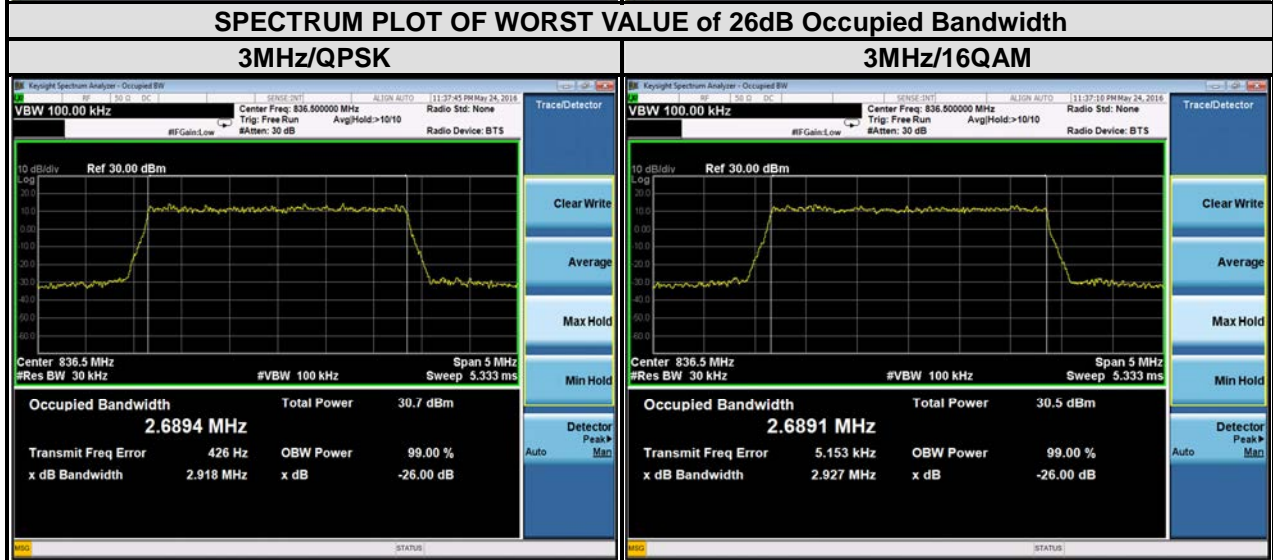
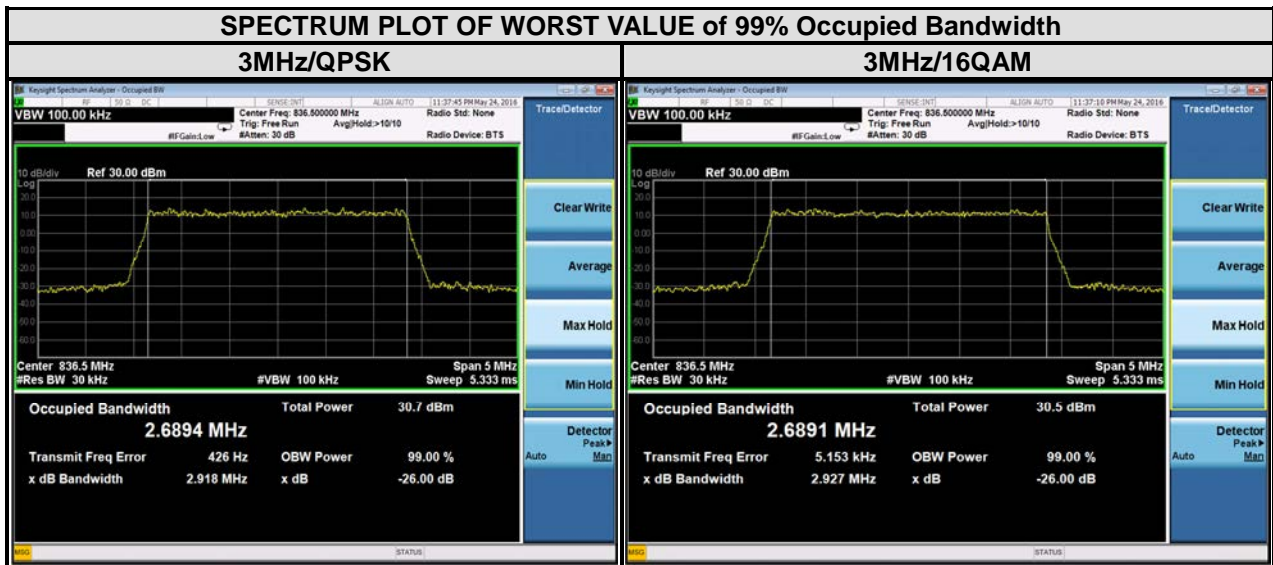

LTE band 5							
Channel Bandwidth : 5 MHz							
Channel	Frequency (MHz)	99% Occupied bandwidth (MHz)		Channel	Frequency (MHz)	26 dB bandwidth (MHz)	
		QPSK	16QAM			QPSK	16QAM
20425	826.5	4.47	4.48	20425	826.5	4.89	4.88
20525	836.5	4.48	4.48	20525	836.5	4.88	4.88
20625	846.5	4.47	4.48	20625	846.5	4.94	4.88

SPECTRUM PLOT OF WORST VALUE of 99% Occupied Bandwidth

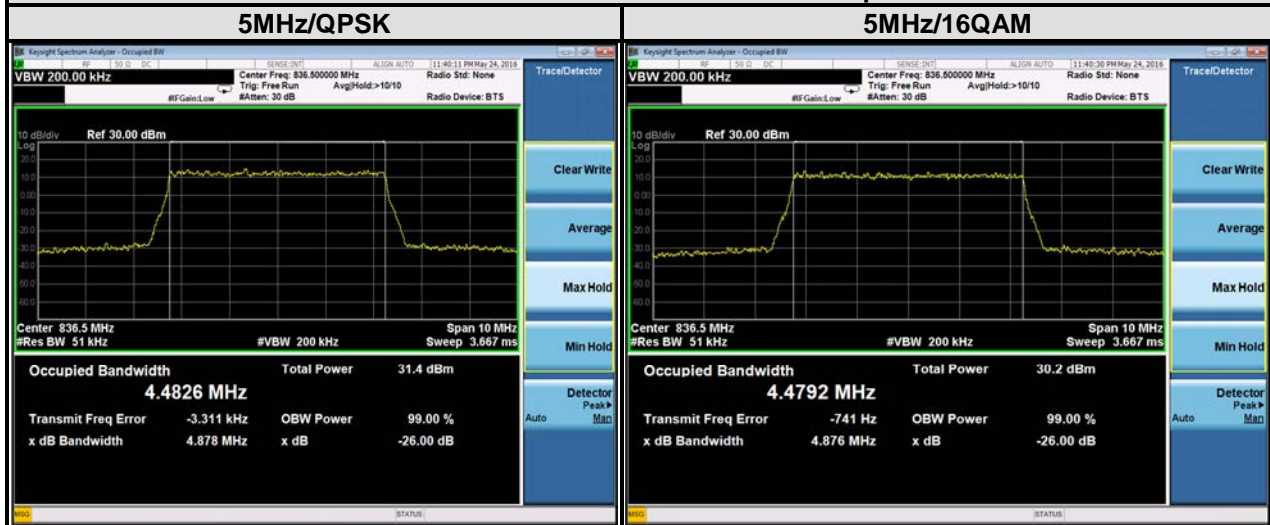

SPECTRUM PLOT OF WORST VALUE of 26dB Occupied Bandwidth

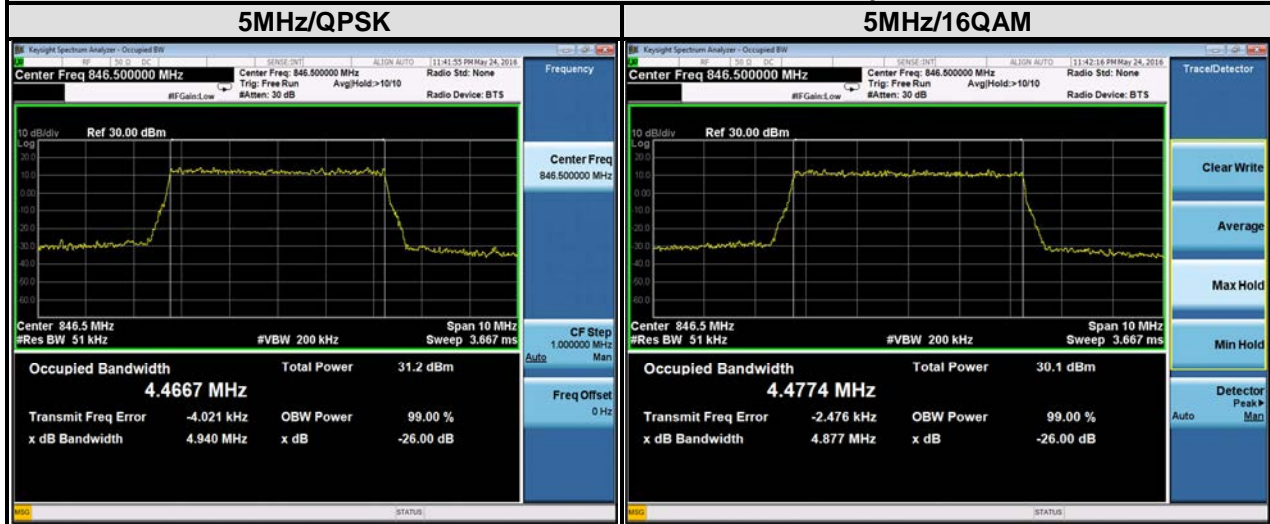

LTE band 5							
Channel Bandwidth : 10 MHz							
Channel	Frequency (MHz)	99% Occupied bandwidth (MHz)		Channel	Frequency (MHz)	26 dB bandwidth (MHz)	
		QPSK	16QAM			QPSK	16QAM
20450	829	8.91	8.93	20450	829	9.70	9.67
20525	836.5	8.96	8.92	20525	836.5	9.76	9.68
20600	844	8.92	8.94	20600	844	9.63	9.67

SPECTRUM PLOT OF WORST VALUE of 99% Occupied Bandwidth

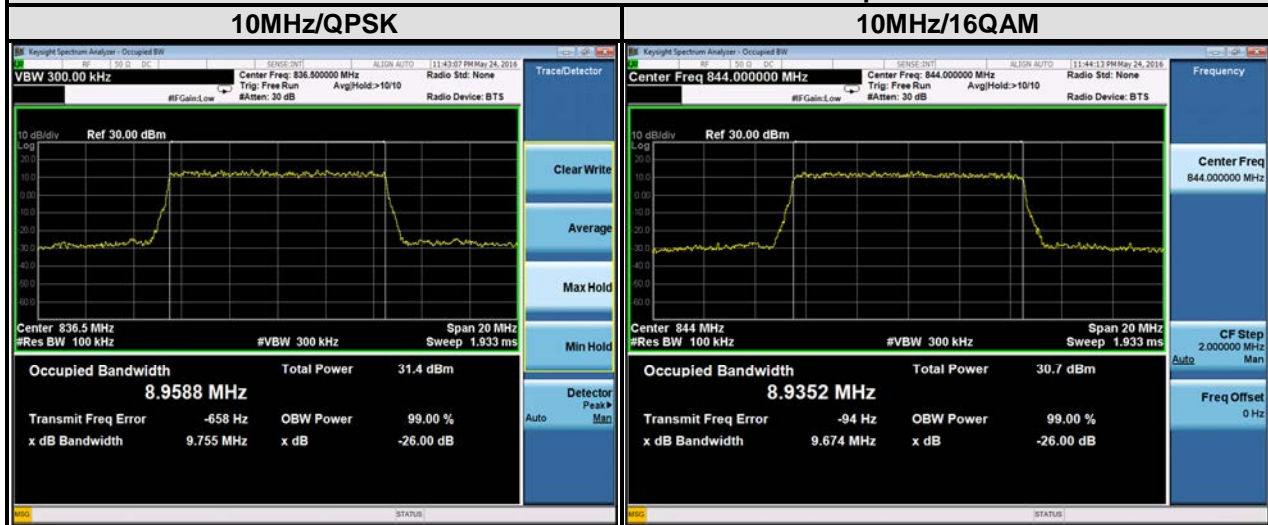

SPECTRUM PLOT OF WORST VALUE of 26dB Occupied Bandwidth

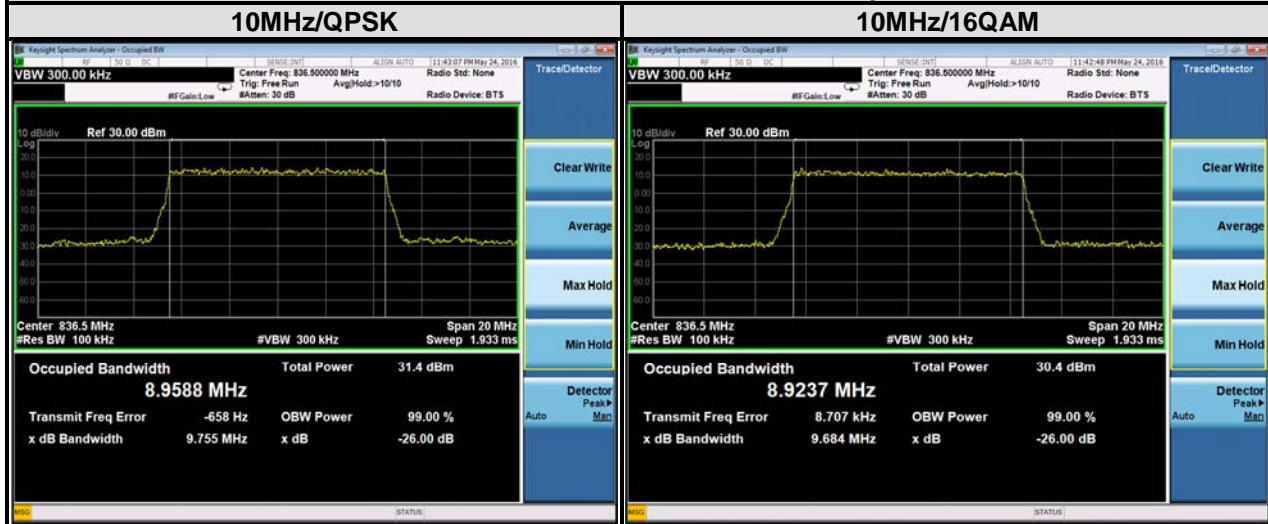

4.4 Band Edge Measurement

4.4.1 Limits of Band Edge Measurement

Power of any emission outside of the authorized operating frequency ranges must be attenuated below the transmitting power (P) by a factor of at least $43 + 10 \log(P)$ dB. In the 1 MHz bands immediately outside and adjacent to the frequency block a resolution bandwidth of at least one percent of the emission bandwidth of the fundamental emission of the transmitter may be employed.

4.4.2 Test Setup

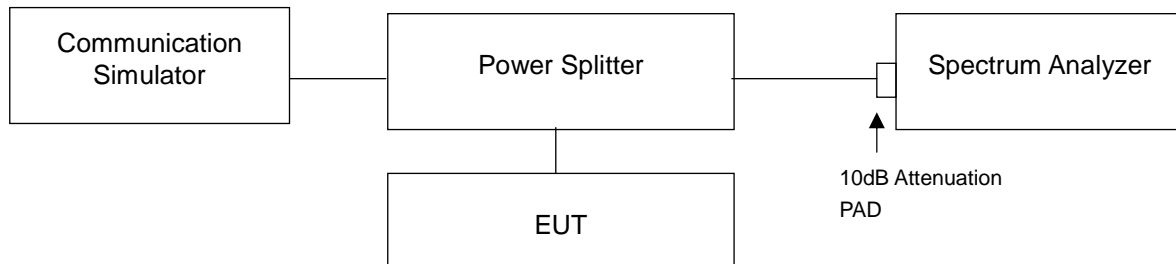

4.4.3 Test Procedures

- a. All measurements were done at low and high operational frequency range.
- b. The center frequency of spectrum is the band edge frequency and span is 1.5MHz. RB of the spectrum is 3kHz and VB of the spectrum is 10kHz (GSM/EDGE).
- c. The center frequency of spectrum is the band edge frequency and span is 10MHz. RB of the spectrum is 100kHz and VB of the spectrum is 300kHz (WCDMA).
- d. The center frequency of spectrum is the band edge frequency and span is 1~5 MHz. RB of the spectrum is 20kHz and VB of the spectrum is 100 kHz. (LTE bandwidth 1.4MHz).
- e. The center frequency of spectrum is the band edge frequency and span is 1~5 MHz. RB of the spectrum is 30kHz and VB of the spectrum is 100kHz. (LTE bandwidth 3MHz)
- f. The center frequency of spectrum is the band edge frequency and span is 1~5 MHz. RB of the spectrum is 50kHz and VB of the spectrum is 200kHz. (LTE bandwidth 5MHz)
- g. The center frequency of spectrum is the band edge frequency and span is 1~5 MHz. RB of the spectrum is 100kHz and VB of the spectrum is 300kHz. (LTE bandwidth 10MHz)
- h. Record the max trace plot into the test report.

4.4.4 Test Results

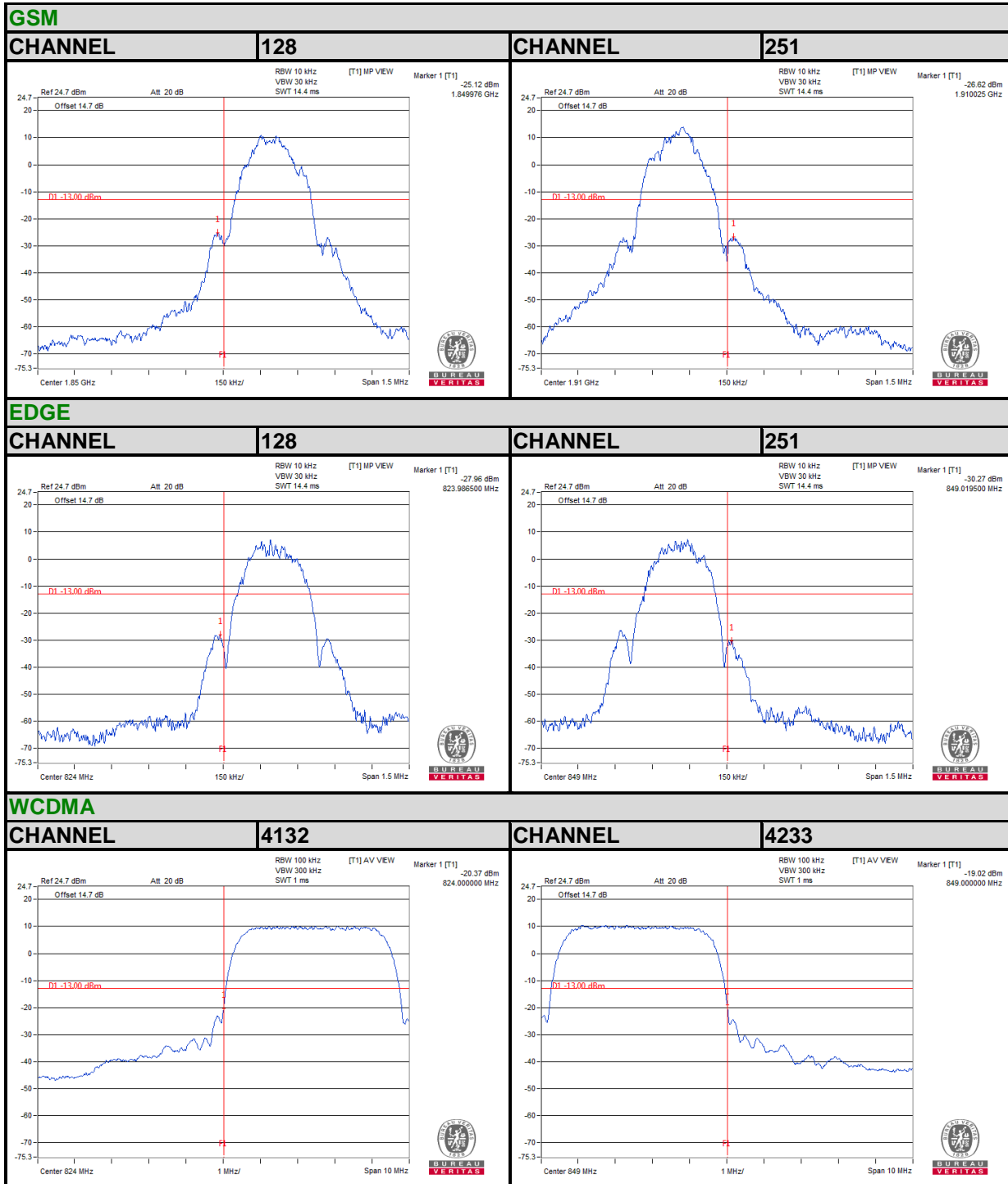

LTE Band5

Channel Bandwidth: 1.4MHz

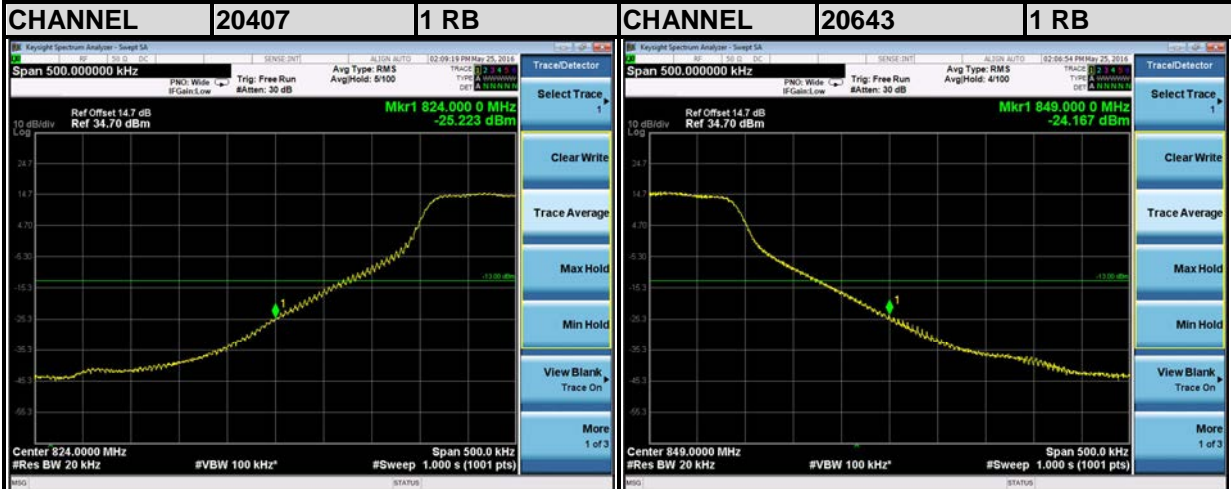

LTE Band5

Channel Bandwidth: 1.4MHz

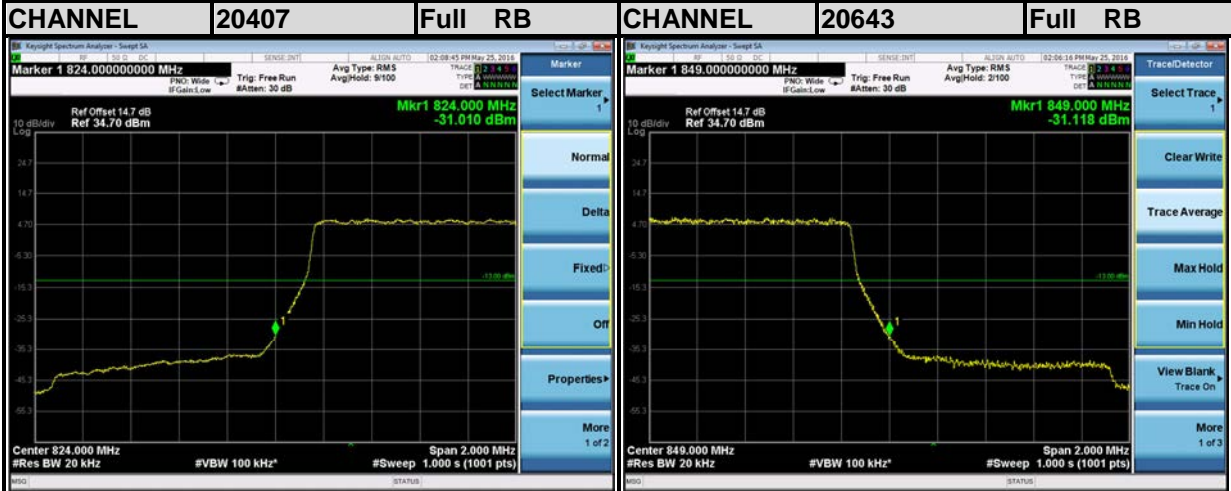

LTE Band5
Channel Bandwidth: 3MHz



LTE Band5
Channel Bandwidth: 3MHz

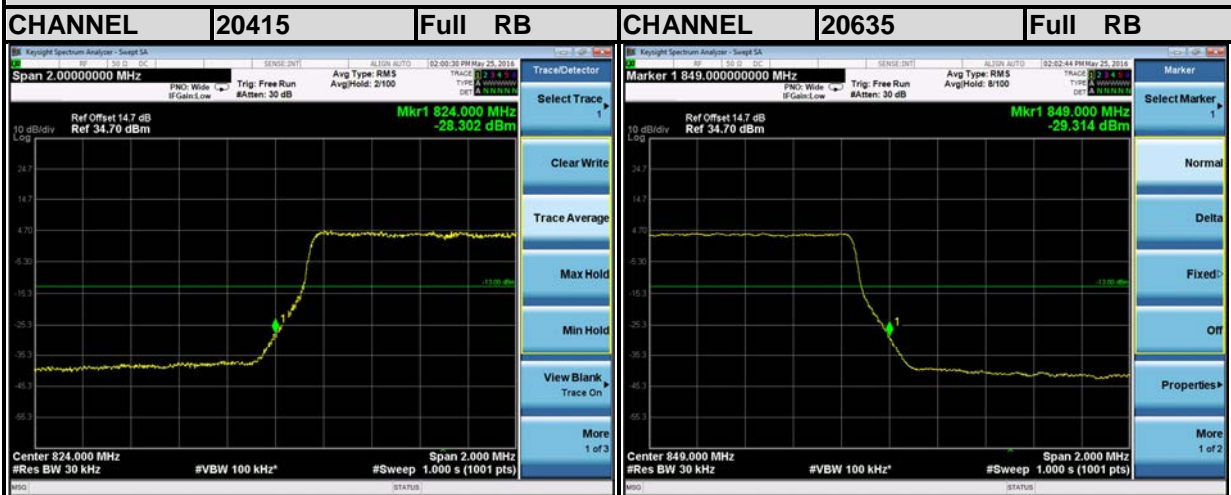

LTE Band5
Channel Bandwidth: 5MHz

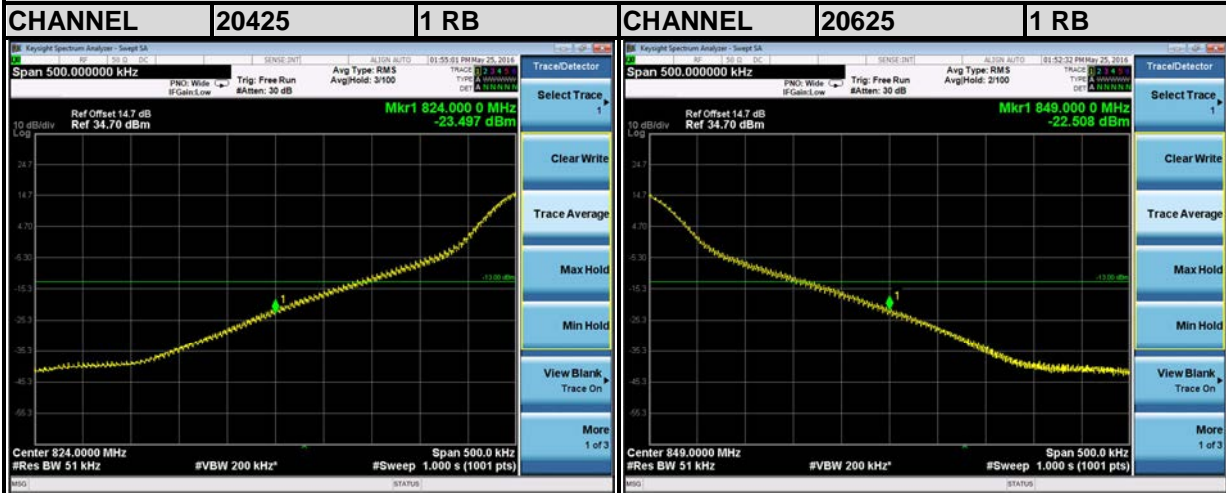

LTE Band5
Channel Bandwidth: 5MHz

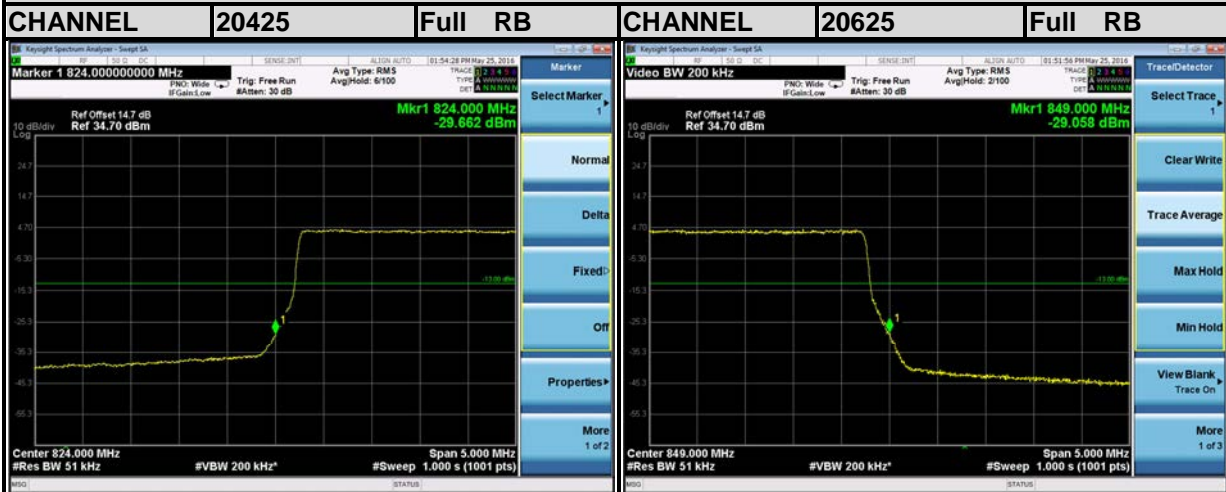

LTE Band5
Channel Bandwidth: 10MHz

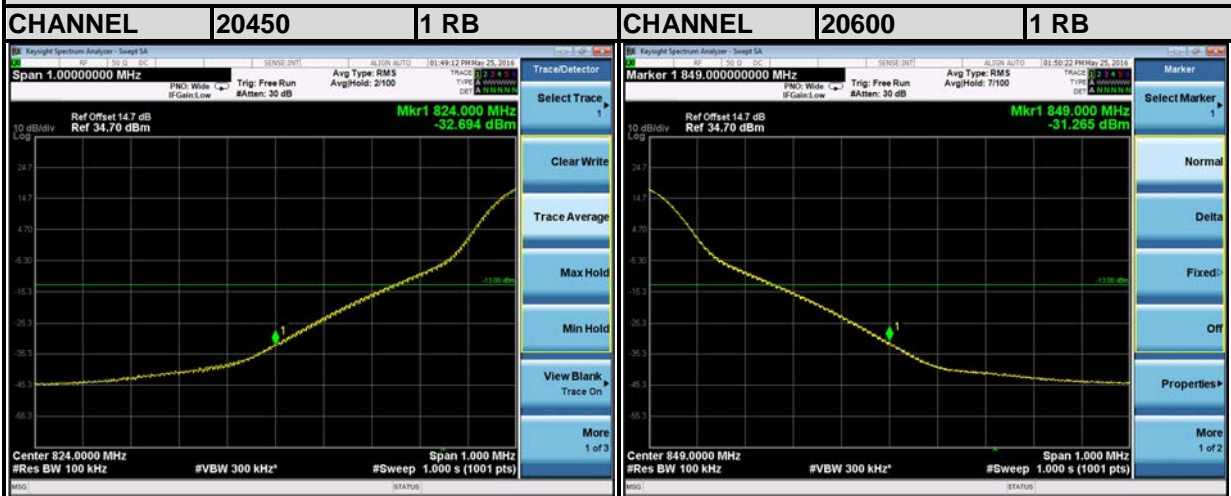

LTE Band5
Channel Bandwidth: 10MHz

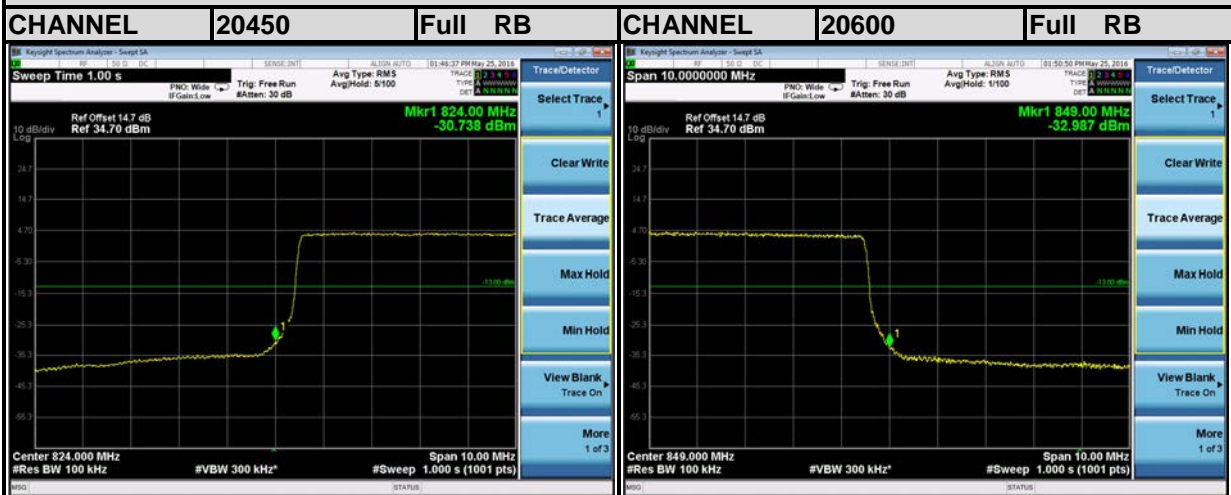

4.5 Peak To Average Ratio

4.5.1 Limits of Peak To Average Ratio Measurement

In measuring transmissions in this band using an average power technique, the peak to-average ratio (PAR) of the transmission may not exceed 13 dB

4.5.2 Test Setup

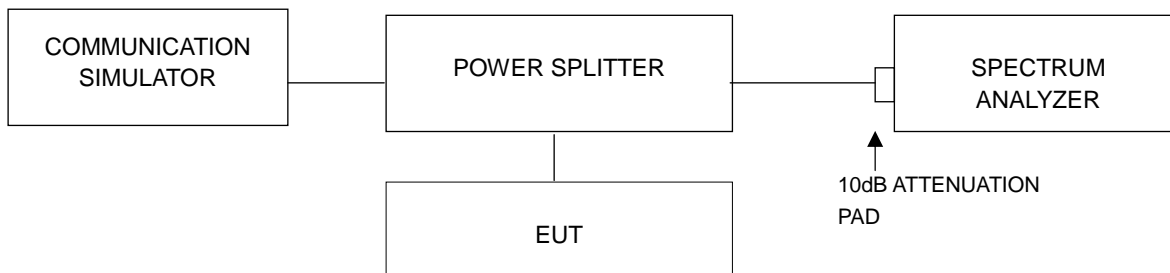

4.5.3 Test Procedures

1. Set resolution/measurement bandwidth \geq signal's occupied bandwidth;
2. Set the number of counts to a value that stabilizes the measured CCDF curve;
3. Record the maximum PAPR level associated with a probability of 0.1%.

4.5.4 Test Results

Channel	Frequency (MHz)	Peak To Average Ratio (dB)		Channel	Frequency (MHz)	Peak To Average Ratio (dB)
		GSM	EDGE			
189	836.4	9.52	9.64	4182	836.4	3.30

SPECTRUM PLOT OF WORST VALUE

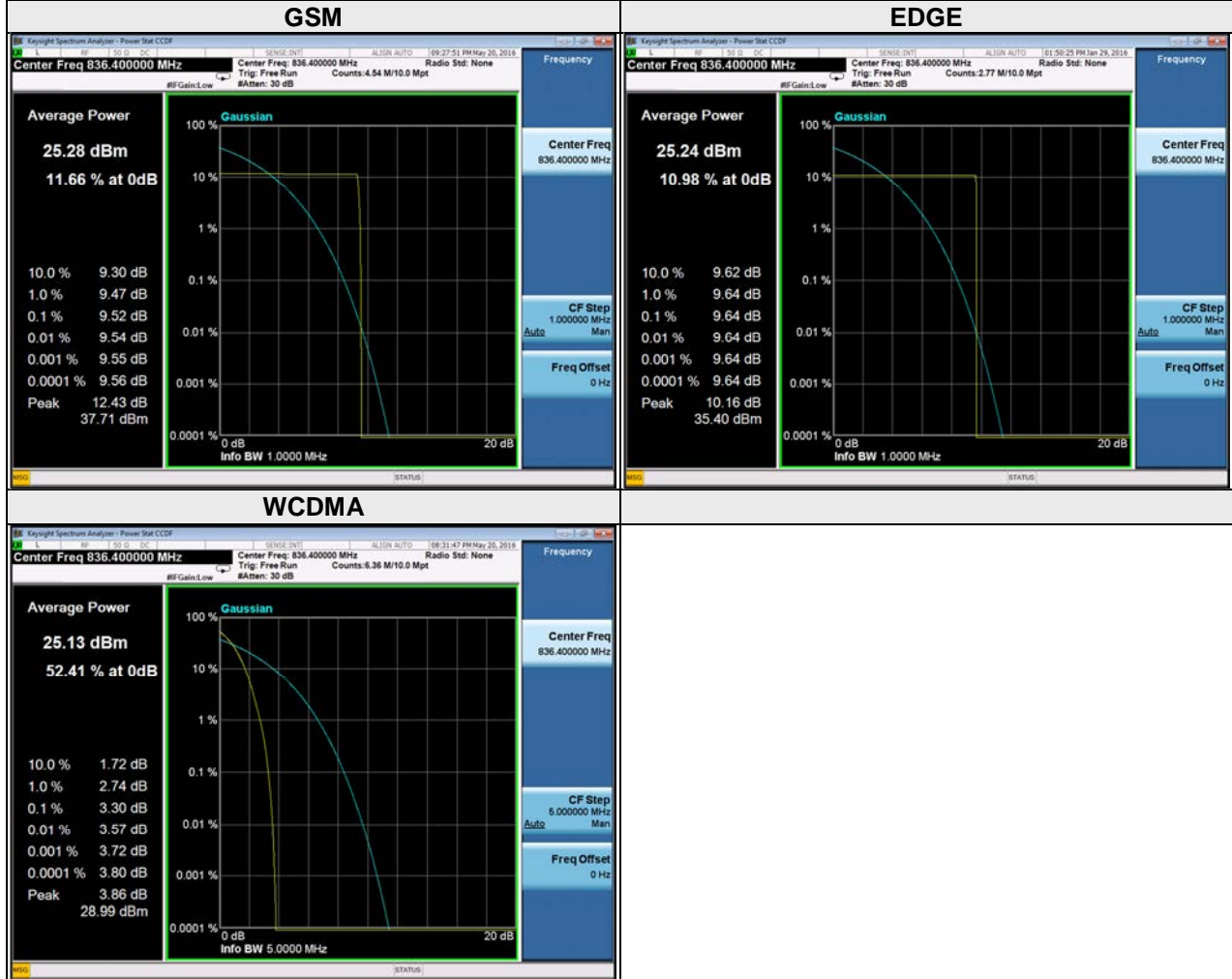

LTE BAND 5

CHANNEL BANDWIDTH: 1.4MHz				CHANNEL BANDWIDTH: 3MHz			
CHANNEL	FREQUENCY (MHz)	PEAK TO AVERAGE RATIO (dB)		CHANNEL	FREQUENCY (MHz)	PEAK TO AVERAGE RATIO (dB)	
		QPSK	16QAM			QPSK	16QAM
20407	824.7	5.27	6.10	20415	825.5	5.35	6.13
20525	836.5	5.56	6.37	20525	836.5	5.68	6.45
20643	848.3	5.26	6.11	20635	847.5	5.34	6.12

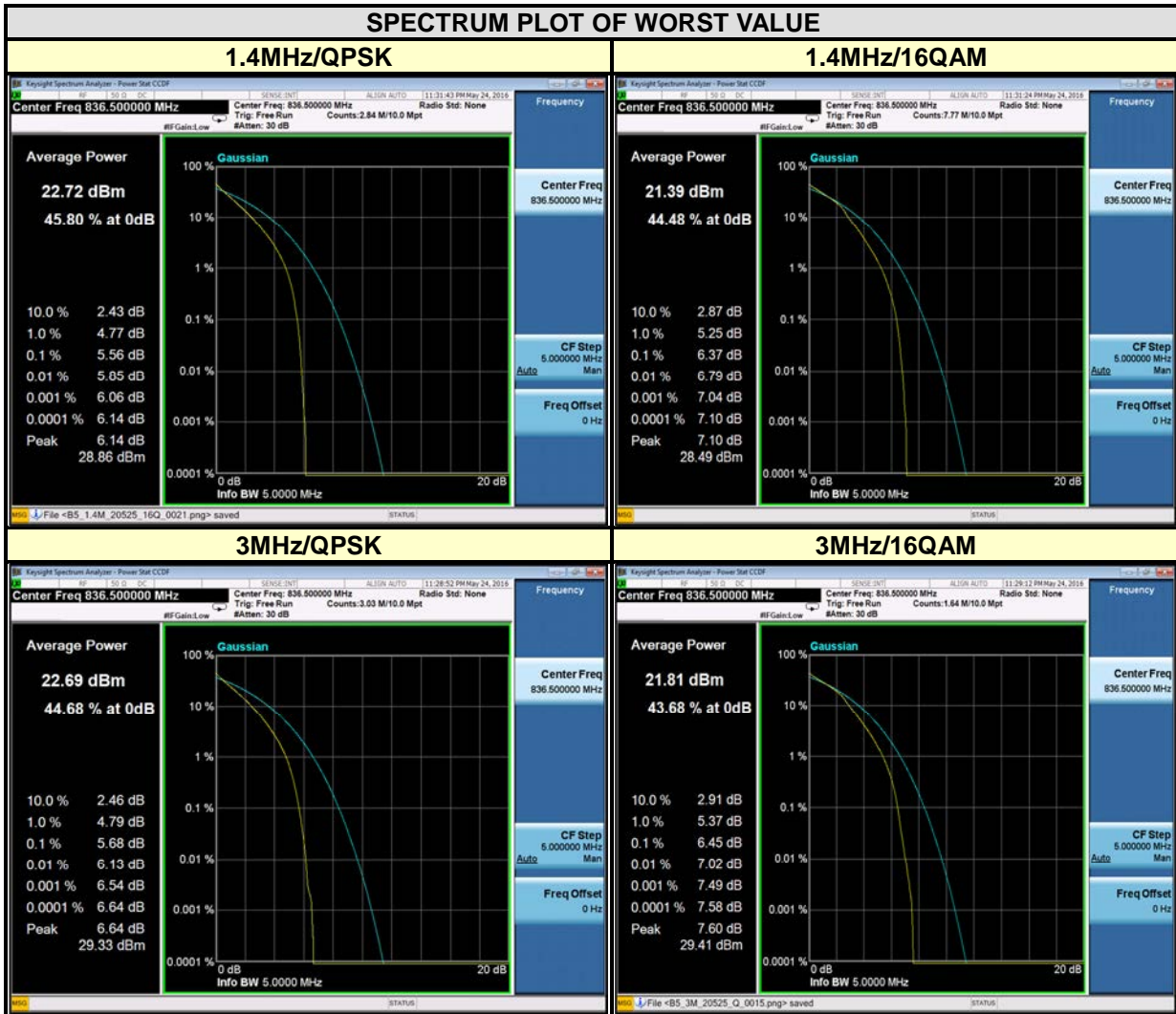

CHANNEL BANDWIDTH: 5MHz				CHANNEL BANDWIDTH: 10MHz			
CHANNEL	FREQUENCY (MHz)	PEAK TO AVERAGE RATIO (dB)		CHANNEL	FREQUENCY (MHz)	PEAK TO AVERAGE RATIO (dB)	
		QPSK	16QAM			QPSK	16QAM
20425	826.5	5.33	6.08	20450	829	5.43	6.15
20525	836.5	5.56	6.33	20525	836.5	5.70	6.40
20625	846.5	5.35	6.12	20600	844	5.47	6.25

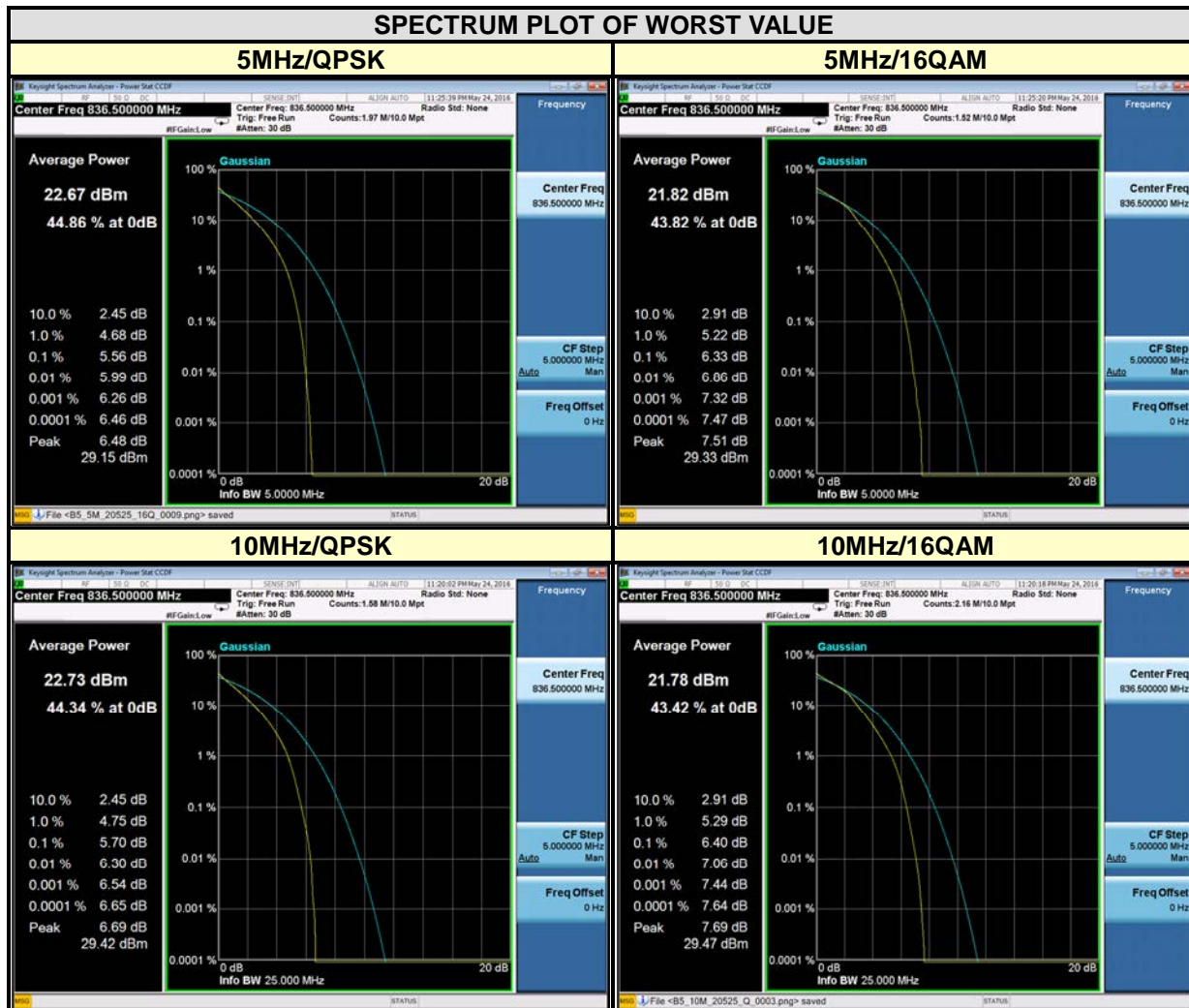

4.6 Conducted Spurious Emissions

4.6.1 Limits of Conducted Spurious Emissions Measurement

The power of any emission outside of the authorized operating frequency ranges must be attenuated below the transmitting power (P) by a factor of at least $43 + 10 \log(P)$ dB. The emission limit equal to -13dBm .

4.6.2 Test Setup

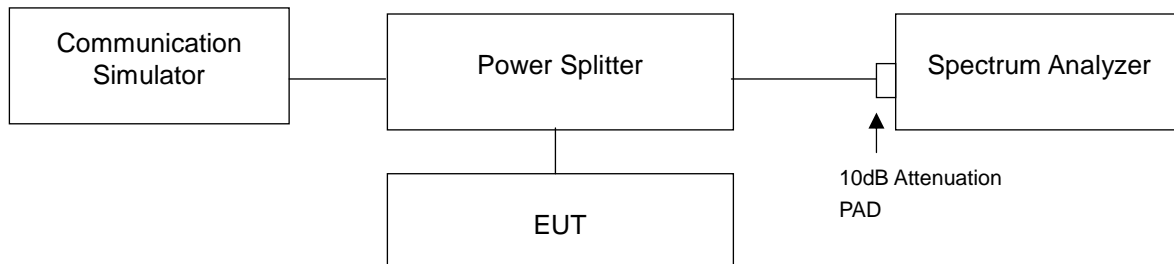

4.6.3 Test Procedure

- a. The EUT makes a phone call to the communication simulator. All measurements were done at low, middle and high operational frequency range.
- b. Measuring frequency range is from 9 kHz to 10GHz. 20dB attenuation pad is connected with spectrum. RBW=1MHz and VBW=3MHz is used for conducted emission measurement.

4.6.4 Test Results

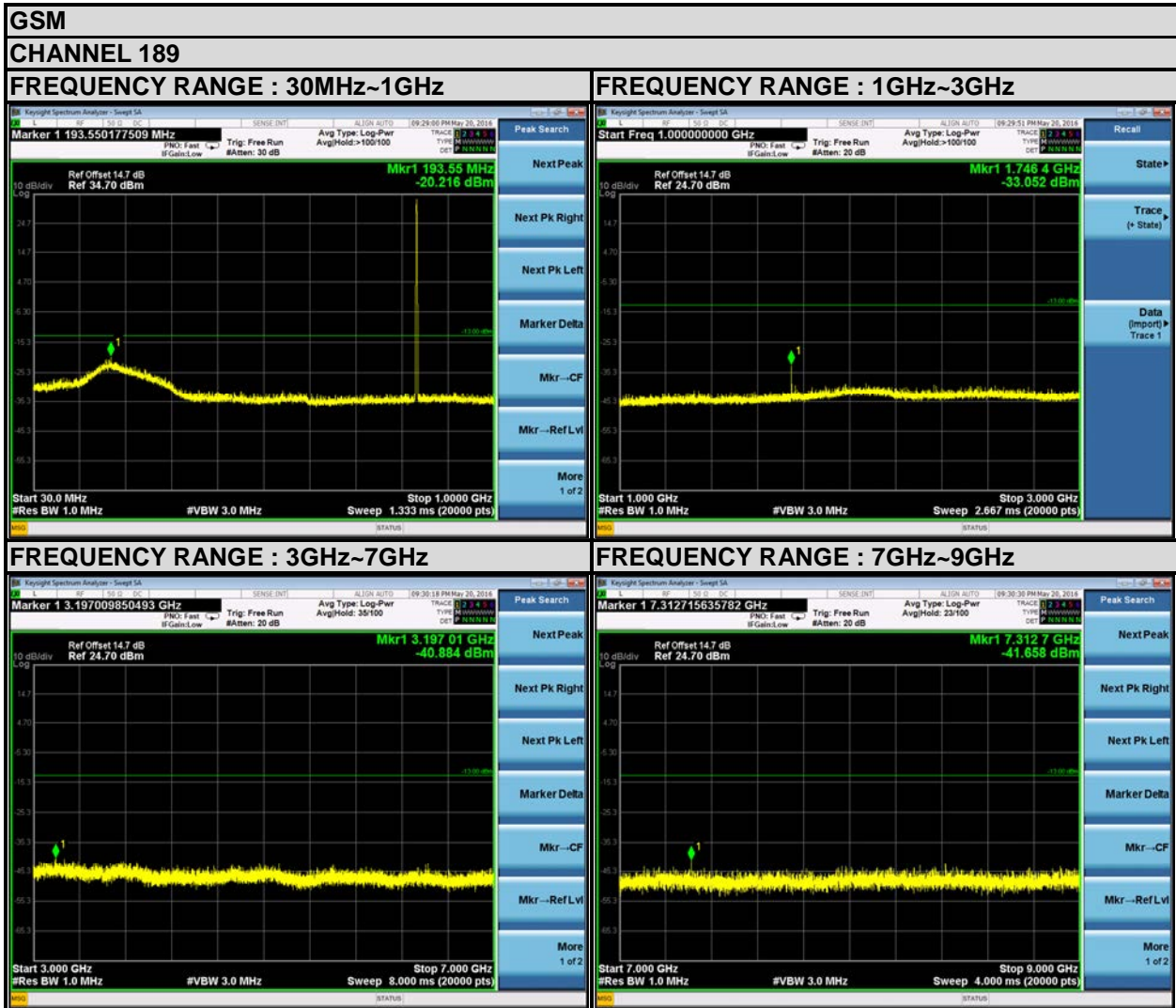

EDGE

CHANNEL 189

FREQUENCY RANGE : 30MHz~1GHz

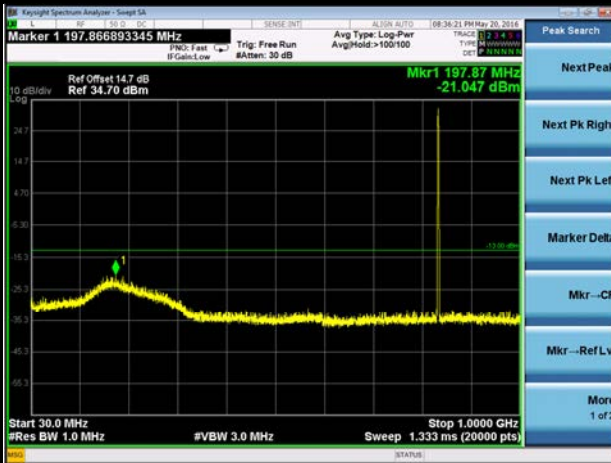

FREQUENCY RANGE : 1GHz~3GHz

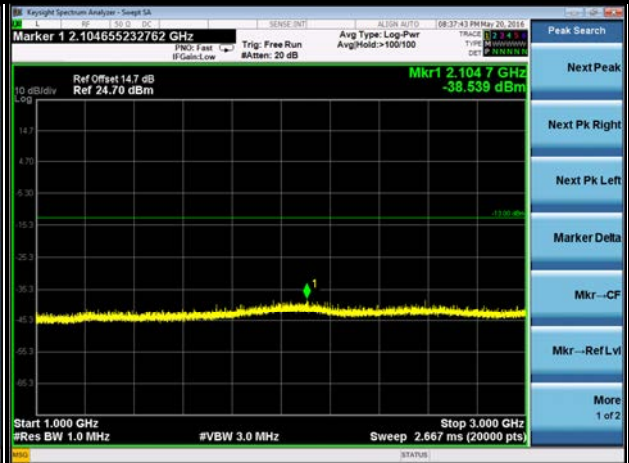

FREQUENCY RANGE : 3GHz~7GHz

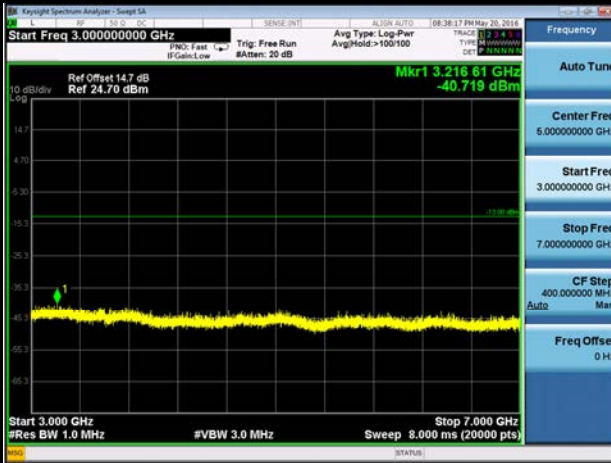

FREQUENCY RANGE : 7GHz~9GHz

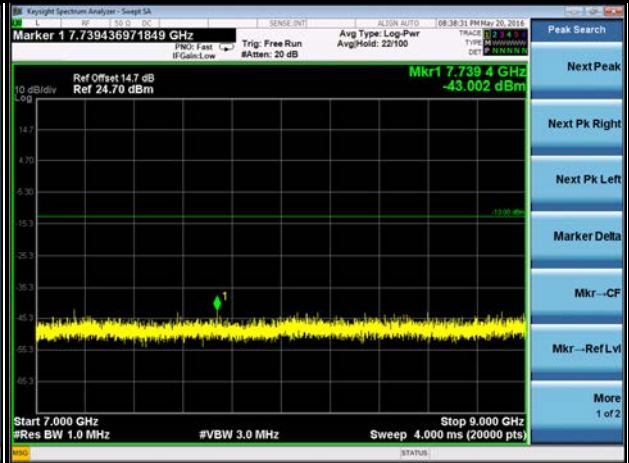

WCDMA

CHANNEL 4182

FREQUENCY RANGE : 30MHz~1GHz

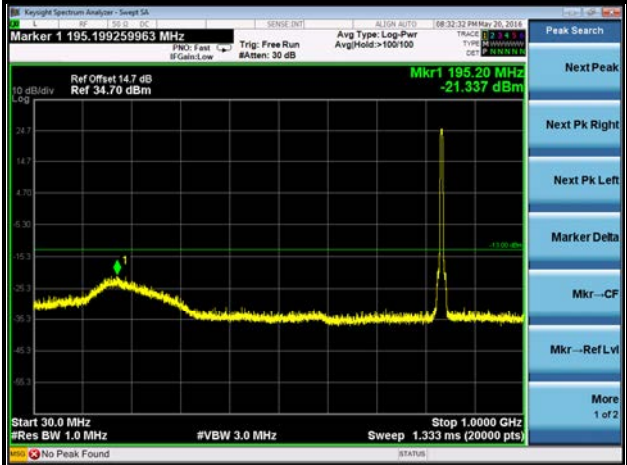

FREQUENCY RANGE : 1GHz~3GHz

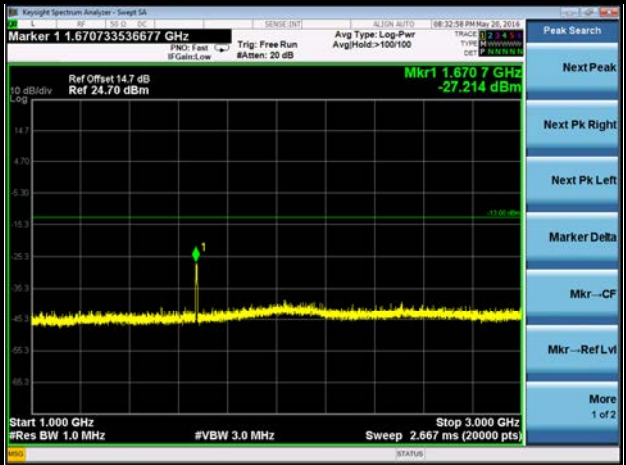

FREQUENCY RANGE : 3GHz~7GHz

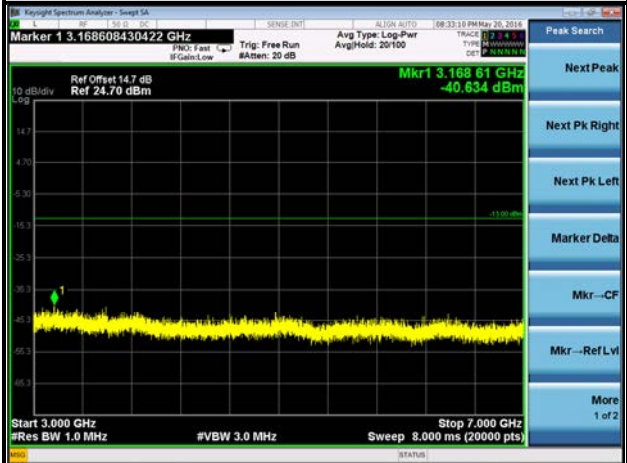

FREQUENCY RANGE : 7GHz~9GHz

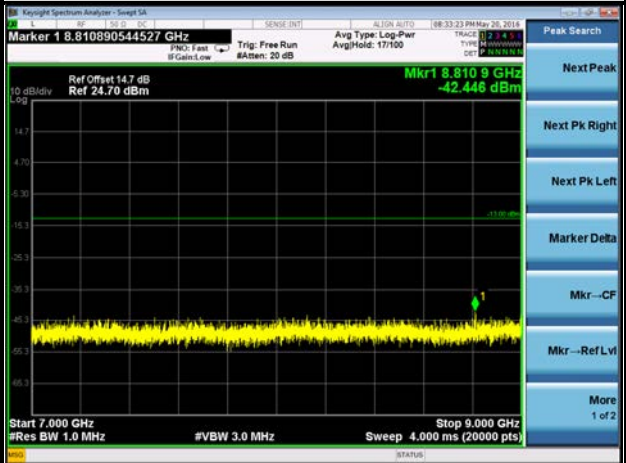

LTE Band 5 (Channel Bandwidth: 1.4MHz)

CHANNEL 20525

FREQUENCY RANGE : 30MHz~10.0GHz

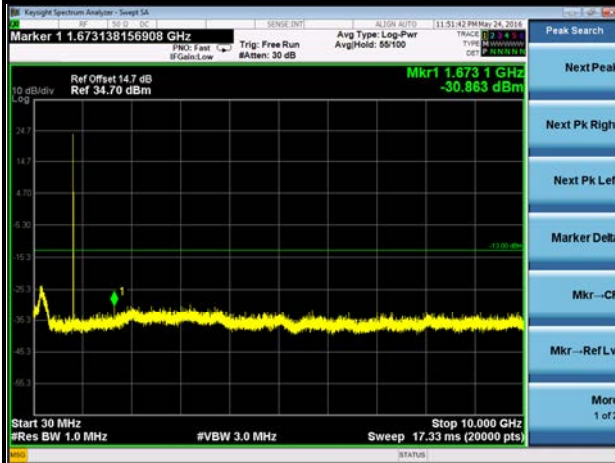

LTE Band 5 (Channel Bandwidth: 3MHz)

CHANNEL 20525

FREQUENCY RANGE : 30MHz~10.0GHz



LTE Band 5 (Channel Bandwidth: 5MHz)

CHANNEL 20525

FREQUENCY RANGE : 30MHz~10.0GHz

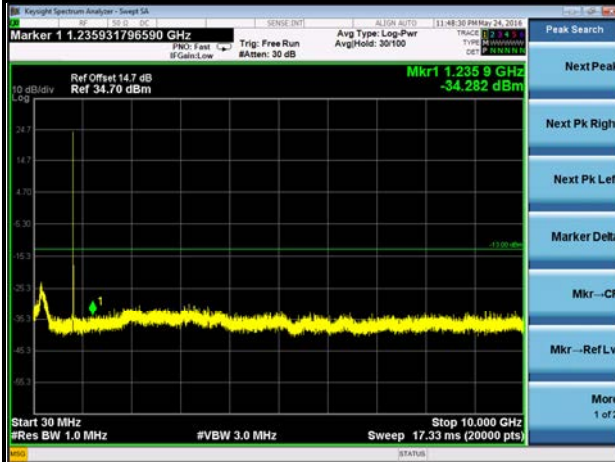

LTE Band 5 (Channel Bandwidth: 10MHz)

CHANNEL 20525

FREQUENCY RANGE : 30MHz~10.0GHz

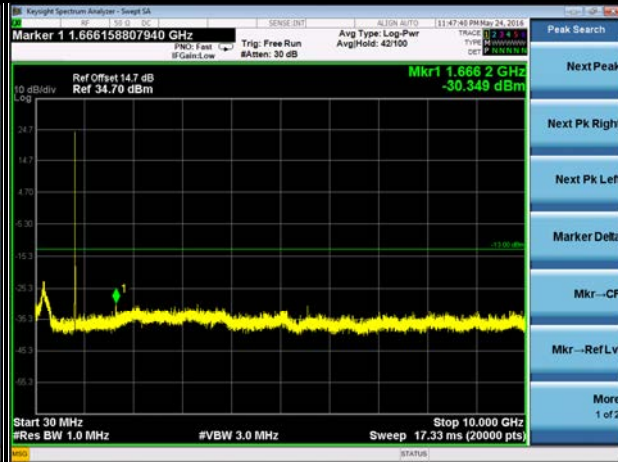

4.7 Radiated Emission Measurement

4.7.1 Limits of Radiated Emission Measurement

The power of any emission outside of the authorized operating frequency ranges must be attenuated below the transmitting power (P) by a factor of at least $43 + 10 \log(P)$ dB. The emission limit equal to -13dBm .

4.7.2 Test Procedure

- a. Substitution method is used for E.I.R.P measurement. In the semi-anechoic chamber, EUT placed on the 0.8m height of Turn Table, rotated the table around 360 degrees to search the maximum radiation power and receiver antenna shall be rotated vertical and horizontal polarization and moved height from 1m to 4m to find the maximum polar radiated power. The "Read Value" is the spectrum reading the maximum power value.
- b. The substitution horn antenna is substituted for EUT at the same position and signals generator export the CW signal to the substitution antenna via a TX cable. Rotated the Turn Table and moved receiving antenna to find the maximum radiation power. Adjust output power level of S.G to get a Value of spectrum reading equal to "Read Value " of step a. Record the power level of S.G
- c. $\text{EIRP} = \text{Output power level of S.G} - \text{TX cable loss} + \text{Antenna gain of substitution horn}$.
- d. E.R.P power can be calculated form E.I.R.P power by subtracting the gain of dipole, $\text{E.R.P power} = \text{E.I.R.P power} - 2.15\text{dBi}$.

NOTE: The resolution bandwidth and video bandwidth of test receiver/spectrum analyzer is 1MHz/3MHz.

4.7.3 Deviation from Test Standard

No deviation.

4.7.4 Test Setup

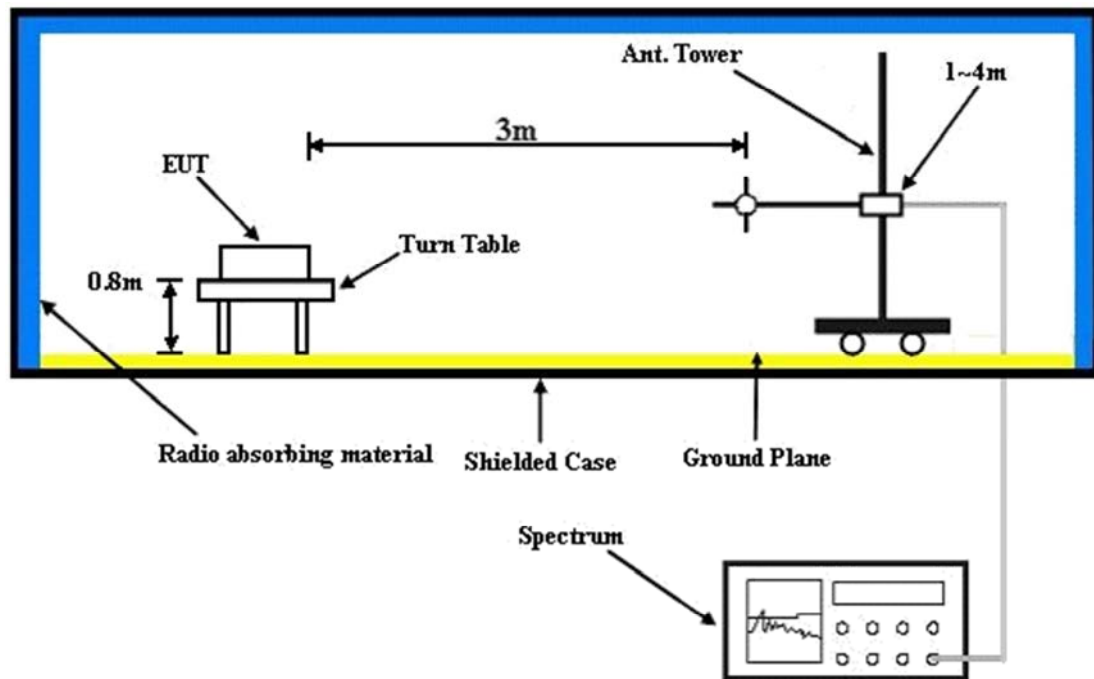

For the actual test configuration, please refer to the attached file (Test Setup Photo).

4.7.5 Test Results

BELOW 1GHz WORST-CASE DATA

GSM 850:

MODE	TX channel 189	FREQUENCY RANGE	Below 1000MHz
ENVIRONMENTAL CONDITIONS	26deg. C, 56%RH	INPUT POWER	DC 5V from adapter
TESTED BY	Alex Chen		
ANTENNA POLARITY & TEST DISTANCE: HORIZONTAL AT 3 M			

	Freq	Level	Read Level	Limit Line	Over Limit	Factor	Pol/Phase	Remark
	MHz	dBm/m	dBm	dBm/m	dB	dB/m		
1	PP	42.610	-30.36	-40.14	-13.00	-17.36	9.78	Horizontal Peak
2		92.080	-63.33	-53.84	-13.00	-50.33	-9.49	Horizontal Peak
3		176.470	-77.85	-59.96	-13.00	-64.85	-17.89	Horizontal Peak
4		384.050	-75.31	-64.32	-13.00	-62.31	-10.99	Horizontal Peak
5		486.870	-71.45	-61.06	-13.00	-58.45	-10.39	Horizontal Peak
6		825.400	-60.29	-56.38	-13.00	-47.29	-3.91	Horizontal Peak

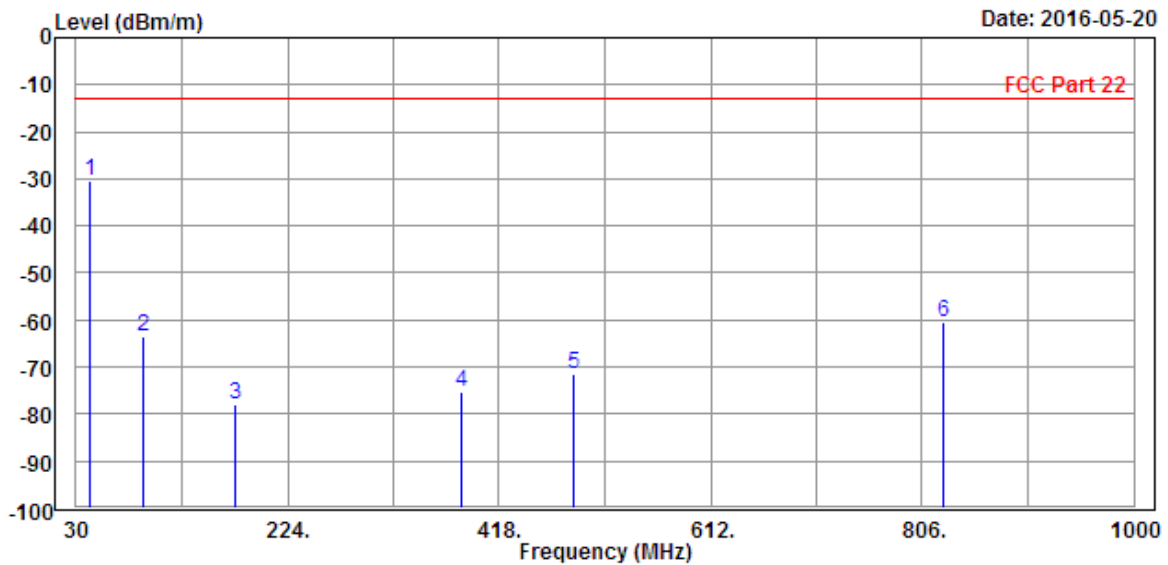

MODE	TX channel 189	FREQUENCY RANGE	Below 1000MHz
ENVIRONMENTAL CONDITIONS	26deg. C, 56%RH	INPUT POWER	DC 5V from adapter
TESTED BY	Alex Chen		
ANTENNA POLARITY & TEST DISTANCE: VERTICAL AT 3 M			

	Freq	Level	Read Level	Limit Line	Over Limit	Factor	Pol/Phase	Remark
	MHz	dBm/m	dBm	dBm/m	dB	dB/m		
1 PP	43.580	-32.22	-29.58	-13.00	-19.22	-2.64	Vertical	Peak
2	89.170	-62.42	-51.91	-13.00	-49.42	-10.51	Vertical	Peak
3	210.420	-71.61	-60.79	-13.00	-58.61	-10.82	Vertical	Peak
4	304.510	-73.65	-62.37	-13.00	-60.65	-11.28	Vertical	Peak
5	538.280	-62.71	-55.43	-13.00	-49.71	-7.28	Vertical	Peak
6	897.180	-58.75	-56.22	-13.00	-45.75	-2.53	Vertical	Peak

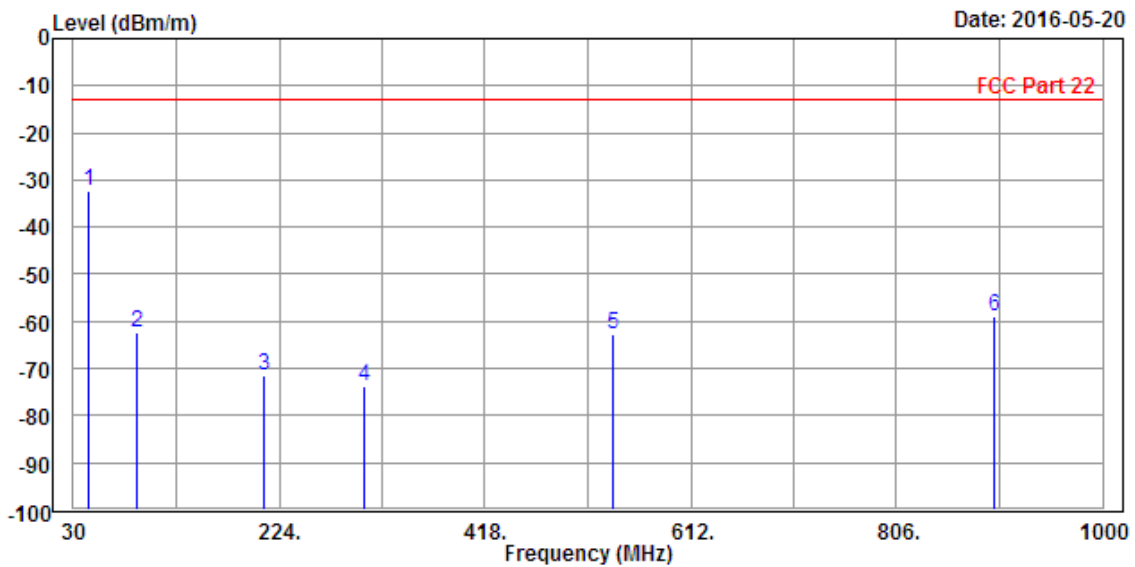

ABOVE 1GHz DATA

GSM 850:

MODE	TX channel 189	FREQUENCY RANGE	Above 1000MHz
ENVIRONMENTAL CONDITIONS	26deg. C, 56%RH	INPUT POWER	DC 5V from adapter
TESTED BY	Alex Chen		
ANTENNA POLARITY & TEST DISTANCE: HORIZONTAL AT 3 M			

			Read	Limit	Over		
	Freq	Level	Level	Line	Limit	Factor	Remark
	MHz	dBm/m	dBm	dBm/m	dB	dB/m	
1	PP 1666.000	-45.49	-40.67	-13.00	-32.49	-4.82	Peak
2	2512.000	-50.89	-49.30	-13.00	-37.89	-1.59	Peak

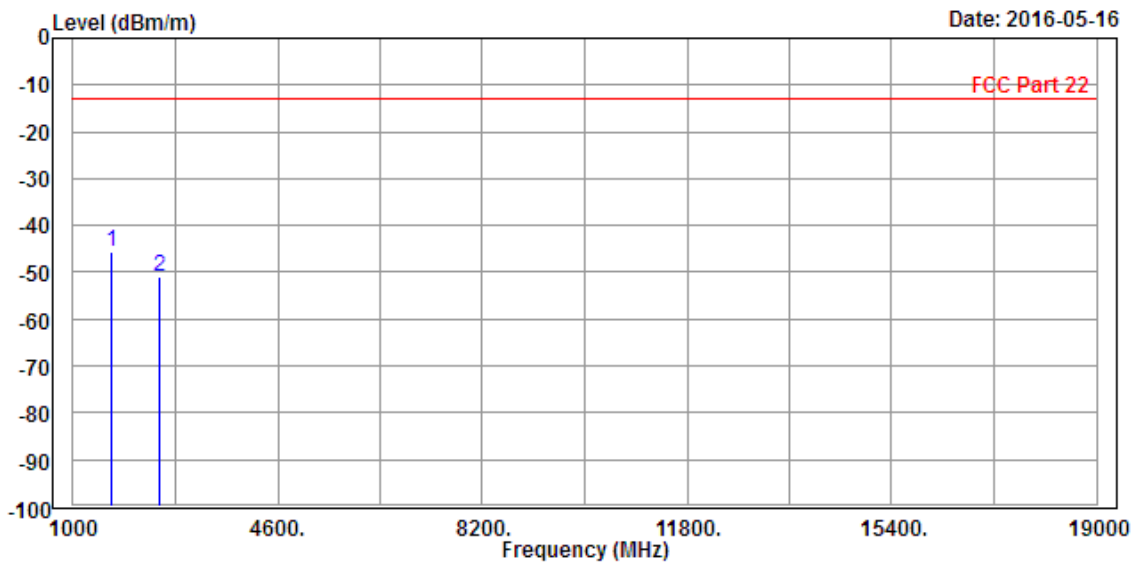



A D T

MODE	TX channel 189	FREQUENCY RANGE	Above 1000MHz
ENVIRONMENTAL CONDITIONS	26deg. C, 56%RH	INPUT POWER	DC 5V from adapter
TESTED BY	Alex Chen		
ANTENNA POLARITY & TEST DISTANCE: VERTICAL AT 3 M			

			Read	Limit	Over		
	Freq	Level	Level	Line	Limit	Factor	Remark
	MHz	dBm/m	dBm	dBm/m	dB	dB/m	
1	PP 1666.000	-48.21	-44.83	-13.00	-35.21	-3.38	Peak
2	2512.000	-48.38	-48.26	-13.00	-35.38	-0.12	Peak

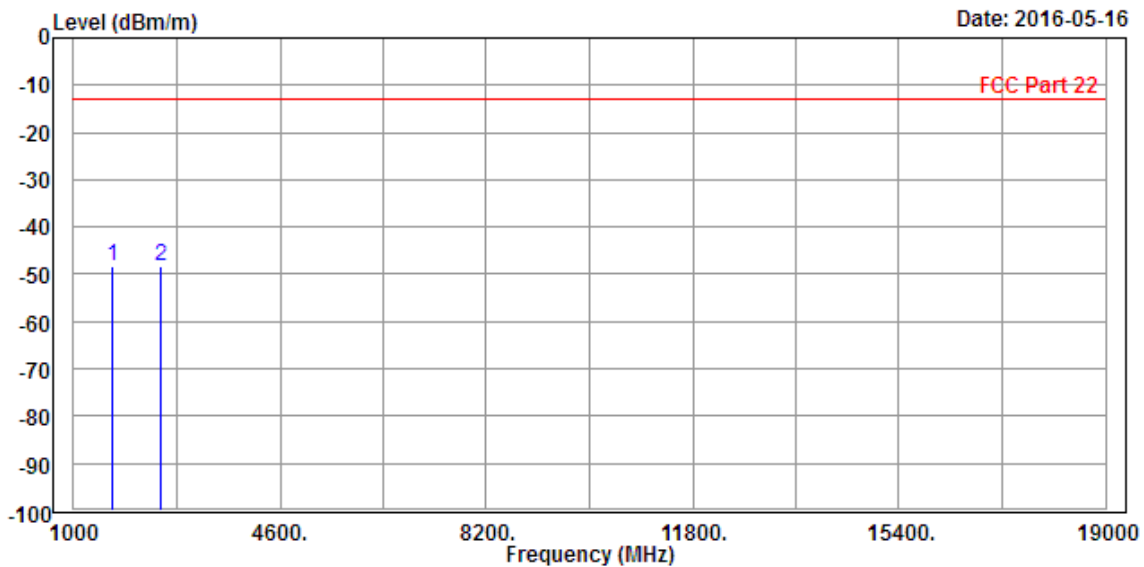



EDGE 850:

MODE	TX channel 189	FREQUENCY RANGE	Above 1000MHz
ENVIRONMENTAL CONDITIONS	26deg. C, 56%RH	INPUT POWER	DC 5V from adapter
TESTED BY	Alex Chen		
ANTENNA POLARITY & TEST DISTANCE: HORIZONTAL AT 3 M			

	Freq	Level	Read Level	Limit Line	Over Limit	Factor	Remark
	MHz	dBm/m	dBm	dBm/m	dB	dB/m	
1 PP	1666.000	-54.98	-50.16	-13.00	-41.98	-4.82	Peak
2	2512.000	-56.56	-54.97	-13.00	-43.56	-1.59	Peak

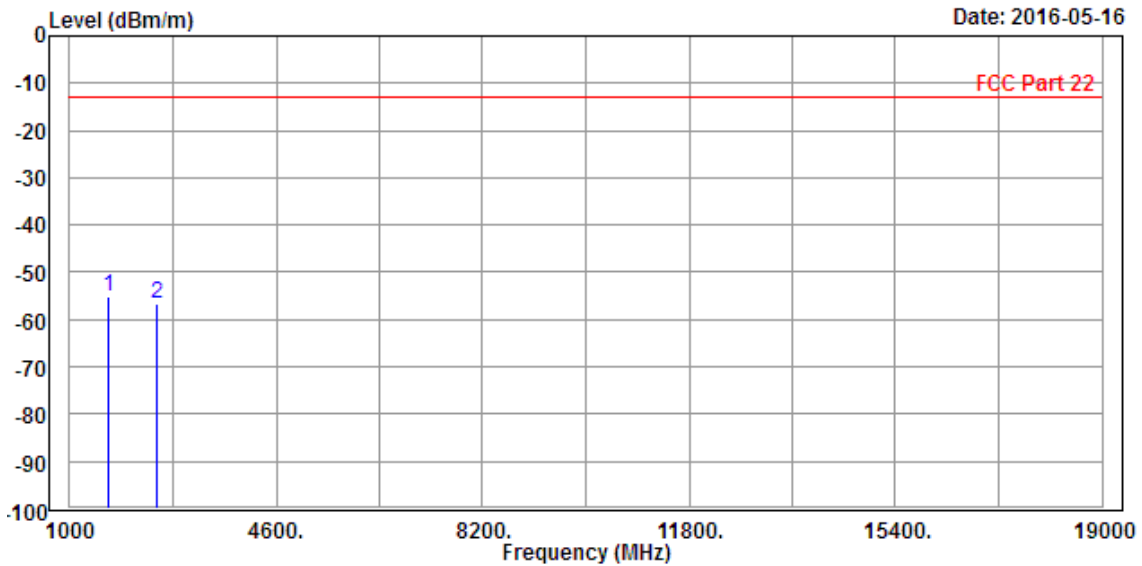

MODE	TX channel 189	FREQUENCY RANGE	Above 1000MHz
ENVIRONMENTAL CONDITIONS	26deg. C, 56%RH	INPUT POWER	DC 5V from adapter
TESTED BY	Alex Chen		
ANTENNA POLARITY & TEST DISTANCE: VERTICAL AT 3 M			

	Freq	Level	Read Level	Limit Line	Over Limit	Factor	Remark
	MHz	dBm/m	dBm	dBm/m	dB	dB/m	
1 PP	1666.000	-53.76	-50.38	-13.00	-40.76	-3.38	Peak
2	2512.000	-53.82	-53.70	-13.00	-40.82	-0.12	Peak

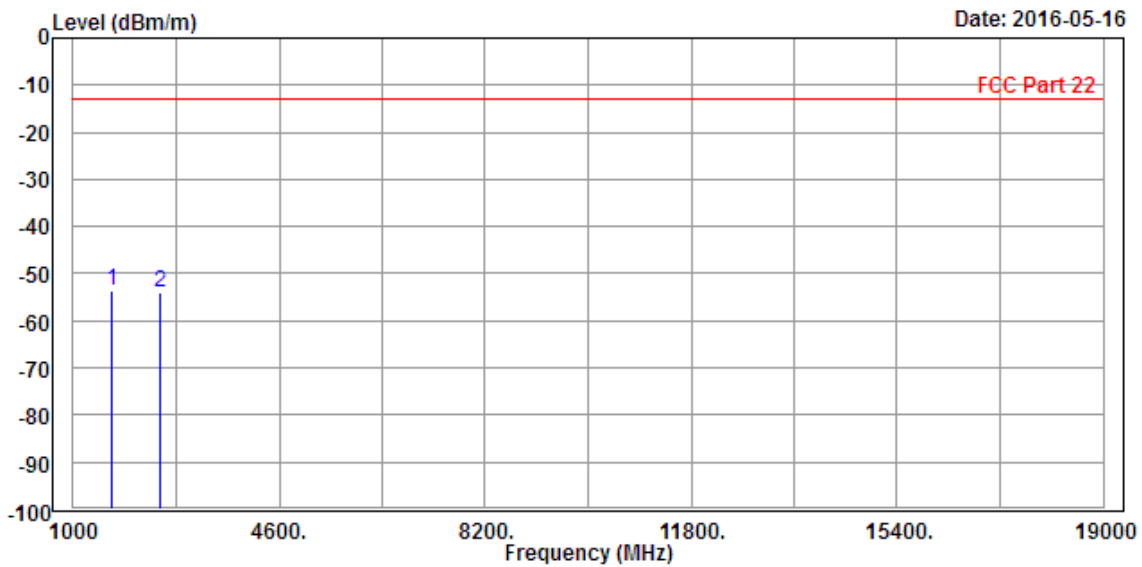

WCDMA Band V:

MODE	TX channel 4182	FREQUENCY RANGE	Above 1000MHz
ENVIRONMENTAL CONDITIONS	26deg. C, 56%RH	INPUT POWER	DC 5V from adapter
TESTED BY	Alex Chen		
ANTENNA POLARITY & TEST DISTANCE: HORIZONTAL AT 3 M			

	Freq	Level	Read Level	Limit Line	Over Limit	Factor	Remark
	MHz	dBm/m	dBm	dBm/m	dB	dB/m	
1	PP 1666.000	-53.94	-49.12	-13.00	-40.94	-4.82	Peak
2	2512.000	-56.08	-54.49	-13.00	-43.08	-1.59	Peak

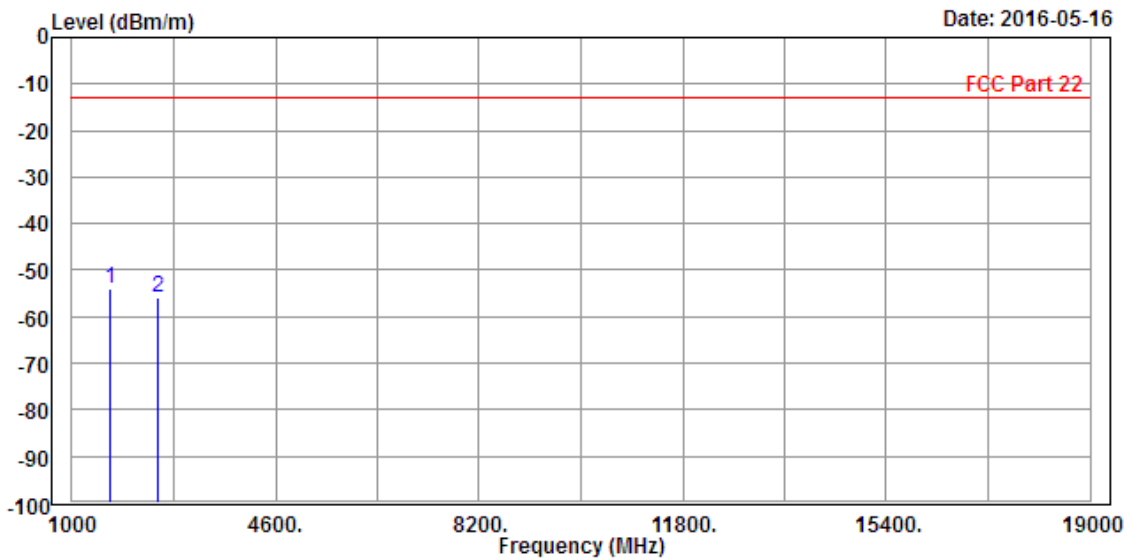

MODE	TX channel 4182	FREQUENCY RANGE	Above 1000MHz
ENVIRONMENTAL CONDITIONS	26deg. C, 56%RH	INPUT POWER	DC 5V from adapter
TESTED BY	Alex Chen		
ANTENNA POLARITY & TEST DISTANCE: VERTICAL AT 3 M			

	Read	Limit	Over		
Freq	Level	Level	Line	Limit	Factor Remark
MHz	dBm/m	dBm	dBm/m	dB	dB/m
1 PP 1666.000	-53.57	-50.19	-13.00	-40.57	-3.38 Peak
2 2512.000	-54.59	-54.47	-13.00	-41.59	-0.12 Peak

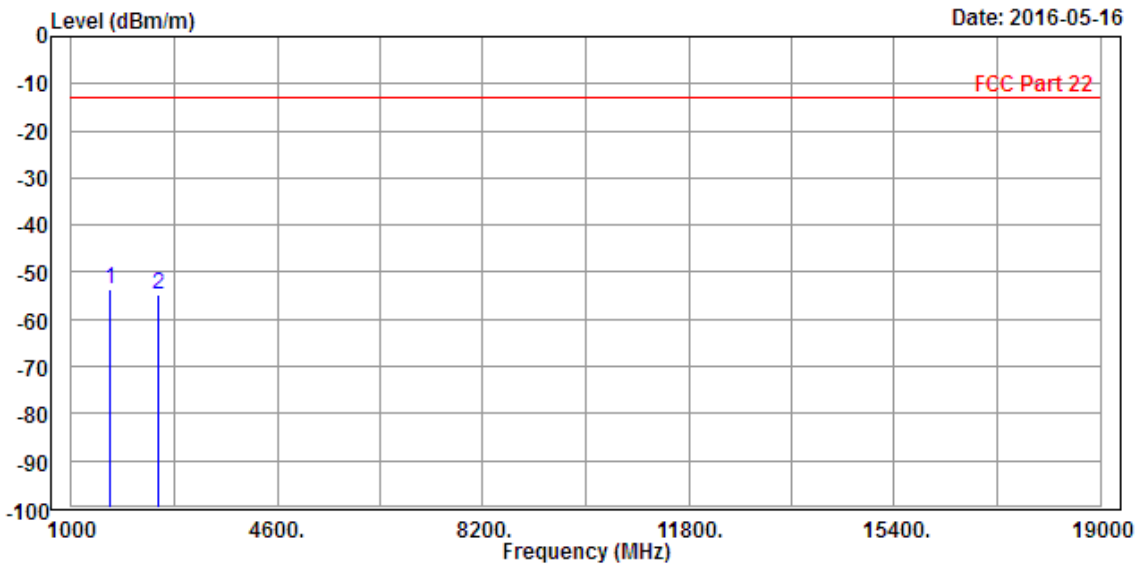



A D T

LTE Band 5

CHANNEL BANDWIDTH: 1.4MHz / QPSK

MODE	TX channel 20525	FREQUENCY RANGE	Above 1000MHz
ENVIRONMENTAL CONDITIONS	26deg. C, 56%RH	INPUT POWER	DC 5V from adapter
TESTED BY	Alex Chen		
ANTENNA POLARITY & TEST DISTANCE: HORIZONTAL AT 3 M			

	Read	Limit	Over	
Freq	Level	Level	Line	Limit Factor Remark
MHz	dBm/m	dBm	dBm/m	dB dB/m
1 PP 1666.000	-54.69	-49.87	-13.00	-41.69 -4.82 Peak
2 2502.000	-56.44	-54.81	-13.00	-43.44 -1.63 Peak

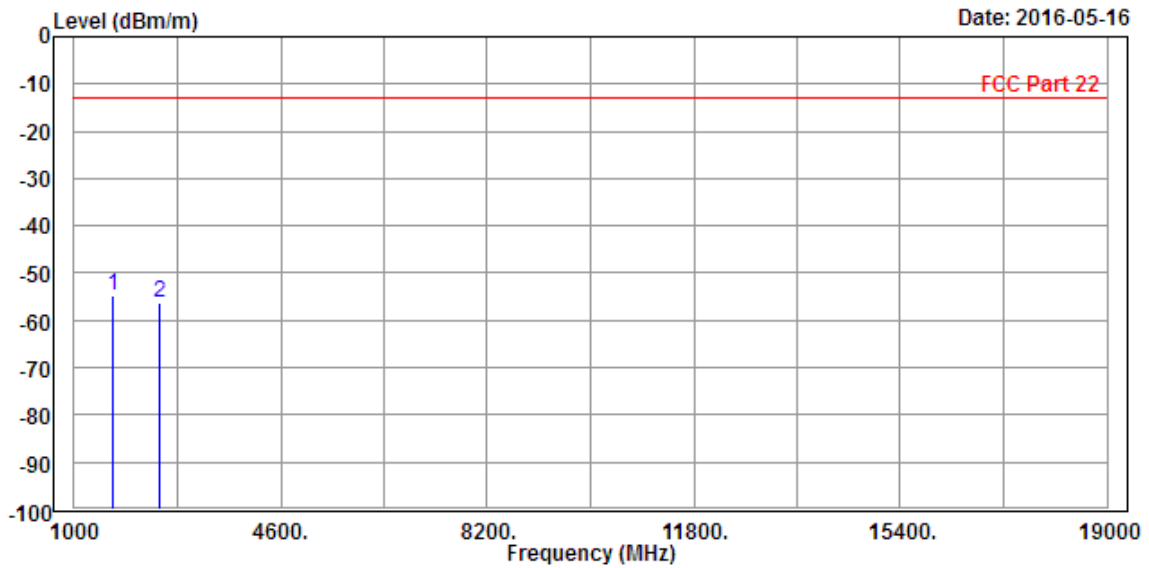

MODE	TX channel 20525	FREQUENCY RANGE	Above 1000MHz
ENVIRONMENTAL CONDITIONS	26deg. C, 56%RH	INPUT POWER	DC 5V from adapter
TESTED BY	Alex Chen		
ANTENNA POLARITY & TEST DISTANCE: VERTICAL AT 3 M			

	Freq	Level	Read Level	Limit Line	Over Limit	Factor	Remark
	MHz	dBm/m	dBm	dBm/m	dB	dB/m	
1 PP	1666.000	-49.08	-45.70	-13.00	-36.08	-3.38	Peak
2	2502.000	-55.36	-55.20	-13.00	-42.36	-0.16	Peak

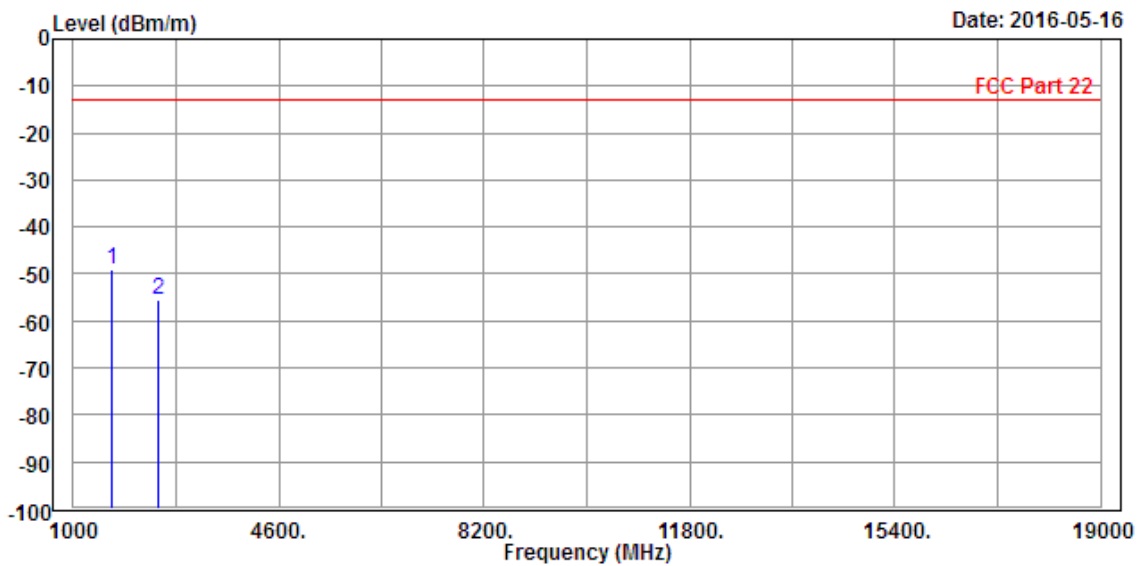

CHANNEL BANDWIDTH: 3MHz / QPSK

MODE	TX channel 20525	FREQUENCY RANGE	Above 1000MHz
ENVIRONMENTAL CONDITIONS	26deg. C, 56%RH	INPUT POWER	DC 5V from adapter
TESTED BY	Alex Chen		
ANTENNA POLARITY & TEST DISTANCE: HORIZONTAL AT 3 M			

	Freq	Level	Read Level	Limit Line	Over Limit	Factor	Remark
	MHz	dBm/m	dBm	dBm/m	dB	dB/m	
1 PP	1666.000	-53.88	-49.06	-13.00	-40.88	-4.82	Peak
2	2502.000	-57.27	-55.64	-13.00	-44.27	-1.63	Peak

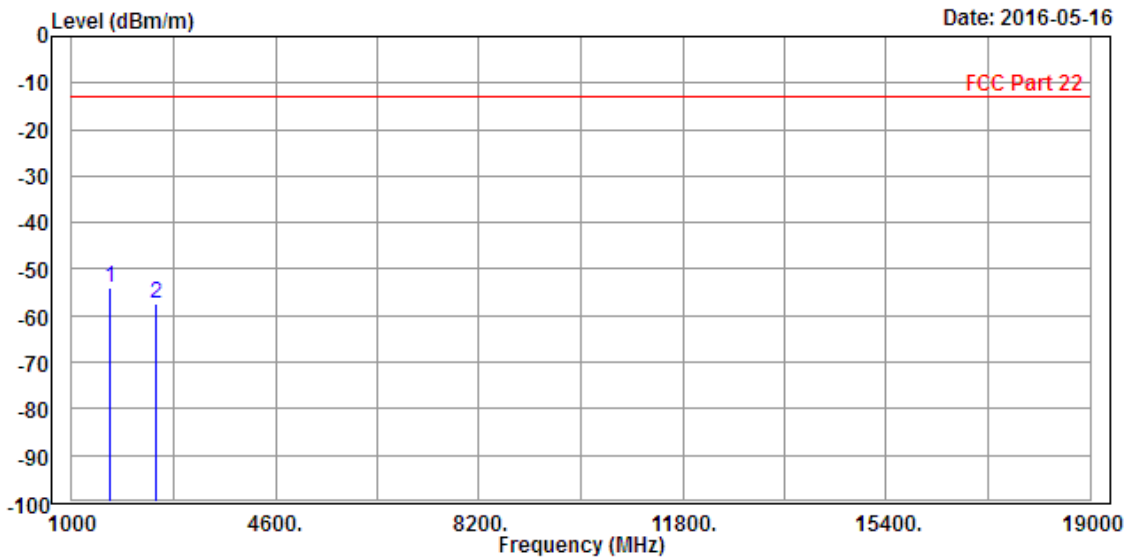

MODE	TX channel 20525	FREQUENCY RANGE	Above 1000MHz
ENVIRONMENTAL CONDITIONS	26deg. C, 56%RH	INPUT POWER	DC 5V from adapter
TESTED BY	Alex Chen		
ANTENNA POLARITY & TEST DISTANCE: VERTICAL AT 3 M			

	Freq	Level	Read Level	Limit Line	Over Limit	Factor	Remark
	MHz	dBm/m	dBm	dBm/m	dB	dB/m	
1 PP	1666.000	-48.71	-45.33	-13.00	-35.71	-3.38	Peak
2	2502.000	-54.38	-54.22	-13.00	-41.38	-0.16	Peak

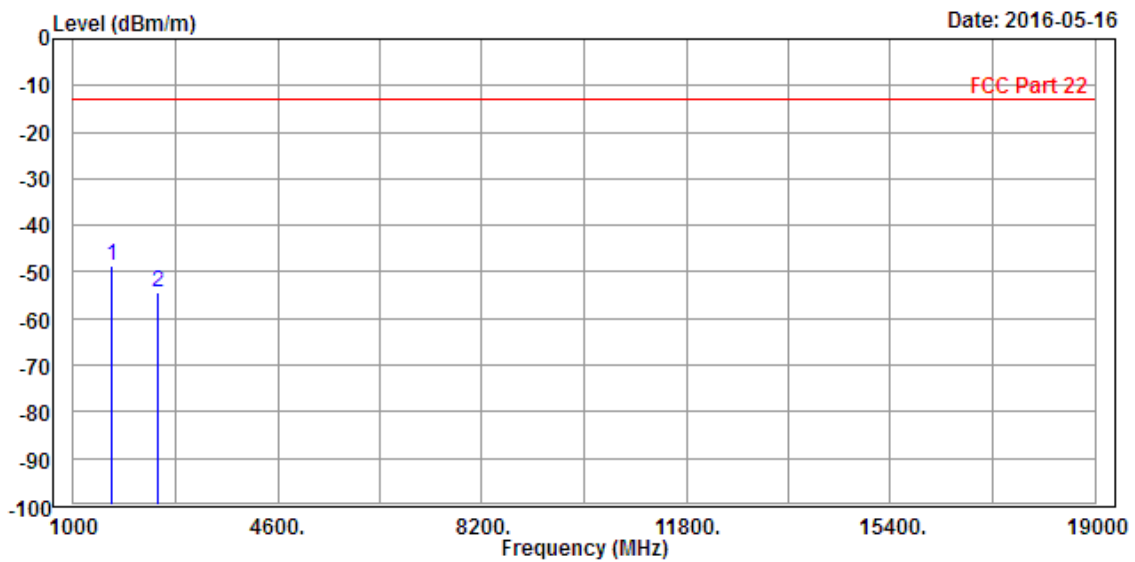

CHANNEL BANDWIDTH: 5MHz / QPSK

MODE	TX channel 20525	FREQUENCY RANGE	Above 1000MHz
ENVIRONMENTAL CONDITIONS	26deg. C, 56%RH	INPUT POWER	DC 5V from adapter
TESTED BY	Alex Chen		
ANTENNA POLARITY & TEST DISTANCE: HORIZONTAL AT 3 M			

	Freq	Level	Read Level	Limit Line	Over Limit	Factor	Remark
	MHz	dBm/m	dBm	dBm/m	dB	dB/m	
1 PP	1666.000	-53.45	-48.63	-13.00	-40.45	-4.82	Peak
2	2502.000	-54.63	-53.00	-13.00	-41.63	-1.63	Peak

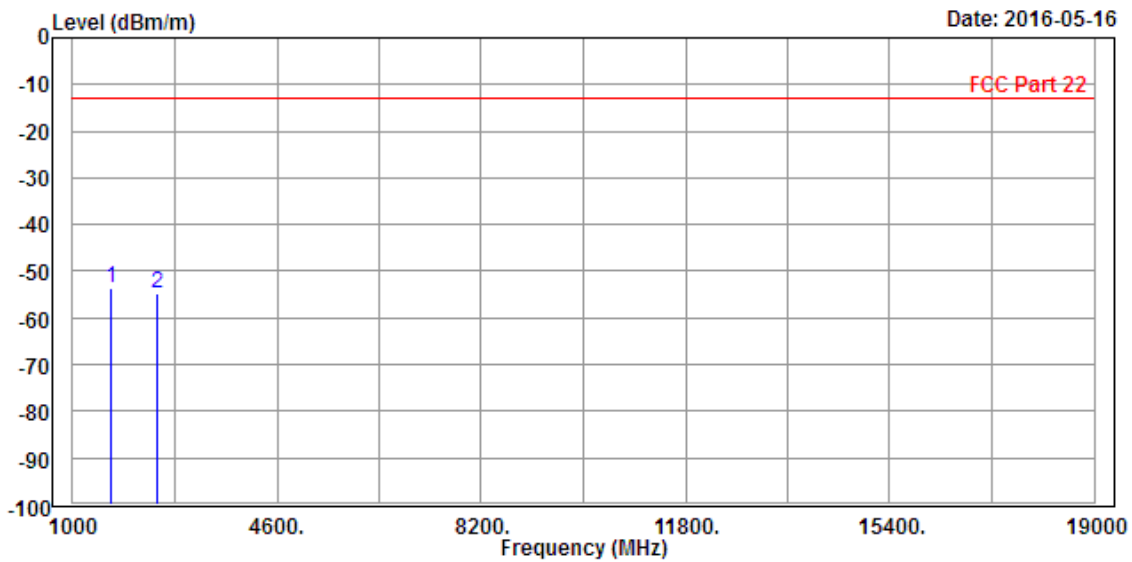

MODE	TX channel 20525	FREQUENCY RANGE	Above 1000MHz
ENVIRONMENTAL CONDITIONS	26deg. C, 56%RH	INPUT POWER	DC 5V from adapter
TESTED BY	Alex Chen		
ANTENNA POLARITY & TEST DISTANCE: VERTICAL AT 3 M			

		Read	Limit	Over		
	Freq	Level	Level	Line	Limit	Factor Remark
	MHz	dBm/m	dBm	dBm/m	dB	dB/m
1	PP 1666.000	-47.41	-44.03	-13.00	-34.41	-3.38 Peak
2	2502.000	-49.89	-49.73	-13.00	-36.89	-0.16 Peak

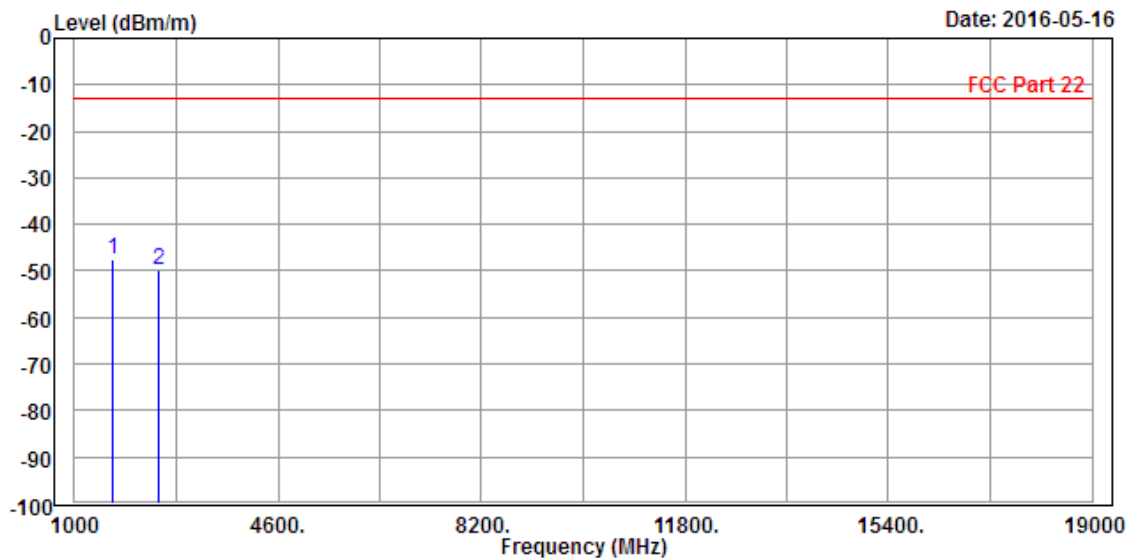



CHANNEL BANDWIDTH: 10MHz / QPSK

MODE	TX channel 20525	FREQUENCY RANGE	Above 1000MHz
ENVIRONMENTAL CONDITIONS	26deg. C, 56%RH	INPUT POWER	DC 5V from adapter
TESTED BY	Alex Chen		
ANTENNA POLARITY & TEST DISTANCE: HORIZONTAL AT 3 M			

	Freq	Level	Read Level	Limit Line	Over Limit	Factor	Remark
	MHz	dBm/m	dBm	dBm/m	dB	dB/m	
1 PP	1666.000	-50.39	-45.57	-13.00	-37.39	-4.82	Peak
2	2512.000	-55.46	-53.87	-13.00	-42.46	-1.59	Peak

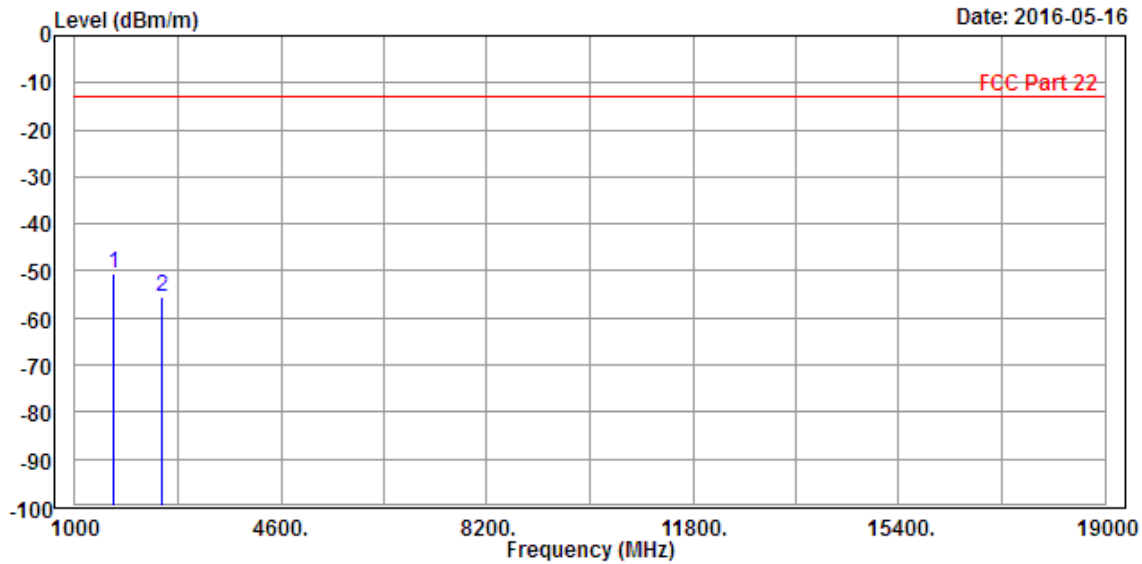

MODE	TX channel 20525	FREQUENCY RANGE	Above 1000MHz
ENVIRONMENTAL CONDITIONS	26deg. C, 56%RH	INPUT POWER	DC 5V from adapter
TESTED BY	Alex Chen		
ANTENNA POLARITY & TEST DISTANCE: VERTICAL AT 3 M			

	Freq	Level	Read Level	Limit Line	Over Limit	Factor	Remark
	MHz	dBm/m	dBm	dBm/m	dB	dB/m	
1 PP	1666.000	-47.92	-44.54	-13.00	-34.92	-3.38	Peak
2	2512.000	-54.47	-54.35	-13.00	-41.47	-0.12	Peak

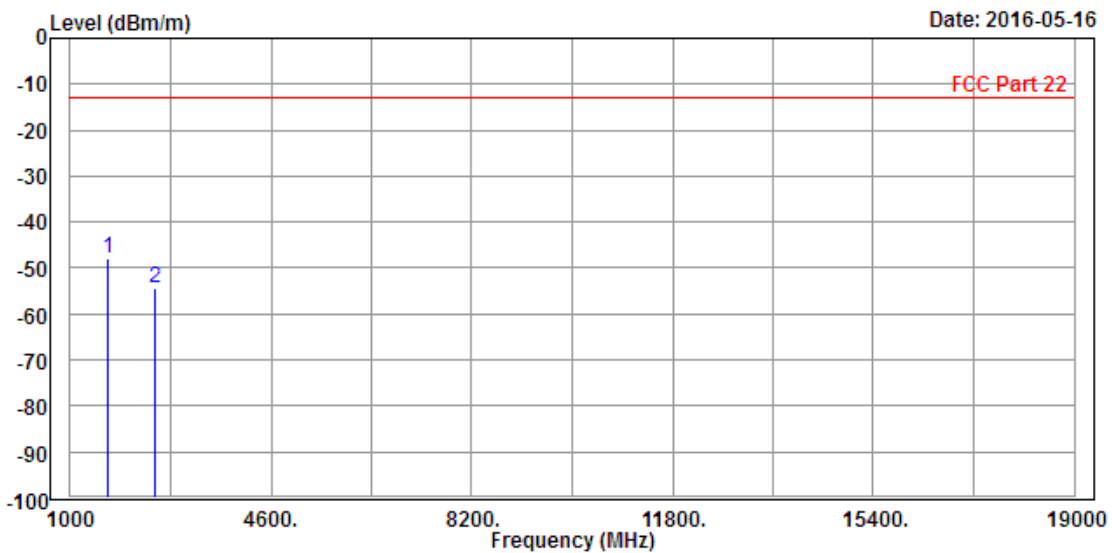

5 Pictures of Test Arrangements

Please refer to the attached file (Test Setup Photo).

Appendix – Information on the Testing Laboratories

We, Bureau Veritas Consumer Products Services (H.K.) Ltd., Taoyuan Branch, were founded in 1988 to provide our best service in EMC, Radio, Telecom and Safety consultation. Our laboratories are accredited and approved according to ISO/IEC 17025.

If you have any comments, please feel free to contact us at the following:

Linko EMC/RF Lab

Tel: 886-2-26052180

Fax: 886-2-26051924

Hsin Chu EMC/RF Lab/Telecom Lab

Tel: 886-3-5935343

Fax: 886-3-5935342

Hwa Ya EMC/RF/Safety

Tel: 886-3-3183232

Fax: 886-3-3270892

Email: service.adt@tw.bureauveritas.com

Web Site: www.bureauveritas-adt.com

The address and road map of all our labs can be found in our web site also.

--- END ---