

# FCC TEST REPORT (WLAN)

**Report No.:** RF160504W010-2

**FCC ID:** 2AD0BF20

**Test Model:** Hisense F20

**Received Date:** May 04, 2016

**Test Date:** May 05, 2016 ~ Jun. 02, 2016

**Issued Date:** Jun. 03, 2016

**Applicant:** Hisense International Co., Ltd.

**Address:** Floor 22, Hisense Tower, 17 Donghai Xi Road, Qingdao,  
266071, China

**Issued By:** Bureau Veritas Consumer Products Services (H.K.) Ltd.,  
Taoyuan Branch

**Lab Address:** No. 47-2, 14th Ling, Chia Cau Vil., Lin Kou Dist., New Taipei  
City, Taiwan (R.O.C.)

**Test Location:** No. 19, Hwa Ya 2nd Rd., Wen Hwa Tsuen, Kwei Shan Hsiang,  
Taoyuan Hsien 333, Taiwan, R.O.C.

This report should not be used by the client to claim product certification, approval, or endorsement by TAF or any government agencies.



This report is for your exclusive use. Any copying or replication of this report to or for any other person or entity, or use of our name or trademark, is permitted only with our prior written permission. This report sets forth our findings solely with respect to the test samples identified herein. The results set forth in this report are not indicative or representative of the quality or characteristics of the lot from which a test sample was taken or any similar or identical product specifically and expressly noted. Our report includes all of the tests requested by you and the results thereof based upon the information that you provided to us. You have 60 days from date of issuance of this report to notify us of any material error or omission caused by our negligence, provided, however, that such notice shall be in writing and shall specifically address the issue you wish to raise. A failure to raise such issue within the prescribed time shall constitute your unqualified acceptance of the completeness of this report, the tests conducted and the correctness of the report contents. Unless specific mention, the uncertainty of measurement has been explicitly taken into account to declare the compliance or non-compliance to the specification. The report must not be used by the client to claim product certification, approval, or endorsement by TAF or any government agencies.

**TABLE OF CONTENTS**

**RELEASE CONTROL RECORD ..... 4**

**1 Certificate of Conformity..... 5**

**2 Summary of Test Results ..... 6**

    2.1 Measurement Uncertainty ..... 6

**3 General Information..... 7**

    3.1 General Description of EUT ..... 7

    3.2 Description of Test Modes ..... 8

    3.2.1 Test Mode Applicability and Tested Channel Detail..... 9

    3.3 Duty Cycle of Test Signal ..... 11

    3.4 Description of Support Units ..... 12

    3.4.1 Configuration of System under Test ..... 12

    3.5 General Description of Applied Standards ..... 12

**4 Test Types and Results ..... 13**

    4.1 Radiated Emission and Bandedge Measurement..... 13

        4.1.1 Limits of Radiated Emission and Bandedge Measurement ..... 13

        4.1.2 Test Instruments ..... 14

        4.1.3 Test Procedures..... 15

        4.1.4 Deviation from Test Standard ..... 15

        4.1.5 Test Set Up ..... 16

        4.1.6 EUT Operating Conditions..... 16

        4.1.7 Test Results ..... 17

    4.2 Conducted Emission Measurement ..... 28

        4.2.1 Limits of Conducted Emission Measurement ..... 28

        4.2.2 Test Instruments ..... 28

        4.2.3 Test Procedures..... 29

        4.2.4 Deviation from Test Standard ..... 29

        4.2.5 Test Setup..... 29

        4.2.6 EUT Operating Conditions..... 29

        4.2.7 Test Results ..... 30

    4.3 6dB Bandwidth Measurement ..... 32

        4.3.1 Limits of 6dB Bandwidth Measurement ..... 32

        4.3.2 Test Setup..... 32

        4.3.3 Test Instruments ..... 32

        4.3.4 Test Procedure ..... 32

        4.3.5 Deviation from Test Standard ..... 32

        4.3.6 EUT Operating Conditions..... 32

        4.3.7 Test Result..... 33

    4.4 Conducted Output Power Measurement..... 35

        4.4.1 Limits of Conducted Output Power Measurement ..... 35

        4.4.2 Test Setup..... 35

        4.4.3 Test Instruments ..... 35

        4.4.4 Test Procedures..... 35

        4.4.5 Deviation from Test Standard ..... 35

        4.4.6 EUT Operating Conditions..... 35

        4.4.7 Test Results ..... 36

            4.4.7.1 Maximum Peak Output Power ..... 36

            4.4.7.2 Average Output Power (For Reference) ..... 37

    4.5 Power Spectral Density Measurement..... 38

        4.5.1 Limits of Power Spectral Density Measurement ..... 38

        4.5.2 Test Setup..... 38

        4.5.3 Test Instruments ..... 38

        4.5.4 Test Procedure ..... 38

        4.5.5 Deviation from Test Standard ..... 38

4.5.6 EUT Operating Condition .....	38
4.5.7 Test Results .....	39
4.6 Conducted Out of Band Emission Measurement .....	41
4.6.1 Limits of Conducted Out of Band Emission Measurement.....	41
4.6.2 Test Setup.....	41
4.6.3 Test Instruments .....	41
4.6.4 Test Procedure .....	41
4.6.5 Deviation from Test Standard .....	41
4.6.6 EUT Operating Condition .....	41
4.6.7 Test Results .....	42
<b>5 Pictures of Test Arrangements.....</b>	<b>45</b>
<b>Appendix – Information on the Testing Laboratories .....</b>	<b>46</b>



A D T

### RELEASE CONTROL RECORD

ISSUE NO.	REASON FOR CHANGE	DATE ISSUED
RF160504W010-2	Original release	Jun. 03, 2016



## 1 Certificate of Conformity

**Product:** Mobile phone  
**Brand:** Hisense  
**Test Model:** Hisense F20  
**Sample Status:** Identical Prototype  
**Applicant:** Hisense International Co., Ltd.  
**Test Date:** May 05, 2016 ~ Jun. 02, 2016  
**Standards:** **FCC Part 15, Subpart C (Section 15.247)**  
**ANSI C63.10: 2013**

The above equipment has been tested by **Bureau Veritas Consumer Products Services (H.K.) Ltd., Taoyuan Branch**, and found compliance with the requirement of the above standards. The test record, data evaluation & Equipment Under Test (EUT) configurations represented herein are true and accurate accounts of the measurements of the sample's EMC characteristics under the conditions specified in this report.

**Prepared by :**  , **Date:** Jun. 03, 2016  
Amyee Qian / Engineer

**Approved by :**  , **Date:** Jun. 03, 2016  
William Chung / Manager

## 2 Summary of Test Results

FCC Part 15, Subpart C (SECTION 15.247)			
FCC Clause	Test Item	Result	Remarks
15.207	AC Power Conducted Emission	PASS	Meet the requirement of limit. Minimum passing margin is 20.98dB at 1.820000MHz.
15.205 & 15.209	Band Edge Emission Measurement	PASS	Meet the requirement of limit. Minimum passing margin is -2.11dB at 2483.50MHz.
15.247(d)	Antenna Port Emission	PASS	Meet the requirement of limit.
15.247(a)(2)	6dB bandwidth	PASS	Meet the requirement of limit.
15.247(b)	Conducted power	PASS	Meet the requirement of limit.
15.247(e)	Power Spectral Density	PASS	Meet the requirement of limit.
15.203	Antenna Requirement	PASS	No antenna connector is used.

### 2.1 Measurement Uncertainty

Where relevant, the following measurement uncertainty levels have been estimated for tests performed on the EUT as specified in CISPR 16-4-2:

Measurement	Frequency	Expanded Uncertainty (k=2) (±)
Conducted Emissions at mains ports	9kHz ~ 30MHz	2.44 dB
Radiated Emissions up to 1 GHz	30MHz ~ 200MHz	2.93 dB
	200MHz ~ 1000MHz	2.95 dB
Radiated Emissions above 1 GHz	1GHz ~ 18GHz	2.26 dB
	18GHz ~ 40GHz	1.94 dB

This uncertainty represents an expanded uncertainty expressed at approximately the 95% confidence level using a coverage factor of  $k = 2$ .

### 3 General Information

#### 3.1 General Description of EUT

<b>Product</b>	Mobile phone
<b>Brand</b>	Hisense
<b>Test Model</b>	Hisense F20
<b>Power Supply Rating</b>	5.0Vdc (adapter or host equipment) 3.8Vdc (battery)
<b>Modulation Technology</b>	DSSS, OFDM
<b>Modulation Type</b>	CCK, DQPSK, DBPSK for DSSS 64QAM, 16QAM, QPSK, BPSK for OFDM
<b>Transfer Rate</b>	802.11b: 11/ 5.5/ 2.0 / 1.0 Mbps 802.11g: 54/ 48/ 36 / 24 / 18 / 9/ 6 Mbps 802.11n: up to 135 Mbps
<b>Operating Frequency</b>	2412 ~ 2462MHz for 11b/g/n(HT20)
<b>Number of Channel</b>	11 for 802.11b, 802.11g, 802.11n(20MHz)
<b>Output Power</b>	127.057 mW
<b>Antenna Type</b>	PIFA Antenna with 1.4dBi gain
<b>Accessory Device</b>	Refer to note as below
<b>Data Cable Supplied</b>	USB cable: shielded, detachable, 0.8m Earphone cable: Unshielded, detachable,0.8m

Note:

- The above EUT information is declared by manufacturer and for more detailed features description, please refer to the manufacturer's specifications or User's Manual.
- The EUT incorporates a MIMO function. Physically, the EUT provides two completed transmitters and two receivers.

Modulation Mode	TX Function
802.11b	1TX /1RX
802.11g	1TX /1RX
802.11n (HT20)	1TX /1RX

- The EUT was powered by the following adapter:

ADAPTER	
<b>BRAND:</b>	Hisense
<b>MODEL:</b>	A31-501000
<b>INPUT:</b>	AC 100-240V, 150mA
<b>OUTPUT:</b>	DC 5V, 1000mA

- The EUT matched the following USB Cable and Earphone.

USB CABLE	
<b>BRAND:</b>	SHENZHEN FKY-QY HARDWARE ELECTRONIC CO.,LTD
<b>MODEL:</b>	FKYM1-2828L08BKR/FKYM1-2828L08WHR
<b>SIGNAL LINE:</b>	0.8 METER

EARPHONE	
<b>BRAND:</b>	NEW LEADER
<b>MODEL:</b>	NLD-EM116T-055S NLD-EM116T-056S
<b>SIGNAL LINE:</b>	0.8 METER

- For the test results, the EUT had been tested with all conditions. But only the worst case was shown in test report.

### 3.2 Description of Test Modes

11 channels are provided for 802.11b, 802.11g and 802.11n (HT20):

Channel	Frequency	Channel	Frequency
1	2412MHz	7	2442MHz
2	2417MHz	8	2447MHz
3	2422MHz	9	2452MHz
4	2427MHz	10	2457MHz
5	2432MHz	11	2462MHz
6	2437MHz		



### 3.2.1 Test Mode Applicability and Tested Channel Detail

EUT CONFIGURE MODE	APPLICABLE TO				DESCRIPTION
	RE $\geq$ 1G	RE<1G	PLC	APCM	
-	√	√	√	√	-

Where RE $\geq$ 1G: Radiated Emission above 1GHz & Bandedge Measurement  
 RE<1G: Radiated Emission below 1GHz  
 PLC: Power Line Conducted Emission  
 APCM: Antenna Port Conducted Measurement

**NOTE:** The EUT had been pre-tested on the positioned of each 3 axis. The worst case was found when positioned on **Y-plane**.  
**NOTE:** "-" means no effect.

#### **Radiated Emission Test (Above 1GHz):**

- Pre-Scan has been conducted to determine the worst-case mode from all possible combinations between available modulations, data rates and antenna ports (if EUT with antenna diversity architecture).
- Following channel(s) was (were) selected for the final test as listed below.

EUT CONFIGURE MODE	MODE	AVAILABLE CHANNEL	TESTED CHANNEL	MODULATION TECHNOLOGY	MODULATION TYPE	DATA RATE (Mbps)
-	802.11b	1 to 11	1, 6, 11	DSSS	DBPSK	1.0
-	802.11g	1 to 11	1, 6, 11	OFDM	BPSK	6.0
-	802.11n (HT20)	1 to 11	1, 6, 11	OFDM	BPSK	7.2

#### **Radiated Emission Test (Below 1GHz):**

- Pre-Scan has been conducted to determine the worst-case mode from all possible combinations between available modulations, data rates and antenna ports (if EUT with antenna diversity architecture).
- Following channel(s) was (were) selected for the final test as listed below.

EUT CONFIGURE MODE	MODE	AVAILABLE CHANNEL	TESTED CHANNEL	MODULATION TECHNOLOGY	MODULATION TYPE	DATA RATE (Mbps)
-	802.11n (20MHz)	1 to 11	6	OFDM	BPSK	7.2

#### **Power Line Conducted Emission Test:**

- Pre-Scan has been conducted to determine the worst-case mode from all possible combinations between available modulations, data rates and antenna ports (if EUT with antenna diversity architecture).
- Following channel(s) was (were) selected for the final test as listed below.

EUT CONFIGURE MODE	MODE	AVAILABLE CHANNEL	TESTED CHANNEL	MODULATION TECHNOLOGY	MODULATION TYPE	DATA RATE (Mbps)
-	802.11b	1 to 11	1	DSSS	DBPSK	1.0

**BANDEDGE MEASUREMENT:**

Pre-Scan has been conducted to determine the worst-case mode from all possible combinations between available modulations, data rates and antenna ports (if EUT with antenna diversity architecture).

Following channel(s) was (were) selected for the final test as listed below.

EUT CONFIGURE MODE	MODE	AVAILABLE CHANNEL	TESTED CHANNEL	MODULATION TECHNOLOGY	MODULATION TYPE	DATA RATE (Mbps)
-	802.11b	1 to 11	1, 6, 11	DSSS	DBPSK	1.0
-	802.11g	1 to 11	1, 6, 11	OFDM	BPSK	6.0
-	802.11n (HT20)	1 to 11	1, 6, 11	OFDM	BPSK	7.2

**Antenna Port Conducted Measurement:**

This item includes all test value of each mode, but only includes spectrum plot of worst value of each mode.

Pre-Scan has been conducted to determine the worst-case mode from all possible combinations between available modulations, data rates and antenna ports (if EUT with antenna diversity architecture).

Following channel(s) was (were) selected for the final test as listed below.

EUT CONFIGURE MODE	MODE	AVAILABLE CHANNEL	TESTED CHANNEL	MODULATION TECHNOLOGY	MODULATION TYPE	DATA RATE (Mbps)
-	802.11b	1 to 11	1, 6, 11	DSSS	DBPSK	1.0
-	802.11g	1 to 11	1, 6, 11	OFDM	BPSK	6.0
-	802.11n (HT20)	1 to 11	1, 6, 11	OFDM	BPSK	7.2

**Test Condition:**

APPLICABLE TO	ENVIRONMENTAL CONDITIONS	INPUT POWER	TESTED BY
RE $\geq$ 1G	25deg. C, 65%RH	120Vac, 60Hz	Alex Chen
RE $<$ 1G	25deg. C, 65%RH	120Vac, 60Hz	Alex Chen
PLC	25deg. C, 68%RH	120Vac, 60Hz	Yuqiang Yin
APCM	21deg. C, 60%RH	120Vac, 60Hz	Wenliang Wu

### 3.3 Duty Cycle of Test Signal

#### WIFI 2.4GHz

**802.11b:** Duty cycle =  $0.181/0.188 = 0.963 < 98\%$ , Duty factor =  $10 * \log(1/0.963) = 0.16$

**802.11g:** Duty cycle =  $1.362/1.562 = 0.872 < 98\%$ , Duty factor =  $10 * \log(1/0.872) = 0.595$

**802.11n (HT20):** Duty cycle =  $1.275/1.475 = 0.864 < 98\%$ , Duty factor =  $10 * \log(1/0.864) = 0.635$

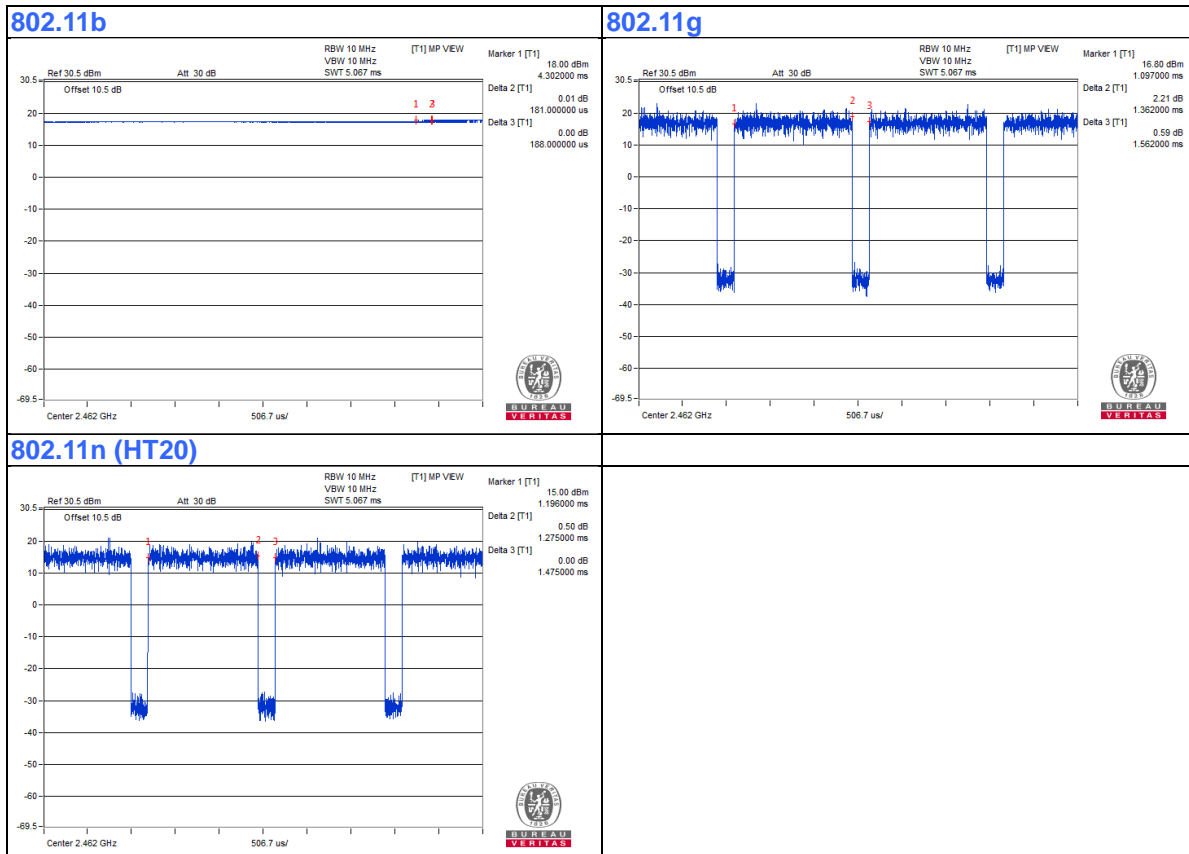

### 3.4 Description of Support Units

The EUT has been tested as an independent unit together with other necessary accessories or support units. The following support units or accessories were used to form a representative test configuration during the tests.

NO.	PRODUCT	BRAND	MODEL NO.	SERIAL NO.	FCC ID
1	DC source	LONG WEI	PS-6403D	010934269	N/A
2	PC	HP	A6608CN	3CR83825X3	N/A

NO.	SIGNAL CABLE DESCRIPTION OF THE ABOVE SUPPORT UNITS
1	DC Line: Unshielded, Detachable 1.0m
2	AC Line: Unshielded, Detachable 1.5m

#### 3.4.1 Configuration of System under Test

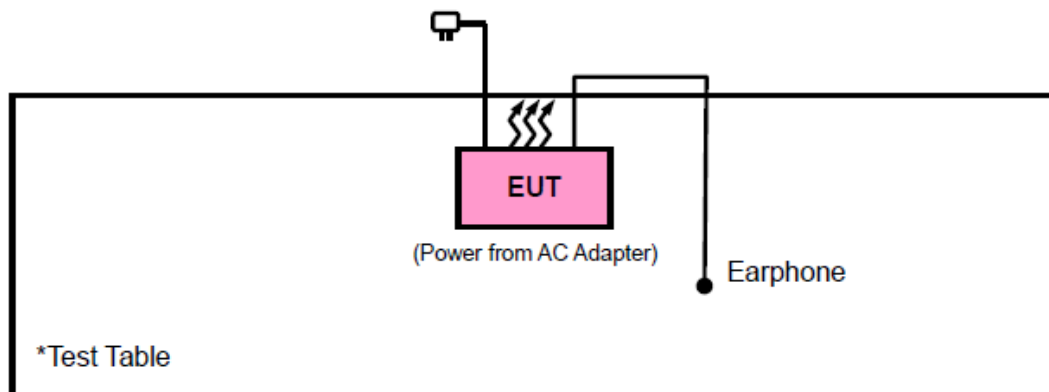

### 3.5 General Description of Applied Standards

The EUT is a RF Product. According to the specifications of the manufacturer, it must comply with the requirements of the following standards:

**FCC Part 15, Subpart C (15.247)**  
**558074 D01 DTS Meas Guidance v03r05**  
 ANSI C63.10-2013

All test items have been performed and recorded as per the above standards.

**NOTE:** The EUT has been verified to comply with the requirements of FCC Part 15, Subpart B, Class B (DoC). The test report has been issued separately.

## 4 Test Types and Results

### 4.1 Radiated Emission and Bandedge Measurement

#### 4.1.1 Limits of Radiated Emission and Bandedge Measurement

Radiated emissions which fall in the restricted bands must comply with the radiated emission limits specified as below table. Other emissions shall be at least 20dB below the highest level of the desired power:

Frequencies (MHz)	Field Strength (microvolts/meter)	Measurement Distance (meters)
0.009 ~ 0.490	2400/F(kHz)	300
0.490 ~ 1.705	24000/F(kHz)	30
1.705 ~ 30.0	30	30
30 ~ 88	100	3
88 ~ 216	150	3
216 ~ 960	200	3
Above 960	500	3

**NOTE:**

1. The lower limit shall apply at the transition frequencies.
2. Emission level (dBuV/m) = 20 log Emission level (uV/m).
3. For frequencies above 1000MHz, the field strength limits are based on average detector, however, the peak field strength of any emission shall not exceed the maximum permitted average limits, specified above by more than 20dB under any condition of modulation.

#### 4.1.2 Test Instruments

Equipment	Manufacturer	Model No.	Serial No.	Last Cal.	Next Cal.
EMI Test Receiver	Rohde&Schwarz	ESR7	101494	Apr. 05,16	Apr. 04,17
Bilog Antenna	Teseq	CBL 6111D	30643	Jul. 16, 15	Jul. 15, 16
Horn Antenna (1GHz -18GHz)	ETS -Lindgren	3117	00062558	May 30, 14	May 29, 17
Amplifier	Burgeon	BPA-530	100220	Apr. 05,16	Apr. 04,17
Pre-Amplifier (18GHz-40GHz)	EMCI	EMC 184045	980102	Nov. 20,15	Nov. 19,17
Pre-Amplifier	HP	8449B	3008A00409	Apr. 25,15	Apr. 24,17
GPS Generator+ Antenna	TOJOIN	GNSS-5000A	E1-010119	Aug. 08, 14	Aug. 07, 16
3m Semi-anechoic Chamber	ETS-LINDGREN	9m*6m*6m	NSEMC003	Mar. 12,16	Mar. 11,18
Test Software	ADT	ADT_Radiated _V7.6.15.9.2	N/A	N/A	N/A

- NOTE:**
1. The calibration interval of the above test instruments is 12 months and the calibrations are traceable to NML/ROC and NIST/USA.
  2. The calibration interval of the loop antenna is 24 months and the calibrations are traceable to NML/ROC and NIST/USA.
  3. The test was performed in HwaYa Chamber 4.
  4. The horn antenna and HP preamplifier (model: 8449B) are used only for the measurement of emission frequency above 1GHz if tested.
  5. The FCC Site Registration No. is 460141.
  6. The IC Site Registration No. is IC7450F-4.

#### 4.1.3 Test Procedures

- a. The EUT was placed on the top of a rotating table 0.8 meters (for below 1GHz) / 1.5 meters (for above 1GHz) above the ground at 3 meter chamber room for test. The table was rotated 360 degrees to determine the position of the highest radiation.
- b. The EUT was set 3 meters away from the interference-receiving antenna, which was mounted on the top of a variable-height antenna tower.
- c. The height of antenna is varied from one meter to four meters above the ground to determine the maximum value of the field strength. Both horizontal and vertical polarizations of the antenna are set to make the measurement.
- d. For each suspected emission, the EUT was arranged to its worst case and then the antenna was tuned to heights from 1 meter to 4 meters and the rotatable table was turned from 0 degrees to 360 degrees to find the maximum reading.
- e. The test-receiver system was set to quasi-peak detect function and specified bandwidth with maximum hold mode when the test frequency is below 1 GHz.
- f. The test-receiver system was set to peak and average detect function and specified bandwidth with maximum hold mode when the test frequency is above 1 GHz. If the peak reading value also meets average limit, measurement with the average detector is unnecessary.

**Note:**

1. The resolution bandwidth and video bandwidth of test receiver/spectrum analyzer is 120kHz for Quasi-peak detection (QP) at frequency below 1GHz.
2. The resolution bandwidth of test receiver/spectrum analyzer is 1 MHz and the video bandwidth is 3 MHz for Peak detection (PK) at frequency above 1GHz.
3. The resolution bandwidth of test receiver/spectrum analyzer is 1MHz and the video bandwidth is 3MHz for RMS Average (Duty cycle < 98%) for Average detection (AV) at frequency above 1GHz, then the measurement results was added to a correction factor ( $10 \log(1/\text{duty cycle})$ ).
4. The resolution bandwidth of test receiver/spectrum analyzer is 1MHz and the video bandwidth is 10Hz (Duty cycle  $\geq 98\%$ ) for Average detection (AV) at frequency above 1GHz.
5. All modes of operation were investigated and the worst-case emissions are reported.

#### 4.1.4 Deviation from Test Standard

No deviation.

4.1.5 Test Set Up

**<Frequency Range below 1GHz>**

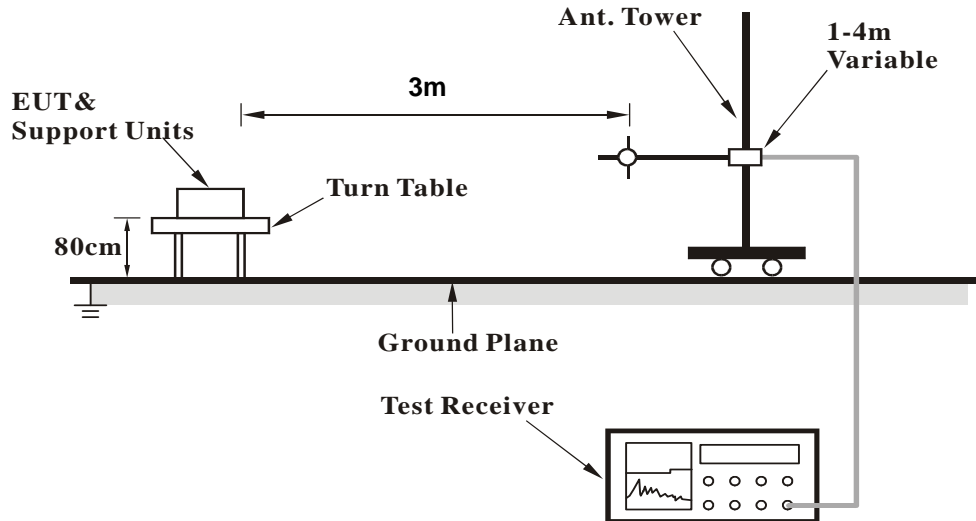

**<Frequency Range above 1GHz>**

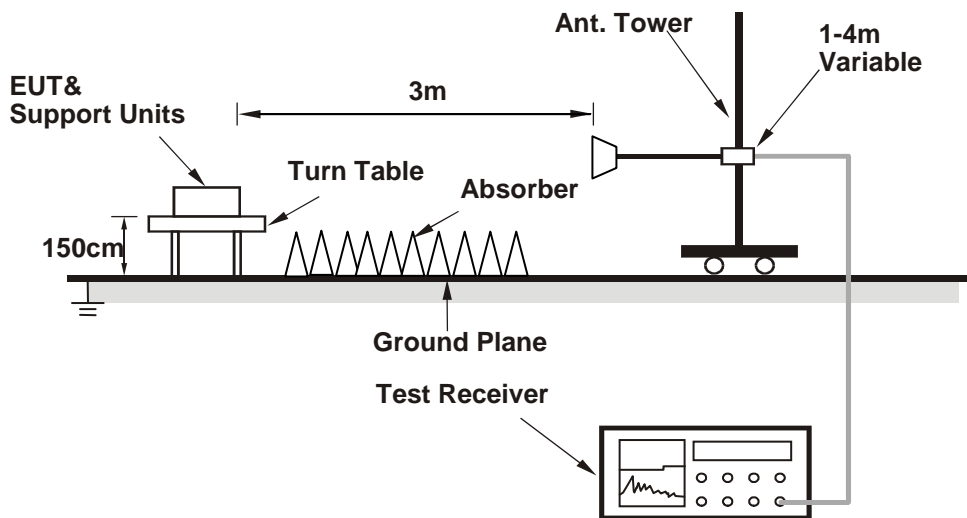

For the actual test configuration, please refer to the attached file (Test Setup Photo).

4.1.6 EUT Operating Conditions

- a. Placed the EUT on the testing table.
- b. Use the software to control the EUT under transmission condition continuously at specific channel frequency.



4.1.7 Test Results

**BELOW 1GHz WORST-CASE DATA:**

<b>CHANNEL</b>	TX Channel 0	<b>DETECTOR FUNCTION</b>	Quasi-Peak (QP)
<b>FREQUENCY RANGE</b>	30MHz ~ 1GHz		

ANTENNA POLARITY & TEST DISTANCE: HORIZONTAL AT 3 M									
Freq. (MHz)	Emission level (dBuV/m)	Read Level (dBuV)	Margin (dB)	Limit (dBuV/m)	Antenna Factor (dB/m)	Cable Loss (dB)	Antenna Height (cm)	Table Angle (degree)	Remark
37.76	26.68	50.15	-13.32	40.00	11.75	-35.22	200	154	QP
62.01	18.23	46.57	-21.77	40.00	6.50	-34.84	200	48	QP
102.75	20.91	47.52	-22.59	43.50	7.90	-34.51	200	202	QP
215.27	15.76	38.78	-27.74	43.50	10.80	-33.82	200	287	QP
486.87	25.54	40.52	-20.46	46.00	18.24	-33.22	200	159	QP
826.37	31.54	41.25	-14.46	46.00	23.00	-32.71	200	79	QP

**REMARKS:**

1. Emission Level(dBuV/m) = Raw Value(dBuV) + Correction Factor(dB/m)
2. Correction Factor(dB/m) = Antenna Factor(dB/m) + Cable Factor(dB) – Pre-Amplifier Factor(dB)
3. The other emission levels were very low against the limit.
4. Margin value = Emission Level – Limit value

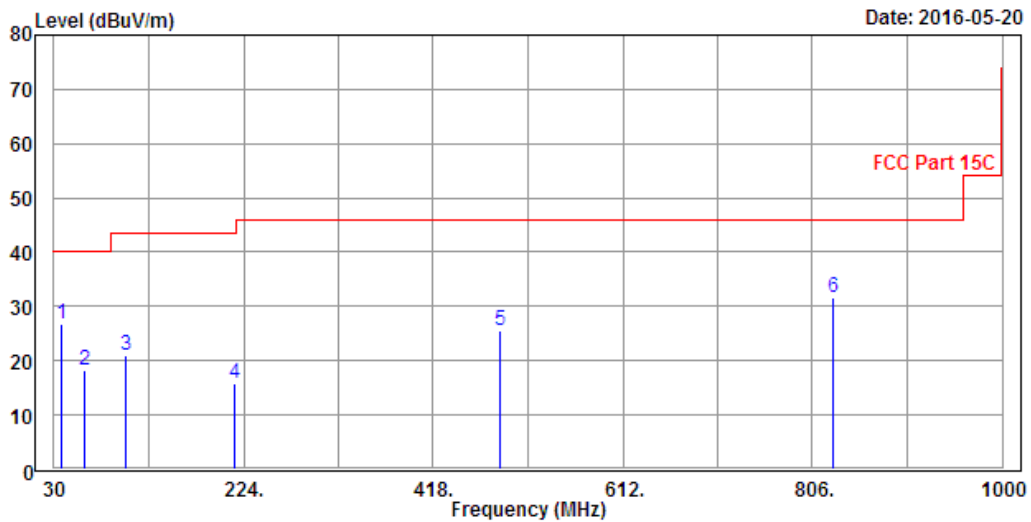

<b>CHANNEL</b>	TX Channel 0	<b>DETECTOR FUNCTION</b>	Quasi-Peak (QP)
<b>FREQUENCY RANGE</b>	30MHz ~ 1GHz		

ANTENNA POLARITY & TEST DISTANCE: VERTICAL AT 3 M									
Freq. (MHz)	Emission level (dBuV/m)	Read Level (dBuV)	Margin (dB)	Limit (dBuV/m)	Antenna Factor (dB/m)	Cable Loss (dB)	Antenna Height (cm)	Table Angle (degree)	Remark
37.76	36.38	59.85	-3.62	40.00	11.75	-35.22	101	128	QP
118.27	16.41	43.44	-27.09	43.50	7.36	-34.39	101	236	QP
176.47	14.28	38.29	-29.22	43.50	9.95	-33.96	101	146	QP
276.38	13.70	34.55	-32.30	46.00	12.72	-33.57	101	75	QP
486.87	24.96	39.94	-21.04	46.00	18.24	-33.22	101	298	QP
777.87	24.76	34.52	-21.24	46.00	23.02	-32.78	101	302	QP

**REMARKS:**

1. Emission Level(dBuV/m) = Raw Value(dBuV) + Correction Factor(dB/m)
2. Correction Factor(dB/m) = Antenna Factor(dB/m) + Cable Factor(dB) – Pre-Amplifier Factor(dB)
3. The other emission levels were very low against the limit.
4. Margin value = Emission Level – Limit value

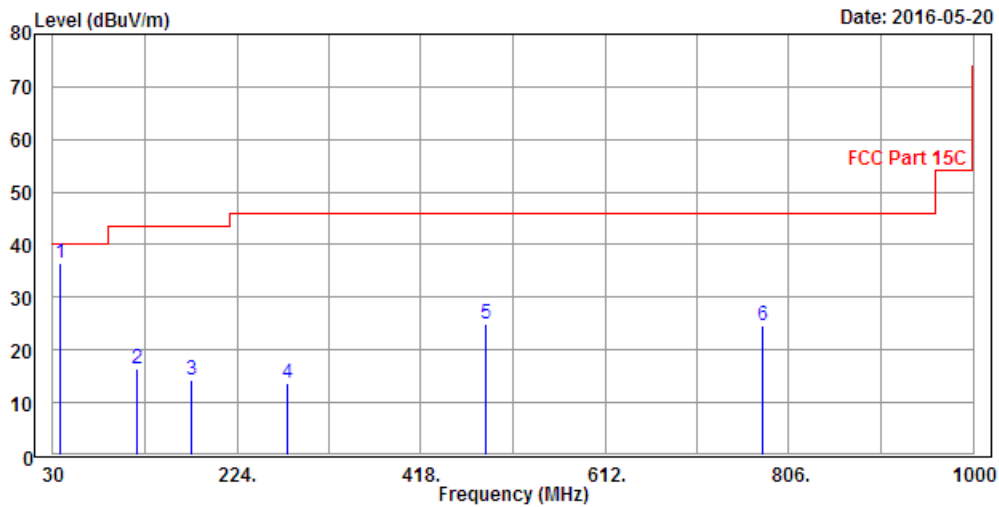

**ABOVE 1GHz WORST-CASE DATA:**

802.11b

<b>CHANNEL</b>	TX Channel 1	<b>DETECTOR FUNCTION</b>	Peak (PK)
<b>FREQUENCY RANGE</b>	1GHz ~ 25GHz		Average (AV)

**ANTENNA POLARITY & TEST DISTANCE: HORIZONTAL AT 3 M**

FREQ. (MHz)	EMISSION LEVEL (dBuV/m)	READ LEVEL (dBuV)	LIMIT (dBuV/m)	MARGIN (dB)	ANTENNA HEIGHT (cm)	TABLE ANGLE (Degree)	CORRECTION FACTOR (dB/m)	REMARK
2390	39.58	47.45	-14.42	54.00	100	205	-7.87	Average
2390	50.44	58.31	-23.56	74.00	100	205	-7.87	Peak
2412	94.86	102.67			100	205	-7.81	Average
2412	97.57	105.38			100	205	-7.81	Peak
4824	40.55	42.52	-13.45	54.00	100	142	-1.97	Average
4824	52.86	54.83	-21.14	74.00	100	142	-1.97	Peak

**ANTENNA POLARITY & TEST DISTANCE: VERTICAL AT 3 M**

FREQ. (MHz)	EMISSION LEVEL (dBuV/m)	READ LEVEL (dBuV)	LIMIT (dBuV/m)	MARGIN (dB)	ANTENNA HEIGHT (cm)	TABLE ANGLE (Degree)	CORRECTION FACTOR (dB/m)	REMARK
2390	38.91	46.78	-15.09	54.00	100	275	-7.87	Average
2390	49.58	57.45	-24.42	74.00	100	275	-7.87	Peak
2412	98.08	105.89			100	275	-7.81	Average
2412	101.36	109.17			100	275	-7.81	Peak
4824	44.05	46.02	-9.95	54.00	100	246	-1.97	Average
4824	52.76	54.73	-21.24	74.00	100	246	-1.97	Peak

**REMARKS:**

1. Emission Level = Read Level+ Antenna Factor + Cable Loss- Preamp Factor  
Margin value = Emission level – Limit value.
2. 2412MHz: Fundamental frequency.

<b>CHANNEL</b>	TX Channel 6	<b>DETECTOR FUNCTION</b>	Peak (PK)
<b>FREQUENCY RANGE</b>	1GHz ~ 25GHz		Average (AV)

<b>ANTENNA POLARITY &amp; TEST DISTANCE: HORIZONTAL AT 3 M</b>								
FREQ. (MHz)	EMISSION LEVEL (dBuV/m)	READ LEVEL (dBuV)	LIMIT (dBuV/m)	MARGIN (dB)	ANTENNA HEIGHT (cm)	TABLE ANGLE (Degree)	CORRECTION FACTOR (dB/m)	REMARK
2437	98.26	105.99			100	210	-7.73	Average
2437	100.50	108.23			100	210	-7.73	Peak
4874	47.92	49.73	-6.08	54.00	100	132	-1.81	Average
4874	53.04	54.85	-20.96	74.00	100	132	-1.81	Peak
7311	45.95	43.20	-8.05	54.00	100	36	2.75	Average
7311	55.50	52.75	-18.50	74.00	100	36	2.75	Peak
<b>ANTENNA POLARITY &amp; TEST DISTANCE: VERTICAL AT 3 M</b>								
FREQ. (MHz)	EMISSION LEVEL (dBuV/m)	READ LEVEL (dBuV)	LIMIT (dBuV/m)	MARGIN (dB)	ANTENNA HEIGHT (cm)	TABLE ANGLE (Degree)	CORRECTION FACTOR (dB/m)	REMARK
2437	101.33	109.06			100	280	-7.73	Average
2437	103.72	111.45			100	280	-7.73	Peak
4874	46.67	48.48	-7.33	54.00	100	120	-1.81	Average
4874	53.53	55.34	-20.47	74.00	100	120	-1.81	Peak
7311	46.06	43.31	-7.94	54.00	100	312	2.75	Average
7311	54.72	51.97	-19.28	74.00	100	312	2.75	Peak

**REMARKS:**

- Emission Level = Read Level+ Antenna Factor + Cable Loss- Preamp Factor  
Margin value = Emission level – Limit value.
- 2437MHz: Fundamental frequency.

<b>CHANNEL</b>	TX Channel 11	<b>DETECTOR FUNCTION</b>	Peak (PK)
<b>FREQUENCY RANGE</b>	1GHz ~ 25GHz		Average (AV)

**ANTENNA POLARITY & TEST DISTANCE: HORIZONTAL AT 3 M**

FREQ. (MHz)	EMISSION LEVEL (dBuV/m)	READ LEVEL (dBuV)	LIMIT (dBuV/m)	MARGIN (dB)	ANTENNA HEIGHT (cm)	TABLE ANGLE (Degree)	CORRECTION FACTOR (dB/m)	REMARK
2462	95.85	103.51			100	200	-7.61	Average
2462	99.36	107.02			100	200	-7.61	Peak
2483.5	34.77	42.37	-19.23	54.00	100	200	-7.60	Average
2483.5	44.81	52.41	-29.19	74.00	100	200	-7.60	Peak
4924	47.20	48.84	-6.80	54.00	100	302	-1.64	Average
4924	53.15	54.79	-20.85	74.00	100	302	-1.64	Peak
7386	44.24	41.37	-9.76	54.00	100	112	2.87	Average
7386	54.59	51.72	-19.41	74.00	100	112	2.87	Peak

**ANTENNA POLARITY & TEST DISTANCE: VERTICAL AT 3 M**

FREQ. (MHz)	EMISSION LEVEL (dBuV/m)	READ LEVEL (dBuV)	LIMIT (dBuV/m)	MARGIN (dB)	ANTENNA HEIGHT (cm)	TABLE ANGLE (Degree)	CORRECTION FACTOR (dB/m)	REMARK
2462	99.28	106.94			100	278	-7.61	Average
2462	101.78	109.44			100	278	-7.61	Peak
2483.5	35.38	42.98	-18.62	54.00	100	278	-7.60	Average
2483.5	45.02	52.62	-28.98	74.00	100	278	-7.60	Peak
4924	46.17	47.81	-7.83	54.00	100	165	-1.64	Average
4924	52.93	54.57	-21.07	74.00	100	165	-1.64	Peak
7386	44.24	41.37	-9.76	54.00	100	78	2.87	Average
7386	55.08	52.21	-18.92	74.00	100	78	2.87	Peak

**REMARKS:**

- Emission Level = Read Level+ Antenna Factor + Cable Loss- Preamp Factor  
Margin value = Emission level – Limit value.
- 2462MHz: Fundamental frequency.

**802.11g**

<b>CHANNEL</b>	TX Channel 1	<b>DETECTOR FUNCTION</b>	Peak (PK)
<b>FREQUENCY RANGE</b>	1GHz ~ 25GHz		Average (AV)

<b>ANTENNA POLARITY &amp; TEST DISTANCE: HORIZONTAL AT 3 M</b>								
<b>FREQ. (MHz)</b>	<b>EMISSION LEVEL (dBuV/m)</b>	<b>READ LEVEL (dBuV)</b>	<b>LIMIT (dBuV/m)</b>	<b>MARGIN (dB)</b>	<b>ANTENNA HEIGHT (cm)</b>	<b>TABLE ANGLE (Degree)</b>	<b>CORRECTION FACTOR (dB/m)</b>	<b>REMARK</b>
2390	50.02	57.89	-3.98	54.00	100	210	-7.87	Average
2390	66.62	74.49	-7.38	74.00	100	210	-7.87	Peak
2412	90.10	97.91			100	210	-7.81	Average
2412	101.58	109.39			100	210	-7.81	Peak
4824	41.31	43.28	-12.69	54.00	100	286	-1.97	Average
4824	52.58	54.55	-21.42	74.00	100	286	-1.97	Peak
<b>ANTENNA POLARITY &amp; TEST DISTANCE: VERTICAL AT 3 M</b>								
<b>FREQ. (MHz)</b>	<b>EMISSION LEVEL (dBuV/m)</b>	<b>READ LEVEL (dBuV)</b>	<b>LIMIT (dBuV/m)</b>	<b>MARGIN (dB)</b>	<b>ANTENNA HEIGHT (cm)</b>	<b>TABLE ANGLE (Degree)</b>	<b>CORRECTION FACTOR (dB/m)</b>	<b>REMARK</b>
2390	51.58	59.45	-2.42	54.00	100	268	-7.87	Average
2390	68.52	76.39	-5.48	74.00	100	268	-7.87	Peak
2412	92.42	100.23			100	268	-7.81	Average
2412	102.67	110.48			100	268	-7.81	Peak
4824	41.30	43.27	-12.70	54.00	100	88	-1.97	Average
4824	52.74	54.71	-21.26	74.00	100	88	-1.97	Peak

**REMARKS:**

1. Emission Level = Read Level+ Antenna Factor + Cable Loss- Preamp Factor  
Margin value = Emission level – Limit value.
2. 2412MHz: Fundamental frequency.

<b>CHANNEL</b>	TX Channel 6	<b>DETECTOR FUNCTION</b>	Peak (PK)
<b>FREQUENCY RANGE</b>	1GHz ~ 25GHz		Average (AV)

<b>ANTENNA POLARITY &amp; TEST DISTANCE: HORIZONTAL AT 3 M</b>								
FREQ. (MHz)	EMISSION LEVEL (dBUV/m)	READ LEVEL (dBUV)	LIMIT (dBUV/m)	MARGIN (dB)	ANTENNA HEIGHT (cm)	TABLE ANGLE (Degree)	CORRECTION FACTOR (dB/m)	REMARK
2437	91.50	99.23			100	208	-7.73	Average
2437	101.19	108.92			100	208	-7.73	Peak
4874	43.05	44.86	-10.95	54.00	100	147	-1.81	Average
4874	54.44	56.25	-19.56	74.00	100	147	-1.81	Peak
7311	45.07	42.32	-8.93	54.00	100	48	2.75	Average
7311	56.55	53.80	-17.45	74.00	100	48	2.75	Peak
<b>ANTENNA POLARITY &amp; TEST DISTANCE: VERTICAL AT 3 M</b>								
FREQ. (MHz)	EMISSION LEVEL (dBUV/m)	READ LEVEL (dBUV)	LIMIT (dBUV/m)	MARGIN (dB)	ANTENNA HEIGHT (cm)	TABLE ANGLE (Degree)	CORRECTION FACTOR (dB/m)	REMARK
2437	95.23	102.96			100	272	-7.73	Average
2437	105.04	112.77			100	272	-7.73	Peak
4874	42.00	43.81	-12.00	54.00	100	156	-1.81	Average
4874	53.88	55.69	-20.12	74.00	100	156	-1.81	Peak
7311	45.13	42.38	-8.87	54.00	100	213	2.75	Average
7311	57.45	54.70	-16.55	74.00	100	213	2.75	Peak

**REMARKS:**

1. Emission Level = Read Level+ Antenna Factor + Cable Loss- Preamp Factor  
Margin value = Emission level – Limit value.
2. 2437MHz: Fundamental frequency.

<b>CHANNEL</b>	TX Channel 11	<b>DETECTOR FUNCTION</b>	Peak (PK)
<b>FREQUENCY RANGE</b>	1GHz ~ 25GHz		Average (AV)

**ANTENNA POLARITY & TEST DISTANCE: HORIZONTAL AT 3 M**

FREQ. (MHz)	EMISSION LEVEL (dBuV/m)	READ LEVEL (dBuV)	LIMIT (dBuV/m)	MARGIN (dB)	ANTENNA HEIGHT (cm)	TABLE ANGLE (Degree)	CORRECTION FACTOR (dB/m)	REMARK
2462	90.57	98.23			100	212	-7.61	Average
2462	100.46	108.12			100	212	-7.61	Peak
2483.5	44.56	52.16	-9.44	54.00	100	212	-7.60	Average
2483.5	62.58	70.18	-11.42	74.00	100	212	-7.60	Peak
4924	42.83	44.47	-11.17	54.00	100	324	-1.64	Average
4924	53.38	55.02	-20.62	74.00	100	324	-1.64	Peak
7386	44.81	41.94	-9.19	54.00	100	65	2.87	Average
7386	56.72	53.85	-17.28	74.00	100	65	2.87	Peak

**ANTENNA POLARITY & TEST DISTANCE: VERTICAL AT 3 M**

FREQ. (MHz)	EMISSION LEVEL (dBuV/m)	READ LEVEL (dBuV)	LIMIT (dBuV/m)	MARGIN (dB)	ANTENNA HEIGHT (cm)	TABLE ANGLE (Degree)	CORRECTION FACTOR (dB/m)	REMARK
2462	93.04	100.70			100	282	-7.61	Average
2462	103.00	110.66			100	282	-7.61	Peak
2483.5	51.28	58.88	-2.72	54.00	100	282	-7.60	Average
2483.5	68.64	76.24	-5.36	74.00	100	282	-7.60	Peak
4924	41.98	43.62	-12.02	54.00	100	75	-1.64	Average
4924	53.99	55.63	-20.01	74.00	100	75	-1.64	Peak
7386	45.83	42.96	-8.17	54.00	100	138	2.87	Average
7386	55.91	53.04	-18.09	74.00	100	138	2.87	Peak

**REMARKS:**

- Emission Level = Read Level+ Antenna Factor + Cable Loss- Preamp Factor  
Margin value = Emission level – Limit value.
- 2462MHz: Fundamental frequency.



**802.11n (20MHz)**

<b>CHANNEL</b>	TX Channel 1	<b>DETECTOR FUNCTION</b>	Peak (PK)
<b>FREQUENCY RANGE</b>	1GHz ~ 25GHz		Average (AV)

**ANTENNA POLARITY & TEST DISTANCE: HORIZONTAL AT 3 M**

FREQ. (MHz)	EMISSION LEVEL (dBuV/m)	READ LEVEL (dBuV)	LIMIT (dBuV/m)	MARGIN (dB)	ANTENNA HEIGHT (cm)	TABLE ANGLE (Degree)	CORRECTION FACTOR (dB/m)	REMARK
2390	47.62	55.49	-6.38	54.00	100	212	-7.87	Average
2390	64.21	72.08	-9.79	74.00	100	212	-7.87	Peak
2412	86.72	94.53			100	212	-7.81	Average
2412	97.13	104.94			100	212	-7.81	Peak
4824	41.14	43.11	-12.86	54.00	100	287	-1.97	Average
4824	52.30	54.27	-21.70	74.00	100	287	-1.97	Peak

**ANTENNA POLARITY & TEST DISTANCE: VERTICAL AT 3 M**

FREQ. (MHz)	EMISSION LEVEL (dBuV/m)	READ LEVEL (dBuV)	LIMIT (dBuV/m)	MARGIN (dB)	ANTENNA HEIGHT (cm)	TABLE ANGLE (Degree)	CORRECTION FACTOR (dB/m)	REMARK
2390	51.58	59.45	-2.42	54.00	100	282	-7.87	Average
2390	69.29	77.16	-4.71	74.00	100	282	-7.87	Peak
2412	89.66	97.47			100	282	-7.81	Average
2412	99.73	107.54			100	282	-7.81	Peak
4824	41.18	43.15	-12.82	54.00	100	145	-1.97	Average
4824	51.71	53.68	-22.29	74.00	100	145	-1.97	Peak

**REMARKS:**

1. Emission Level = Read Level+ Antenna Factor + Cable Loss- Preamp Factor  
Margin value = Emission level – Limit value.
2. 2412MHz: Fundamental frequency.

<b>CHANNEL</b>	TX Channel 6	<b>DETECTOR FUNCTION</b>	Peak (PK)
<b>FREQUENCY RANGE</b>	1GHz ~ 25GHz		Average (AV)

<b>ANTENNA POLARITY &amp; TEST DISTANCE: HORIZONTAL AT 3 M</b>								
FREQ. (MHz)	EMISSION LEVEL (dBuV/m)	READ LEVEL (dBuV)	LIMIT (dBuV/m)	MARGIN (dB)	ANTENNA HEIGHT (cm)	TABLE ANGLE (Degree)	CORRECTION FACTOR (dB/m)	REMARK
2437	93.44	101.17			100	270	-7.73	Average
2437	103.69	111.42			100	270	-7.73	Peak
4874	42.04	43.85	-11.96	54.00	100	124	-1.81	Average
4874	53.15	54.96	-20.85	74.00	100	124	-1.81	Peak
7311	45.16	42.41	-8.84	54.00	100	205	2.75	Average
7311	55.95	53.20	-18.05	74.00	100	205	2.75	Peak
<b>ANTENNA POLARITY &amp; TEST DISTANCE: VERTICAL AT 3 M</b>								
FREQ. (MHz)	EMISSION LEVEL (dBuV/m)	READ LEVEL (dBuV)	LIMIT (dBuV/m)	MARGIN (dB)	ANTENNA HEIGHT (cm)	TABLE ANGLE (Degree)	CORRECTION FACTOR (dB/m)	REMARK
2437	89.43	97.16			100	198	-7.73	Average
2437	100.01	107.74			100	198	-7.73	Peak
4874	42.03	43.84	-11.97	54.00	100	88	-1.81	Average
4874	53.00	54.81	-21.00	74.00	100	88	-1.81	Peak
7311	45.07	42.32	-8.93	54.00	100	269	2.75	Average
7311	57.20	54.45	-16.80	74.00	100	269	2.75	Peak

**REMARKS:**

1. Emission Level = Read Level+ Antenna Factor + Cable Loss- Preamp Factor  
Margin value = Emission level – Limit value.
2. 2437MHz: Fundamental frequency.

<b>CHANNEL</b>	TX Channel 11	<b>DETECTOR FUNCTION</b>	Peak (PK)
<b>FREQUENCY RANGE</b>	1GHz ~ 25GHz		Average (AV)

**ANTENNA POLARITY & TEST DISTANCE: HORIZONTAL AT 3 M**

FREQ. (MHz)	EMISSION LEVEL (dBuV/m)	READ LEVEL (dBuV)	LIMIT (dBuV/m)	MARGIN (dB)	ANTENNA HEIGHT (cm)	TABLE ANGLE (Degree)	CORRECTION FACTOR (dB/m)	REMARK
2462	89.53	97.19			100	202	-7.61	Average
2462	98.57	106.23			100	202	-7.61	Peak
2483.5	44.17	51.77	-9.83	54.00	100	202	-7.60	Average
2483.5	62.89	70.49	-11.11	74.00	100	202	-7.60	Peak
4924	41.77	43.41	-12.23	54.00	100	158	-1.64	Average
4924	53.03	54.67	-20.97	74.00	100	158	-1.64	Peak
7386	44.66	41.79	-9.34	54.00	100	76	2.87	Average
7386	56.96	54.09	-17.04	74.00	100	76	2.87	Peak

**ANTENNA POLARITY & TEST DISTANCE: VERTICAL AT 3 M**

FREQ. (MHz)	EMISSION LEVEL (dBuV/m)	READ LEVEL (dBuV)	LIMIT (dBuV/m)	MARGIN (dB)	ANTENNA HEIGHT (cm)	TABLE ANGLE (Degree)	CORRECTION FACTOR (dB/m)	REMARK
2462	92.03	99.69			100	270	-7.61	Average
2462	102.05	109.71			100	270	-7.61	Peak
<b>2483.5</b>	<b>51.89</b>	<b>59.49</b>	<b>-2.11</b>	<b>54.00</b>	<b>100</b>	<b>270</b>	<b>-7.60</b>	<b>Average</b>
2483.5	66.47	74.07	-7.53	74.00	100	270	-7.60	Peak
4924	41.80	43.44	-12.20	54.00	100	167	-1.64	Average
4924	52.59	54.23	-21.41	74.00	100	167	-1.64	Peak
7386	45.79	42.92	-8.21	54.00	100	322	2.87	Average
7386	56.50	53.63	-17.50	74.00	100	322	2.87	Peak

**REMARKS:**

- Emission Level = Read Level+ Antenna Factor + Cable Loss- Preamp Factor  
Margin value = Emission level – Limit value.
- 2462MHz: Fundamental frequency.

## 4.2 Conducted Emission Measurement

### 4.2.1 Limits of Conducted Emission Measurement

Frequency (MHz)	Conducted Limit (dBuV)	
	Quasi-peak	Average
0.15 - 0.5	66 - 56	56 - 46
0.50 - 5.0	56	46
5.0 - 30.0	60	50

- NOTE:**
1. The lower limit shall apply at the transition frequencies.
  2. The limit decreases in line with the logarithm of the frequency in the range of 0.15 to 0.50MHz.
  3. All emanations from a class A/B digital device or system, including any network of conductors and apparatus connected thereto, shall not exceed the level of field strengths specified above.

### 4.2.2 Test Instruments

Equipment	Manufacturer	Model No.	Serial No.	Last Cal.	Next Cal.
EMI Test Receiver	Rohde&Schwarz	ESCS30	100340	May 11,15	May 10,17
Artificial Mains Network	Rohde&Schwarz	ENV216	101173	Mar. 04,16	Mar. 03,17
Artificial Mains Network	Rohde&Schwarz	ESH3-Z5	100317	Apr. 05,16	Apr. 04,17
Voltage probe	SCHWARZBECK	TK 9421	TK 9421-176	Jan. 08,16	Jan. 07,17
Test software	ADT	ADT_Cond_V7.3.7	N/A	N/A	N/A

- NOTE:**
1. The calibration interval of the above test instruments is 12 months and the calibrations are traceable to NML/ROC and NIST/USA.
  2. The test was performed in HwaYa Shielded Room 1.
  3. The VCCI Site Registration No. is C-2040.

#### 4.2.3 Test Procedures

- a. The EUT was placed 0.4 meters from the conducting wall of the shielded room with EUT being connected to the power mains through a line impedance stabilization network (LISN). Other support units were connected to the power mains through another LISN. The two LISNs provide 50 ohm/ 50uH of coupling impedance for the measuring instrument.
- b. Both lines of the power mains connected to the EUT were checked for maximum conducted interference.
- c. The frequency range from 150kHz to 30MHz was searched. Emission levels under (Limit - 20dB) was not recorded.

**NOTE:** All modes of operation were investigated and the worst-case emissions are reported.

#### 4.2.4 Deviation from Test Standard

No deviation.

#### 4.2.5 Test Setup

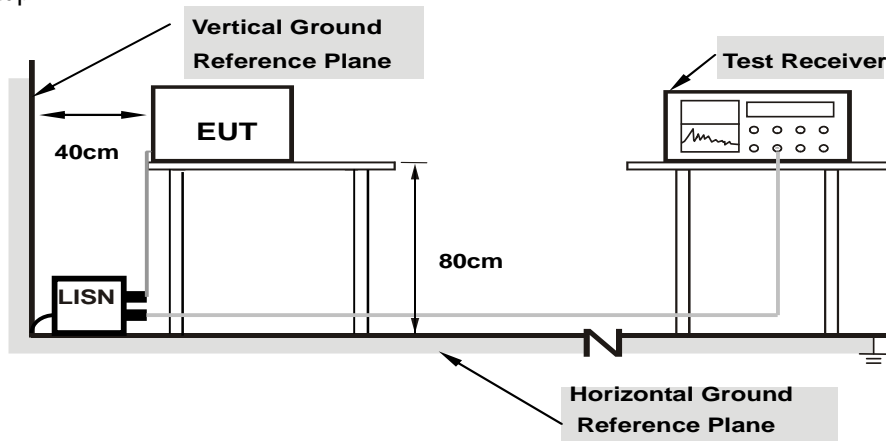

**Note: 1. Support units were connected to second LISN.**

For the actual test configuration, please refer to the attached file (Test Setup Photo).

#### 4.2.6 EUT Operating Conditions

Same as 4.1.6.

4.2.7 Test Results

**CONDUCTED WORST-CASE DATA**

<b>TEST VOLTAGE</b>	DC 5V From Adapter Input 230 Vac, 50 Hz	<b>6dB BANDWIDTH</b>	9 kHz
<b>ENVIRONMENTAL CONDITIONS</b>	24deg. C, 55RH	<b>TESTED BY</b>	Eric

Frequency (MHz)	QuasiPeak (dBµV)	CAverage (dBµV)	Limit (dBµV)	Margin (dB)	Line	Filter	Corr. (dB)
0.468000	---	9.40	46.55	37.15	L	ON	9.7
0.468000	17.99	---	56.55	38.56	L	ON	9.7
1.820000	---	19.38	46.00	26.62	L	ON	9.7
1.820000	23.71	---	56.00	32.29	L	ON	9.7
2.924000	---	17.44	46.00	28.56	L	ON	9.7
2.924000	20.76	---	56.00	35.24	L	ON	9.7
5.772000	---	25.74	50.00	24.26	L	ON	9.8
5.772000	28.41	---	60.00	31.59	L	ON	9.8
6.152000	---	20.38	50.00	29.62	L	ON	9.8
6.152000	24.83	---	60.00	35.17	L	ON	9.8
12.376000	---	22.94	50.00	27.06	L	ON	9.9
12.376000	28.09	---	60.00	31.91	L	ON	9.9

- REMARKS:**
1. Q.P. and AV. are abbreviations of quasi-peak and average individually.
  2. "-": The Quasi-peak reading value also meets average limit and measurement with the average detector is unnecessary.
  3. The emission levels of other frequencies were very low against the limit.
  4. Margin value = Emission level - Limit value
  5. Correction factor = Insertion loss + Cable loss
  6. Emission Level = Correction Factor + Reading Value.

Full Spectrum

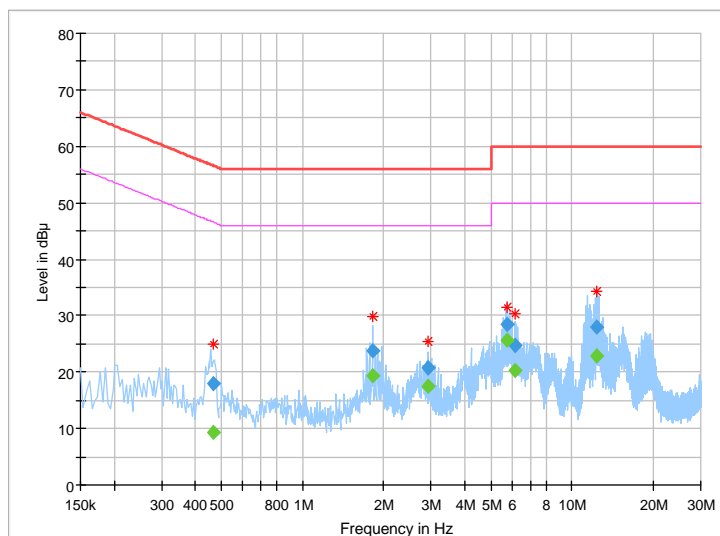

<b>TEST VOLTAGE</b>	DC 5V From Adapter Input 230 Vac, 50 Hz	<b>6dB BANDWIDTH</b>	9 kHz
<b>ENVIRONMENTAL CONDITIONS</b>	24deg. C, 55RH	<b>TESTED BY</b>	Eric

Frequency (MHz)	QuasiPeak (dBuV)	CAverage (dBuV)	Limit (dBuV)	Margin (dB)	Line	Filter	Corr. (dB)
0.464000	---	12.53	46.62	34.09	N	ON	10.1
0.464000	22.69	---	56.62	33.93	N	ON	10.1
<b>1.820000</b>	---	<b>25.02</b>	<b>46.00</b>	<b>20.98</b>	<b>N</b>	<b>ON</b>	<b>9.8</b>
1.820000	28.75	---	56.00	27.25	N	ON	9.8
4.860000	---	13.38	46.00	32.62	N	ON	9.8
4.860000	23.00	---	56.00	33.00	N	ON	9.8
6.148000	---	18.91	50.00	31.09	N	ON	9.8
6.148000	25.82	---	60.00	34.18	N	ON	9.8
12.444000	---	24.99	50.00	25.01	N	ON	9.9
12.444000	32.22	---	60.00	27.78	N	ON	9.9
18.512000	---	21.78	50.00	28.22	N	ON	10.0
18.512000	28.37	---	60.00	31.63	N	ON	10.0

- REMARKS:**
1. Q.P. and AV. are abbreviations of quasi-peak and average individually.
  2. "-": The Quasi-peak reading value also meets average limit and measurement with the average detector is unnecessary.
  3. The emission levels of other frequencies were very low against the limit.
  4. Margin value = Emission level - Limit value
  5. Correction factor = Insertion loss + Cable loss
  6. Emission Level = Correction Factor + Reading Value.

Full Spectrum

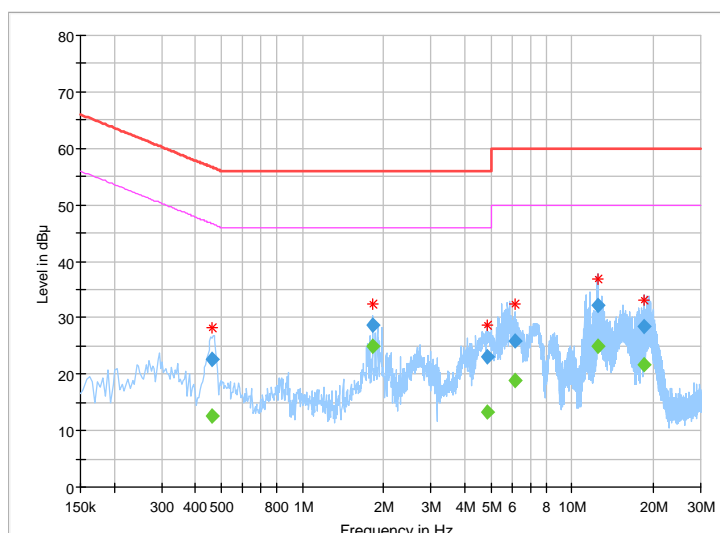

### 4.3 6dB Bandwidth Measurement

#### 4.3.1 Limits of 6dB Bandwidth Measurement

The minimum of 6dB Bandwidth Measurement is 0.5 MHz.

#### 4.3.2 Test Setup

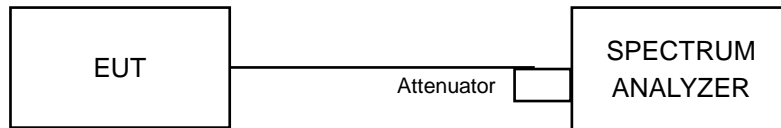

#### 4.3.3 Test Instruments

Equipment	Manufacturer	Model No.	Serial No.	Last Cal.	Next Cal.
Spectrum Analyzer (10Hz-40GHz)	Rohde&Schwarz	FSV40	101003	Apr. 05,16	Apr. 04,17
Power Meter	Anritsu	ML2495A	1139001	Feb.19,16	Feb. 18,17
Power Sensor	Anritsu	MA2411B	1126068	Feb.19,16	Feb. 18,17
Power Sensor	Keysight	U2021XA	MY55060016	May 27,15	May 26,17
Power Sensor	Keysight	U2021XA	MY55060018	May 27,15	May 26,17
Digital Multimeter	FLUKE	15B	A1220010DG	Oct. 12, 15	Oct.11, 16

**NOTE:**

1. The calibration interval of the above test instruments is 12 months and the calibrations are traceable to CEPREI/CHINA, GRGT/CHINA and NIM/CHINA.
2. The test was performed in RF Oven room.

#### 4.3.4 Test Procedure

- a. Set resolution bandwidth (RBW) = 100kHz
- b. Set the video bandwidth (VBW) ≥ 3 x RBW, Detector = Peak.
- c. Trace mode = max hold.
- d. Sweep = auto couple.
- e. Measure the maximum width of the emission that is constrained by the frequencies associated with the two amplitude points (upper and lower) that are attenuated by 6 dB relative to the maximum level measured in the fundamental emission

#### 4.3.5 Deviation from Test Standard

No deviation.

#### 4.3.6 EUT Operating Conditions

The software provided by client to enable the EUT under transmission condition continuously at lowest, middle and highest channel frequencies individually.



## 4.3.7 Test Result

## 802.11b

Channel	Frequency (MHz)	6db Bandwidth (MHz)	Minimum Limit (MHz)	Pass / Fail
1	2412	8.55	0.5	PASS
6	2437	8.57	0.5	PASS
11	2462	8.56	0.5	PASS

## 802.11g

Channel	Frequency (MHz)	6db Bandwidth (MHz)	Minimum Limit (MHz)	Pass / Fail
1	2412	15.76	0.5	PASS
6	2437	16.32	0.5	PASS
11	2462	15.95	0.5	PASS

## 802.11n (HT20)

Channel	Frequency (MHz)	6db Bandwidth (MHz)	Minimum Limit (MHz)	Pass / Fail
1	2412	16.55	0.5	Pass
6	2437	17.30	0.5	Pass
11	2462	17.20	0.5	Pass

Spectrum Plot of Worst Value

802.11b

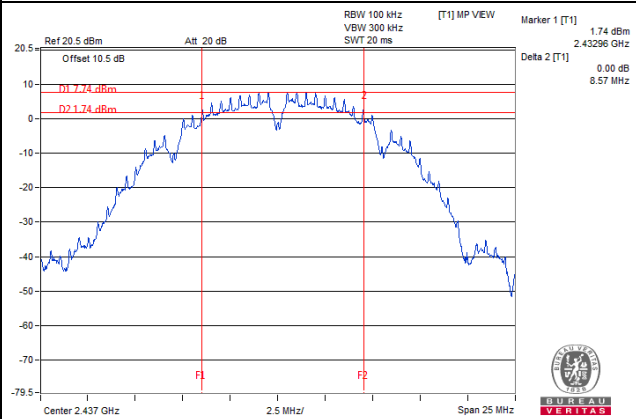

802.11g

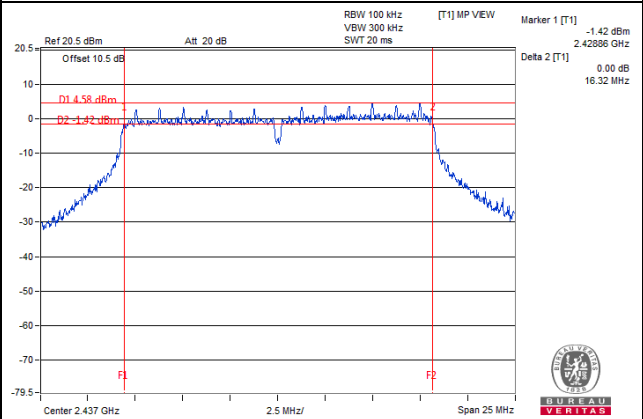

802.11n (HT20)

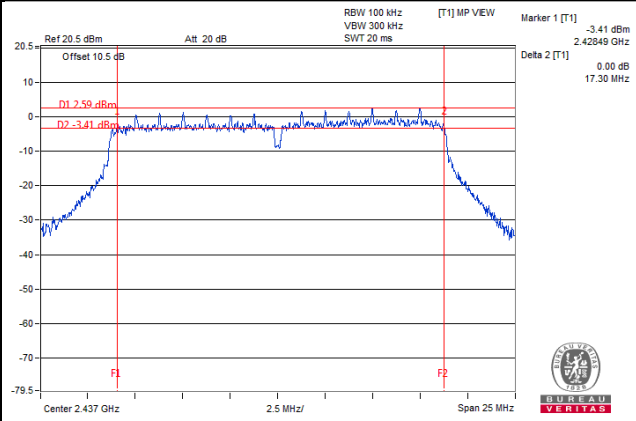

## 4.4 Conducted Output Power Measurement

### 4.4.1 Limits of Conducted Output Power Measurement

For systems using digital modulation in the 2400–2483.5 MHz bands: 1 Watt (30dBm)

### 4.4.2 Test Setup

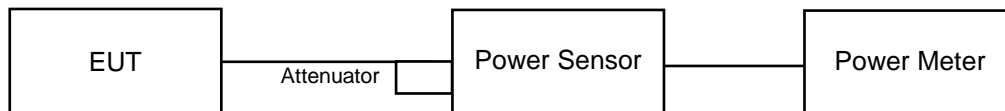

### 4.4.3 Test Instruments

Refer to section 4.3.3 to get information of above instrument.

### 4.4.4 Test Procedures

A peak / average power sensor was used on the output port of the EUT. A power meter was used to read the response of the peak / average power sensor. Record the power level.

### 4.4.5 Deviation from Test Standard

No deviation.

### 4.4.6 EUT Operating Conditions

Same as Item 4.3.6.

#### 4.4.7 Test Results

##### 4.4.7.1 Maximum Peak Output Power

###### 802.11b

CHANNEL	CHANNEL FREQUENCY (MHz)	PEAK POWER (dBm)	PEAK POWER (mW)	PEAK POWER LIMIT (W)	PASS/FAIL
1	2412	17.90	61.660	1	PASS
6	2437	17.98	62.806	1	PASS
11	2462	18.44	69.823	1	PASS

###### 802.11g

CHANNEL	CHANNEL FREQUENCY (MHz)	PEAK POWER (dBm)	PEAK POWER (mW)	PEAK POWER LIMIT (W)	PASS/FAIL
1	2412	20.78	119.674	1	PASS
6	2437	20.43	110.408	1	PASS
11	2462	21.04	<b>127.057</b>	1	PASS

###### 802.11n (20MHz)

CHANNEL	CHANNEL FREQUENCY (MHz)	PEAK POWER (dBm)	PEAK POWER (mW)	PEAK POWER LIMIT (W)	PASS/FAIL
1	2412	18.98	79.068	1	PASS
6	2437	19.58	90.782	1	PASS
11	2462	19.83	96.161	1	PASS

#### 4.4.7.2 Average Output Power (For Reference)

The average power sensor was used on the output port of the EUT. A power meter was used to read the response of the power sensor. Record the power level.

#### 802.11b

CHANNEL	CHANNEL FREQUENCY (MHz)	AVERAGE POWER (dBm)	PASS/FAIL
1	2412	15.23	N/A
6	2437	15.48	N/A
11	2462	15.62	N/A

#### 802.11g

CHANNEL	CHANNEL FREQUENCY (MHz)	AVERAGE POWER (dBm)	PASS/FAIL
1	2412	14.42	N/A
6	2437	14.29	N/A
11	2462	14.96	N/A

#### 802.11n (20MHz)

CHANNEL	CHANNEL FREQUENCY (MHz)	AVERAGE POWER (dBm)	PASS/FAIL
1	2412	11.78	N/A
6	2437	12.21	N/A
11	2462	12.50	N/A

## 4.5 Power Spectral Density Measurement

### 4.5.1 Limits of Power Spectral Density Measurement

The Maximum of Power Spectral Density Measurement is 8dBm.

### 4.5.2 Test Setup

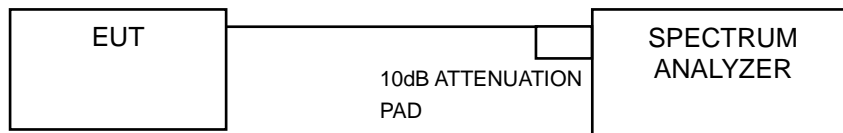

### 4.5.3 Test Instruments

Refer to section 4.3.3 to get information of above instrument.

### 4.5.4 Test Procedure

- Set analyzer center frequency to DTS channel center frequency.
- Set the span to 1.5 times the DTS bandwidth.
- Set the RBW to:  $3 \text{ kHz} \leq \text{RBW} \leq 100 \text{ kHz}$ .
- Set the VBW  $\geq 3 \times \text{RBW}$ .
- Detector = peak.
- Sweep time = auto couple.
- Trace mode = max hold.
- Allow trace to fully stabilize.
- Use the peak marker function to determine the maximum amplitude level within the RBW.

### 4.5.5 Deviation from Test Standard

No deviation.

### 4.5.6 EUT Operating Condition

Same as Item 4.3.6

## 4.5.7 Test Results

## 802.11b

Channel	Freq. (MHz)	PSD (dBm/3kHz)	Limit (dBm)	Pass /Fail
1	2412	-7.51	8	Pass
6	2437	-5.44	8	Pass
11	2462	-6.39	8	Pass

## 802.11g

Channel	Freq. (MHz)	PSD (dBm/3kHz)	Limit (dBm)	Pass /Fail
1	2412	-9.09	8	Pass
6	2437	-8.92	8	Pass
11	2462	-9.84	8	Pass

## 802.11n (HT20)

Channel	Freq. (MHz)	PSD (dBm/3kHz)	Limit (dBm)	Pass /Fail
1	2412	-12.05	8	Pass
6	2437	-13.12	8	Pass
11	2462	-11.03	8	Pass

**Spectrum Plot of Worst Value**

**802.11b**

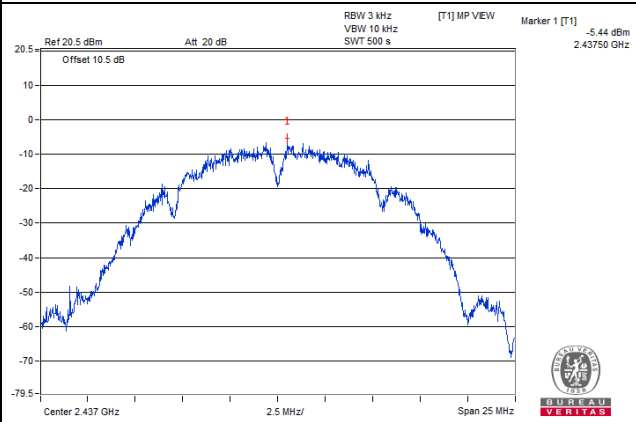

**802.11g**

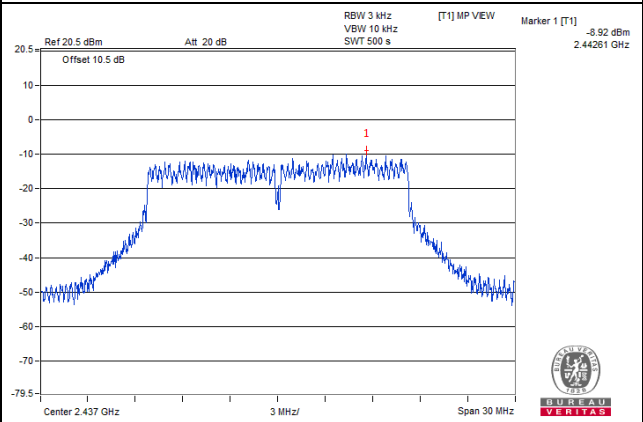

**802.11n (HT20)**

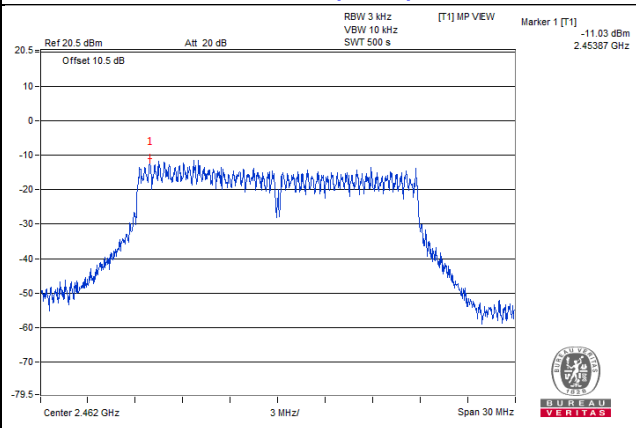



## 4.6 Conducted Out of Band Emission Measurement

### 4.6.1 Limits of Conducted Out of Band Emission Measurement

Below 20dB of the highest emission level of operating band (in 100kHz Resolution Bandwidth).

### 4.6.2 Test Setup

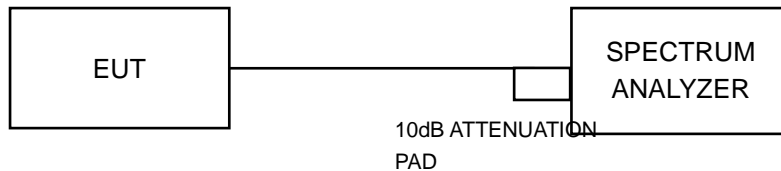

### 4.6.3 Test Instruments

Refer to section 4.3.3 to get information of above instrument.

### 4.6.4 Test Procedure

#### MEASUREMENT PROCEDURE REF

1. Set the RBW = 100 kHz.
2. Set the VBW  $\geq$  300 kHz.
3. Detector = peak.
4. Sweep time = auto couple.
5. Trace mode = max hold.
6. Allow trace to fully stabilize.
7. Use the peak marker function to determine the maximum power level in any 100 kHz band segment within the fundamental EBW.

#### MEASUREMENT PROCEDURE OOB

1. Set RBW = 100 kHz.
2. Set VBW  $\geq$  300 kHz.
3. Detector = peak.
4. Sweep = auto couple.
5. Trace Mode = max hold.
6. Allow trace to fully stabilize.
7. Use the peak marker function to determine the maximum amplitude level.

### 4.6.5 Deviation from Test Standard

No deviation.

### 4.6.6 EUT Operating Condition

Same as Item 4.3.6

### 4.6.7 Test Results

The spectrum plots are attached on the following pages. D1 line indicates the highest level, and D2 line indicates the 20dB offset below D1. It shows compliance with the requirement.

#### 802.11b

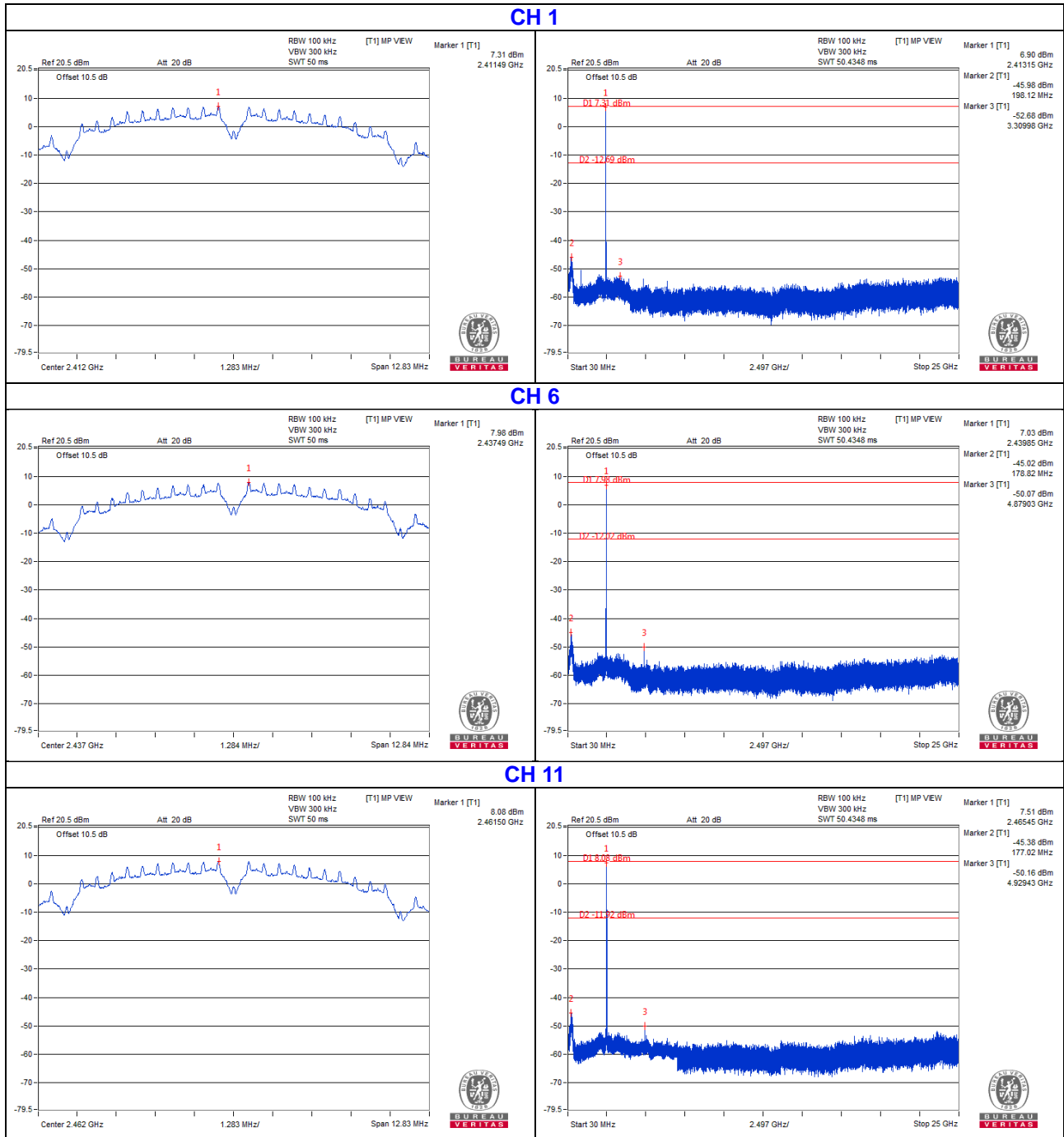

802.11g

CH 1

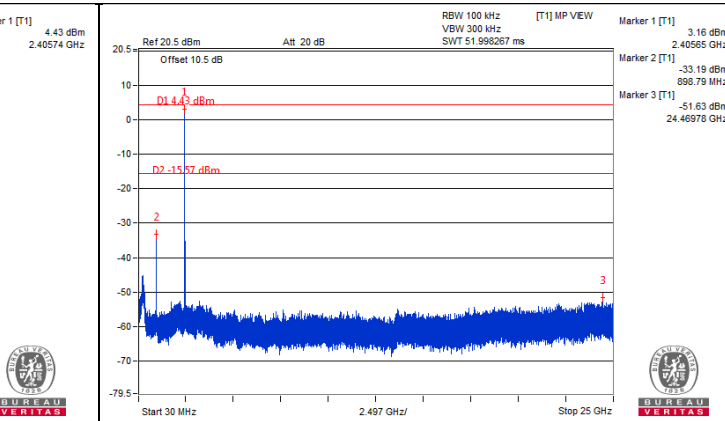
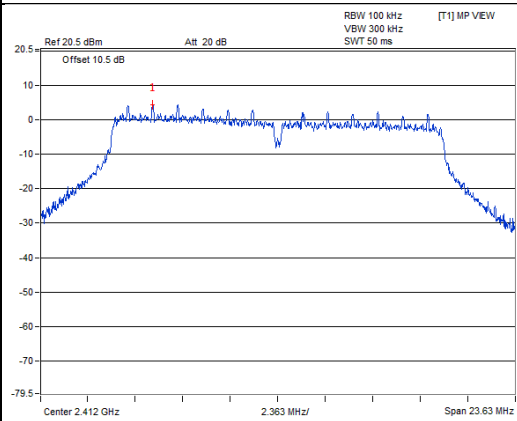

CH 6

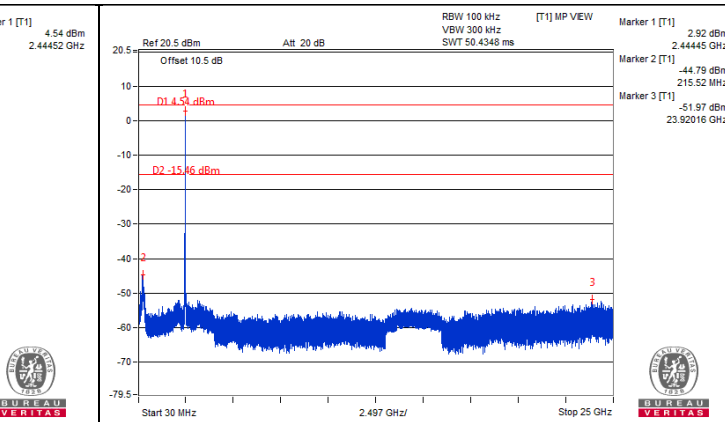
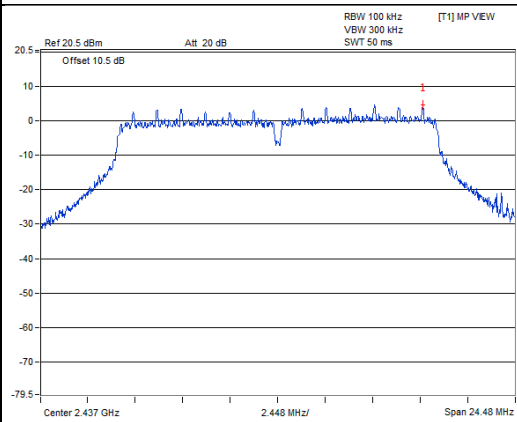

CH 11

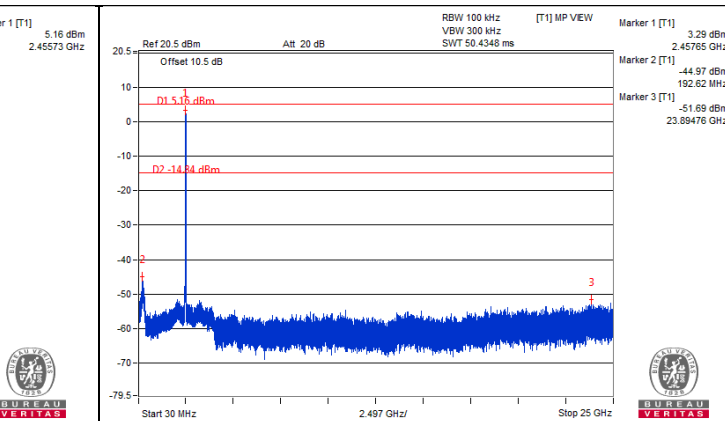
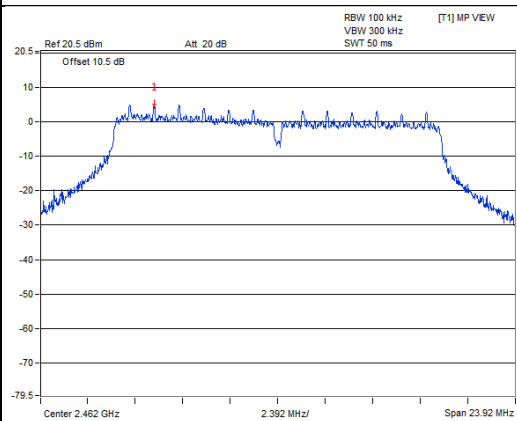

### 802.11n (HT20)

#### CH 1

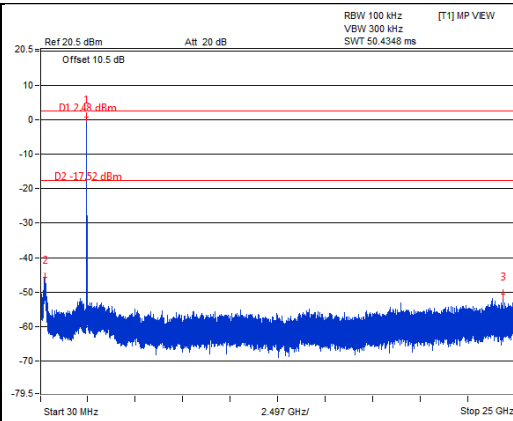
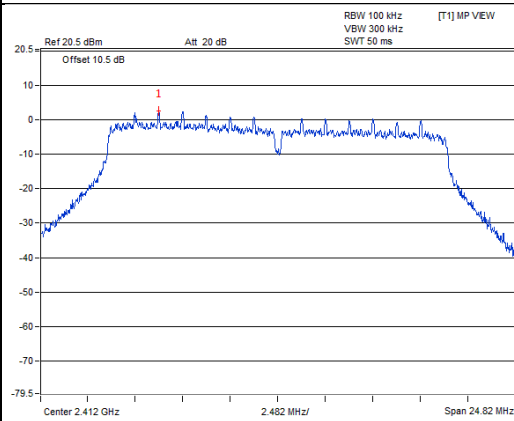

#### CH 6

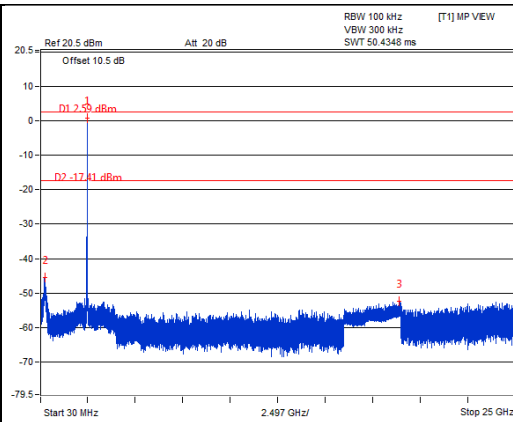
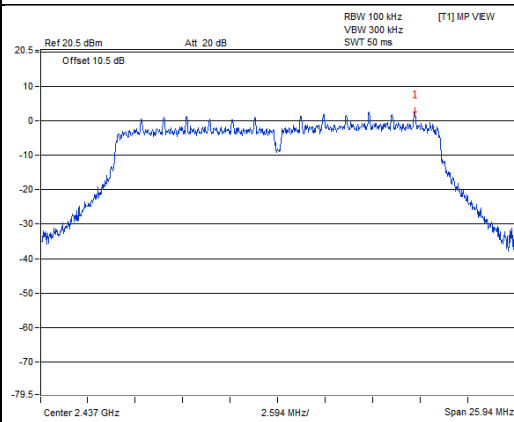

#### CH 11

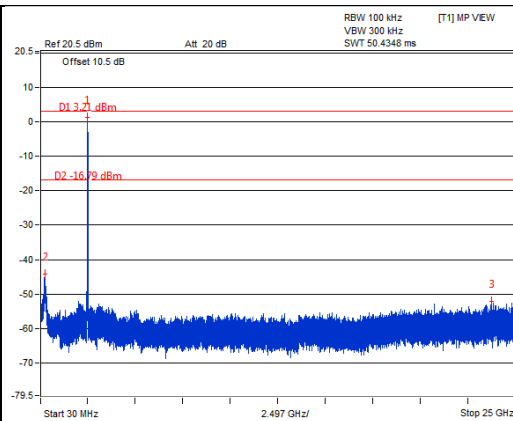
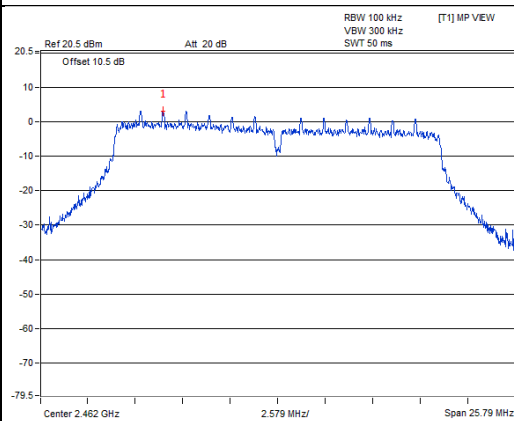

## 5 Pictures of Test Arrangements

Please refer to the attached file (Test Setup Photo).

## Appendix – Information on the Testing Laboratories

We, Bureau Veritas Consumer Products Services (H.K.) Ltd., Taoyuan Branch, were founded in 1988 to provide our best service in EMC, Radio, Telecom and Safety consultation. Our laboratories are accredited and approved according to ISO/IEC 17025.

If you have any comments, please feel free to contact us at the following:

**Linko EMC/RF Lab**

Tel: 886-2-26052180

Fax: 886-2-26051924

**Hsin Chu EMC/RF/Telecom Lab**

Tel: 886-3-5935343

Fax: 886-3-5935342

**Hwa Ya EMC/RF/Safety Lab**

Tel: 886-3-3183232

Fax: 886-3-3270892

**Email:** [service.adt@tw.bureauveritas.com](mailto:service.adt@tw.bureauveritas.com)

**Web Site:** [www.bureauveritas-adt.com](http://www.bureauveritas-adt.com)

The address and road map of all our labs can be found in our web site also.

--- END ---