



Registration
No.788871

TEST REPORT FOR WCDMA TESTING

Report No.: SRTC2018-9004(F)-18062601(B)

Product Name: Mobile Phone

Product Model: Hisense F15

Applicant: Hisense International Co., Ltd.

Manufacturer: Hisense Communications Co., Ltd.

Specification: FCC Part 24E, Part 22H, Part 2, Part 27 (2018)

FCC ID: 2ADOBF15

The State Radio_monitoring_center Testing Center (SRTC)

15th Building, No.30, Shixing Street, Shijingshan District,

Beijing, P.R.China

Tel: 86-10-57996183 Fax: 86-10-57996388

CONTENTS

1. GENERAL INFORMATION	2
1.1 NOTES OF THE TEST REPORT	2
1.2 INFORMATION ABOUT THE TESTING LABORATORY	2
1.3 APPLICANT’S DETAILS	2
1.4 MANUFACTURER’S DETAILS	2
1.5 TEST ENVIRONMENT	3
2 DESCRIPTION OF THE DEVICE UNDER TEST	4
2.1 FINAL EQUIPMENT BUILD STATUS	4
2.2 SUPPORT EQUIPMENT	5
2.3 SUMMARY TABLE	5
3 REFERENCE SPECIFICATION	6
4 KEY TO NOTES AND RESULT CODES	7
5 RESULT SUMMARY	8
6 TEST RESULT	9
6.1 RF POWER OUTPUT-FCC PART 22.913(A)/PART24.232(B)	9
6.2 EFFECTIVE ISOTROPIC RADIATED POWER-FCC 22.913(A)/24.232(B) /27.50(D)(4).....	11
6.3 OCCUPIED BANDWIDTH-FCC 2.1049/ 27.53(H)(1)	15
6.4 EMISSION BANDWIDTH-FCC 22.917(B)/24.238(B).....	17
6.5 SPURIOUS EMISSIONS AT ANTENNA TERMINAL-FCC 2.1051/ 22.917(A)/24.238(A)/ 27.53(H)	19
6.6 BAND EDGES COMPLIANCE-FCC 22.917(B)/24.238(B)/ 27.53(H)	21
6.7 FREQUENCY STABILITY-FCC 2.1055/22.355/24.235/27.54	23
6.8 RADIATED SPURIOUS EMISSIONS-FCC 2.1053/22.917(A)/24.238(A)/ 27.53(H), 27.53(G)	25
6.9 PEAK-AVERAGE RATIO -FCC 24.232(D)/ 27.50(D)(5).....	30
7 MEASUREMENT UNCERTAINTIES	31
8 TEST EQUIPMENTS	32
APPENDIX A – TEST DATA OF CONDUCTED EMISSION	33
APPENDIX B – TEST DATA OF RADIATED EMISSION	97

1. GENERAL INFORMATION

1.1 Notes of the test report

The test report may only be reproduced or published in full. Reproduction or publication of extracts from the report requires the prior written permission of The State Radio_monitoring_center Testing Center (SRTC).

The test results relate only to individual items of the samples which have been tested.

1.2 Information about the testing laboratory

Company:	The State Radio_monitoring_center Testing Center (SRTC)
Address:	15th Building, No.30 Shixing Street, Shijingshan District, P.R.China
City:	Beijing
Country or Region:	P.R.China
Contacted person:	Liu Jia
Tel:	+86 10 57996183
Fax:	+86 10 57996388
Email:	liujiaf@srtc.org.cn

1.3 Applicant's details

Company:	Hisense International Co., Ltd.
Address:	Floor 22, Hisense Tower, 17 Donghai Xi Road, Qingdao, 266071, China
City:	Qingdao
Country or Region:	China
Contacted person:	Geng Ruifeng
Tel:	+86-532-80877742
Fax:	---
Email:	gengruifeng@hisense.com

1.4 Manufacturer's details

Company:	Hisense Communications Co., Ltd.
Address:	218 Qianwangang Road, Qingdao Economic & Technological Development Zone, Qingdao, China
City:	Qingdao
Country or Region:	China
Contacted person:	Dai Qingtao
Tel:	+86-532-55753749
Fax:	---
Email:	daiqingtao@hisense.com

1.5 Test Environment

Date of Receipt of test sample at SRTC:	2018-06-26
Testing Start Date:	2018-06-26
Testing End Date:	2018-08-16

Environmental Data:	Temperature (°C)	Humidity (%)
Ambient	25	30
Maximum Extreme	55	---
Minimum Extreme	-20	---

Normal Supply Voltage (V d.c.):	3.80
Maximum Extreme Supply Voltage (V d.c.):	4.35
Minimum Extreme Supply Voltage (V d.c.):	3.40

2 DESCRIPTION OF THE DEVICE UNDER TEST

2.1 Final Equipment Build Status

Frequency Range	WCDMA Band II: Tx:1852.4~1907.6MHz Rx:1932.4~1987.6MHz WCDMA Band IV: Tx:1712.4~1752.6MHz Rx:2112.4~2152.6MHz WCDMA Band V: Tx:826.4~846.6MHz Rx:871.4~891.6MHz
Rated Output Power	WCDMA Band II:24.0dBm WCDMA Band IV:24.0dBm WCDMA Band V:24.0dBm
Modulation Type	QPSK
Emission Designator	4M50F9W
Duplex Mode	FDD
Duplex Spacing	WCDMA Band II:80MHz WCDMA Band IV:400MHz WCDMA Band V:45MHz
Antenna Type	PIFA Antenna
Power Supply	Battery/AC adapter
HW Version	YK737_V0.2
SW Version	Hisense_F15_4G_10
IMEI	861854039418502

2.2 Support Equipment

The following support equipment was used to exercise the DUT during testing:

Equipment	Charger
Manufacturer	Shenzhen Tianyin Electronics Co.,Ltd
Model Number	TPA-97050100UU
Serial Number	---

Equipment	Battery
Manufacturer	Guangdong Teamgiant New Energy Tech Co.,LTD
Model Number	LIW38210A
Serial Number	---

The products are different on the supplier of LCD/TP/Camera/Flash. There is no change in the RF module and antenna.

Main Supply

Part Name	Model Name	supplier
LCD	ST7701S	JIANGXI HOLITECH TECHNOLOGY CO., LTD
TP	FT6336U	Guizhou Yuye Opto-Electronic Co., Ltd
Camera	GC5025/GC8034	Shenzhen Chengxiangtong technology CO.,LTD
Flash	KMFN60012M-B214	SAMSUNG

Secondary Supply

Part Name	Model Name	supplier
LCD	ST7701S-G5	Shenzhen Digital Technology Co., LTD
TP	FT6336U	JIANGXI HOLITECH TECHNOLOGY CO., LTD
Camera	GC5025/GC8034	Shenzhen Union Image Co.,Ltd
Flash	08EMCP08-EL3DT227	KINGSTON

2.3 Summary table.

FCC Rule Part	Frequency Range(MHz)	Conducted (Average)(dBm)	Antenna Gain	EIRP/ERP(W)	Frequency Tolerance (ppm)	Emission Designator
22H	826.4-846.6	23.27	-1.10	0.100	0.013	4M21F9W
24E	1852.4-1907.6	22.54	-1.50	0.127	0.015	4M20F9W
27	1712.4-1752.6	22.61	-1.50	0.129	0.012	4M20F9W

3 REFERENCE SPECIFICATION

Specification	Version	Title
2.1046	2018	Measurements required: RF power output.
2.1049	2018	Measurements required: Occupied bandwidth.
2.1051	2018	Measurements required: Spurious emissions at antenna terminals.
2.1053	2018	Measurements required: Field strength of spurious radiation.
2.1055	2018	Measurements required: Frequency stability.
22.355	2018	Frequency tolerance.
22.913	2018	Effective radiated power limits.
22.917	2018	Emission limitations for cellular equipment.
24.232	2018	Power and antenna height limits.
24.235/27.54	2018	Frequency stability.
24.238	2018	Emission limitations for Broadband PCS equipment.
27.50	2018	Power limits and duty cycle.
27.53	2018	Emission limits.
ANSI C63.26	2015	American National Standard for Compliance Testing of Transmitters Used in Licensed Radio Services
KDB 971168 D01	April 9, 2018	MEASUREMENT GUIDANCE FOR CERTIFICATION OF LICENSED DIGITAL TRANSMITTERS



4 KEY TO NOTES AND RESULT CODES

The following are the definition of the test result.

Code	Meaning
PASS	Test result shows that the requirements of the relevant specification have been met.
FAIL	Test result shows that the requirements of the relevant specification have not been met.
N/T	Test case is not tested.
NTC	Nominal voltage, Normal Temperature
HV	High voltage, Normal Temperature
LV	Low voltage, Normal Temperature
HTHV	high voltage, High Temperature
LTHV	High voltage, Low Temperature
HTLV	Low voltage, High Temperature
LTLV	Low voltage, Low Temperature

5 RESULT SUMMARY

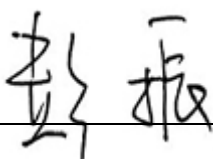
No.	Test case	FCC reference	Verdict
1	RF Power Output	22.913(a)/24.232(b)	Pass
2	Effective Radiated Power and Effective Isotropic Radiated Power	22.913(a)/24.232(b) /27.50(d)(4)	Pass
3	Occupied Bandwidth	2.1049/27.53(h)(1)	Pass
4	Emission Bandwidth	22.917(b)/24.238(b)	Pass
5	Spurious Emissions at antenna terminal	2.1051/22.917(a)/24.238(a)/27.53(h)	Pass
6	Band Edges Compliance	22.917(b)/24.238(b)/ 27.53(h)	Pass
7	Frequency Stability	2.1055/22.355/24.235/27.54	Pass
8	Radiated Spurious Emissions	2.1053/22.917(a)/24.238(a)/27.53(h), 27.53(g)	Pass
9	Peak-Average Ratio	24.232(d)/ 27.50(d)(5)	Pass

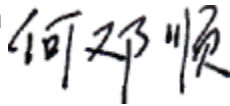
This Test Report Is Issued by: Mr. Peng Zhen 	Checked by: Mr. Li Bin 
Tested by: Mr. He Dengshun 	Issued date: 20180823

6 TEST RESULT

6.1 RF Power Output-FCC Part 22.913(a)/Part24.232(b)

Ambient condition:

Temperature	Relative humidity	Pressure
25°C	30%	101.9kPa

Test Setup:

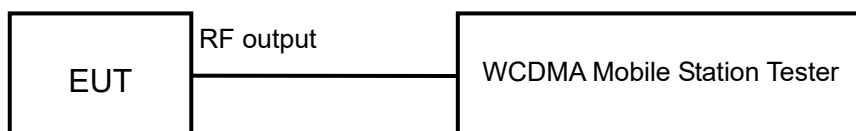

WCDMA band II

Test procedure:

After a radio link has been established between EUT and Tester, the output power of the cell signal of the testing equipment will be decreased until the output power of the EUT reach a maximum value. Then the test data can be read at the tester screen. The loss between RF output port of the EUT and the input port of the tester will be taken into consideration.

The measurement will be conducted at three channels No9262, No9400 and No9538 (Bottom, middle and top channels of WCDMA band II)

Limits	≤24dBm
--------	--------

WCDMA band V

Test procedure:

After a radio link has been established between EUT and Tester, the output power of the cell signal of the testing equipment will be decreased until the output power of the EUT reach a maximum value. Then the test data can be read at the tester screen. The loss between RF output port of the EUT and the input port of the tester will be taken into consideration.

The measurement will be conducted at three channels No4132, No4183 and No4233 (Bottom, middle and top channels of WCDMA band V)

Limits	≤24dBm
--------	--------

WCDMA band IV

Test procedure:

After a radio link has been established between EUT and Tester, the output power of the cell signal of the testing equipment will be decreased until the output power of the EUT reach a maximum value. Then the test data can be read at the tester screen. The loss between RF output port of the EUT and the input port of the tester will be taken into consideration. The measurement will be conducted at three channels No1312, No1412 and No1513 (Bottom, middle and top channels of WCDMA band IV)

Limits	$\leq 24\text{dBm}$
--------	---------------------

Test result:

The test results are shown in Appendix A.

6.2 Effective Isotropic Radiated Power-FCC 22.913(a)/24.232(b) /27.50(d)(4)

Ambient condition:

Temperature	Relative humidity	Pressure
25°C	30%	101.9kPa

Test setup:

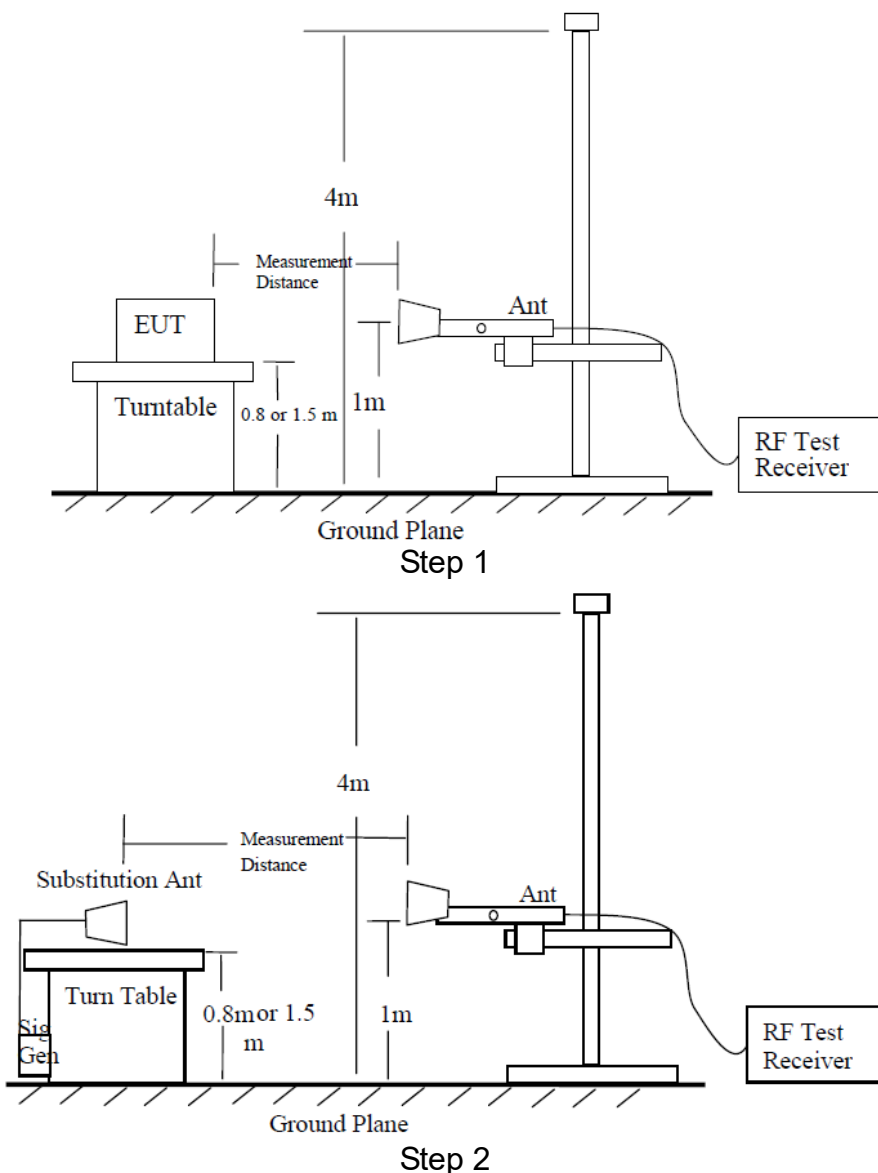

WCDMA band II

Test procedure:

The measurements procedures in TIA-603C-2004 are used.

Step 1:

The measurement is carried out in the fully anechoic chamber. EUT was placed on a 2.4 meters high non-conductive table at a 3 meters test distance from the test receive antenna. A receiving antenna was placed on the antenna mast 3 meters from the EUT. The height of receiving antenna is 2.4m and varies in certain range to find the maximum power value. A radio link shall be established between EUT and Tester. The output power of the cell signal of the tester will be decreased until the output power of the EUT reach a maximum value. A peak detector is used and RBW is set to 3MHz. Then the height of receive antenna shall be moved from 1 to 4 meters, and the antenna shall be performed under horizontal and vertical polarization. The turn table shall be rotated from 0 to 360 degrees for detecting the maximum power value on spectrum analyzer or receiver. And the maximum value of the receiver should be recorded as (Pr).

Step 2:

A log-periodic antenna or double-ridged waveguide horn antenna shall be substituted in place of the EUT. The log-periodic antenna will be driven by a signal generator. To repeat the same procedure as step1 and the level of signal generator will be adjusted till the same power value on the spectrum analyzer or receiver. The ERP/EIRP of the EUT can be calculated through the level of the signal generator, cable loss, the gain of the substitution antenna and the reading of the spectrum analyzer or receiver.

A power (P_{mea}) is applied to the input of the substitution antenna, and adjusts the level of the signal generator output until the value of the receiver reach the previously recorded (Pr). The power of signal source (P_{mea}) is recorded. The test should be performed by rotating the test item and adjusting the receiving antenna polarization.

A “reference path loss” should be calculated after test. The attenuation of “reference path loss” is the cable loss between the Signal Source with the Substitution Antenna (P_{ca}) and the Substitution Antenna Gain (G_a).

The measurement results are obtained as described below:

$$\text{Power (EIRP)} = P_{mea} + P_{ca} + G_a$$

The measurement will be done at three channels No9262, No9400 and No9538 (Bottom, middle and top channels of WCDMA band II).

Limits	≤33dBm
--------	--------

WCDMA band V

Test procedure:

The measurements procedures in TIA-603C-2004 are used.

Step 1:

The measurement is carried out in the fully anechoic chamber. EUT was placed on a 2.4 meters high non-conductive table at a 3 meters test distance from the test receive antenna. A receiving antenna was placed on the antenna mast 3 meters from the EUT. The height of receiving antenna is 2.4m and varies in certain range to find the maximum power value. A radio link shall be established between EUT and Tester. The output power of the cell signal of the tester will be decreased until the output power of the EUT reach a maximum value. A peak detector is used and RBW is set to 3MHz. Then the height of receive antenna shall be moved from 1 to 4 meters, and the antenna shall be performed under horizontal and vertical polarization. The turn table shall be rotated from 0 to 360 degrees for detecting the maximum power value on spectrum analyzer or receiver. And the maximum value of the receiver should be recorded as (Pr).

Step 2:

A log-periodic antenna or double-ridged waveguide horn antenna shall be substituted in place of the EUT. The log-periodic antenna will be driven by a signal generator. To repeat the same procedure as step1 and the level of signal generator will be adjusted till the same power value on the spectrum analyzer or receiver. The ERP/EIRP of the EUT can be calculated through the level of the signal generator, cable loss, the gain of the substitution antenna and the reading of the spectrum analyzer or receiver.

A power (Pmea) is applied to the input of the substitution antenna, and adjusts the level of the signal generator output until the value of the receiver reach the previously recorded (Pr). The power of signal source (Pmea) is recorded. The test should be performed by rotating the test item and adjusting the receiving antenna polarization.

A “reference path loss” should be calculated after test. The attenuation of “reference path loss” is the cable loss between the Signal Source with the Substitution Antenna (Pca) and the Substitution Antenna Gain (Ga).

The measurement results are obtained as described below:

$$\text{Power (EIRP)} = P_{\text{mea}} + P_{\text{ca}} + G_{\text{a}}$$

This value is EIRP since the measurement is calibrated using an antenna of known gain (2.15dB) and known input power. ERP can be calculated from EIRP by subtracting the gain of the dipole, $\text{ERP} = \text{EIRP} - 2.15 \text{ (dB)}$.

The measurement will be done at three channels No4132, No4183 and No4233 (Bottom, middle and top channels of WCDMA band V)

Limits	$\leq 38.5 \text{ dBm}$
--------	-------------------------

WCDMA band IV

Test procedure:

The measurements procedures in TIA-603C-2004 are used.

Step 1:

The measurement is carried out in the fully anechoic chamber. EUT was placed on a 2.4 meters high non-conductive table at a 3 meters test distance from the test receive antenna. A receiving antenna was placed on the antenna mast 3 meters from the EUT. The height of receiving antenna is 2.4m and varies in certain range to find the maximum power value. A radio link shall be established between EUT and Tester. The output power of the cell signal of the tester will be decreased until the output power of the EUT reach a maximum value. A peak detector is used and RBW is set to 3MHz. Then the height of receive antenna shall be moved from 1 to 4 meters, and the antenna shall be performed under horizontal and vertical polarization. The turn table shall be rotated from 0 to 360 degrees for detecting the maximum power value on spectrum analyzer or receiver. And the maximum value of the receiver should be recorded as (Pr).

Step 2:

A log-periodic antenna or double-ridged waveguide horn antenna shall be substituted in place of the EUT. The log-periodic antenna will be driven by a signal generator. To repeat the same procedure as step1 and the level of signal generator will be adjusted till the same power value on the spectrum analyzer or receiver. The ERP/EIRP of the EUT can be calculated through the level of the signal generator, cable loss, the gain of the substitution antenna and the reading of the spectrum analyzer or receiver.

A power (P_{mea}) is applied to the input of the substitution antenna, and adjusts the level of the signal generator output until the value of the receiver reach the previously recorded (Pr). The power of signal source (P_{mea}) is recorded. The test should be performed by rotating the test item and adjusting the receiving antenna polarization.

A “reference path loss” should be calculated after test. The attenuation of “reference path loss” is the cable loss between the Signal Source with the Substitution Antenna (P_{ca}) and the Substitution Antenna Gain (G_a).

The measurement results are obtained as described below:

$$\text{Power (EIRP)} = P_{mea} + P_{ca} + G_a$$

The measurement will be done at three channels No1312, No1412 and No1513 (Bottom, middle and top channels of WCDMA band IV).

Limits	≤30dBm
--------	--------

Test result:

The test results are shown in Appendix B.

6.3 Occupied Bandwidth-FCC 2.1049/ 27.53(h)(1)

Ambient condition:

Temperature	Relative humidity	Pressure
25°C	30%	101.9kPa

Test Setup:

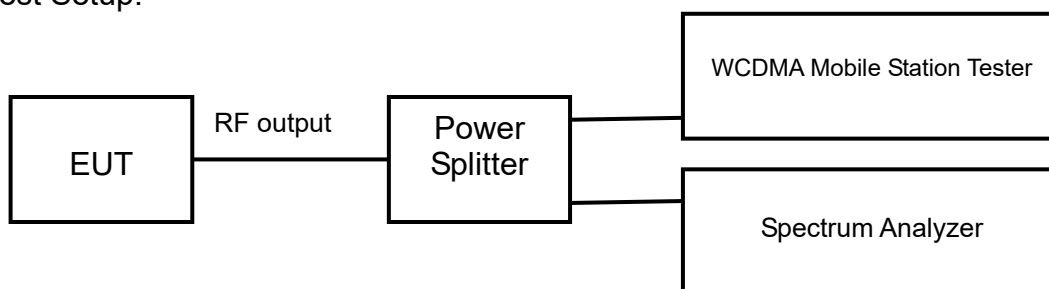

WCDMA band II

Test procedure:

After a radio link has been established between EUT and Tester, the output power of the cell signal of the testing equipment will be decreased until the output power of the EUT reach a maximum value. The occupied bandwidth is measured using spectrum analyzer. RBW is set to 51kHz on spectrum analyzer. The bandwidth of 99% power can be read on spectrum analyzer.

The measurement will be conducted at three channels No9262, No9400 and No9538 (Bottom, middle and top channels of WCDMA band II)

Limits: No specific occupied bandwidth requirements in part 2.1049

WCDMA band V

Test procedure:

After a radio link has been established between EUT and Tester, the output power of the cell signal of the testing equipment will be decreased until the output power of the EUT reach a maximum value. The occupied bandwidth is measured using spectrum analyzer. RBW is set to 30kHz on spectrum analyzer. The bandwidth of 99% power can be read on spectrum analyzer.

The measurement will be conducted at three channels No4132, No4183 and No4233 (Bottom, middle and top channels of WCDMA band V)

Limits: No specific occupied bandwidth requirements in part 2.1049

WCDMA band IV

Test procedure:

After a radio link has been established between EUT and Tester, the output power of the cell signal of the testing equipment will be decreased until the output power of the EUT reach a maximum value. The occupied bandwidth is measured using spectrum analyzer. RBW is set to 51kHz on spectrum analyzer. The bandwidth of 99% power can be read on spectrum analyzer.

The measurement will be conducted at three channels No1312, No1412 and No1513 (Bottom, middle and top channels of WCDMA band IV)

Limits: No specific occupied bandwidth requirements in part 2.1049

Test result:

The test results are shown in Appendix A.

6.4 Emission Bandwidth-FCC 22.917(b)/24.238(b)

Ambient condition:

Temperature	Relative humidity	Pressure
25°C	30%	101.9kPa

Test Setup:

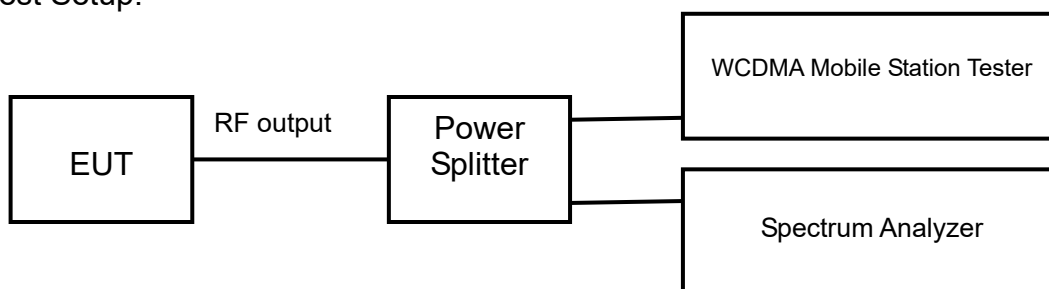

WCDMA band II

Test procedure:

After a radio link has been established between EUT and Tester, the output power of the cell signal of the testing equipment will be decreased until the output power of the EUT reach a maximum value. The emission bandwidth is measured using spectrum analyzer. RBW is set to 30kHz on spectrum analyzer. The bandwidth of -26dBc power can be read on spectrum analyzer.

The measurement will be conducted at three channels No9262, No9400 and No9538 (Bottom, middle and top channels of WCDMA band II)

Limits: No specific emission bandwidth requirements in part 24.238(b)

WCDMA band V

Test procedure:

After a radio link has been established between EUT and Tester, the output power of the cell signal of the testing equipment will be decreased until the output power of the EUT reach a maximum value. The emission bandwidth is measured using spectrum analyzer. RBW is set to 30kHz on spectrum analyzer. The bandwidth of -26dBc power can be read on spectrum analyzer.

The measurement will be conducted at three channels No9262, No9400 and No9538 (Bottom, middle and top channels of WCDMA band V)

Limits: No specific emission bandwidth requirements in part 22.917(b)

WCDMA band IV

Test procedure:

After a radio link has been established between EUT and Tester, the output power of the cell signal of the testing equipment will be decreased until the output power of the EUT reach a maximum value. The emission bandwidth is measured using spectrum analyzer. RBW is set to 30kHz on spectrum analyzer. The bandwidth of -26dBc power can be read on spectrum analyzer.

The measurement will be conducted at three channels No1312, No1412 and No1513 (Bottom, middle and top channels of WCDMA band IV)

Limits: No specific emission bandwidth requirements in part 24.238(b)

Test result:

The test results are shown in Appendix A.

6.5 Spurious Emissions at antenna terminal-FCC 2.1051/ 22.917(a)/24.238(a)/ 27.53(h)

Ambient condition:

Temperature	Relative humidity	Pressure
25°C	30%	101.9kPa

Test Setup:

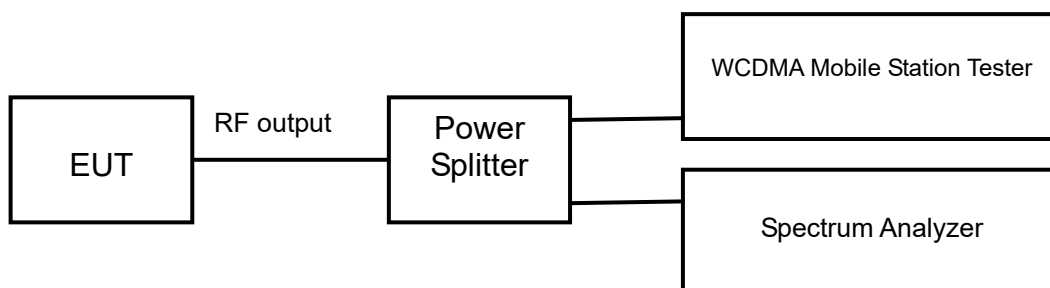

WCDMA band II

Test procedure:

After a radio link has been established between EUT and Tester, the output power of the cell signal of the testing equipment will be decreased until the output power of the EUT reach a maximum value. The measurement is carried out using a spectrum analyzer. The spectrum analyzer scans from 30MHz to 20GHz (higher than the 10th harmonic of the carrier). The peak detector is used and RBW is set to 1MHz on spectrum analyzer.

The measurement will be conducted at one channel No9400 (middle channel of WCDMA band II)

Limits	≤-13dBm
--------	---------

WCDMA band V

Test procedure:

After a radio link has been established between EUT and Tester, the output power of the cell signal of the testing equipment will be decreased until the output power of the EUT reach a maximum value. The measurement is carried out using a spectrum analyzer. The spectrum analyzer scans from 30MHz to 9GHz (higher than the 10th harmonic of the carrier). The peak detector is used and RBW is set to 1MHz on spectrum analyzer.

The measurement will be conducted at one channel No4183 (middle channel of WCDMA band V)

Limits	≤-13dBm
--------	---------

WCDMA band IV

Test procedure:

After a radio link has been established between EUT and Tester, the output power of the cell signal of the testing equipment will be decreased until the output power of the EUT reach a maximum value. The measurement is carried out using a spectrum analyzer. The spectrum analyzer scans from 30MHz to 20GHz (higher than the 10th harmonic of the carrier). The peak detector is used and RBW is set to 1MHz on spectrum analyzer.

The measurement will be conducted at one channel No1412 (middle channel of WCDMA band IV)

Limits	$\leq -13\text{dBm}$
--------	----------------------

Test result:

The test results are shown in Appendix A.

6.6 Band Edges Compliance-FCC 22.917(b)/24.238(b)/ 27.53(h)

Ambient condition:

Temperature	Relative humidity	Pressure
25°C	30%	101.9kPa

Test Setup:

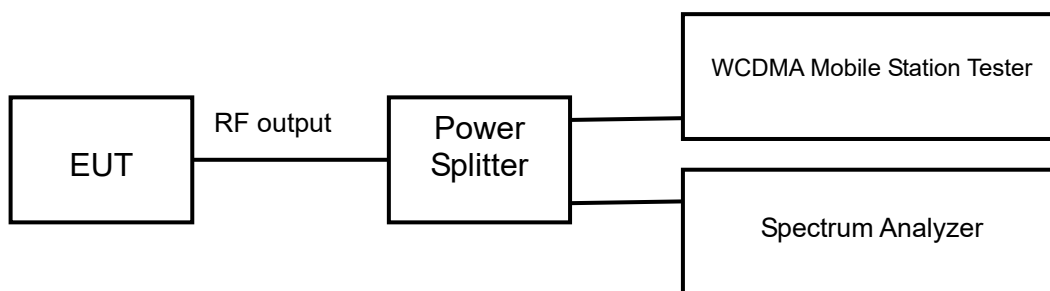

WCDMA band II

Test procedure:

After a radio link has been established between EUT and Tester, the output power of the cell signal of the testing equipment will be decreased until the output power of the EUT reach a maximum value. The measurement is carried out using a spectrum analyzer. The peak detector is used and RBW is set to at least 1% of the emission bandwidth on spectrum analyzer.

The measurement will be conducted at two channels No9262 and No9538 (Bottom and top channels of WCDMA band II)

Limits	≤-13dBm

WCDMA band V

Test procedure:

After a radio link has been established between EUT and Tester, the output power of the cell signal of the testing equipment will be decreased until the output power of the EUT reach a maximum value. The measurement is carried out using a spectrum analyzer. The peak detector is used and RBW is set to at least 1% of the emission bandwidth on spectrum analyzer.

The measurement will be conducted at two channels No4132 and No4233 (Bottom and top channels of WCDMA band V)

Limits	≤-13dBm

WCDMA band IV

Test procedure:

After a radio link has been established between EUT and Tester, the output power of the cell signal of the testing equipment will be decreased until the output power of the EUT reach a maximum value. The measurement is carried out using a spectrum analyzer. The peak detector is used and RBW is set to at least 1% of the emission bandwidth on spectrum analyzer.

The measurement will be conducted at two channels No1312 and No1513 (Bottom and top channels of WCDMA band IV)

Limits	$\leq -13\text{dBm}$
--------	----------------------

Test result:

The test results are shown in Appendix A.

6.7 Frequency Stability-FCC 2.1055/22.355/24.235/27.54

Ambient condition:

Temperature	Relative humidity	Pressure
25°C	30%	101.9kPa

Test setup:

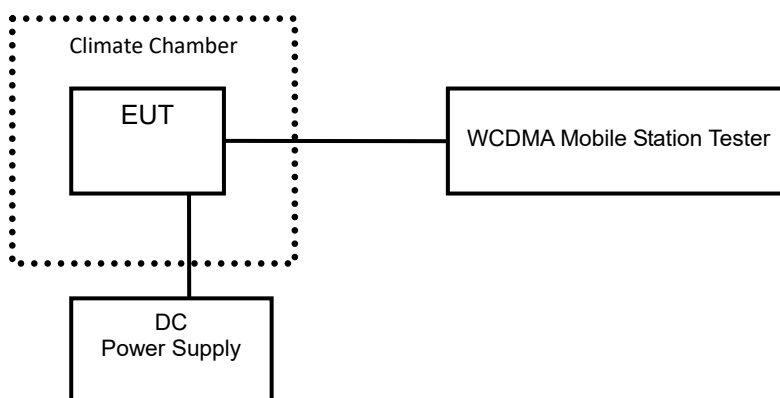

WCDMA band II

Test Procedure:

A radio link shall be established between EUT and Tester. The tester will sample the transmitter RF output signal and measure its frequency. The temperature inside the climate chamber is varied from -30 to +50°C in 10°C step size, and also the DC power supply voltage to the EUT is varied from LV to HV. The measurement will be conducted at three channels No9262, No9400 and No9538 (Bottom, middle and top channels of WCDMA band II).

Limits: No specific frequency stability requirements in part 2.1055 and part 24.235.

WCDMA band V

Test Procedure:

A radio link shall be established between EUT and Tester. The tester will sample the transmitter RF output signal and measure its frequency. The temperature inside the climate chamber is varied from -30 to +50°C in 10°C step size, and also the DC power supply voltage to the EUT is varied from LV to HV. The measurement will be conducted at three channels No4132, No4183 and No4233 (Bottom, middle and top channels of WCDMA band V).

Limits: No specific frequency stability requirements in part 2.1055 and part 22.355.

WCDMA band IV

Test Procedure:

A radio link shall be established between EUT and Tester. The tester will sample the transmitter RF output signal and measure its frequency. The temperature inside the climate chamber is varied from -30 to +50°C in 10°C step size, and also the DC power supply voltage to the EUT is varied from LV to HV. The measurement will be conducted at three channels No1312, No1412 and No1513 (Bottom, middle and top channels of WCDMA band IV).

Limits: No specific frequency stability requirements in part 2.1055 and part 24.235.

Test result:

The test results are shown in Appendix A.

6.8 Radiated Spurious Emissions-FCC 2.1053/22.917(a)/24.238(a)/ 27.53(h), 27.53(g)

Ambient condition:

Temperature	Relative humidity	Pressure
25°C	30%	101.9kPa

Test Setup:

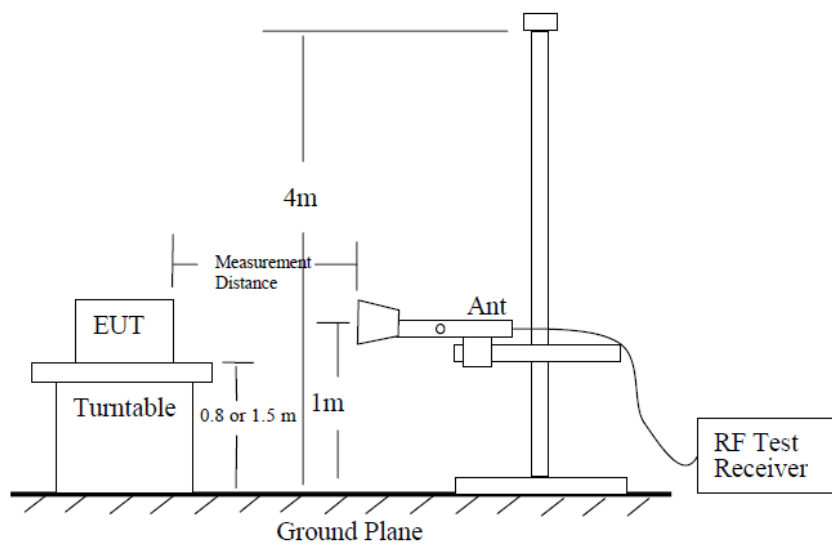

Step 1

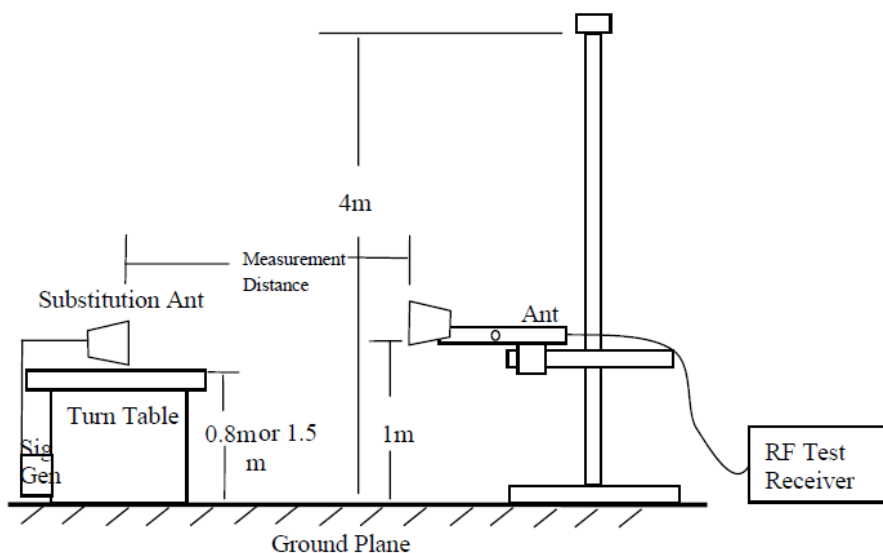

Step 2

WCDMA band II

Test procedure:

The measurements procedures in TIA-603C-2004 are used.

The spectrum was scanned from 30MHz to the 10th harmonic of the highest frequency generated within the equipment.

Step 1:

The measurement is carried out in the fully anechoic chamber. EUT was placed on a 2.4 meter high non-conductive table at a 3 meter test distance from the test receive antenna. A receiving antenna was placed on the antenna mast 3 meters from the EUT. The height of receiving antenna is 2.4m and varies in certain range to find the maximum power value. A radio link shall be established between EUT and Tester. The output power of the cell signal of the tester will be decreased until the output power of the EUT reach a maximum value. The measurement is carried out using a spectrum analyzer or receiver. The spectrum analyzer scans from 30MHz to 20GHz (higher than the 10th harmonic of the carrier). The peak detector is used and RBW is set to 1MHz on spectrum analyzer. Then the antenna height and turn table rotation is adjusted till the maximum power value is founded on spectrum analyzer or receiver. A notch filter is necessary in the band near to the carrier frequency. A high pass filter is needed to avoid the distortion of the testing equipment in the band above the carrier frequency.

Step 2:

A log-periodic antenna or double-ridged waveguide horn antenna shall be substituted in place of the EUT. The log-periodic antenna will be driven by a signal generator and the level will be adjusted till the same power value on the spectrum analyzer or receiver. The level of the spurious emissions can be calculated through the level of the signal generator, cable loss, the gain of the substitution antenna and the reading of the spectrum analyzer or receiver.

A power (P_{mea}) is applied to the input of the substitution antenna, and adjusts the level of the signal generator output until the value of the receiver reach the previously recorded (P_r). The power of signal source (P_{mea}) is recorded. The test should be performed by rotating the test item and adjusting the receiving antenna polarization.

A "reference path loss" should be calculated after test. The attenuation of "reference path loss" is the cable loss between the Signal Source with the Substitution Antenna (P_{ca}) and the Substitution Antenna Gain (G_a).

Calculation procedure:

The data of cable loss and antenna gain has been calibrated in full testing frequency range before the testing.

The power of the Radiated Spurious Emissions is calculated by adding the cable loss and antenna gain. The basic equation with a sample calculation is as followed:

$$\text{Power(EIRP)} = P_{mea} + P_{ca} + G_a$$

This value is EIRP since the measurement is calibrated using an antenna of known gain (2.15dB) and known input power. ERP can be calculated from EIRP by subtracting the gain of the dipole, $ERP = EIRP - 2.15$ (dB).

Assumed the power of signal source record is -20dBm. A cable loss of -30dB, and an

antenna gain of 11dB are added.

$$P=P_{\text{mea}}+P_{\text{ca}}+G_a=(-20\text{dBm})+(-30\text{dB})+(11\text{dB})= -39\text{dBm}$$

The measurement will be done at carrier frequencies that pertain to bottom (Channel 9262), middle (Channel 9400) and top (Channel 9538) channels of WCDMA band II.

WCDMA band V

Test procedure:

The measurements procedures in TIA-603C-2004 are used.

The spectrum was scanned from 30MHz to the 10th harmonic of the highest frequency generated within the equipment.

Step 1:

The measurement is carried out in the fully anechoic chamber. EUT was placed on a 2.4 meter high non-conductive table at a 3 meter test distance from the test receive antenna. A receiving antenna was placed on the antenna mast 3 meters from the EUT. The height of receiving antenna is 2.4m and varies in certain range to find the maximum power value. A radio link shall be established between EUT and Tester. The output power of the cell signal of the tester will be decreased until the output power of the EUT reach a maximum value. The measurement is carried out using a spectrum analyzer or receiver. The spectrum analyzer scans from 30MHz to 20GHz (higher than the 10th harmonic of the carrier). The peak detector is used and RBW is set to 1MHz on spectrum analyzer. Then the antenna height and turn table rotation is adjusted till the maximum power value is founded on spectrum analyzer or receiver. A notch filter is necessary in the band near to the carrier frequency. A high pass filter is needed to avoid the distortion of the testing equipment in the band above the carrier frequency.

Step 2:

A log-periodic antenna or double-ridged waveguide horn antenna shall be substituted in place of the EUT. The log-periodic antenna will be driven by a signal generator and the level will be adjusted till the same power value on the spectrum analyzer or receiver. The level of the spurious emissions can be calculated through the level of the signal generator, cable loss, the gain of the substitution antenna and the reading of the spectrum analyzer or receiver.

A power (P_{mea}) is applied to the input of the substitution antenna, and adjusts the level of the signal generator output until the value of the receiver reach the previously recorded (P_r). The power of signal source (P_{mea}) is recorded. The test should be performed by rotating the test item and adjusting the receiving antenna polarization.

A "reference path loss" should be calculated after test. The attenuation of "reference path loss" is the cable loss between the Signal Source with the Substitution Antenna (P_{ca}) and the Substitution Antenna Gain (G_a).

Calculation procedure:

The data of cable loss and antenna gain has been calibrated in full testing frequency range before the testing.

The power of the Radiated Spurious Emissions is calculated by adding the cable loss and antenna gain. The basic equation with a sample calculation is as followed:

$$\text{Power(EIRP)} = P_{\text{mea}} + P_{\text{ca}} + G_a$$

This value is EIRP since the measurement is calibrated using an antenna of known gain (2.15dB) and known input power. ERP can be calculated from EIRP by subtracting the gain of the dipole, $\text{ERP} = \text{EIRP} - 2.15 \text{ (dB)}$.

Assumed the power of signal source record is -20dBm. A cable loss of -30dB, and an antenna gain of 11dB are added.

$$P = P_{\text{mea}} + P_{\text{ca}} + G_a = (-20\text{dBm}) + (-30\text{dB}) + (11\text{dB}) = -39\text{dBm}$$

The measurement will be done at carrier frequencies that pertain to bottom (Channel 4132), middle (Channel 4183) and top (Channel 4233) channels of WCDMA band V.

WCDMA band IV

Test procedure:

The measurements procedures in TIA-603C-2004 are used.

The spectrum was scanned from 30MHz to the 10th harmonic of the highest frequency generated within the equipment.

Step 1:

The measurement is carried out in the fully anechoic chamber. EUT was placed on a 2.4 meter high non-conductive table at a 3 meter test distance from the test receive antenna. A receiving antenna was placed on the antenna mast 3 meters from the EUT. The height of receiving antenna is 2.4m and varies in certain range to find the maximum power value. A radio link shall be established between EUT and Tester. The output power of the cell signal of the tester will be decreased until the output power of the EUT reach a maximum value. The measurement is carried out using a spectrum analyzer or receiver. The spectrum analyzer scans from 30MHz to 20GHz (higher than the 10th harmonic of the carrier). The peak detector is used and RBW is set to 1MHz on spectrum analyzer. Then the antenna height and turn table rotation is adjusted till the maximum power value is founded on spectrum analyzer or receiver. A notch filter is necessary in the band near to the carrier frequency. A high pass filter is needed to avoid the distortion of the testing equipment in the band above the carrier frequency.

Step 2:

A log-periodic antenna or double-ridged waveguide horn antenna shall be substituted in place of the EUT. The log-periodic antenna will be driven by a signal generator and the level will be adjusted till the same power value on the spectrum analyzer or receiver. The level of the spurious emissions can be calculated through the level of the signal generator, cable loss, the gain of the substitution antenna and the reading of the spectrum analyzer or receiver.

A power (P_{mea}) is applied to the input of the substitution antenna, and adjusts the level of the signal generator output until the value of the receiver reach the previously recorded (P_r). The power of signal source (P_{mea}) is recorded. The test should be performed by rotating the test item and adjusting the receiving antenna polarization.

A "reference path loss" should be calculated after test. The attenuation of "reference path loss" is the cable loss between the Signal Source with the Substitution Antenna (P_{ca}) and

the Substitution Antenna Gain (G_a).

Calculation procedure:

The data of cable loss and antenna gain has been calibrated in full testing frequency range before the testing.

The power of the Radiated Spurious Emissions is calculated by adding the cable loss and antenna gain. The basic equation with a sample calculation is as followed:

$$\text{Power(EIRP)} = P_{\text{mea}} + P_{\text{ca}} + G_a$$

This value is EIRP since the measurement is calibrated using an antenna of known gain (2.15dB) and known input power. ERP can be calculated from EIRP by subtracting the gain of the dipole, $\text{ERP} = \text{EIRP} - 2.15 \text{ (dB)}$.

Assumed the power of signal source record is -20dBm. A cable loss of -30dB, and an antenna gain of 11dB are added.

$$P = P_{\text{mea}} + P_{\text{ca}} + G_a = (-20\text{dBm}) + (-30\text{dB}) + (11\text{dB}) = -39\text{dBm}$$

The measurement will be done at carrier frequencies that pertain to bottom (Channel 1312), middle (Channel 1412) and top (Channel 1513) channels of WCDMA band IV.

Test result:

The test results are shown in Appendix B.

6.9 Peak-Average Ratio -FCC 24.232(d)/ 27.50(d)(5)

Ambient condition:

Temperature	Relative humidity	Pressure
25°C	30%	101.9kPa

Test Setup:

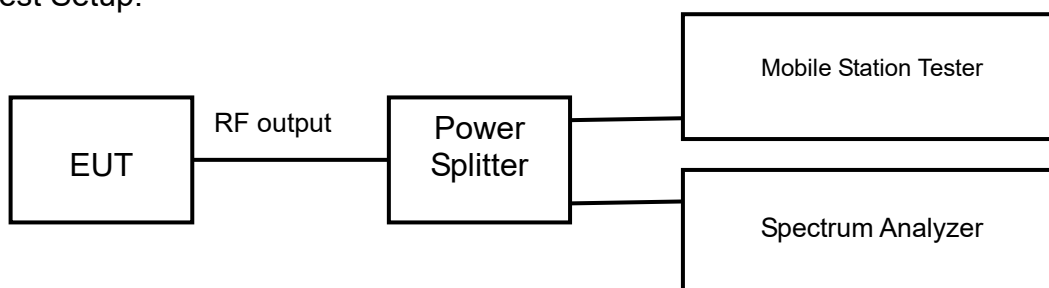

Test procedure:

After a radio link has been established between EUT and Tester, the output power of the cell signal of the testing equipment will be decreased until the output power of the EUT reach a maximum value. The Peak-Average Ratio is measured using spectrum analyzer. RBW is set to 30kHz on spectrum analyzer. The Peak-Average Ratio can be read on spectrum analyzer.

Limits: the peak-to-average ratio (PAR) of the transmission may not exceed 13 dB.

Test result:

The test results are shown in Appendix A

7 MEASUREMENT UNCERTAINTIES

Items	Uncertainty	
RF Power Output	U=0.6 dB	
Occupied Bandwidth	3kHz	
Spurious Emissions	9kHz~2GHz	U=1.2dB
	2G~3.6GHz	U=1.4dB
	3.6G~8GHz	U=2.2dB
	8G~12.75GHz	U=2.7dB
Band Edges Compliance	1.2dB	
Frequency Stability	U=48 Hz	

8 TEST EQUIPMENTS

No.	Name/Model	Manufacturer	S/N	Calibration Date	Calibration Due Date
1	E5515C(8960) Mobile Station Tester	Agilent	MY50266302	2017.8.20	2018.8.19
2	N9020A Spectrum Analyzer	Agilent	MY48010771	2017.8.20	2018.8.19
3	DC Power Supply E3645A	Agilent	MY40000741	2018.3.01	2019.2.28
5	Temperature chamber SH241	ESPEC	92013758	2017.8.20	2018.8.19
6	12.65m×8.03m×7.50m Fully-Anechoic Chamber	FRANKONIA	---	---	---
7	Turn table Diameter:1m	HD	---	---	---
8	Antenna master FAC(MA4.0)	MATURO	---	---	---
9	HF 906 Double-Ridged Waveguide Horn Antenna	R&S	100030	2017.8.20	2018.8.19
10	HL562 Ultra log antenna	R&S	100016	2017.8.20	2018.8.19
11	3160-09 Receive antenna	SCHWARZ-BECK	002058-002	2017.8.20	2018.8.19
12	ESI 40 EMI test receiver	R&S	100015	2017.8.20	2018.8.19
13	Radio tester	CMU 200	114667	2017.8.20	2018.8.19

APPENDIX A – TEST DATA OF CONDUCTED EMISSION

Please refer to the attachment.

APPENDIX B – TEST DATA OF RADIATED EMISSION

Please refer to the attachment.

APPENDIX A – TEST DATA OF CONDUCTED EMISSION

RF Power Output-FCC Part 22.913(a)/Part 24.232(b)

WCDMA band II

Antenna gain=-1.5dBi

WCDMA Mode:

Carrier frequency (MHz)	Channel No.	RF Power Output (dBm)	EIRP (dBm)
1852.4	9262	22.54	21.04
1880.0	9400	22.45	20.95
1907.6	9538	22.16	20.66

HSDPA/HSUPA Mode:

Carrier frequency (MHz)	Channel No.	RF Power Output (dBm)	EIRP (dBm)
1852.4	9262	21.27	19.77
1880.0	9400	21.14	19.64
1907.6	9538	21.18	19.68

HSPA+ Mode:

Carrier frequency (MHz)	Channel No.	RF Power Output (dBm)	EIRP (dBm)
1852.4	9262	21.24	19.74
1880.0	9400	21.21	19.71
1907.6	9538	21.16	19.66

DC-HSDPA Mode:

Carrier frequency (MHz)	Channel No.	RF Power Output (dBm)	EIRP (dBm)
1852.4	9262	21.13	19.63
1880.0	9400	21.14	19.64
1907.6	9538	21.16	19.66

WCDMA band V

ERP=Conducted Power+ Antenna Gain- Ga Antenna Gain

Antenna Gain=-1.1dBi

Ga Antenna Gain=2.15dB

WCDMA Mode:

Carrier frequency (MHz)	Channel No.	RF Power Output (dBm)	ERP (dBm)
826.4	4132	23.25	20.00
836.6	4183	23.27	20.02
846.6	4233	23.23	19.98

HSDPA/HSUPA Mode:

Carrier frequency (MHz)	Channel No.	RF Power Output (dBm)	ERP (dBm)
826.4	4132	22.14	18.89
836.6	4183	22.31	19.06
846.6	4233	22.24	18.99

HSPA+ Mode:

Carrier frequency (MHz)	Channel No.	RF Power Output (dBm)	ERP (dBm)
826.4	4132	22.13	18.88
836.6	4183	22.34	19.09
846.6	4233	22.26	19.01

DC-HSDPA Mode:

Carrier frequency (MHz)	Channel No.	RF Power Output (dBm)	ERP (dBm)
826.4	4132	22.13	18.88
836.6	4183	22.34	19.09
846.6	4233	22.26	19.01

WCDMA band IV

Antenna gain=-1.5dBi

WCDMA Mode:

Carrier frequency (MHz)	Channel No.	RF Power Output (dBm)	EIRP (dBm)
1712.4	1312	22.59	21.09
1732.4	1412	22.61	21.11
1752.6	1513	22.47	20.97

HSDPA/HSUPA Mode:

Carrier frequency (MHz)	Channel No.	RF Power Output (dBm)	EIRP (dBm)
1712.4	1312	21.14	19.64
1732.4	1412	21.26	19.76
1752.6	1513	21.18	19.68

HSPA+ Mode:

Carrier frequency (MHz)	Channel No.	RF Power Output (dBm)	EIRP (dBm)
1712.4	1312	21.31	19.81
1732.4	1412	21.24	19.74
1752.6	1513	21.15	19.65

DC-HSDPA Mode:

Carrier frequency (MHz)	Channel No.	RF Power Output (dBm)	EIRP (dBm)
1712.4	1312	21.14	19.64
1732.4	1412	21.15	19.65
1752.6	1513	21.11	19.61

Occupied Bandwidth-FCC 2.1049/ 27.53(h)(1)

WCDMA band II

WCDMA Mode:

Carrier frequency (MHz)	Channel No.	Bandwidth of 99% Power (MHz)
1852.4	9262	4.1874
1880.0	9400	4.1612
1907.6	9538	4.1828

HSDPA/HSUPA Mode:

Carrier frequency (MHz)	Channel No.	Bandwidth of 99% Power (MHz)
1852.4	9262	4.1839
1880.0	9400	4.1951
1907.6	9538	4.1759

HSPA+ Mode:

Carrier frequency (MHz)	Channel No.	Bandwidth of 99% Power (MHz)
1852.4	9262	4.1754
1880.0	9400	4.1507
1907.6	9538	4.1804

DC-HSDPA Mode:

Carrier frequency (MHz)	Channel No.	Bandwidth of 99% Power (MHz)
1852.4	9262	4.1985
1880.0	9400	4.1818
1907.6	9538	4.1772

WCDMA band V

WCDMA Mode:

Carrier frequency (MHz)	Channel No.	Bandwidth of 99% Power (MHz)
826.4	4132	4.1703
836.6	4183	4.2050
846.6	4233	4.2002

HSDPA/HSUPA Mode:

Carrier frequency (MHz)	Channel No.	Bandwidth of 99% Power (MHz)
826.4	4132	4.1683
836.6	4183	4.1992
846.6	4233	4.1938

HSPA+ Mode:

Carrier frequency (MHz)	Channel No.	Bandwidth of 99% Power (MHz)
826.4	4132	4.1883
836.6	4183	4.2093
846.6	4233	4.1829

DC-HSDPA Mode:

Carrier frequency (MHz)	Channel No.	Bandwidth of 99% Power (MHz)
826.4	4132	4.1893
836.6	4183	4.1748
846.6	4233	4.1757

WCDMA band IV

WCDMA Mode:

Carrier frequency (MHz)	Channel No.	Bandwidth of 99% Power (MHz)
1712.4	1312	4.1850
1732.4	1412	4.1609
1752.6	1513	4.1775

HSDPA/HSUPA Mode:

Carrier frequency (MHz)	Channel No.	Bandwidth of 99% Power (MHz)
1712.4	1312	4.1822
1732.4	1412	4.1784
1752.6	1513	4.1697

HSPA+ Mode:

Carrier frequency (MHz)	Channel No.	Bandwidth of 99% Power (MHz)
1712.4	1312	4.1989
1732.4	1412	4.1613
1752.6	1513	4.1572

DC-HSDPA Mode:

Carrier frequency (MHz)	Channel No.	Bandwidth of 99% Power (MHz)
1712.4	1312	4.2014
1732.4	1412	4.1632
1752.6	1513	4.1725

WCDMA band II

WCDMA Mode:

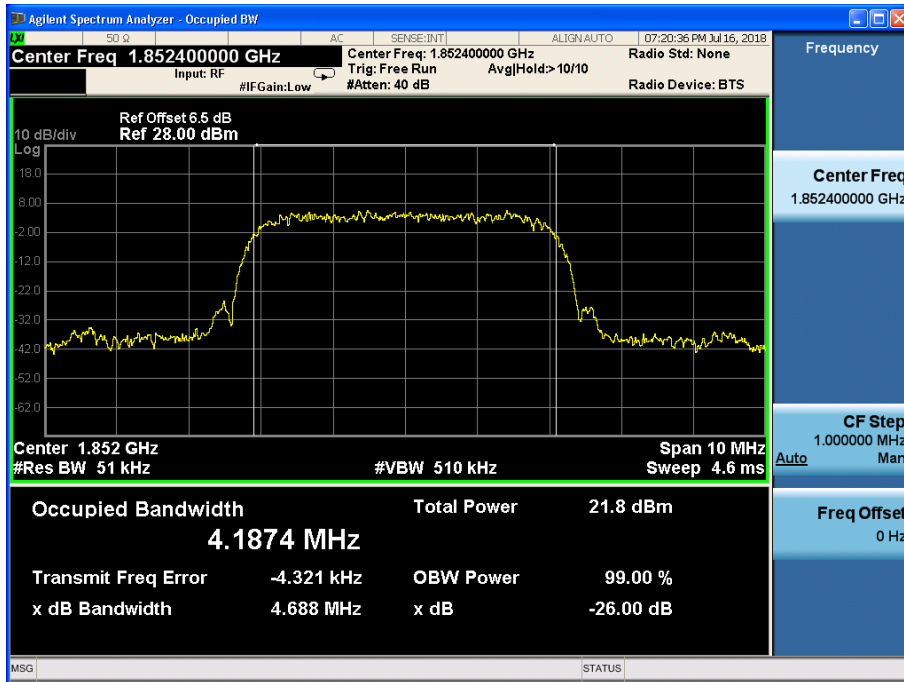

Channel 9262

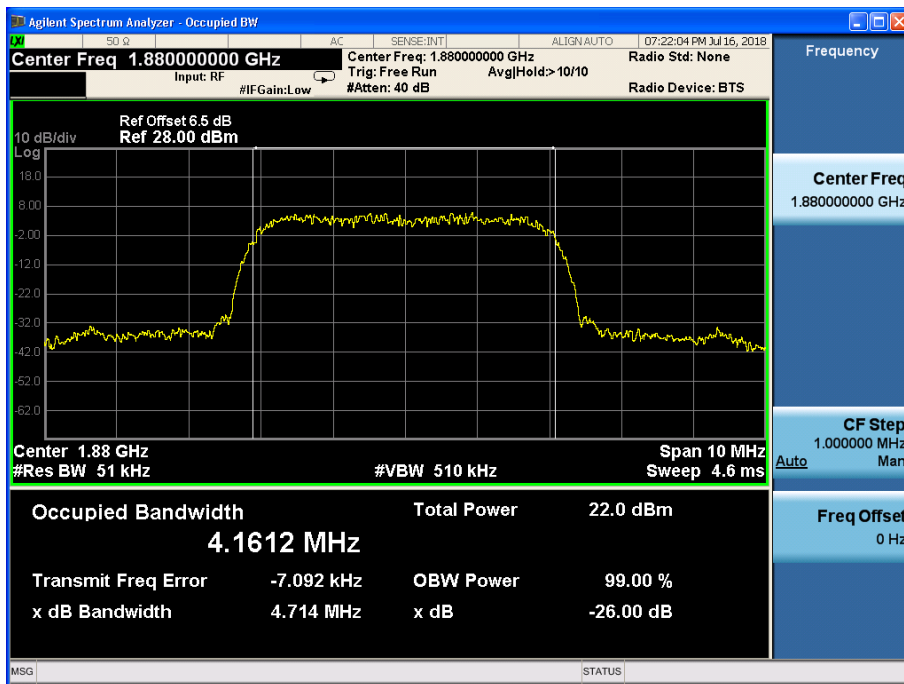

Channel 9400

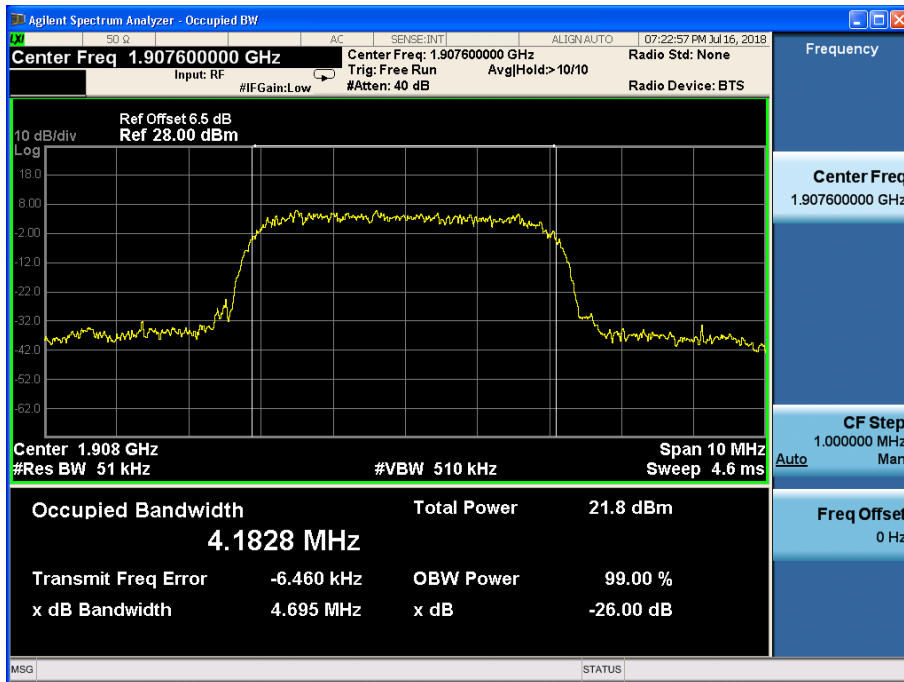

Channel 9538

HSDPA/HSUPA Mode:

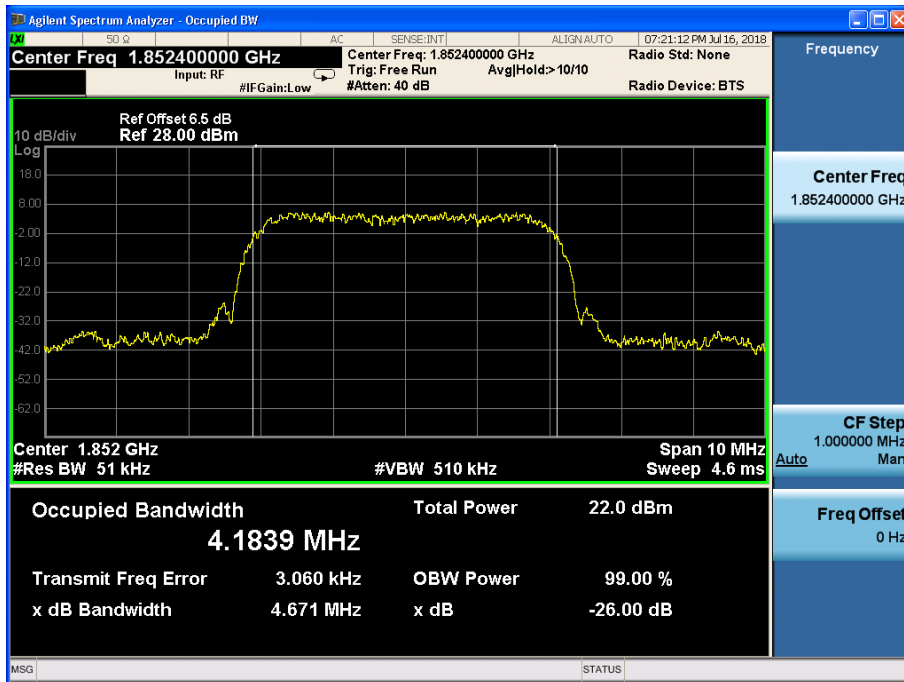

Channel 9262

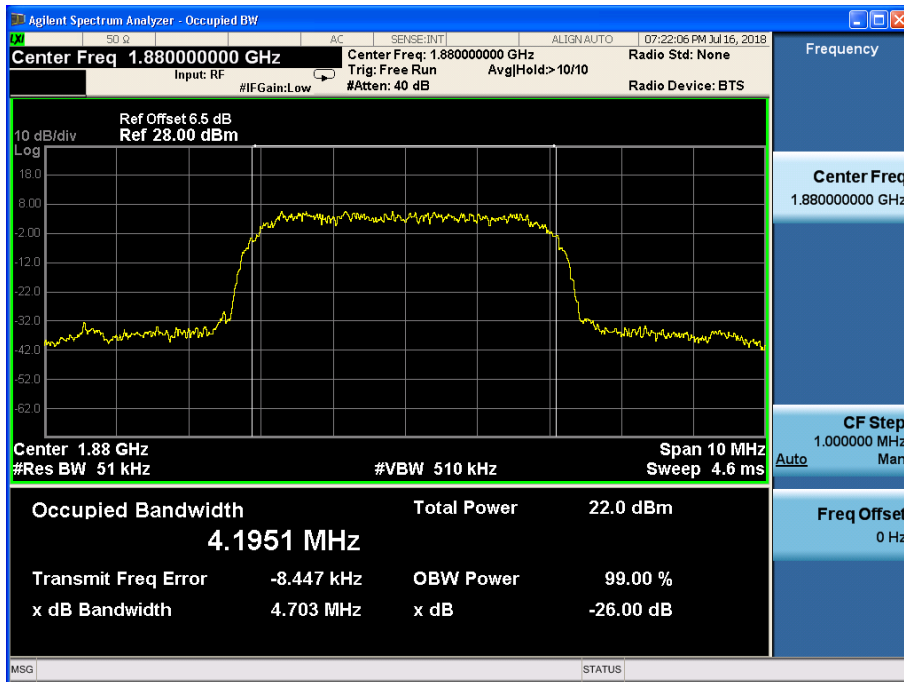

Channel 9400

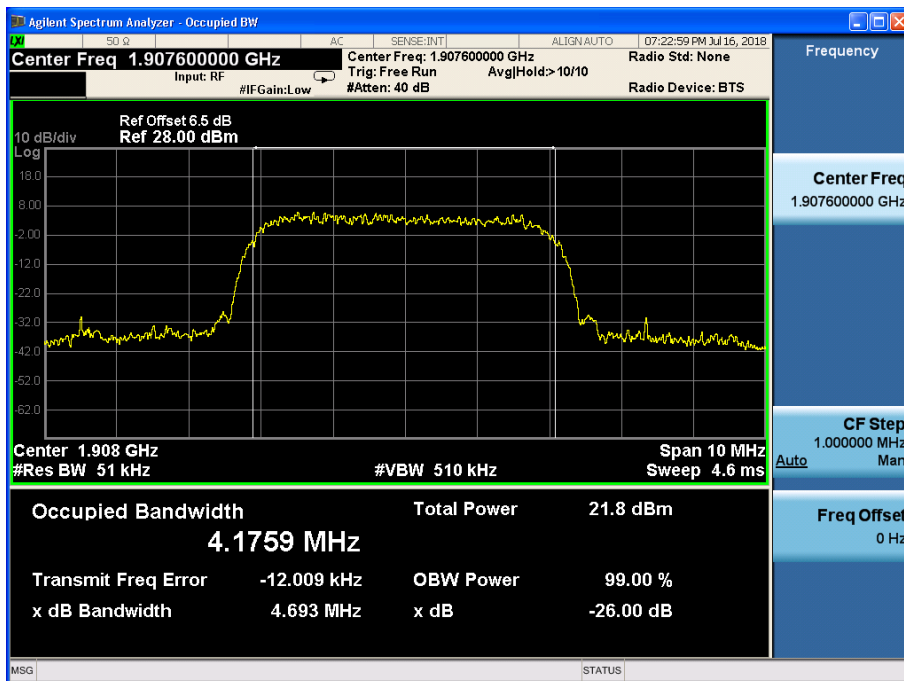

Channel 9538

HSPA+ Mode:

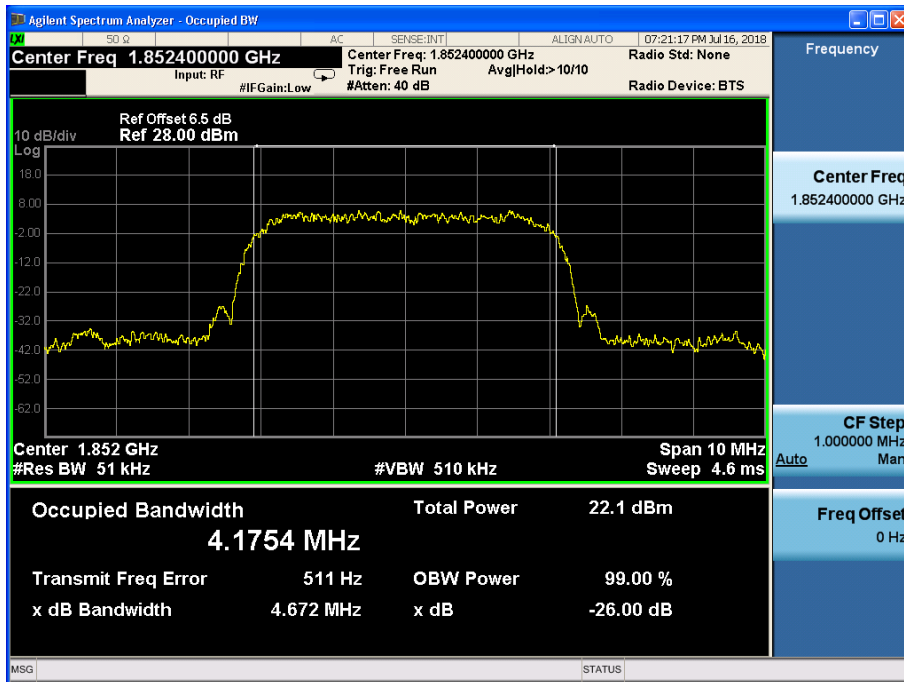

Channel 9262

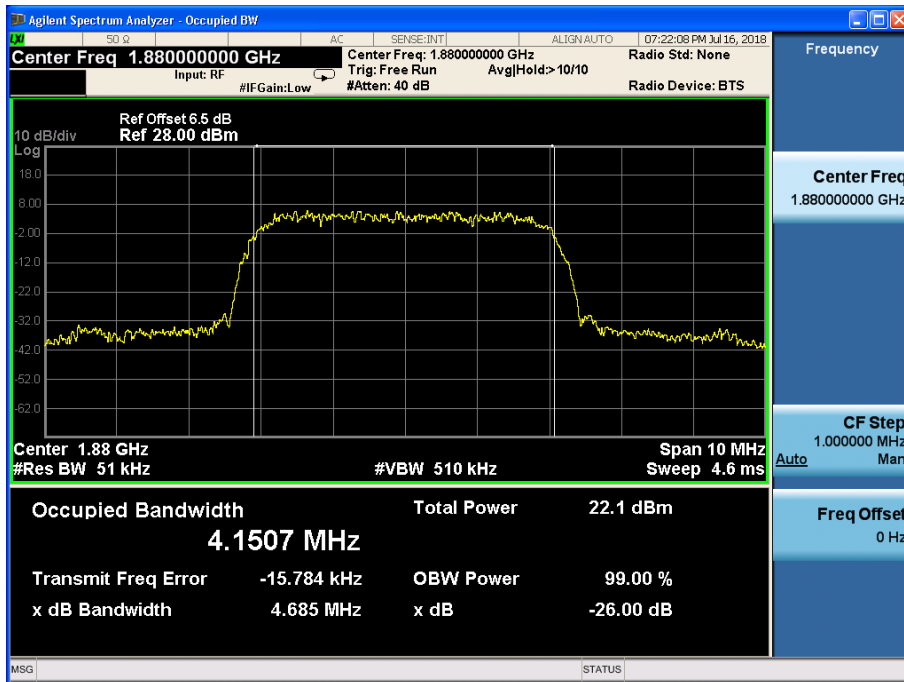

Channel 9400

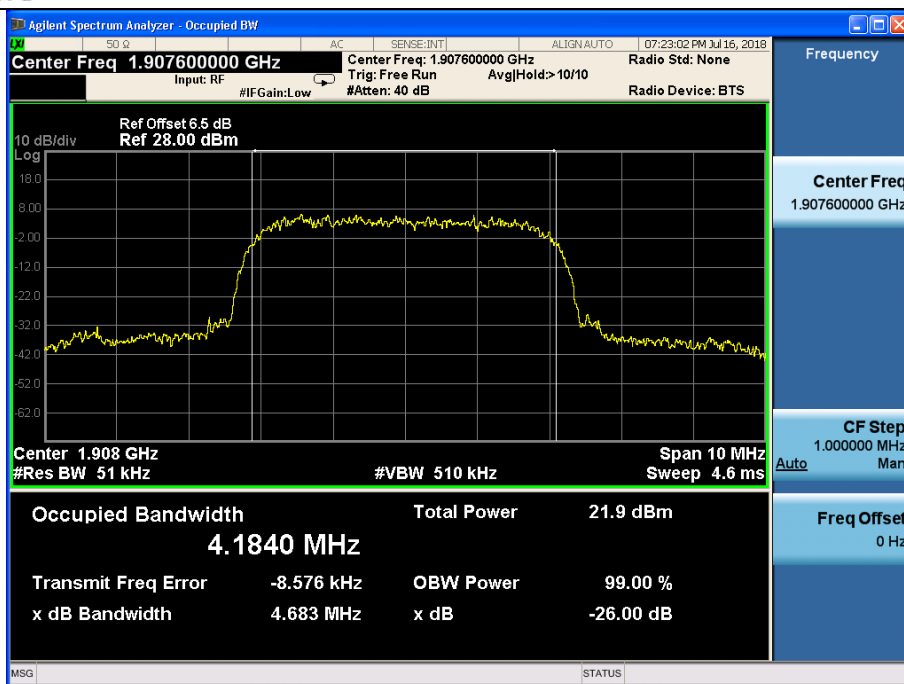

Channel 9538

DC-HSDPA Mode:

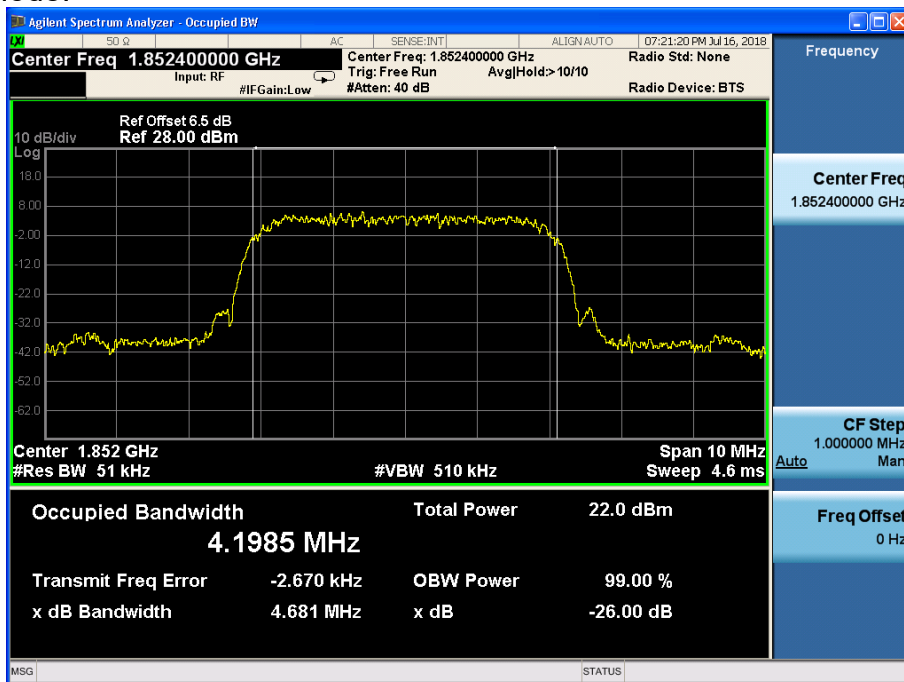

Channel 9262

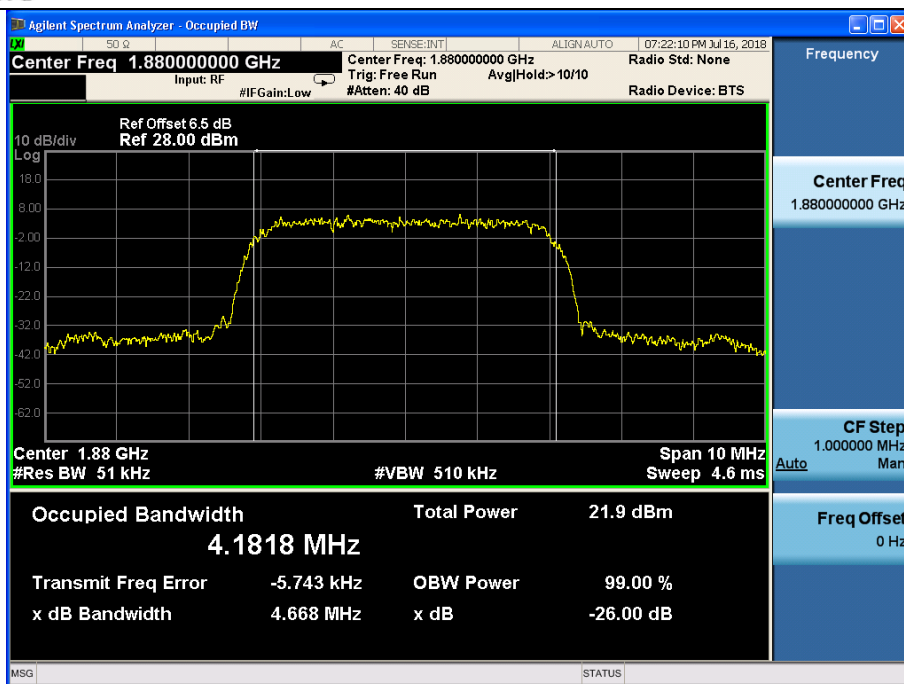

Channel 9400

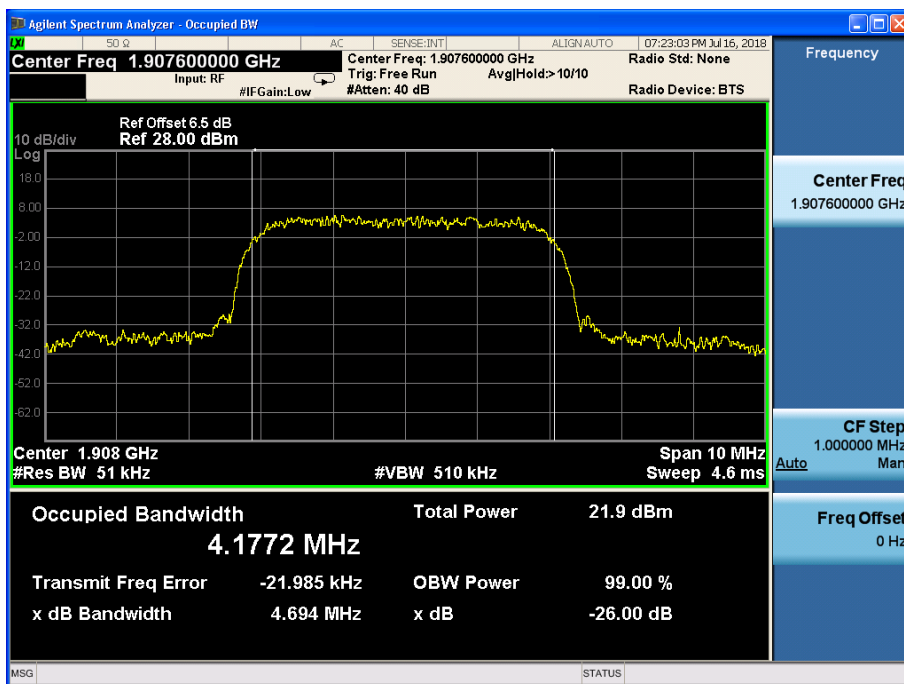

Channel 9538

WCDMA band V

WCDMA Mode:

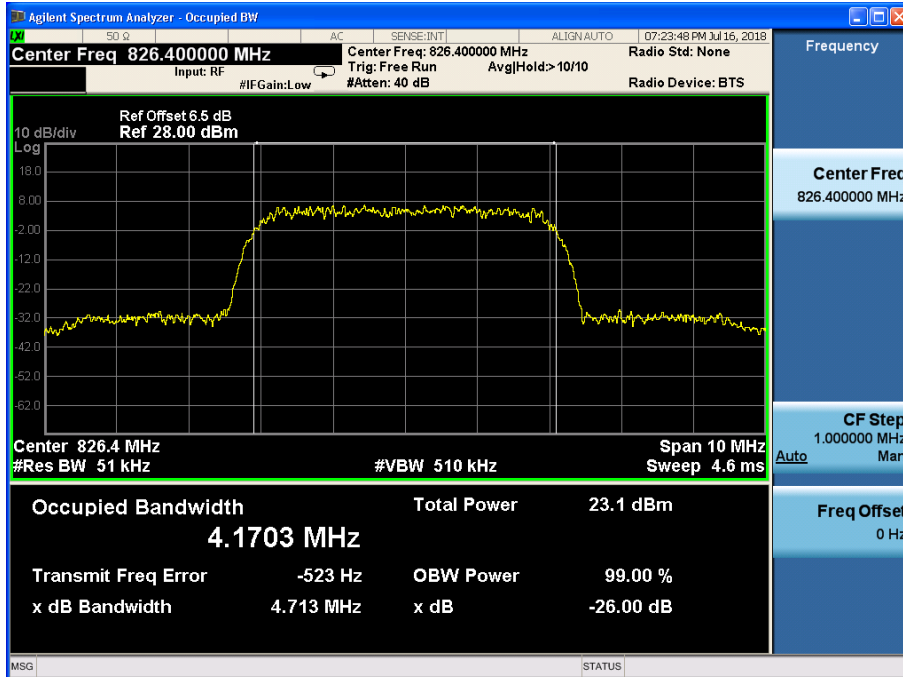

Channel 4132

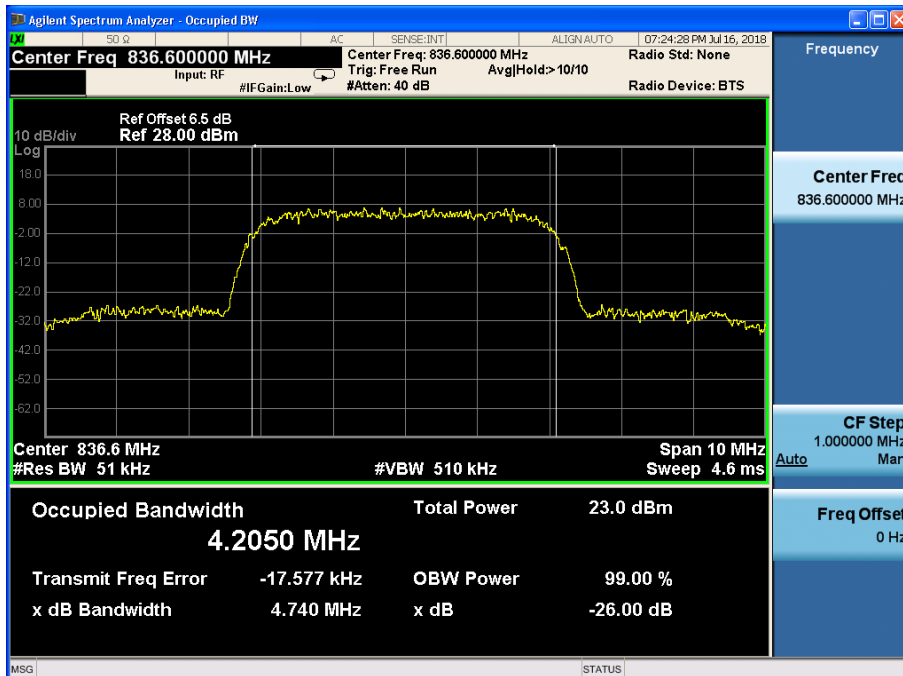

Channel 4183

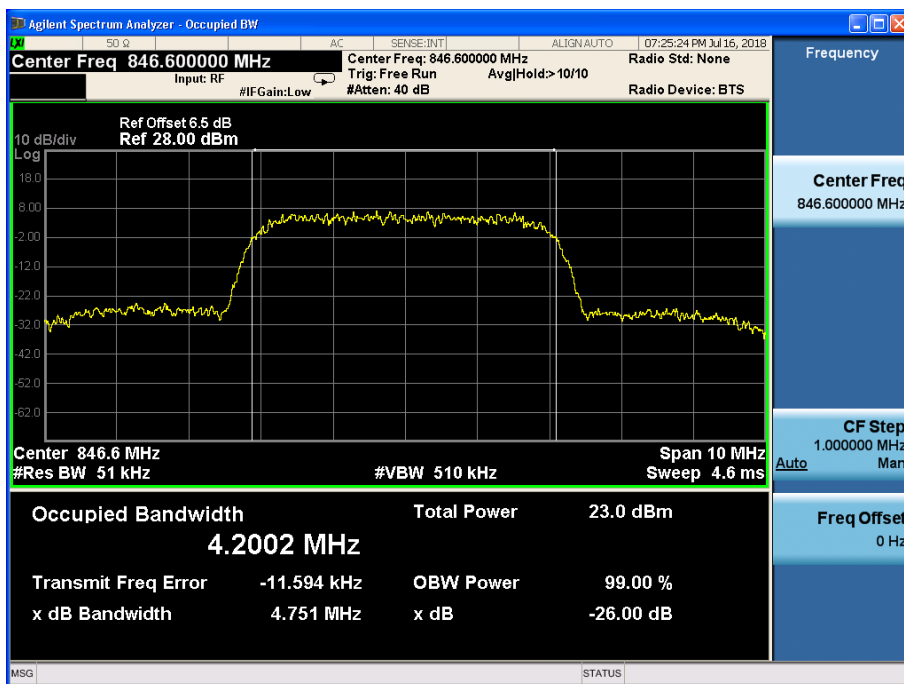

Channel 4233

HSDPA/HSUPA Mode:

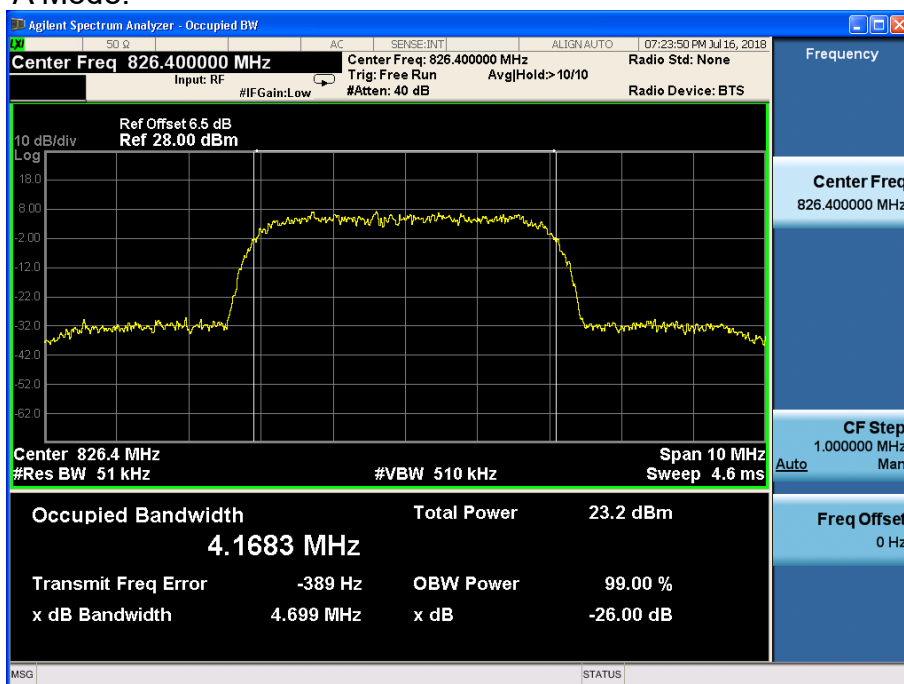

Channel 4132

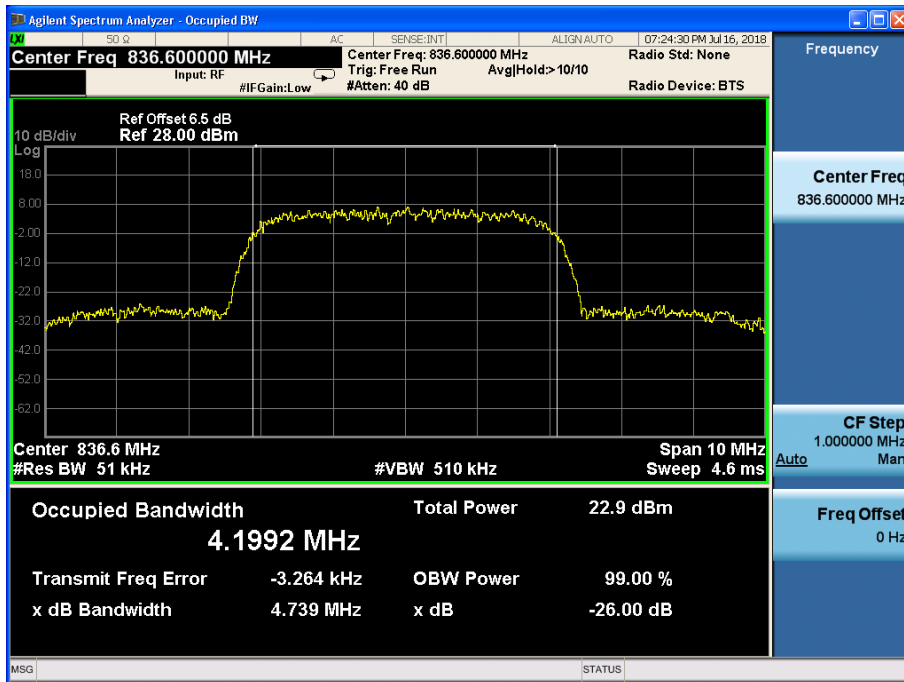

Channel 4183

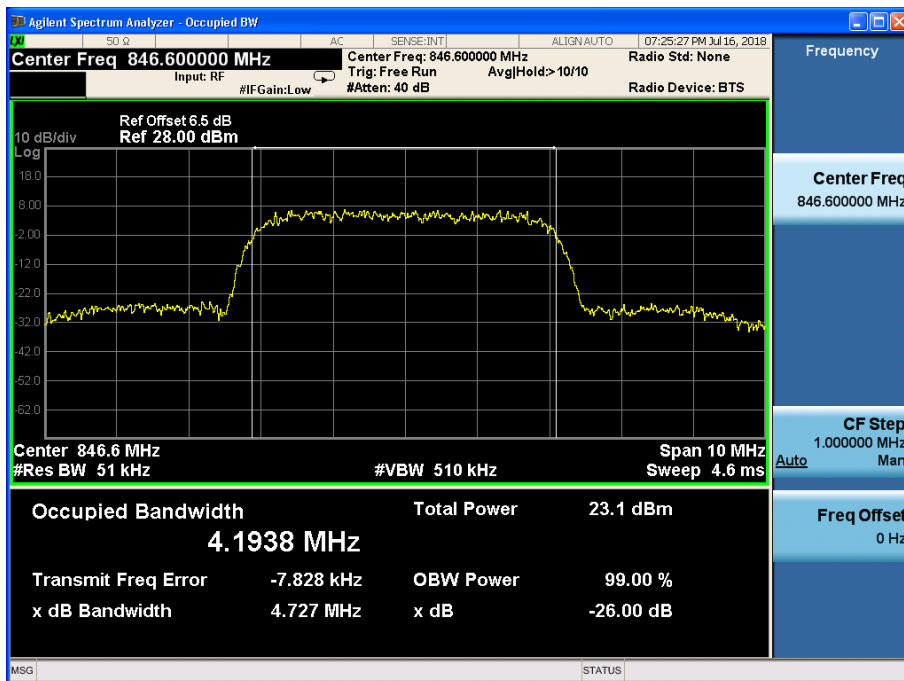

Channel 4233

HSPA+ Mode:

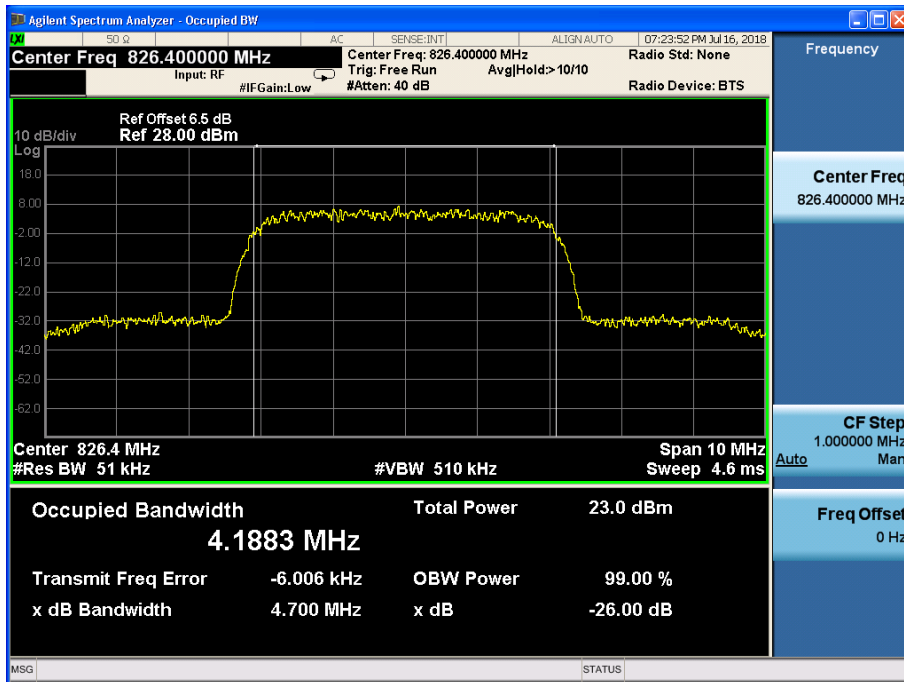

Channel 4132

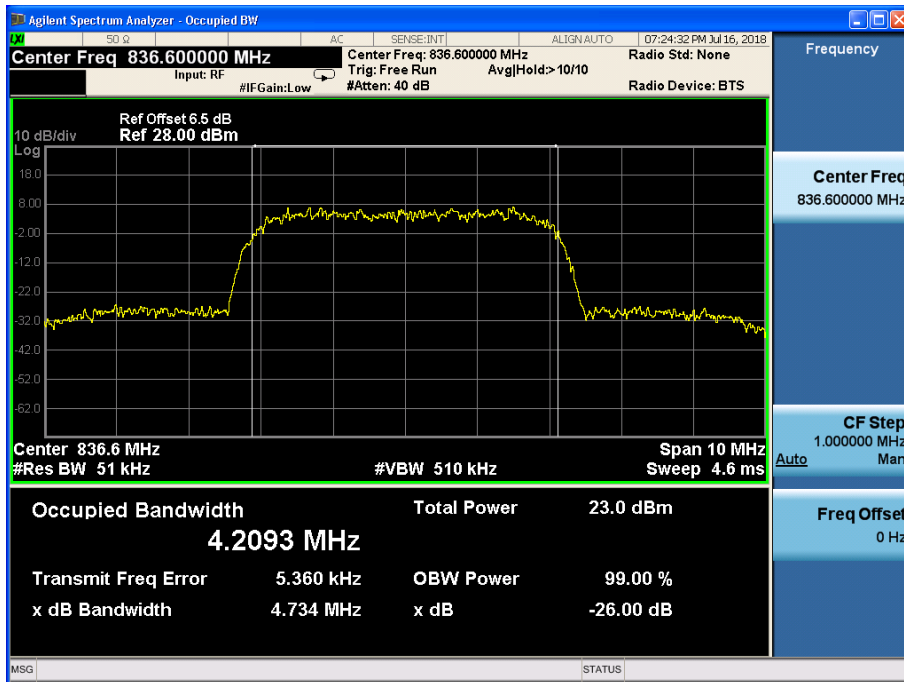

Channel 4183

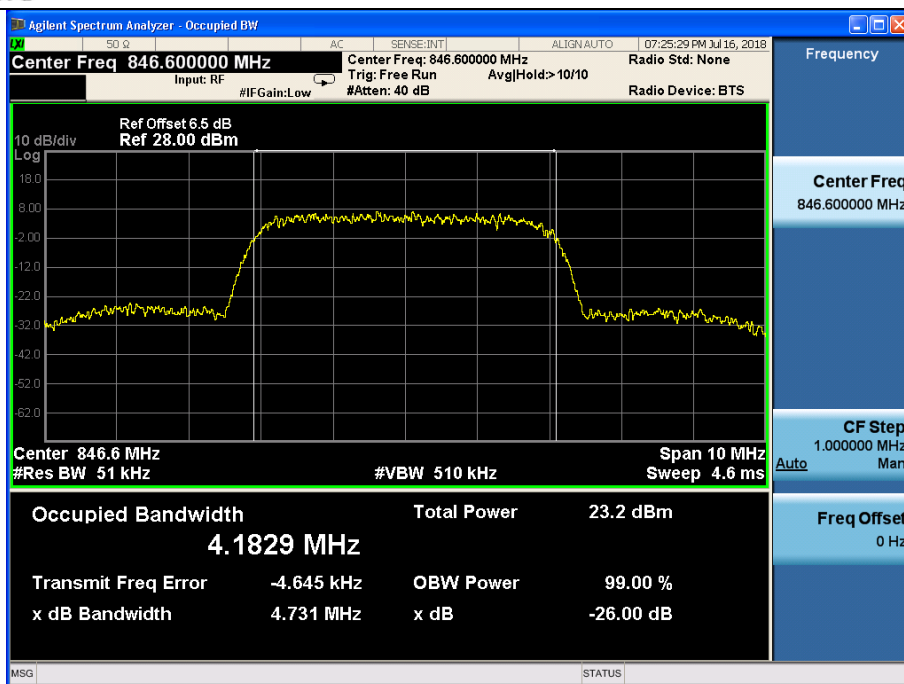

Channel 4233

DC-HSDPA Mode:

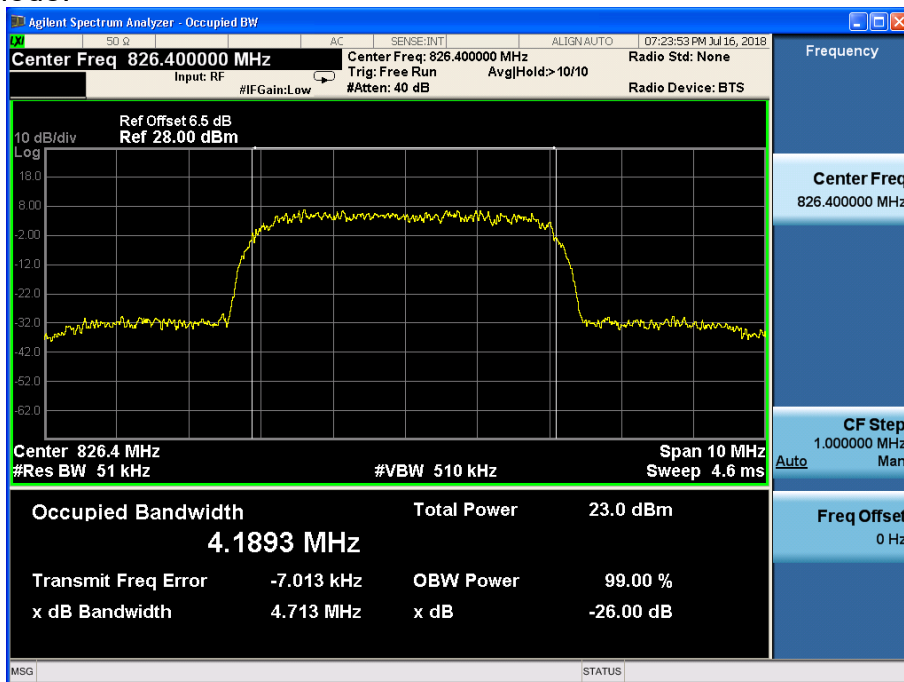

Channel 4132

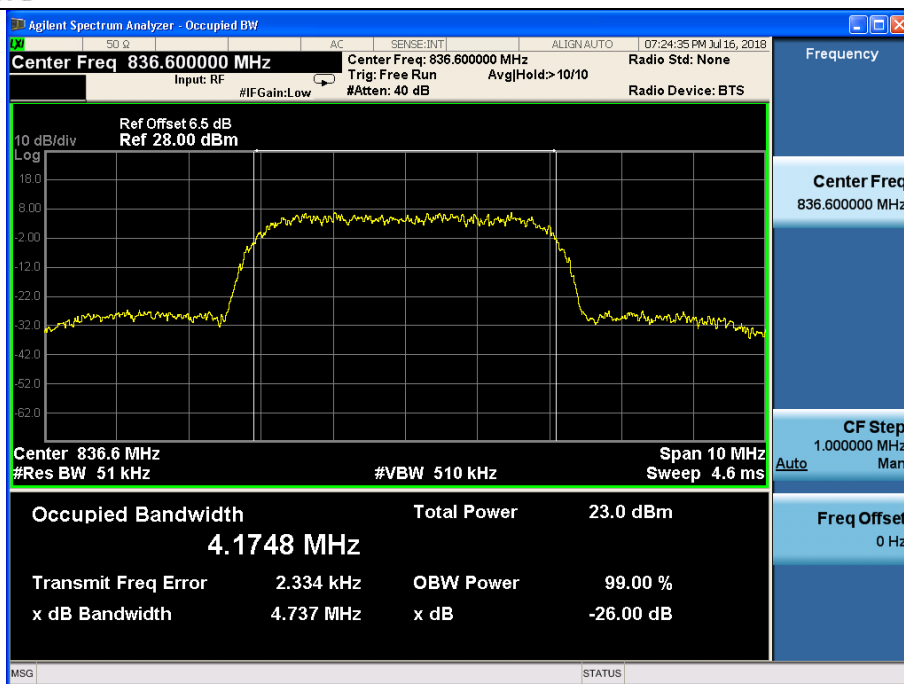

Channel 4183

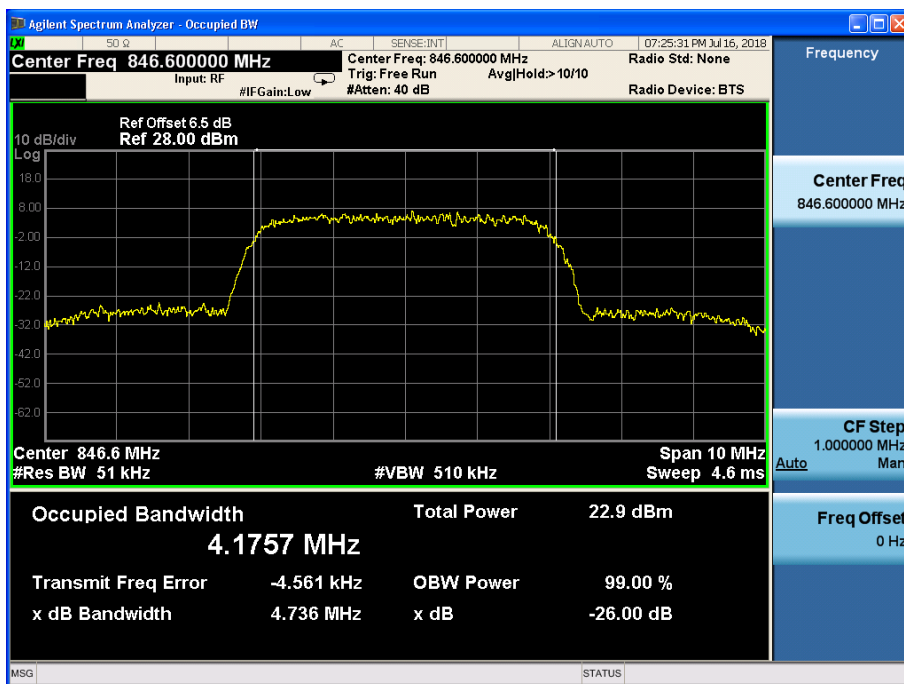

Channel 4233

WCDMA band IV

WCDMA Mode:

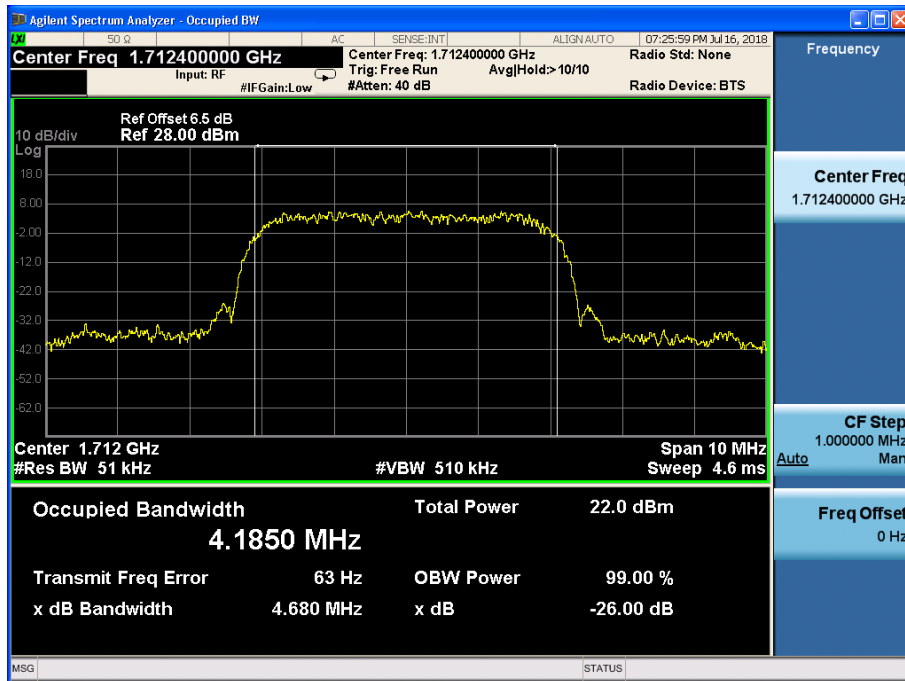

Channel 1312

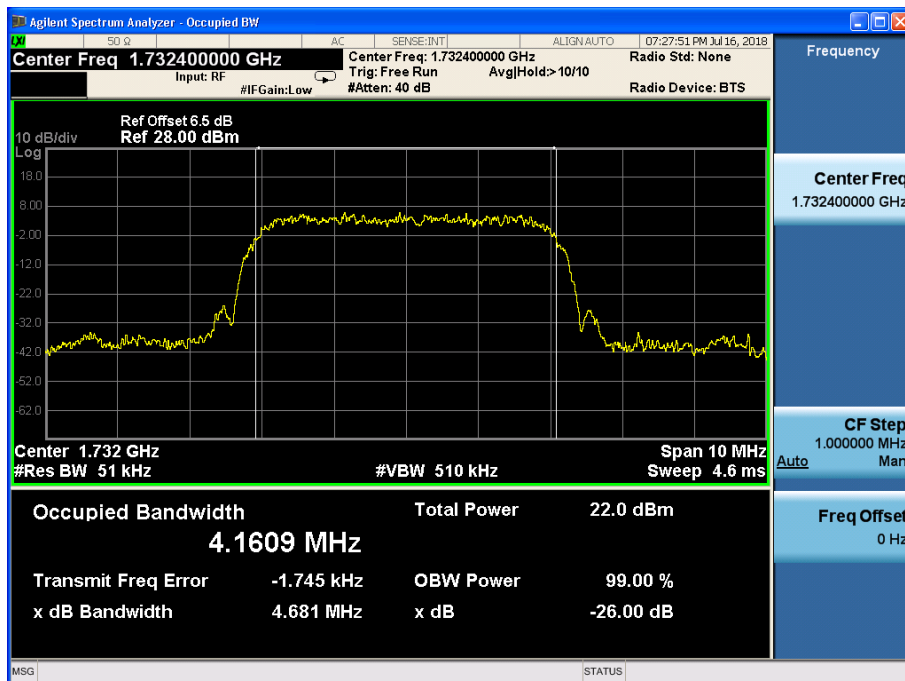

Channel 1412

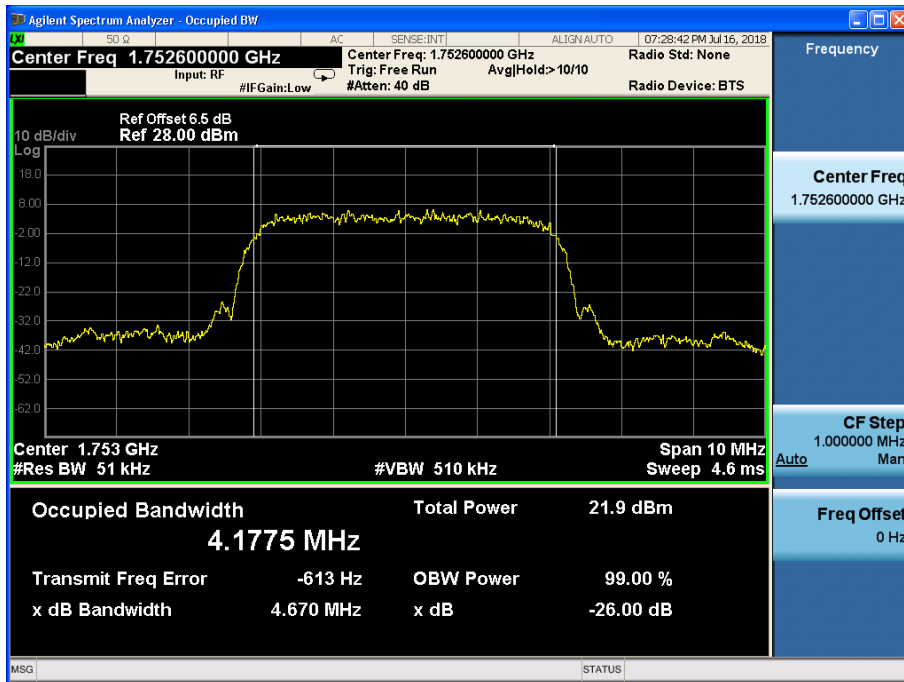

Channel 1513

HSDPA/HSUPA Mode:

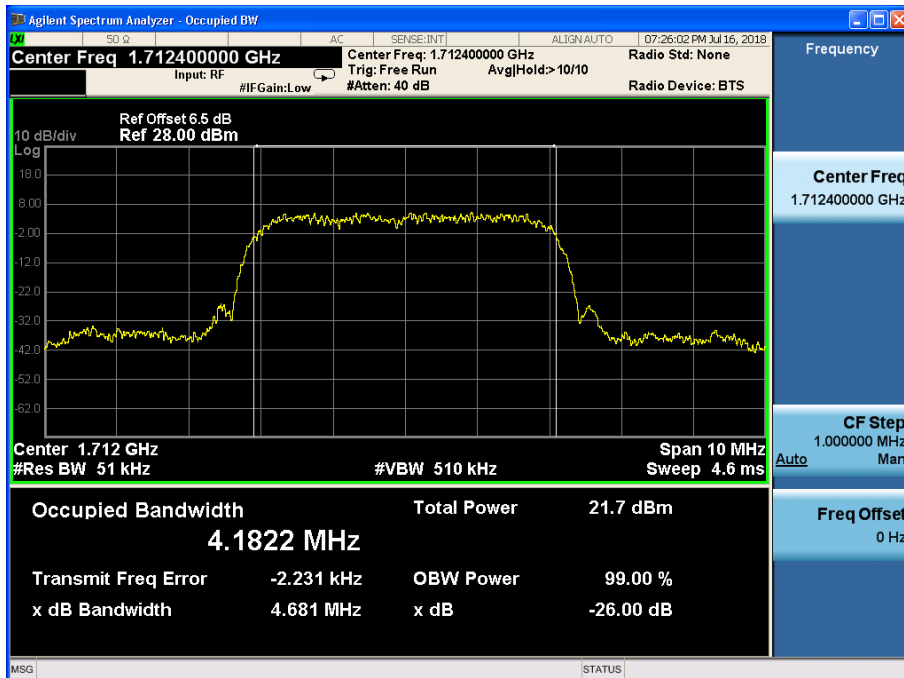

Channel 1312

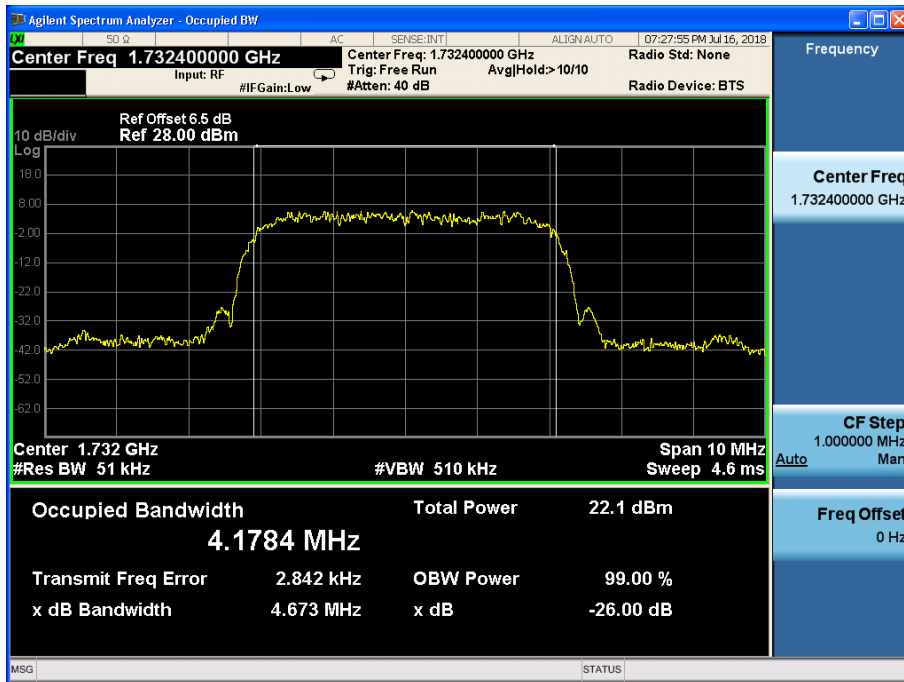

Channel 1412

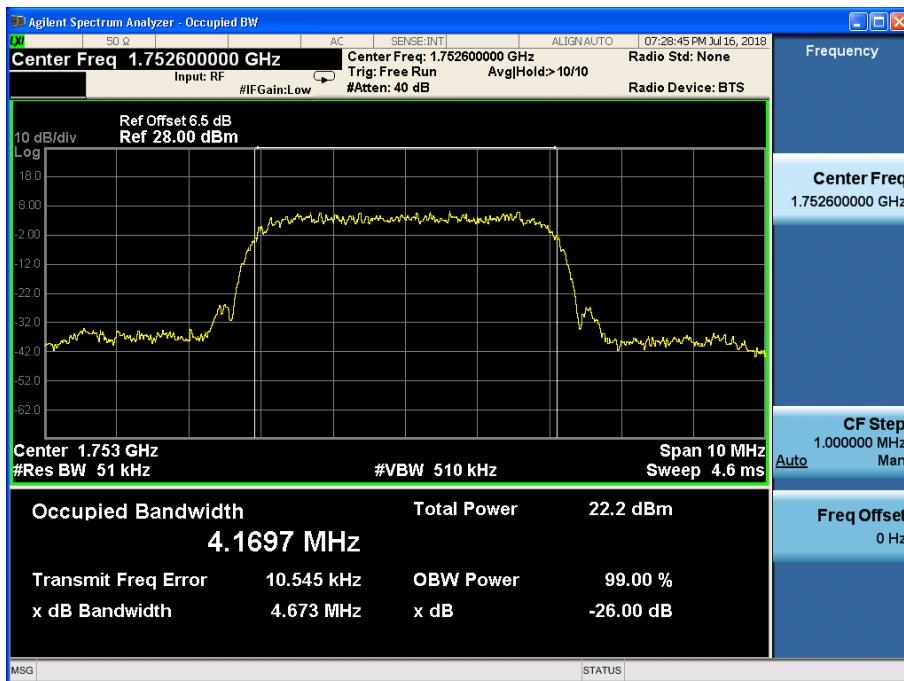

Channel 1513

HSPA+ Mode:

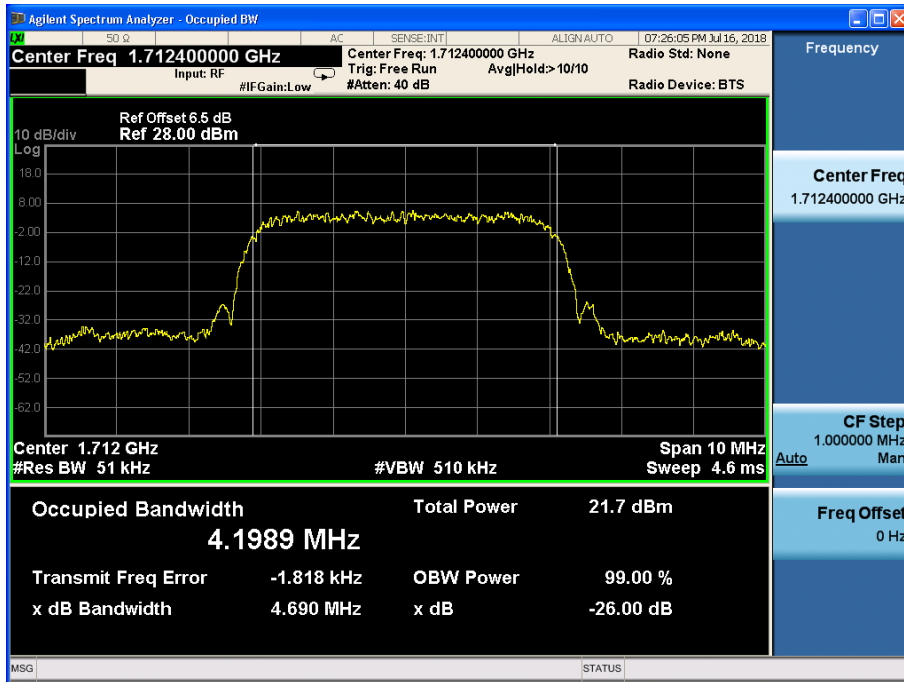

Channel 1312

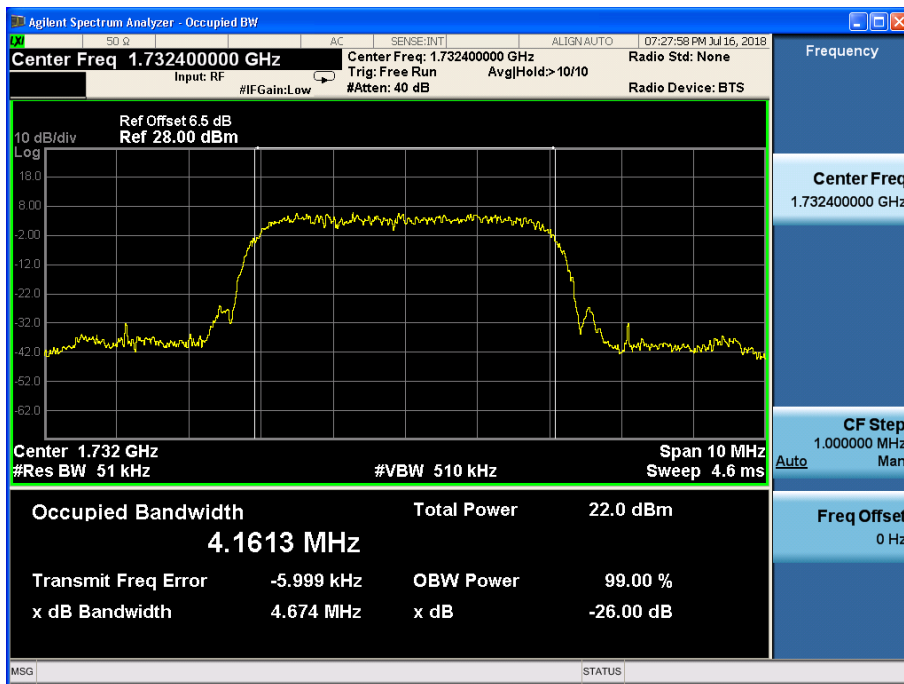

Channel 1412

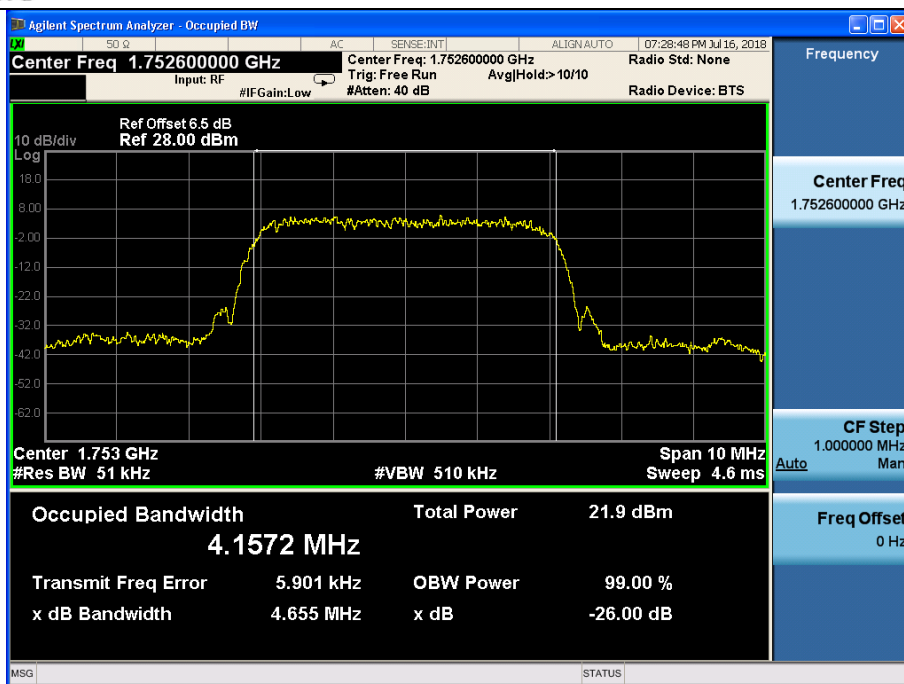

Channel 1513

DC-HSDPA Mode:

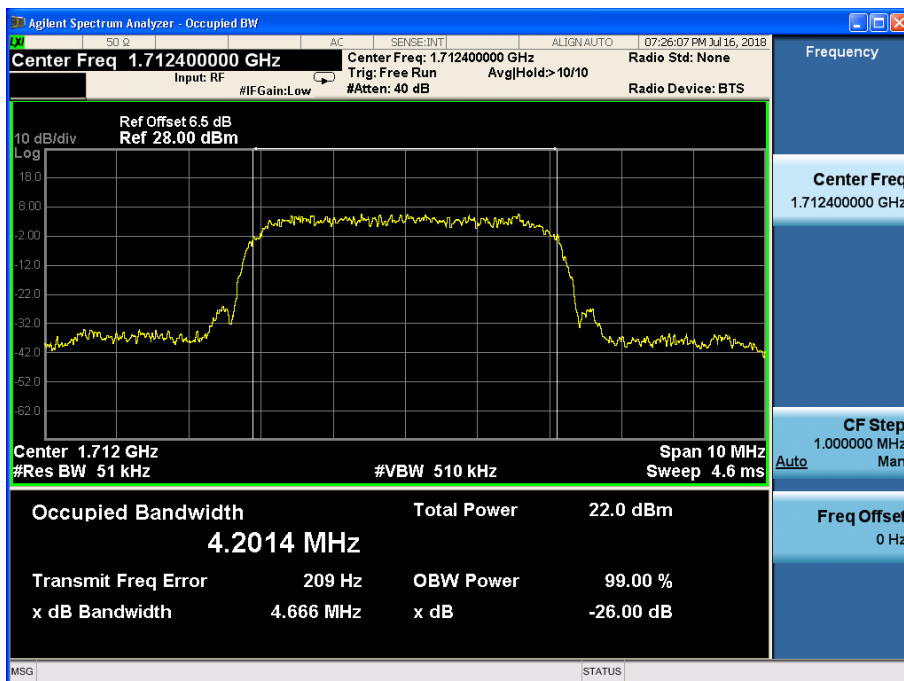

Channel 1312

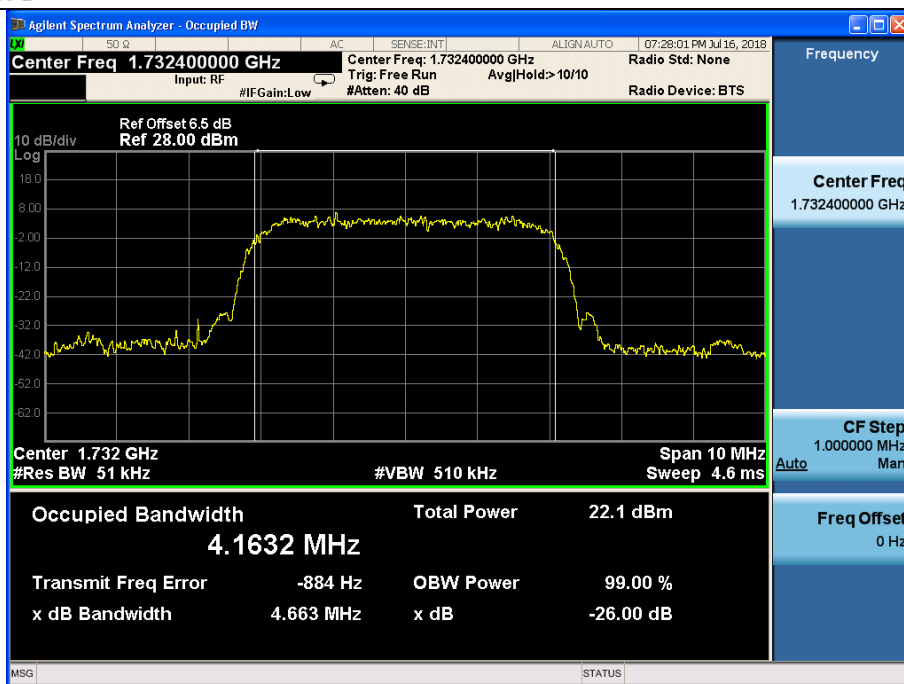

Channel 1412

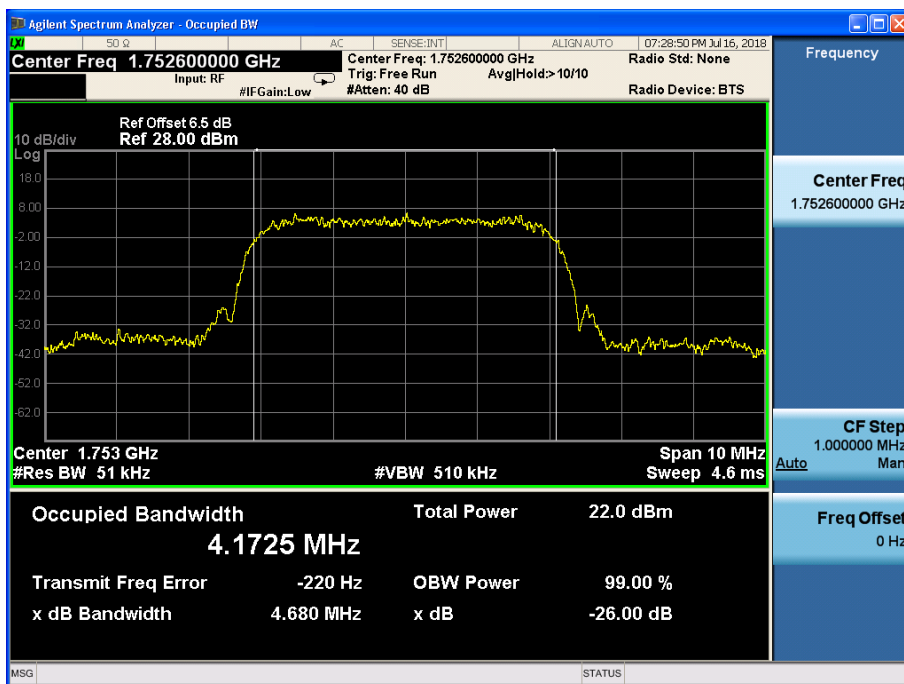

Channel 1513

Emission Bandwidth-FCC 22.917(b)/24.238(b)

WCDMA band II

WCDMA Mode:

Carrier frequency (MHz)	Channel No.	Bandwidth of -26dBc Power (MHz)
1852.4	9262	4.688
1880.0	9400	4.714
1907.6	9538	4.695

HSDPA/HSUPA Mode:

Carrier frequency (MHz)	Channel No.	Bandwidth of -26dBc Power (MHz)
1852.4	9262	4.671
1880.0	9400	4.703
1907.6	9538	4.693

HSPA+ Mode:

Carrier frequency (MHz)	Channel No.	Bandwidth of -26dBc Power (MHz)
1852.4	9262	4.672
1880.0	9400	4.685
1907.6	9538	4.683

DC-HSDPA Mode:

Carrier frequency (MHz)	Channel No.	Bandwidth of -26dBc Power (MHz)
1852.4	9262	4.681
1880.0	9400	4.668
1907.6	9538	4.694

WCDMA band V

WCDMA Mode:

Carrier frequency (MHz)	Channel No.	Bandwidth of -26dBc Power (MHz)
826.4	4132	4.713
836.6	4183	4.740
846.6	4233	4.751

HSDPA/HSUPA Mode:

Carrier frequency (MHz)	Channel No.	Bandwidth of -26dBc Power (MHz)
826.4	4132	4.699
836.6	4183	4.739
846.6	4233	4.727

HSPA+ Mode:

Carrier frequency (MHz)	Channel No.	Bandwidth of -26dBc Power (MHz)
826.4	4132	4.700
836.6	4183	4.734
846.6	4233	4.731

DC-HSDPA Mode:

Carrier frequency (MHz)	Channel No.	Bandwidth of -26dBc Power (MHz)
826.4	4132	4.713
836.6	4183	4.737
846.6	4233	4.736

WCDMA band IV

WCDMA Mode:

Carrier frequency (MHz)	Channel No.	Bandwidth of -26dBc Power (MHz)
1712.4	1312	4.680
1732.4	1412	4.681
1752.6	1513	4.670

HSDPA/HSUPA Mode:

Carrier frequency (MHz)	Channel No.	Bandwidth of -26dBc Power (MHz)
1712.4	1312	4.681
1732.4	1412	4.673
1752.6	1513	4.673

HSPA+ Mode:

Carrier frequency (MHz)	Channel No.	Bandwidth of -26dBc Power (MHz)
1712.4	1312	4.690
1732.4	1412	4.674
1752.6	1513	4.655

DC-HSDPA Mode:

Carrier frequency (MHz)	Channel No.	Bandwidth of -26dBc Power (MHz)
1712.4	1312	4.666
1732.4	1412	4.663
1752.6	1513	4.680

Spurious Emissions at antenna terminal-FCC Part2.1051/ 22.917(a)/24.238(a)/ 27.53(h)
WCDMA band II

WCDMA Mode:

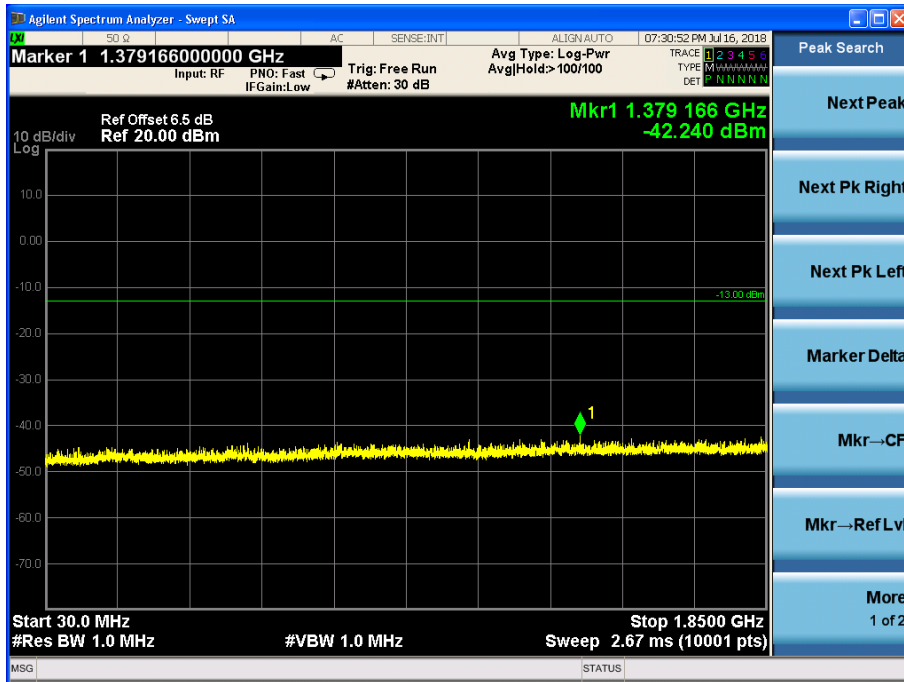

Channel 9400, 30MHz~1850MHz

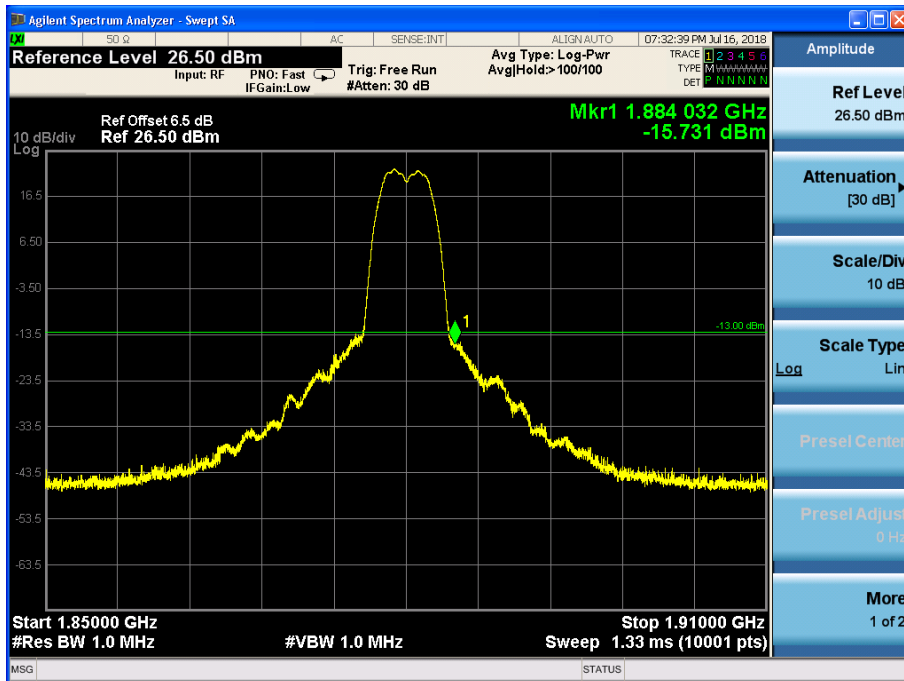

Channel 9400, 1850MHz~1910MHz

Note: The signal beyond the limit is the signal transmitted by EUT.

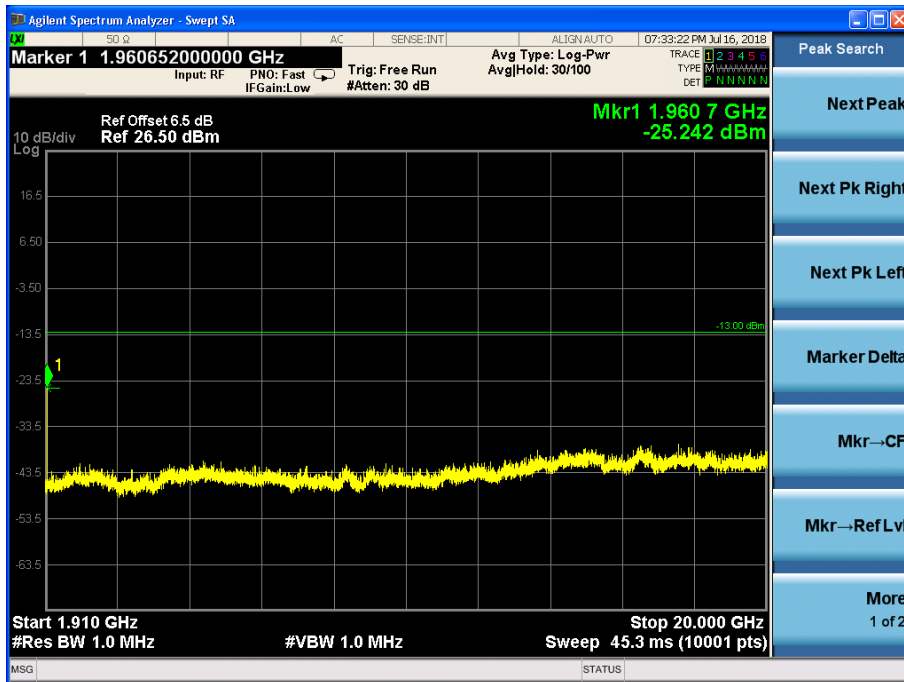

Channel 9400, 1910MHz~20GHz

HSDPA/HSUPA Mode:

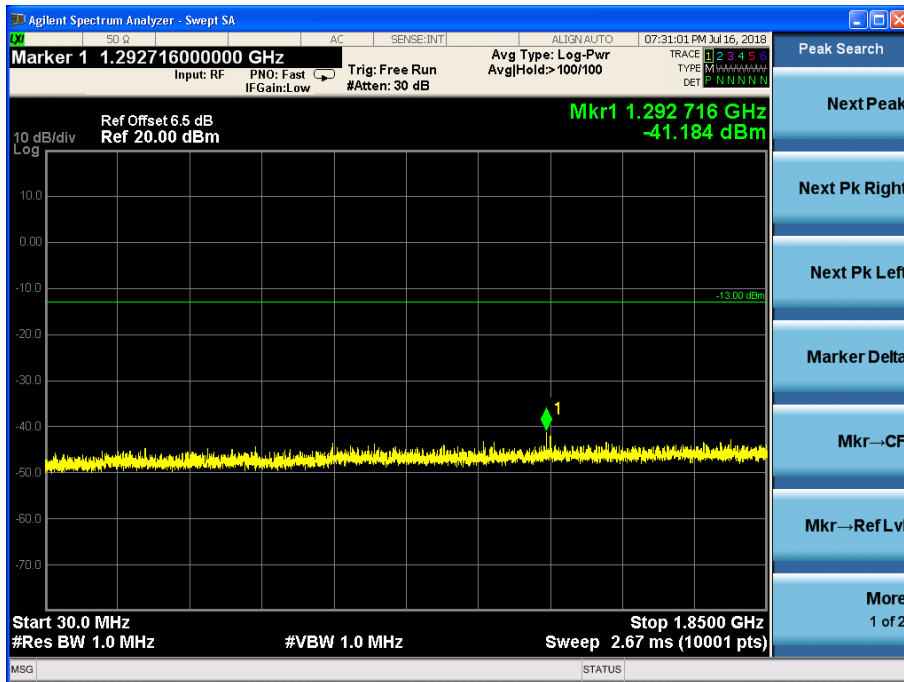

Channel 9400, 30MHz~1850MHz

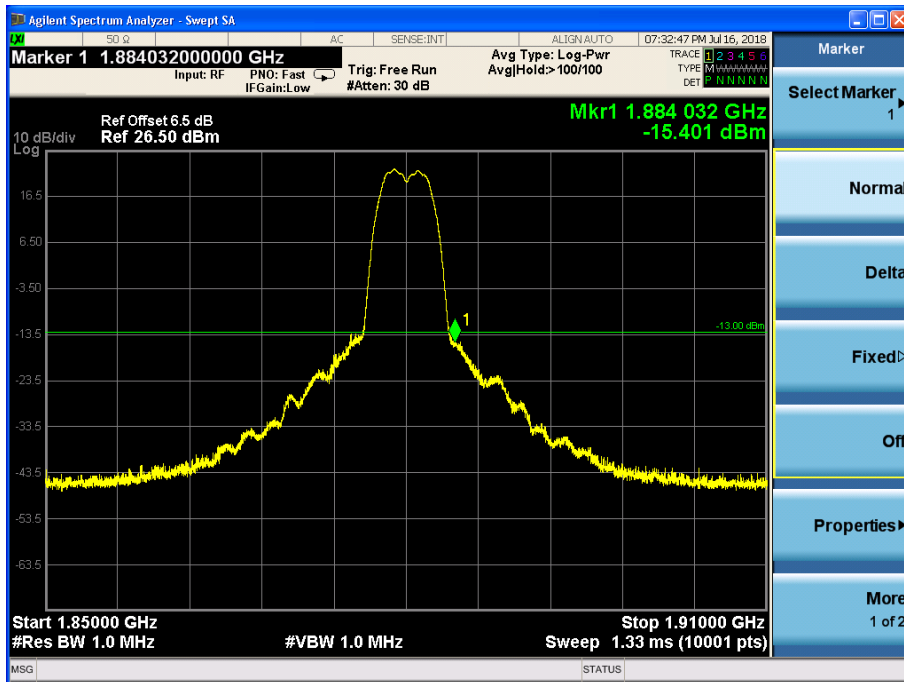

Channel 9400, 1850MHz~1910MHz

Note: The signal beyond the limit is the signal transmitted by EUT.

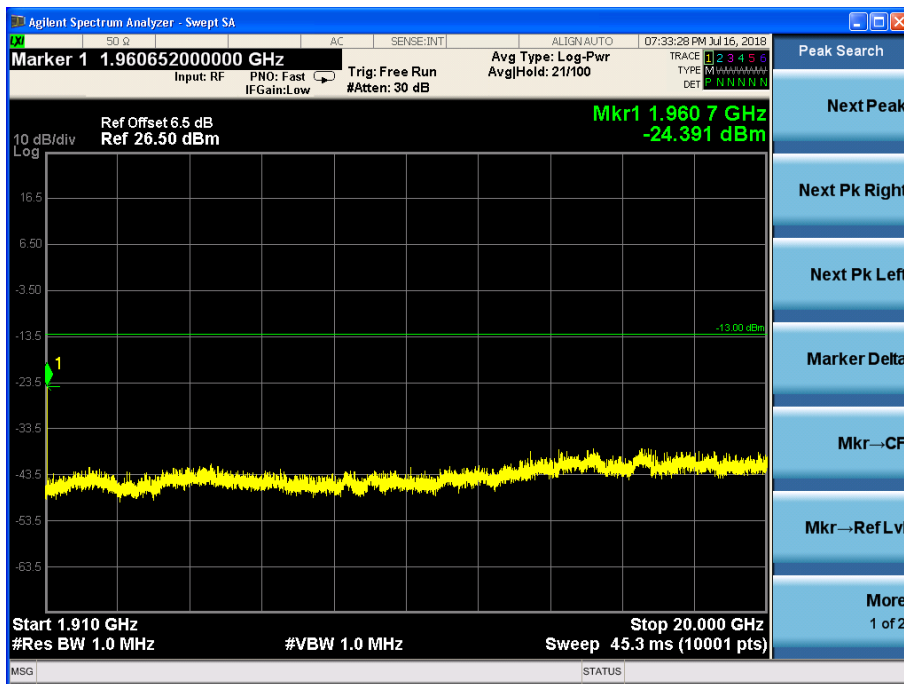

Channel 9400, 1910MHz~20GHz

HSPA+ Mode:

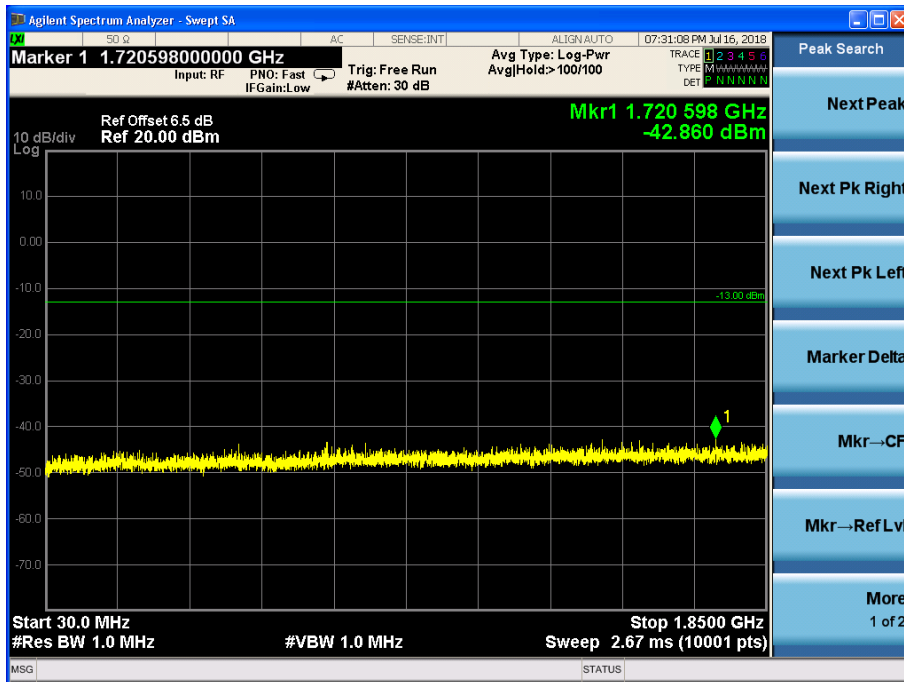

Channel 9400, 30MHz~1850MHz

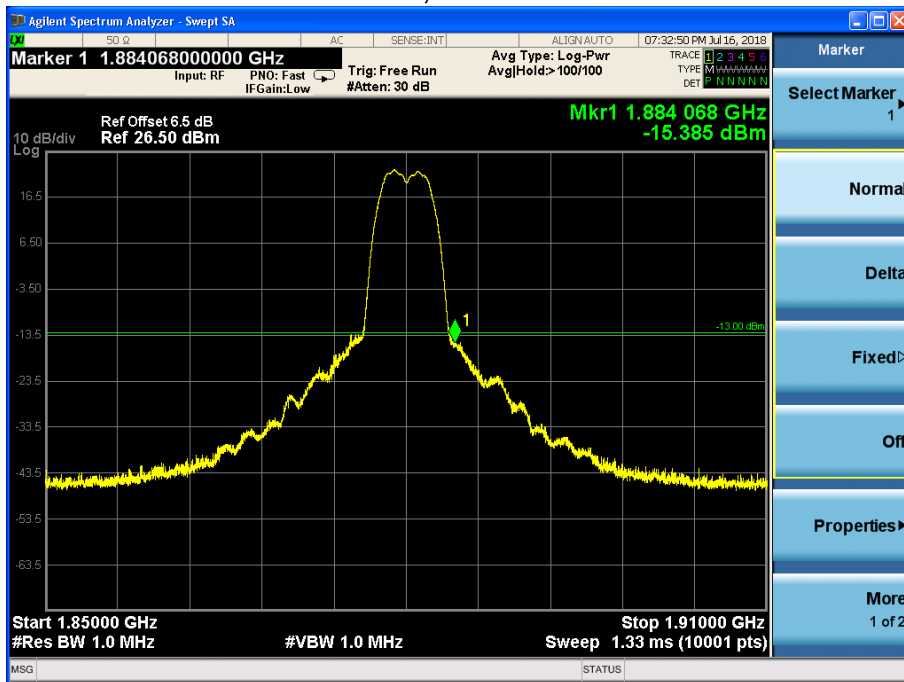

Channel 9400, 1850MHz~1910MHz

Note: The signal beyond the limit is the signal transmitted by EUT.

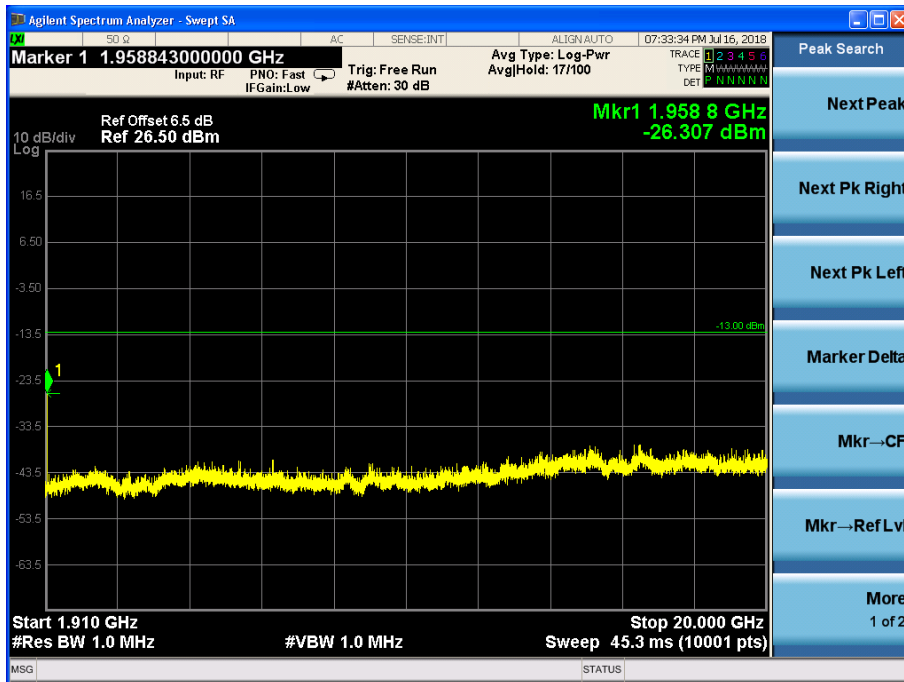

Channel 9400, 1910MHz~20GHz

DC-HSDPA Mode:

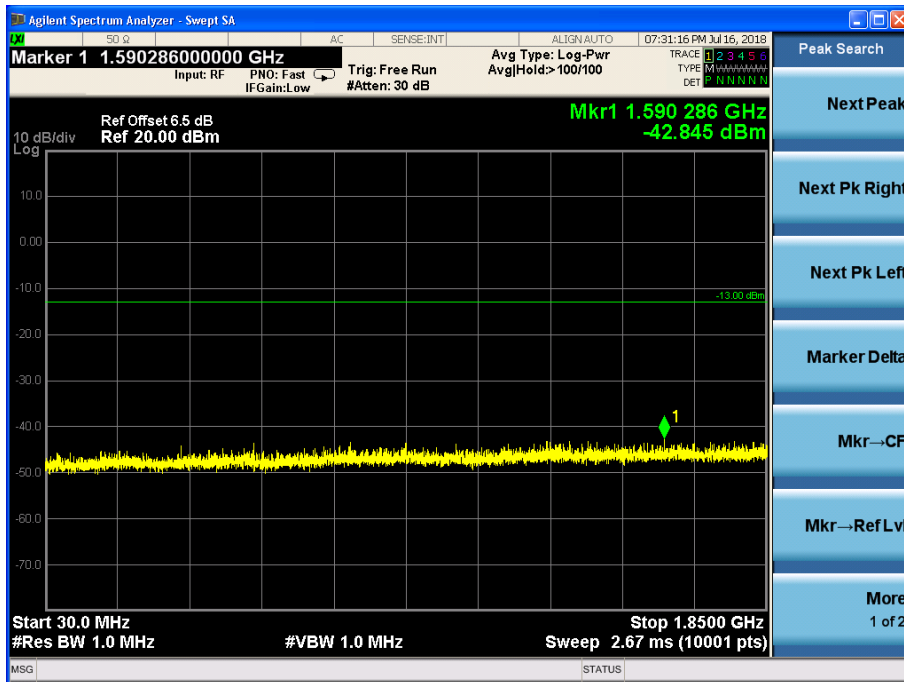

Channel 9400, 30MHz~1850MHz

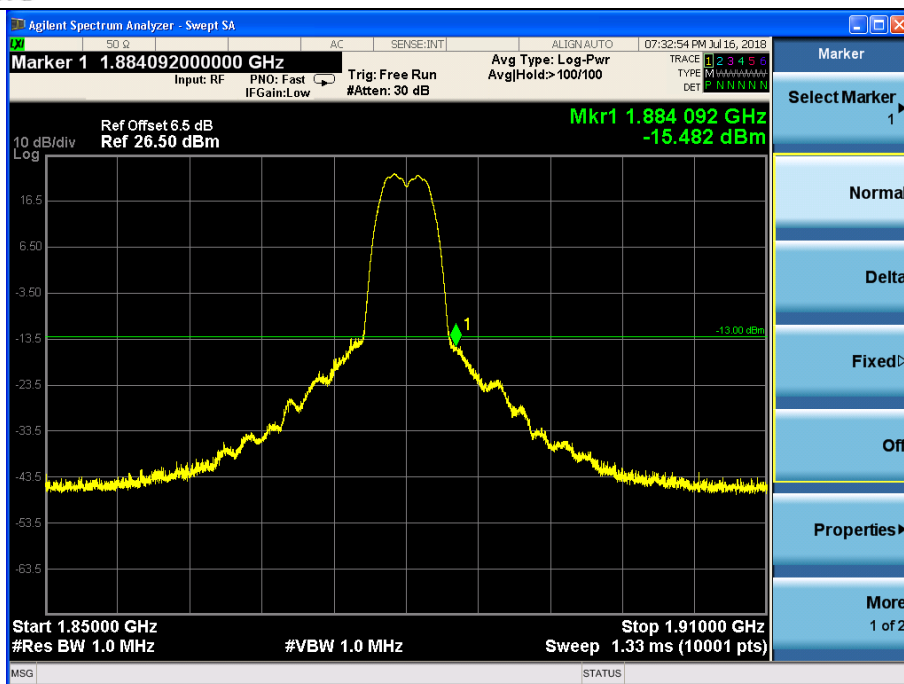

Channel 9400, 1850MHz~1910MHz

Note: The signal beyond the limit is the signal transmitted by EUT.

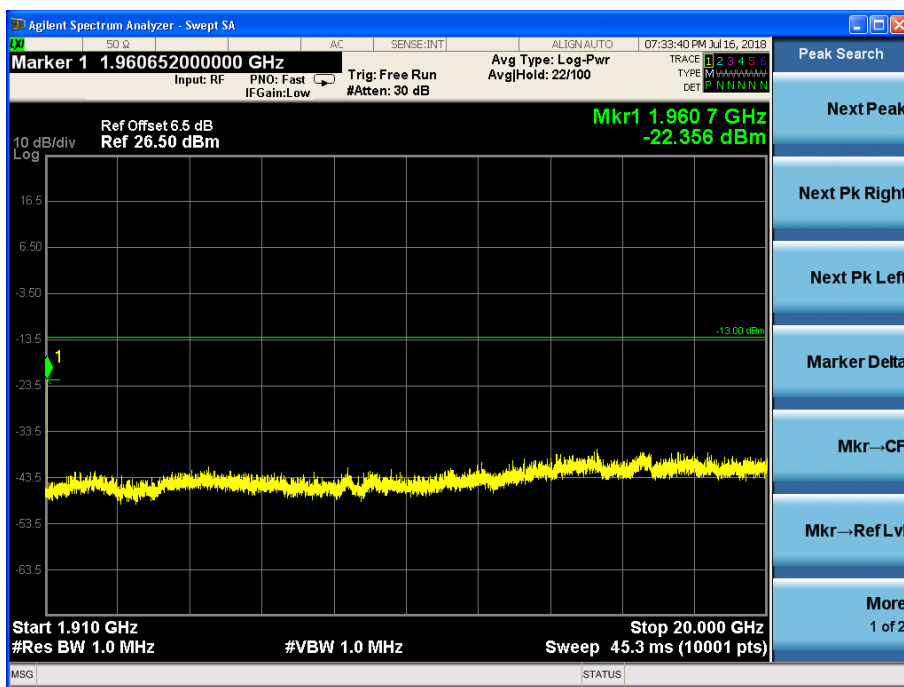

Channel 9400, 1910MHz~20GHz

WCDMA band V

WCDMA Mode:

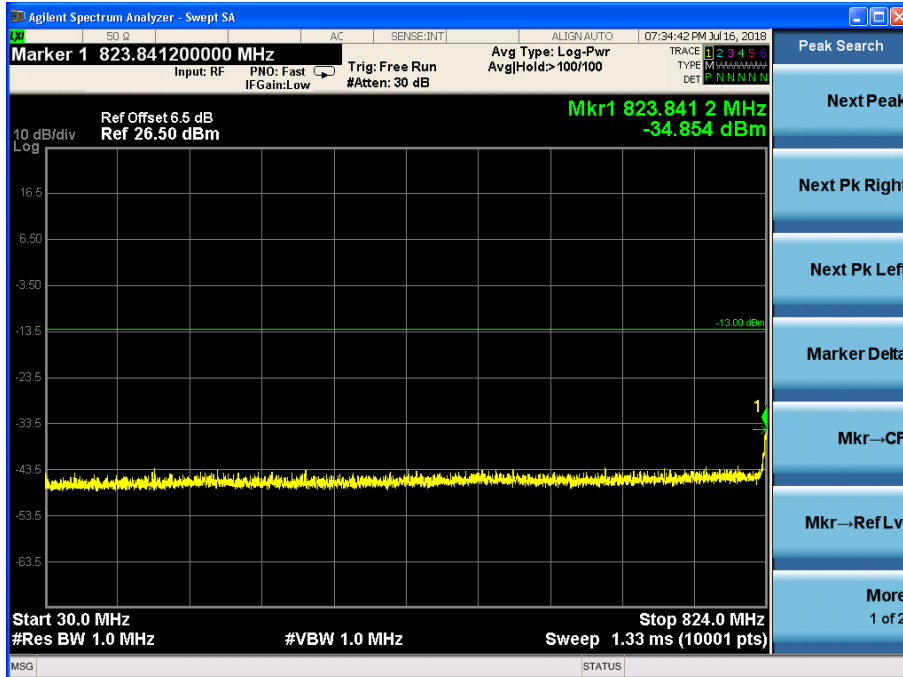

Channel 4183, 30MHz~824MHz

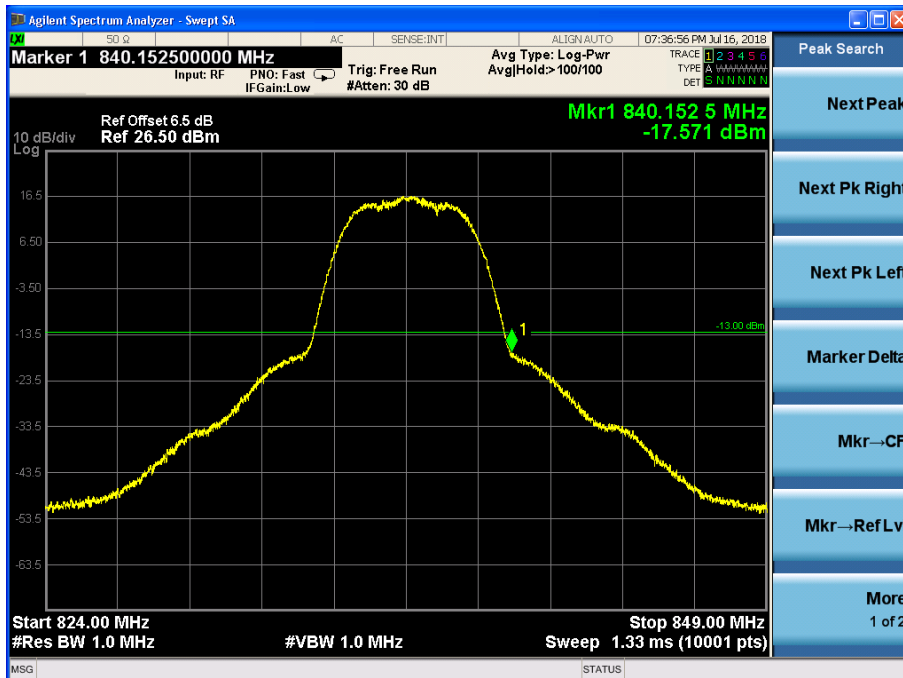

Channel 4183, 824MHz~849MHz

Note: The signal beyond the limit is the signal transmitted by EUT.

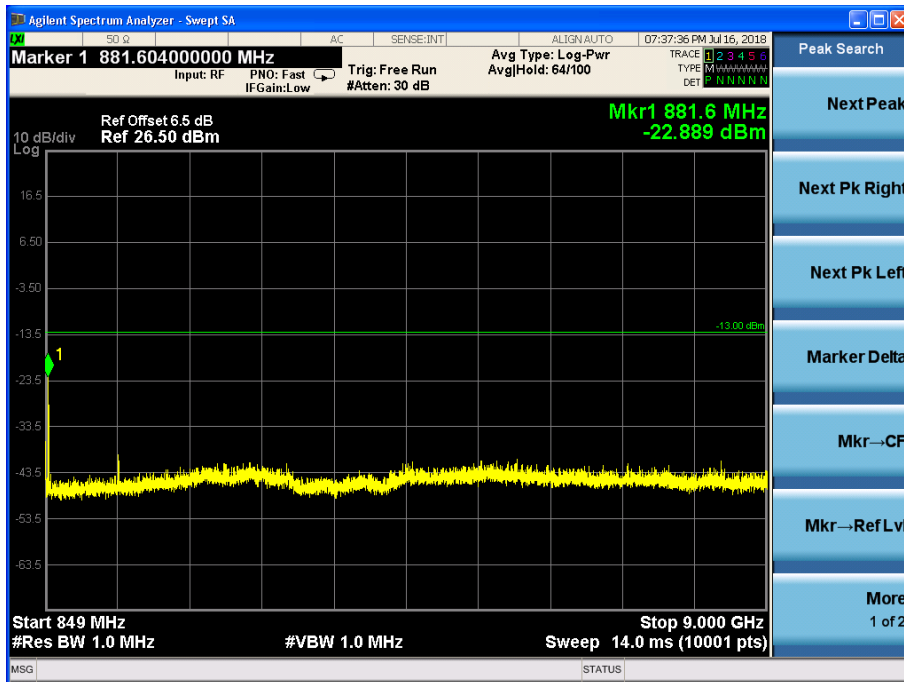

Channel 4183, 849MHz~9GHz

HSDPA/HSUPA Mode:

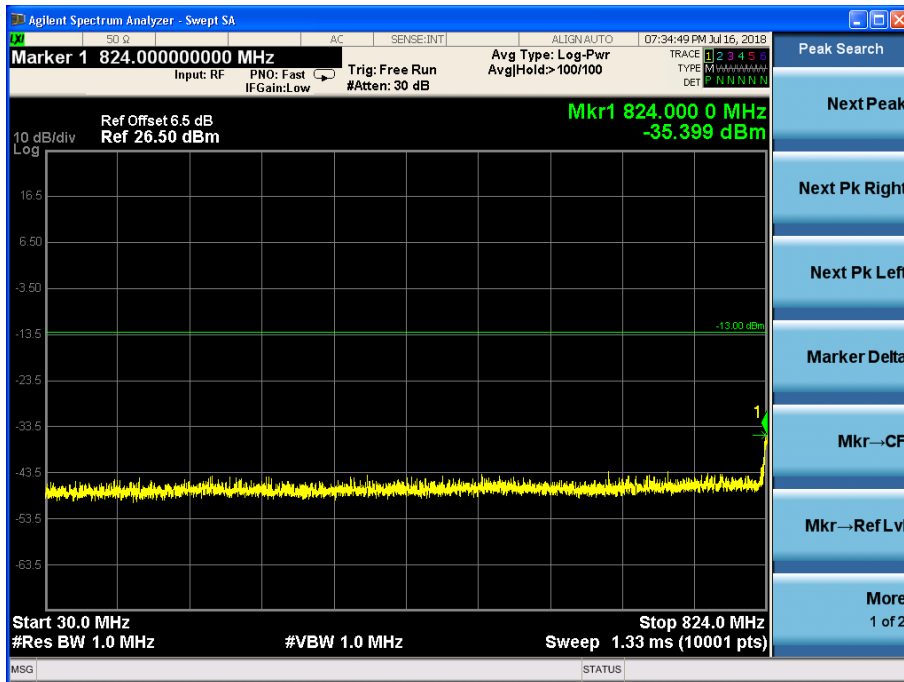

Channel 4183, 30MHz~824MHz

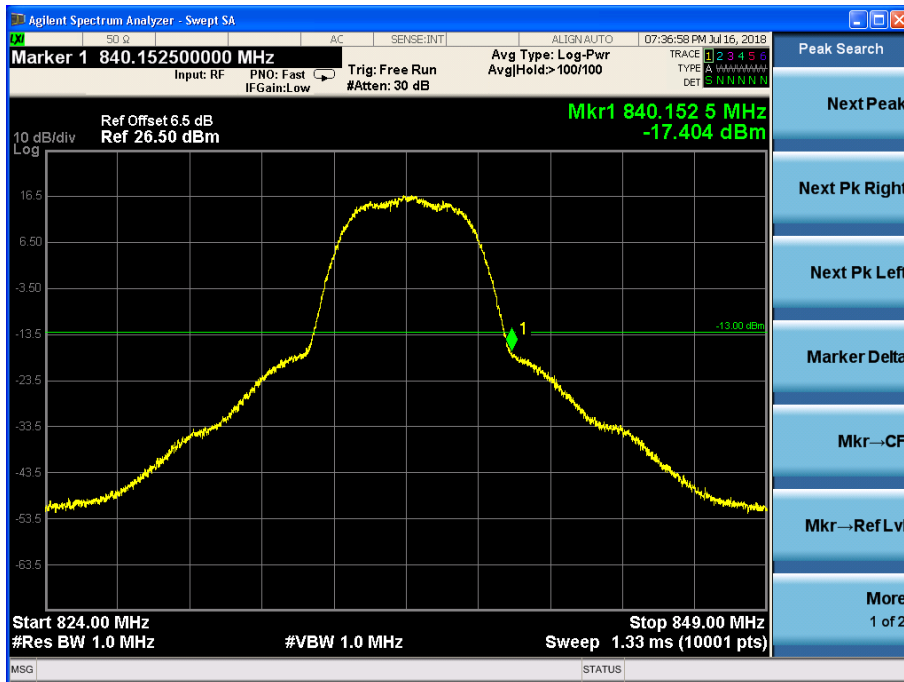

Channel 4183, 824MHz~849MHz

Note: The signal beyond the limit is the signal transmitted by EUT.

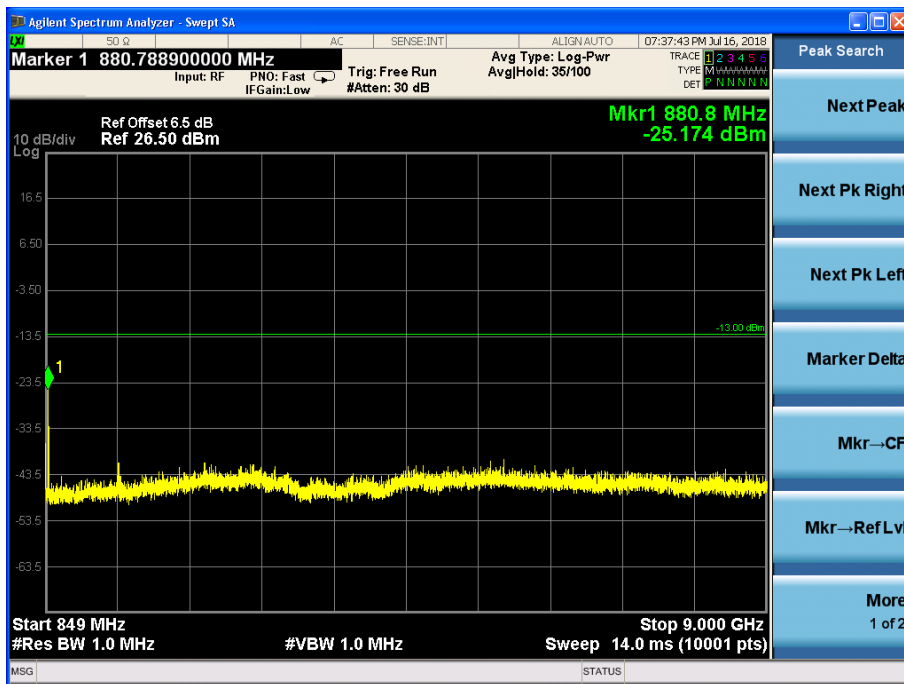

Channel 4183, 849MHz~9GHz

HSPA+ Mode:

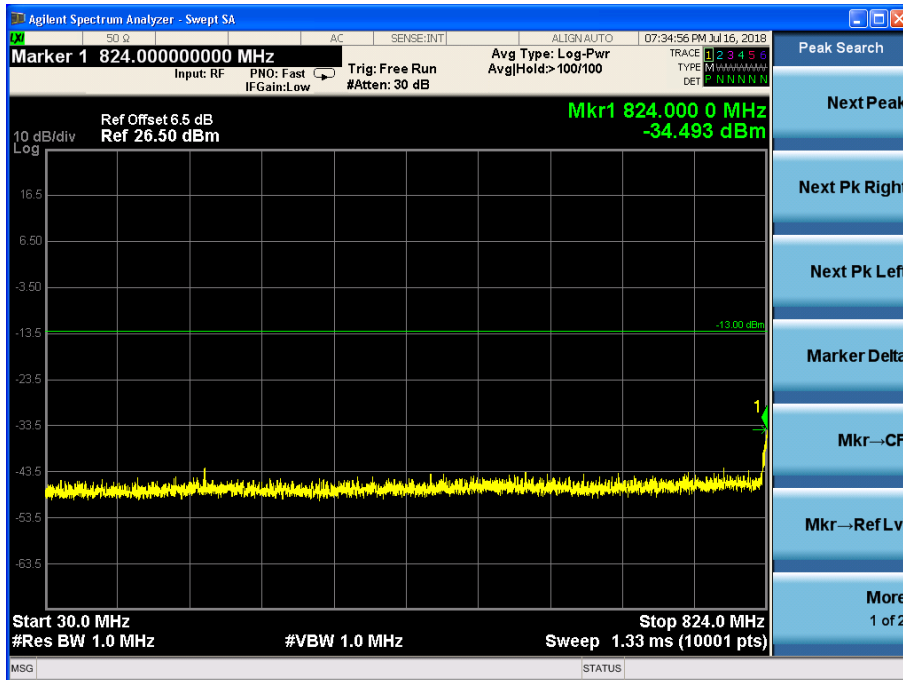

Channel 4183, 30MHz~824MHz

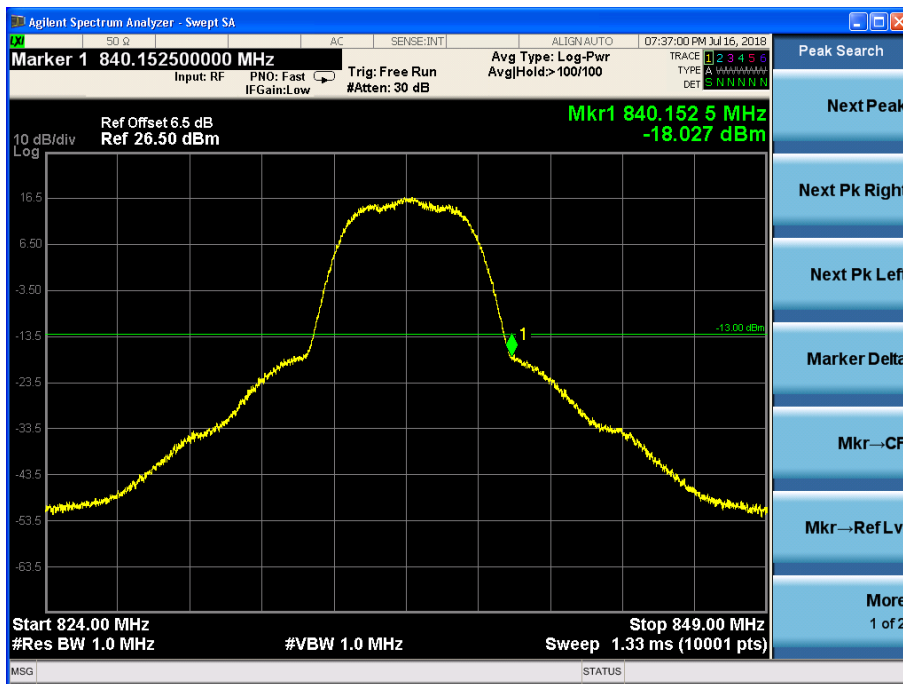

Channel 4183, 824MHz~849MHz

Note: The signal beyond the limit is the signal transmitted by EUT.

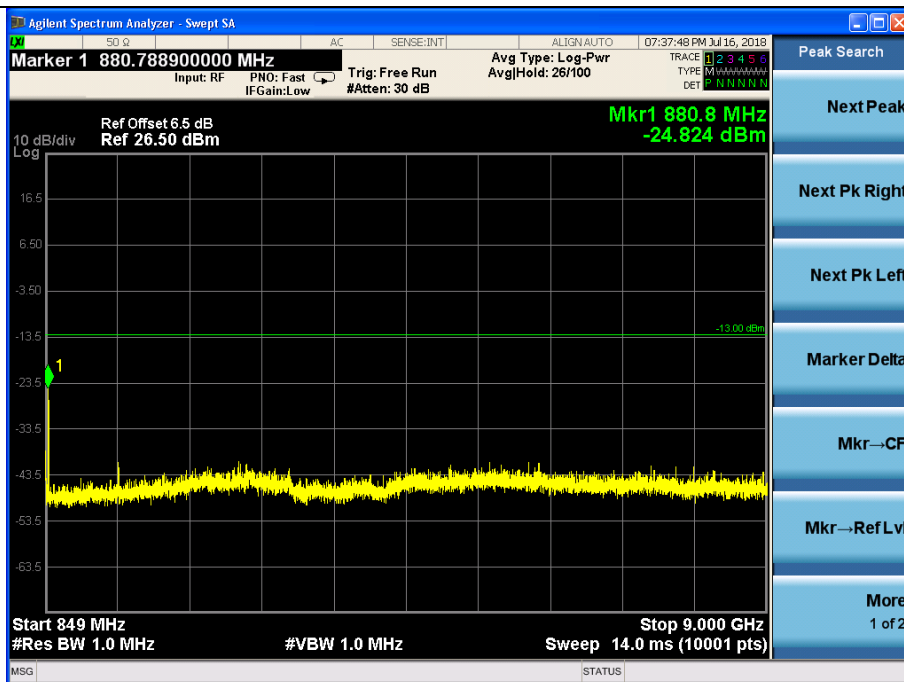

Channel 4183, 849MHz~9GHz

DC-HSDPA Mode:

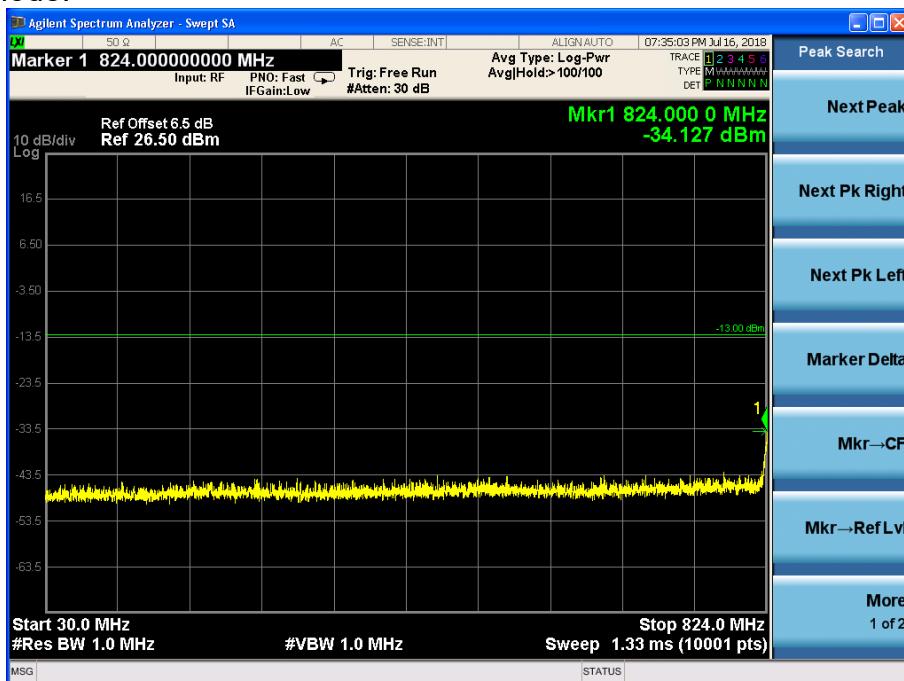

Channel 4183, 30MHz~824MHz

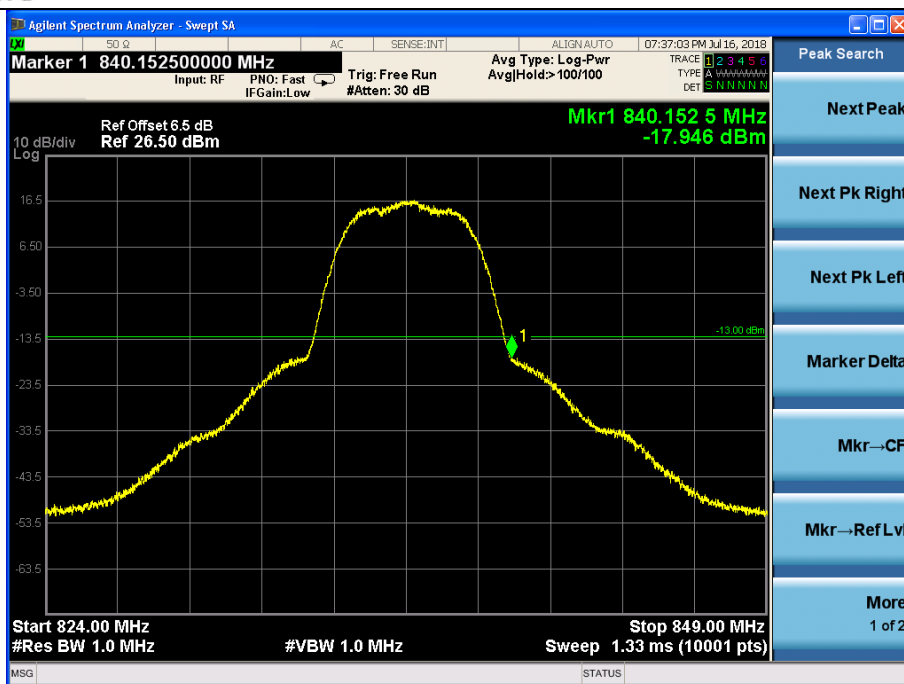

Channel 4183, 824MHz~849MHz

Note: The signal beyond the limit is the signal transmitted by EUT.

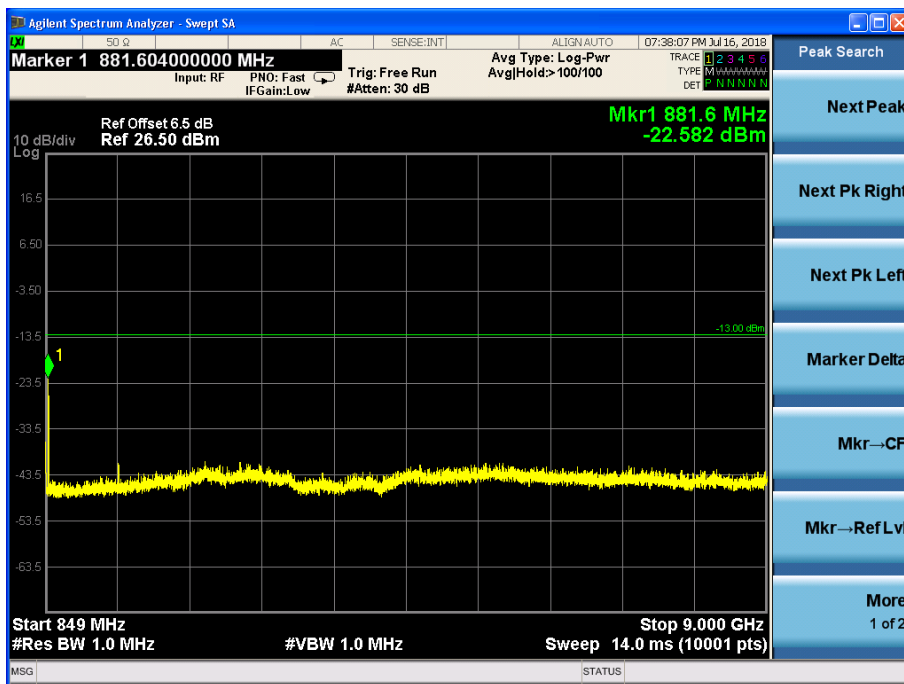

Channel 4183, 849MHz~9GHz

WCDMA band IV
WCDMA Mode:

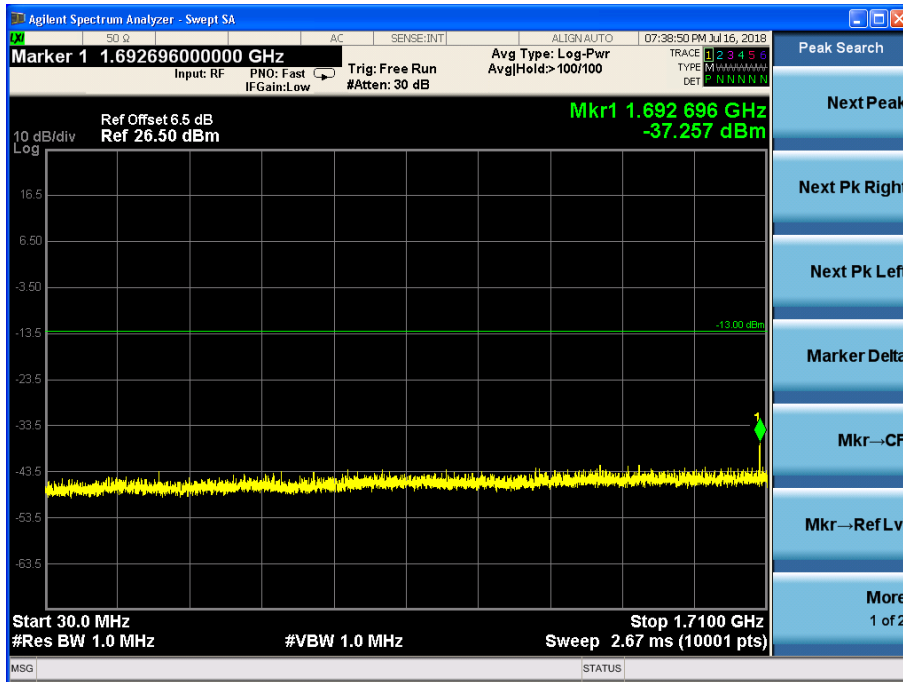

Channel 1412, 30MHz~1710MHz

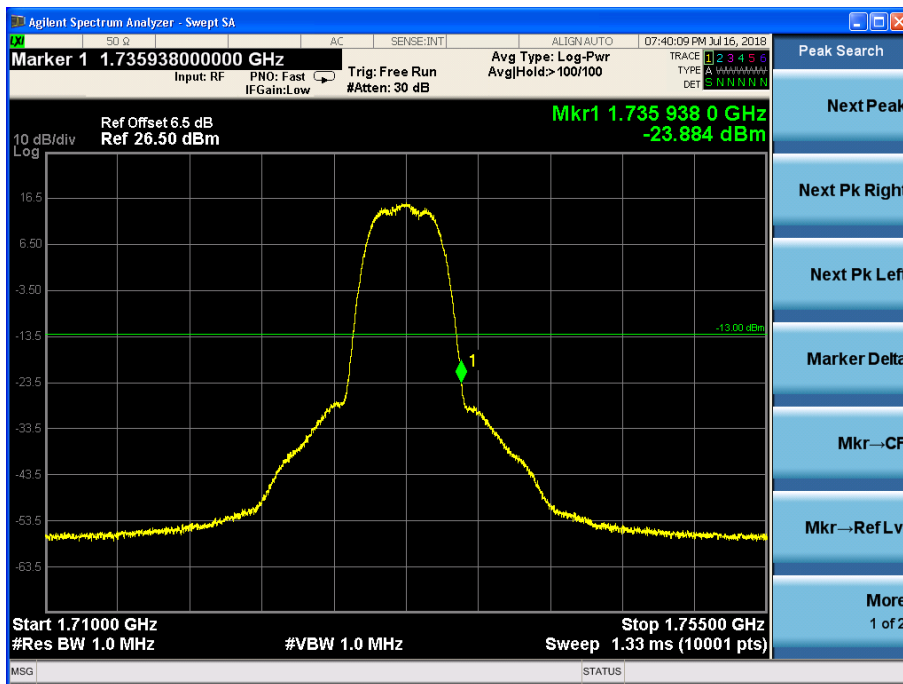

Channel 1412, 1710MHz~1755MHz

Note: The signal beyond the limit is the signal transmitted by EUT.

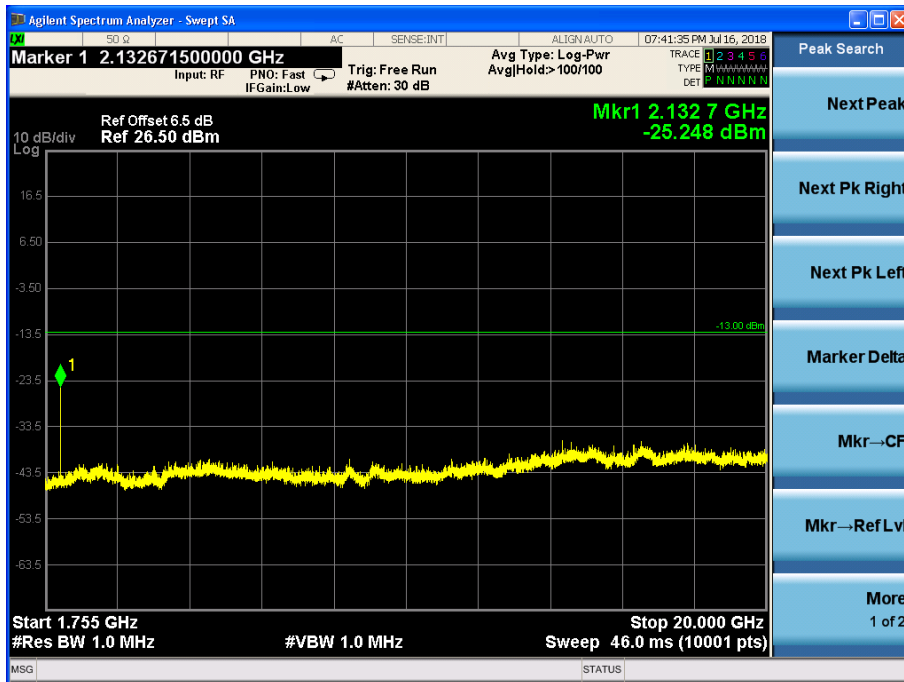

Channel 1412, 1755MHz~20GHz

HSDPA/HSUPA Mode:

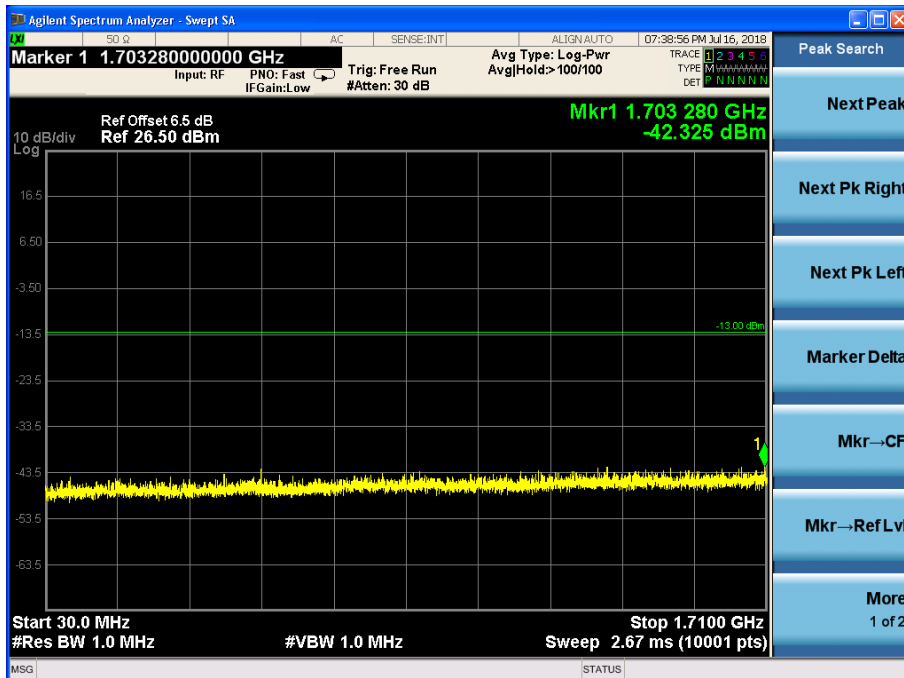

Channel 1412, 30MHz~1710MHz

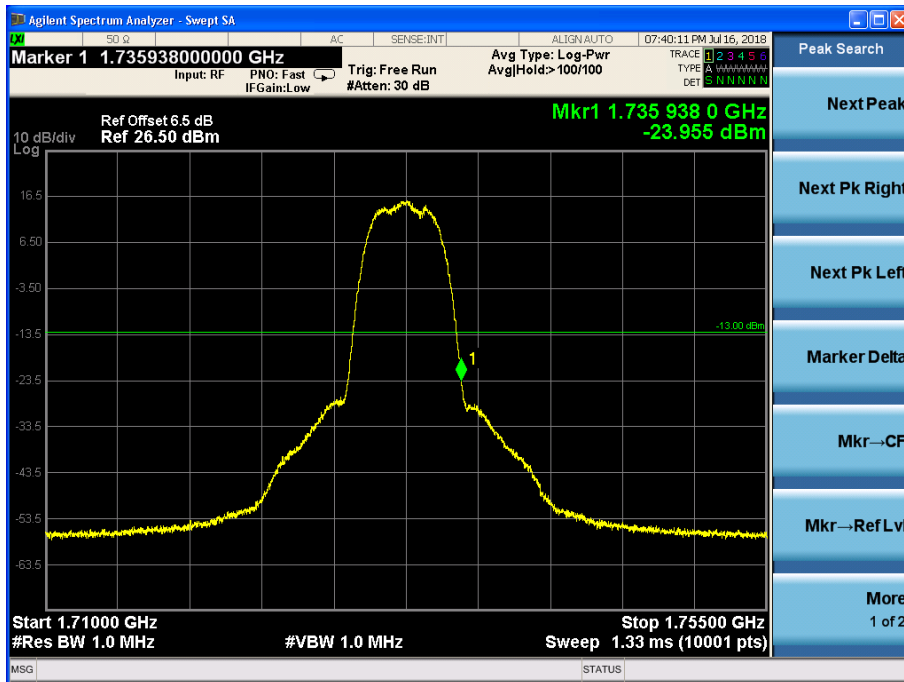

Channel 1412, 1710MHz~1755MHz

Note: The signal beyond the limit is the signal transmitted by EUT.

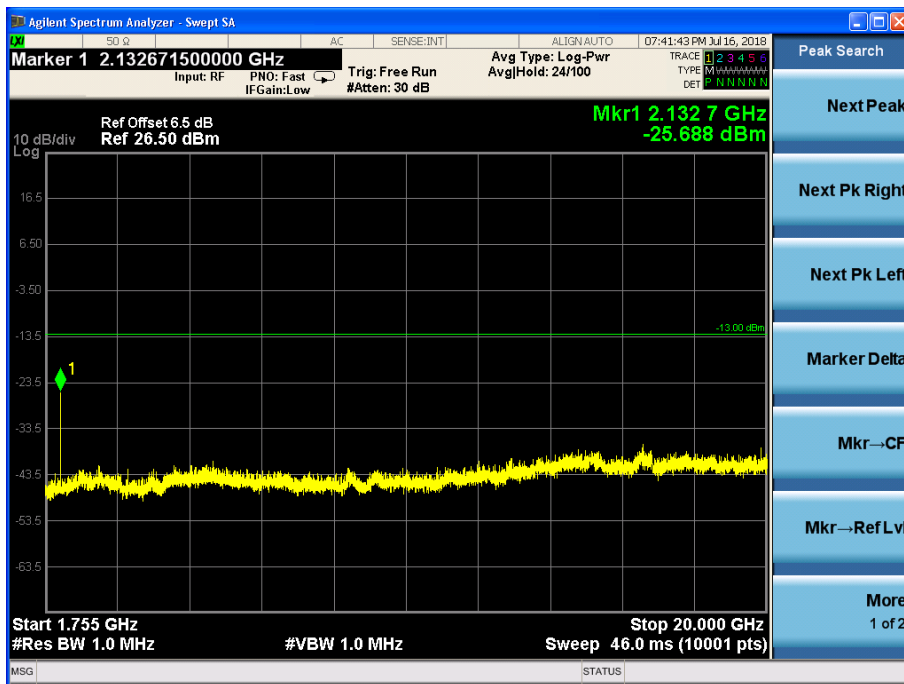

Channel 1412, 1755MHz~20GHz

HSPA+ Mode:

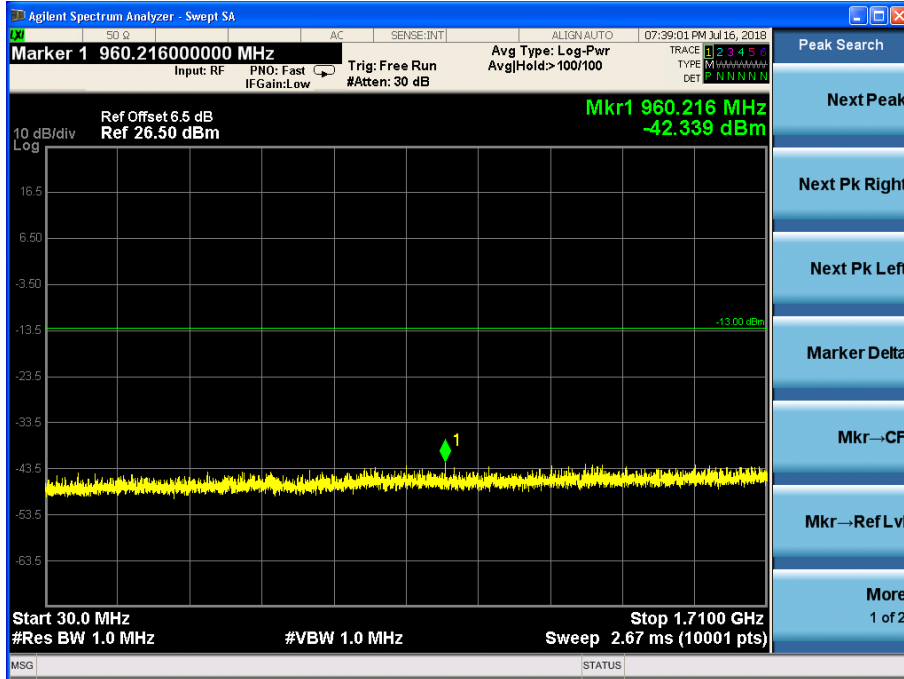

Channel 1412, 30MHz~1710MHz

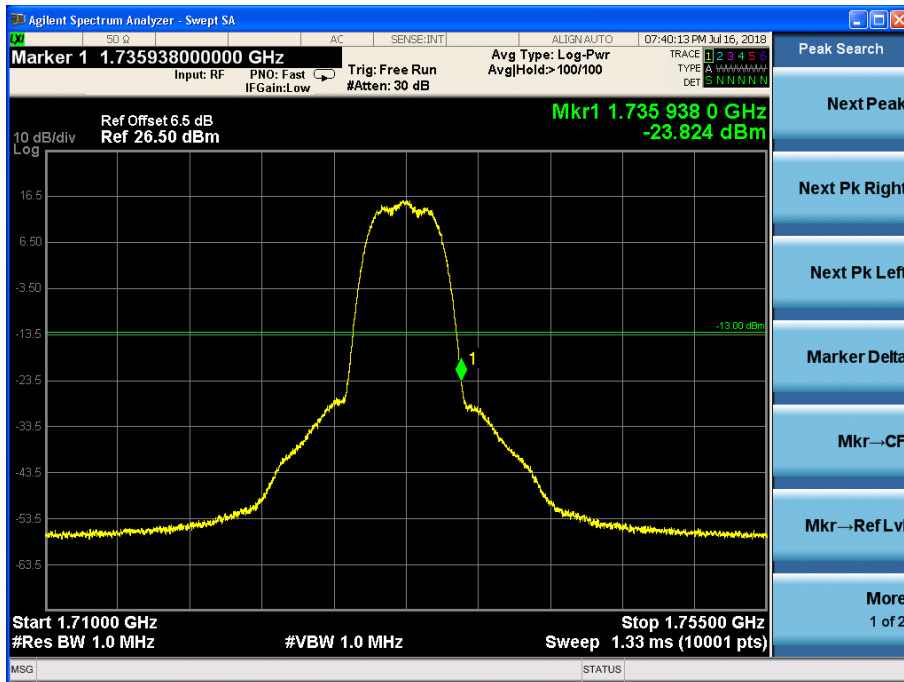

Channel 1412, 1710MHz~1755MHz

Note: The signal beyond the limit is the signal transmitted by EUT.

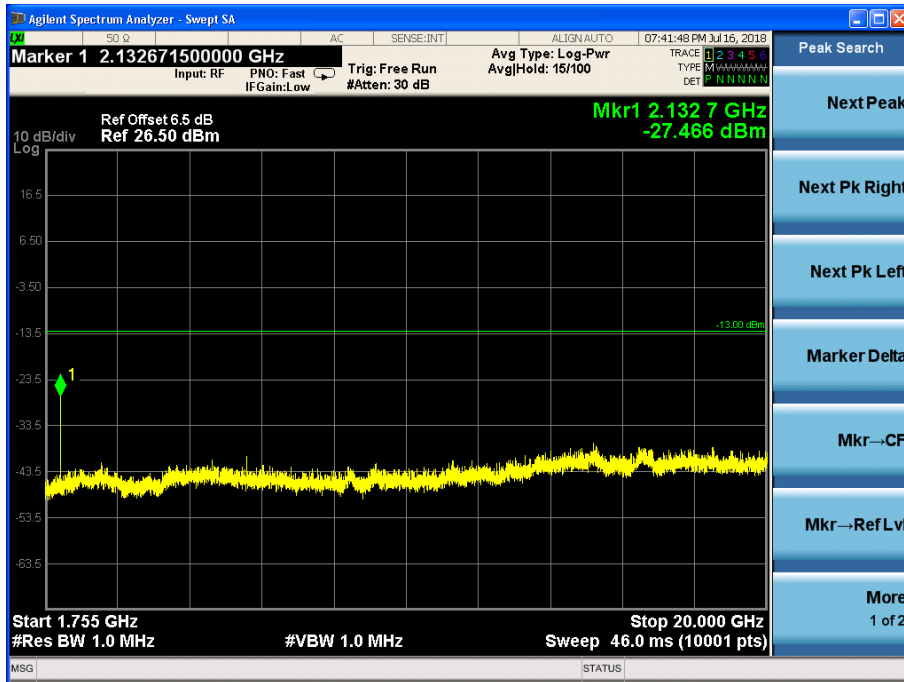

Channel 1412, 1755MHz~20GHz

DC-HSDPA Mode:

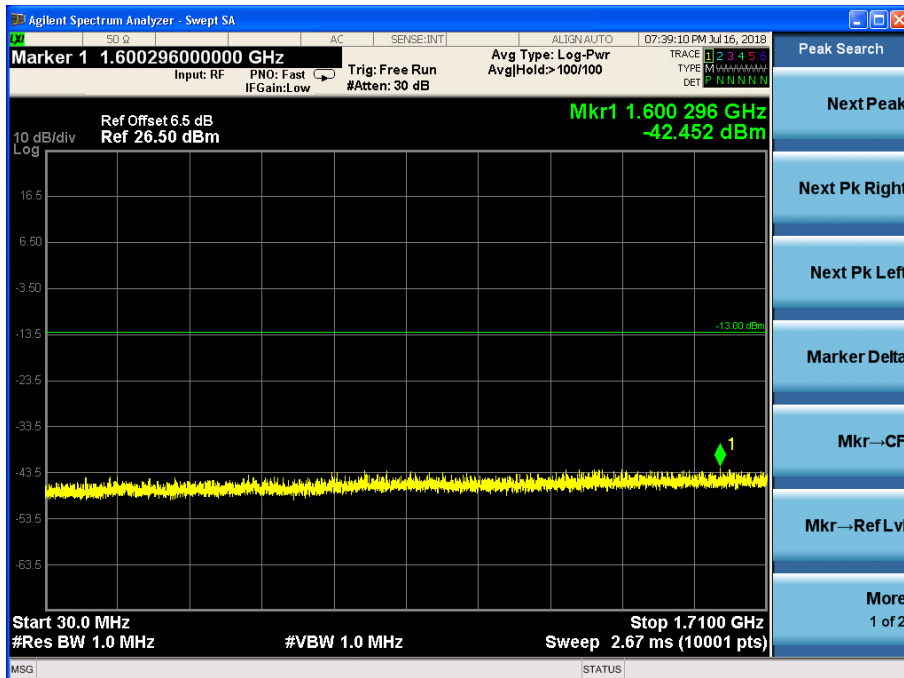

Channel 1412, 30MHz~1710MHz

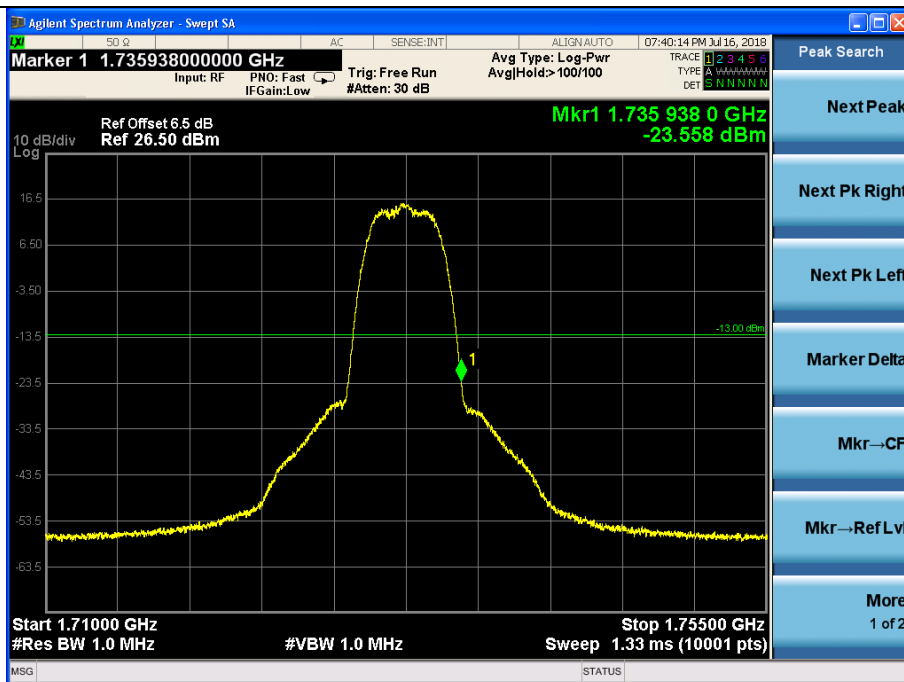

Channel 1412, 1710MHz~1755MHz

Note: The signal beyond the limit is the signal transmitted by EUT.

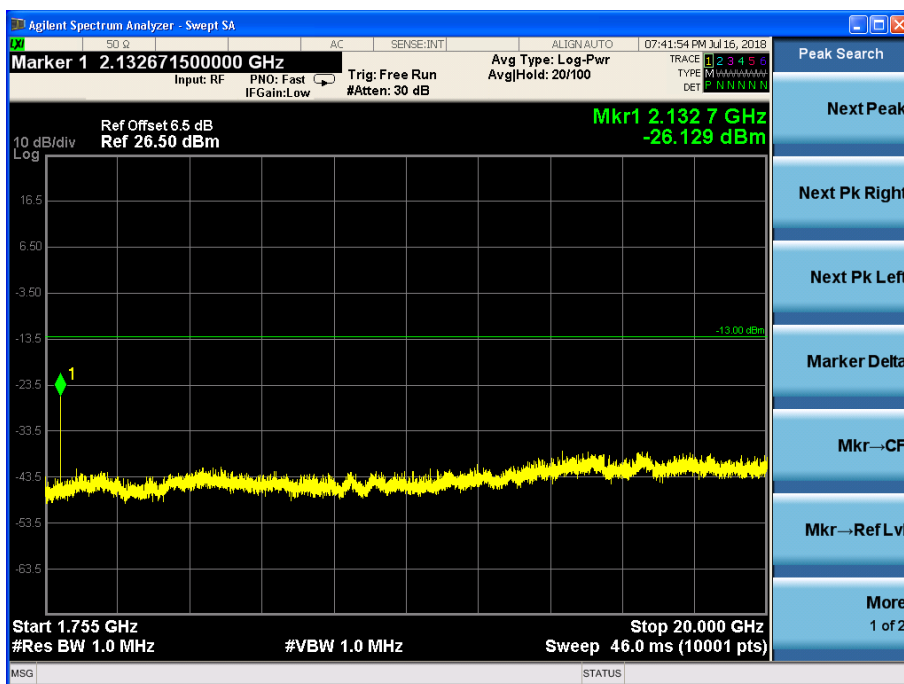

Channel 1412, 1755MHz~20GHz

Band Edges Compliance-FCC 22.917(b)/24.238(b)/ 27.53(h)

WCDMA band II

WCDMA Mode:

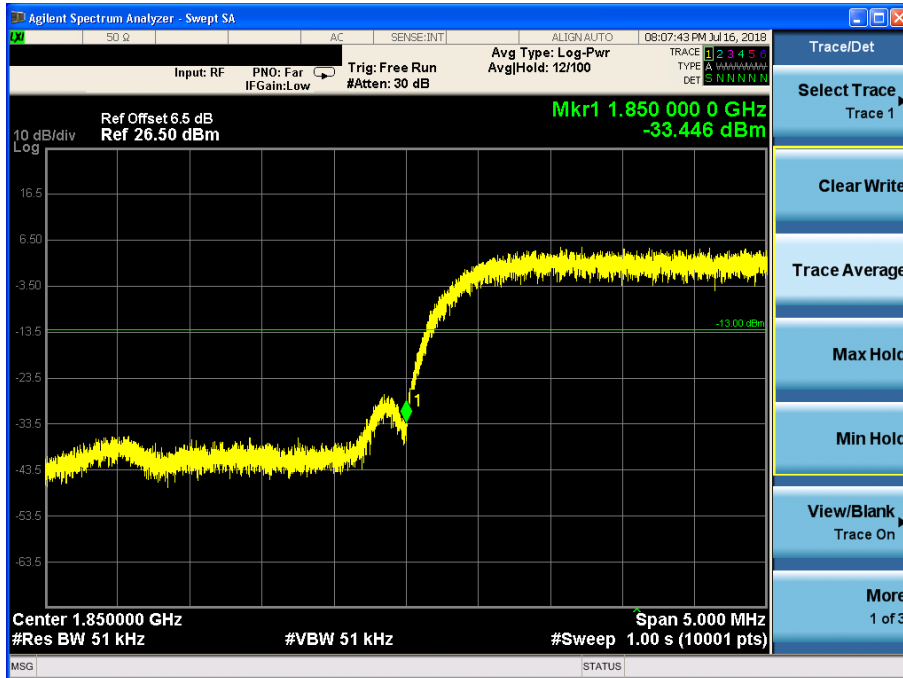

Channel 9262

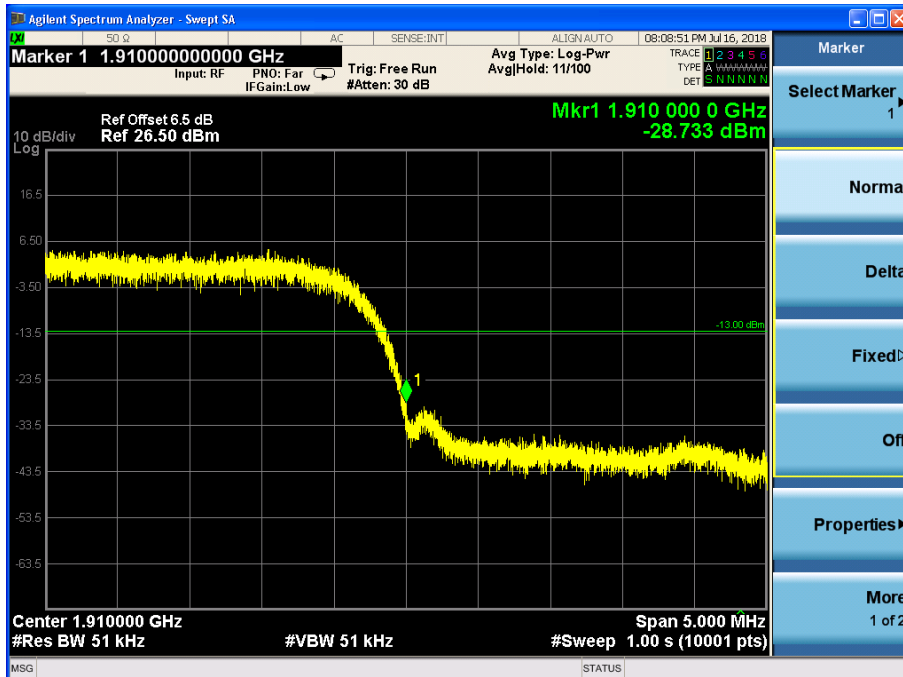

Channel 9538

HSDPA/HSUPA Mode:

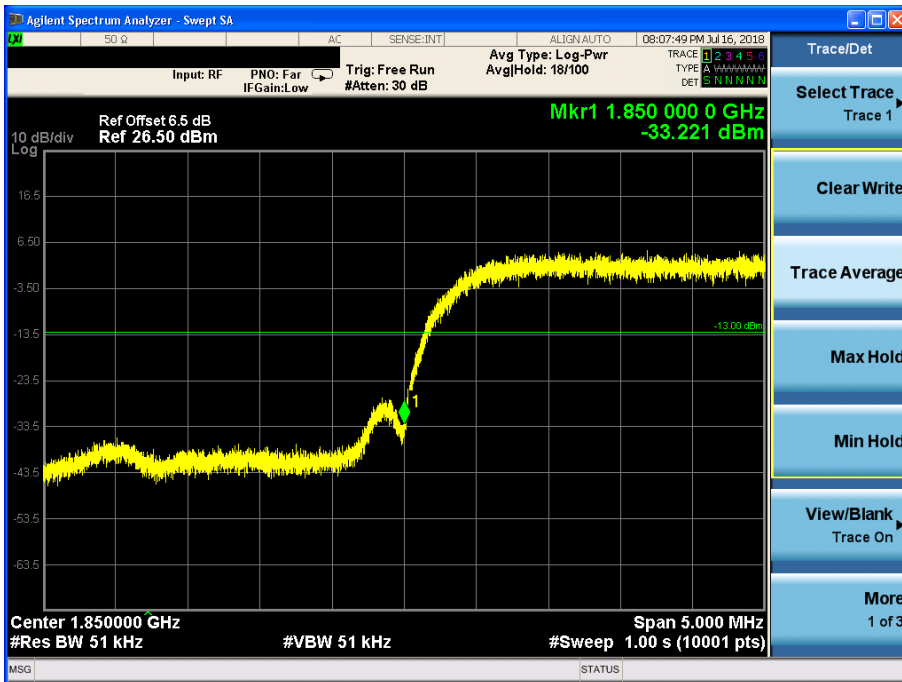

Channel 9262

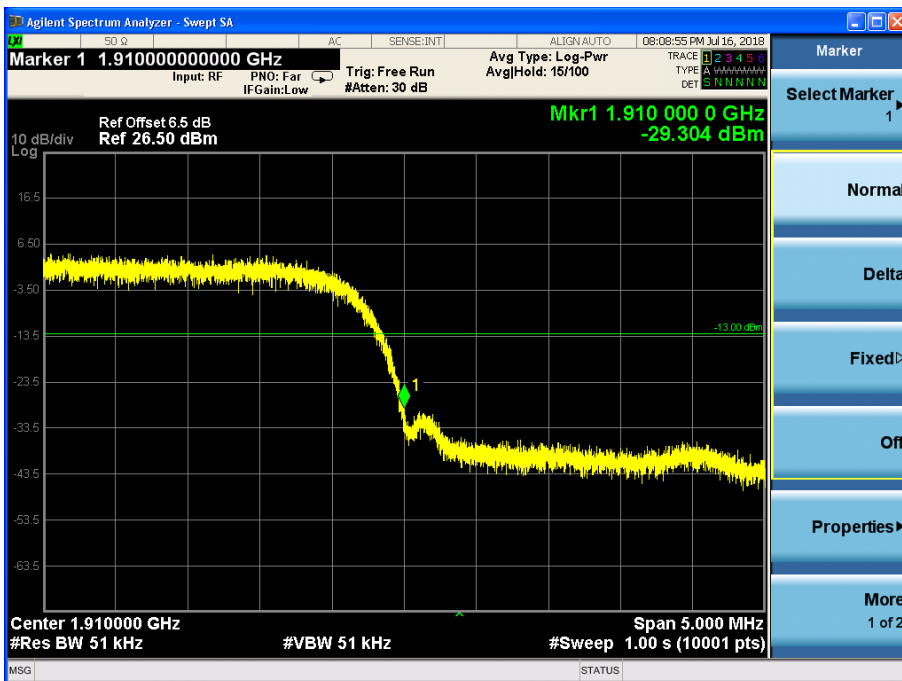

Channel 9538

HSPA+ Mode:

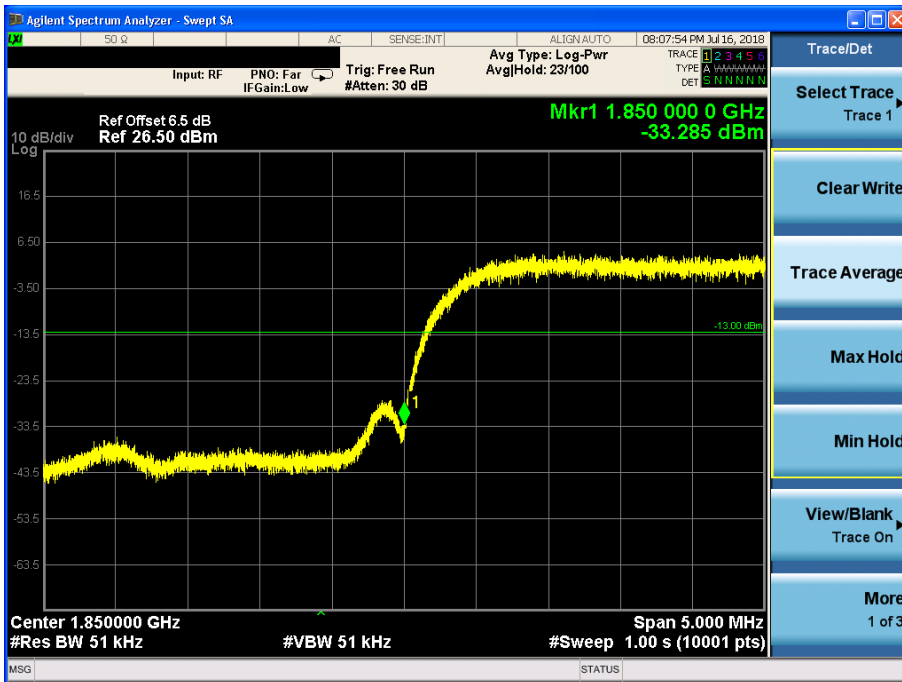

Channel 9262

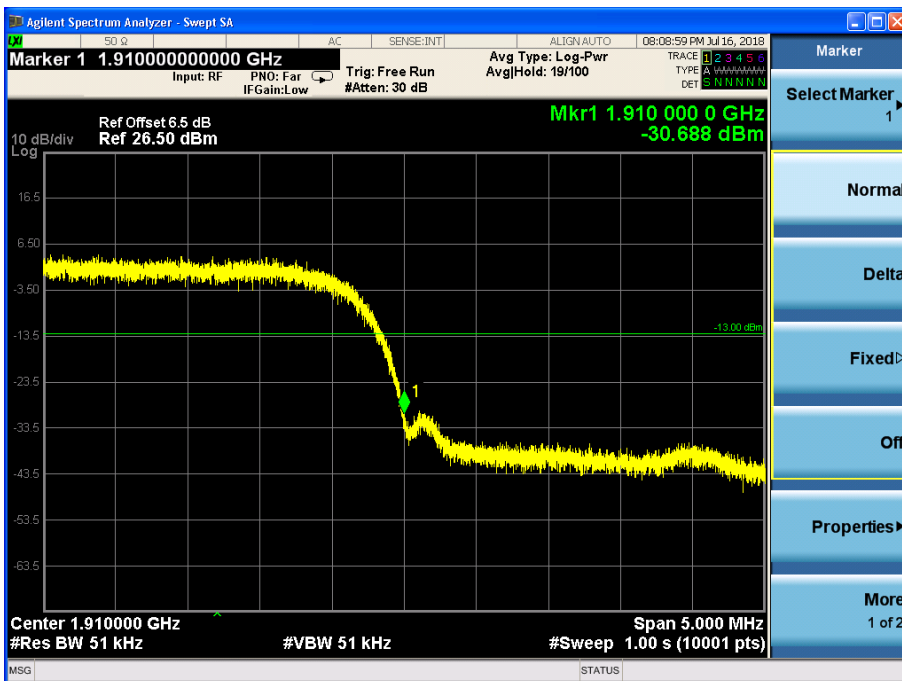

Channel 9538

DC-HSDPA Mode:

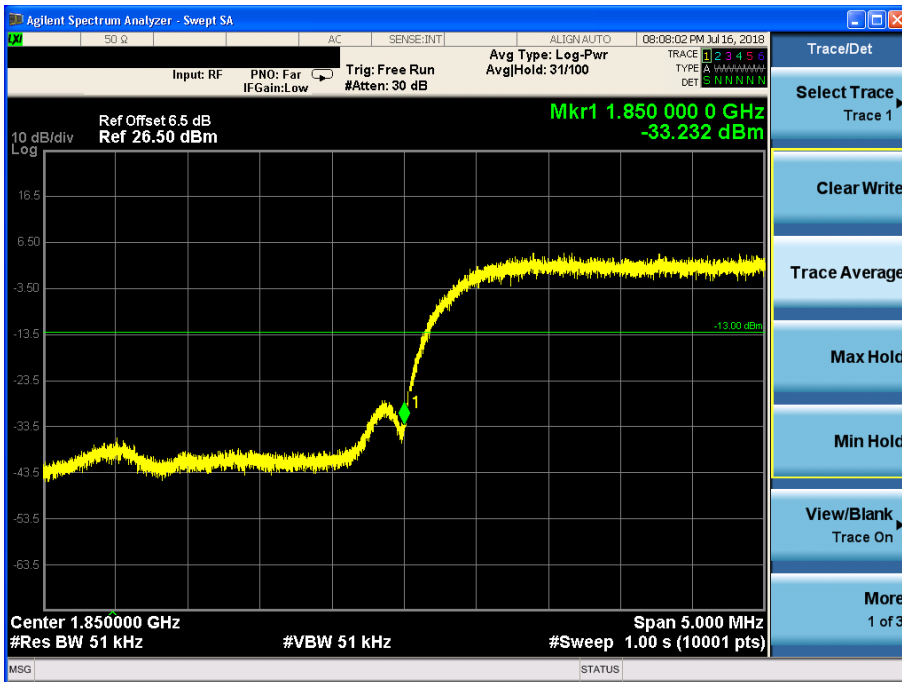

Channel 9262

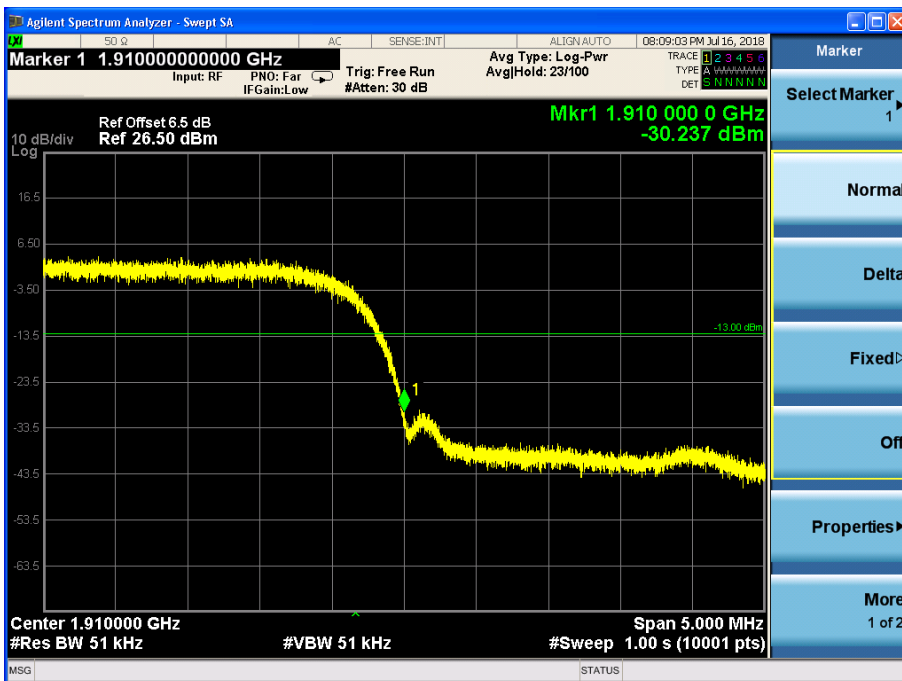

Channel 9538

WCDMA band V

WCDMA Mode:

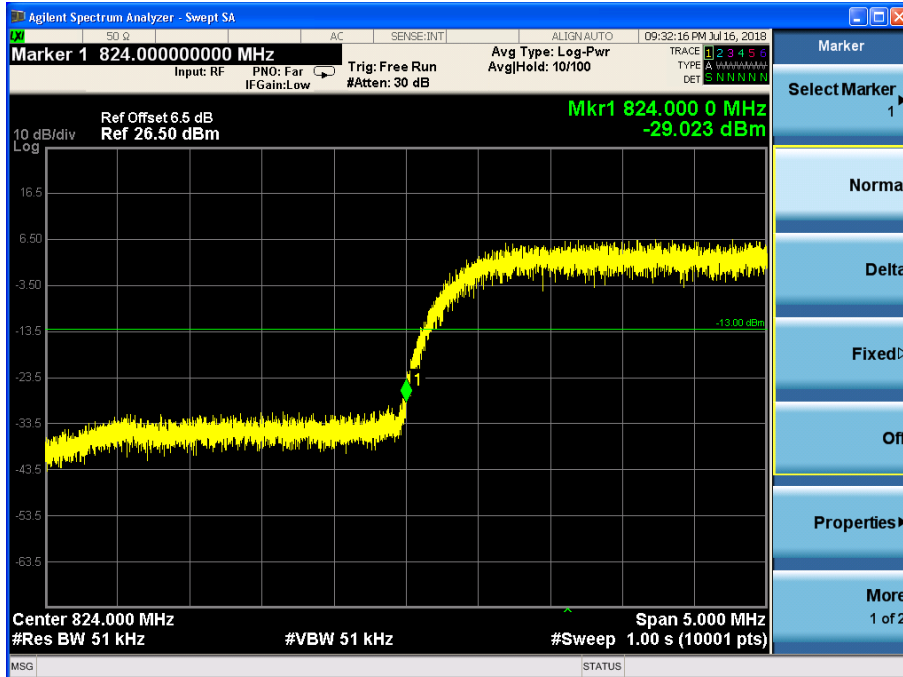

Channel 4132

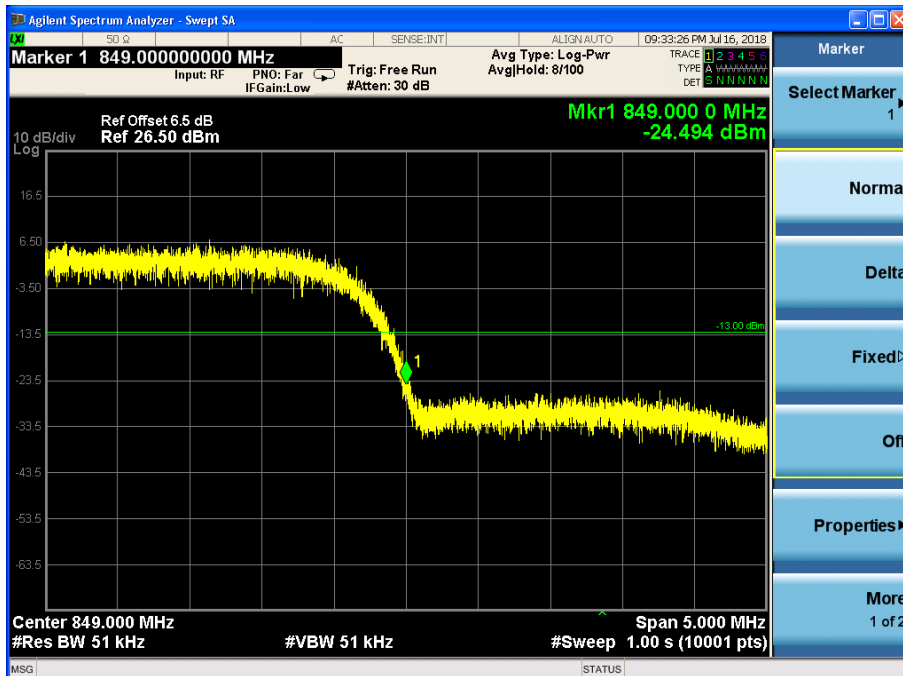

Channel 4233

HSDPA/HSUPA Mode:

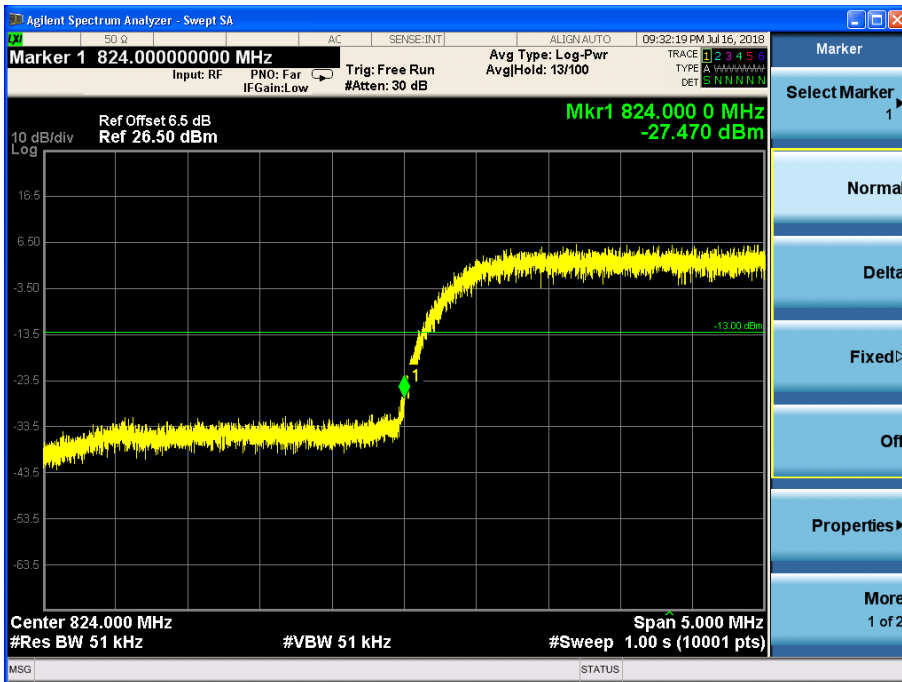

Channel 4132

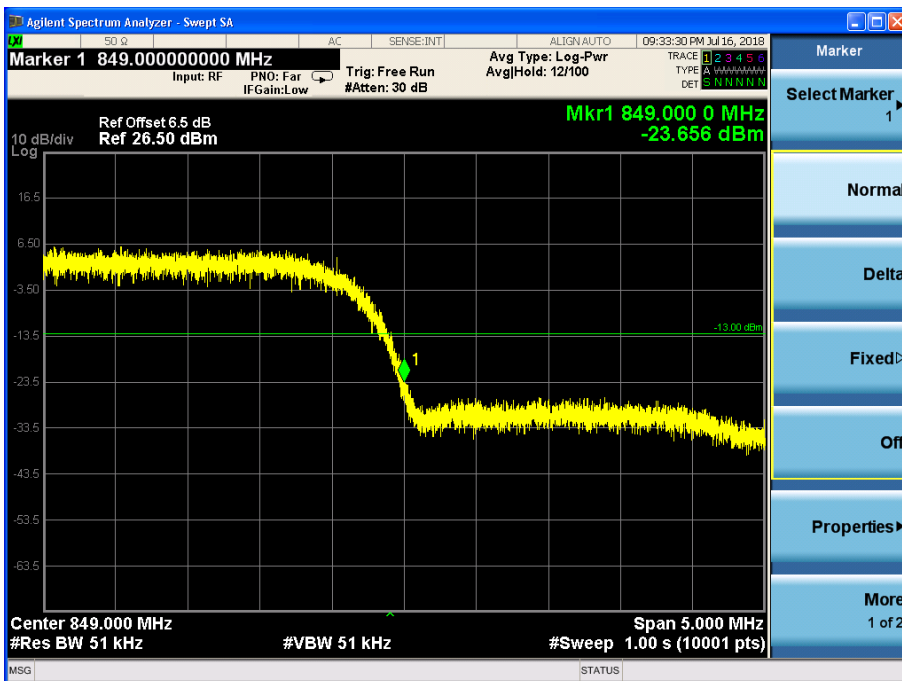

Channel 4233

HSPA+ Mode:

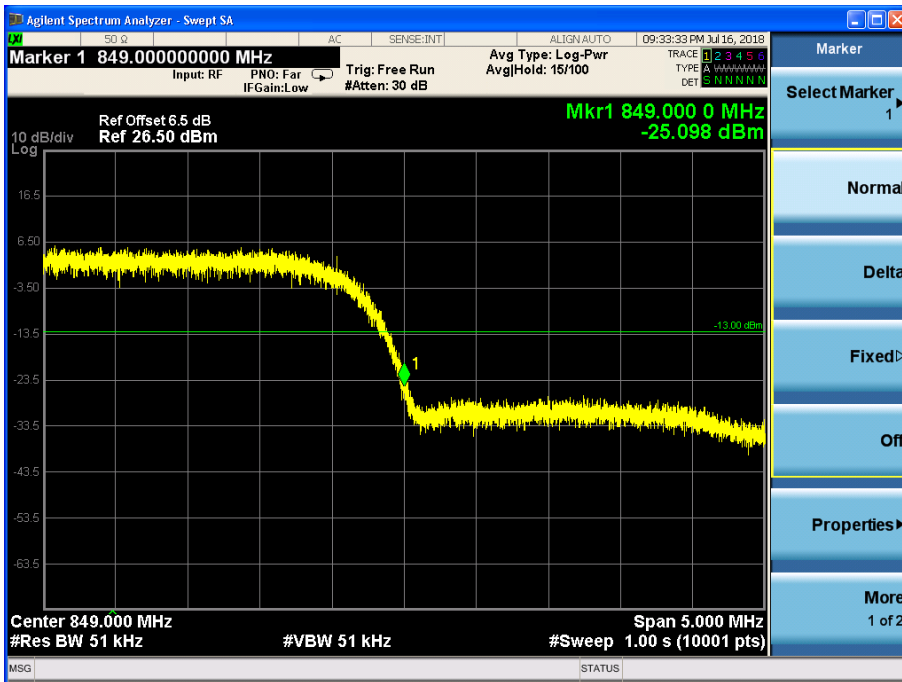
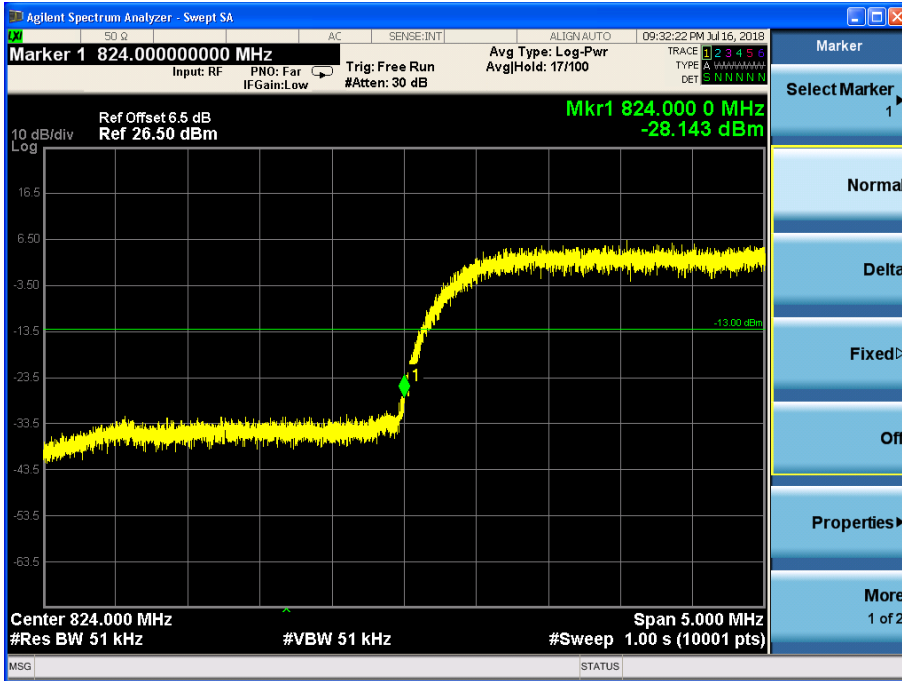

DC-HSDPA Mode:

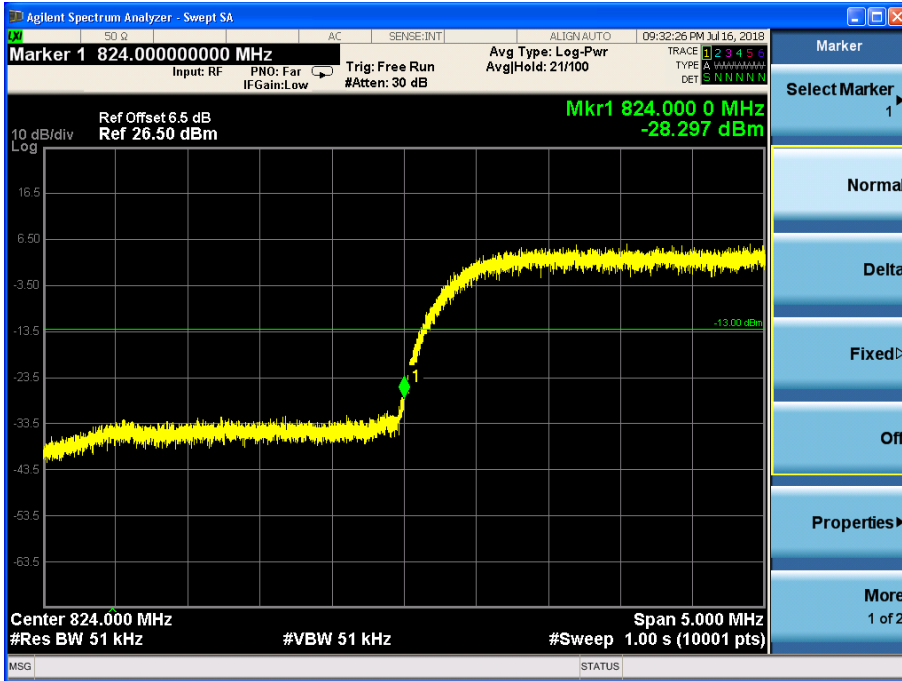

Channel 4132

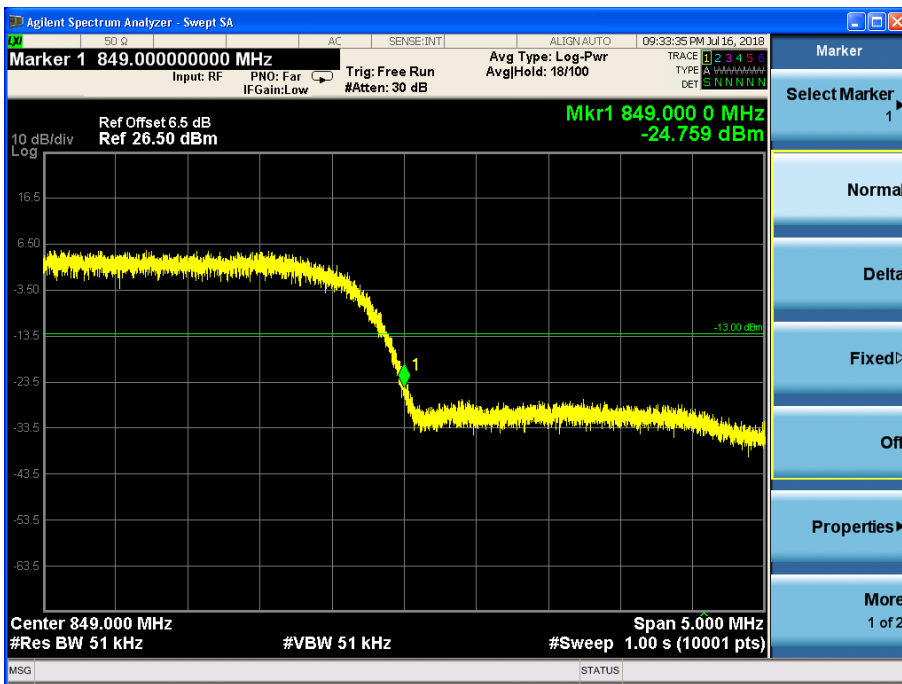

Channel 4233

WCDMA band IV

WCDMA Mode:

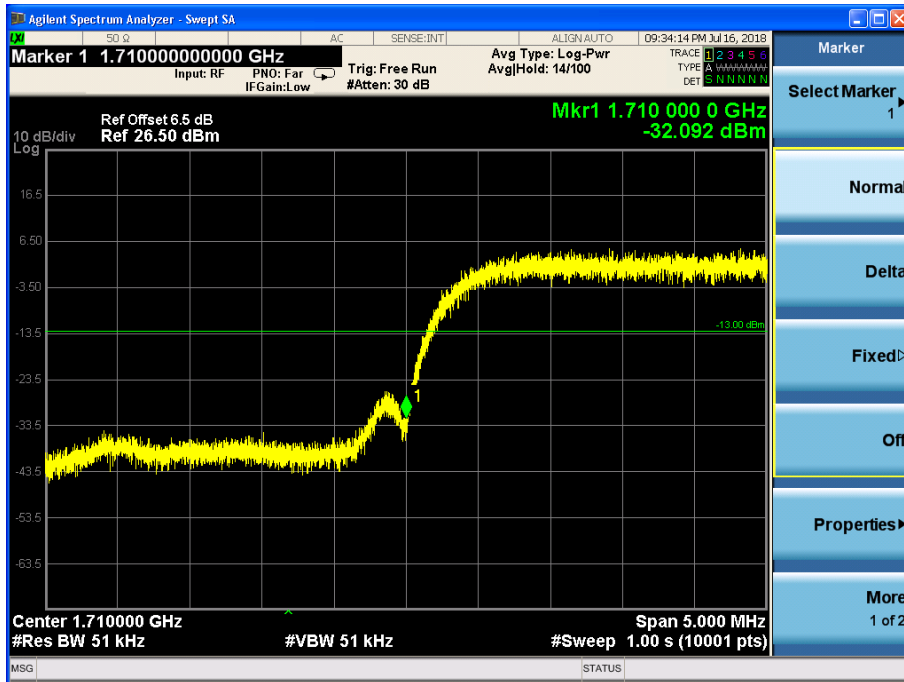

Channel 1312

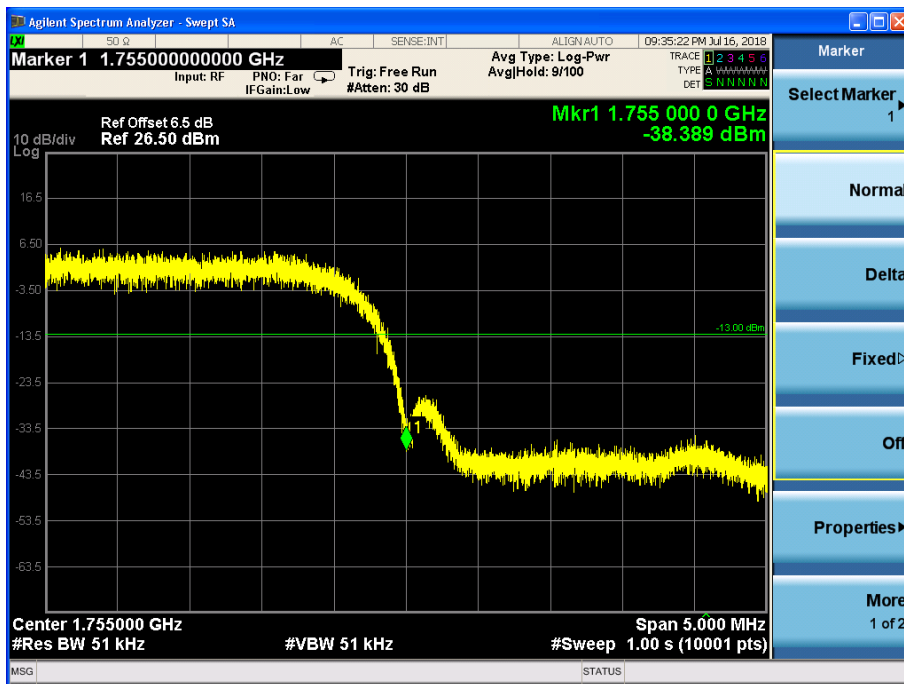

Channel 1513

HSDPA/HSUPA Mode:

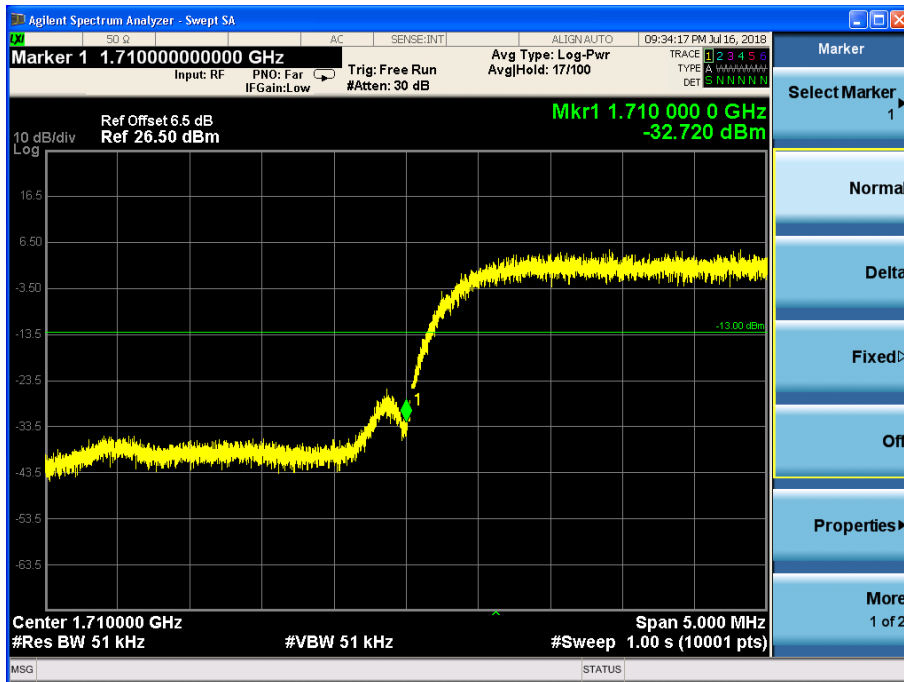

Channel 1312

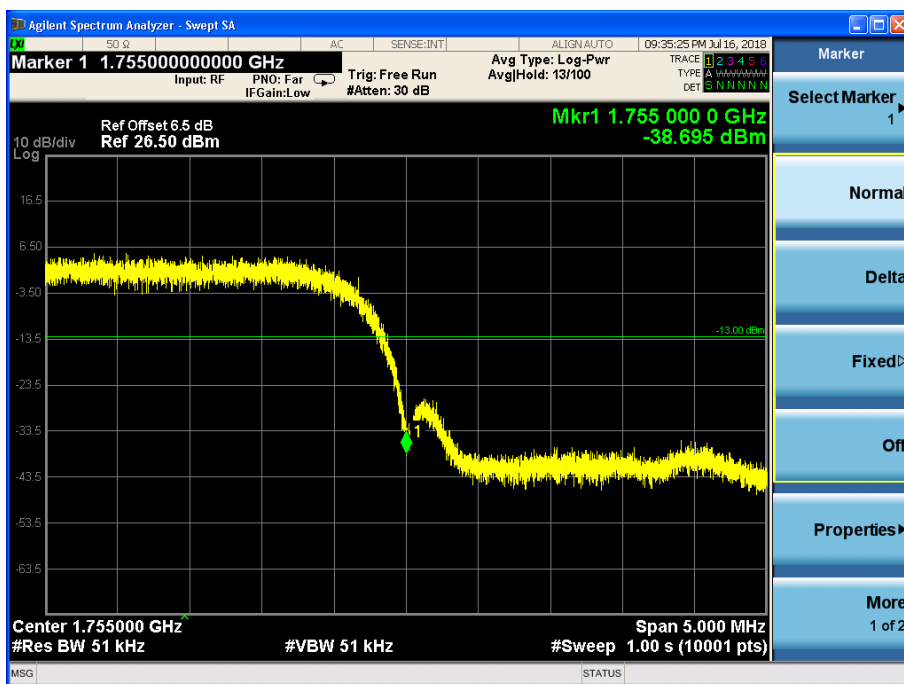

Channel 1513

HSPA+ Mode:

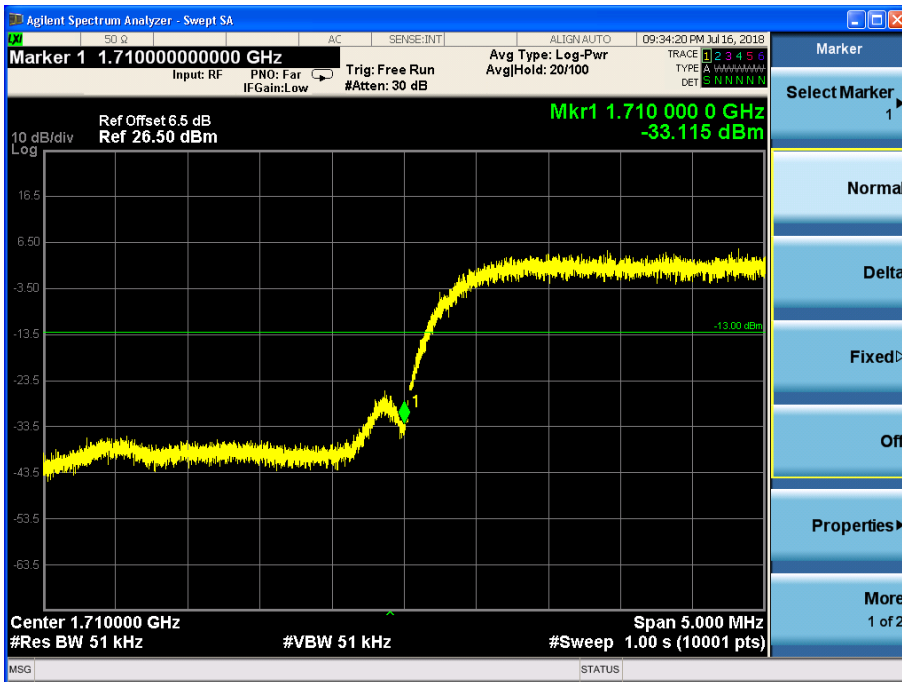

Channel 1312

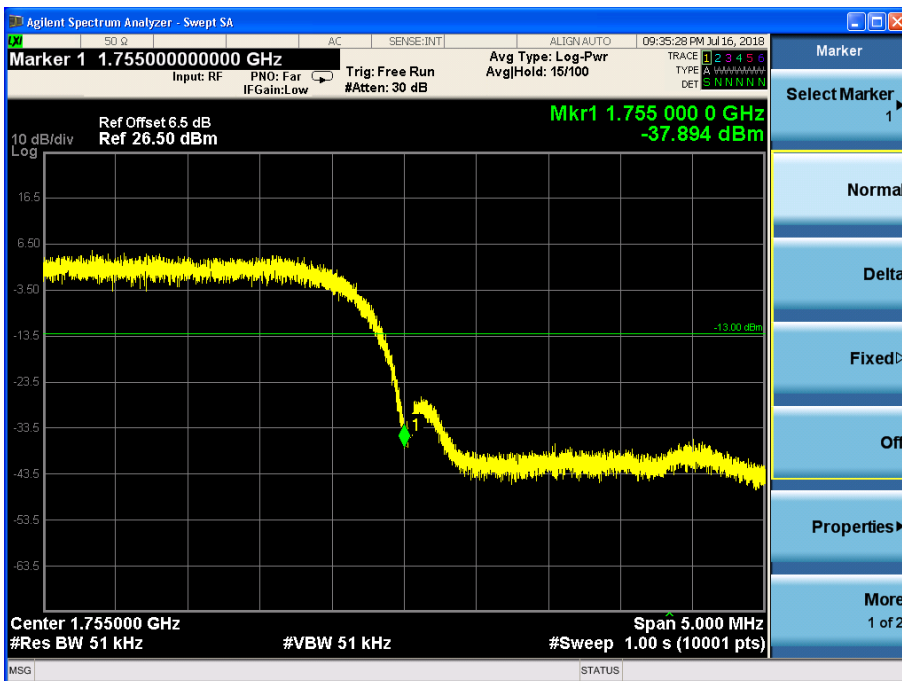

Channel 1513

DC-HSDPA Mode:

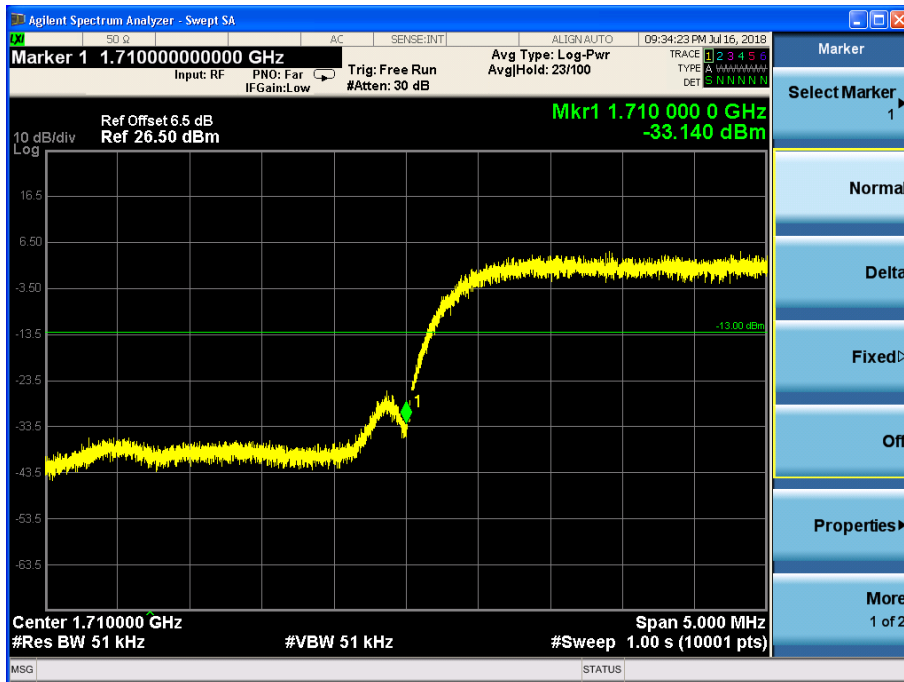

Channel 1312

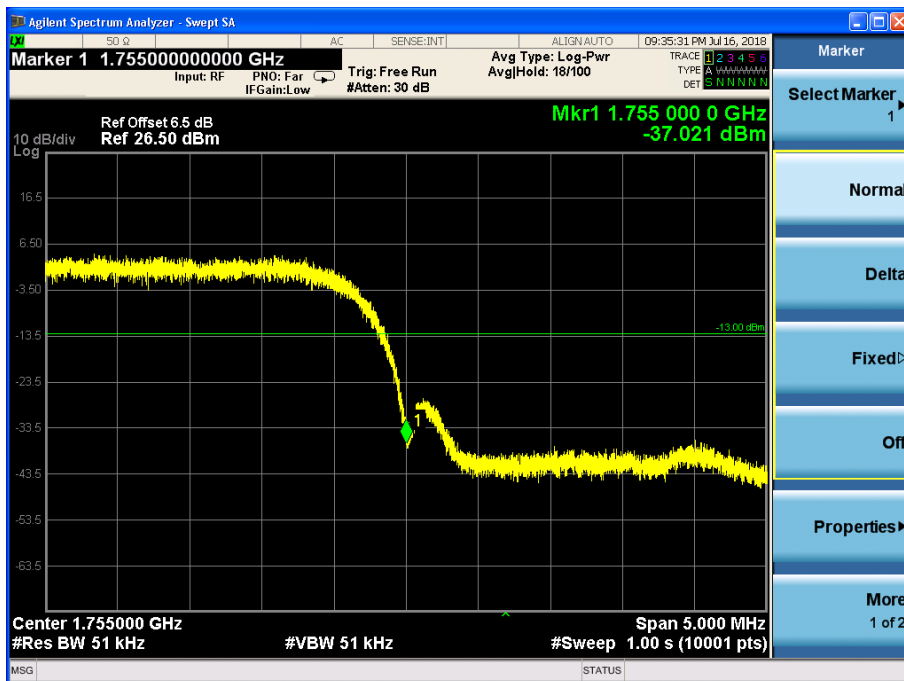

Channel 1513

Frequency Stability-FCC Part2.1055/22.355/24.235/27.54

WCDMA band II

WCDMA Mode:

Temperature(°C)	Test Result (ppm)@NV		
	Channel 9262	Channel 9400	Channel 9538
-20	0.002	0.003	0.002
-10	0.002	0.002	0.002
0	0.001	0.012	0.014
+10	0.003	0.001	0.004
+20	0.011	0.002	0.003
+30	0.002	0.009	0.004
+40	0.002	0.005	0.002
+50	0.007	0.003	0.008
+55	0.004	0.004	0.015
Voltage	Test Result (ppm)@NT		
	Channel 9262	Channel 9400	Channel 9538
LV	0.002	0.003	0.004
HV	0.004	0.004	0.002

HSDPA/HSUPA Mode:

Temperature(°C)	Test Result (ppm)@NV		
	Channel 9262	Channel 9400	Channel 9538
-20	0.002	0.003	0.002
-10	0.002	0.002	0.002
0	0.004	0.003	0.004
+10	0.002	0.001	0.001
+20	0.003	0.004	0.005
+30	0.001	0.002	0.002
+40	0.008	0.002	0.002
+50	0.002	0.007	0.007
+55	0.003	0.002	0.003
Voltage	Test Result (ppm)NT		
	Channel 9262	Channel 9400	Channel 9538
LV	0.008	0.011	0.003
HV	0.006	0.002	0.008

HSPA+ Mode:

Temperature(°C)	Test Result (ppm)@NV		
	Channel 9262	Channel 9400	Channel 9538
-20	0.002	0.003	0.002
-10	0.002	0.002	0.002
0	0.004	0.003	0.004
+10	0.002	0.001	0.001
+20	0.003	0.004	0.005
+30	0.001	0.002	0.002
+40	0.008	0.002	0.002
+50	0.002	0.007	0.007
+55	0.003	0.002	0.003
Voltage	Test Result (ppm)NT		
	Channel 9262	Channel 9400	Channel 9538
LV	0.008	0.011	0.003
HV	0.006	0.002	0.008

DC-HSDPA Mode:

Temperature(°C)	Test Result (ppm)@NV		
	Channel 9262	Channel 9400	Channel 9538
-20	0.002	0.003	0.002
-10	0.002	0.002	0.002
0	0.004	0.003	0.004
+10	0.002	0.001	0.001
+20	0.003	0.004	0.005
+30	0.001	0.002	0.002
+40	0.008	0.002	0.002
+50	0.002	0.007	0.007
+55	0.003	0.002	0.003
Voltage	Test Result (ppm)NT		
	Channel 9262	Channel 9400	Channel 9538
LV	0.008	0.011	0.003
HV	0.006	0.002	0.008

WCDMA band V

WCDMA Mode:

Temperature(°C)	Test Result (ppm)@NV		
	Channel 4132	Channel 4183	Channel 4233
-20	0.002	0.003	0.002
-10	0.002	0.002	0.002
0	0.005	0.008	0.005
+10	0.007	0.002	0.004
+20	0.002	0.007	0.007
+30	0.002	0.002	0.002
+40	0.003	0.003	0.006
+50	0.006	0.003	0.004
+55	0.002	0.009	0.004

Voltage	Test Result (ppm)@NT		
	Channel 4132	Channel 4183	Channel 4233
LV	0.007	0.003	0.003
HV	0.004	0.006	0.002

HSDPA/HSUPA Mode:

Temperature(°C)	Test Result (ppm)@NV		
	Channel 4132	Channel 4183	Channel 4233
-20	0.002	0.003	0.002
-10	0.002	0.002	0.002
0	0.005	0.003	0.003
+10	0.002	0.002	0.002
+20	0.012	0.002	0.005
+30	0.003	0.003	0.003
+40	0.003	0.008	0.002
+50	0.001	0.001	0.006
+55	0.007	0.002	0.004

Voltage	Test Result (ppm)@NT		
	Channel 4132	Channel 4183	Channel 4233
LV	0.012	0.004	0.006
HV	0.002	0.008	0.003

HSPA+ Mode:

Temperature(°C)	Test Result (ppm)@NV		
	Channel 4132	Channel 4183	Channel 4233
-20	0.002	0.003	0.002
-10	0.002	0.002	0.002
0	0.005	0.003	0.003
+10	0.002	0.002	0.002
+20	0.012	0.002	0.005
+30	0.003	0.003	0.003
+40	0.003	0.008	0.002
+50	0.001	0.001	0.006
+55	0.007	0.002	0.004

Voltage	Test Result (ppm)@NT		
	Channel 4132	Channel 4183	Channel 4233
LV	0.012	0.004	0.006
HV	0.002	0.008	0.003

DC-HSDPA Mode:

Temperature(°C)	Test Result (ppm)@NV		
	Channel 4132	Channel 4183	Channel 4233
-20	0.002	0.003	0.002
-10	0.002	0.002	0.002
0	0.005	0.003	0.003
+10	0.002	0.002	0.002
+20	0.012	0.002	0.005
+30	0.003	0.003	0.003
+40	0.003	0.008	0.002
+50	0.001	0.001	0.006
+55	0.007	0.002	0.004

Voltage	Test Result (ppm)@NT		
	Channel 4132	Channel 4183	Channel 4233
LV	0.013	0.004	0.006
HV	0.002	0.008	0.003

WCDMA band IV

WCDMA Mode:

Temperature(°C)	Test Result (ppm)@NV		
	Channel 1312	Channel 1412	Channel 1513
-20	0.002	0.003	0.002
-10	0.002	0.002	0.002
0	0.005	0.001	0.002
+10	0.003	0.004	0.003
+20	0.001	0.003	0.002
+30	0.008	0.002	0.003
+40	0.004	0.003	0.007
+50	0.003	0.004	0.002
+55	0.003	0.004	0.004

Voltage	Test Result (ppm)@NT		
	Channel 1312	Channel 1412	Channel 1513
LV	0.005	0.002	0.003
HV	0.001	0.006	0.009

HSDPA/HSUPA Mode:

Temperature(°C)	Test Result (ppm)@NV		
	Channel 1312	Channel 1412	Channel 1513
-20	0.002	0.003	0.002
-10	0.002	0.002	0.002
0	0.003	0.002	0.003
+10	0.002	0.003	0.008
+20	0.003	0.004	0.003
+30	0.005	0.006	0.004
+40	0.004	0.002	0.005
+50	0.001	0.001	0.003
+55	0.007	0.004	0.009

Voltage	Test Result (ppm)@NT		
	Channel 1312	Channel 1412	Channel 1513
LV	0.003	0.008	0.005
HV	0.006	0.004	0.004

HSPA+ Mode:

Temperature(°C)	Test Result (ppm)@NV		
	Channel 1312	Channel 1412	Channel 1513
-20	0.002	0.003	0.002
-10	0.002	0.002	0.002
0	0.003	0.002	0.003
+10	0.002	0.003	0.008
+20	0.003	0.004	0.003
+30	0.005	0.006	0.004
+40	0.004	0.002	0.005
+50	0.001	0.001	0.003
+55	0.007	0.004	0.009

Voltage	Test Result (ppm)@NT		
	Channel 1312	Channel 1412	Channel 1513
LV	0.003	0.008	0.005
HV	0.006	0.004	0.004

DC-HSDPA Mode:

Temperature(°C)	Test Result (ppm)@NV		
	Channel 1312	Channel 1412	Channel 1513
-20	0.002	0.003	0.002
-10	0.002	0.002	0.002
0	0.003	0.002	0.003
+10	0.002	0.003	0.008
+20	0.003	0.004	0.003
+30	0.005	0.006	0.004
+40	0.004	0.002	0.005
+50	0.001	0.001	0.003
+55	0.007	0.004	0.012

Voltage	Test Result (ppm)@NT		
	Channel 1312	Channel 1412	Channel 1513
LV	0.003	0.008	0.005
HV	0.006	0.004	0.004

Peak-Average Ratio -FCC Part 24.232(d)/ 27.50(d)(5)

WCDMA band II

WCDMA Mode:

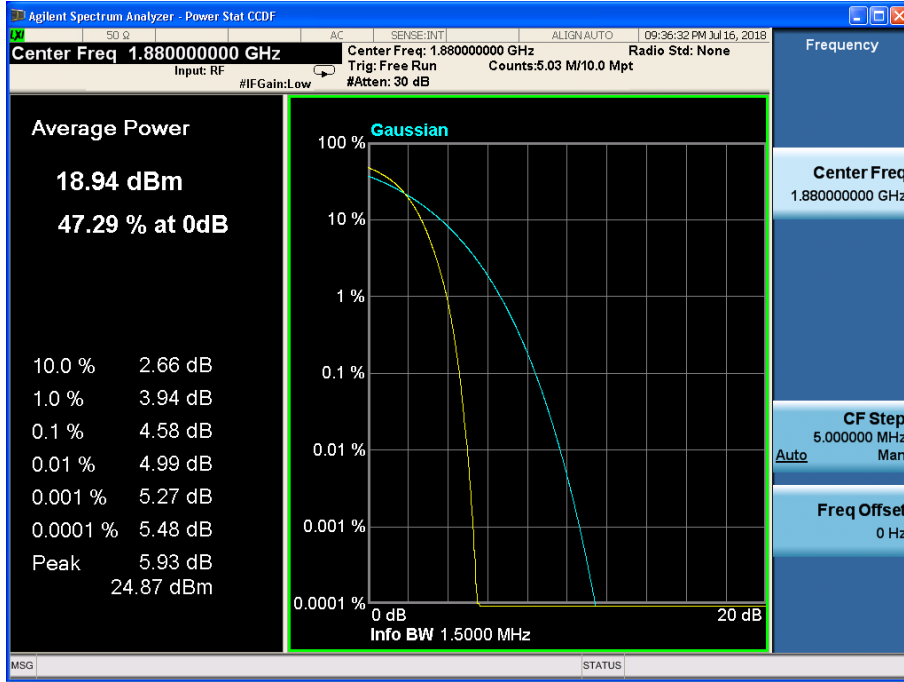

HSDPA/HSUPA Mode:

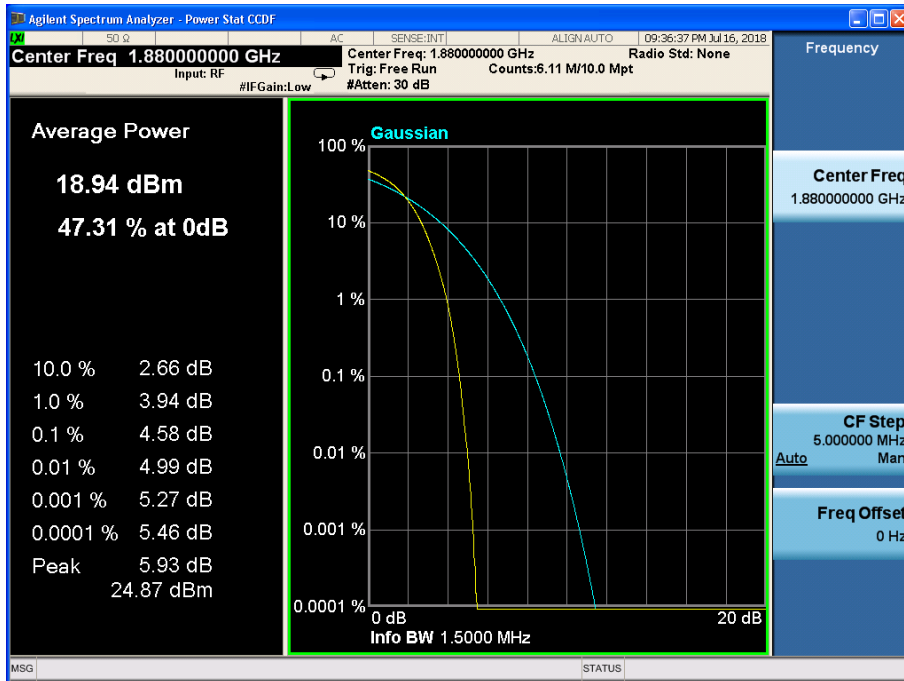

HSPA+ Mode:

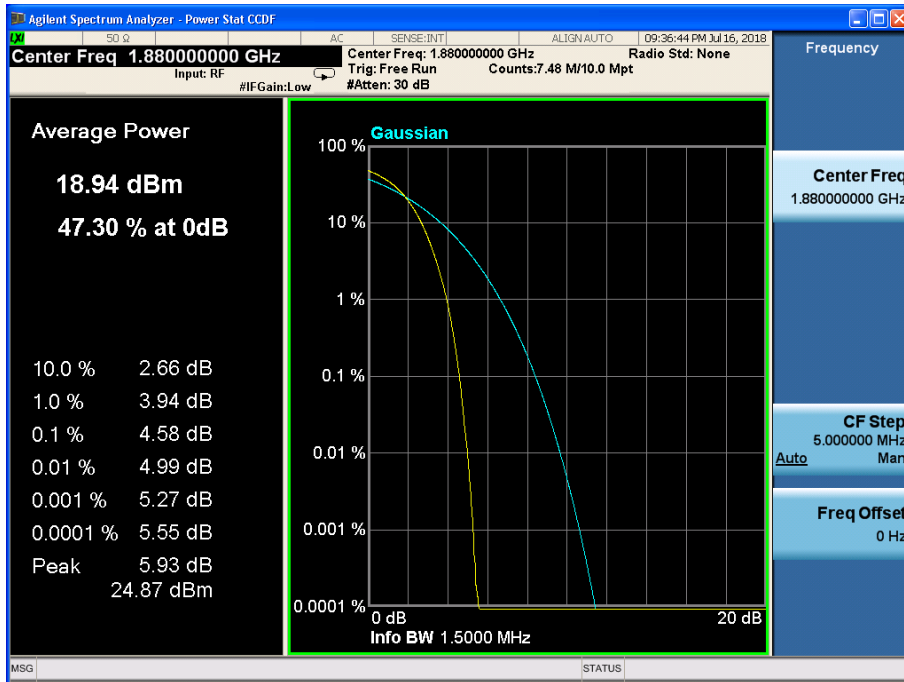

DC-HSDPA Mode:

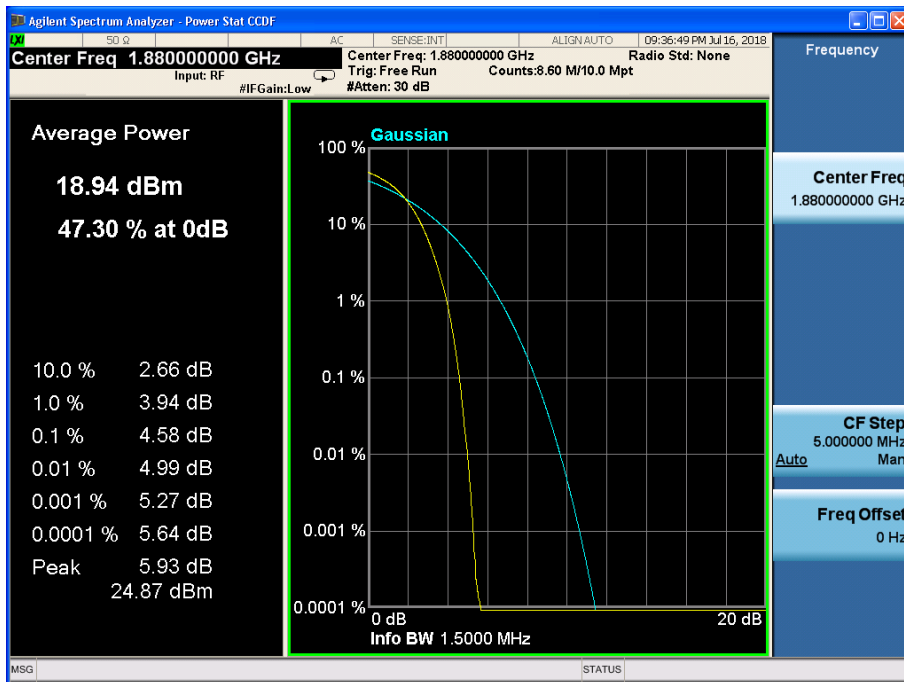

WCDMA band IV

WCDMA Mode:

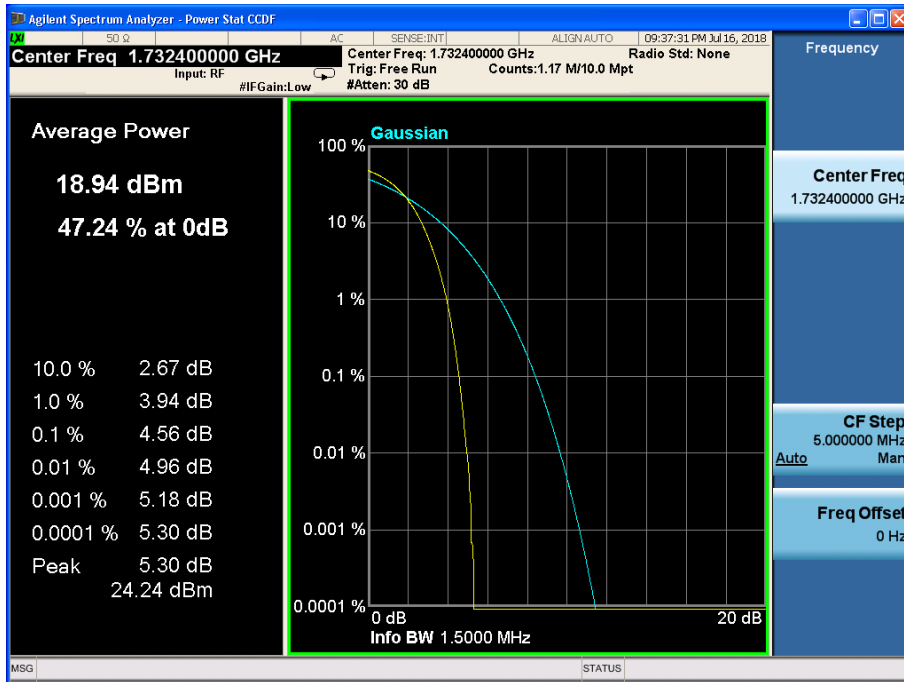

HSDPA/HSUPA Mode:

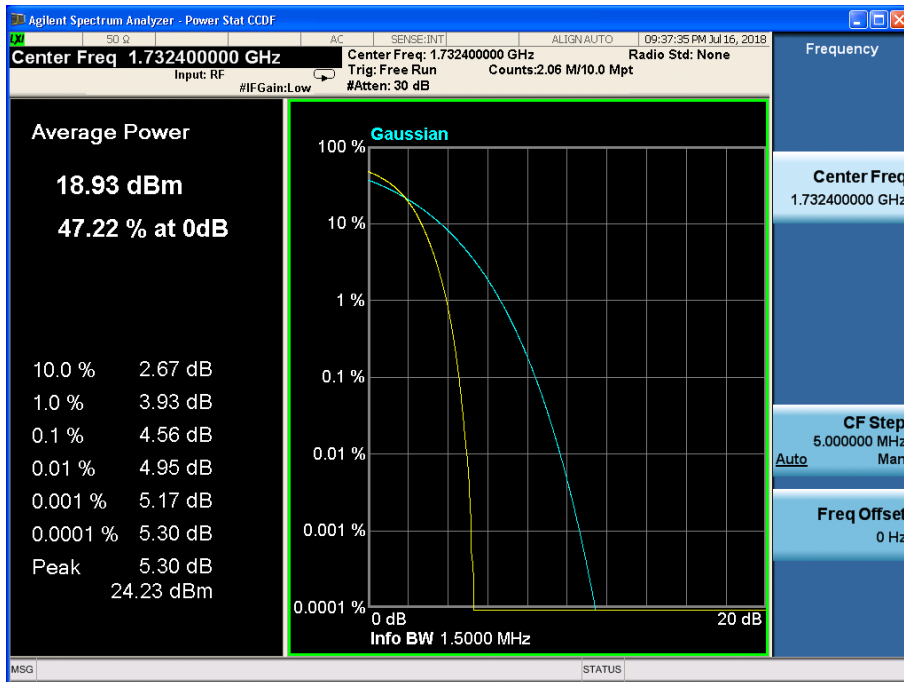

HSPA+ Mode:

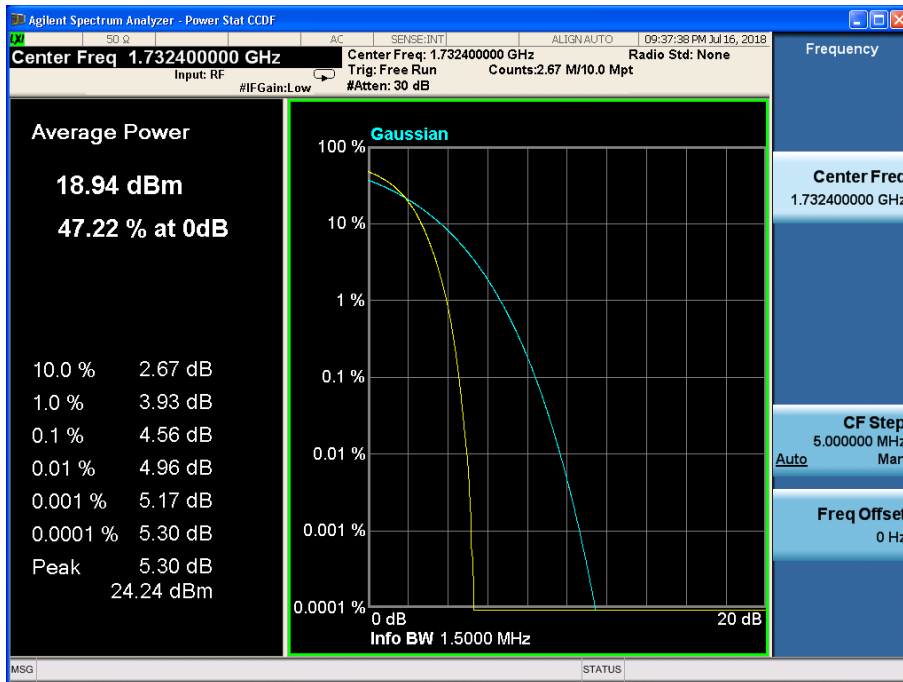

DC-HSDPA Mode:

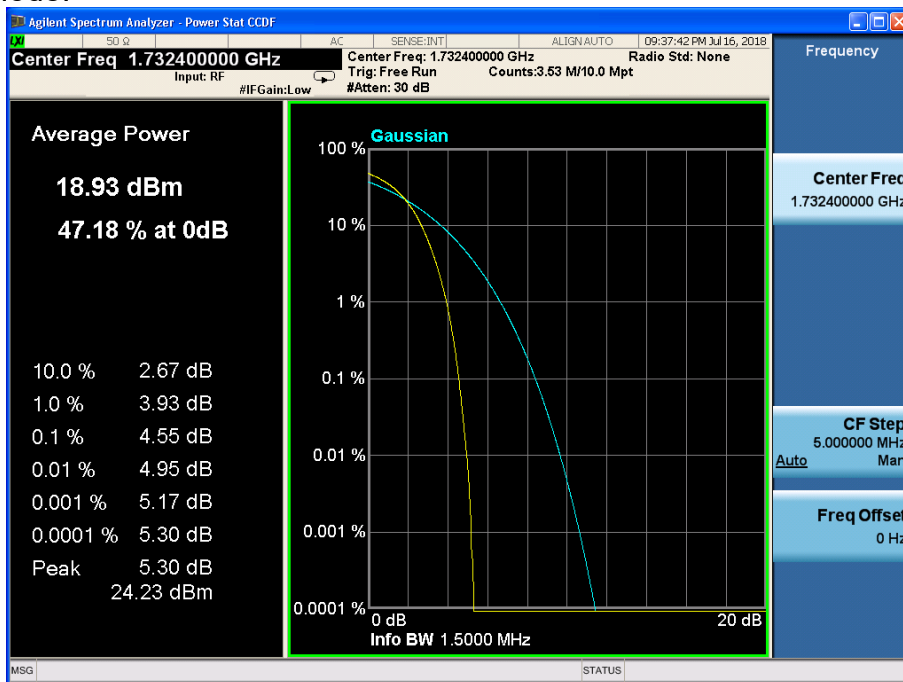

APPENDIX B – TEST DATA OF RADIATED EMISSION

Radiated Spurious Emissions-FCC Part2.1053/24.238

WCDMA band II

WCDMA Mode:
Channel 9262

Frequency (MHz)	Power (dBm)	Limited (dBm)	Polarization
3704.8	-46.32	-13	Vertical
5557.2	-47.44	-13	Vertical
7409.6	-46.39	-13	Vertical
3704.8	-45.90	-13	Horizontal
5557.2	-47.07	-13	Horizontal
7409.6	-45.76	-13	Horizontal

Channel 9400

Frequency (MHz)	Power (dBm)	Limited (dBm)	Polarization
3760	-45.62	-13	Vertical
5640	-46.92	-13	Vertical
7520	-45.95	-13	Vertical
3760	-44.47	-13	Horizontal
5640	-47.16	-13	Horizontal
7520	-45.70	-13	Horizontal

Channel 9538

Frequency (MHz)	Power (dBm)	Limited (dBm)	Polarization
3815.2	-45.68	-13	Vertical
5722.8	-46.30	-13	Vertical
7630.4	-45.29	-13	Vertical
3815.2	-44.73	-13	Horizontal
5722.8	-47.32	-13	Horizontal
7630.4	-46.00	-13	Horizontal

HSDPA/HSUPA Mode:
Channel 9262

Frequency (MHz)	Power (dBm)	Limited (dBm)	Polarization
3704.8	-45.44	-13	Vertical
5557.2	-46.90	-13	Vertical
7409.6	-44.37	-13	Vertical
3704.8	-45.89	-13	Horizontal
5557.2	-47.29	-13	Horizontal
7409.6	-46.03	-13	Horizontal

Channel 9400

Frequency (MHz)	Power (dBm)	Limited (dBm)	Polarization
3760	-45.28	-13	Vertical
5640	-46.31	-13	Vertical
7520	-45.70	-13	Vertical
3760	-44.19	-13	Horizontal
5640	-46.50	-13	Horizontal
7520	-45.79	-13	Horizontal

Channel 9538

Frequency (MHz)	Power (dBm)	Limited (dBm)	Polarization
3815.2	-45.83	-13	Vertical
5722.8	-47.59	-13	Vertical
7630.4	-46.00	-13	Vertical
3815.2	-43.93	-13	Horizontal
5722.8	-47.32	-13	Horizontal
7630.4	-46.48	-13	Horizontal

WCDMA band IV

WCDMA Mode:
Channel 1312

Frequency (MHz)	Power (dBm)	Limited (dBm)	Polarization
3424.8	-46.81	-13	Vertical
5137.2	-47.39	-13	Vertical
6849.6	-45.88	-13	Vertical
3424.8	-46.80	-13	Horizontal
5137.2	-46.24	-13	Horizontal
6849.6	-46.75	-13	Horizontal

Channel 1412

Frequency (MHz)	Power (dBm)	Limited (dBm)	Polarization
3464.8	-46.00	-13	Vertical
5197.2	-46.01	-13	Vertical
6929.6	-46.84	-13	Vertical
3464.8	-46.23	-13	Horizontal
5197.2	-45.84	-13	Horizontal
6929.6	-47.79	-13	Horizontal

Channel 1513

Frequency (MHz)	Power (dBm)	Limited (dBm)	Polarization
3505.2	-46.78	-13	Vertical
5257.8	-45.56	-13	Vertical
7010.4	-46.67	-13	Vertical
3505.2	-46.35	-13	Horizontal
5257.8	-46.40	-13	Horizontal
7010.4	-46.28	-13	Horizontal

HSDPA/HSUPA Mode:
Channel 1312

Frequency (MHz)	Power (dBm)	Limited (dBm)	Polarization
3424.8	-46.87	-13	Vertical
5137.2	-45.74	-13	Vertical
6849.6	-46.91	-13	Vertical
3424.8	-46.49	-13	Horizontal
5137.2	-46.67	-13	Horizontal
6849.6	-47.25	-13	Horizontal

Channel 1412

Frequency (MHz)	Power (dBm)	Limited (dBm)	Polarization
3464.8	-46.48	-13	Vertical
5197.2	-45.72	-13	Vertical
6929.6	-44.97	-13	Vertical
3464.8	-46.14	-13	Horizontal
5197.2	-45.56	-13	Horizontal
6929.6	-46.32	-13	Horizontal

Channel 1513

Frequency (MHz)	Power (dBm)	Limited (dBm)	Polarization
3505.2	-46.60	-13	Vertical
5257.8	-46.26	-13	Vertical
7010.4	-46.10	-13	Vertical
3505.2	-47.60	-13	Horizontal
5257.8	-45.34	-13	Horizontal
7010.4	-46.86	-13	Horizontal

WCDMA band V

WCDMA Mode:
Channel 4132

Frequency (MHz)	Power (dBm)	Limited (dBm)	Polarization
1652.8	-45.37	-13	Vertical
2479.2	-46.97	-13	Vertical
3305.6	-46.24	-13	Vertical
1652.8	-46.35	-13	Horizontal
2479.2	-47.15	-13	Horizontal
3305.6	-45.17	-13	Horizontal

Channel 4183

Frequency (MHz)	Power (dBm)	Limited (dBm)	Polarization
1673.2	-46.04	-13	Vertical
2509.8	-46.78	-13	Vertical
3346.4	-46.00	-13	Vertical
1673.2	-44.32	-13	Horizontal
2509.8	-47.46	-13	Horizontal
3346.4	-46.14	-13	Horizontal

Channel 4233

Frequency (MHz)	Power (dBm)	Limited (dBm)	Polarization
1693.2	-45.98	-13	Vertical
2539.8	-45.51	-13	Vertical
3386.4	-46.29	-13	Vertical
1693.2	-44.36	-13	Horizontal
2539.8	-48.17	-13	Horizontal
3386.4	-46.26	-13	Horizontal

HSDPA/HSUPA Mode:
Channel 4132

Frequency (MHz)	Power (dBm)	Limited (dBm)	Polarization
1652.8	-46.18	-13	Vertical
2479.2	-46.15	-13	Vertical
3305.6	-46.56	-13	Vertical
1652.8	-44.99	-13	Horizontal
2479.2	-47.83	-13	Horizontal
3305.6	-45.39	-13	Horizontal

Channel 4183

Frequency (MHz)	Power (dBm)	Limited (dBm)	Polarization
1673.2	-47.12	-13	Vertical
2509.8	-46.96	-13	Vertical
3346.4	-46.18	-13	Vertical
1673.2	-45.57	-13	Horizontal
2509.8	-47.39	-13	Horizontal
3346.4	-45.67	-13	Horizontal

Channel 4233

Frequency (MHz)	Power (dBm)	Limited (dBm)	Polarization
1693.2	-45.53	-13	Vertical
2539.8	-45.99	-13	Vertical
3386.4	-46.19	-13	Vertical
1693.2	-43.82	-13	Horizontal
2539.8	-47.87	-13	Horizontal
3386.4	-45.61	-13	Horizontal

---End of Test Report---