



MEASUREMENT REPORT

FCC PART 15.247

FCC ID: 2AQVB-T19V0315
APPLICANT: Taisync Technology LLC
Application Type: Certification
Product: 2.4GHz HD Wireless Link
Model No.: WLN210-BM-a, WLN210-BM-b, WLN210-BM-c
Brand Name: TAISYNC
FCC Classification: Digital Transmission System (DTS)
FCC Rule Part(s): Part 15 Subpart C (Section 15.247)
Test Procedure(s): ANSI C63.10-2013, KDB 558074 D01v05r01
Test Date: March 01 ~ March 18, 2019

Reviewed By:

Kevin Guo

(Kevin Guo)

Approved By:

Robin Wu

(Robin Wu)



The test results relate only to the samples tested.

This equipment has been shown to be capable of compliance with the applicable technical standards as indicated in the measurement report and was tested in accordance with the measurement procedures specified in ANSI C63.10-2013. Test results reported herein relate only to the item(s) tested.

The test report shall not be reproduced except in full without the written approval of MRT Technology (Suzhou) Co., Ltd.

Revision History

Report No.	Version	Description	Issue Date	Note
1902RSU015-U1	Rev. 01	Initial Report	03-18-2019	Valid

CONTENTS

Description	Page
§2.1033 General Information	5
1. INTRODUCTION	6
1.1. Scope.....	6
1.2. MRT Test Location.....	6
2. PRODUCT INFORMATION	7
2.1. Feature of Equipment under Test.....	7
2.2. Product Specification Subjective to this Report.....	7
2.3. Working Frequencies for this report.....	7
2.4. Description of Available Antennas.....	8
2.5. Description of Antenna RF Port.....	8
2.6. Test Mode.....	8
2.7. Device Capabilities.....	9
2.8. Test Configuration.....	10
2.9. EMI Suppression Device(s)/Modifications.....	10
2.10. Labeling Requirements.....	10
3. DESCRIPTION of TEST	11
3.1. Evaluation Procedure.....	11
3.2. AC Line Conducted Emissions.....	11
3.3. Radiated Emissions.....	12
4. ANTENNA REQUIREMENTS	13
5. TEST EQUIPMENT CALIBRATION DATE	14
6. MEASUREMENT UNCERTAINTY	16
7. TEST RESULT	17
7.1. Summary.....	17
7.2. 6dB Bandwidth Measurement.....	18
7.2.1. Test Limit.....	18
7.2.2. Test Procedure used.....	18
7.2.3. Test Setting.....	18
7.2.4. Test Setup.....	18
7.2.5. Test Result.....	19
7.3. Output Power Measurement.....	23
7.3.1. Test Limit.....	23
7.3.2. Test Procedure Used.....	23

7.3.3.	Test Setting.....	23
7.3.4.	Test Setup	23
7.3.5.	Test Result.....	24
7.4.	Power Spectral Density Measurement.....	26
7.4.1.	Test Limit	26
7.4.2.	Test Procedure Used	26
7.4.3.	Test Setting.....	26
7.4.4.	Test Setup	27
7.4.5.	Test Result.....	28
7.5.	Conducted Band Edge and Out-of-Band Emissions	32
7.5.1.	Test Limit	32
7.5.2.	Test Procedure Used	32
7.5.3.	Test Setting.....	32
7.5.4.	Test Setup	33
7.5.5.	Test Result.....	34
7.6.	Radiated Spurious Emission Measurement.....	41
7.6.1.	Test Limit	41
7.6.2.	Test Procedure Used	41
7.6.3.	Test Setting.....	41
7.6.4.	Test Setup	43
7.6.5.	Test Result.....	44
7.7.	Radiated Restricted Band Edge Measurement.....	56
7.7.1.	Test Limit	56
7.7.2.	Test Procedure Used	57
7.7.3.	Test Setting.....	57
7.7.4.	Test Setup	58
7.7.5.	Test Result.....	59
7.8.	AC Conducted Emissions Measurement	83
7.8.1.	Test Limit	83
7.8.2.	Test Setup	83
7.8.3.	Test Result.....	84
8.	CONCLUSION	86
	Appendix A – Test Setup Photograph	87
	Appendix B – EUT Photograph.....	88

§2.1033 General Information

Applicant:	Taisync Technology LLC
Applicant Address:	6th floor,75 E. Santa Clara St., San Jose, CA 95113
Manufacturer:	Taisync
Manufacturer Address:	B-702 ,Creative Park, NO.100 dicui road, Binhu District, Wuxi, Jiangsu, China
Test Site:	MRT Technology (Suzhou) Co., Ltd
Test Site Address:	D8 Building, No.2 Tian'edang Rd., Wuzhong Economic Development Zone, Suzhou, China
FCC Registration No.:	893164
Test Device Serial No.:	N/A <input type="checkbox"/> Production <input checked="" type="checkbox"/> Pre-Production <input type="checkbox"/> Engineering

Test Facility / Accreditations

Measurements were performed at MRT Laboratory located in Tian'edang Rd., Suzhou, China.

- MRT facility is a FCC registered (MRT Reg. No. 893164) test facility with the site description report on file and has met all the requirements specified in ANSI C63.4-2014.
- MRT facility is an IC registered (MRT Reg. No. 11384A-1) test laboratory with the site description on file at Industry Canada.
- MRT facility is a VCCI registered (R-20025, G-20034, C-20020, T-20020) test laboratory with the site description on file at VCCI Council.
- MRT Lab is accredited to ISO 17025 by the American Association for Laboratory Accreditation (A2LA) under the American Association for Laboratory Accreditation Program (A2LA Cert. No. 3628.01) in EMC, Telecommunications, Radio and SAR testing.



1. INTRODUCTION

1.1. Scope

Measurement and determination of electromagnetic emissions (EMC) of radio frequency devices including intentional and/or unintentional radiators for compliance with the technical rules and regulations of the Federal Communications Commission and the Industry Canada Certification and Engineering Bureau.

1.2. MRT Test Location

The map below shows the location of the MRT LABORATORY, its proximity to the Taihu Lake. These measurement tests were conducted at the MRT Technology (Suzhou) Co., Ltd. Facility located at D8 Building, No.2 Tian'edang Rd., Wuzhong Economic Development Zone, Suzhou, China. The measurement facility compliant with the test site requirements specified in ANSI C63.4-2014.



2. PRODUCT INFORMATION

2.1. Feature of Equipment under Test

Product Name:	2.4GHz HD Wireless Link
Model No.:	WLN210-BM-a, WLN210-BM-b, WLN210-BM-c
Brand Name:	TAISYNC
RF Specification:	2.4GHz
Working Voltage:	DC 5V

Note 1: These models are different in the shape of their shielding enclosures, which are used to accommodate different mounting configurations. The material and PCBA are the same.

Note 2: Due to 3 models have the same shielding cavity, and the more similar shape between WLN210-BM-a and WLN210-BM-b, so we select WLN210-BM-a for all tests and verify RSE & Bandedge test of one channel for WLN210-BM-c according to WLN210-BM-a's test result in this report.

2.2. Product Specification Subjective to this Report



RF Specification (2.4GHz)	
Frequency Range:	2412 ~ 2472 MHz
Type of Modulation:	OFDM
Channel Bandwidth	2.5MHz / 10MHz
Data Rate:	Bandwidth 2.5MHz: 115200kbps Bandwidth 10MHz: 2.3 Mbps ~12Mbps

2.3. Working Frequencies for this report

2.4G 2.5MHz/10MHz

Channel	Frequency	Channel	Frequency	Channel	Frequency
01	2412 MHz	02	2417 MHz	03	2422 MHz
04	2427 MHz	05	2432 MHz	06	2437 MHz
07	2442 MHz	08	2447 MHz	09	2452 MHz
10	2457 MHz	11	2462 MHz	12	2467 MHz
13	2472 MHz	--	--	--	--

2.4. Description of Available Antennas

Antenna	Manufacturer	Frequency Band (GHz)	Antenna Name	Tx Paths
	saixun	2.4	RP-SMA Antenna	1Tx + 1Rx
	airgain	2.4	PCB Antenna	1Tx + 1Rx

Antenna Name	Frequency Band (GHz)	TX Paths	Max Peak Gain (dBi)
RP-SMA Antenna (Ant 1)	2.4 ~ 2.5	1	5.0
PCB Antenna (Ant 2)	2.4 ~ 2.5	1	2.0

Note: The device can only use the Ant 1 When it is working at 2.5MHz Bandwidth. This caution will be described in Operational description and User manual of this device by manufacturer.

2.5. Description of Antenna RF Port

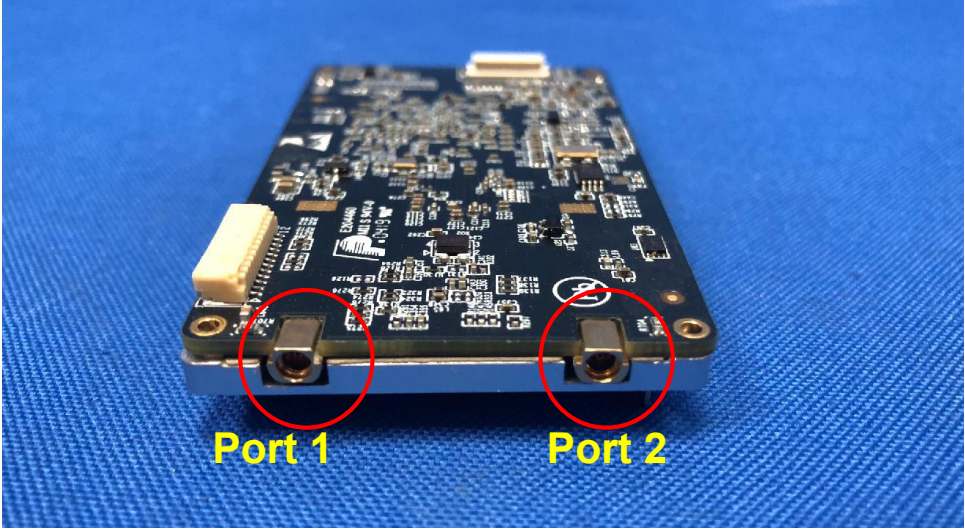
Software Control Port	2.4GHz RF Port	
	Port 1	Port 2
		
<p>Note: For current device can use port 1 only, port 2 is reserved for upgrade version.</p>		

2.6. Test Mode

Test Mode	Mode 1: Transmit by Bandwidth 10MHz (2.3Mbps)
	Mode 2: Transmit by Bandwidth 2.5MHz (115200kbps)

2.7. Device Capabilities

This device contains the following capabilities:

2.4G Radio frequency with 10MHz and 2.5MHz Bandwidth.

The maximum achievable duty cycles for all modes were determined based on measurements performed on a spectrum analyzer in zero-span mode with RBW = 8MHz, VBW = 50MHz, and detector = peak. The RBW and VBW were both greater than 50/T, where T is the minimum transmission duration, and the number of sweep points across T was greater than 100. The duty cycles are as follows:

Test Mode / Bandwidth	Duty Cycle
10MHz	99.01 %
2.5MHz	91.40 %

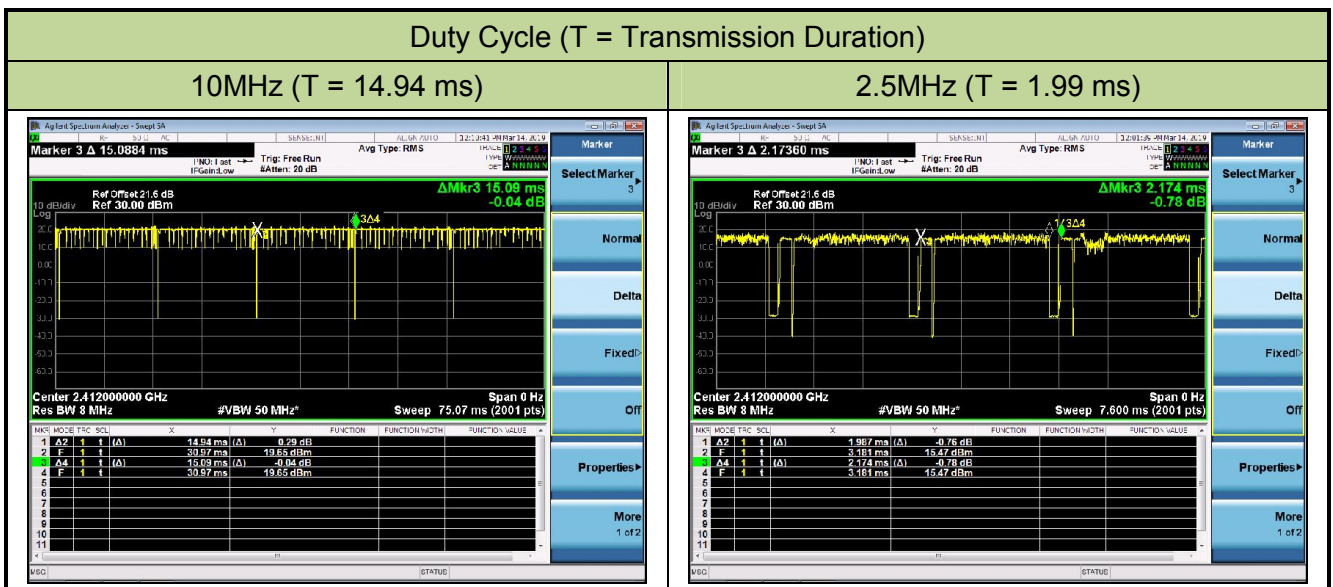

2.8. Test Configuration

The device was tested per the guidance of ANSI C63.10-2013. ANSI C63.10-2013 was used to reference the appropriate EUT setup for radiated spurious emissions testing and AC line conducted testing.

2.9. EMI Suppression Device(s)/Modifications

No EMI suppression device(s) were added and/or no modifications were made during testing.

2.10. Labeling Requirements

Per 2.1074 & 15.19; Docket 95-19

The label shall be permanently affixed at a conspicuous location on the device; instruction manual or pamphlet supplied to the user and be readily visible to the purchaser at the time of purchase. However, when the device is so small wherein placement of the label with specified statement is not practical, only the FCC ID must be displayed on the device per Section 15.19(a)(5). Please see attachment for FCC ID label and label location.

3. DESCRIPTION of TEST

3.1. Evaluation Procedure

The measurement procedures described in the American National Standard for Testing Unlicensed Wireless Devices (ANSI C63.10-2013), and the guidance was used in the measurement of the device.

Deviation from measurement procedure.....None

3.2. AC Line Conducted Emissions

The line-conducted facility is located inside an 8'x4'x4' shielded enclosure. A 1m x 2m wooden table 80cm high is placed 40cm away from the vertical wall and 80cm away from the sidewall of the shielded room. Two 10kHz-30MHz, 50Ω/50uH Line-Impedance Stabilization Networks (LISNs) are bonded to the shielded room floor. Power to the LISNs is filtered by external high-current high-insertion loss power line filters. These filters attenuate ambient signal noise from entering the measurement lines. These filters are also bonded to the shielded enclosure.

The EUT is powered from one LISN and the support equipment is powered from the second LISN. All interconnecting cables more than 1 meter were shortened to a 1 meter length by non-inductive bundling (serpentine fashion) and draped over the back edge of the test table. All cables were at least 40cm above the horizontal reference ground-plane. Power cables for support equipment were routed down to the second LISN while ensuring that that cables were not draped over the second LISN.

Sufficient time for the EUT, support equipment, and test equipment was allowed in order for them to warm up to their normal operating condition. The RF output of the LISN was connected to the receiver and exploratory measurements were made to determine the frequencies producing the maximum emission from the EUT. The receiver was scanned from 150kHz to 30MHz. The detector function was set to peak mode for exploratory measurements while the bandwidth of the analyzer was set to 9kHz. The EUT, support equipment, and interconnecting cables were arranged and manipulated to maximize each emission. Each emission was also maximized by varying: power lines, the mode of operation or data exchange speed, or support equipment whichever determined the worst-case emission. Once the worst case emissions have been identified, the one EUT cable configuration/arrangement and mode of operation that produced these emissions are used for final measurements on the same test site. The analyzer is set to CISPR quasi-peak and average detectors with a 9kHz resolution bandwidth for final measurements.

An extension cord was used to connect to a single LISN which powered by EUT. The extension cord was calibrated with LISN, the impedance and insertion loss are compliance with the requirements as stated in ANSI C63.10-2013.

3.3. Radiated Emissions

The radiated test facilities consisted of an indoor 3 meter semi-anechoic chamber used for final measurements and exploratory measurements, when necessary. The measurement area is contained within the semi-anechoic chamber which is shielded from any ambient interference. For measurements above 1GHz absorbers are arranged on the floor between the turn table and the antenna mast in such a way so as to maximize the reduction of reflections. For measurements below 1GHz, the absorbers are removed. A MF Model 210SS turntable is used for radiated measurement. It is a continuously rotatable, remote controlled, metallic turntable and 2 meters (6.56 ft.) in diameter. The turn table is flush with the raised floor of the chamber in order to maintain its function as a ground plane. An 80cm high PVC support structure is placed on top of the turntable.

For all measurements, the spectrum was scanned through all EUT azimuths and from 1 to 4 meter receive antenna height using a broadband antenna from 30MHz up to the upper frequency shown in 15.33(b)(1) depending on the highest frequency generated or used in the device or on which the device operates or tunes. For frequencies above 1GHz, linearly polarized double ridge horn antennas were used. For frequencies below 30MHz, a calibrated loop antenna was used. When exploratory measurements were necessary, they were performed at 1 meter test distance inside the semi-anechoic chamber using broadband antennas, broadband amplifiers, and spectrum analyzers to determine the frequencies and modes producing the maximum emissions. Sufficient time for the EUT, support equipment, and test equipment was allowed in order for them to warm up to their normal operating condition. The test set-up for frequencies below 1GHz was placed on top of the 0.8 meter high, 1 x 1.5 meter table; and test set-up for frequencies 1-40GHz was placed on top of the 1.5 meter high, 1 x 1.5 meter table. The EUT, support equipment, and interconnecting cables were arranged and manipulated to maximize each emission. Appropriate precaution was taken to ensure that all emissions from the EUT were maximized and investigated. The system configuration, clock speed, mode of operation or video resolution, if applicable, turntable azimuth, and receive antenna height was noted for each frequency found.

Final measurements were made in the semi-anechoic chamber using calibrated, linearly polarized broadband and horn antennas. The test setup was configured to the setup that produced the worst case emissions. The spectrum analyzer was set to investigate all frequencies required for testing to compare the highest radiated disturbances with respect to the specified limits. The turntable containing the EUT was rotated through 360 degrees and the height of the receive antenna was varied 1 to 4 meters and stopped at the azimuth and height producing the maximum emission. Each emission was maximized by changing the orientation of the EUT through three orthogonal planes and changing the polarity of the receive antenna, whichever produced the worst-case emissions. According to 3dB Beam-Width of horn antenna, the horn antenna should be always directed to the EUT when rising height.

4. ANTENNA REQUIREMENTS

Excerpt from §15.203 of the FCC Rules/Regulations:

“An intentional radiator antenna shall be designed to ensure that no antenna other than that furnished by the responsible party can be used with the device. The use of a permanently attached antenna or of an antenna that uses a unique coupling to the intentional radiator shall be considered sufficient to comply with the provisions of this section.”

- There are provisions for special connector (MMCX PLUG connector) to an external antenna.

Conclusion:

The device unit complies with the requirement of §15.203.

5. TEST EQUIPMENT CALIBRATION DATE

Conducted Emissions - SR2

Instrument	Manufacturer	Type No.	Asset No.	Cali. Interval	Cali. Due Date
EMI Test Receiver	R&S	ESR3	MRTSUE06185	1 year	2019/04/20
Two-Line V-Network	R&S	ENV216	MRTSUE06002	1 year	2019/06/15
Two-Line V-Network	R&S	ENV216	MRTSUE06003	1 year	2019/06/15
Temperature/Humidity Meter	Testo	608-H1	MRTSUE06404	1 year	2019/08/14
Shielding Anechoic Chamber	Mikebang	Chamber-SR2	MRTSUE06214	1 year	2019/05/10

Radiated Disturbance – AC1

Instrument	Manufacturer	Type No.	Asset No.	Cali. Interval	Cali. Due Date
Spectrum Analyzer	Keysight	N9030B	MRTSUE06395	1 year	2019/09/30
EMI Test Receiver	R&S	ESR7	MRTSUE06001	1 year	2019/08/18
Loop Antenna	Schwarzbeck	FMZB 1519	MRTSUE06025	1 year	2019/11/20
Bilog Period Antenna	Schwarzbeck	VULB 9168	MRTSUE06172	1 year	2019/04/12
Horn Antenna	Schwarzbeck	BBHA9120D	MRTSUE06023	1 year	2019/10/21
Broadband Horn Antenna	Schwarzbeck	BBHA9170	MRTSUE06024	1 year	2019/12/14
Microwave System Amplifier	Agilent	83017A	MRTSUE06076	1 year	2019/11/17
Preamplifier	Schwarzbeck	BBV 9721	MRTSUE06121	1 year	2019/06/13
Temperature/Humidity Meter	Testo	608-H1	MRTSUE06403	1 year	2019/08/14
Anechoic Chamber	TDK	Chamber-AC1	MRTSUE06212	1 year	2019/05/02

Radiated Emissions - AC2

Instrument	Manufacturer	Type No.	Asset No.	Cali. Interval	Cali. Due Date
Spectrum Analyzer	Keysight	N9038A	MRTSUE06125	1 year	2019/08/14
Loop Antenna	Schwarzbeck	FMZB 1519	MRTSUE06025	1 year	2019/11/09
Bilog Period Antenna	Schwarzbeck	VULB 9162	MRTSUE06022	1 year	2019/10/20
Horn Antenna	Schwarzbeck	BBHA9120D	MRTSUE06171	1 year	2019/11/09
Broadband Horn Antenna	Schwarzbeck	BBHA9170	MRTSUE06024	1 year	2019/12/17
Broadband Coaxial Preamplifier	Schwarzbeck	BBV 9718	MRTSUE06176	1 year	2019/11/16
Preamplifier	Schwarzbeck	BBV 9721	MRTSUE06121	1 year	2019/06/13
Temperature/Humidity Meter	Minggao	ETH529	MRTSUE06170	1 year	2019/12/13
Anechoic Chamber	RIKEN	Chamber-AC2	MRTSUE06213	1 year	2019/05/02

Conducted Test Equipment - TR3

Instrument	Manufacturer	Type No.	Asset No.	Cali. Interval	Cali. Due Date
Spectrum Analyzer	Agilent	N9020A	MRTSUE06106	1 year	2019/04/20
Power Meter	Agilent	U2021XA	MRTSUE06030	1 year	2019/12/06
Temperature&Humidity Chamber	BAOYT	BYH-150CL	MRTSUE06051	1 year	2019/12/06
Temperature/Humidity Meter	Testo	608-H1	MRTSUE06401	1 year	2019/11/21

Software	Version	Function
e3	V8.3.5	EMI Test Software

6. MEASUREMENT UNCERTAINTY

Where relevant, the following test uncertainty levels have been estimated for tests performed on the EUT as specified in CISPR 16-4-2. This uncertainty represents an expanded uncertainty expressed at approximately the 95% confidence level using a coverage factor of $k = 2$.

AC Conducted Emission Measurement - SR2
Measuring Uncertainty for a Level of Confidence of 95% ($U=2Uc(y)$): 150kHz~30MHz: $\pm 3.46\text{dB}$
Radiated Emission Measurement – AC1
Measuring Uncertainty for a Level of Confidence of 95% ($U=2Uc(y)$): 9kHz ~ 1GHz: $\pm 4.18\text{dB}$ 1GHz ~ 25GHz: $\pm 4.76\text{dB}$
Radiated Emission Measurement – AC2
Measuring Uncertainty for a Level of Confidence of 95% ($U=2Uc(y)$): 9kHz ~ 1GHz: 3.86dB 1GHz ~ 25GHz: 4.33dB
Spurious Emissions, Conducted - TR3
Measuring Uncertainty for a Level of Confidence of 95% ($U=2Uc(y)$): 0.78dB
Output Power - TR3
Measuring Uncertainty for a Level of Confidence of 95% ($U=2Uc(y)$): 1.13dB
Power Spectrum Density - TR3
Measuring Uncertainty for a Level of Confidence of 95% ($U=2Uc(y)$): 1.15dB
Occupied Bandwidth - TR3
Measuring Uncertainty for a Level of Confidence of 95% ($U=2Uc(y)$): 0.28%

7. TEST RESULT

7.1. Summary

Company Name: Taisync Technology LLC

FCC ID: 2AQVB-T19V0315

FCC Part Section(s)	Test Description	Test Limit	Test Condition	Test Result	Reference
15.247(a)(2)	6dB Bandwidth	$\geq 500\text{kHz}$	Conducted	Pass	Section 7.2
15.247(b)(3)	Output Power	$\leq 1\text{ Watt}$		Pass	Section 7.3
15.247(e)	Power Spectral Density	$\leq 8\text{ dBm} / 3\text{kHz}$		Pass	Section 7.4
15.247(d)	Band Edge / Out-of-Band Emissions	$\leq 30\text{dBc (Average)}$		Pass	Section 7.5
15.205 15.209	General Field Strength Limits (Restricted Bands and Radiated Emission Limits)	Emissions in restricted bands must meet the radiated limits detailed in 15.209	Radiated	Pass	Section 7.6 & 7.7
15.207	AC Conducted Emissions 150kHz - 30MHz	< FCC 15.207 limits	Line Conducted	Pass	Section 7.8

Notes:

- 1) All modes of operation and data rates were investigated. For radiated emission test, every axis (X, Y, Z) was also verified. The test results shown in the following sections represent the worst case emissions.
- 2) The analyzer plots shown in this section were all taken with a correction table loaded into the analyzer. The correction table was used to account for the losses of the cables and attenuators used as part of the system to connect the EUT to the analyzer at all frequencies of interest.
- 3) All channels that reduced power are verified in the band-edge testing, but we reported worst channel data only.

7.2. 6dB Bandwidth Measurement

7.2.1. Test Limit

The minimum 6dB bandwidth shall be at least 500 kHz.

7.2.2. Test Procedure used

ANSI C63.10-2013 Section 11.8

7.2.3. Test Setting

1. The Spectrum's automatic bandwidth measurement capability was used to perform the 6dB bandwidth measurement. The "X" dB bandwidth parameter was set to $X = 6$. The bandwidth measurement was not influenced by any intermediate power nulls in the fundamental emission.
2. Set RBW = 100 kHz
3. VBW $\geq 3 \times$ RBW
4. Detector = Peak
5. Trace mode = max hold
6. Sweep = auto couple
7. Allow the trace was allowed to stabilize

7.2.4. Test Setup

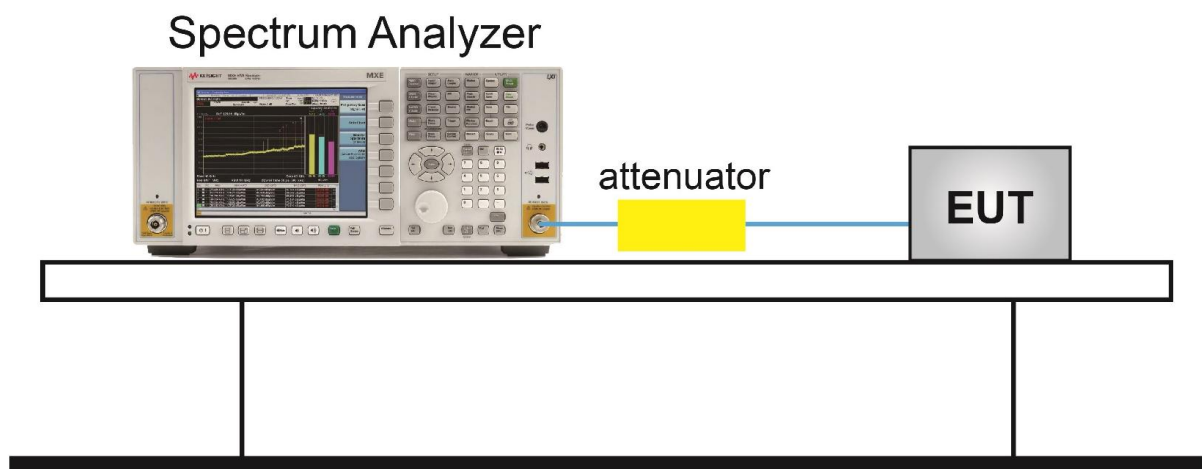

7.2.5. Test Result

Product	2.4GHz HD Wireless Link	Temperature	25°C
Test Engineer	Snake Ni	Relative Humidity	52%
Test Site	TR3	Test Date	2019/03/13

Test Mode / Bandwidth	Data Rate	Channel No.	Frequency (MHz)	6dB Bandwidth (MHz)	Limit (MHz)	Result
Ant 1						
10MHz	2.3Mbps	01	2412	9.11	≥ 0.5	Pass
10MHz	2.3Mbps	07	2442	9.08	≥ 0.5	Pass
10MHz	2.3Mbps	13	2472	9.05	≥ 0.5	Pass
2.5MHz	115200kbps	01	2412	2.27	≥ 0.5	Pass
2.5MHz	115200kbps	07	2442	2.28	≥ 0.5	Pass
2.5MHz	115200kbps	13	2472	2.28	≥ 0.5	Pass
Ant 2						
10MHz	2.3Mbps	01	2412	9.10	≥ 0.5	Pass
10MHz	2.3Mbps	07	2442	9.11	≥ 0.5	Pass
10MHz	2.3Mbps	13	2472	9.04	≥ 0.5	Pass

10MHz 6dB Bandwidth - Ant 1

Channel 01 (2412MHz)

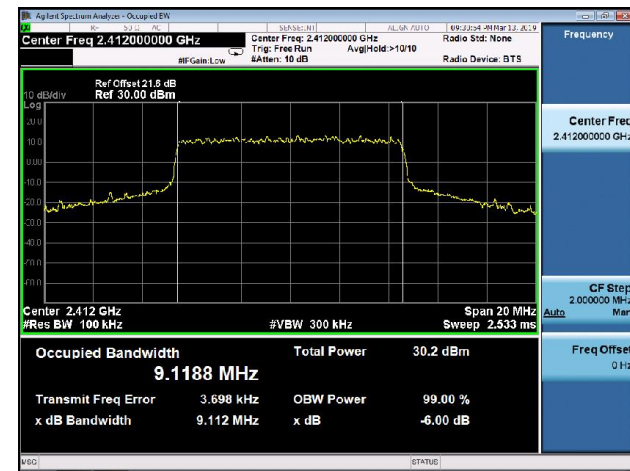

Channel 07 (2442MHz)

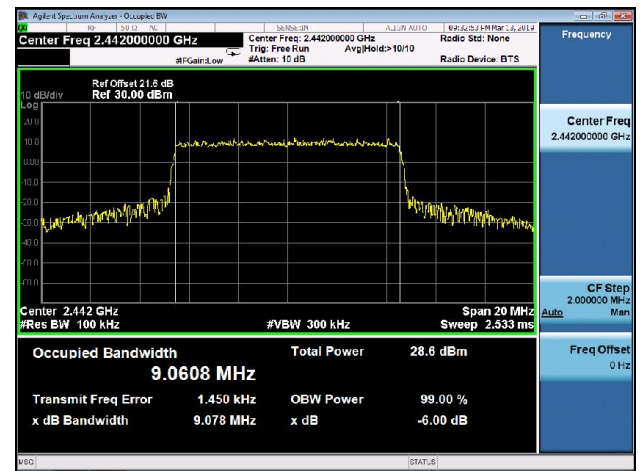

Channel 13 (2472MHz)



--

--

2.5MHz 6dB Bandwidth - Ant 1

Channel 01 (2412MHz)

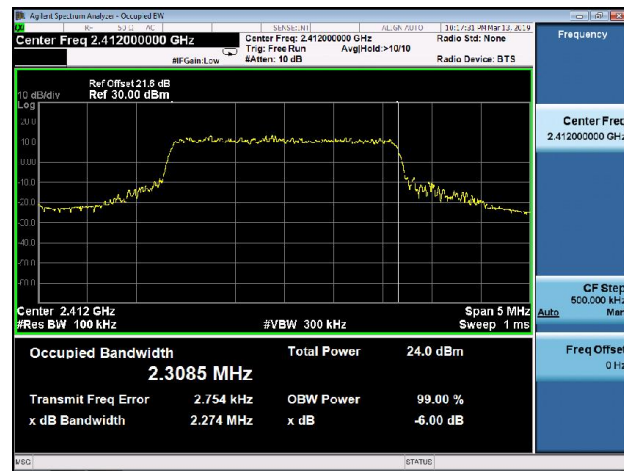

Channel 07 (2442MHz)

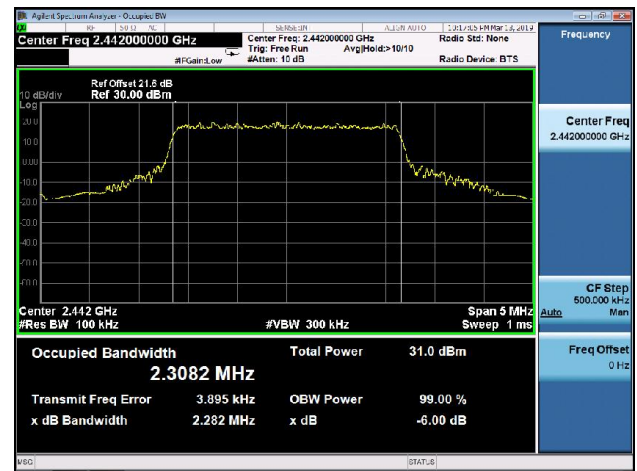

Channel 13 (2472MHz)

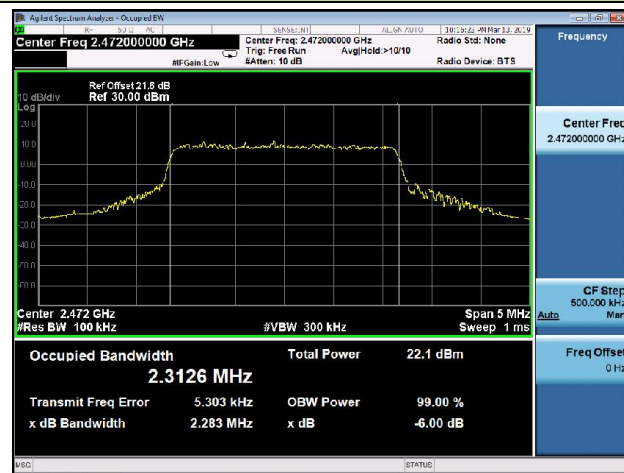

--

--

10MHz 6dB Bandwidth - Ant 2

Channel 01 (2412MHz)

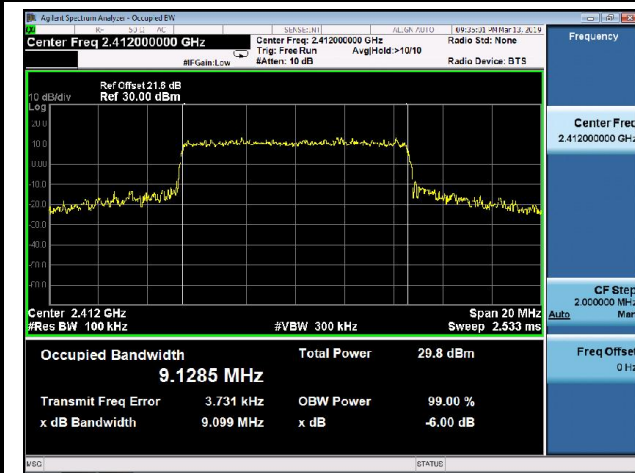

Channel 07 (2442MHz)

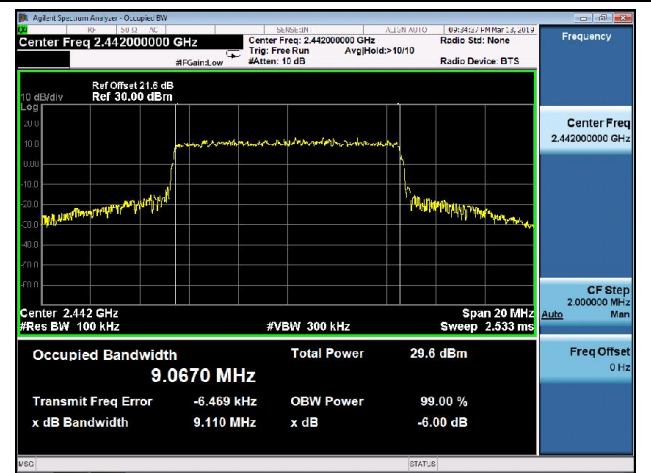

Channel 13 (2472MHz)

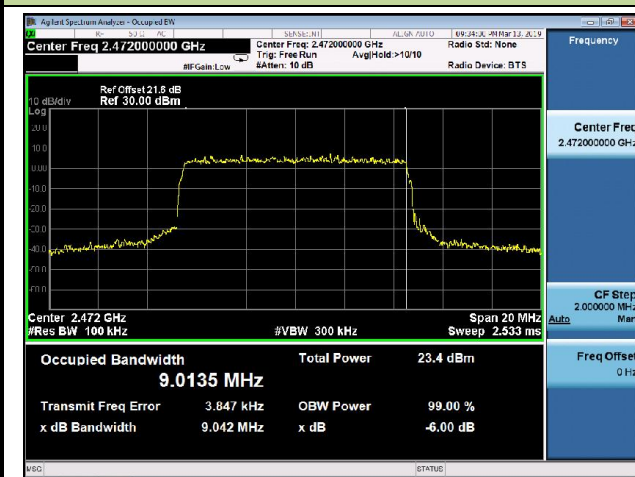

--

--

7.3. Output Power Measurement

7.3.1. Test Limit

The maximum out power shall be less 1 Watt (30dBm).

The conducted output power limit specified in paragraph FCC Part 15.247(b) of this section is based on the use of antennas with directional gains that do not exceed 6 dBi. If transmitting antennas of directional gain greater than 6 dBi are used, the conducted output power from the intentional radiator shall be reduced below the stated values in paragraphs FCC Part 15.247(b)(3) of this section, as appropriate, by the amount in dB that the directional gain of the antenna exceeds 6 dBi.

7.3.2. Test Procedure Used

ANSI C63.10 Section 11.9.2.3.2

7.3.3. Test Setting

Average Power Measurement

Average power measurements were perform only when the EUT was transmitting at its maximum power control level using a broadband power meter with a pulse sensor. The power meter implemented triggering and gating capabilities which were set up such that power measurements were recorded only during the ON time of the transmitter.

7.3.4. Test Setup

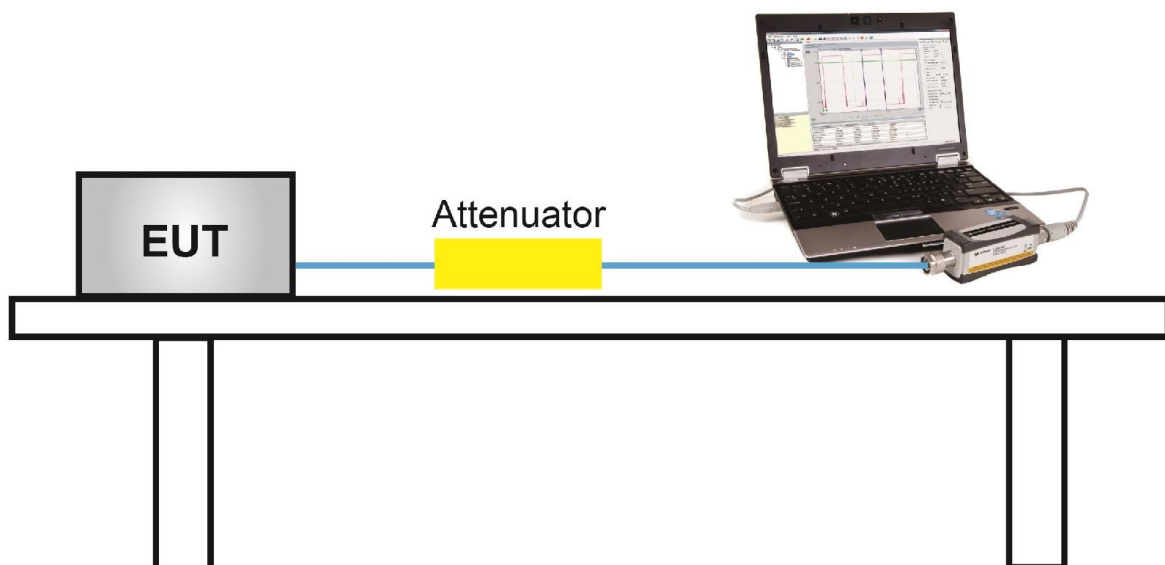

7.3.5. Test Result

Power output test was verified over all data rates of each mode shown as below, and then choose the maximum power output (Gray marker) for final test of each channel.

Ant 1 Output power at various data rates:

Test Mode / Bandwidth	Channel No.	Frequency (MHz)	Data Rate	Average Power (dBm)
10MHz	7	2442	2.3 Mbps	20.77
			6.94 Mbps	20.69
			12 Mbps	20.62
2.5MHz	7	2442	115200kbps	21.51
			--	--
			--	--

Product	2.4GHz HD Wireless Link	Temperature	23°C
Test Engineer	Snake Ni	Relative Humidity	51%
Test Site	TR3	Test Date	2019/03/13

Test Mode / Bandwidth	Data Rate	Channel No.	Freq. (MHz)	Average Power (dBm)	Limit (dBm)	Result
Ant 1						
10MHz	2.3Mbps	1	2412	20.65	≤ 30.00	Pass
	2.3Mbps	7	2442	20.77	≤ 30.00	Pass
	2.3Mbps	12	2467	20.01	≤ 30.00	Pass
	2.3Mbps	13	2472	16.63	≤ 30.00	Pass
2.5MHz	115200kbps	1	2412	15.18	≤ 30.00	Pass
	115200kbps	7	2442	21.51	≤ 30.00	Pass
	115200kbps	12	2467	13.70	≤ 30.00	Pass
	115200kbps	13	2472	12.14	≤ 30.00	Pass
Ant 2						
10MHz	2.3Mbps	1	2412	21.35	≤ 30.00	Pass
	2.3Mbps	7	2442	22.03	≤ 30.00	Pass
	2.3Mbps	12	2467	16.45	≤ 30.00	Pass
	2.3Mbps	13	2472	14.69	≤ 30.00	Pass

7.4. Power Spectral Density Measurement

7.4.1. Test Limit

The maximum permissible power spectral density is 8dBm in any 3 kHz band.

The same method of determining the conducted output power shall be used to determine the power spectral density.

7.4.2. Test Procedure Used

ANSI C63.10 Section 11.10.5

7.4.3. Test Setting

1. Measure the duty cycle (x) of the transmitter output signal.
2. Set instrument center frequency to DTS channel center frequency.
3. Set span to at least 1.5 times the OBW.
4. RBW = 10 kHz.
5. VBW = 30 kHz.
6. Detector = RMS.
7. Ensure that the number of measurement points in the sweep $\geq 2 \times \text{span}/\text{RBW}$.
8. Sweep time = auto couple.
9. Don't use sweep triggering. Allow sweep to "free run".
10. Employ trace averaging (RMS) mode over a minimum of 100 traces.
11. Use the peak marker function to determine the maximum amplitude level.
12. Add $10 \log (1/x)$, where x is the duty cycle measured in step (a), to the measured PSD to compute the average PSD during the actual transmission time.

7.4.4. Test Setup

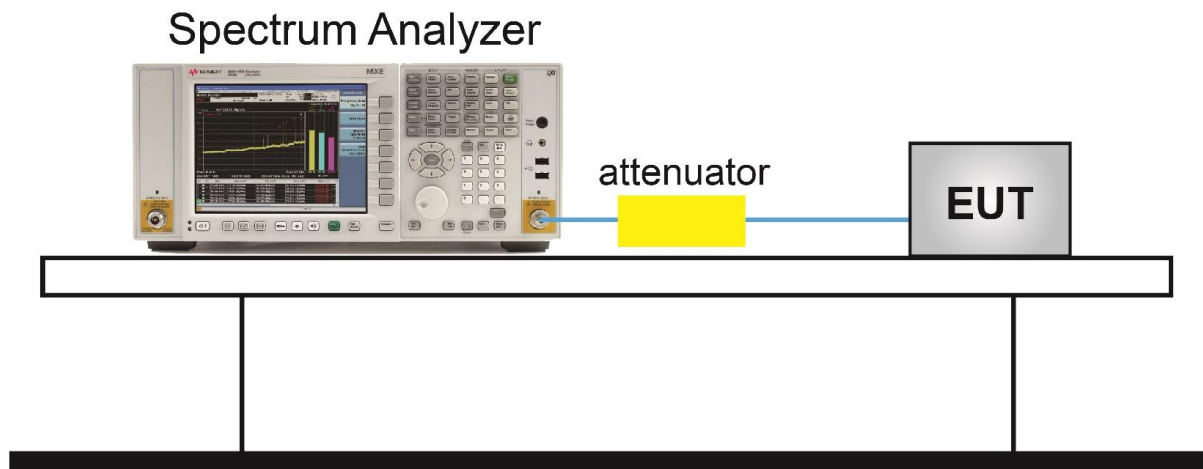

7.4.5. Test Result

Product	2.4GHz HD Wireless Link	Temperature	23°C
Test Engineer	Snake Ni	Relative Humidity	52%
Test Site	TR3	Test Date	2019/03/13

Test Mode	Data Rate	Channel No.	Freq. (MHz)	AVGPSD (dBm / 10kHz)	Duty Cycle (%)	Final AVGPSD (dBm / 3kHz)	Limit (dBm / 3kHz)	Result
Ant 1								
10MHz	2.3Mbps	1	2412	-4.31	99.01	-9.54	≤ 8.00	Pass
	2.3Mbps	7	2442	-4.77	99.01	-10.00	≤ 8.00	Pass
	2.3Mbps	13	2472	-7.54	99.01	-12.77	≤ 8.00	Pass
2.5MHz	115200 kbps	1	2412	-5.02	91.40	-9.86	≤ 8.00	Pass
	115200 kbps	7	2442	1.50	91.40	-3.34	≤ 8.00	Pass
	115200 kbps	13	2472	-7.89	91.40	-12.73	≤ 8.00	Pass
Ant 2								
10MHz	2.3Mbps	1	2412	-3.36	99.01	-8.59	≤ 8.00	Pass
	2.3Mbps	7	2442	-4.29	99.01	-9.52	≤ 8.00	Pass
	2.3Mbps	13	2472	-9.32	99.01	-14.55	≤ 8.00	Pass

Note: When EUT duty cycle < 98%, Final AVGPSD (dBm / 3kHz) = AVGPSD + 10*log (1/Duty Cycle).
 When EUT duty cycle ≥ 98%, Final AVGPSD (dBm / 3kHz) = AVGPSD.

10MHz PSD - Ant 1

Channel 01 (2412MHz)

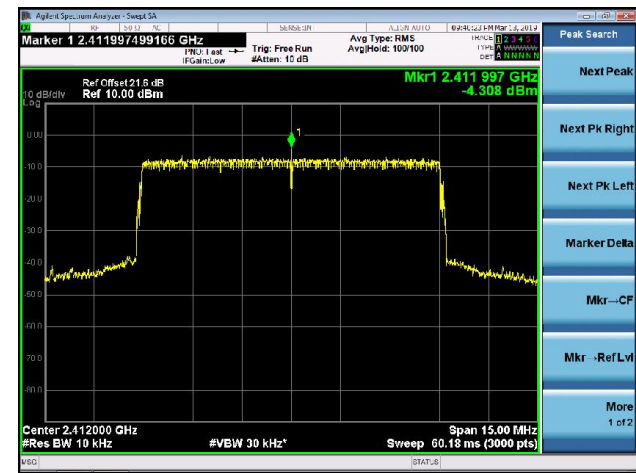

Channel 07 (2442MHz)



Channel 13 (2472MHz)

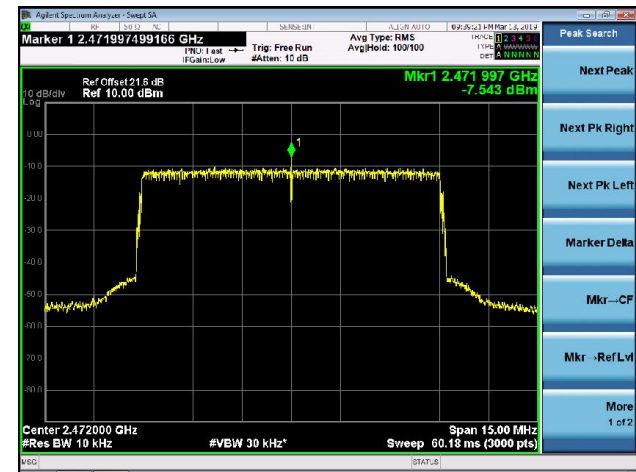

--

--

2.5MHz PSD-Ant 1

Channel 01 (2412MHz)



Channel 07 (2442MHz)



Channel 13 (2472MHz)



--

--

10MHz PSD-Ant 2

Channel 01 (2412MHz)



Channel 07 (2442MHz)



Channel 13 (2472MHz)

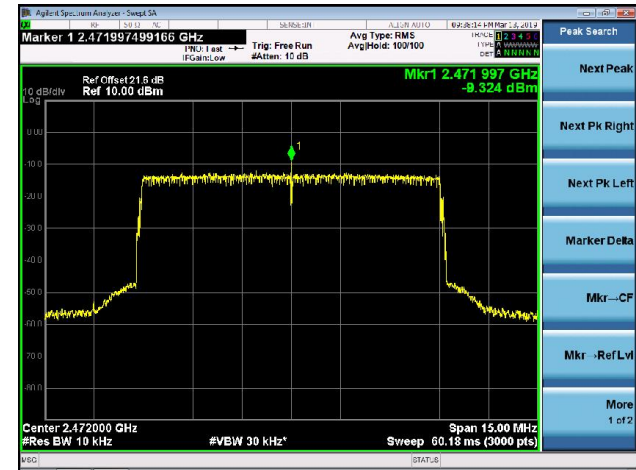

--

--

7.5. Conducted Band Edge and Out-of-Band Emissions

7.5.1. Test Limit

The limit for out-of-band spurious emissions at the band edge is 30dB below the fundamental emission level, as determined from the in-band power measurement of the DTS channel performed in a 100 kHz bandwidth per the PSD procedure.

7.5.2. Test Procedure Used

ANSI C63.10 Section 11.11

7.5.3. Test Setting

Reference level measurement

1. Set instrument center frequency to DTS channel center frequency
2. Set the span to ≥ 1.5 times the DTS bandwidth
3. Set the RBW = 100 kHz
4. Set the VBW $\geq 3 \times$ RBW
5. Detector = peak
6. Sweep time = auto couple
7. Trace mode = max hold
8. Allow trace to fully stabilize

Emission level measurement

1. Set the center frequency and span to encompass frequency range to be measured
2. RBW = 100kHz
3. VBW = 300kHz
4. Detector = Peak
5. Trace mode = max hold
6. Sweep time = auto couple
7. The trace was allowed to stabilize

Test Notes

1. RBW was set to 1.3MHz rather than 100 kHz in order to increase the measurement speed.
2. The display line shown in the following plots denotes the limit at 30dB below the fundamental emission level measured in a 100 kHz bandwidth. However, since the traces in the following plots are measured with a 1.3MHz RBW, the display line may not necessarily appear to be 30dB below the level of the fundamental in a 1.3MHz bandwidth.
3. For plots showing conducted spurious emissions near the limit, the frequencies were investigated with a reduced RBW to ensure that no emissions were present

7.5.4. Test Setup

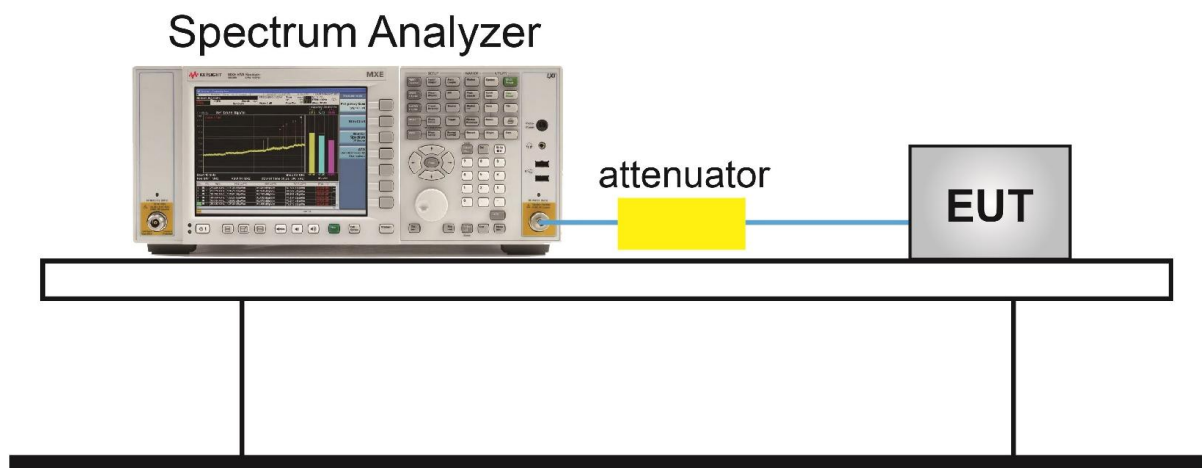

7.5.5. Test Result

Product	2.4GHz HD Wireless Link	Temperature	23°C
Test Engineer	Snake Ni	Relative Humidity	52%
Test Site	TR3	Test Date	2019/03/13

Test Mode / Bandwidth	Data Rate	Channel No.	Frequency (MHz)	Limit	Result
Ant 1					
10MHz	2.3Mbps	01	2412	30dBc	Pass
10MHz	2.3Mbps	07	2442	30dBc	Pass
10MHz	2.3Mbps	13	2472	30dBc	Pass
2.5MHz	115200kbps	01	2412	30dBc	Pass
2.5MHz	115200kbps	07	2442	30dBc	Pass
2.5MHz	115200kbps	13	2472	30dBc	Pass
Ant 2					
10MHz	2.3Mbps	01	2412	30dBc	Pass
10MHz	2.3Mbps	07	2442	30dBc	Pass
10MHz	2.3Mbps	13	2472	30dBc	Pass

10MHz Out-of-Band Emissions - Ant 1

Channel 01 (2412MHz)

100kHz PSD reference Level



Low Band Edge



Spurious Emission

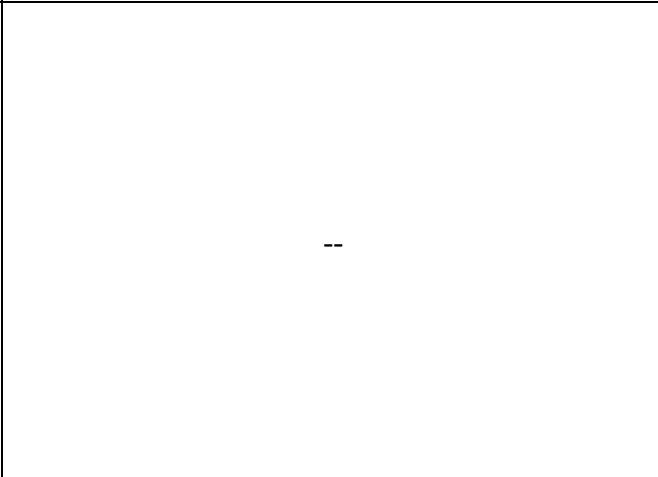
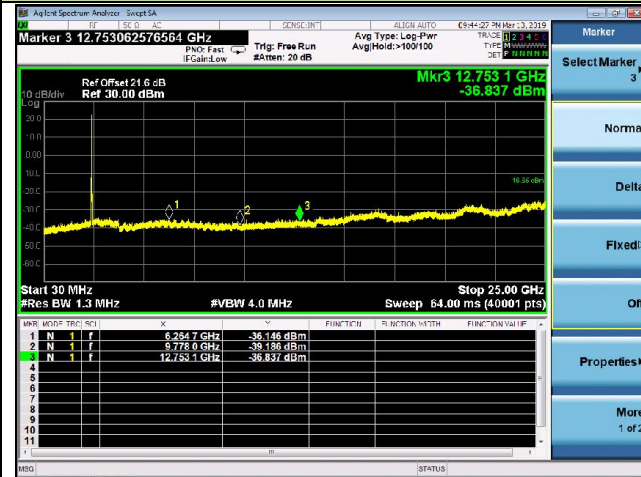

Channel 07 (2442MHz)

100kHz PSD reference Level

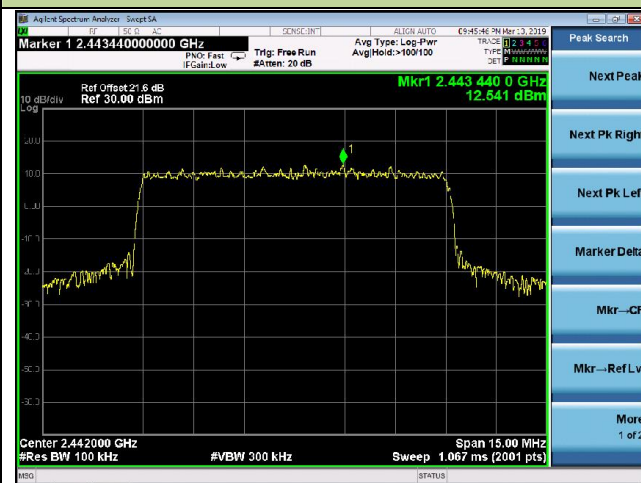

Spurious Emission

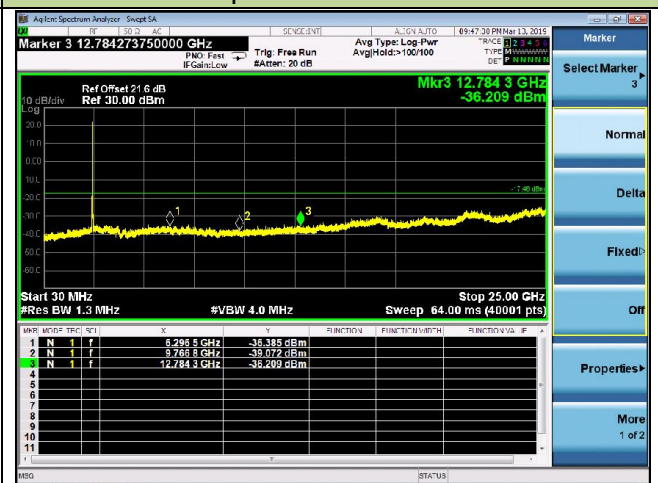

Channel 13 (2472MHz)

100kHz PSD reference Level



High Band Edge

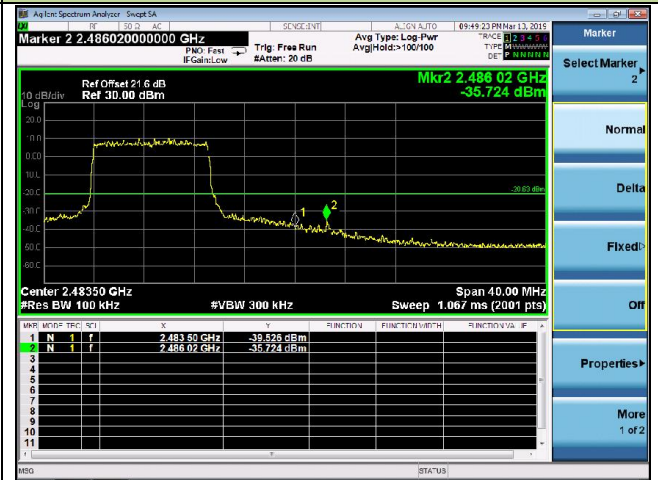

Spurious Emission

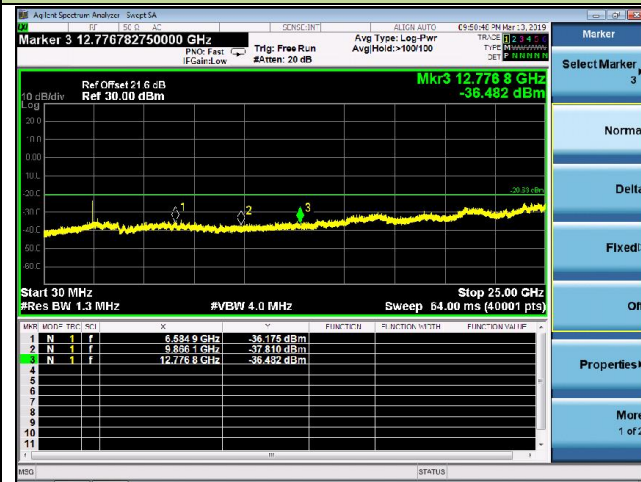

--

--

2.5MHz Out-of-Band Emissions - Ant 1

Channel 01 (2412MHz)

100kHz PSD reference Level



Low Band Edge



Spurious Emission

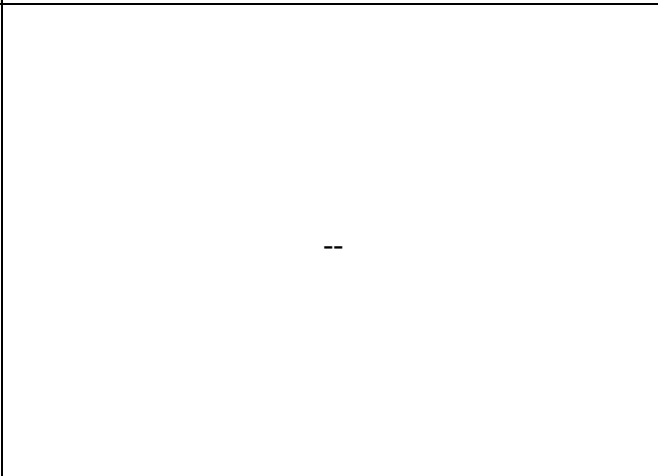
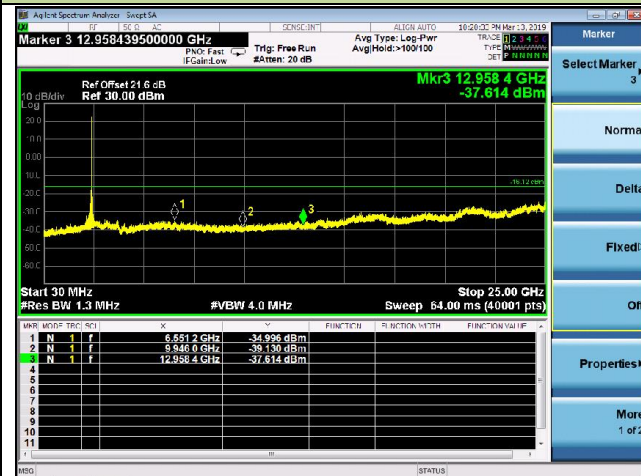

Channel 07 (2442MHz)

100kHz PSD reference Level

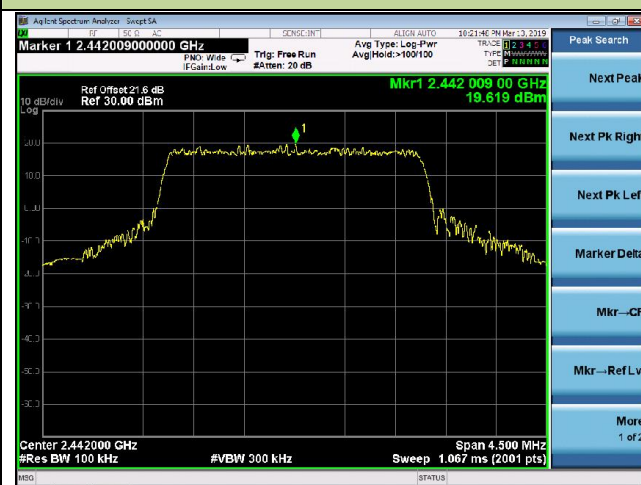

Spurious Emission

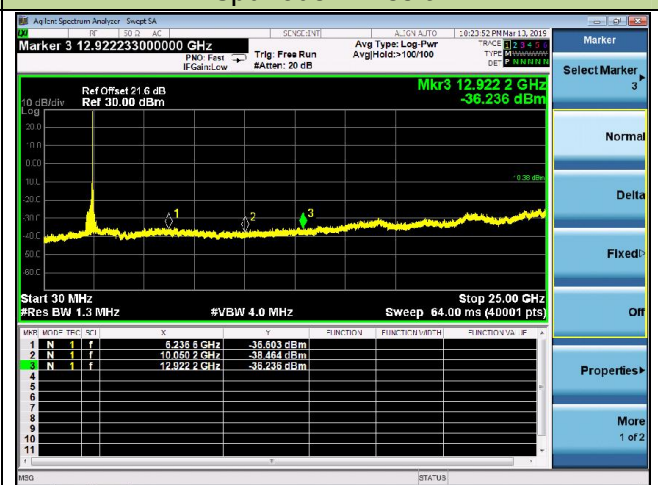

Channel 13 (2472MHz)

100kHz PSD reference Level



High Band Edge

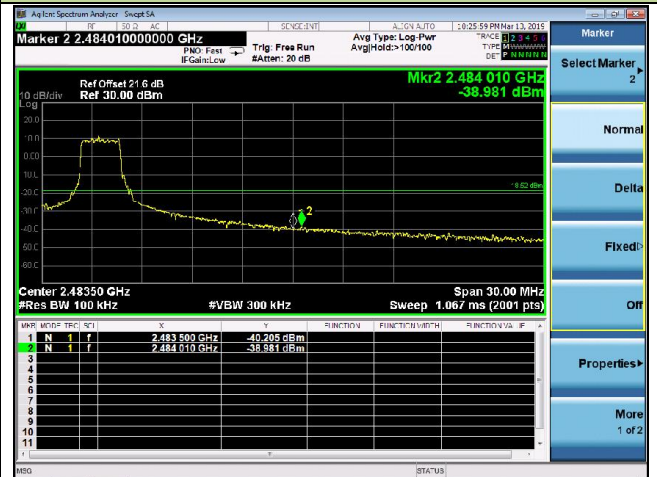

Spurious Emission

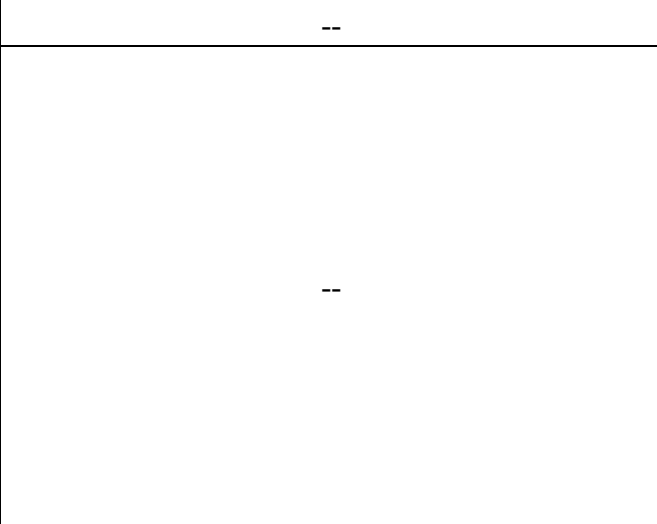
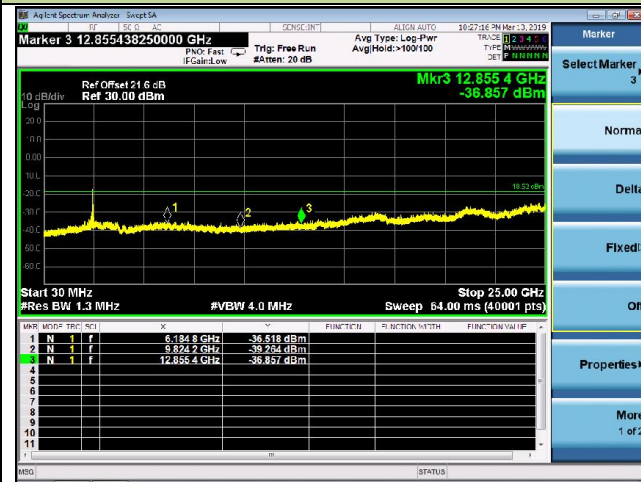

10MHz Out-of-Band Emissions - Ant 2

Channel 01 (2412MHz)

100kHz PSD reference Level



Low Band Edge



Spurious Emission

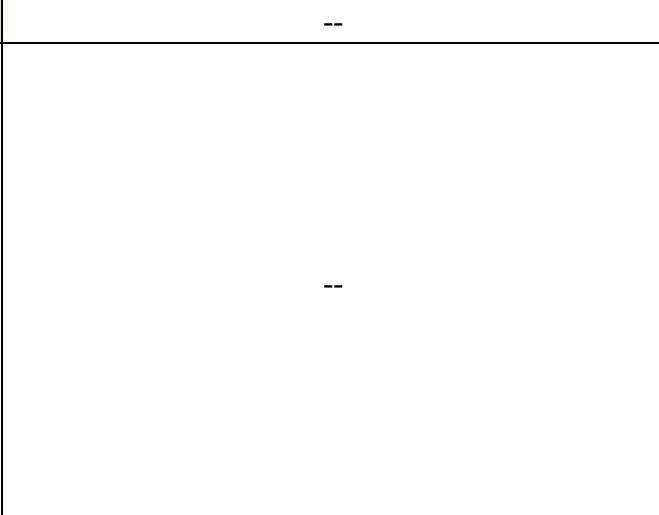
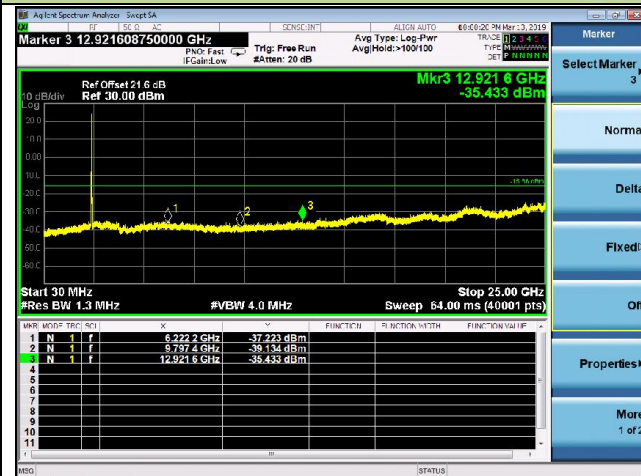

Channel 07 (2442MHz)

100kHz PSD reference Level

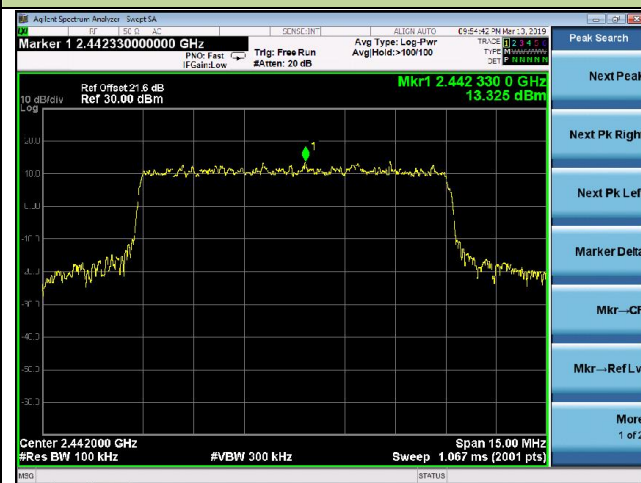

Spurious Emission

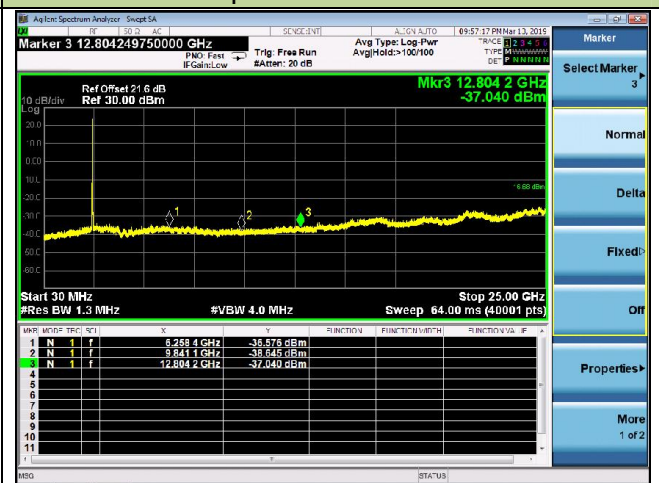

Channel 13 (2472MHz)

100kHz PSD reference Level

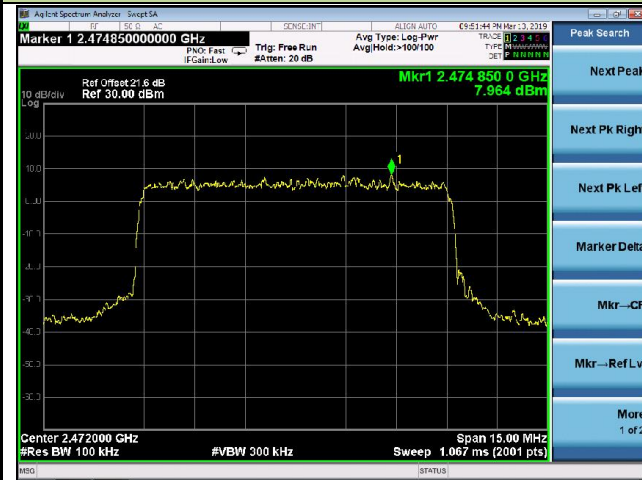

High Band Edge

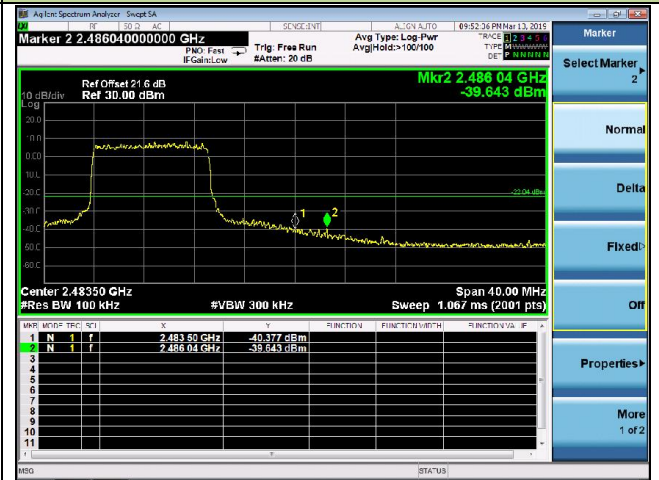

Spurious Emission

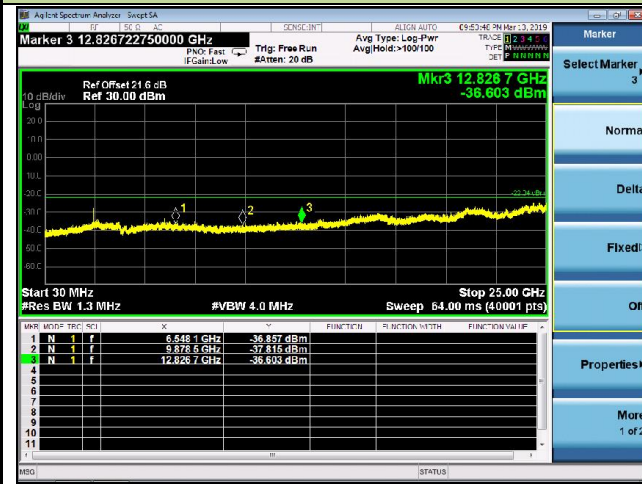

--

--

7.6. Radiated Spurious Emission Measurement

7.6.1. Test Limit

All out of band emissions appearing in a restricted band as specified in Section 15.205 of the Title 47 CFR must not exceed the limits shown in Table per Section 15.209.

FCC Part 15 Subpart C Paragraph 15.209		
Frequency [MHz]	Field Strength [uV/m]	Measured Distance [Meters]
0.009 - 0.490	2400/F (kHz)	300
0.490 - 1.705	24000/F (kHz)	30
1.705 - 30	30	30
30 - 88	100	3
88 - 216	150	3
216 - 960	200	3
Above 960	500	3

7.6.2. Test Procedure Used

ANSI C63.10 Section 6.3 (General Requirements)

ANSI C63.10 Section 6.4 (Standard test method below 30MHz)

ANSI C63.10 Section 6.5 (Standard test method above 30MHz to 1GHz)

ANSI C63.10 Section 6.6 (Standard test method above 1GHz)

7.6.3. Test Setting

Quasi-Peak Measurements below 1GHz

1. Analyzer center frequency was set to the frequency of the radiated spurious emission of interest
2. Span was set greater than 1MHz
3. RBW = as specified in Table 1
4. Detector = CISPR quasi-peak or average
5. Sweep time = auto couple
6. Trace was allowed to stabilize

Table 1 - RBW as a function of frequency

Frequency	RBW
9 ~ 150 kHz	200 ~ 300 Hz
0.15 ~ 30 MHz	9 ~ 10 kHz
30 ~ 1000 MHz	100 ~ 120 kHz

Peak Measurements above 1GHz

1. Analyzer center frequency was set to the frequency of the radiated spurious emission of interest
2. RBW = 1MHz
3. VBW = 3MHz
4. Detector = peak
5. Sweep time = auto couple
6. Trace mode = max hold
7. Trace was allowed to stabilize

Average Measurements above 1GHz (Method VB)

1. Analyzer center frequency was set to the frequency of the radiated spurious emission of interest
2. RBW = 1MHz
3. VBW; If the EUT is configured to transmit with duty cycle $\geq 98\%$, set VBW = 10 Hz.
If the EUT duty cycle is $< 98\%$, set VBW $\geq 1/T$. T is the minimum transmission duration.
4. Detector = Peak
5. Sweep time = auto
6. Trace mode = max hold
7. Trace was allowed to stabilize

7.6.4. Test Setup

Below 1GHz Test Setup:

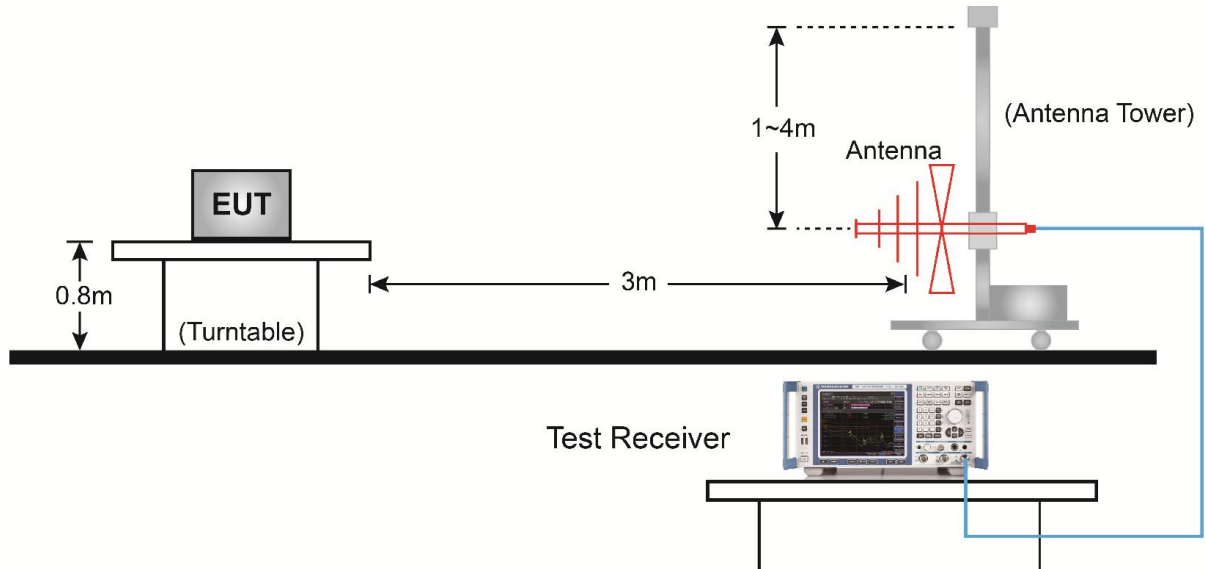

Above 1GHz Test Setup:

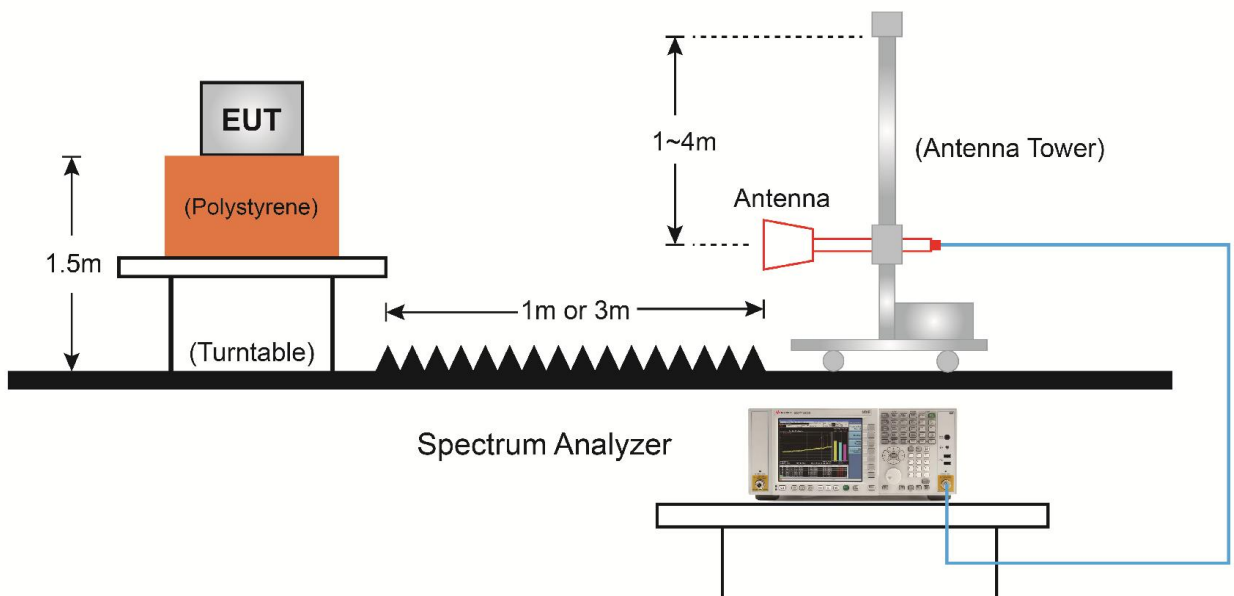

7.6.5. Test Result

Product	2.4GHz HD Wireless Link	Temperature	26°C
Test Engineer	Dandy Li	Relative Humidity	56%
Test Site	AC1	Test Date	2019/03/11
Test Mode:	10MHz Bandwidth - Ant 1	Test Channel:	01
Remark:	1. Average measurement was not performed if peak level lower than average limit. 2. Other frequency was 20dB below limit line within 1-18GHz, there is not show in the report.		

Mark	Frequency (MHz)	Reading Level (dB μ V)	Factor (dB)	Measure Level (dB μ V/m)	Limit (dB μ V/m)	Margin (dB)	Detector	Polarization
	3796.5	39.3	2.7	42.1	74.0	-31.9	Peak	Horizontal
	4825.0	41.1	5.9	46.9	74.0	-27.1	Peak	Horizontal
*	7239.0	55.0	12.7	67.7	91.0	-23.3	Peak	Horizontal
*	9644.5	48.1	15.5	63.5	91.0	-27.5	Peak	Horizontal
	4825.0	44.3	5.9	50.2	74.0	-23.8	Peak	Vertical
*	7239.0	61.3	12.7	74.0	91.0	-17.0	Peak	Vertical
	7443.0	37.6	12.9	50.5	74.0	-23.5	Peak	Vertical
*	9644.5	52.0	15.5	67.5	91.0	-23.5	Peak	Vertical

Note 1: "*" is not in restricted band, its limit is 30dBc of the fundamental emission level (121.1dB μ V/m) or 15.209 which is higher.

Note 2: Measure Level (dB μ V/m) = Reading Level (dB μ V) + Factor (dB)

Factor (dB) = Cable Loss (dB) + Antenna Factor (dB/m) - Pre_Amplifier Gain (dB)

Product	2.4GHz HD Wireless Link	Temperature	26°C
Test Engineer	Dandy Li	Relative Humidity	56%
Test Site	AC1	Test Date	2019/03/11
Test Mode:	10MHz Bandwidth - Ant 1	Test Channel:	07
Remark:	1. Average measurement was not performed if peak level lower than average limit. 2. Other frequency was 20dB below limit line within 1-18GHz, there is not show in the report.		

Mark	Frequency (MHz)	Reading Level (dB μ V)	Factor (dB)	Measure Level (dB μ V/m)	Limit (dB μ V/m)	Margin (dB)	Detector	Polarization
	5403.0	37.7	6.6	44.3	74.0	-29.7	Peak	Horizontal
*	5598.5	42.0	7.0	49.0	90.8	-41.8	Peak	Horizontal
	7324.0	46.8	12.6	59.5	74.0	-14.5	Peak	Horizontal
	7326.0	35.3	12.6	47.9	54.0	-6.1	Average	Horizontal
*	9772.0	45.7	16.2	61.8	90.8	-29.0	Peak	Horizontal
	4884.5	40.8	6.0	46.8	74.0	-27.2	Peak	Vertical
*	5598.5	52.5	7.0	59.5	90.8	-31.3	Peak	Vertical
	7324.0	56.3	12.6	68.9	74.0	-5.1	Peak	Vertical
	7326.0	40.8	12.6	53.4	54.0	-0.6	Average	Vertical
*	9772.0	45.1	16.2	61.3	90.8	-29.5	Peak	Vertical

Note 1: "*" is not in restricted band, its limit is 30dBc of the fundamental emission level (120.8dB μ V/m) or 15.209 which is higher.

Note 2: Measure Level (dB μ V/m) = Reading Level (dB μ V) + Factor (dB)

Factor (dB) = Cable Loss (dB) + Antenna Factor (dB/m) - Pre_Amplifier Gain (dB)

Product	2.4GHz HD Wireless Link	Temperature	26°C
Test Engineer	Dandy Li	Relative Humidity	56%
Test Site	AC1	Test Date	2019/03/11
Test Mode:	10MHz Bandwidth - Ant 1	Test Channel:	13
Remark:	1. Average measurement was not performed if peak level lower than average limit. 2. Other frequency was 20dB below limit line within 1-18GHz, there is not show in the report.		

Mark	Frequency (MHz)	Reading Level (dBμV)	Factor (dB)	Measure Level (dBμV/m)	Limit (dBμV/m)	Margin (dB)	Detector	Polarization
	4884.5	37.7	6.0	43.7	74.0	-30.3	Peak	Horizontal
*	5590.0	47.2	7.0	54.2	86.2	-32.0	Peak	Horizontal
	7409.0	45.1	12.6	57.6	74.0	-16.4	Peak	Horizontal
	7416.2	31.0	12.7	43.6	54.0	-10.4	Average	Horizontal
*	9891.0	45.0	16.6	61.6	86.2	-24.6	Peak	Horizontal
	4944.0	42.9	6.1	48.9	74.0	-25.1	Peak	Vertical
*	5590.0	54.9	7.0	61.9	86.2	-24.3	Peak	Vertical
	7416.3	39.8	12.7	52.5	54.0	-1.5	Average	Vertical
	7417.5	56.8	12.7	69.5	74.0	-4.5	Peak	Vertical
*	9891.0	49.2	16.6	65.7	86.2	-20.5	Peak	Vertical

Note 1: "*" is not in restricted band, its limit is 30dBc of the fundamental emission level (116.2dBμV/m) or 15.209 which is higher.

Note 2: Measure Level (dBμV/m) = Reading Level (dBμV) + Factor (dB)

Factor (dB) = Cable Loss (dB) + Antenna Factor (dB/m) - Pre_Amplifier Gain (dB)

Product	2.4GHz HD Wireless Link	Temperature	26°C
Test Engineer	Dandy Li	Relative Humidity	56%
Test Site	AC1	Test Date	2019/03/11
Test Mode:	2.5MHz Bandwidth - Ant 1	Test Channel:	01
Remark:	1. Average measurement was not performed if peak level lower than average limit. 2. Other frequency was 20dB below limit line within 1-18GHz, there is not show in the report.		

Mark	Frequency (MHz)	Reading Level (dBμV)	Factor (dB)	Measure Level (dBμV/m)	Limit (dBμV/m)	Margin (dB)	Detector	Polarization
	3805.0	39.0	2.8	41.8	74.0	-32.2	Peak	Horizontal
*	5658.0	49.4	7.0	56.4	88.2	-31.8	Peak	Horizontal
	8488.5	36.7	12.8	49.4	74.0	-24.6	Peak	Horizontal
*	10511.5	35.5	17.6	53.0	88.2	-35.2	Peak	Horizontal
	4825.0	41.1	5.9	47.0	74.0	-27.0	Peak	Vertical
*	5658.0	62.1	7.0	69.2	88.2	-19.0	Peak	Vertical
*	7222.0	46.2	12.7	58.8	88.2	-29.4	Peak	Vertical
	11319.0	38.2	17.6	55.8	74.0	-18.2	Peak	Vertical
	11319.0	29.7	17.6	47.3	54.0	-6.8	Average	Vertical

Note 1: "*" is not in restricted band, its limit is 30dBc of the fundamental emission level (118.2dBμV/m) or 15.209 which is higher.

Note 2: Measure Level (dBμV/m) = Reading Level (dBμV) + Factor (dB)

Factor (dB) = Cable Loss (dB) + Antenna Factor (dB/m) - Pre_Amplifier Gain (dB)

Product	2.4GHz HD Wireless Link	Temperature	26°C
Test Engineer	Dandy Li	Relative Humidity	56%
Test Site	AC1	Test Date	2019/03/11
Test Mode:	2.5MHz Bandwidth - Ant 1	Test Channel:	07
Remark:	1. Average measurement was not performed if peak level lower than average limit. 2. Other frequency was 20dB below limit line within 1-18GHz, there is not show in the report.		

Mark	Frequency (MHz)	Reading Level (dBμV)	Factor (dB)	Measure Level (dBμV/m)	Limit (dBμV/m)	Margin (dB)	Detector	Polarization
	4884.5	40.5	6.0	46.4	74.0	-27.6	Peak	Horizontal
*	5666.5	53.9	7.0	61.0	87.2	-26.2	Peak	Horizontal
	7315.5	37.1	12.6	49.6	74.0	-24.4	Peak	Horizontal
*	9755.0	36.8	16.2	53.0	87.2	-34.2	Peak	Horizontal
	4884.3	38.6	6.0	44.5	54.0	-9.5	Average	Vertical
	4884.5	51.5	6.0	57.4	74.0	-16.6	Peak	Vertical
	5675.0	62.3	7.1	69.4	87.2	-17.8	Peak	Vertical
*	7324.0	46.2	12.6	58.9	74.0	-15.1	Peak	Vertical
	7326.0	31.2	12.6	43.8	54.0	-10.2	Average	Vertical
*	9755.0	42.1	16.2	58.3	87.2	-28.9	Peak	Vertical

Note 1: "*" is not in restricted band, its limit is 30dBc of the fundamental emission level (117.2dBμV/m) or 15.209 which is higher.

Note 2: Measure Level (dBμV/m) = Reading Level (dBμV) + Factor (dB)

Factor (dB) = Cable Loss (dB) + Antenna Factor (dB/m) - Pre_Amplifier Gain (dB)

Product	2.4GHz HD Wireless Link	Temperature	26°C
Test Engineer	Dandy Li	Relative Humidity	56%
Test Site	AC1	Test Date	2019/03/11
Test Mode:	2.5MHz Bandwidth - Ant 1	Test Channel:	13
Remark:	1. Average measurement was not performed if peak level lower than average limit. 2. Other frequency was 20dB below limit line within 1-18GHz, there is not show in the report.		

Mark	Frequency (MHz)	Reading Level (dBμV)	Factor (dB)	Measure Level (dBμV/m)	Limit (dBμV/m)	Margin (dB)	Detector	Polarization
	5658.0	55.2	7.0	62.2	85.0	-22.8	Peak	Horizontal
	7723.5	36.3	12.8	49.1	74.0	-24.9	Peak	Horizontal
*	8097.5	36.3	13.5	49.9	74.0	-24.1	Peak	Horizontal
*	9874.0	36.5	16.8	53.3	85.0	-31.7	Peak	Horizontal
	4944.0	43.4	6.1	49.4	74.0	-24.6	Peak	Vertical
	5666.5	62.5	7.0	69.5	85.0	-15.5	Peak	Vertical
*	7409.0	39.4	12.6	52.0	74.0	-22.0	Peak	Vertical
*	9874.0	41.9	16.8	58.7	85.0	-26.3	Peak	Vertical

Note 1: "*" is not in restricted band, its limit is 30dBc of the fundamental emission level (115.0dBμV/m) or 15.209 which is higher.

Note 2: Measure Level (dBμV/m) = Reading Level (dBμV) + Factor (dB)

Factor (dB) = Cable Loss (dB) + Antenna Factor (dB/m) - Pre_Amplifier Gain (dB)

Product	2.4GHz HD Wireless Link	Temperature	26°C
Test Engineer	Dandy Li	Relative Humidity	56%
Test Site	AC1	Test Date	2019/03/11
Test Mode:	10MHz Bandwidth - Ant 2	Test Channel:	01
Remark:	1. Average measurement was not performed if peak level lower than average limit. 2. Other frequency was 20dB below limit line within 1-18GHz, there is not show in the report.		

Mark	Frequency (MHz)	Reading Level (dBμV)	Factor (dB)	Measure Level (dBμV/m)	Limit (dBμV/m)	Margin (dB)	Detector	Polarization
	4825.0	41.0	5.9	46.8	74.0	-27.2	Peak	Horizontal
*	7239.0	54.0	12.7	66.7	86.5	-19.8	Peak	Horizontal
	9644.5	46.4	15.5	61.9	86.5	-24.6	Peak	Horizontal
*	12058.5	40.7	17.5	58.1	74.0	-15.9	Peak	Horizontal
	12060.5	29.0	17.5	46.4	54.0	-7.6	Average	Horizontal
	4816.5	46.8	5.9	52.7	74.0	-21.3	Peak	Vertical
	7239.0	60.0	12.7	72.7	86.5	-13.8	Peak	Vertical
*	9644.5	51.1	15.5	66.6	86.5	-19.9	Peak	Vertical
*	10885.5	34.6	18.1	52.8	74.0	-21.2	Peak	Vertical

Note 1: "*" is not in restricted band, its limit is 30dBc of the fundamental emission level (116.5dBμV/m) or 15.209 which is higher.

Note 2: Measure Level (dBμV/m) = Reading Level (dBμV) + Factor (dB)

Factor (dB) = Cable Loss (dB) + Antenna Factor (dB/m) - Pre_Amplifier Gain (dB)

Product	2.4GHz HD Wireless Link	Temperature	26°C
Test Engineer	Dandy Li	Relative Humidity	56%
Test Site	AC1	Test Date	2019/03/11
Test Mode:	10MHz Bandwidth - Ant 2	Test Channel:	07
Remark:	1. Average measurement was not performed if peak level lower than average limit. 2. Other frequency was 20dB below limit line within 1-18GHz, there is not show in the report.		

Mark	Frequency (MHz)	Reading Level (dBμV)	Factor (dB)	Measure Level (dBμV/m)	Limit (dBμV/m)	Margin (dB)	Detector	Polarization
	4884.5	39.0	6.0	45.0	74.0	-29.0	Peak	Horizontal
	5607.0	42.6	7.0	49.6	85.8	-36.2	Peak	Horizontal
	7326.1	37.5	12.6	50.1	54.0	-3.9	Average	Horizontal
*	7332.5	46.2	12.6	58.8	74.0	-15.2	Peak	Horizontal
*	9763.5	44.8	16.2	61.0	85.8	-24.8	Peak	Horizontal
	4884.5	41.4	6.0	47.4	74.0	-26.6	Peak	Vertical
	5615.5	49.9	7.0	56.9	85.8	-28.9	Peak	Vertical
	7326.1	40.8	12.6	53.4	54.0	-0.6	Average	Vertical
*	7332.5	55.7	12.6	68.4	74.0	-5.6	Peak	Vertical
*	9772.0	45.1	16.2	61.3	85.8	-24.5	Peak	Vertical

Note 1: "*" is not in restricted band, its limit is 30dBc of the fundamental emission level (115.8dBμV/m) or 15.209 which is higher.

Note 2: Measure Level (dBμV/m) = Reading Level (dBμV) + Factor (dB)

Factor (dB) = Cable Loss (dB) + Antenna Factor (dB/m) - Pre_Amplifier Gain (dB)

Product	2.4GHz HD Wireless Link	Temperature	26°C
Test Engineer	Dandy Li	Relative Humidity	56%
Test Site	AC1	Test Date	2019/03/11
Test Mode:	10MHz Bandwidth - Ant 2	Test Channel:	13
Remark:	1. Average measurement was not performed if peak level lower than average limit. 2. Other frequency was 20dB below limit line within 1-18GHz, there is not show in the report.		

Mark	Frequency (MHz)	Reading Level (dBμV)	Factor (dB)	Measure Level (dBμV/m)	Limit (dBμV/m)	Margin (dB)	Detector	Polarization
	4876.0	36.9	6.0	42.9	74.0	-31.1	Peak	Horizontal
	5607.0	43.9	7.0	50.9	82.2	-31.3	Peak	Horizontal
*	7417.5	41.0	12.7	53.7	74.0	-20.3	Peak	Horizontal
*	9891.0	43.8	16.6	60.4	82.2	-21.8	Peak	Horizontal
	5598.5	54.0	7.0	61.0	82.2	-21.2	Peak	Vertical
	7416.5	35.2	12.7	47.9	54.0	-6.1	Average	Vertical
	7417.5	48.8	12.7	61.5	74.0	-12.5	Peak	Vertical
*	9891.0	48.0	16.6	64.5	82.2	-17.7	Peak	Vertical
*	11208.5	38.2	17.6	55.8	74.0	-18.2	Peak	Vertical
	11208.5	29.7	17.6	47.2	54.0	-6.8	Average	Vertical

Note 1: "*" is not in restricted band, its limit is 30dBc of the fundamental emission level (112.2dBμV/m) or 15.209 which is higher.

Note 2: Measure Level (dBμV/m) = Reading Level (dBμV) + Factor (dB)

Factor (dB) = Cable Loss (dB) + Antenna Factor (dB/m) - Pre_Amplifier Gain (dB)

Product	2.4GHz HD Wireless Link	Temperature	26°C
Test Engineer	Dandy Li	Relative Humidity	56%
Test Site	AC1	Test Date	2019/03/15
Test Mode:	10MHz Bandwidth - Ant 1 (Model: WLN210-BM-c)	Test Channel:	07
Remark:	1. Average measurement was not performed if peak level lower than average limit. 2. Other frequency was 20dB below limit line within 1-18GHz, there is not show in the report.		

Mark	Frequency (MHz)	Reading Level (dBμV)	Factor (dB)	Measure Level (dBμV/m)	Limit (dBμV/m)	Margin (dB)	Detector	Polarization
	4884.5	42.1	6.0	48.1	74.0	-25.9	Peak	Horizontal
*	5607.0	46.6	7.0	53.6	90.8	-37.2	Peak	Horizontal
	7324.0	45.3	12.6	57.9	74.0	-16.1	Peak	Horizontal
	7325.9	32.9	12.6	45.5	54.0	-8.5	Average	Horizontal
*	9772.0	42.8	16.2	59.0	90.8	-31.8	Peak	Horizontal
	4884.5	43.0	6.0	49.0	74.0	-25.0	Peak	Horizontal
*	5598.5	50.2	7.0	57.2	90.8	-33.6	Peak	Vertical
	7324.0	53.4	12.6	66.0	74.0	-8.0	Peak	Vertical
	7326.5	40.0	12.6	52.6	54.0	-1.4	Average	Vertical
*	9763.5	47.5	16.2	63.7	90.8	-27.1	Peak	Vertical
	11200.7	26.2	17.6	43.8	54.0	-10.2	Average	Vertical
	11217.0	37.7	17.6	55.3	74.0	-18.7	Peak	Vertical

Note 1: "*" is not in restricted band, its limit is 30dBc of the fundamental emission level (120.8dBμV/m) or 15.209 which is higher.

Note 2: Measure Level (dBμV/m) = Reading Level (dBμV) + Factor (dB)

Factor (dB) = Cable Loss (dB) + Antenna Factor (dB/m) - Pre_Amplifier Gain (dB)

The worst case of Radiated Emission below 1GHz:

Site: AC1	Time: 2019/02/27 - 23:26
Limit: FCC_Part15.109_RE(3m)_ClassB	Engineer: Cloud Guo
Probe: VULB 9168 _20-2000MHz	Polarity: Horizontal
EUT: 2.4GHz HD Wireless Link	Power: DC 5V
Test Mode: There is the worst case within frequency range 30MHz~1GHz.	

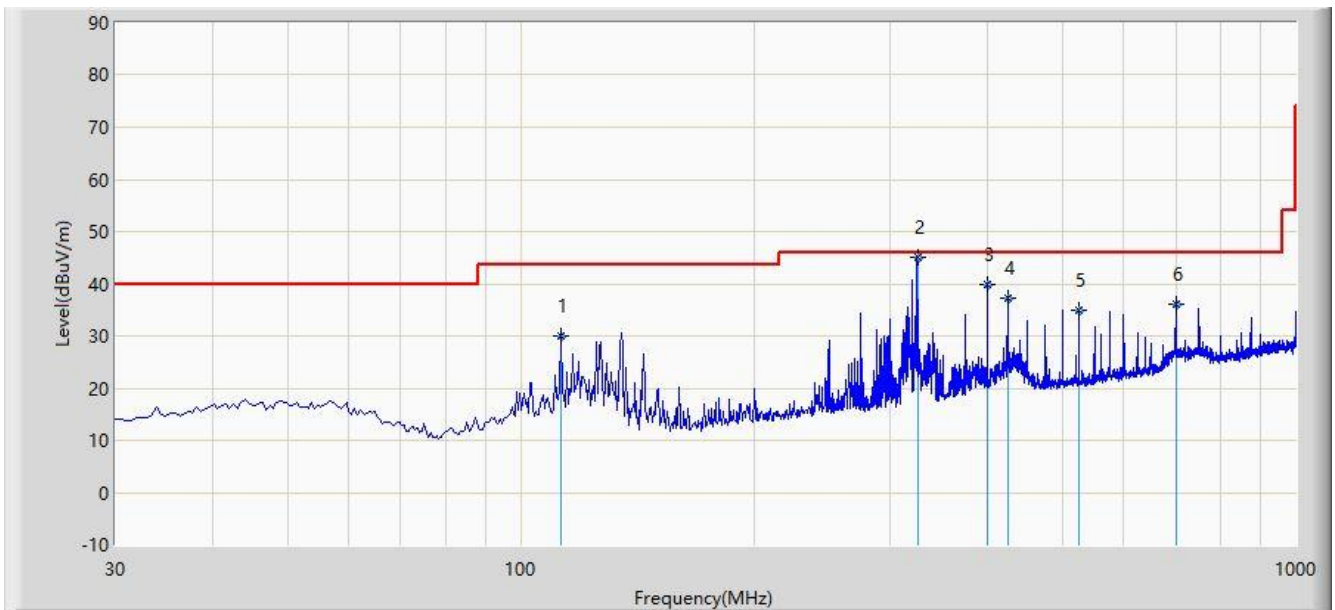

No	Flag	Mark	Frequency (MHz)	Measure Level (dBuV/m)	Reading Level (dBuV)	Over Limit (dB)	Limit (dBuV/m)	Factor (dB)	Type
1		*	112.935	29.963	18.463	-13.537	43.500	11.500	QP
2			325.000	44.937	29.420	-1.063	46.000	15.516	QP
3			400.055	39.985	25.010	-6.015	46.000	14.975	QP
4			424.790	37.256	21.980	-8.744	46.000	15.276	QP
5			525.185	34.983	18.310	-11.017	46.000	16.673	QP
6			699.785	35.976	16.740	-10.024	46.000	19.236	QP

Note 1: Measure Level (dB μ V/m) = Reading Level (dB μ V) + Factor (dB)

Factor (dB) = Cable Loss (dB) + Antenna Factor (dB/m)

Note 2: The test trace is same as the ambient noise and the amplitude of the emissions are attenuated more than 20dB below the permissible (the test frequency range: 9kHz ~ 30MHz, 18GHz ~ 25GHz), therefore no data appear in the report.

Site: AC1	Time: 2019/02/27 - 23:32
Limit: FCC_Part15.109_RE(3m)_ClassB	Engineer: Cloud Guo
Probe: VULB 9168 _20-2000MHz	Polarity: Vertical
EUT: 2.4GHz HD Wireless Link	Power: DC 5V
Test Mode: There is the worst case within frequency range 30MHz~1GHz.	

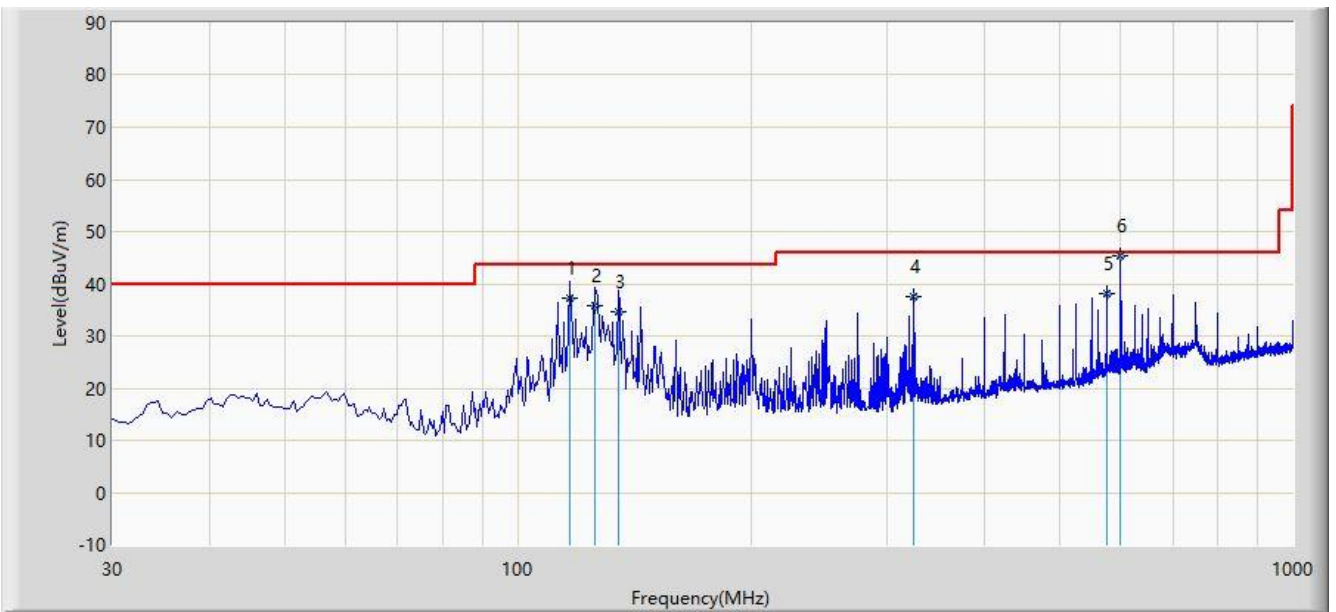

No	Flag	Mark	Frequency (MHz)	Measure Level (dBuV/m)	Reading Level (dBuV)	Over Limit (dB)	Limit (dBuV/m)	Factor (dB)	Type
1			116.815	37.348	26.511	-6.152	43.500	10.837	QP
2			126.030	35.780	26.340	-7.720	43.500	9.440	QP
3			134.760	34.610	25.890	-8.890	43.500	8.720	QP
4			324.880	37.599	23.950	-8.401	46.000	13.649	QP
5			575.140	38.142	20.590	-7.858	46.000	17.552	QP
6		*	600.000	45.299	24.850	-0.701	46.000	20.449	QP

Note 1: Measure Level (dB μ V/m) = Reading Level (dB μ V) + Factor (dB)

Factor (dB) = Cable Loss (dB) + Antenna Factor (dB/m)

Note 2: The test trace is same as the ambient noise and the amplitude of the emissions are attenuated more than 20dB below the permissible (the test frequency range: 9kHz ~ 30MHz, 18GHz ~ 25GHz), therefore no data appear in the report.

7.7. Radiated Restricted Band Edge Measurement

7.7.1. Test Limit

For 15.205 requirement:

Radiated emissions which fall in the restricted bands, as defined in Section 15.205(a) of FCC part 15, must also comply with the radiated emission limits specified in Section 15.209(a).

Frequency (MHz)	Frequency (MHz)	Frequency (MHz)	Frequency (GHz)
0.090 - 0.110	16.42 - 16.423	399.9 - 410	4.5 - 5.15
¹ 0.495 - 0.505	16.69475 - 16.69525	608 - 614	5.35 - 5.46
2.1735 - 2.1905	16.80425 - 16.80475	960 - 1240	7.25 - 7.75
4.125 - 4.128	25.5 - 25.67	1300 - 1427	8.025 - 8.5
4.17725 - 4.17775	37.5 - 38.25	1435 - 1626.5	9.0 - 9.2
4.20725 - 4.20775	73 - 74.6	1645.5 - 1646.5	9.3 - 9.5
6.215 - 6.218	74.8 - 75.2	1660 - 1710	10.6 - 12.7
6.26775 - 6.26825	108 - 121.94	1718.8 - 1722.2	13.25 - 13.4
6.31175 - 6.31225	123 - 138	2200 - 2300	14.47 - 14.5
8.291 - 8.294	149.9 - 150.05	2310 - 2390	15.35 - 16.2
8.362 - 8.366	156.52475 - 156.525	2483.5 - 2500	17.7 - 21.4
8.37625 - 8.38675	156.7 - 156.9	2690 - 2900	22.01 - 23.12
8.41425 - 8.41475	162.0125 - 167.17	3260 - 3267	23.6 - 24.0
12.29 - 12.293	167.72 - 173.2	3332 - 3339	31.2 - 31.8
12.51975 - 12.52025	240 - 285	3345.8 - 3358	36.43 - 36.5
12.57675 - 12.57725	322 - 335.4	3600 - 4400	(²)
13.36 - 13.41	--	--	--

All out of band emissions appearing in a restricted band as specified in Section 15.205 of the Title 47CFR must not exceed the limits shown in Table per Section 15.209.

FCC Part 15 Subpart C Paragraph 15.209		
Frequency [MHz]	Field Strength [uV/m]	Measured Distance [Meters]
0.009 - 0.490	2400/F (kHz)	300
0.490 - 1.705	24000/F (kHz)	30
1.705 - 30	30	30
30 - 88	100	3
88 - 216	150	3
216 - 960	200	3
Above 960	500	3

7.7.2. Test Procedure Used

ANSI C63.10 Section 6.3 (General Requirements)

ANSI C63.10 Section 6.6 (Standard test method above 1GHz)

7.7.3. Test Setting

Peak Field Strength Measurements

1. Analyzer center frequency was set to the frequency of the radiated spurious emission of interest
2. RBW = as specified in Table 1
3. VBW = 3MHz
4. Detector = peak
5. Sweep time = auto couple
6. Trace mode = max hold
7. Trace was allowed to stabilize

Average Field Strength Measurements

. Analyzer center frequency was set to the frequency of the radiated spurious emission of interest

2. RBW = 1MHz

3. VBW; If the EUT is configured to transmit with duty cycle $\geq 98\%$, set VBW = 10 Hz.

If the EUT duty cycle is $< 98\%$, set $VBW \geq 1/T$. T is the minimum transmission duration.

4. Detector = Peak

5. Sweep time = auto

6. Trace mode = max hold

7. Trace was allowed to stabilize

7.7.4. Test Setup

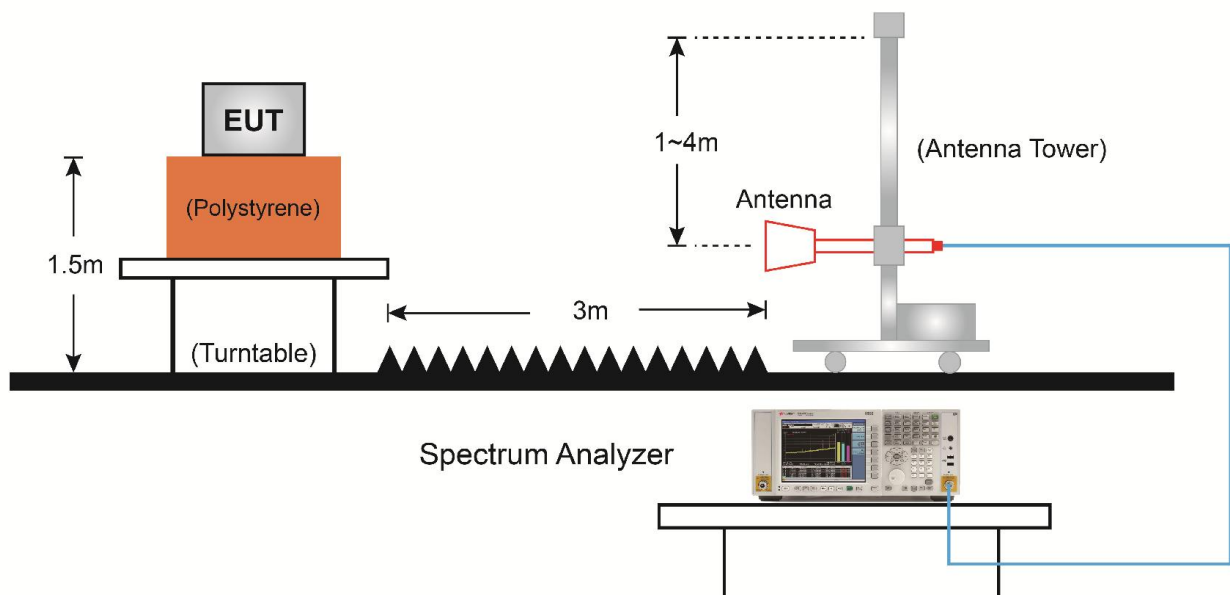

7.7.5. Test Result

Site: AC1	Time: 2019/03/14 - 16:10
Limit: FCC_Part15_Band Edge(3m)	Engineer: Dandy Li
Probe: BBHA9120D_1-18GHz	Polarity: Horizontal
EUT: 2.4GHz HD Wireless Link	Power: DC 5V
Test Mode: Transmit by 10MHz Bandwidth at channel 2412MHz with Ant 1	

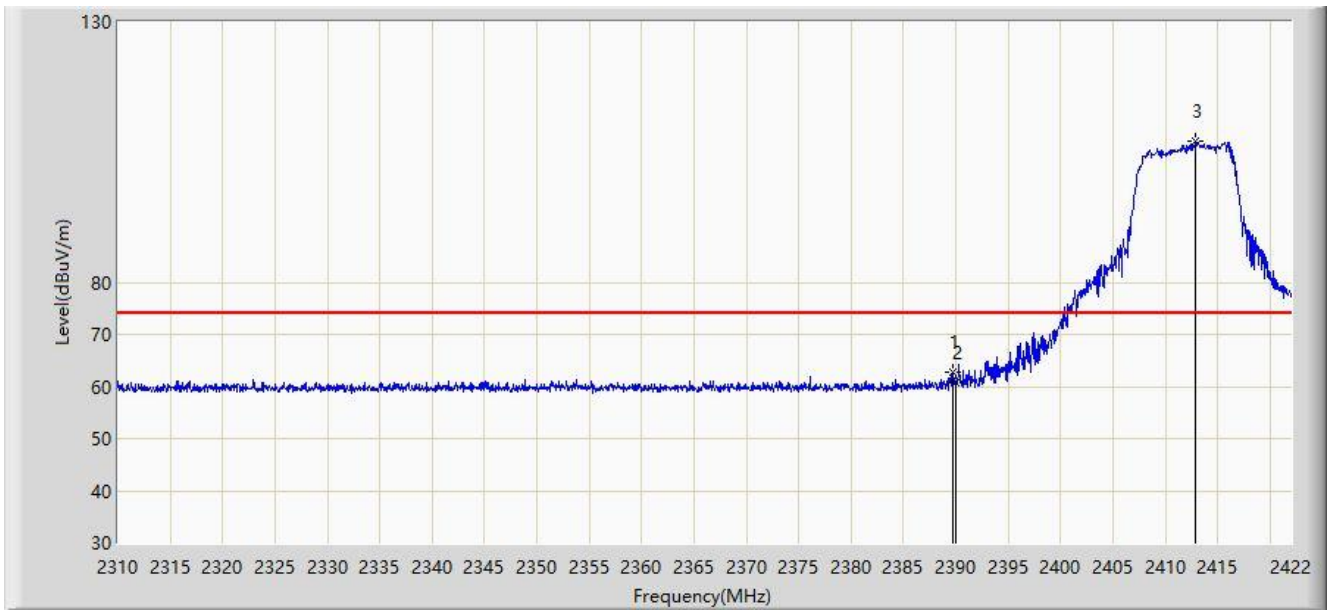

No	Flag	Mark	Frequency (MHz)	Measure Level (dBuV/m)	Reading Level (dBuV)	Margin (dB)	Limit (dBuV/m)	Factor (dB)	Type
1			2389.744	62.731	30.404	-11.269	74.000	32.327	PK
2			2390.000	60.724	28.397	-13.276	74.000	32.327	PK
3		*	2412.928	107.074	74.790	N/A	N/A	32.285	PK

Note: Measure Level (dB μ V/m) = Reading Level (dB μ V) + Factor (dB)

Factor (dB) = Cable Loss (dB) + Antenna Factor (dB/m).

Site: AC1	Time: 2019/03/14 - 16:10
Limit: FCC_Part15_Band Edge(3m)	Engineer: Dandy Li
Probe: BBHA9120D_1-18GHz	Polarity: Horizontal
EUT: 2.4GHz HD Wireless Link	Power: DC 5V
Test Mode: Transmit by 10MHz Bandwidth at channel 2412MHz with Ant 1	

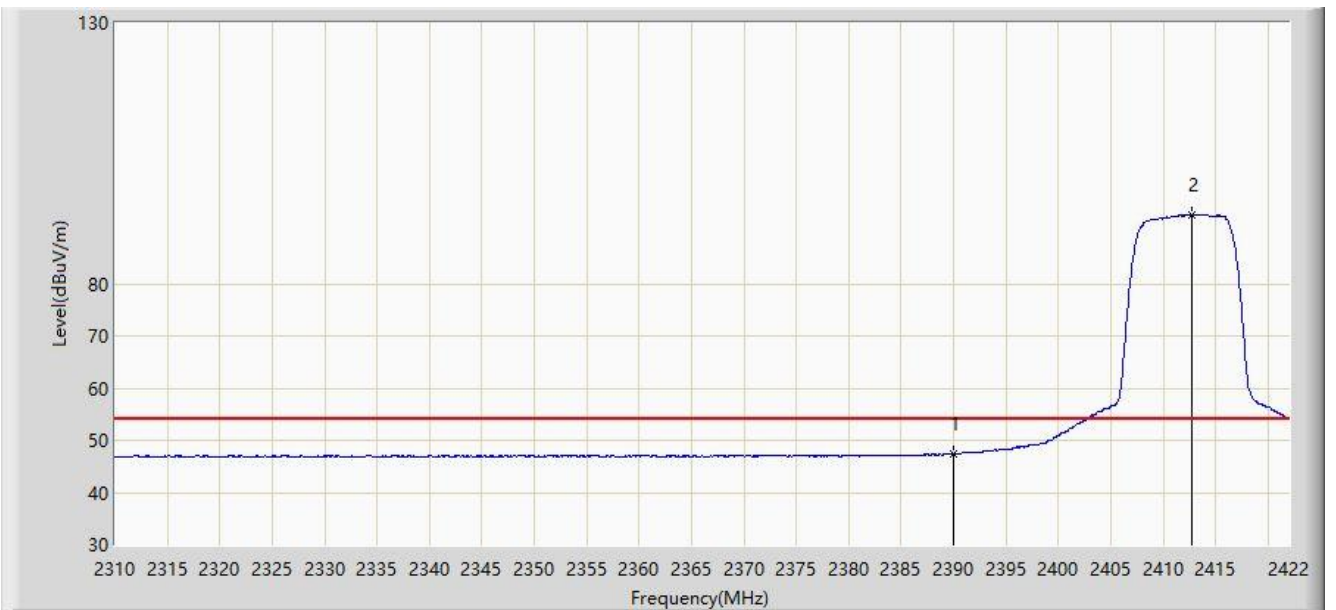

No	Flag	Mark	Frequency (MHz)	Measure Level (dBuV/m)	Reading Level (dBuV)	Margin (dB)	Limit (dBuV/m)	Factor (dB)	Type
1			2390.000	47.413	15.086	-6.587	54.000	32.327	AV
2		*	2412.704	93.228	60.943	N/A	N/A	32.284	AV

Note: Measure Level (dBuV/m) = Reading Level (dBuV) + Factor (dB)

Factor (dB) = Cable Loss (dB) + Antenna Factor (dB/m).

Site: AC1	Time: 2019/03/14 - 16:10
Limit: FCC_Part15_Band Edge(3m)	Engineer: Dandy Li
Probe: BBHA9120D_1-18GHz	Polarity: Vertical
EUT: 2.4GHz HD Wireless Link	Power: DC 5V
Test Mode: Transmit by 10MHz Bandwidth at channel 2412MHz with Ant 1	

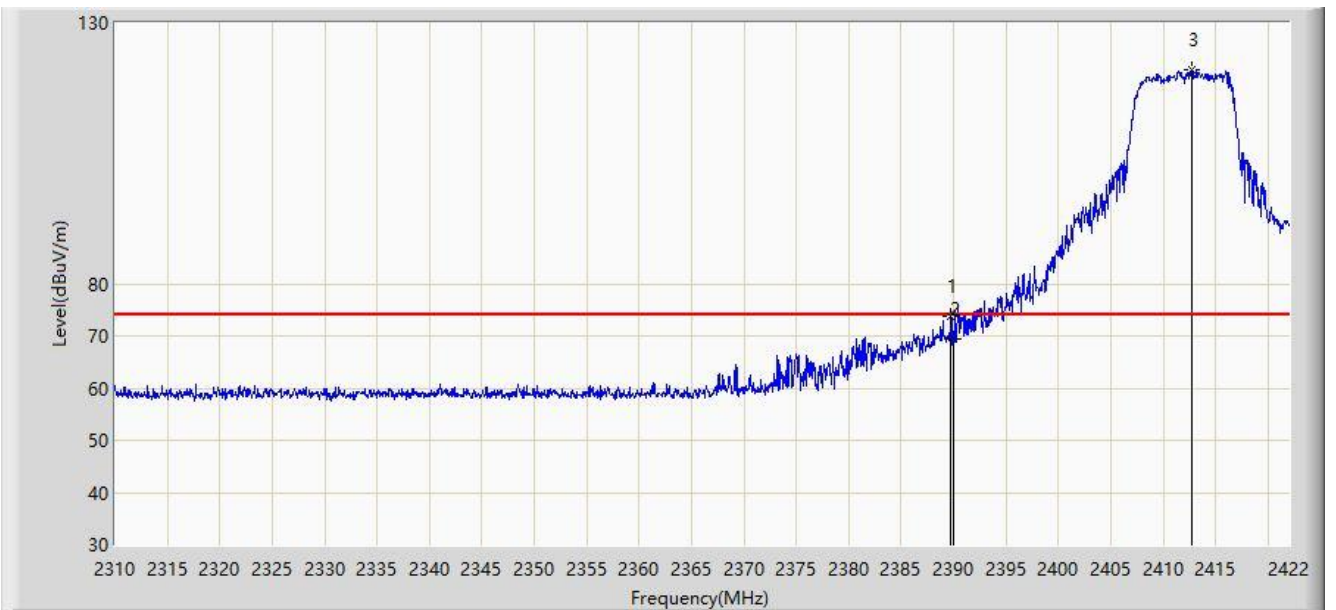

No	Flag	Mark	Frequency (MHz)	Measure Level (dBuV/m)	Reading Level (dBuV)	Margin (dB)	Limit (dBuV/m)	Factor (dB)	Type
1			2389.744	73.665	41.338	-0.335	74.000	32.327	PK
2			2390.000	69.517	37.190	-4.483	74.000	32.327	PK
3		*	2412.760	121.036	88.751	N/A	N/A	32.284	PK

Note: Measure Level (dB μ V/m) = Reading Level (dB μ V) + Factor (dB)

Factor (dB) = Cable Loss (dB) + Antenna Factor (dB/m).

Site: AC1	Time: 2019/03/14 - 16:10
Limit: FCC_Part15_Band Edge(3m)	Engineer: Dandy Li
Probe: BBHA9120D_1-18GHz	Polarity: Vertical
EUT: 2.4GHz HD Wireless Link	Power: DC 5V
Test Mode: Transmit by 10MHz Bandwidth at channel 2412MHz with Ant 1	

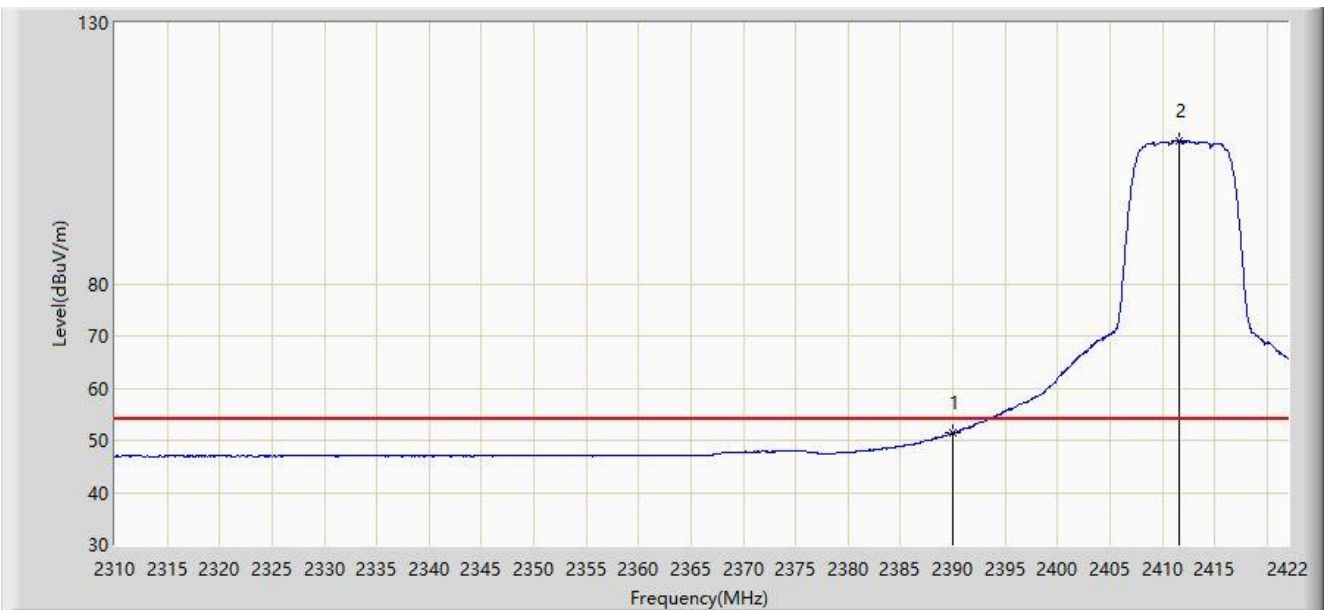

No	Flag	Mark	Frequency (MHz)	Measure Level (dBuV/m)	Reading Level (dBuV)	Margin (dB)	Limit (dBuV/m)	Factor (dB)	Type
1			2390.000	51.407	19.080	-2.593	54.000	32.327	AV
2		*	2411.584	107.494	75.209	N/A	N/A	32.285	AV

Note: Measure Level (dB μ V/m) = Reading Level (dB μ V) + Factor (dB)

Factor (dB) = Cable Loss (dB) + Antenna Factor (dB/m).

Site: AC1	Time: 2019/03/14 - 16:11
Limit: FCC_Part15_Band Edge(3m)	Engineer: Dandy Li
Probe: BBHA9120D_1-18GHz	Polarity: Horizontal
EUT: 2.4GHz HD Wireless Link	Power: DC 5V
Test Mode: Transmit by 10MHz Bandwidth at channel 2472MHz with Ant 1	

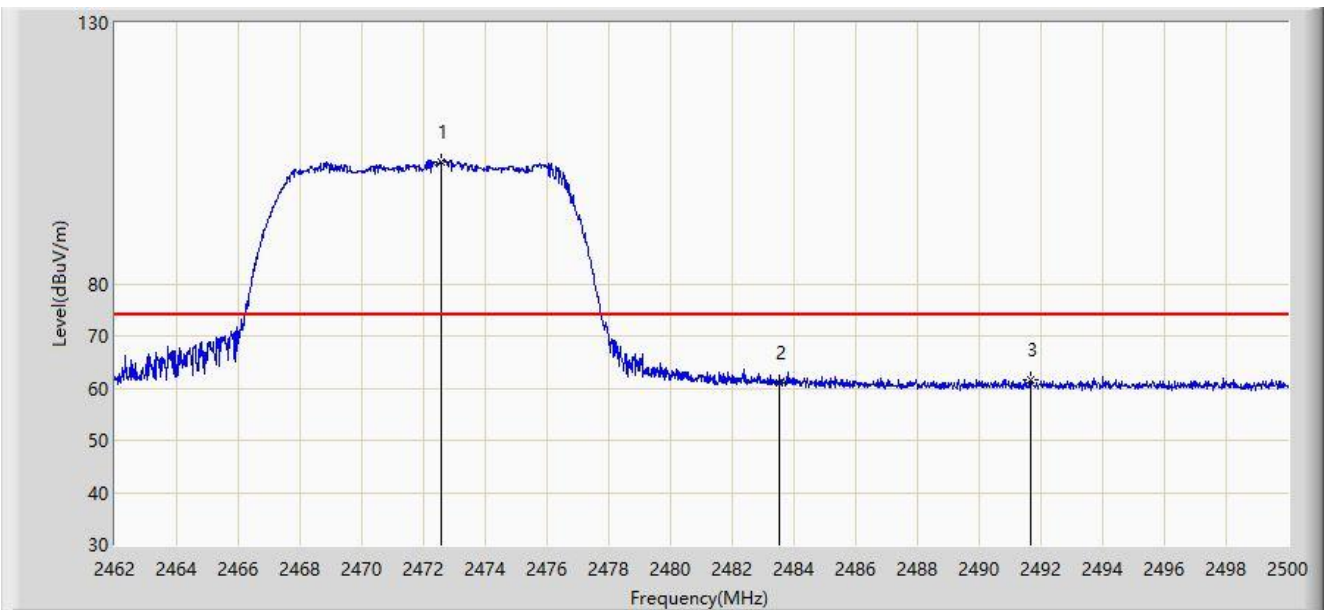

No	Flag	Mark	Frequency (MHz)	Measure Level (dBuV/m)	Reading Level (dBuV)	Margin (dB)	Limit (dBuV/m)	Factor (dB)	Type
1		*	2472.564	103.451	71.146	N/A	N/A	32.305	PK
2			2483.500	61.132	28.793	-12.868	74.000	32.340	PK
3			2491.659	61.708	29.337	-12.292	74.000	32.371	PK

Note: Measure Level (dBuV/m) = Reading Level (dBuV) + Factor (dB)

Factor (dB) = Cable Loss (dB) + Antenna Factor (dB/m).

Site: AC1	Time: 2019/03/14 - 16:11
Limit: FCC_Part15_Band Edge(3m)	Engineer: Dandy Li
Probe: BBHA9120D_1-18GHz	Polarity: Horizontal
EUT: 2.4GHz HD Wireless Link	Power: DC 5V
Test Mode: Transmit by 10MHz Bandwidth at channel 2472MHz with Ant 1	

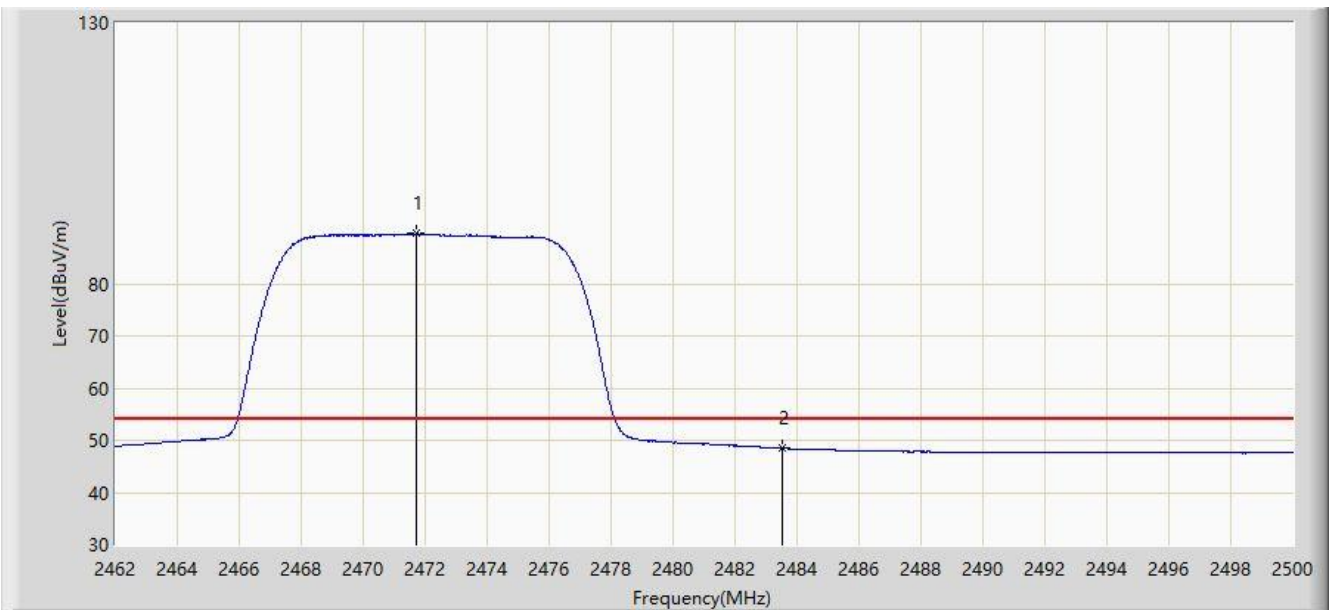

No	Flag	Mark	Frequency (MHz)	Measure Level (dBuV/m)	Reading Level (dBuV)	Margin (dB)	Limit (dBuV/m)	Factor (dB)	Type
1		*	2471.728	89.586	57.283	N/A	N/A	32.303	AV
2			2483.500	48.477	16.138	-5.523	54.000	32.340	AV

Note: Measure Level (dBuV/m) = Reading Level (dBuV) + Factor (dB)

Factor (dB) = Cable Loss (dB) + Antenna Factor (dB/m).

Site: AC1	Time: 2019/03/14 - 16:11
Limit: FCC_Part15_Band Edge(3m)	Engineer: Dandy Li
Probe: BBHA9120D_1-18GHz	Polarity: Vertical
EUT: 2.4GHz HD Wireless Link	Power: DC 5V
Test Mode: Transmit by 10MHz Bandwidth at channel 2472MHz with Ant 1	

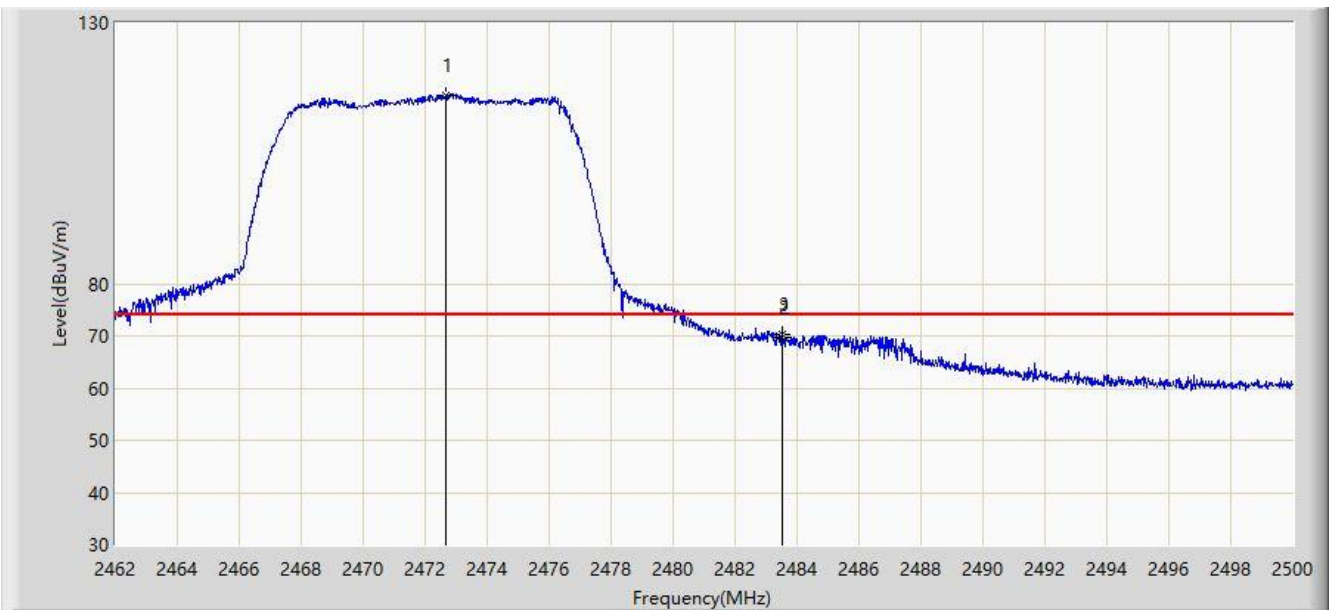

No	Flag	Mark	Frequency (MHz)	Measure Level (dBuV/m)	Reading Level (dBuV)	Margin (dB)	Limit (dBuV/m)	Factor (dB)	Type
1		*	2472.678	116.189	83.883	N/A	N/A	32.306	PK
2			2483.500	69.629	37.290	-4.371	74.000	32.340	PK
3			2483.527	70.282	37.943	-3.718	74.000	32.340	PK

Note: Measure Level (dB μ V/m) = Reading Level (dB μ V) + Factor (dB)

Factor (dB) = Cable Loss (dB) + Antenna Factor (dB/m).

Site: AC1	Time: 2019/03/14 - 16:11
Limit: FCC_Part15_Band Edge(3m)	Engineer: Dandy Li
Probe: BBHA9120D_1-18GHz	Polarity: Vertical
EUT: 2.4GHz HD Wireless Link	Power: DC 5V
Test Mode: Transmit by 10MHz Bandwidth at channel 2472MHz with Ant 1	

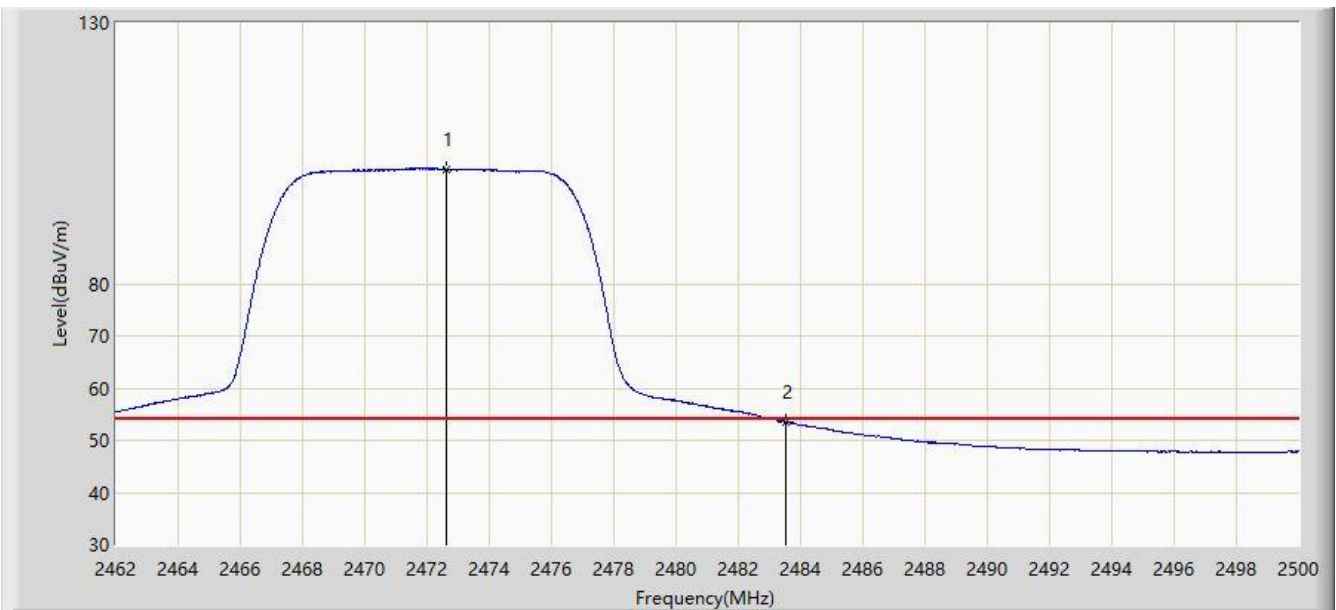

No	Flag	Mark	Frequency (MHz)	Measure Level (dBuV/m)	Reading Level (dBuV)	Margin (dB)	Limit (dBuV/m)	Factor (dB)	Type
1		*	2472.640	101.931	69.626	N/A	N/A	32.306	AV
2			2483.500	53.608	21.269	-0.392	54.000	32.340	AV

Note: Measure Level (dBuV/m) = Reading Level (dBuV) + Factor (dB)

Factor (dB) = Cable Loss (dB) + Antenna Factor (dB/m).

Site: AC1	Time: 2019/03/14 - 16:15
Limit: FCC_Part15_Band Edge(3m)	Engineer: Dandy Li
Probe: BBHA9120D_1-18GHz	Polarity: Horizontal
EUT: 2.4GHz HD Wireless Link	Power: DC 5V
Test Mode: Transmit by 2.5MHz Bandwidth at channel 2412MHz with Ant 1	

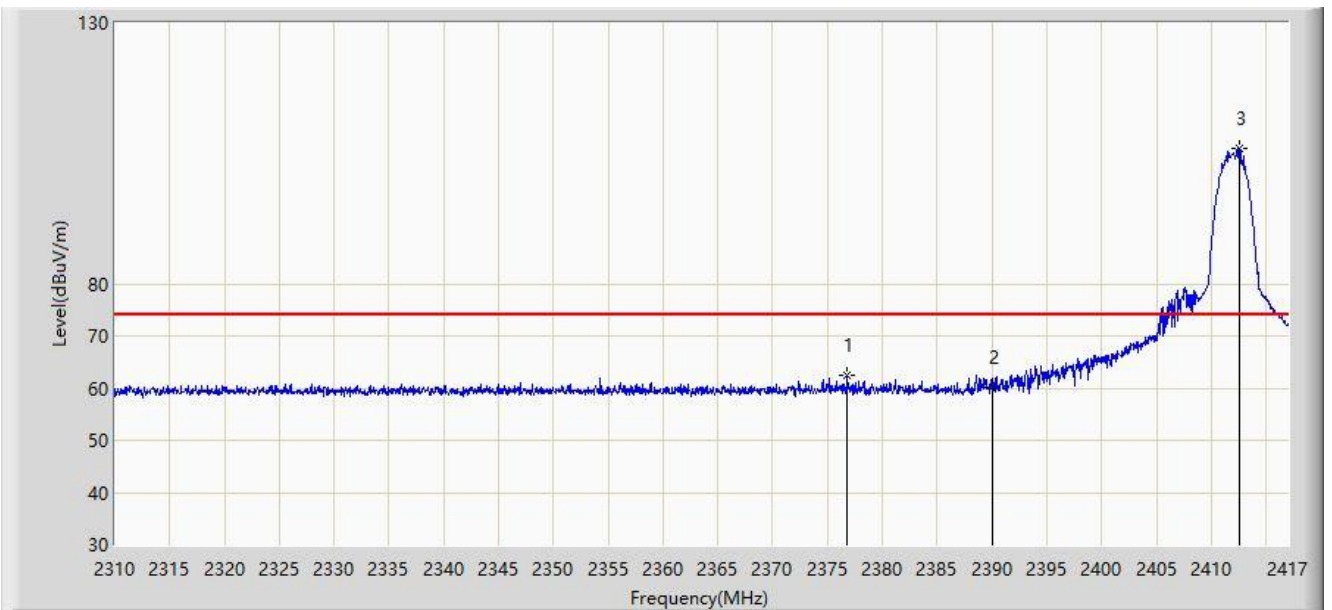

No	Flag	Mark	Frequency (MHz)	Measure Level (dBuV/m)	Reading Level (dBuV)	Margin (dB)	Limit (dBuV/m)	Factor (dB)	Type
1			2376.768	62.337	29.992	-11.663	74.000	32.345	PK
2			2390.000	60.195	27.868	-13.805	74.000	32.327	PK
3		*	2412.560	106.075	73.790	N/A	N/A	32.285	PK

Note: Measure Level (dB μ V/m) = Reading Level (dB μ V) + Factor (dB)

Factor (dB) = Cable Loss (dB) + Antenna Factor (dB/m).

Site: AC1	Time: 2019/03/14 - 16:15
Limit: FCC_Part15_Band Edge(3m)	Engineer: Dandy Li
Probe: BBHA9120D_1-18GHz	Polarity: Horizontal
EUT: 2.4GHz HD Wireless Link	Power: DC 5V
Test Mode: Transmit by 2.5MHz Bandwidth at channel 2412MHz with Ant 1	

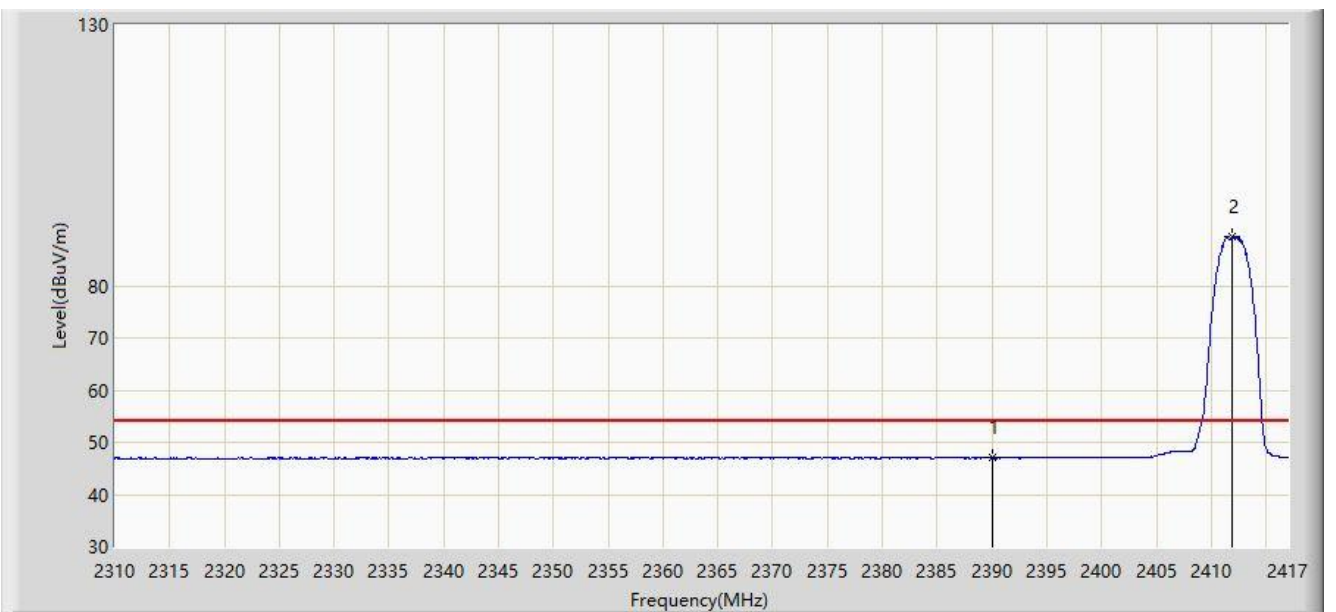

No	Flag	Mark	Frequency (MHz)	Measure Level (dBuV/m)	Reading Level (dBuV)	Margin (dB)	Limit (dBuV/m)	Factor (dB)	Type
1			2390.000	46.988	14.661	-7.012	54.000	32.327	AV
2		*	2411.864	89.441	57.156	N/A	N/A	32.285	AV

Note: Measure Level (dBuV/m) = Reading Level (dBuV) + Factor (dB)

Factor (dB) = Cable Loss (dB) + Antenna Factor (dB/m).

Site: AC1	Time: 2019/03/14 - 16:15
Limit: FCC_Part15_Band Edge(3m)	Engineer: Dandy Li
Probe: BBHA9120D_1-18GHz	Polarity: Vertical
EUT: 2.4GHz HD Wireless Link	Power: DC 5V
Test Mode: Transmit by 2.5MHz Bandwidth at channel 2412MHz with Ant 1	

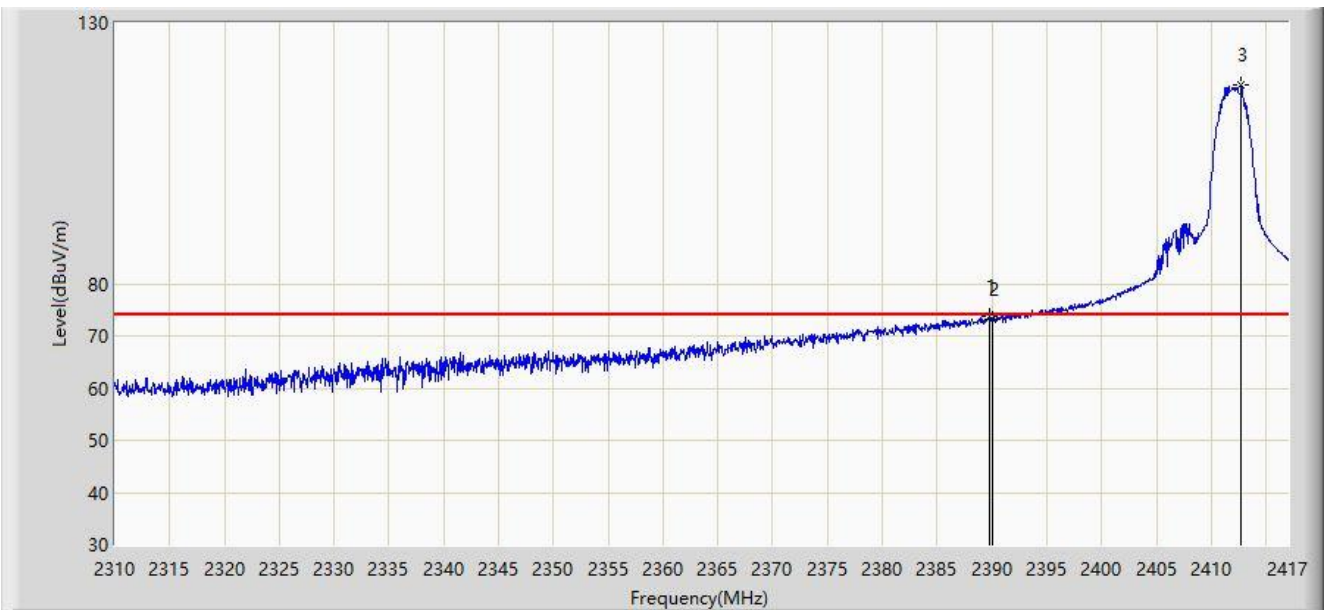

No	Flag	Mark	Frequency (MHz)	Measure Level (dBuV/m)	Reading Level (dBuV)	Margin (dB)	Limit (dBuV/m)	Factor (dB)	Type
1			2389.715	73.666	41.339	-0.334	74.000	32.328	PK
2			2390.000	73.172	40.845	-0.828	74.000	32.327	PK
3		*	2412.720	118.210	85.925	N/A	N/A	32.284	PK

Note: Measure Level (dB μ V/m) = Reading Level (dB μ V) + Factor (dB)

Factor (dB) = Cable Loss (dB) + Antenna Factor (dB/m).

Site: AC1	Time: 2019/03/14 - 16:15
Limit: FCC_Part15_Band Edge(3m)	Engineer: Dandy Li
Probe: BBHA9120D_1-18GHz	Polarity: Vertical
EUT: 2.4GHz HD Wireless Link	Power: DC 5V
Test Mode: Transmit by 2.5MHz Bandwidth at channel 2412MHz with Ant 1	

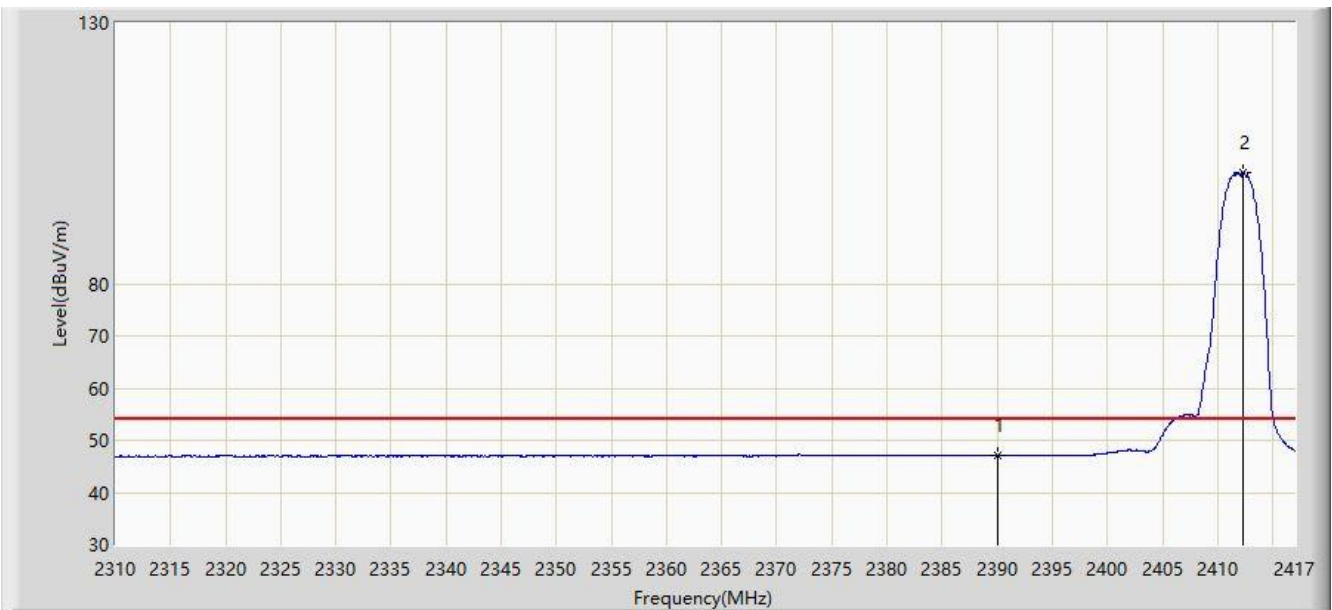

No	Flag	Mark	Frequency (MHz)	Measure Level (dBuV/m)	Reading Level (dBuV)	Margin (dB)	Limit (dBuV/m)	Factor (dB)	Type
1			2390.000	47.121	14.794	-6.879	54.000	32.327	AV
2		*	2412.292	101.289	69.004	N/A	N/A	32.285	AV

Note: Measure Level (dBuV/m) = Reading Level (dBuV) + Factor (dB)

Factor (dB) = Cable Loss (dB) + Antenna Factor (dB/m).

Site: AC1	Time: 2019/03/14 - 16:15
Limit: FCC_Part15_Band Edge(3m)	Engineer: Dandy Li
Probe: BBHA9120D_1-18GHz	Polarity: Horizontal
EUT: 2.4GHz HD Wireless Link	Power: DC 5V
Test Mode: Transmit by 2.5MHz Bandwidth at channel 2472MHz with Ant 1	

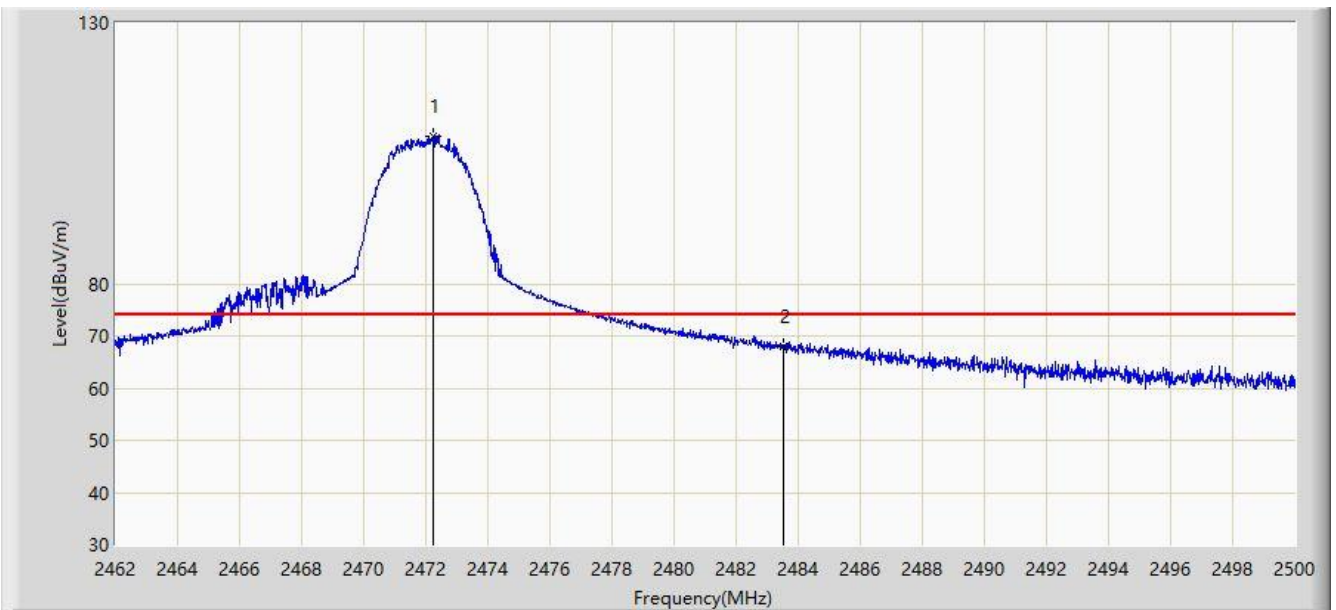

No	Flag	Mark	Frequency (MHz)	Measure Level (dBuV/m)	Reading Level (dBuV)	Margin (dB)	Limit (dBuV/m)	Factor (dB)	Type
1		*	2472.260	108.265	75.960	N/A	N/A	32.304	PK
2			2483.500	68.108	35.769	-5.892	74.000	32.340	PK

Note: Measure Level (dB μ V/m) = Reading Level (dB μ V) + Factor (dB)

Factor (dB) = Cable Loss (dB) + Antenna Factor (dB/m).

Site: AC1	Time: 2019/03/14 - 16:16
Limit: FCC_Part15_Band Edge(3m)	Engineer: Dandy Li
Probe: BBHA9120D_1-18GHz	Polarity: Horizontal
EUT: 2.4GHz HD Wireless Link	Power: DC 5V
Test Mode: Transmit by 2.5MHz Bandwidth at channel 2472MHz with Ant 1	

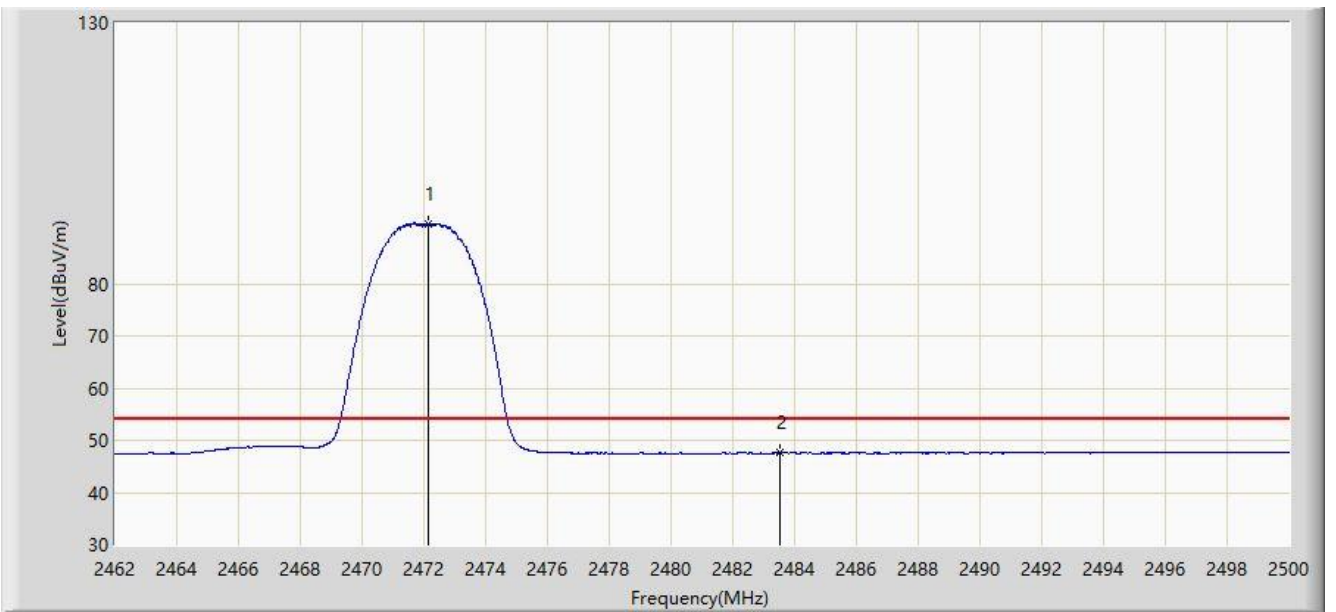

No	Flag	Mark	Frequency (MHz)	Measure Level (dBuV/m)	Reading Level (dBuV)	Margin (dB)	Limit (dBuV/m)	Factor (dB)	Type
1		*	2472.146	91.345	59.041	N/A	N/A	32.304	AV
2			2483.500	47.556	15.217	-6.444	54.000	32.340	AV

Note: Measure Level (dBuV/m) = Reading Level (dBuV) + Factor (dB)

Factor (dB) = Cable Loss (dB) + Antenna Factor (dB/m).

Site: AC1	Time: 2019/03/14 - 16:16
Limit: FCC_Part15_Band Edge(3m)	Engineer: Dandy Li
Probe: BBHA9120D_1-18GHz	Polarity: Vertical
EUT: 2.4GHz HD Wireless Link	Power: DC 5V
Test Mode: Transmit by 2.5MHz Bandwidth at channel 2472MHz with Ant 1	

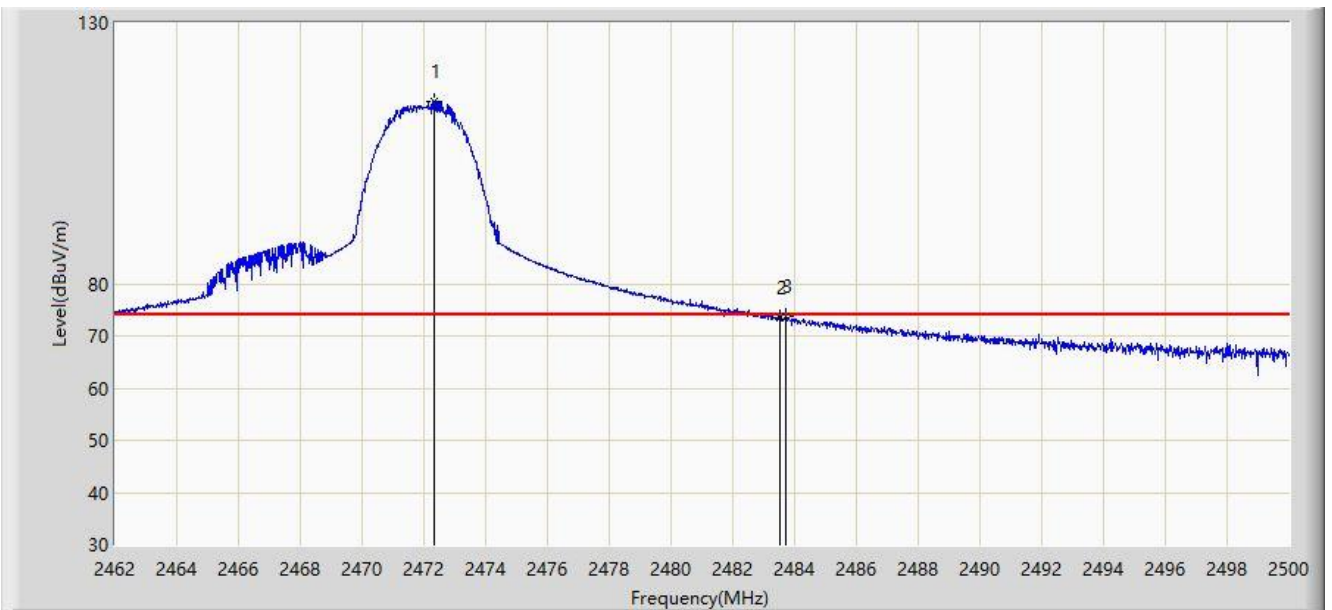

No	Flag	Mark	Frequency (MHz)	Measure Level (dBuV/m)	Reading Level (dBuV)	Margin (dB)	Limit (dBuV/m)	Factor (dB)	Type
1		*	2472.355	114.976	82.671	N/A	N/A	32.304	PK
2			2483.500	73.557	41.218	-0.443	74.000	32.340	PK
3			2483.736	73.662	41.322	-0.338	74.000	32.340	PK

Note: Measure Level (dBuV/m) = Reading Level (dBuV) + Factor (dB)

Factor (dB) = Cable Loss (dB) + Antenna Factor (dB/m).

Site: AC1	Time: 2019/03/14 - 16:16
Limit: FCC_Part15_Band Edge(3m)	Engineer: Dandy Li
Probe: BBHA9120D_1-18GHz	Polarity: Vertical
EUT: 2.4GHz HD Wireless Link	Power: DC 5V
Test Mode: Transmit by 2.5MHz Bandwidth at channel 2472MHz with Ant 1	

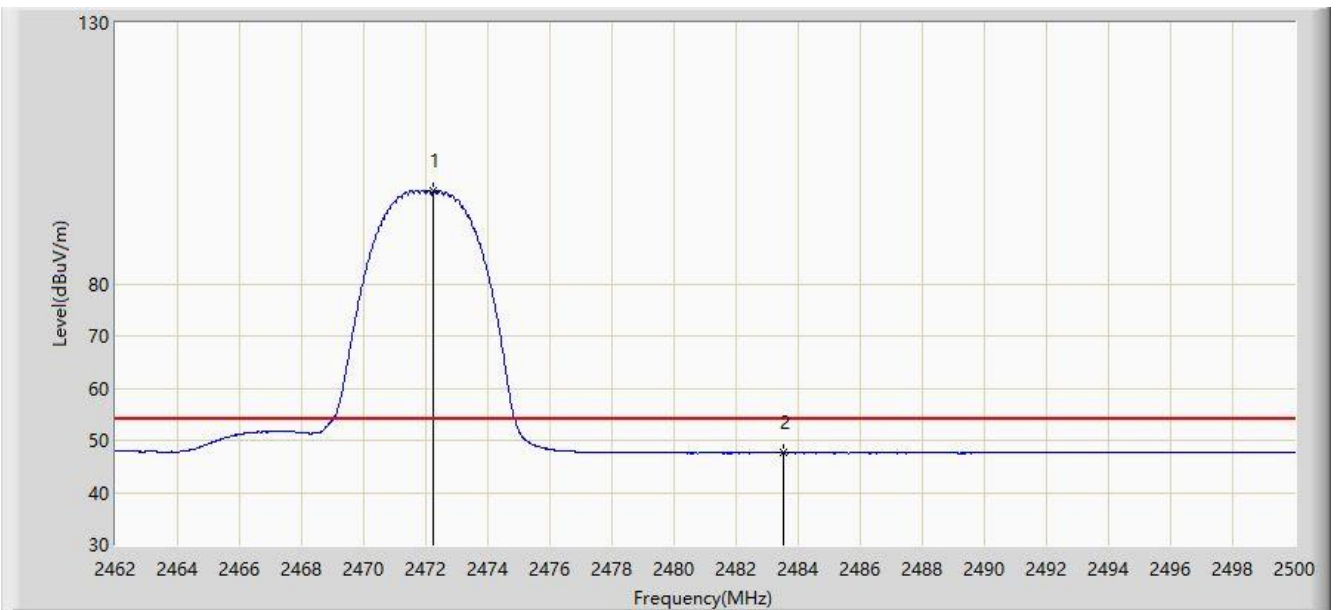

No	Flag	Mark	Frequency (MHz)	Measure Level (dBuV/m)	Reading Level (dBuV)	Margin (dB)	Limit (dBuV/m)	Factor (dB)	Type
1		*	2472.222	97.687	65.383	N/A	N/A	32.304	AV
2			2483.500	47.570	15.231	-6.430	54.000	32.340	AV

Note: Measure Level (dBuV/m) = Reading Level (dBuV) + Factor (dB)

Factor (dB) = Cable Loss (dB) + Antenna Factor (dB/m).

Site: AC1	Time: 2019/03/14 - 16:17
Limit: FCC_Part15_Band Edge(3m)	Engineer: Dandy Li
Probe: BBHA9120D_1-18GHz	Polarity: Horizontal
EUT: 2.4GHz HD Wireless Link	Power: DC 5V
Test Mode: Transmit by 10MHz Bandwidth at channel 2412MHz with Ant 2	

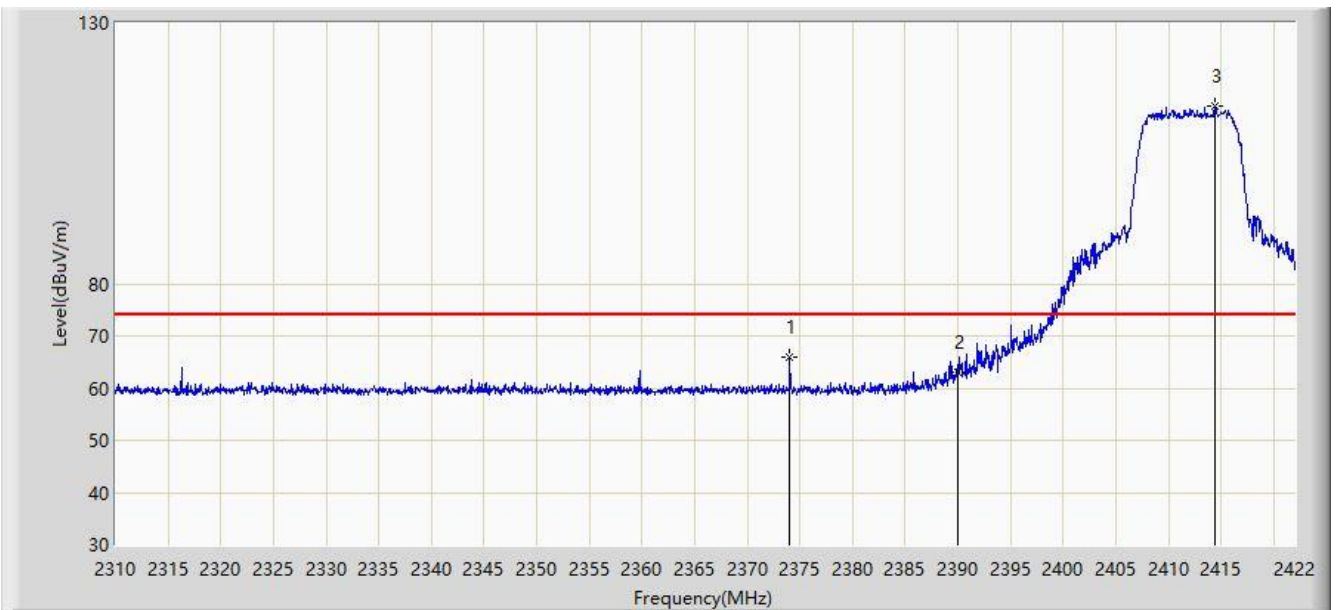

No	Flag	Mark	Frequency (MHz)	Measure Level (dBuV/m)	Reading Level (dBuV)	Margin (dB)	Limit (dBuV/m)	Factor (dB)	Type
1			2374.064	65.917	33.567	-8.083	74.000	32.350	PK
2			2390.000	63.005	30.678	-10.995	74.000	32.327	PK
3		*	2414.384	114.044	81.760	N/A	N/A	32.284	PK

Note: Measure Level (dB μ V/m) = Reading Level (dB μ V) + Factor (dB)

Factor (dB) = Cable Loss (dB) + Antenna Factor (dB/m).

Site: AC1	Time: 2019/03/14 - 16:17
Limit: FCC_Part15_Band Edge(3m)	Engineer: Dandy Li
Probe: BBHA9120D_1-18GHz	Polarity: Horizontal
EUT: 2.4GHz HD Wireless Link	Power: DC 5V
Test Mode: Transmit by 10MHz Bandwidth at channel 2412MHz with Ant 2	

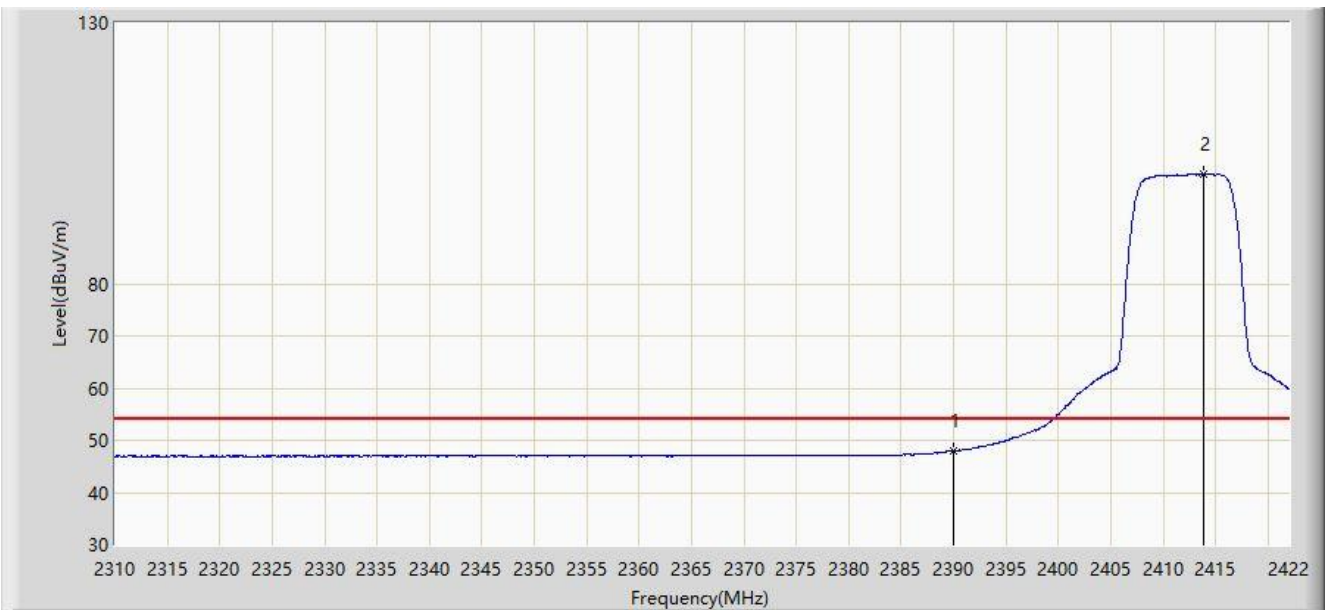

No	Flag	Mark	Frequency (MHz)	Measure Level (dBuV/m)	Reading Level (dBuV)	Margin (dB)	Limit (dBuV/m)	Factor (dB)	Type
1			2390.000	47.955	15.628	-6.045	54.000	32.327	AV
2		*	2413.880	101.001	68.717	N/A	N/A	32.284	AV

Note: Measure Level (dBuV/m) = Reading Level (dBuV) + Factor (dB)

Factor (dB) = Cable Loss (dB) + Antenna Factor (dB/m).

Site: AC1	Time: 2019/03/14 - 16:17
Limit: FCC_Part15_Band Edge(3m)	Engineer: Dandy Li
Probe: BBHA9120D_1-18GHz	Polarity: Vertical
EUT: 2.4GHz HD Wireless Link	Power: DC 5V
Test Mode: Transmit by 10MHz Bandwidth at channel 2412MHz with Ant 2	

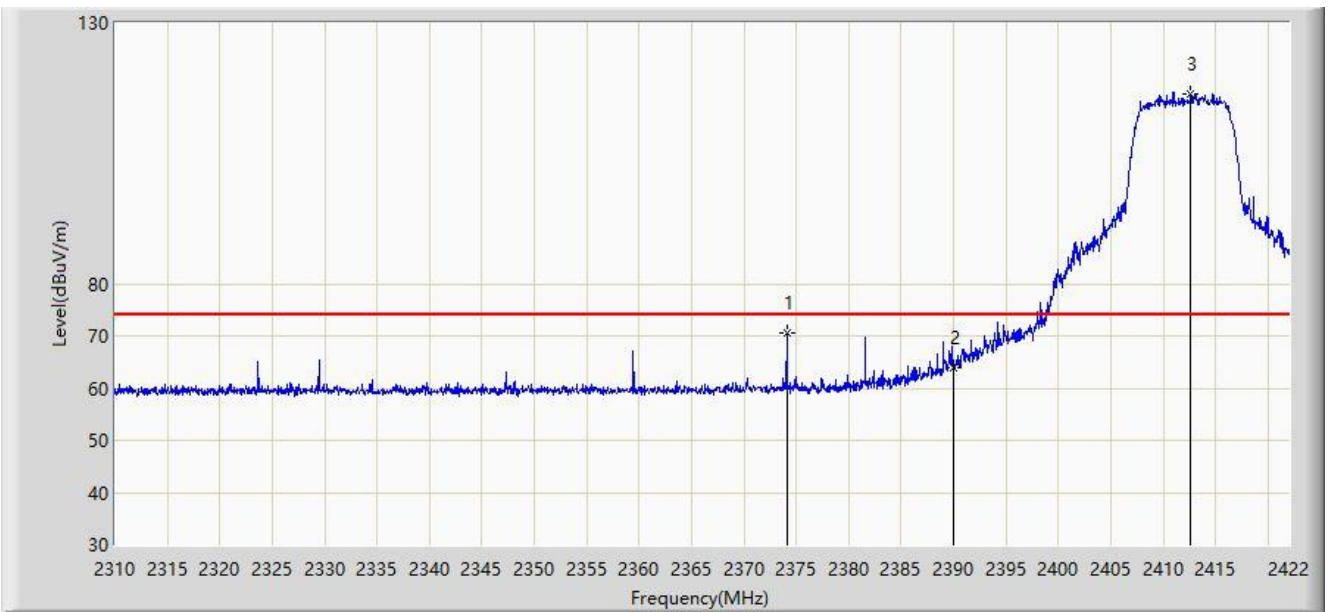

No	Flag	Mark	Frequency (MHz)	Measure Level (dBuV/m)	Reading Level (dBuV)	Margin (dB)	Limit (dBuV/m)	Factor (dB)	Type
1			2374.120	70.621	38.271	-3.379	74.000	32.350	PK
2			2390.000	63.804	31.477	-10.196	74.000	32.327	PK
3		*	2412.648	116.465	84.180	N/A	N/A	32.284	PK

Note: Measure Level (dB μ V/m) = Reading Level (dB μ V) + Factor (dB)

Factor (dB) = Cable Loss (dB) + Antenna Factor (dB/m).

Site: AC1	Time: 2019/03/14 - 16:17
Limit: FCC_Part15_Band Edge(3m)	Engineer: Dandy Li
Probe: BBHA9120D_1-18GHz	Polarity: Vertical
EUT: 2.4GHz HD Wireless Link	Power: DC 5V
Test Mode: Transmit by 10MHz Bandwidth at channel 2412MHz with Ant 2	

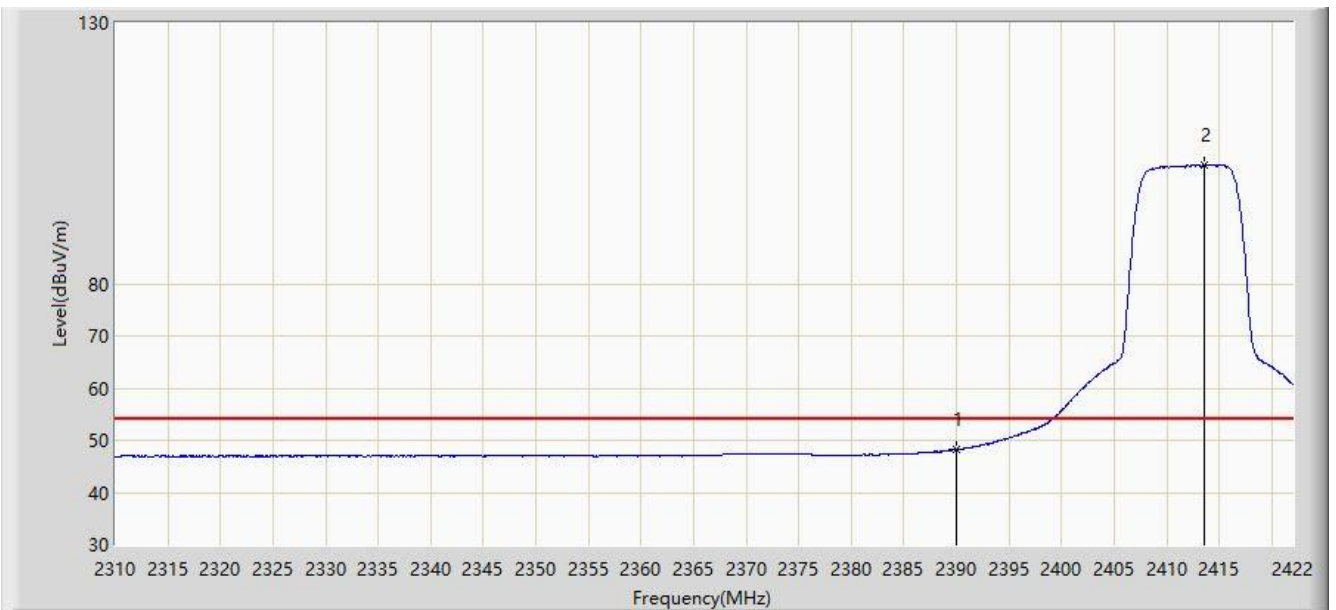

No	Flag	Mark	Frequency (MHz)	Measure Level (dBuV/m)	Reading Level (dBuV)	Margin (dB)	Limit (dBuV/m)	Factor (dB)	Type
1			2390.000	48.225	15.898	-5.775	54.000	32.327	AV
2		*	2413.600	102.866	70.582	N/A	N/A	32.284	AV

Note: Measure Level (dBuV/m) = Reading Level (dBuV) + Factor (dB)

Factor (dB) = Cable Loss (dB) + Antenna Factor (dB/m).

Site: AC1	Time: 2019/03/14 - 16:18
Limit: FCC_Part15_Band Edge(3m)	Engineer: Dandy Li
Probe: BBHA9120D_1-18GHz	Polarity: Horizontal
EUT: 2.4GHz HD Wireless Link	Power: DC 5V
Test Mode: Transmit by 10MHz Bandwidth at channel 2472MHz with Ant 2	

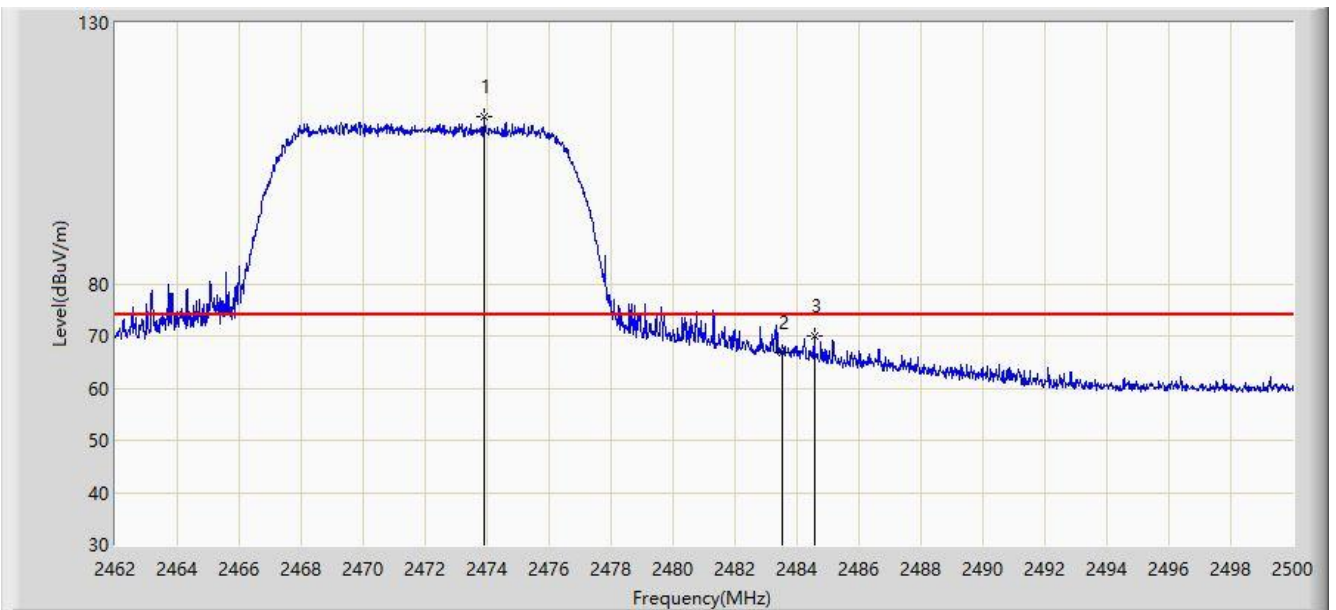

No	Flag	Mark	Frequency (MHz)	Measure Level (dBuV/m)	Reading Level (dBuV)	Margin (dB)	Limit (dBuV/m)	Factor (dB)	Type
1		*	2473.913	112.106	79.797	N/A	N/A	32.308	PK
2			2483.500	66.793	34.454	-7.207	74.000	32.340	PK
3			2484.553	69.936	37.593	-4.064	74.000	32.344	PK

Note: Measure Level (dBuV/m) = Reading Level (dBuV) + Factor (dB)

Factor (dB) = Cable Loss (dB) + Antenna Factor (dB/m).

Site: AC1	Time: 2019/03/14 - 16:18
Limit: FCC_Part15_Band Edge(3m)	Engineer: Dandy Li
Probe: BBHA9120D_1-18GHz	Polarity: Horizontal
EUT: 2.4GHz HD Wireless Link	Power: DC 5V
Test Mode: Transmit by 10MHz Bandwidth at channel 2472MHz with Ant 2	

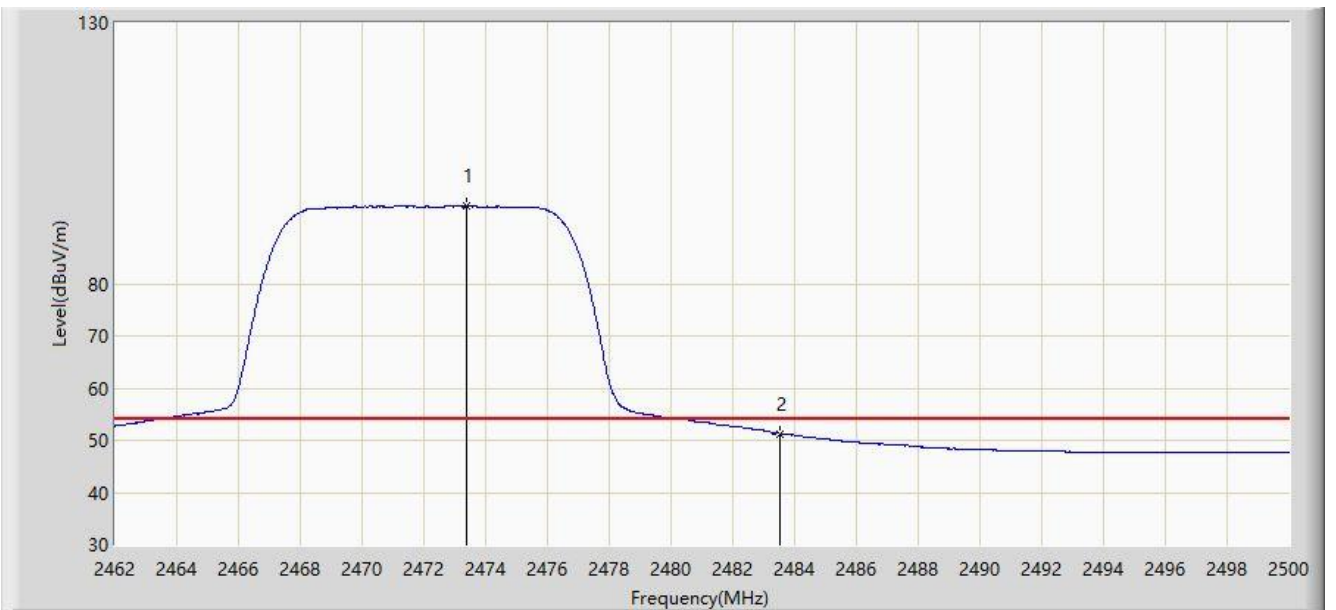

No	Flag	Mark	Frequency (MHz)	Measure Level (dBuV/m)	Reading Level (dBuV)	Margin (dB)	Limit (dBuV/m)	Factor (dB)	Type
1		*	2473.400	94.888	62.581	N/A	N/A	32.307	AV
2			2483.500	51.298	18.959	-2.702	54.000	32.340	AV

Note: Measure Level (dBuV/m) = Reading Level (dBuV) + Factor (dB)

Factor (dB) = Cable Loss (dB) + Antenna Factor (dB/m).

Site: AC1	Time: 2019/03/14 - 16:18
Limit: FCC_Part15_Band Edge(3m)	Engineer: Dandy Li
Probe: BBHA9120D_1-18GHz	Polarity: Vertical
EUT: 2.4GHz HD Wireless Link	Power: DC 5V
Test Mode: Transmit by 10MHz Bandwidth at channel 2472MHz with Ant 2	

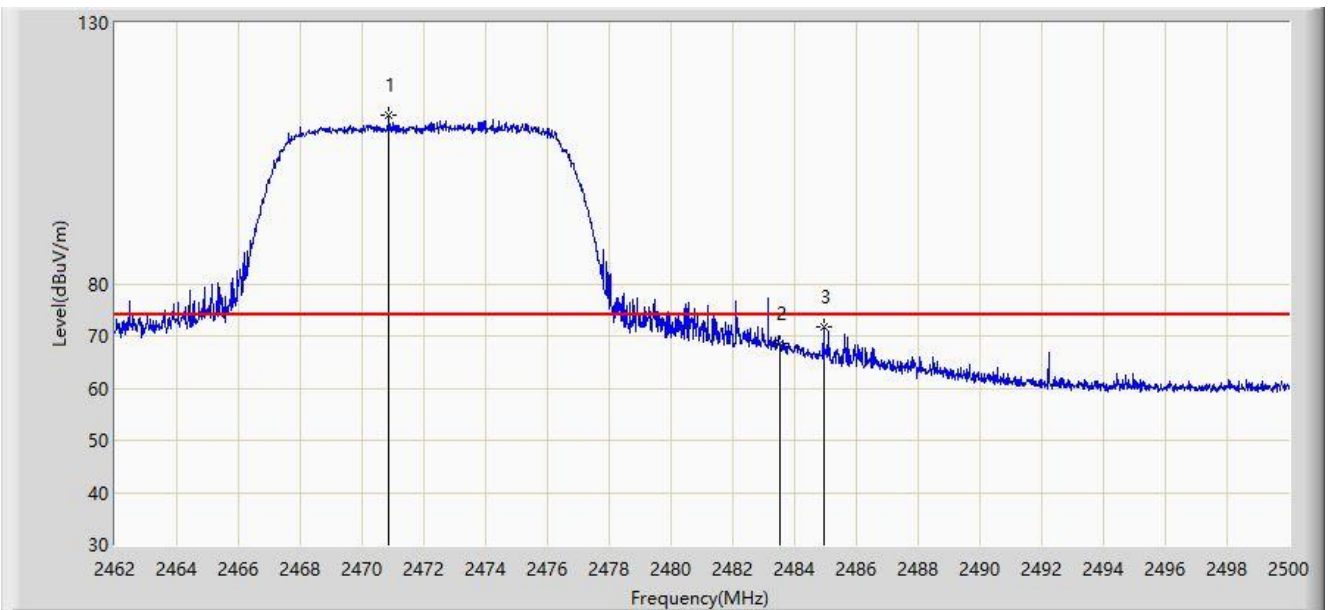

No	Flag	Mark	Frequency (MHz)	Measure Level (dBuV/m)	Reading Level (dBuV)	Margin (dB)	Limit (dBuV/m)	Factor (dB)	Type
1		*	2470.873	112.178	79.877	N/A	N/A	32.301	PK
2			2483.500	68.658	36.319	-5.342	74.000	32.340	PK
3			2484.933	71.812	39.467	-2.188	74.000	32.345	PK

Note: Measure Level (dBuV/m) = Reading Level (dBuV) + Factor (dB)

Factor (dB) = Cable Loss (dB) + Antenna Factor (dB/m).

Site: AC1	Time: 2019/03/14 - 16:18
Limit: FCC_Part15_Band Edge(3m)	Engineer: Dandy Li
Probe: BBHA9120D_1-18GHz	Polarity: Vertical
EUT: 2.4GHz HD Wireless Link	Power: DC 5V
Test Mode: Transmit by 10MHz Bandwidth at channel 2472MHz with Ant 2	

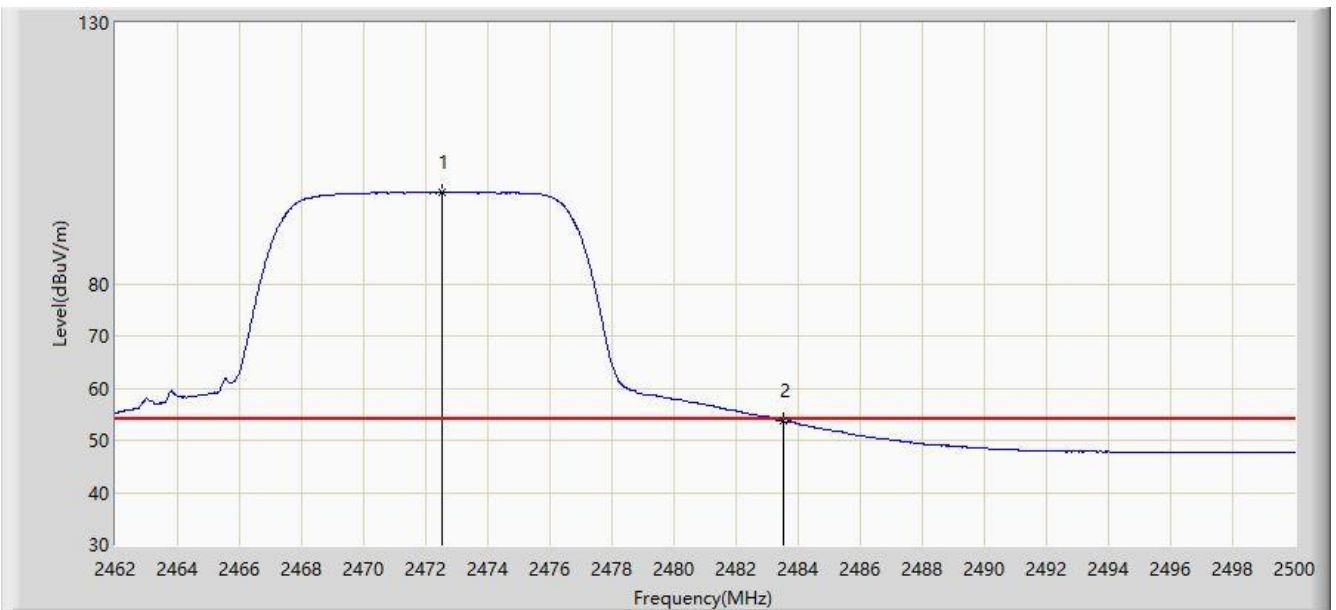

No	Flag	Mark	Frequency (MHz)	Measure Level (dBuV/m)	Reading Level (dBuV)	Margin (dB)	Limit (dBuV/m)	Factor (dB)	Type
1		*	2472.507	97.572	65.267	N/A	N/A	32.305	AV
2			2483.500	53.754	21.415	-0.246	54.000	32.340	AV

Note: Measure Level (dBuV/m) = Reading Level (dBuV) + Factor (dB)

Factor (dB) = Cable Loss (dB) + Antenna Factor (dB/m).

7.8. AC Conducted Emissions Measurement

7.8.1. Test Limit

FCC Part 15 Subpart C Paragraph 15.207 Limits		
Frequency (MHz)	QP (dBuV)	AV (dBuV)
0.15 - 0.50	66 - 56	56 - 46
0.50 - 5.0	56	46
5.0 - 30	60	50

Note 1: The lower limit shall apply at the transition frequencies.

Note 2: The limit decreases linearly with the logarithm of the frequency in the range 0.15MHz to 0.5MHz.

7.8.2. Test Setup

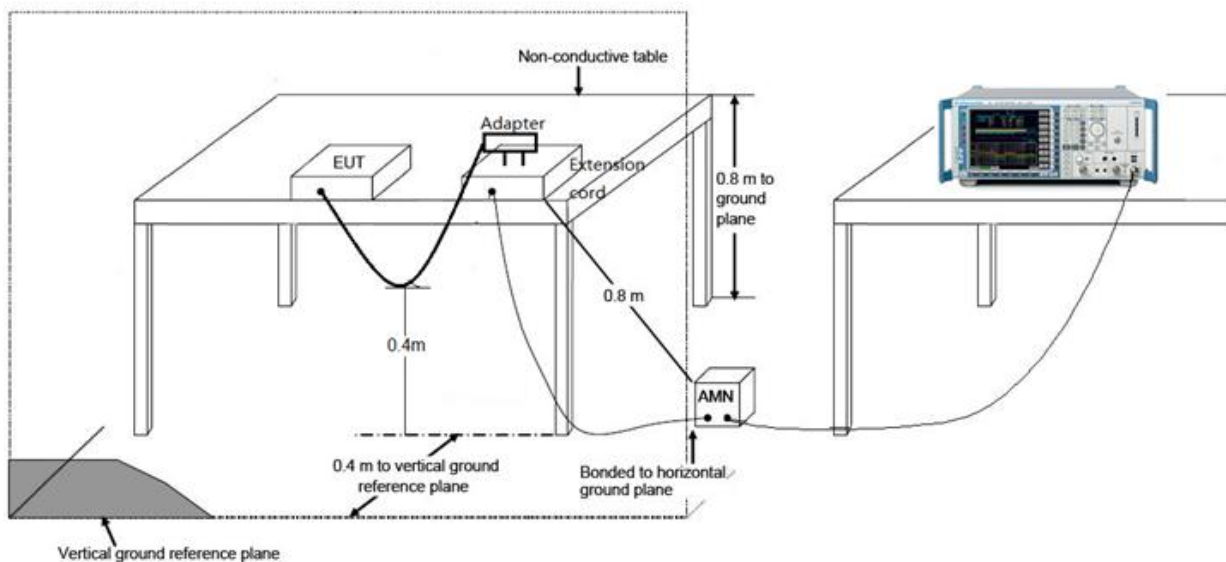

7.8.3. Test Result

Site: SR2	Time: 2019/03/14 - 16:40
Limit: FCC_Part15.107_CE_AC Power_ClassB	Engineer: Liz Yuan
Probe: ENV216_101683_Filter On	Polarity: Line
EUT: 2.4GHz HD Wireless Link	Power: DC 5V
Worst Case Mode: Transmit by 10MHz Bandwidth at channel 2442MHz with Ant 1	

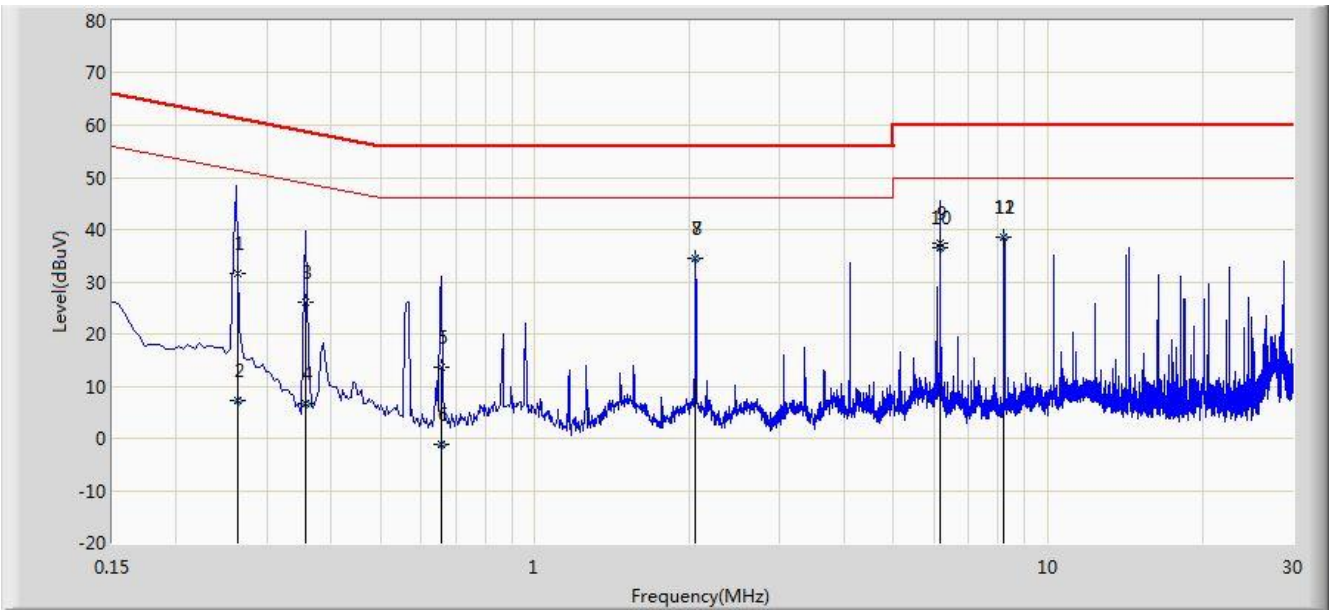

No	Flag	Mark	Frequency (MHz)	Measure Level (dBuV)	Reading Level (dBuV)	Margin (dB)	Limit (dBuV)	Factor (dB)	Type
1			0.263	31.574	21.600	-29.762	61.336	9.974	QP
2			0.263	7.174	-2.800	-44.162	51.336	9.974	AV
3			0.357	26.150	16.100	-32.648	58.798	10.051	QP
4			0.357	6.550	-3.500	-42.248	48.798	10.051	AV
5			0.658	13.701	3.616	-42.299	56.000	10.085	QP
6			0.658	-1.235	-11.320	-47.235	46.000	10.085	AV
7			2.054	34.476	24.606	-21.524	56.000	9.869	QP
8			2.054	34.461	24.592	-11.539	46.000	9.869	AV
9			6.166	37.523	27.409	-22.477	60.000	10.114	QP
10			6.166	36.565	26.451	-13.435	50.000	10.114	AV
11			8.214	38.665	28.500	-21.335	60.000	10.165	QP
12		*	8.214	38.465	28.300	-11.535	50.000	10.165	AV

Note: Measure Level (dBμV) = Reading Level (dBμV) + Factor (dB)

Factor (dB) = Cable Loss (dB) + LISN Factor (dB).

Site: SR2	Time: 2019/03/14 - 16:49
Limit: FCC_Part15.107_CE_AC Power_ClassB	Engineer:Liz Yuan
Probe: ENV216_101683_Filter On	Polarity: Neutral
EUT: 2.4GHz HD Wireless Link	Power: DC 5V
Worst Case Mode: Transmit by 10MHz Bandwidth at channel 2442MHz with Ant 1	

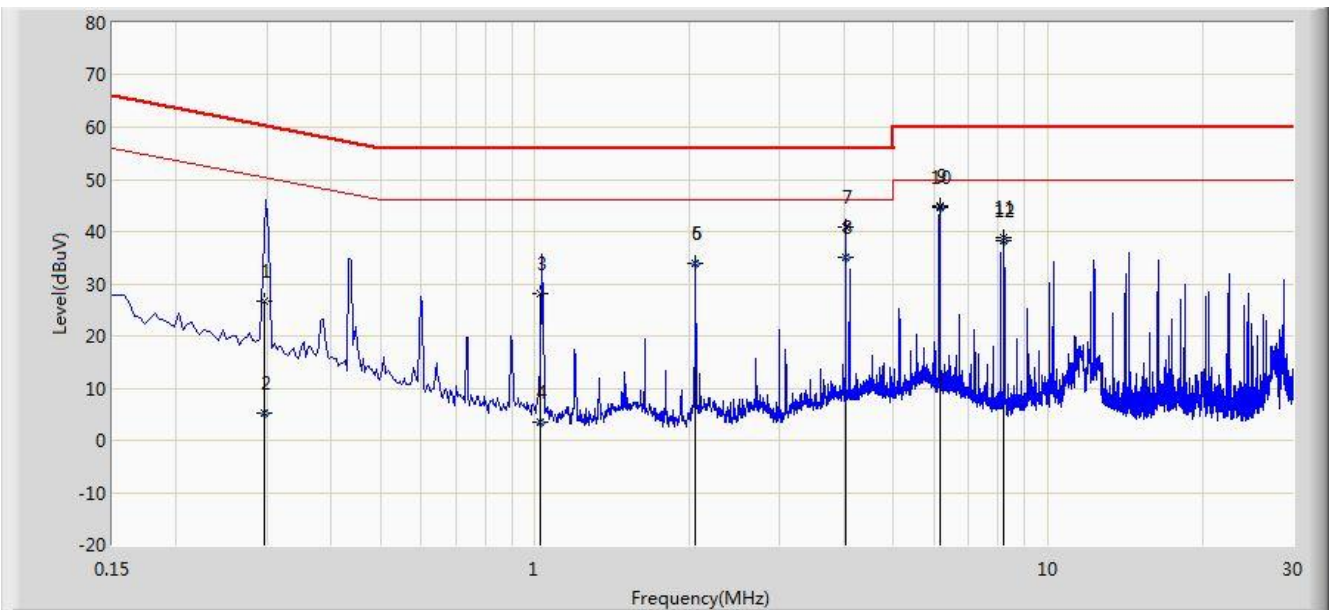

No	Flag	Mark	Frequency (MHz)	Measure Level (dBuV)	Reading Level (dBuV)	Margin (dB)	Limit (dBuV)	Factor (dB)	Type
1			0.297	26.585	16.549	-33.752	60.337	10.035	QP
2			0.297	5.287	-4.748	-45.050	50.337	10.035	AV
3			1.027	28.008	18.100	-27.992	56.000	9.908	QP
4			1.027	3.608	-6.300	-42.392	46.000	9.908	AV
5			2.054	33.955	24.083	-22.045	56.000	9.872	QP
6			2.054	33.935	24.063	-12.065	46.000	9.872	AV
7			4.034	40.874	30.900	-15.126	56.000	9.975	QP
8			4.034	34.974	25.000	-11.026	46.000	9.975	AV
9			6.158	45.025	34.900	-14.975	60.000	10.125	QP
10		*	6.158	44.625	34.500	-5.375	50.000	10.125	AV
11			8.214	38.705	28.523	-21.295	60.000	10.182	QP
12			8.214	38.188	28.005	-11.812	50.000	10.182	AV

Note: Measure Level (dBμV) = Reading Level (dBμV) + Factor (dB)

Factor (dB) = Cable Loss (dB) + LISN Factor (dB).

8. CONCLUSION

The data collected relate only the item(s) tested and show that the device is in compliance with Part 15C of the FCC Rules.

_____ The End _____

Appendix A – Test Setup Photograph

Refer to “ 1902RSU015-UT” file.

Appendix B – EUT Photograph

Refer to “ 1902RSU015-UE” file.