

TEST REPORT

Report Number. : 14888706-E3V2

Applicant : ENERGOUS CORPORATION
3590 NORTH FIRST STREET,
SUITE 210,
SAN JOSE, CA 95134, U.S.A.

Model : VN55, VN55-E

Brand : ENERGOUS

FCC ID : 2ADNG-VN55

IC : 23686-VN55

EUT Description : WIRELESS CHARGER

Test Standard(s) : FCC 47 CFR PART 15 C
ISED RSS-247 ISSUE 3
ISED RSS-GEN ISSUE 5 + A1 +A2

Date Of Issue:
2023-10-17

Prepared by:
UL VERIFICATION SERVICES INC.
47173 Benicia Street
Fremont, CA 94538 U.S.A.
TEL: (510) 319-4000
FAX: (510) 661-0888



REPORT REVISION HISTORY

Rev.	Issue Date	Revisions	Revised By
V1	2023-08-14	Initial Issue	--
V2	2023-10-17	Corrected FCC standard wording and revised Section 6.5 C2PC description. Added additional model number. Added Section model number difference description. Revised RSS 247 to Issue 3.	Tina Chu

TABLE OF CONTENTS

REPORT REVISION HISTORY	2
TABLE OF CONTENTS	3
1. ATTESTATION OF TEST RESULTS	5
2. TEST RESULTS SUMMARY	7
3. TEST METHODOLOGY	8
4. FACILITIES AND ACCREDITATION	8
5. DECISION RULES AND MEASUREMENT UNCERTAINTY	9
5.1. METROLOGICAL TRACEABILITY	9
5.2. DECISION RULES.....	9
5.3. MEASUREMENT UNCERTAINTY.....	9
5.4. SAMPLE CALCULATION	10
6. EQUIPMENT UNDER TEST	11
6.1. EUT DESCRIPTION	11
6.2. DESCRIPTION OF MODEL NUMBER DIFFERENCE	11
6.3. MAXIMUM OUTPUT POWER.....	11
6.4. DESCRIPTION OF AVAILABLE ANTENNAS AND CABLE LOSS.....	11
6.5. DESCRIPTION OF CLASS II PERMISSIVE CHANGE	11
6.6. SOFTWARE AND FIRMWARE.....	11
6.7. WORST-CASE CONFIGURATION AND MODE.....	12
6.8. DESCRIPTION OF TEST SETUP.....	13
7. MEASUREMENT METHOD.....	15
8. TEST AND MEASUREMENT EQUIPMENT	16
9. ANTENNA PORT TEST RESULTS	17
9.1. ON TIME AND DUTY CYCLE.....	17
9.2. OUTPUT POWER.....	18
9.3. AVERAGE POWER.....	19
10. RADIATED TEST RESULTS	20
10.1. LIMITS AND PROCEDURE.....	20
10.2. TRANSMITTER ABOVE 1 GHz.....	22

10.3.	WORST CASE BELOW 30MHZ.....	40
10.4.	WORST CASE BELOW 1 GHZ.....	42
10.5.	WORST CASE 18-26 GHZ.....	44
11.	SETUP PHOTOS	46

1. ATTESTATION OF TEST RESULTS

COMPANY NAME: ENERGOUS CORPORATION
3590 NORTH FIRST STREET,
SUITE 210,
SAN JOSE, CA 95134, U.S.A.

EUT DESCRIPTION: WIRELESS CHARGER

MODEL: VN55, VN55-E (TESTED MODEL NUMBER)

BRAND: ENERGOUS

SERIAL NUMBER: D003778 (CONDUCTED/RADIATED)

SAMPLE RECEIPT DATE: 2023-07-13

DATE TESTED: 2023-07-13 TO 2023-07-24

APPLICABLE STANDARDS	
STANDARD	TEST RESULTS
FCC 47 CFR Part 15 C	Complies
ISED RSS-247 Issue 3	Complies
ISED RSS-GEN Issue 5 + A1 + A2	Complies

UL Verification Services Inc. tested the above equipment in accordance with the requirements set forth in the above standards. The test results show that the equipment tested is capable of demonstrating compliance with the requirements as documented in this report.

The results documented in this report apply only to the tested sample, under the conditions and modes of operation as described herein. It is the manufacturer's responsibility to assure that additional production units of this model are manufactured with identical electrical and mechanical components. All samples tested were in good operating condition throughout the entire test program. Measurement Uncertainties are published for informational purposes only and were not taken into account unless noted otherwise.

This document may not be altered or revised in any way unless done so by UL Verification Services Inc. and all revisions are duly noted in the revisions section. Any alteration of this document not carried out by UL Verification Services Inc. will constitute fraud and shall nullify the document.

Approved & Released For
UL Verification Services Inc. By:



Dan Corona
Operations Leader
Consumer Technology Division
UL Verification Services Inc.

Prepared By:



Gerardo Abrego
Senior Test Engineer
Consumer Technology Division
UL Verification Services Inc.

Reviewed By:



Tina Chu
Senior Project Engineer
Consumer Technology Division
UL Verification Services Inc.

2. TEST RESULTS SUMMARY

This report contains data provided by the customer which can impact the validity of results. UL Verification Services Inc. is only responsible for the validity of results after the integration of the data provided by the customer.

Below is a list of the data provided by the customer:

- 1) Antenna gain and type (see section 6.3)
- 2) Cable Loss (see section 6.3)

FCC Clause	ISED Clause	Requirement	Result	Comment
See Comment	See Comment	Duty Cycle	Reporting purposes only	ANSI C63.10 Section 11.6.
-	RSS-GEN 6.7	99% OBW	Not performed	Antenna changed only, no impacted conducted test items
15.247 (a) (2)	RSS-247 5.2 (a)	6dB BW	Not performed	Antenna changed only, no impacted conducted test items
15.247 (b) (3)	RSS-247 5.4 (d)	Output Power	Complies	None.
See Comment	See Comment	Average power	Reporting purposes only	Per ANSI C63.10, Section 11.9.2.3.2.
15.247 (e)	RSS-247 5.2 (b)	PSD	Not performed	Antenna changed only, no impacted conducted test items
15.247 (d)	RSS-247 5.5	Conducted Spurious Emissions	Not performed	Antenna changed only, no impacted conducted test items
15.209, 15.205	RSS-GEN 8.9, 8.10	Radiated Emissions	Complies	None.
15.207	RSS-Gen 8.8	AC Mains Conducted Emissions	Not performed	Antenna changed only, no impacted on the AC powerline test.

3. TEST METHODOLOGY

The tests documented in this report were performed in accordance with FCC 47 CFR Part 2, FCC 47 CFR Part 15, ANSI C63.10-2013, KDB 558074 D01 15.247 Meas Guidance v05r02, KDB 414788 D01 Radiated Test Site v01r01, RSS-GEN Issue 5 + A1 + A2, and RSS-247 Issue 3.

4. FACILITIES AND ACCREDITATION

UL Verification Services Inc. is accredited by A2LA, Certificate Number 0751.05, for all testing performed within the scope of this report. Testing was performed at the locations noted below.

	Address	ISED CABID	ISED Company Number	FCC Registration
<input checked="" type="checkbox"/>	Building 1: 47173 Benicia Street Fremont, CA 94538, U.S.A	US0104	2324A	550739
<input type="checkbox"/>	Building 2: 47266 Benicia Street Fremont, CA 94538, U.S.A			
<input checked="" type="checkbox"/>	Building 4: 47658 Kato Rd Fremont, CA 94538, U.S.A			

5. DECISION RULES AND MEASUREMENT UNCERTAINTY

5.1. METROLOGICAL TRACEABILITY

All test and measuring equipment utilized to perform the tests documented in this report are calibrated on a regular basis, with a maximum time between calibrations of one year or the manufacturers' recommendation, whichever is less, and where applicable is traceable to recognized national standards.

5.2. DECISION RULES

The Decision Rule is based on Simple Acceptance in accordance with ISO Guide 98-4:2012 Clause 8.2. (Measurement uncertainty is not taken into account when stating conformity with a specified requirement.)

5.3. MEASUREMENT UNCERTAINTY

Where relevant, the following measurement uncertainty levels have been estimated for tests performed on the apparatus:

PARAMETER	U _{Lab}
Radio Frequency (Spectrum Analyzer)	141.16 Hz
Occupied Bandwidth	1.22%
Power Spectral Density	2.47 dB
RF Power Measurement Direct Method Using Power Meter	1.3 dB (PK) / 0.45 dB (AV)
Unwanted Emissions, Conducted	1.94 dB
Worst Case Conducted Disturbance, 9kHz to 0.15 MHz	3.78 dB
Worst Case Conducted Disturbance, 0.15 to 30 MHz	3.40 dB
Worst Case Radiated Disturbance, 9kHz to 30 MHz	2.87 dB
Worst Case Radiated Disturbance, 30 to 1000 MHz	6.01 dB
Worst Case Radiated Disturbance, 1000 to 18000 MHz	4.73 dB
Worst Case Radiated Disturbance, 18000 to 26000 MHz	4.51 dB
Worst Case Radiated Disturbance, 26000 to 40000 MHz	5.29 dB
Time Domain Measurements	3.39%
Temperature	0.57°C
Humidity	3.39%
DC Supply Voltages	0.57%

Uncertainty figures are valid to a confidence level of 95%.

5.4. SAMPLE CALCULATION

RADIATED EMISSIONS

Where relevant, the following sample calculation is provided:

Field Strength (dBuV/m) = Measured Voltage (dBuV) + Antenna Factor (dB/m) + Cable Loss (dB) – Preamp Gain (dB)

$$36.5 \text{ dBuV} + 18.7 \text{ dB/m} + 0.6 \text{ dB} - 26.9 \text{ dB} = 28.9 \text{ dBuV/m}$$

MAINS CONDUCTED EMISSIONS

Where relevant, the following sample calculation is provided:

Final Voltage (dBuV) = Measured Voltage (dBuV) + Cable Loss (dB) + Limiter Factor (dB) + LISN Insertion Loss.

$$36.5 \text{ dBuV} + 0 \text{ dB} + 10.1 \text{ dB} + 0 \text{ dB} = 46.6 \text{ dBuV}$$

6. EQUIPMENT UNDER TEST

6.1. EUT DESCRIPTION

The EUT is a stand-alone wireless charger with BLE and Zigbee 802.15.4 that is mounted on a ceiling. The wireless charger transmits power via a frequency hopping signal between 907MHz to 920MHz and a DTS Zigbee 802.15.4 signal between 2402MHz and 2480MHz, and charges multiple receivers at a time.

This report documents test results of the Zigbee 802.15.4 radio portion (only supports 250kbps) of the wireless charger.

6.2. DESCRIPTION OF MODEL NUMBER DIFFERENCE

Model number: VN55: Original filing for EUT with internal antenna.

Model number: VN55-E: Class II permissive change filing for EUT with external antenna.

Tested model number: VN55-E.

6.3. MAXIMUM OUTPUT POWER

Refer to original test report 14262501-E3V2 for max output power.

6.4. DESCRIPTION OF AVAILABLE ANTENNAS AND CABLE LOSS

The antenna(s) gain and type, cable loss as provided by the manufacturer' are as follows:

The Zigbee radio utilizes one External Omni Dipole antenna, with a maximum gain of 6dBi.

Cable loss: 0.5 dB

6.5. DESCRIPTION OF CLASS II PERMISSIVE CHANGE

This class II permissive change is to add a new external antenna type and the highest gain to support SISO for all technologies and additional range on the 900MHz radio from 917.2MHz-918.8MHz to 907MHz-920MHz via firmware changed.

6.6. SOFTWARE AND FIRMWARE

The EUT firmware installed during testing was brg_energous_v0_3.15.44

The test utility software used during testing was brg_energous_v0_3.15.44

6.7. WORST-CASE CONFIGURATION AND MODE

Radiated band edge were performed with the EUT was set to transmit at the Low /2475MHz/High channels measured power.

Radiated harmonics, and spurious emissions from 1 GHz to 18GHz were performed with the EUT was set to transmit at the Low/Mid/High channels with highest output power as worst-case scenario.

Radiated emission below 30MHz, below 1GHz, above 18GHz were performed with the EUT was set to transmit at the channel with highest output power as worst-case scenario.

The EUT is a ceiling mounted device, and it has one USB type C port for power only. The fundamental of the antenna was investigated in three orthogonal orientations X,Y(upright), it was determined that Y orientation was worst-case orientation; therefore, all final radiated testing was performed with the EUT in Y orientation.

Worst-case data rate as provided by the client was:
Zigbee 802.15.4: 250 kbps.

WPT band and 2.4G Zigbee 802.15.4 transmit simultaneously, simultaneous operation result of the radiated emissions is documented in UL document 14888706-E1 WPT report.

6.8. DESCRIPTION OF TEST SETUP

SUPPORT TEST EQUIPMENT						
Description	Manufacturer	Model	Serial Number	FCC ID/ DoC		
Laptop	Dell	Precision 5520	FK7QHM2	DoC		
Laptop AC/DC adapter	Dell	HA130PM130	CN-0V363H-CH200-84A-03QN-A01	DoC		
AC/DC Switching Adapter	CUI Inc.	HDP-QB05010U	-	DoC		
I/O CABLES (RF CONDUCTED TEST)						
Cable No.	Port	# of Identical Ports	Connector Type	Cable Type	Cable Length (m)	Remarks
1	AC	1	AC	Un-shielded	1	AC Mains to AC/DC Adapter
2	DC	1	DC	Un-shielded	1.5	AC/DC Adapter to Laptop
3	USB to UART	1	USB A	Un-shielded	1.5	Laptop to EUT
4	USB	1	USB Type C	Shielded	1	EUT to AC/DC adapter
5	Antenna	1	SMA	Un-shielded	0.3	To spectrum analyzer
I/O CABLES (RF RADIATED TEST)						
Cable No.	Port	# of Identical Ports	Connector Type	Cable Type	Cable Length (m)	Remarks
1	USB	1	USB Type C	Shielded	1	

TEST SETUP-RF CONDUCTED TEST

The EUT was powered by AC/DC adapter via USB cable. Test software exercised the EUT. Laptop was removed after test setup.

SETUP DIAGRAMS

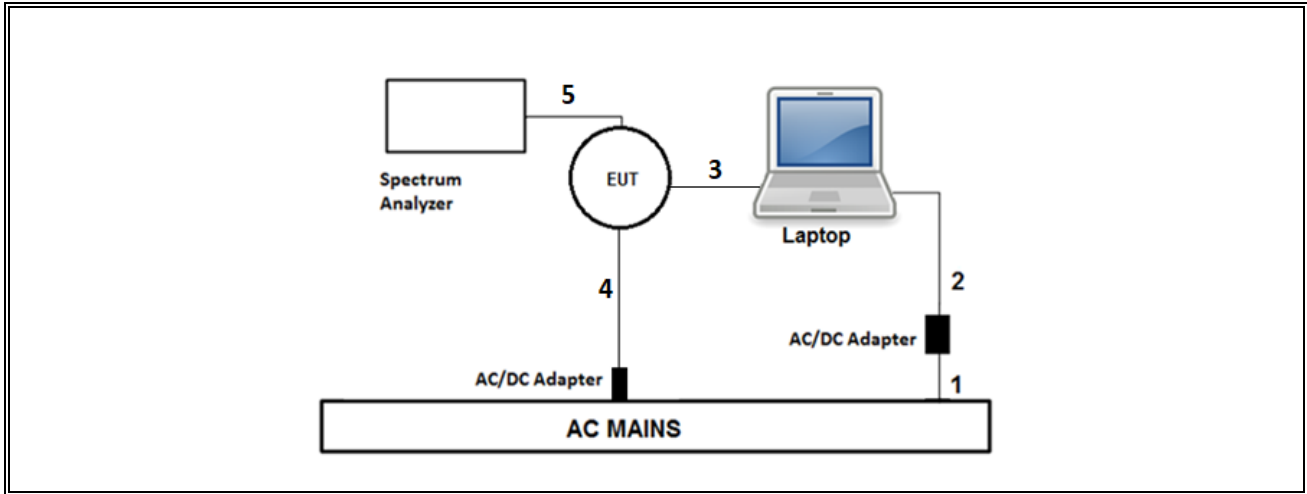

TEST SETUP- RADIATED TEST

The EUT was powered by AC/DC adapter via USB cable. Test software exercised the EUT. Laptop was removed after test setup.

SETUP DIAGRAM

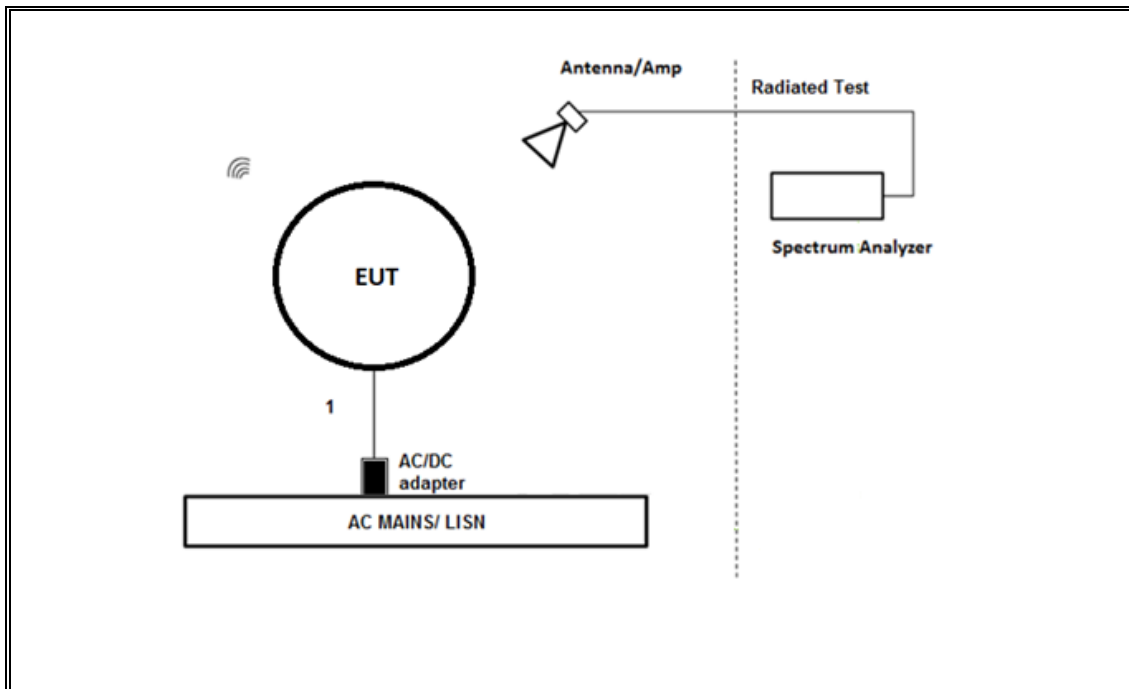

7. MEASUREMENT METHOD

Output Power: ANSI C63.10 Subclause -11.9.1.3 Method PKPM1 Peak-reading power meter

Output Power: ANSI C63.10 Subclause -11.9.2.3.2 Method AVGPM-G (Measurement using a gated RF average-reading power meter)

Radiated emissions non-restricted frequency bands: ANSI C63.10 Subclause -11.11

Radiated emissions restricted frequency bands: ANSI C63.10 Subclause -11.12.1

Band-edge: ANSI C63.10 Subclause -11.13.3.4 Integration method -Trace averaging across ON and OFF times DC correction

Radiated Spurious Emissions Below 30MHz: ANSI C63.10-2013 Section 6.4

8. TEST AND MEASUREMENT EQUIPMENT

The following test and measurement equipment was utilized for the tests documented in this report:

TEST EQUIPMENT LIST					
Description	Manufacturer	Model	ID Num	Cal Due	Last Cal
Antenna, Passive Loop 30Hz - 1MHz	ELECTRO METRICS	EM-6871	170013	2023-07-28	2022-07-28
Antenna, Passive Loop 100KHz - 30MHz	ELECTRO METRICS	EM-6872	170015	2023-07-28	2022-07-28
Antenna, Broadband Hybrid, 30MHz to 3000MHz	Sunol Sciences Corp.	JB3	174374	2024-04-30	2023-04-05
Amplifier, 10KHz to 1GHz, 32dB	SONOMA INSTRUMENT	310N	29654	2024-07-31	2023-07-13
Thermometer	Control Company	14-650-118	160656	2024-04-30	2023-04-24
EMI TEST RECEIVER	Rohde & Schwarz	ESW44	191429	2024-02-29	2023-02-15
Antenna, Horn 1-18GHz	ETS-Lindgren (Cedar Park, Texas)	3117	206806	2023-10-07	2022-10-07
RF Filter Box, 1-18GHz	FREMONT	SAC-L1	171013	2023-10-31	2021-10-31
Thermometer - Digital	Control Company	14-650-118	175731	2024-02-29	2023-02-08
EMI TEST RECEIVER	Rohde & Schwarz	ESW44	191429	2024-02-29	2023-02-15
Antenna, Horn 18 to 26.5GHz	ARA	MWH-1826/B	199659	2023-12-06	2022-12-06
Rf Amplifier, 18-26.5GHz, 60dB gain	AMPLICAL	AMP18G26.5-60	234683	2024-03-29	2023-02-18
Spectrum Analyzer, PSA, 3Hz to 26.5GHz	Keysight Technologies Inc	E4440A	125178	2024-02-29	2023-02-06
Power Meter, P-series single channel	Keysight Technologies Inc	N1911A	90757	2024-02-29	2023-02-03
Power Sensor, P - series, 50MHz to 18GHz, Wideband	Keysight Technologies Inc	N1921A	90419	2024-02-29	2023-02-03
UL TEST SOFTWARE LIST					
Radiated Software	UL	UL EMC	Rev 9.5, Jan 03, 2020		

9. ANTENNA PORT TEST RESULTS

9.1. ON TIME AND DUTY CYCLE

LIMITS

None; for reporting purposes only.

PROCEDURE

ANSI C63.10 Section 11.6 Zero-Span Spectrum Analyzer Method.

ON TIME AND DUTY CYCLE RESULTS

Mode	ON Time B (msec)	Period (msec)	Duty Cycle x (linear)	Duty Cycle (%)	Duty Cycle Correction Factor (dB)	1/B Minimum VBW (kHz)
2.4GHz Band						
Zigbee 802.15.4	8.35	8.45	0.988	98.82	0.00	0.010

Test Engineer	CH 27342
---------------	----------

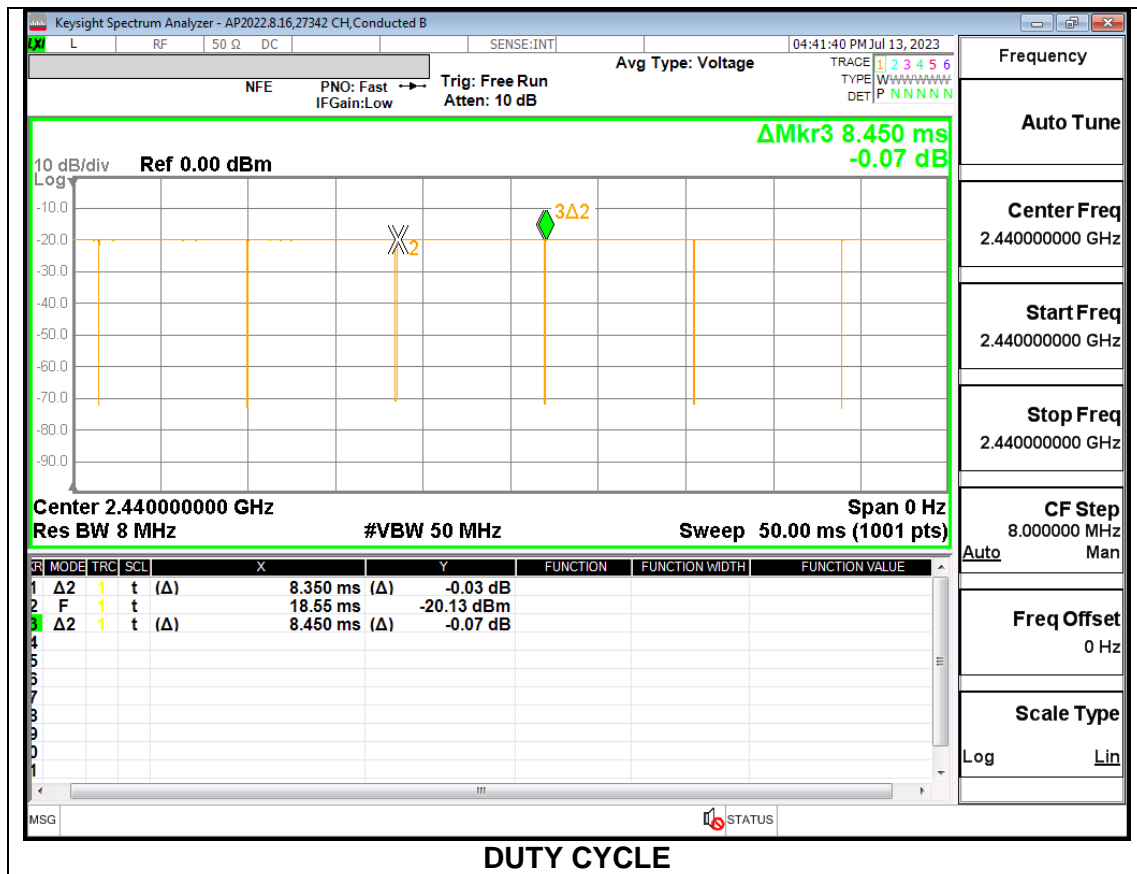

9.2. OUTPUT POWER

LIMITS

FCC §15.247 (b) (3)
 RSS-247 5.4 (d)

The maximum antenna gain is less than or equal to 6 dBi, therefore the limit is 30 dBm.

TEST PROCEDURE

The transmitter output is connected to a power meter.

The power output was measured on the EUT antenna port using SMA cable with 10dB attenuator connected to a power meter via wideband power sensor. Peak output power was read directly from power meter.

RESULTS

Tested By:	12485 GA, 27342 CH
Date:	2023-07-21

Application	Channel	Frequency (MHz)	Output Power Peak (dBm)		Total Peak power (dBm)	Limit (dBm)	Margin (dB)
			Ant1	Ant2	Ant1+ Ant2		
Original	Low	2402	17.77	17.07	20.44	30	-9.56
	Middle	2440	18.38	18.14	21.27	30	-8.73
	High	2475	17.71	17.27	20.51	30	-9.49
	High	2480	-1.60	1.50	3.23	30	-26.77
C2PC	Low	2402	21.25			30	-8.75
	Middle	2440	21.27			30	-8.73
	High	2475	20.86			30	-9.14
	High	2480	-1.19			30	-31.19

9.3. AVERAGE POWER

LIMITS

None; for reporting purposes only.

TEST PROCEDURE

The transmitter output is connected to a power meter.

The power output was measured on the EUT antenna port using SMA cable with 10dB attenuator connected to a power meter via wideband power sensor. Gated average output power was read directly from power meter.

RESULTS

Application	Channel	Frequency (MHz)	Output Power Avg (dBm)		Total avg power (dBm)
			Ant1	Ant2	Ant1+ Ant2
Original	Low	2402	17.66	16.88	20.30
	Middle	2440	18.29	18.03	21.17
	High	2475	17.54	17.13	20.35
	High	2480	-2.18	1.10	2.77
C2PC	Low	2402	21.15		
	Middle	2440	21.16		
	High	2475	20.78		
	High	2480	-1.87		

10. RADIATED TEST RESULTS

10.1. LIMITS AND PROCEDURE

LIMITS

FCC §15.205 and §15.209
RSS-GEN, Section 8.9 and 8.10.

Frequency Range (MHz)	Field Strength Limit (uV/m) at 3 m	Field Strength Limit (dBuV/m) at 3 m
0.009-0.490	2400/F(kHz) @ 300 m	-
0.490-1.705	24000/F(kHz) @ 30 m	-
1.705 - 30	30 @ 30m	-
30 - 88	100	40
88 - 216	150	43.5
216 - 960	200	46
Above 960	500	54

TEST PROCEDURE

The EUT is placed on a non-conducting table 80 cm above the ground plane for measurement below 1GHz; 1.5 m above the ground plane for measurement above 1GHz. The antenna to EUT distance is 3 meters. The EUT is configured in accordance with ANSI C63.10. The EUT is set to transmit in a continuous mode.

For measurements below 1 GHz the resolution bandwidth is set to 100 kHz for peak detection measurements or 120 kHz for quasi-peak detection measurements in the 30-1000MHz range, 9kHz for peak and/or quasi-peak detection measurements in the 0.15-30MHz range and 200Hz for peak and/or quasi-peak detection measurements in the 9 to 150kHz range. Peak detection is used unless otherwise noted as quasi-peak or average (9-90kHz and 110-490kHz).

For pre-scans above 1 GHz the resolution bandwidth is set to 1 MHz; the video bandwidth is set to 30 KHz for peak measurements.

For final measurements above 1 GHz the resolution bandwidth is set to 1 MHz; the video bandwidth is set to 3 MHz for peak measurements and as applicable for average measurements.

The spectrum from 1 GHz to 18 GHz is investigated with the transmitter set to the lowest, middle, and highest channels in each applicable band. Below 1GHz and above 18GHz emissions, the channel with the highest output power was tested.

The frequency range of interest is monitored at a fixed antenna height and EUT azimuth. The EUT is rotated through 360 degrees to maximize emissions received. The antenna is scanned from 1 to 4 meters above the ground plane to further maximize the emission. Measurements are made with the antenna polarized in both the vertical and the horizontal positions.

For below 30MHz testing, investigation was done on three antenna orientations (parallel, perpendicular, and ground-parallel), parallel and perpendicular are the worst orientations, therefore testing was performed on these two orientations only. Blue color trace on plots: Parallel orientation. Green color trace on plots: Perpendicular orientation.

Base on FCC 15.31 (f) (2): measurements may be performed at a distance closer than that specified in the regulations; however, an attempt should be made to avoid making measurements in the near field.

KDB 414788 Open Field Site(OFS) and Chamber Correlation Justification

OFS and chamber correlation testing had been performed and chamber measured test result is the worst case test result.

NOTE: The limits in FCC 47 CFR, Part 15, Subpart C, paragraph 15.209(a), are identical to those in RSS-Gen section 8.9, Table 6, since the measurements are performed in terms of magnetic field strength and converted to electric field strength levels (as reported in the table), using the free space impedance of 377 Ohms. For example the measurement at frequency X kHz resulted in a level of Y dBuV/m, which is equivalent to $Y - 51.5 = Z$ dBuA/m, which has the same margin, W dB, to the corresponding RSS-Gen Table 6 limit as it has to 15.209(a) limit.

10.2. TRANSMITTER ABOVE 1 GHz

BANDEDGE (LOW CHANNEL)

HORIZONTAL RESULT

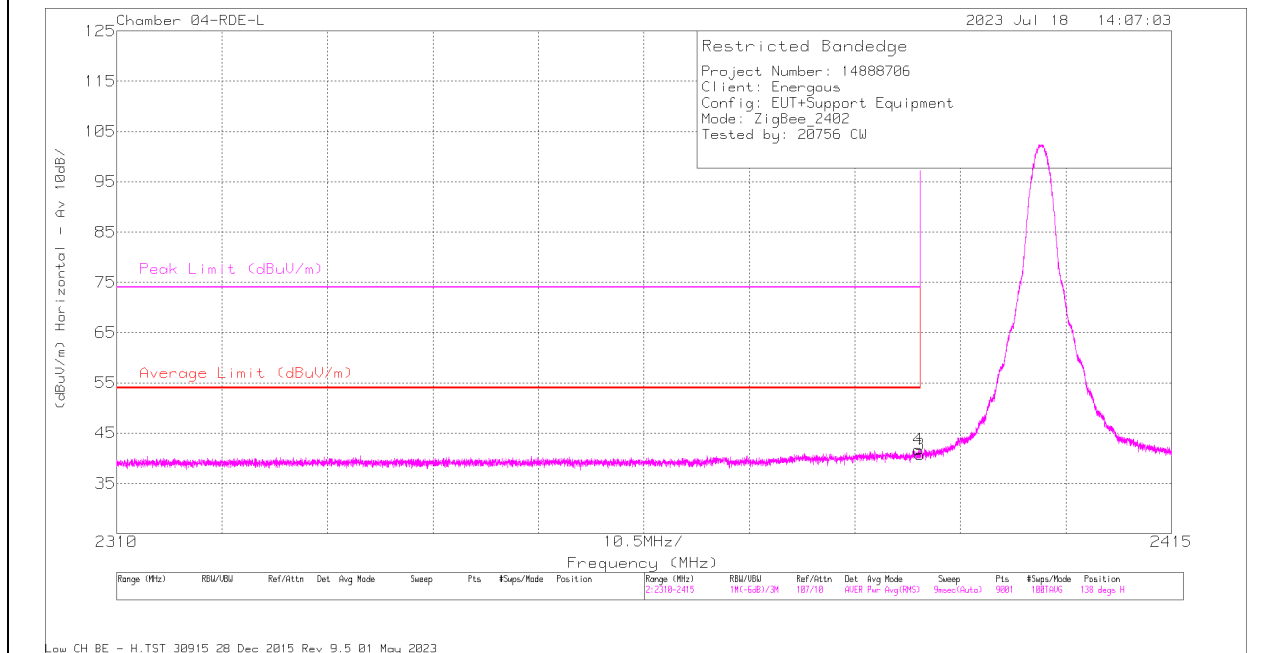
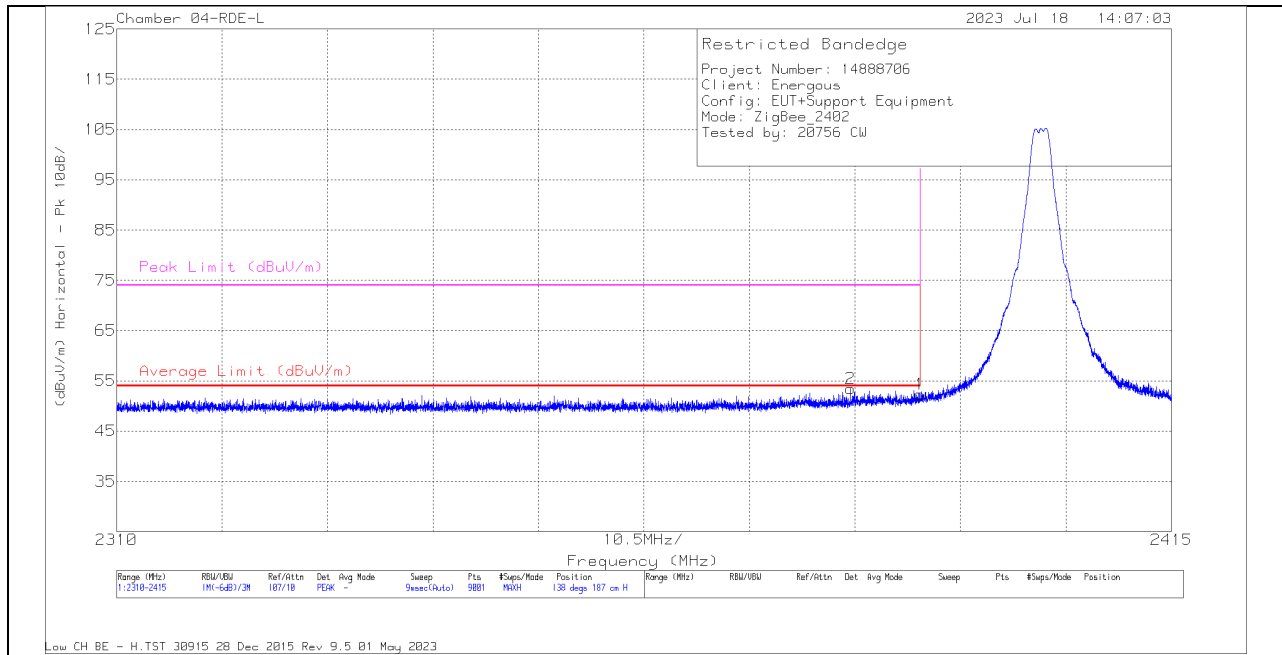

Trace Markers

Marker	Frequency (MHz)	Meter Reading (dBuV)	Det	206806 ACF (dB) 3mH	AMP/CBL	Corrected Reading (dBuV/m)	Average Limit (dBuV/m)	Margin (dB)	Peak Limit (dBuV/m)	PK Margin (dB)	Azimuth (Degs)	Height (cm)	Polarity
1	* 2390	39.15	Pk	32	-18.8	52.35	-	-	74	-21.65	138	187	H
2	* 2383.07	40.28	Pk	32	-18.8	53.48	-	-	74	-20.52	138	187	H
3	* 2390	27.55	RMS	32	-18.8	40.75	54	-13.25	-	-	138	187	H
4	* 2389.814	28.58	RMS	32	-18.8	41.78	54	-12.22	-	-	138	187	H

* - indicates frequency in CFR47 Pt 15 / IC RSS-Restricted Band
 Pk - Peak detector
 RMS - RMS detection

VERTICAL RESULT

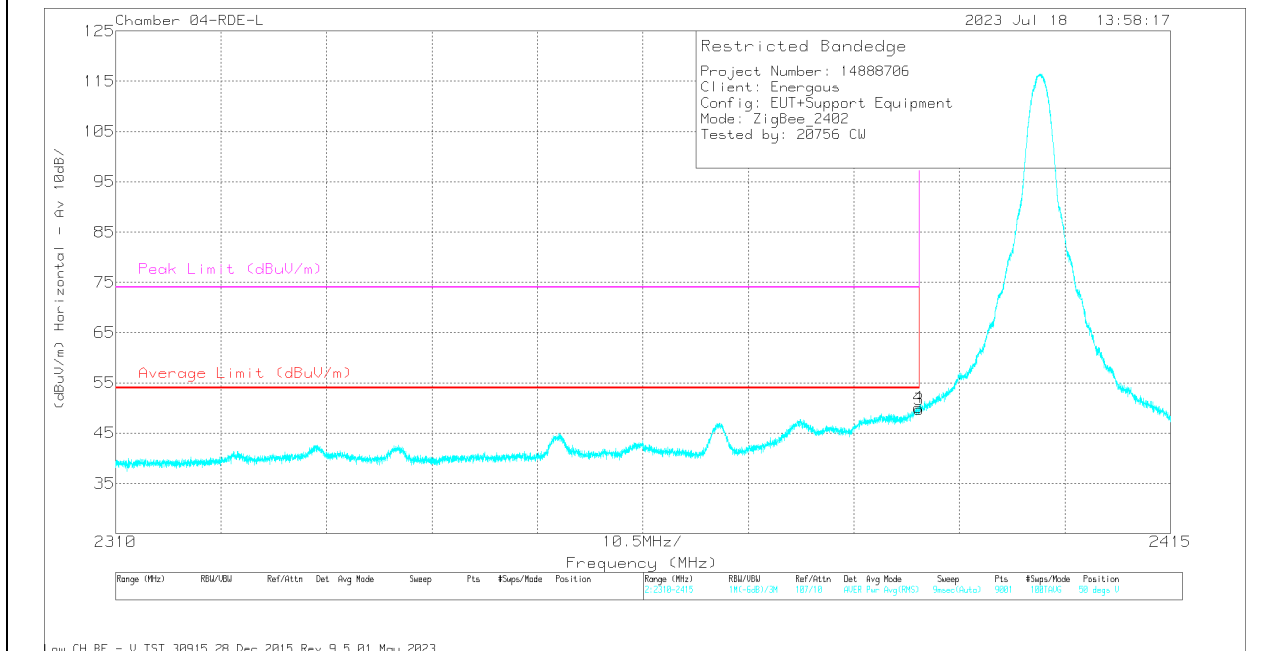
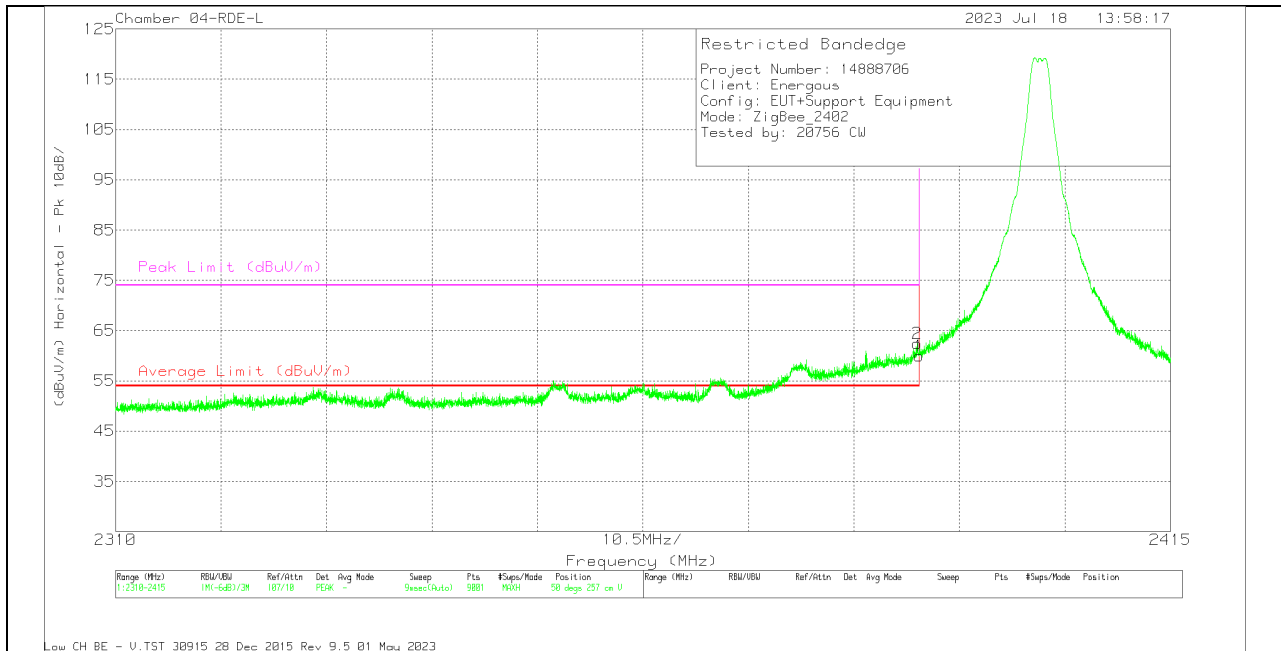

Trace Markers

Marker	Frequency (MHz)	Meter Reading (dBuV)	Det	206806 ACF (dB) 3mH	AMP/CBL	Corrected Reading (dBuV/m)	Average Limit (dBuV/m)	Margin (dB)	Peak Limit (dBuV/m)	PK Margin (dB)	Azimuth (Degs)	Height (cm)	Polarity
1	* 2390	46.79	Pk	32	-18.8	59.99	-	-	74	-14.01	50	257	V
2	* 2389.791	49.26	Pk	32	-18.8	62.46	-	-	74	-11.54	50	257	V
3	* 2390	36.51	RMS	32	-18.8	49.71	54	-4.29	-	-	50	257	V
4	* 2389.896	36.92	RMS	32	-18.8	50.12	54	-3.88	-	-	50	257	V

* - indicates frequency in CFR47 Pt 15 / IC RSS-Restricted Band
 Pk - Peak detector
 RMS - RMS detection

BANDEDGE (2475 MHz)

HORIZONTAL RESULT

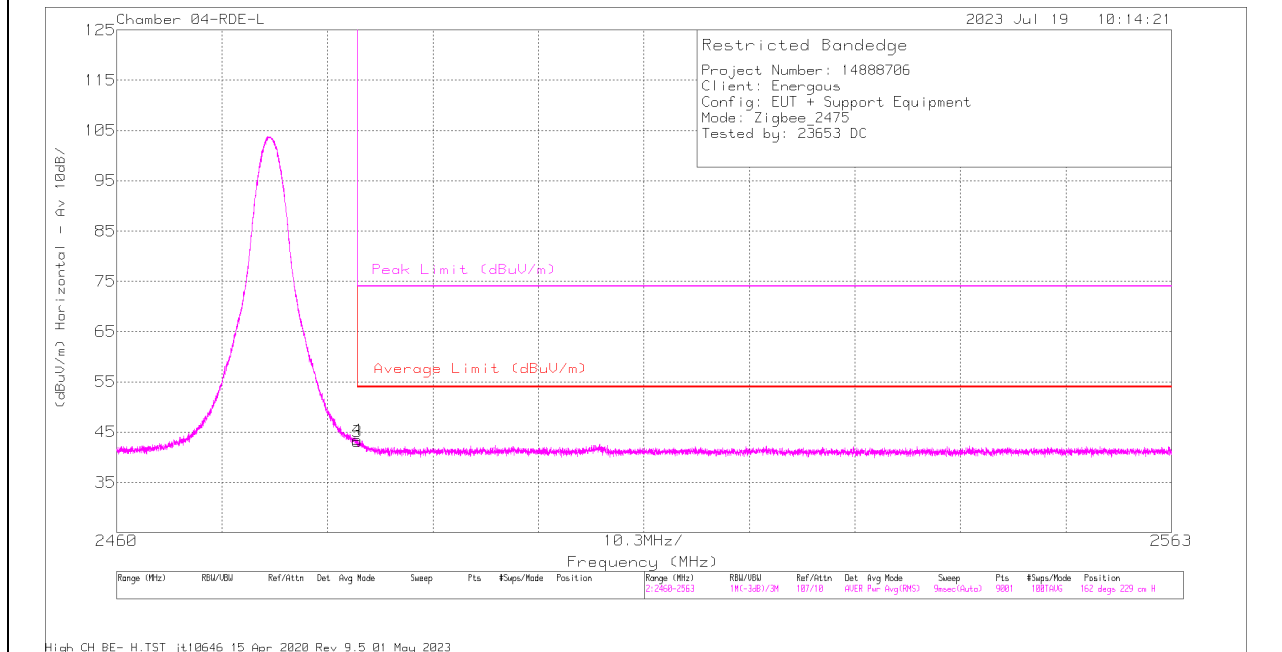
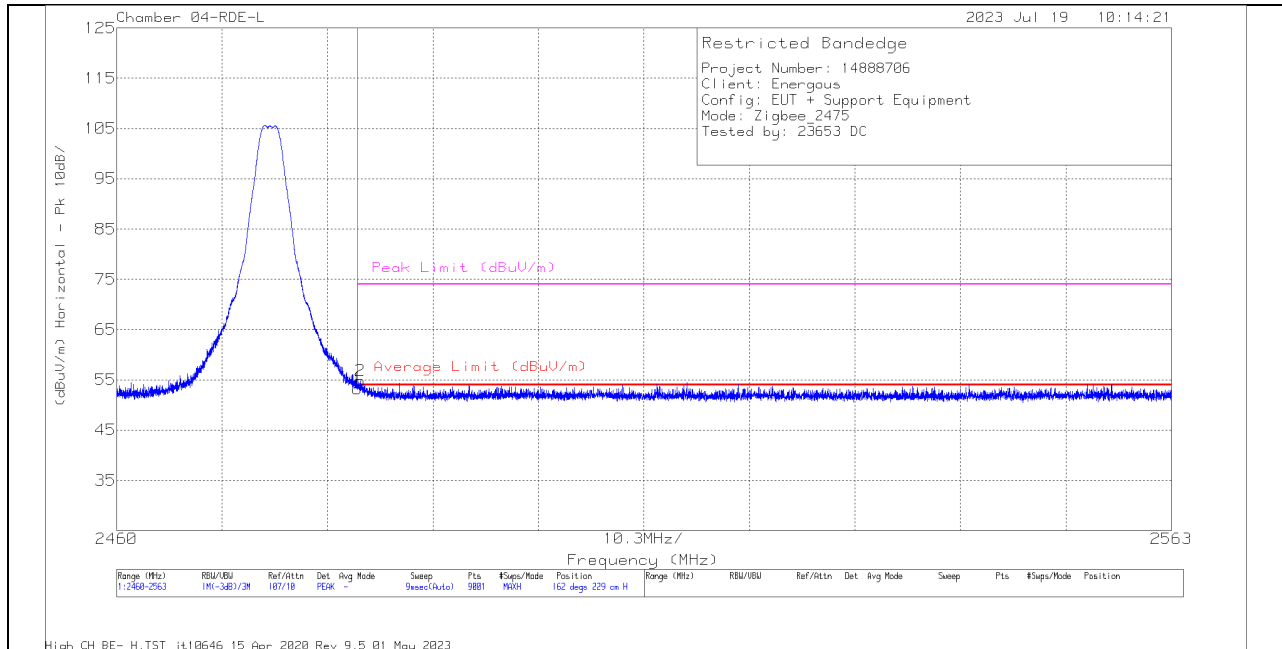

Trace Markers

Marker	Frequency (MHz)	Meter Reading (dBuV)	Det	206806 ACF (dB) 3mH	AMP/CBL	Corrected Reading (dBuV/m)	Average Limit (dBuV/m)	Margin (dB)	Peak Limit (dBuV/m)	PK Margin (dB)	Azimuth (Degs)	Height (cm)	Polarity
1	* 2483.5	39.81	Pk	32	-18.6	53.21	-	-	74	-20.79	162	229	H
2	* 2483.838	41.32	Pk	32	-18.5	54.82	-	-	74	-19.18	162	229	H
3	* 2483.5	29.73	RMS	32	-18.6	43.13	54	-10.87	-	-	162	229	H
4	* 2483.506	29.93	RMS	32	-18.5	43.43	54	-10.57	-	-	162	229	H

* - indicates frequency in CFR47 Pt 15 / IC RSS-Restricted Band
 Pk - Peak detector
 RMS - RMS detection

VERTICAL RESULT

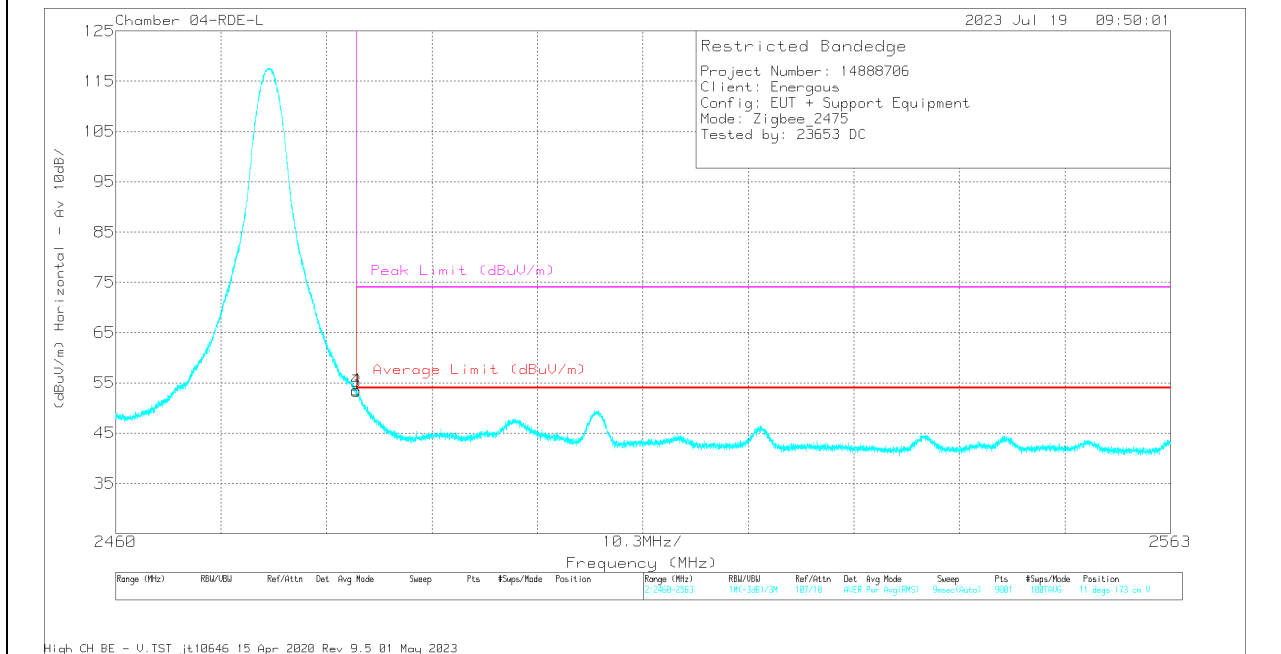
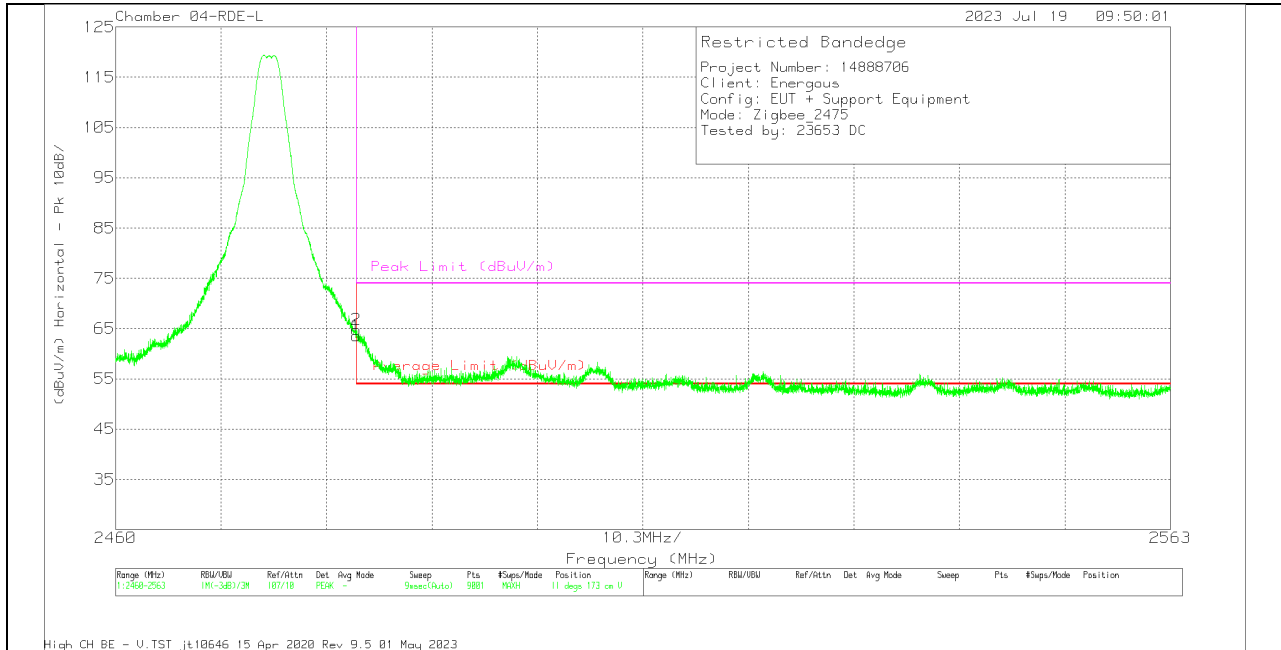

Trace Markers

Marker	Frequency (MHz)	Meter Reading (dBuV)	Det	206806 ACF (dB) 3mH	AMP/CBL	Corrected Reading (dBuV/m)	Average Limit (dBuV/m)	Margin (dB)	Peak Limit (dBuV/m)	PK Margin (dB)	Azimuth (Degs)	Height (cm)	Polarity
1	* 2483.5	50.21	Pk	32	-18.6	63.61	-	-	74	-10.39	11	173	V
2	* 2483.529	51.32	Pk	32	-18.5	64.82	-	-	74	-9.18	11	173	V
3	* 2483.5	39.89	RMS	32	-18.6	53.29	54	-71	-	-	11	173	V
4	* 2483.506	40.08	RMS	32	-18.5	53.58	54	-42	-	-	11	173	V

* - indicates frequency in CFR47 Pt 15 / IC RSS-Restricted Band
 Pk - Peak detector
 RMS - RMS detection

BANEDGE (HIGH CHANNEL)

HORIZONTAL RESULT

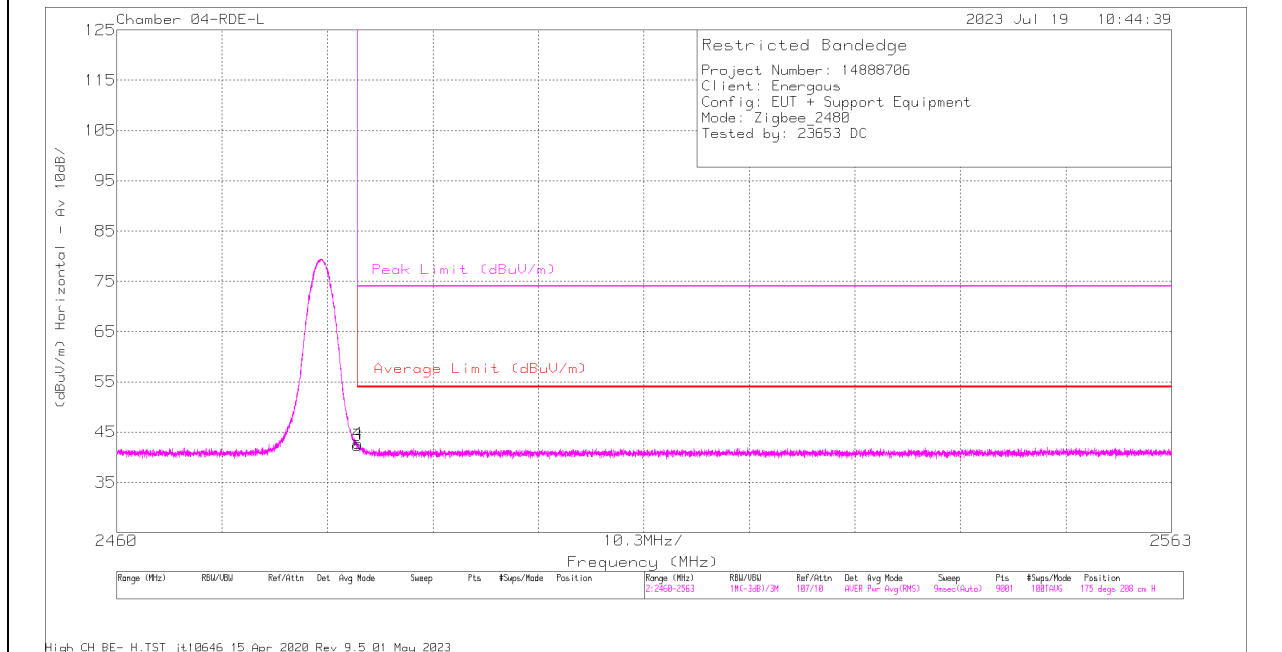
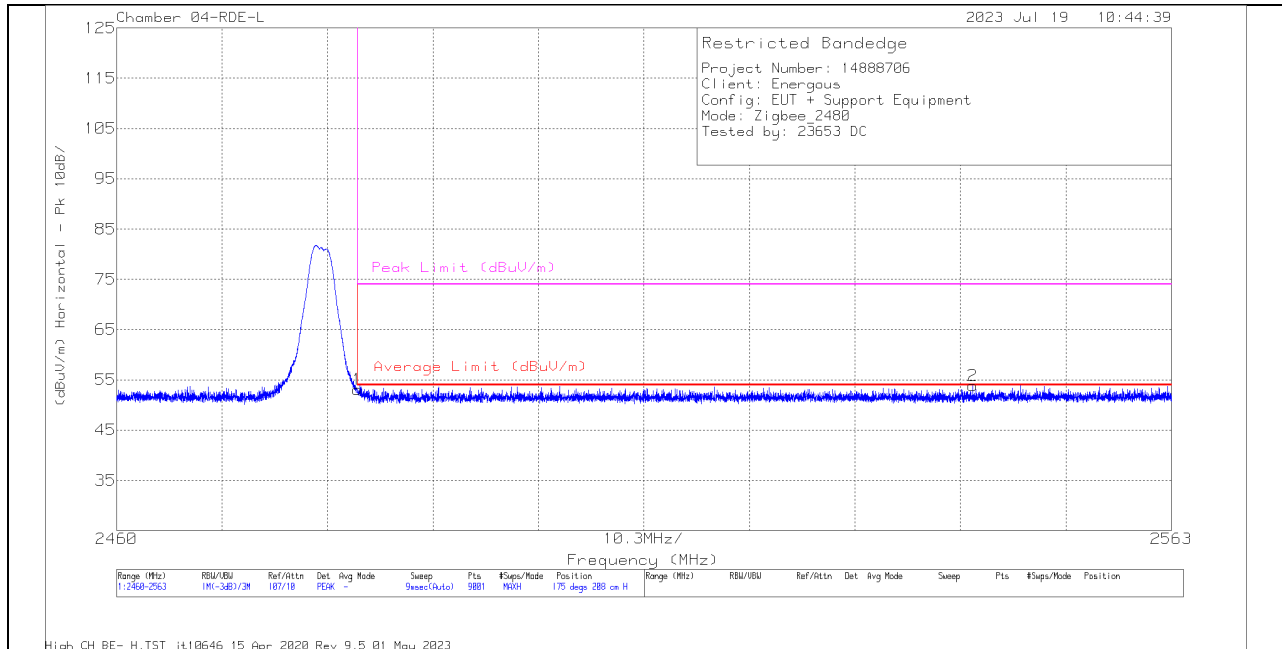

Trace Markers

Marker	Frequency (MHz)	Meter Reading (dBuV)	Det	206806 ACF (dB) 3mH	AMP/CBL	Corrected Reading (dBuV/m)	Average Limit (dBuV/m)	Margin (dB)	Peak Limit (dBuV/m)	PK Margin (dB)	Azimuth (Degs)	Height (cm)	Polarity
1	* 2483.5	39.65	Pk	32	-18.6	53.05	-	-	74	-20.95	175	208	H
2	2543.587	40.28	Pk	32	-18.4	53.88	-	-	74	-20.12	175	208	H
3	* 2483.5	28.99	RMS	32	-18.6	42.39	54	-11.61	-	-	175	208	H
4	* 2483.575	29.25	RMS	32	-18.5	42.75	54	-11.25	-	-	175	208	H

* - indicates frequency in CFR47 Pt 15 / IC RSS-Restricted Band
 Pk - Peak detector
 RMS - RMS detection

VERTICAL RESULT

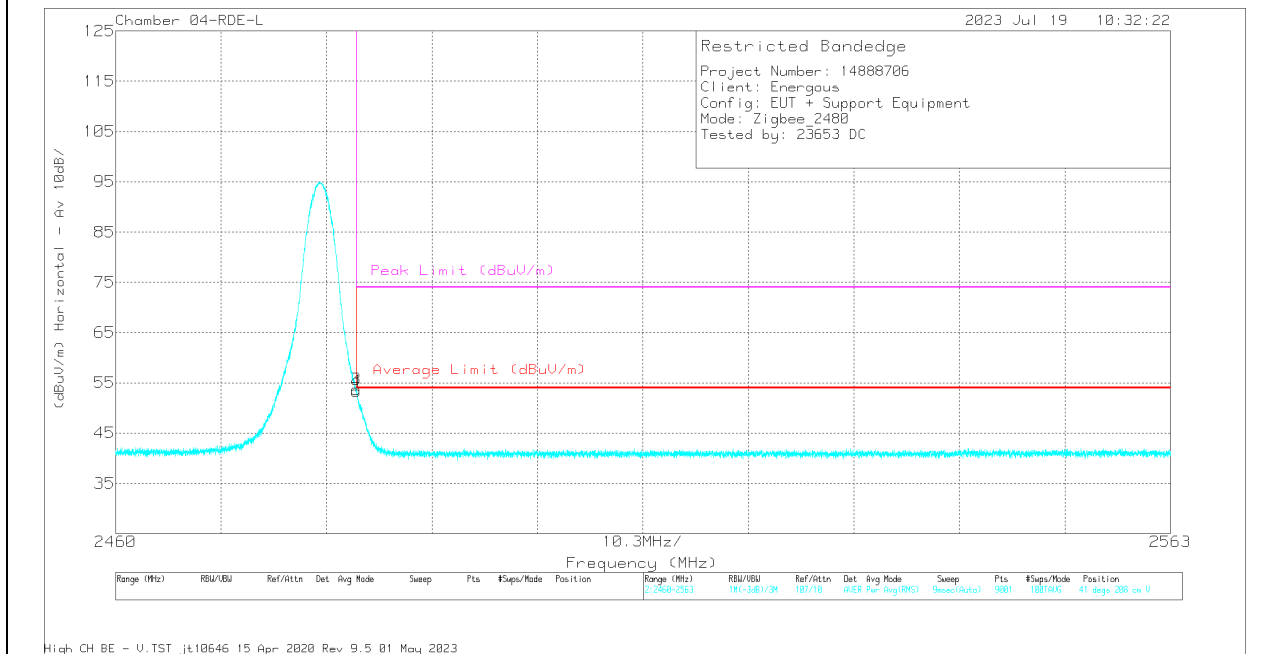
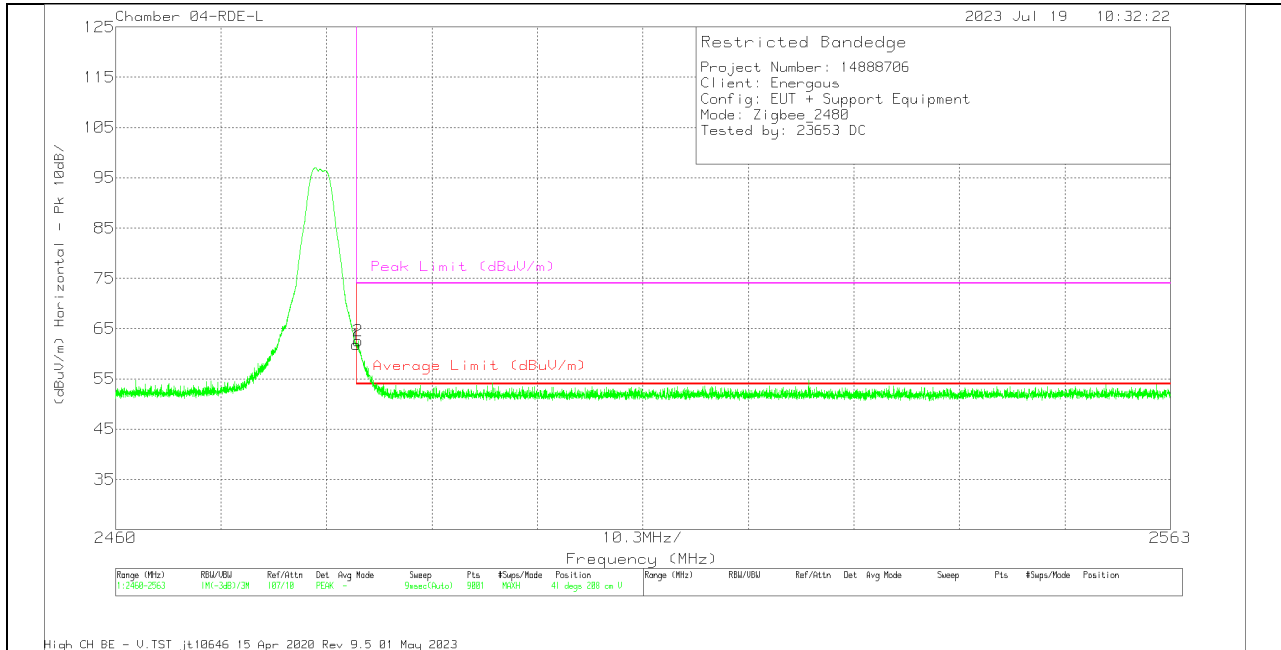

Trace Markers

Marker	Frequency (MHz)	Meter Reading (dBuV)	Det	206806 ACF (dB) 3mH	AMP/CBL	Corrected Reading (dBuV/m)	Average Limit (dBuV/m)	Margin (dB)	Peak Limit (dBuV/m)	PK Margin (dB)	Azimuth (Degs)	Height (cm)	Polarity
1	* 2483.5	48.4	Pk	32	-18.6	61.8	-	-	74	-12.2	41	208	V
2	* 2483.689	49.1	Pk	32	-18.5	62.6	-	-	74	-11.4	41	208	V
3	* 2483.5	40.32	RMS	32	-18.6	53.72	54	-28	-	-	41	208	V
4	* 2483.506	39.88	RMS	32	-18.5	53.38	54	-62	-	-	41	208	V

* - indicates frequency in CFR47 Pt 15 / IC RSS-Restricted Band
 Pk - Peak detector
 RMS - RMS detection

HARMONICS AND SPURIOUS EMISSIONS

LOW CHANNEL RESULTS

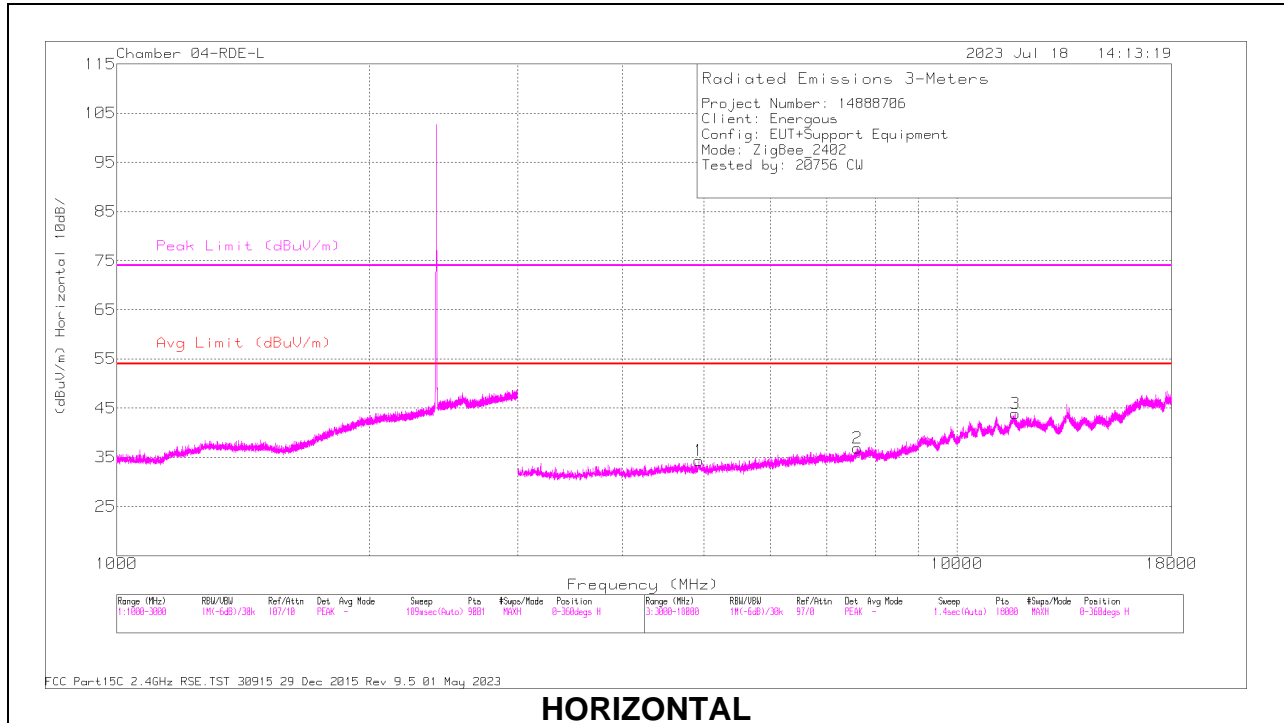

HORIZONTAL

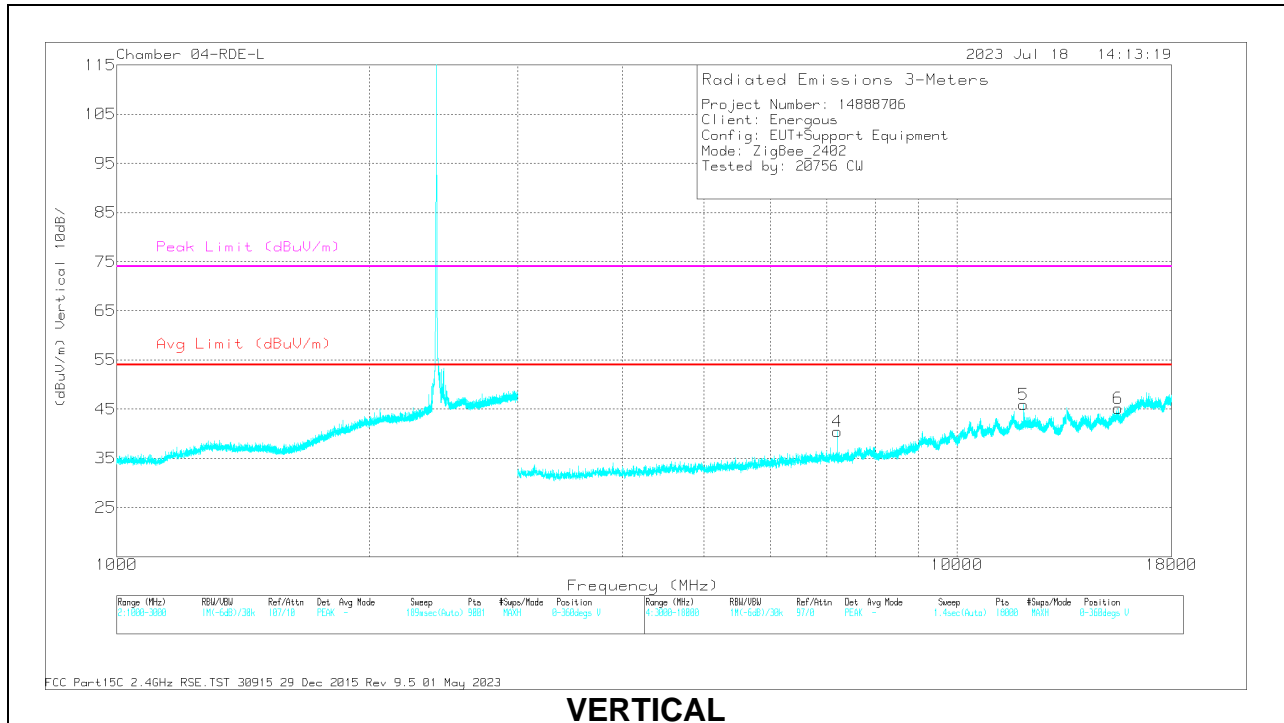

VERTICAL

Radiated Emissions

Marker	Frequency (MHz)	Meter Reading (dBuV)	Det	206806 ACF (dB) 3mH	AMPCBL	Corrected Reading (dBuV/m)	Avg Limit (dBuV/m)	Margin (dB)	Peak Limit (dBuV/m)	PK Margin (dB)	Azimuth (Degs)	Height (cm)	Polarity
1	* 4933.363	31.92	PK2	33.9	-23.9	41.92	-	-	74	-32.08	273	207	H
	* 4933.79	20.68	MAv1	33.9	-23.9	30.68	54	-23.32	-	-	273	207	H
2	* 7617.204	29.88	PK2	35.7	-20	45.58	-	-	74	-28.42	97	306	H
	* 7617.151	18.24	MAv1	35.7	-20	33.94	54	-20.06	-	-	97	306	H
3	* 11737.685	30.17	PK2	38.4	-16.6	51.97	-	-	74	-22.03	304	133	H
	* 11740.841	18.81	MAv1	38.4	-16.5	40.71	54	-13.29	-	-	304	133	H
4	7207.258	33.21	PK2	35.6	-21.6	47.21	-	-	-	-	272	230	V
	7207.233	24.14	MAv1	35.6	-21.6	38.14	-	-	-	-	272	230	V
5	* 12010.045	30.67	PK2	38.6	-16.5	52.77	-	-	74	-21.23	109	320	V
	* 12007.893	20.38	MAv1	38.6	-16.5	42.48	54	-11.52	-	-	109	320	V
6	* 15536.888	28.98	PK2	39.7	-15.2	53.48	-	-	74	-20.52	258	240	V
	* 15537.255	17.37	MAv1	39.7	-15.2	41.87	54	-12.13	-	-	258	240	V

* - indicates frequency in CFR47 Pt 15 / IC RSS-Restricted Band
 PK2 - KDB558074 Method: Maximum Peak
 MAv1 - KDB558074 Option 1 Maximum RMS Average

MID CHANNEL RESULTS

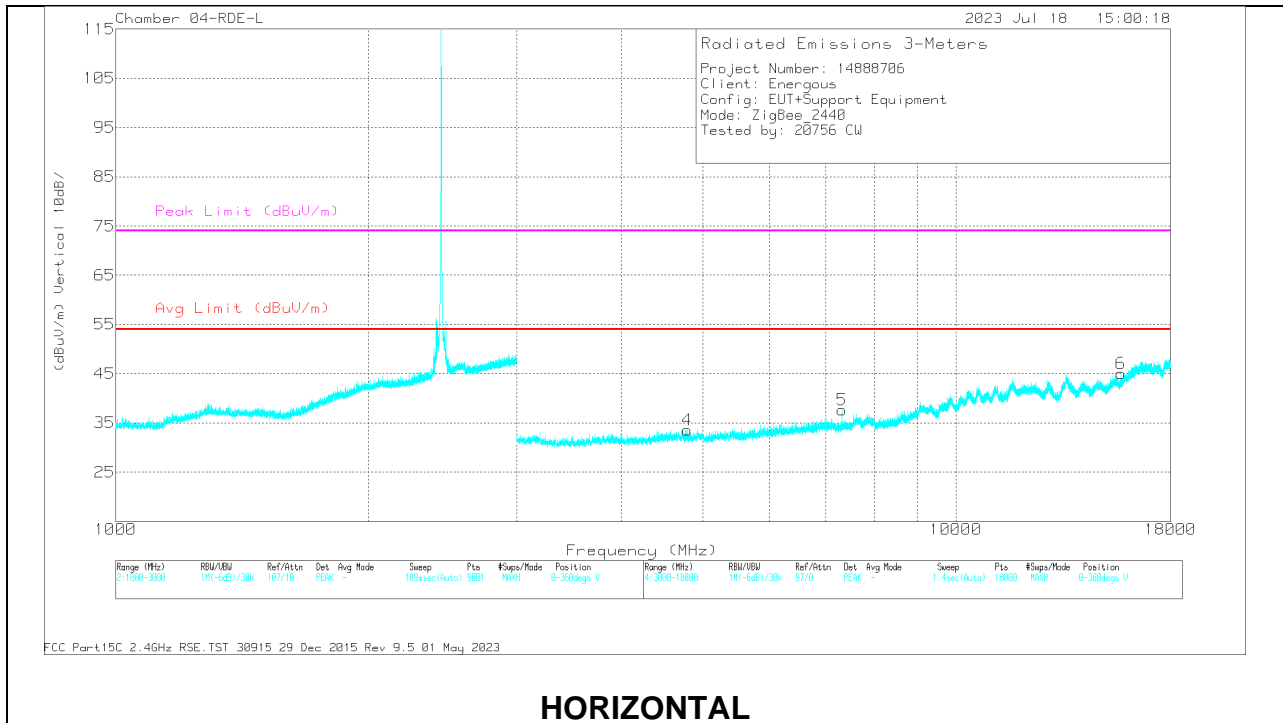

HORIZONTAL

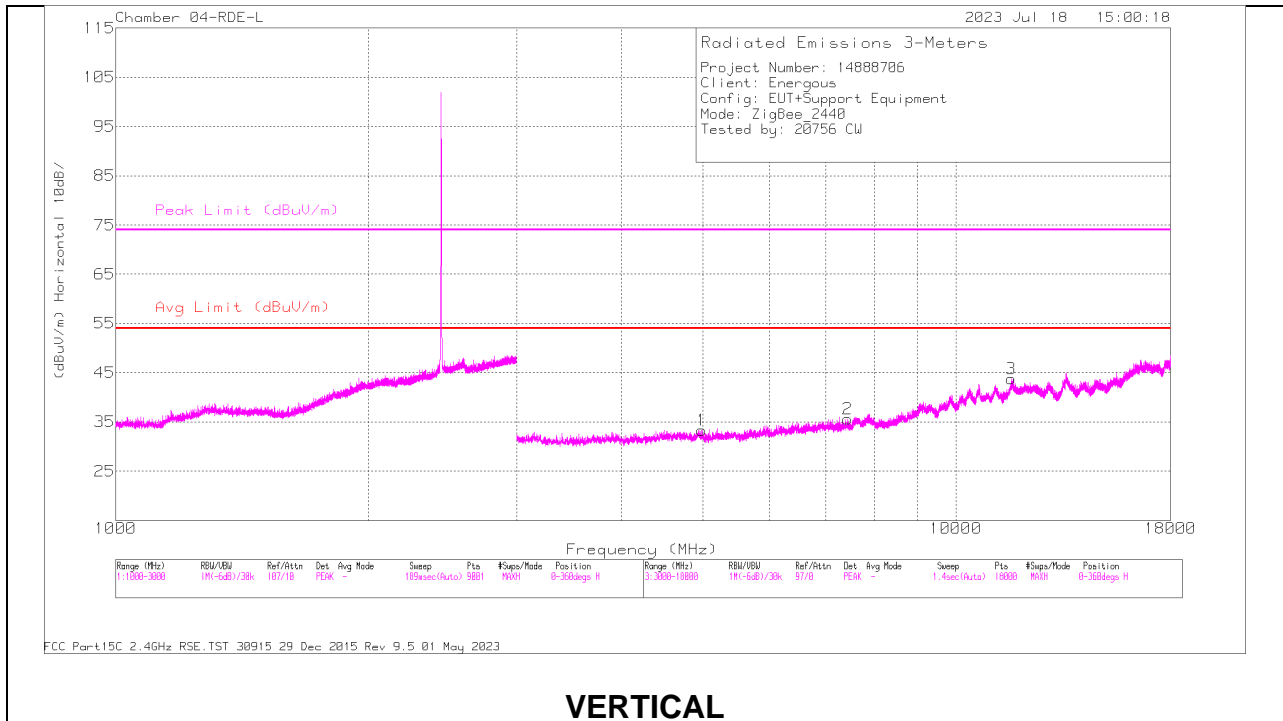

VERTICAL

Radiated Emissions

Marker	Frequency (MHz)	Meter Reading (dBuV)	Det	206806 ACF (dB) 3mH	AMP/CBL	Corrected Reading (dBuV/m)	Avg Limit (dBuV/m)	Margin (dB)	Peak Limit (dBuV/m)	PK Margin (dB)	Azimuth (Degs)	Height (cm)	Polarity
1	* 4986.248	34.1	PK2	33.9	-24.5	43.5	-	-	74	-30.5	216	312	H
	* 4989.215	22.41	MAv1	33.9	-24.6	31.71	54	-22.29	-	-	216	312	H
2	* 7434.64	30.03	PK2	35.6	-21.1	44.53	-	-	74	-29.47	262	307	H
	* 7433.843	18.83	MAv1	35.6	-21.1	33.33	54	-20.67	-	-	262	307	H
3	* 11625.808	29.89	PK2	38.3	-15.6	52.59	-	-	74	-21.41	262	258	H
	* 11628.965	18.54	MAv1	38.3	-15.6	41.24	54	-12.76	-	-	262	258	H
4	* 4782.514	34.37	PK2	33.9	-25	43.27	-	-	74	-30.73	266	277	V
	* 4784.111	22.37	MAv1	33.9	-25	31.27	54	-22.73	-	-	266	277	V
5	* 7321.386	34.05	PK2	35.6	-21.3	48.35	-	-	74	-25.65	255	228	V
	* 7321.286	25.97	MAv1	35.6	-21.3	40.27	54	-13.73	-	-	255	228	V
6	* 15705.433	29.56	PK2	39.9	-16.3	53.16	-	-	74	-20.84	156	128	V
	* 15707.345	17.99	MAv1	39.9	-16.3	41.59	54	-12.41	-	-	156	128	V

* - indicates frequency in CFR47 Pt 15 / IC RSS-Restricted Band

PK2 - KDB558074 Method: Maximum Peak

MAv1 - KDB558074 Option 1 Maximum RMS Average

HIGH CHANNEL RESULTS

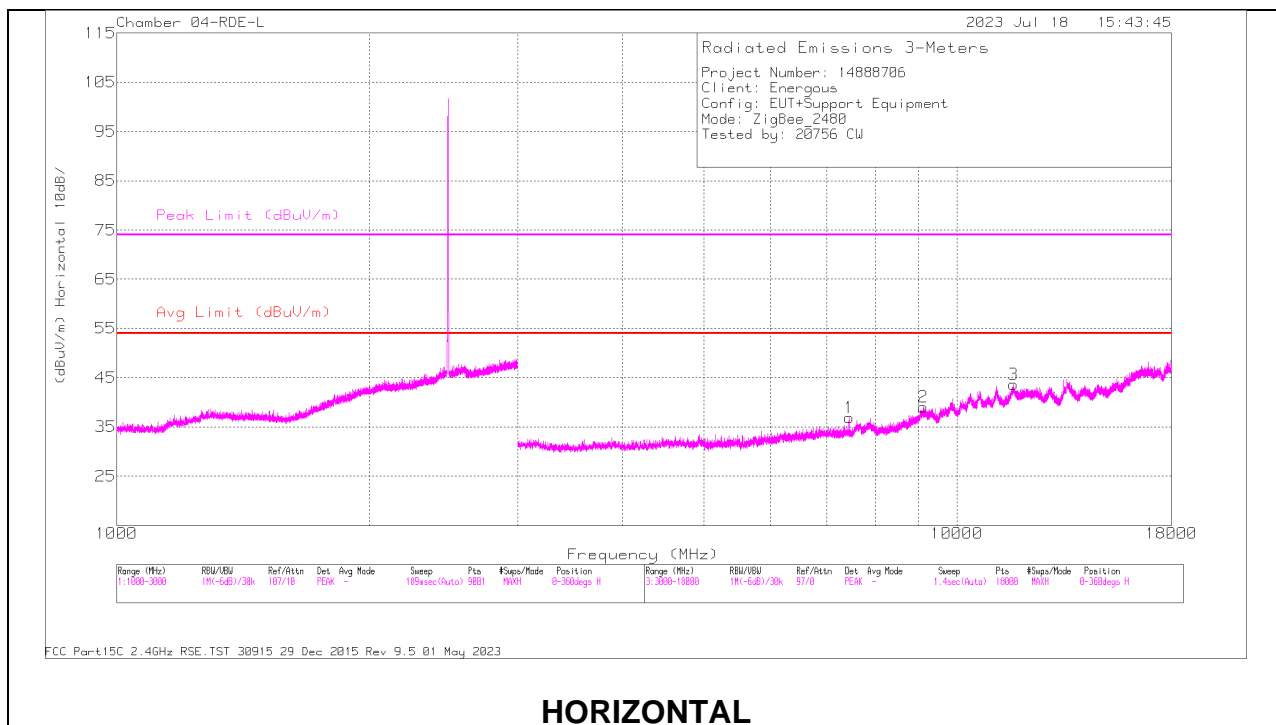

HORIZONTAL

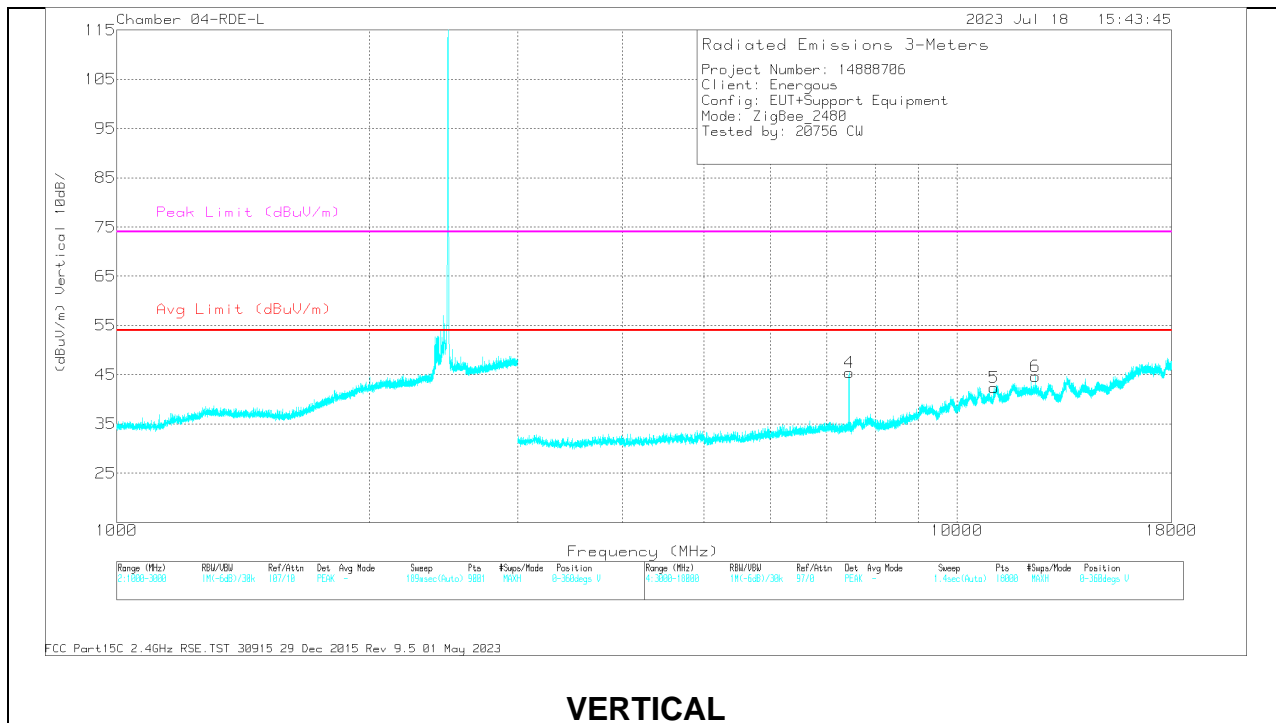

VERTICAL

RADIATED EMISSIONS

Frequency (MHz)	Meter Reading (dBuV)	Det	206806 ACF (dB) 3mH	AMP/CBL	Corrected Reading (dBuV/m)	Avg Limit (dBuV/m)	Margin (dB)	Peak Limit (dBuV/m)	PK Margin (dB)	Azimuth (Degs)	Height (cm)	Polarity
* 7441.402	30.55	PK2	35.6	-21	45.15	-	-	74	-28.85	164	283	H
* 7441.59	19.14	MAv1	35.6	-21	33.74	54	-20.26	-	-	164	283	H
* 9120.871	30.06	PK2	36.1	-18.1	48.06	-	-	74	-25.94	315	283	H
* 9119.958	18.64	MAv1	36.1	-18.1	36.64	54	-17.36	-	-	315	283	H
* 11672.18	30.22	PK2	38.3	-15.6	52.92	-	-	74	-21.08	136	112	H
* 11673.628	18.68	MAv1	38.3	-15.6	41.38	54	-12.62	-	-	136	112	H
* 7438.36	31.73	PK2	35.6	-21.1	46.23	-	-	74	-27.77	174	101	V
* 7438.708	21.01	MAv1	35.6	-21	35.61	54	-18.39	-	-	174	101	V
* 11066.634	28.82	PK2	37.8	-16.4	50.22	-	-	74	-23.78	356	174	V
* 11065.839	18.01	MAv1	37.8	-16.4	39.41	54	-14.59	-	-	356	174	V
* 12397.085	31.19	PK2	38.8	-16	53.99	-	-	74	-20.01	109	110	V
* 12397.565	21.21	MAv1	38.8	-16	44.01	54	-9.99	-	-	109	110	V

* - indicates frequency in CFR47 Pt 15 / IC RSS-Restricted Band
 PK2 - KDB558074 Method: Maximum Peak
 MAv1 - KDB558074 Option 1 Maximum RMS Average

10.3. WORST CASE BELOW 30MHZ

SPURIOUS EMISSIONS BELOW 30 MHz (WORST-CASE CONFIGURATION)

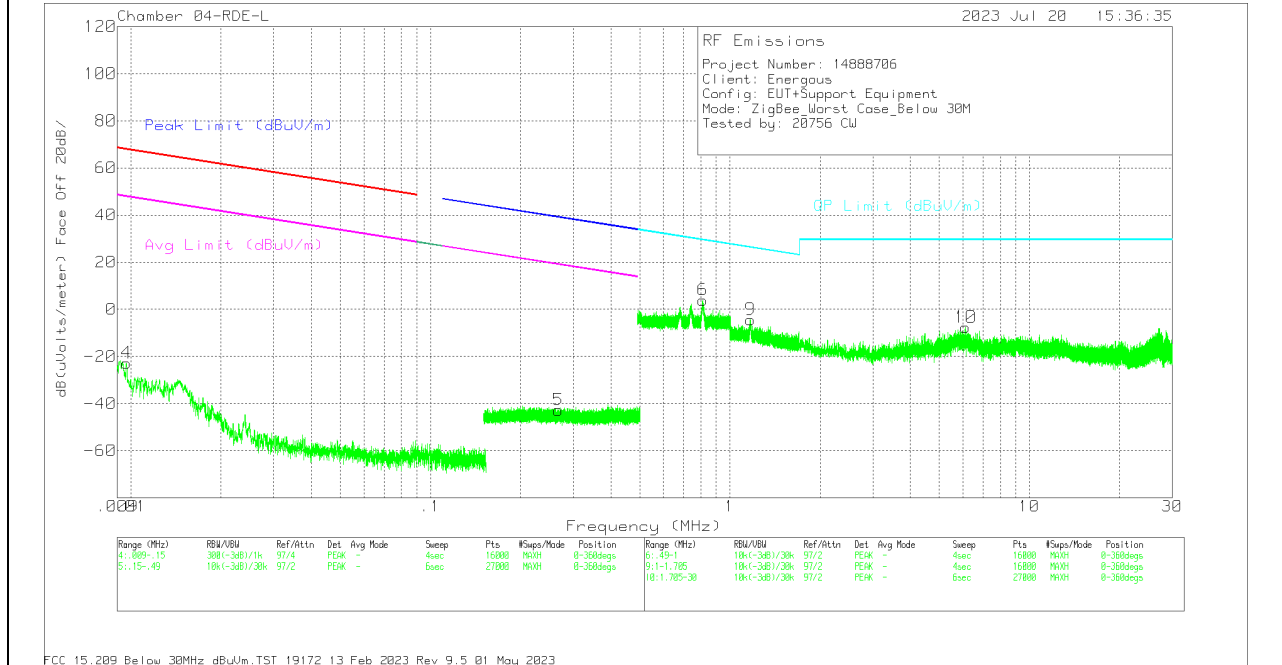
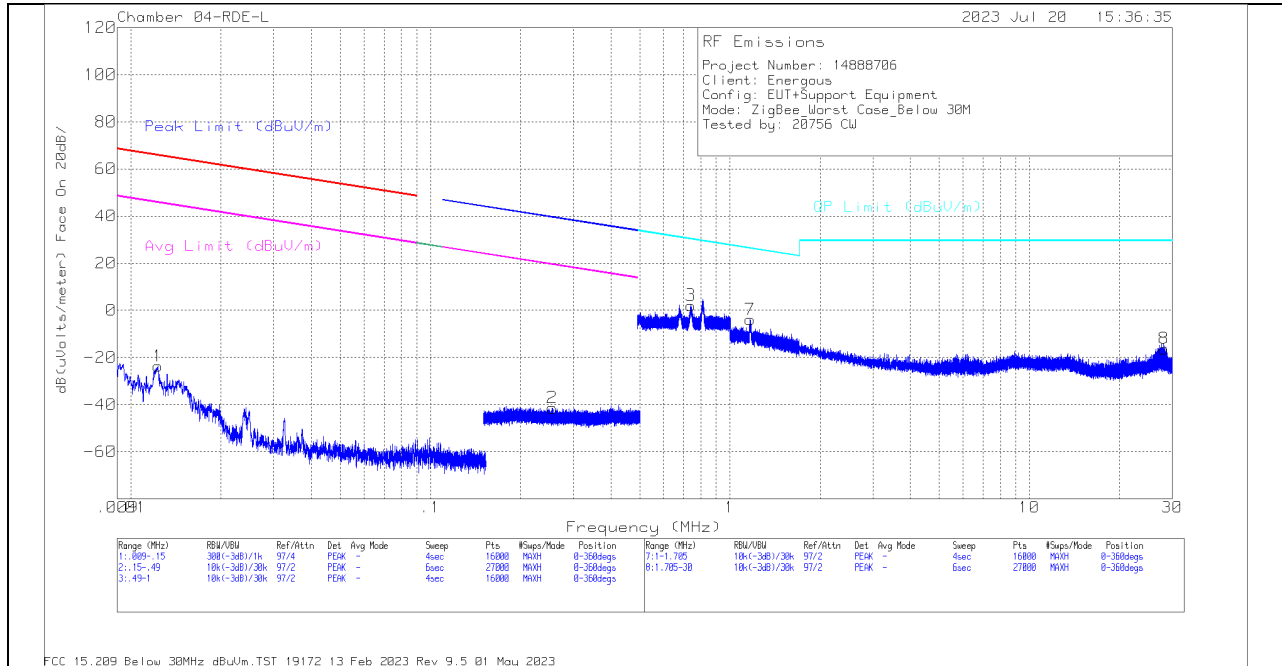

ANTENNA- TWO ORIENTATIONS FACE ON/FACE OFF

Below 30MHz Data

Marker	Frequency (MHz)	Meter Reading (dBuV)	Det	Loop Antenna E(ACF)	CBL/AMP	Dist Corr 300m	Corrected Reading dB(uVolts/meter)	Peak Limit (dBuV/m)	Margin (dB)	Avg Limit (dBuV/m)	Margin (dB)	Azimuth (Degs)
1	.0123	25.75	Pk	60.1	-29.5	-80	-23.65	65.78	-89.43	45.78	-69.43	0-360
Marker	Frequency (MHz)	Meter Reading (dBuV)	Det	Loop Antenna E(ACF)	CBL/AMP	Dist Corr 300m	Corrected Reading dB(uVolts/meter)	Peak Limit (dBuV/m)	Margin (dB)	Avg Limit (dBuV/m)	Margin (dB)	Azimuth (Degs)
2	2553	14.4	Pk	56.2	-32	-80	-41.4	39.47	-80.87	19.47	-60.87	0-360
Marker	Frequency (MHz)	Meter Reading (dBuV)	Det	Loop Antenna E(ACF)	CBL/AMP	Dist Corr 300m	Corrected Reading dB(uVolts/meter)	Peak Limit (dBuV/m)	Margin (dB)	Avg Limit (dBuV/m)	Margin (dB)	Azimuth (Degs)
4	.0097	25.33	Pk	60.7	-28.8	-80	-22.77	67.89	-90.66	47.89	-70.66	0-360
Marker	Frequency (MHz)	Meter Reading (dBuV)	Det	Loop Antenna E(ACF)	CBL/AMP	Dist Corr 300m	Corrected Reading dB(uVolts/meter)	Peak Limit (dBuV/m)	Margin (dB)	Avg Limit (dBuV/m)	Margin (dB)	Azimuth (Degs)
5	.2668	13.07	Pk	56.2	-32	-80	-42.73	39.09	-81.82	19.09	-61.82	0-360
Marker	Frequency (MHz)	Meter Reading (dBuV)	Det	Loop Antenna E(ACF)	CBL/AMP	Dist Corr 30m (dB) 40Log	Corrected Reading dB(uVolts/meter)	QP Limit (dBuV/m)	Margin (dB)		Azimuth (Degs)	
3	.7415	17.56	Pk	56.4	-31.9	-40	2.06	30.21	-28.15		0-360	
Marker	Frequency (MHz)	Meter Reading (dBuV)	Det	Loop Antenna E(ACF)	CBL/AMP	Dist Corr 30m (dB) 40Log	Corrected Reading dB(uVolts/meter)	QP Limit (dBuV/m)	Margin (dB)		Azimuth (Degs)	
6	.8111	19.45	Pk	56.4	-31.9	-40	3.95	29.43	-25.48		0-360	
Marker	Frequency (MHz)	Meter Reading (dBuV)	Det	Passive Loop Antenna E(ACF)	CBL/AMP	Dist Corr 30m (dB) 40Log	Corrected Reading dB(uVolts/meter)	QP Limit (dBuV/m)	Margin (dB)		Azimuth (Degs)	
7	1.169	21.98	Pk	45.9	-31.8	-40	-3.92	26.27	-30.19		0-360	
Marker	Frequency (MHz)	Meter Reading (dBuV)	Det	Passive Loop Antenna E(ACF)	CBL/AMP	Dist Corr 30m (dB) 40Log	Corrected Reading dB(uVolts/meter)	QP Limit (dBuV/m)	Margin (dB)		Azimuth (Degs)	
8	28.1125	21.29	Pk	33.6	-31.2	-40	-16.31	29.5	-45.81		0-360	
Marker	Frequency (MHz)	Meter Reading (dBuV)	Det	Passive Loop Antenna E(ACF)	CBL/AMP	Dist Corr 30m (dB) 40Log	Corrected Reading dB(uVolts/meter)	QP Limit (dBuV/m)	Margin (dB)		Azimuth (Degs)	
9	1.172	21.54	Pk	45.9	-31.8	-40	-4.36	26.25	-30.61		0-360	
Marker	Frequency (MHz)	Meter Reading (dBuV)	Det	Passive Loop Antenna E(ACF)	CBL/AMP	Dist Corr 30m (dB) 40Log	Corrected Reading dB(uVolts/meter)	QP Limit (dBuV/m)	Margin (dB)		Azimuth (Degs)	
10	6.1255	28.77	Pk	35.2	-31.6	-40	-7.63	29.5	-37.13		0-360	

Pk - Peak detector

10.4. WORST CASE BELOW 1 GHZ

SPURIOUS EMISSIONS 30 TO 1000 MHz (WORST-CASE CONFIGURATION)

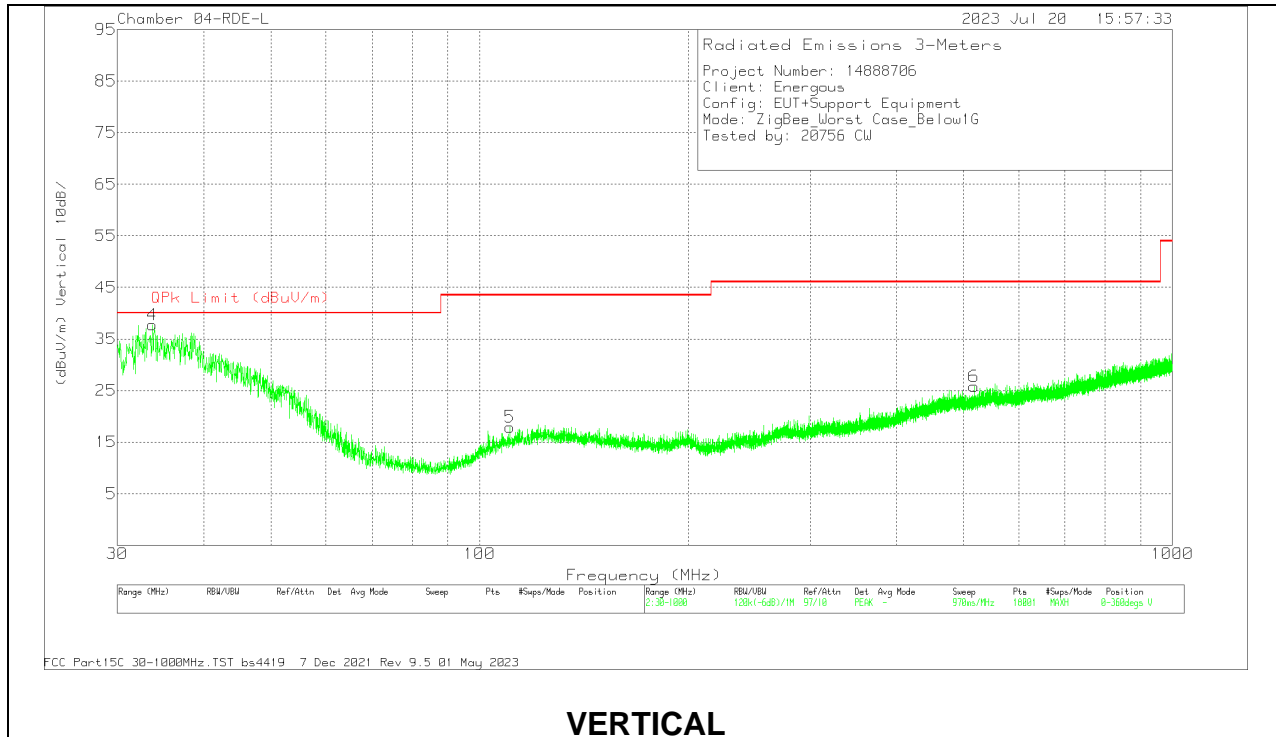
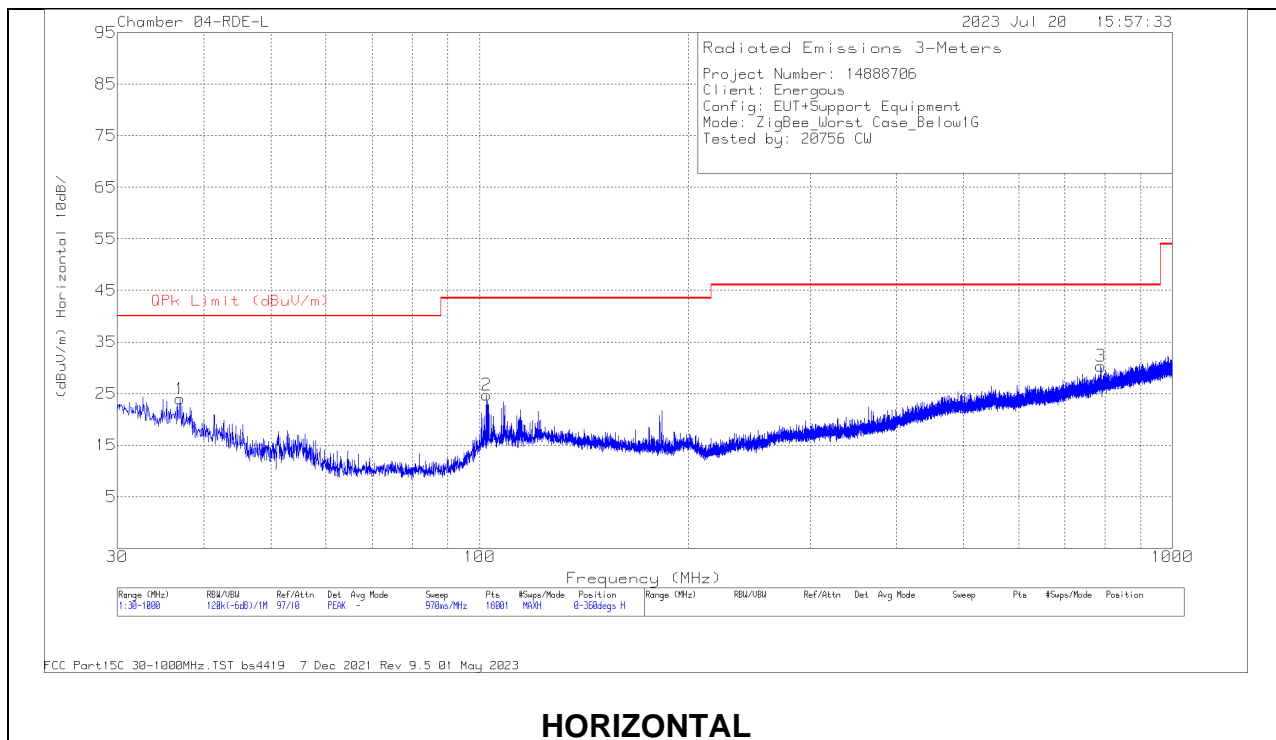

Below 1GHz Data

Marker	Frequency (MHz)	Meter Reading (dBuV)	Det	174374 ANSI ACF 10 m H UL_	Amp/Cbl (dB)	Corrected Reading (dBuV/m)	QPk Limit (dBuV/m)	Margin (dB)	Azimuth (Degs)	Height (cm)	Polarity
1	36.9517	33.27	Pk	21.8	-31.1	23.97	40	-16.03	0-360	299	H
2	102.373	38.42	Pk	16.7	-30.4	24.72	43.52	-18.8	0-360	399	H
3	788.703	30.83	Pk	27	-27.5	30.33	46.02	-15.69	0-360	199	H
4	33.7183	44.81	Pk	24	-31.1	37.71	40	-2.29	0-360	100	V
	32.9663	37.04	Qp	24.7	-31.1	30.64	40	-9.36	2	108	V
5	110.672	29.7	Pk	18.5	-30.3	17.9	43.52	-25.62	0-360	299	V
6	517.426	30.17	Pk	23.7	-28.1	25.77	46.02	-20.25	0-360	399	V

Pk - Peak detector
 Qp - Quasi-Peak detector

10.5. WORST CASE 18-26 GHZ

SPURIOUS EMISSIONS 18-26 GHz (WORST-CASE CONFIGURATION)

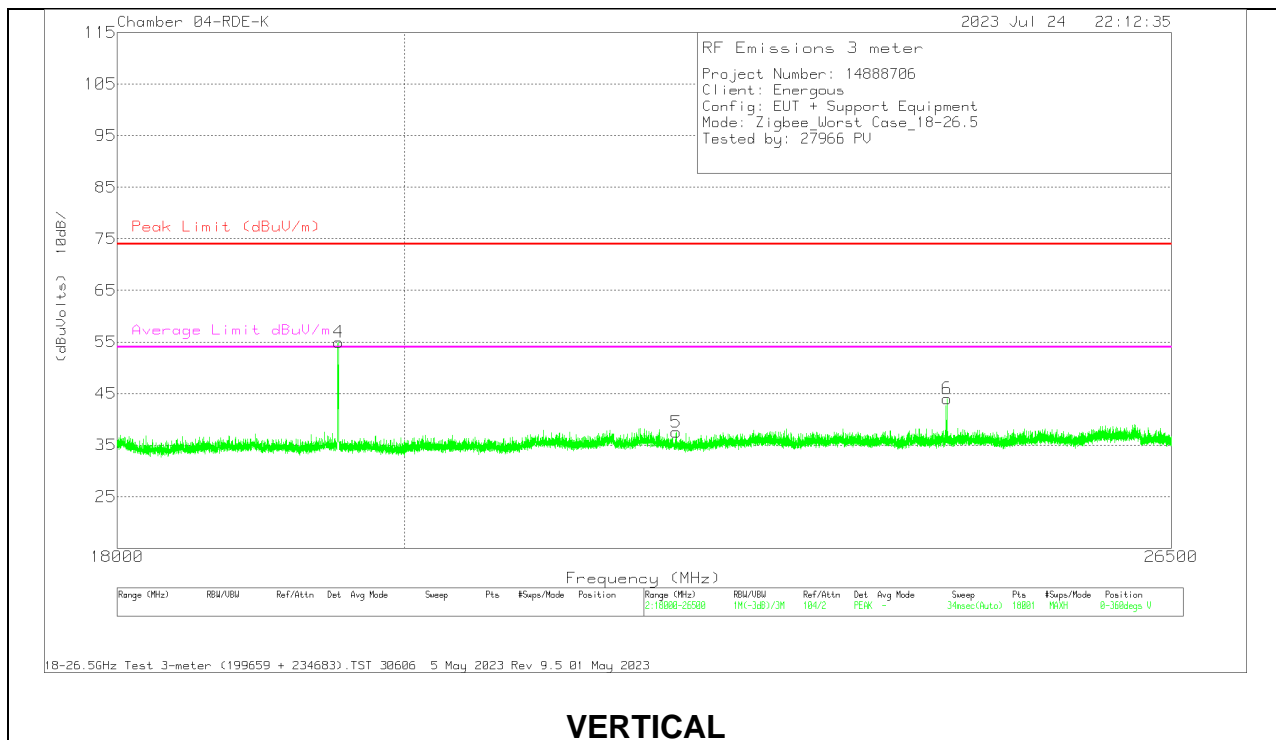
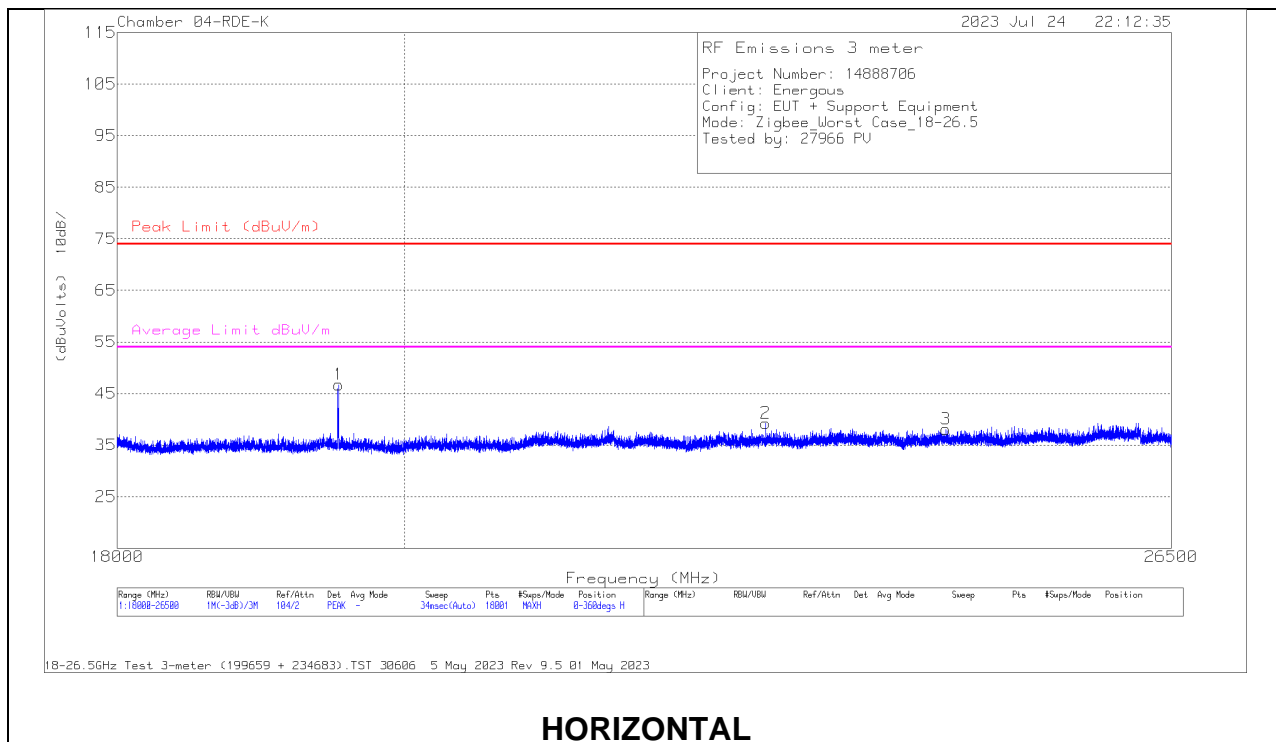

18 – 26GHz DATA

Marker	Frequency (MHz)	Meter Reading (dBuV)	Det	Horn ACF (dB/m)	234683 Amp/Cbl (dB)	Cables (dB)	Corrected Reading (dBuVolts)	Peak Limit (dBuV/m)	PK Margin (dB)	Average Limit dBuV/m	Margin (dB)	Azimuth (Degs)	Height (cm)	Polarity
1	* 19523.86	58.32	Pk	32.6	-62.7	18.5	46.72	74	-27.28	-	-	0-360	100	H
2	* 22835.553	48.35	Pk	33.4	-62.5	20	39.25	74	-34.75	-	-	0-360	100	H
3	24394.83	45.97	Pk	33.9	-62.4	20.6	38.07	74	-35.93	-	-	0-360	100	H
4	* 19523.892	66.42	Pk	32.6	-62.7	18.5	54.82	74	-19.18	-	-	9	118	V
	* 19523.892	60.64	RMS	32.6	-62.7	18.5	49.04	-	-	54	-4.96	9	118	V
5	* 22097.943	47.11	Pk	33.2	-62.4	19.6	37.51	74	-36.49	-	-	0-360	200	V
6	24405.219	51.89	Pk	33.9	-62.4	20.6	43.99	74	-30.01	-	-	0-360	101	V

* - indicates frequency in CFR47 Pt 15 / IC RSS-Restricted Band

Pk - Peak detector

RMS - RMS detection