



# **TEST REPORT**

**Report Number:** 13710438-E1V3

**Applicant :** ENERGOUS CORPORATION  
3590 NORTH FIRST STREET,  
SUITE 210,  
SAN JOSE, CA 95134, U.S.A.

**Model :** VN-1810

**FCC ID :** 2ADNG-VN1810

**EUT Description :** WIRELESS CHARGER

**Test Standard(s) :** FCC CFR 47 PART 18 SUBPART C

**Date Of Issue:**

September 27, 2021

**Prepared by:**

UL Verification Services Inc.  
47173 Benicia Street  
Fremont, CA 94538, U.S.A.  
TEL: (510) 319-4000  
FAX: (510) 661-0888



## REPORT REVISION HISTORY

Rev.	Issue Date	Revisions	Revised By
1	9/13/2021	Initial Issue	--
2	9/17/2021	Corrected firmware version on Section 5.4	Tina Chu
3	9/27/2021	Updated Sections 5.2, 5.5, 8 and 8.1	Tina Chu

## TABLE OF CONTENTS

<b>REPORT REVISION HISTORY</b> .....	<b>2</b>
<b>TABLE OF CONTENTS</b> .....	<b>3</b>
<b>1. ATTESTATION OF TEST RESULTS</b> .....	<b>5</b>
<b>2. TEST METHODOLOGY</b> .....	<b>7</b>
<b>3. FACILITIES AND ACCREDITATION</b> .....	<b>7</b>
<b>4. DECISION RULES AND MEASUREMENT UNCERTAINTY</b> .....	<b>8</b>
4.1. <i>METROLOGICAL TRACEABILITY</i> .....	8
4.2. <i>DECISION RULES</i> .....	8
4.3. <i>MEASUREMENT UNCERTAINTY</i> .....	8
4.4. <i>SAMPLE CALCULATION</i> .....	8
<b>5. EQUIPMENT UNDER TEST</b> .....	<b>9</b>
5.1. <i>EUT DESCRIPTION</i> .....	9
5.2. <i>OPERATING FREQUENCY AND POWER</i> .....	9
5.3. <i>DESCRIPTION OF AVAILABLE ANTENNAS</i> .....	9
5.4. <i>SOFTWARE AND FIRMWARE</i> .....	9
5.5. <i>WORST-CASE CONFIGURATION AND MODE</i> .....	10
5.6. <i>DESCRIPTION OF TEST SETUP</i> .....	11
<b>7. TEST AND MEASUREMENT EQUIPMENT</b> .....	<b>13</b>
<b>8. RADIATED EMISSIONS</b> .....	<b>14</b>
8.1. <i>SPURIOUS EMISSIONS 9 kHz TO 30 MHz</i> .....	16
8.1.1. <i>CONFIGURATION 1</i> .....	16
8.1.2. <i>CONFIGURATION 2</i> .....	17
8.2. <i>SPURIOUS EMISSIONS 30 MHz TO 1000 MHz</i> .....	19
8.2.1. <i>CONFIGURATION 1</i> .....	19
8.2.2. <i>CONFIGURATION 2</i> .....	21
8.3. <i>SPURIOUS EMISSIONS 1 GHz TO 10 GHz</i> .....	26
8.3.1. <i>CONFIGURATION 1</i> .....	26
8.3.2. <i>CONFIGURATION 2</i> .....	28
<b>9. AC POWER LINE CONDUCTED EMISSIONS</b> .....	<b>32</b>
9.1. <i>CONFIGURATION 1</i> .....	33
9.2. <i>CONFIGURATION 2</i> .....	35
<b>10. SETUP PHOTOS</b> .....	<b>37</b>

10.1. CONFIGURATION 1 ..... 37  
10.2. CONFIGURATION 2 ..... 39

# 1. ATTESTATION OF TEST RESULTS

**COMPANY NAME:** ENERGOUS CORPORATION  
3590 NORTH FIRST STREET,  
SUITE 210,  
SAN JOSE, CA 95134, U.S.A

**EUT DESCRIPTION:** WIRELESS CHARGER

**MODEL NUMBER:** VN-1810

**BRAND:** ENERGOUS

**SERIAL NUMBER:** 7004

**SAMPLE RECEIPT DATE:** AUGUST 24, 2021

**DATE TESTED:** AUGUST 24, 2021 – SEPTEMBER 02, 2021

APPLICABLE STANDARDS	
STANDARD	TEST RESULTS
FCC CFR 47 PART 18 SUBPART C	Complies

UL Verification Services Inc. tested the above equipment in accordance with the requirements set forth in the above standards. The test results show that the equipment tested is capable of demonstrating compliance with the requirements as documented in this report.

The results documented in this report apply only to the tested sample, under the conditions and modes of operation as described herein. It is the manufacturer's responsibility to assure that additional production units of this model are manufactured with identical electrical and mechanical components. All samples tested were in good operating condition throughout the entire test program. Measurement Uncertainties are published for informational purposes only and were not taken into account unless noted otherwise.

This document may not be altered or revised in any way unless done so by UL Verification Services Inc. and all revisions are duly noted in the revisions section. Any alteration of this document not carried out by UL Verification Services Inc. will constitute fraud and shall nullify the document. This report must not be used by the client to claim product certification, approval, or endorsement by A2LA, NIST.

Approved & Released For  
UL Verification Services Inc. By:



---

DAN CORONIA  
OPERATIONS LEADER  
UL Verification Services Inc.

Prepared By:

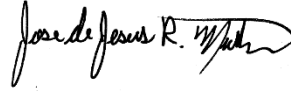

---

JOSE MARTINEZ  
TEST ENGINEER  
UL Verification Services Inc.

Reviewed By:

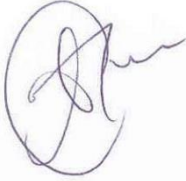

---

TINA CHU  
SENIOR PROJECT ENGINEER  
UL Verification Services Inc.

## 2. TEST METHODOLOGY

This report contains data provided by the customer which can impact the validity of results. UL Verification Services Inc. is only responsible for the validity of results after the integration of the data provided by the customer.

The tests documented in this report were performed in accordance with FCC / OST MP-5, "FCC Methods of Measurements of Radio Noise Emissions from Industrial, Scientific, and Medical Equipment."

## 3. FACILITIES AND ACCREDITATION

UL LLC is accredited by A2LA, certification #0751.05, for all testing performed within the scope of this report. Testing was performed at the locations noted below.

	Address	ISED CABID	ISED Company Number	FCC Registration
<input type="checkbox"/>	Building 1: 47173 Benicia Street, Fremont, CA 94538, USA	US0104	2324A	208313
<input type="checkbox"/>	Building 2: 47266 Benicia Street, Fremont, CA 94538, USA	US0104	22541	208313
<input checked="" type="checkbox"/>	Building 4: 47658 Kato Rd, Fremont, CA 94538, USA	US0104	2324B	208313

## 4. DECISION RULES AND MEASUREMENT UNCERTAINTY

### 4.1. METROLOGICAL TRACEABILITY

All test and measuring equipment utilized to perform the tests documented in this report are calibrated on a regular basis, with a maximum time between calibrations of one year or the manufacturers' recommendation, whichever is less, and where applicable is traceable to recognized national standards.

### 4.2. DECISION RULES

The Decision Rule is based on Simple Acceptance in accordance with ISO Guide 98-4:2012 Clause 8.2. (Measurement uncertainty is not taken into account when stating conformity with a specified requirement.)

### 4.3. MEASUREMENT UNCERTAINTY

Where relevant, the following measurement uncertainty levels have been estimated for tests performed on the apparatus:

PARAMETER	U <sub>Lab</sub>
Worst Case Conducted Disturbance, 9KHz to 0.15 MHz	3.78 dB
Worst Case Conducted Disturbance, 0.15 to 30 MHz	3.40 dB
Worst Case Radiated Disturbance, 9KHz to 30 MHz	2.84 dB
Worst Case Radiated Disturbance, 30 to 1000 MHz	6.01 dB
Worst Case Radiated Disturbance, 1000 to 18000 MHz	4.73 dB
Worst Case Radiated Disturbance, 18000 to 26000 MHz	4.51 dB
Worst Case Radiated Disturbance, 26000 to 40000 MHz	5.29 dB

Uncertainty figures are valid to a confidence level of 95%.

### 4.4. SAMPLE CALCULATION

#### RADIATED EMISSIONS

Where relevant, the following sample calculation is provided:

Field Strength (dBuV/m) = Measured Voltage (dBuV) + Antenna Factor (dB/m) + Cable Loss (dB) – Preamp Gain (dB)

$$36.5 \text{ dBuV} + 18.7 \text{ dB/m} + 0.6 \text{ dB} - 26.9 \text{ dB} = 28.9 \text{ dBuV/m}$$

#### MAINS CONDUCTED EMISSIONS

Where relevant, the following sample calculation is provided:

Final Voltage (dBuV) = Measured Voltage (dBuV) + Cable Loss (dB) + Limiter Factor (dB) + LISN Insertion Loss.

$$36.5 \text{ dBuV} + 0 \text{ dB} + 10.1 \text{ dB} + 0 \text{ dB} = 46.6 \text{ dBuV}$$



## **5. EQUIPMENT UNDER TEST**

### **5.1. EUT DESCRIPTION**

The EUT is an over-the-air, distance charging transmitter. Wireless power transfer is only transmitting a continuous carrier wave signal at 917.5 MHz frequency single channel when client device is positioned within the charging zone. The charging zone of the EUT is up to 1 meter for client device placed in front of the EUT. The EUT can only charge one client device at a time. The EUT uses BLE to pair with the client device.

This report documents test results of the Wireless Power Transfer ISM portion of the wireless charger.

### **5.2. OPERATING FREQUENCY AND POWER**

The EUT operates at 917.5 MHz. And the maximum RF energy generated is 40dBm as declared by the applicant. The device is powered via a CONN power jack interface (28V / 1.0 Amps).

This device also includes an ultrasonic sensor operating at 175 kHz at power/energy level of less than 1mW.

### **5.3. DESCRIPTION OF AVAILABLE ANTENNAS**

The antenna gain(s) and type, as provided by the manufacturer, are as follows:

The EUT supports one patch antenna with antenna peak gain 8dBi.

### **5.4. SOFTWARE AND FIRMWARE**

The firmware installed in the EUT during testing was Version: 5.0.2.255

The test utility software was WattUp app Version: : 4.0.31

## 5.5. WORST-CASE CONFIGURATION AND MODE

The EUT is a tabletop device and it has two ports, one is the CONN power jack port for power only, second port is a micro USB port for command line interface control, end user will not have access to it. Therefore, all final radiated testing was performed with the EUT in tabletop orientation powered by AC/DC adapter via cable.

The worst case orientation and position of the client device was investigated and declared by the applicant. The applicant determined that the operating condition for worst-case emissions is when the charger is operating at the maximum rated level and the maximum possible power (as adjusted by internal power control circuitry) is coupled to the client device. This condition occurs at the following orientation and position: the client device is directly centered on the tabletop, 35cm in front of the EUT with a landscape orientation where right side of the client is directly pointing at the EUT. All of the charging mode final testing is performed using this configuration of charger and client.

The antenna is active for all the charging mode testing.

Configuration	Mode	Description
1	Standby mode	EUT is powered by AC/DC adapter via cable. Wireless Power Transfer ISM portion is in standby mode, ultrasonic sensor is on. Ultrasonic sensor and BLE are in normal operating mode as the worst case.
2	Charging mode	EUT is powered by AC/DC adapter via cable and client device receives maximum 917.5 MHz RF energy from EUT, ultrasonic sensor is on. Wireless Power Transfer ISM portion, ultrasonic sensor, and BLE can transmit simultaneously. Ultrasonic sensor and BLE are in normal operating mode as the worst case.

### 5.6. DESCRIPTION OF TEST SETUP

SUPPORT TEST EQUIPMENT						
Description	Manufacturer	Model	Serial Number	FCC ID/ DoC		
1 Receiver (client device)	Energous	-	PER300F	DoC		
EUT AC/DC Adapter (80 W)	TDK-Lambda	DT80PW280D	E20122202-4M-0011-2105	DoC		
I/O CABLES (RF RADIATED/AC POWER LINE TEST)						
Cable No.	Port	# of Identical Ports	Connector Type	Cable Type	Cable Length (m)	Remarks
1	AC	1	AC	Un-shielded	1.8	AC Mains to AC/DC Adapter
2	DC	1	CONN PWR JACK	Un-shielded	1.5	AC/DC Adapter to EUT

#### TEST SETUP- RADIATED TEST/AC POWER LINE TEST

The EUT is powered by AC/DC adapter via cable, the client device is directly centered on the tabletop, 35cm in front of the EUT with a landscape orientation where right side of the client is directly pointing at the EUT. All of the charging mode final testing is performed at this configuration.

#### SETUP DIAGRAM

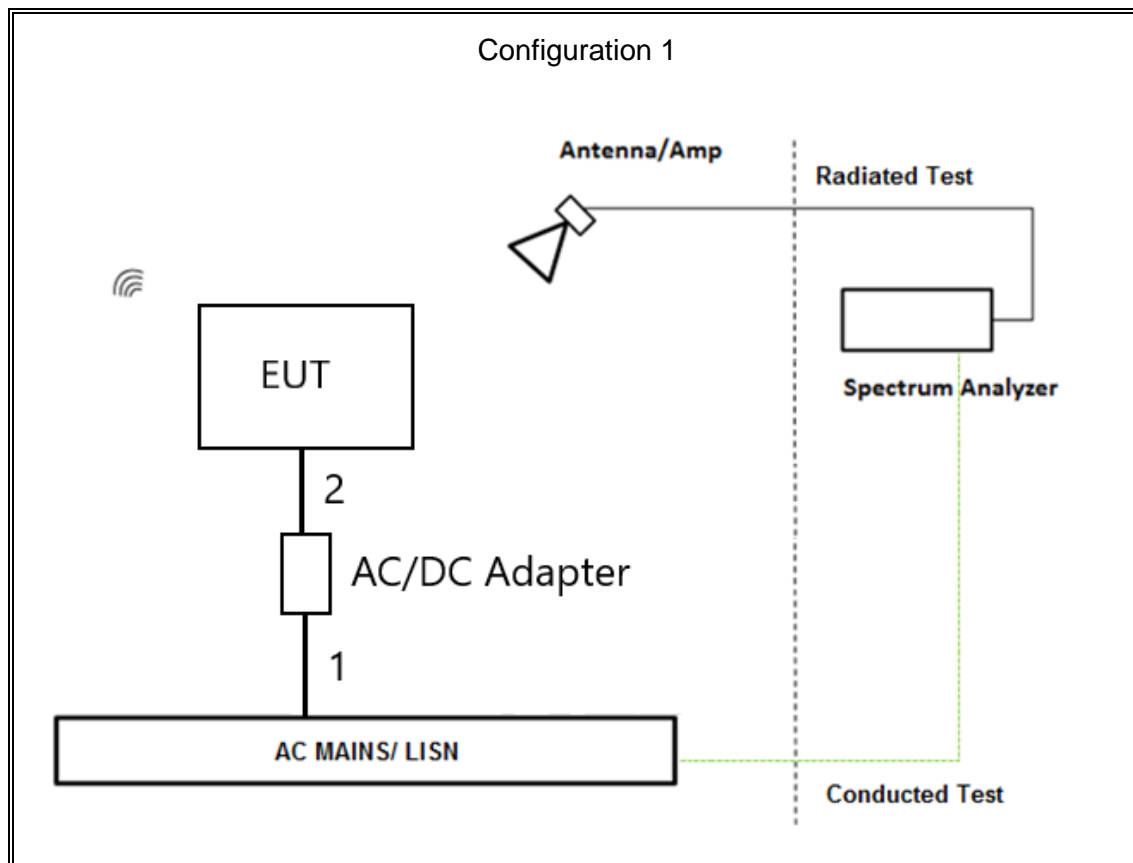

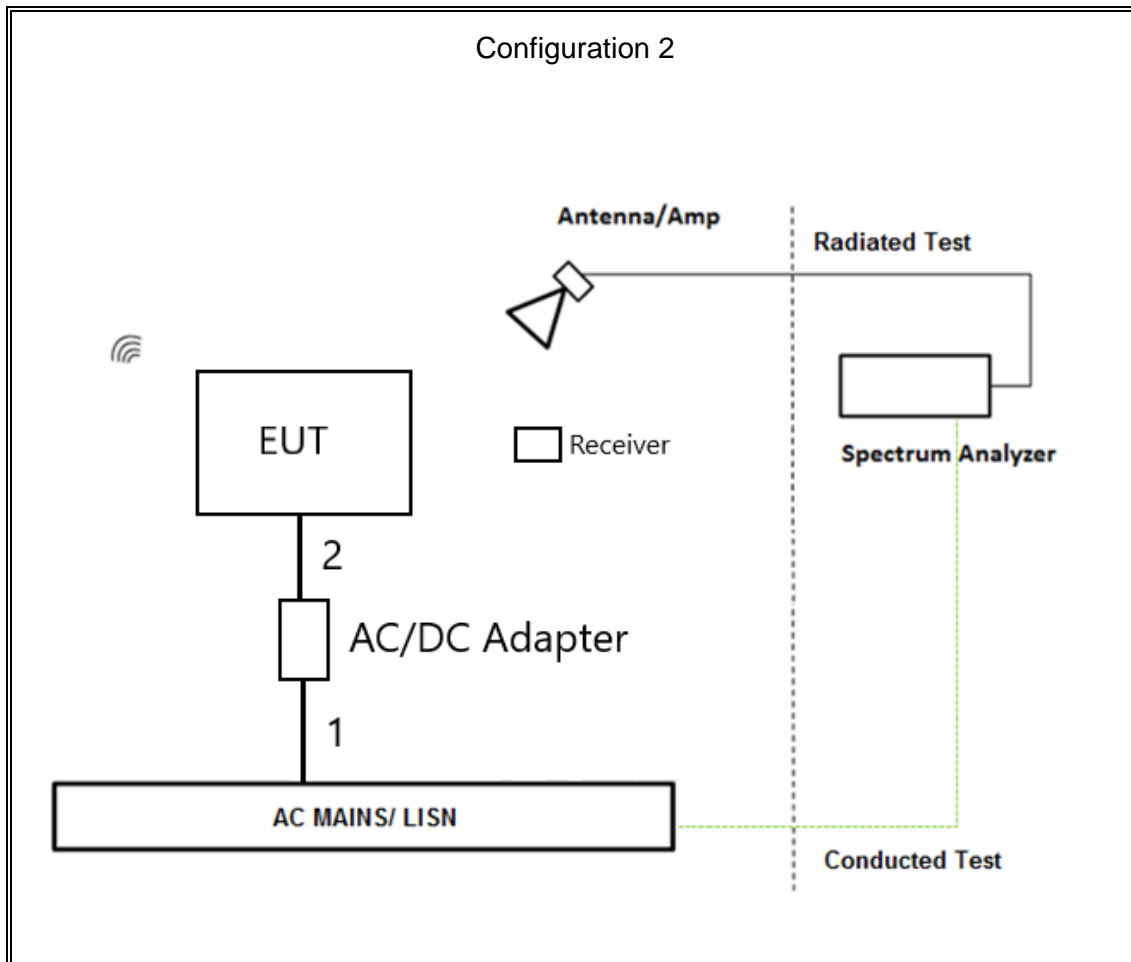

## 7. TEST AND MEASUREMENT EQUIPMENT

The following test and measurement equipment was utilized for the tests documented in this report:

<b>TEST EQUIPMENT LIST</b>				
<b>Description</b>	<b>Manufacturer</b>	<b>Model</b>	<b>Asset</b>	<b>Cal Due</b>
Antenna, Passive Loop 30Hz - 1MHz	ELECTRO METRICS	EM-6871	SC-8015	05/24/2022
Antenna, Passive Loop 100KHz - 30MHz	ELECTRO METRICS	EM-6872	SC-8014	05/24/2022
Antenna, Horn 1-18GHz	ETS-Lindgren	3117	* T863	08/31/2021
Amplifier, 100MHz-18GHz	AMPLICAL	AMP0.1G18-47-20	PRE0197319	04/08/2022
Antenna, Broadband Hybrid, 30MHz to 2GHz	Sunol Sciences Corp.	JB3	81560	09/24/2021
Amplifier, 9KHz to 1GHz, 32dB	SONOMA INSTRUMENT	310	175953	01/21/2022
EMI TEST RECEIVER	Rohde & Schwarz	ESW44	PRE0179367	02/21/2022
Filter, BRF 902 to 928MHz	MICRO-TRONICS	BRC50722	T1847	04/08/2022
Filter, HPF 1.5 to 18GHz	MICRO-TRONICS	HPM50114	204786	06/24/2022
<b>AC Line Conducted</b>				
<b>Description</b>	<b>Manufacturer</b>	<b>Model</b>	<b>ID Num</b>	<b>Cal Due</b>
LISN	Fischer Custom Communications, Inc	FCC-LISN-50/250-25-2-01-480V	PRE0186446	01/20/2022
EMI TEST RECEIVER	Rohde & Schwarz	ESR	T1436	02/19/2022
Transient Limiter	TE	TBFL1	207996	06/01/2022
<b>UL AUTOMATION SOFTWARE</b>				
Radiated Software	UL	UL EMC	Rev 9.5, 03 Sept, 2020	
AC Line Conducted Software	UL	UL EMC	Rev 9.5, 07 Jul 2020	

\* Testing is completed before equipment expiration date.

## 8. RADIATED EMISSIONS

### LIMIT

#### §18.301 Operating frequencies

The EUT operates at 917.5 MHz, within the tolerance of the ISM Frequency of 915 +/- 13MHz.

#### §18.305 Field Strength Limits

(b) The field strength levels of emissions which lie outside the bands specified in §18.301, unless otherwise indicated, shall not exceed the following:

Equipment	Operating frequency	RF Power generated by equipment (watts)	Field strength limit (µV/m)	Distance (meters)
Any type unless otherwise specified (miscellaneous)	Any ISM frequency	Below 500 500 or more	25 25 x SQRT(power/500)	300 <sup>1</sup> 300

<sup>1</sup>Field strength may not exceed 10µV/m at 1600 meters. Consumer equipment operating below 1000 MHz is not permitted the increase in field strength otherwise permitted here for power over 500 watts.

The RF Power generated by the equipment is below 500 W therefore the field strength limit is 25uV/m at 300 m, equivalent to 28 dBuV/m at 300 m.

### TEST PROCEDURE

Tested in accordance with FCC / OST MP-5

The frequency range was investigated from 9 kHz to 10 GHz. An EUT which is normally operated on a table shall be placed on a non-conducting table having a height of 1 meter above test site ground level for all frequency ranges.

For pre-scans above 1 GHz the resolution bandwidth is set to 1 MHz; the video bandwidth is set to 30 KHz for peak measurements.

For final measurements above 1 GHz the resolution bandwidth is set to 1 MHz; the video bandwidth is set to 3 MHz for peak measurements and as applicable for average measurements.

For below 30MHz testing, investigation was done on three antenna orientations (parallel, perpendicular, and ground-parallel), parallel and perpendicular are the worst orientations, therefore testing was performed on these two orientations only. Blue color trace on plots: Parallel orientation. Green color trace on plots: Perpendicular orientation. For a loop antenna, the antenna height shall be set at around 2 meters.

**KDB 414788 Open Field Site(OFS) and Chamber Correlation Justification**

For below 30MHz testing, based on KDB 414788, Clause 2, for Part 18 equipment, Section 2.1 of FCC Measurement Procedure MP-5 also permits the use of test sites other than an open-field test site only if it can be shown that the results obtained at such a location are correlated with those made at an open-field test site.

OFS and chamber correlation testing had been performed and chamber measured test result is the worst case test result.

**Distance Correction Factor**

Based on FCC 18.305, note 2. Testing for compliance with these limits may be made at closer distances, provided a sufficient number of measurements are taken to plot the radiation pattern, to determine the major lobes of radiation, and to determine the expected field strength level at 30, 300, or 1600 meters. Alternatively, if measurements are made at only one closer fixed distance, then the permissible field strength limits shall be adjusted using 1/d as an attenuation factor.

- Distance factor from 3m to 300m =  $20\log(3/300) = -40\text{dB}$

**RESULTS**

This device includes an ultrasonic sensor. The Part 18 limits for this sensor (ultrasonic operating below 500W at 175 kHz) are  $2,400/F(\text{kHz})$  at 300m, and so the limit is 13.7 uV/m (22.7 dBuV/m) at 300m for the frequency range 9kHz – 30 MHz (18.309). Emissions are evaluated in section 8.1

## 8.1. SPURIOUS EMISSIONS 9 kHz TO 30 MHz

### 8.1.1. CONFIGURATION 1

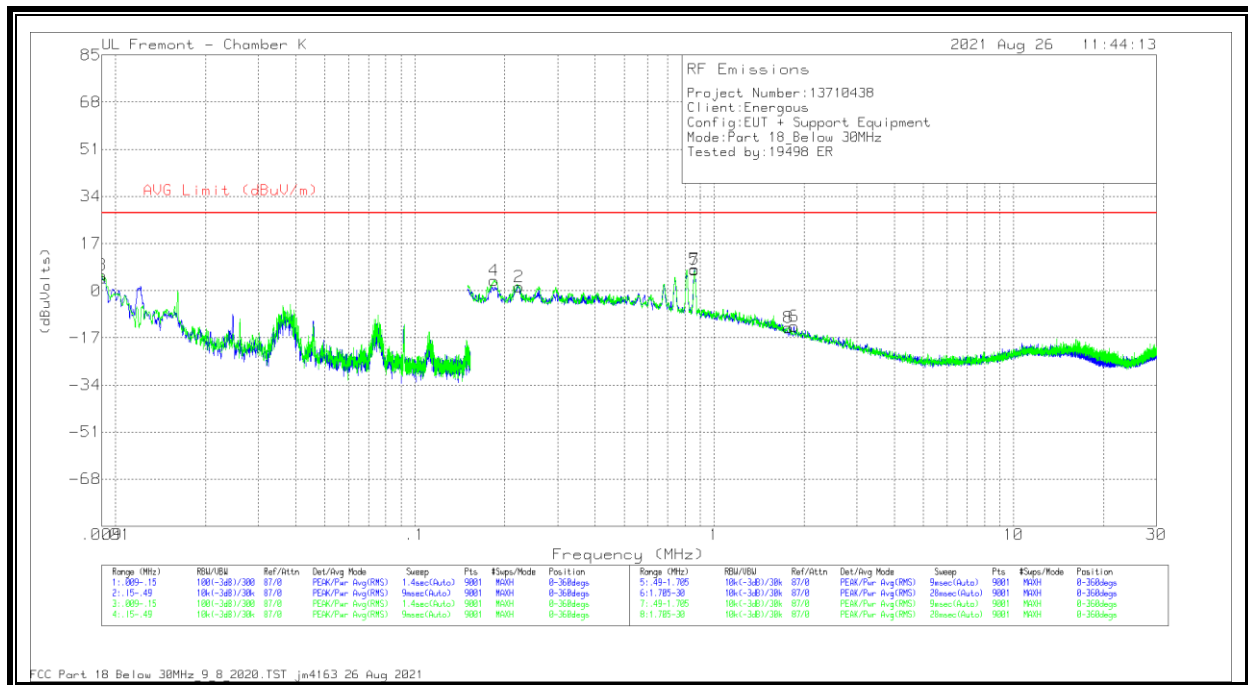

## DATA

Marker	Frequency (MHz)	Meter Reading (dBuV)	Det	Loop Antenna (E ACF)	Amp/Cbl (dB)	Dist Corr 300m	Corrected Reading (dBuVolts/m)	Part 18 Limit 300m (dBuV/m)	Margin (dB)	Azimuth (Degs)
1	.00903	14.37	Pk	61.4	-31.3	-40	4.47	22.7	-18.23	0-360
2	.22332	17.43	Pk	56.2	-32.2	-40	1.43	22.7	-21.27	0-360
3	.00902	15.63	Pk	61.4	-31.3	-40	5.73	22.7	-16.97	0-360
4	.1842	19.7	Pk	56.1	-32.2	-40	3.6	22.7	-19.1	0-360
5	.8601	32.11	Pk	47.9	-32.2	-40	7.81	22.7	-14.89	0-360
6	1.84648	16.89	Pk	42.3	-32.1	-40	-12.91	22.7	-35.61	0-360
7	.86024	31.72	Pk	47.9	-32.2	-40	7.42	22.7	-15.28	0-360
8	1.76788	16.07	Pk	42.7	-32.1	-40	-13.33	22.7	-36.03	0-360

Pk - Peak detector

Note:

- Test was performed @ 3 meter distance.
- Distance factor from 3m to 300m =  $20\log(3/300) = -40\text{dB}$
- The limit line is shown at 28 dBuV/m in the plot for the WPT transmitter but the table limits reflect the lower limits for the ultrasonic sensor which is only on when WPT is in standby mode.



### 8.1.2. CONFIGURATION 2

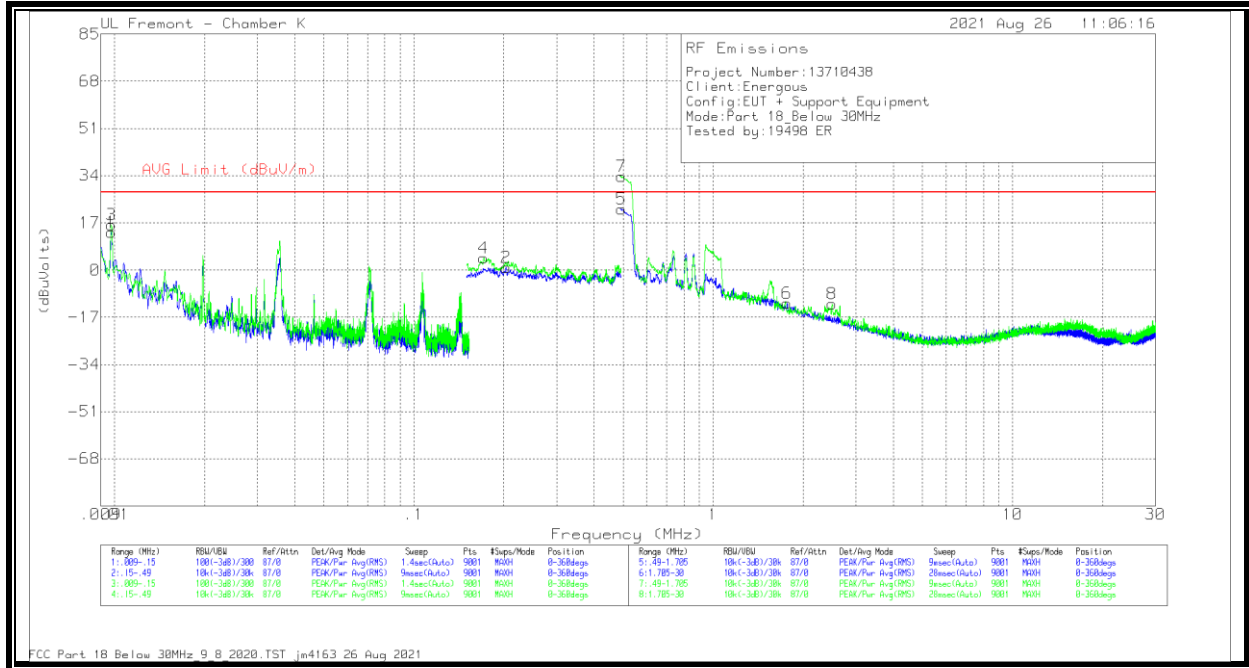

### DATA

For the WPT with limit 28dBuV/m at 300 meter

Marker	Frequency (MHz)	Meter Reading (dBuV)	Det	Loop Antenna (E ACF)	Amp/Cbl (dB)	Dist Corr 300m	Corrected Reading (dBuVolts/m)	Part 18 Limit 300m (dBuV/m)	Margin (dB)	Azimuth (Degs)
1	.00977	24.39	Pk	60.6	-31.3	-40	13.69	28	-14.31	0-360
2	.20341	16.97	Pk	56.2	-32.2	-40	.97	28	-27.03	0-360
3	.00977	26.98	Pk	60.6	-31.3	-40	16.28	28	-11.72	0-360
4	.17126	20.53	Pk	56	-32.2	-40	4.33	28	-23.67	0-360
5	.49344	41.79	Pk	52.3	-32.2	-40	21.89	28	-6.11	0-360
6	1.76474	17.53	Pk	42.7	-32.1	-40	-11.87	28	-39.87	0-360
7	.49365	53.58	Pk	52.3	-32.2	-40	33.68	28	5.68	0-360
	.49	46.31	RMS	52.4	-32.2	-40	26.51	28	-1.49	257
8	2.49414	19.87	Pk	40.1	-32.1	-40	-12.13	28	-40.13	0-360

For the Ultrasonic sensor with limit 22.7dBuV/m at 300 meter

Marker	Frequency (MHz)	Meter Reading (dBuV)	Det	Loop Antenna (E ACF)	Amp/Cbl (dB)	Dist Corr 300m	Corrected Reading (dBuVolts/m)	Part 18 Limit 300m (dBuV/m)	Margin (dB)	Azimuth (Degs)
1	.00977	24.39	Pk	60.6	-31.3	-40	13.69	22.7	-9.01	0-360
2	.20341	16.97	Pk	56.2	-32.2	-40	.97	22.7	-21.73	0-360
3	.00977	26.98	Pk	60.6	-31.3	-40	16.28	22.7	-6.42	0-360
4	.17126	20.53	Pk	56	-32.2	-40	4.33	22.7	-18.37	0-360
6	1.76474	17.53	Pk	42.7	-32.1	-40	-11.87	22.7	-34.57	0-360
8	2.49414	19.87	Pk	40.1	-32.1	-40	-12.13	22.7	-34.83	0-360

Pk - Peak detector  
 RMS - RMS detection

Note:

- Test was performed @ 3 meter distance.
- Distance factor from 3m to 300m =  $20\log(3/300) = -40\text{dB}$

- WPT and ultrasonic sensor are active for this test therefore then higher limit for the WPT transmitter are used for this test configuration.

## 8.2. SPURIOUS EMISSIONS 30 MHz TO 1000 MHz

### 8.2.1. CONFIGURATION 1

#### Spurious Emissions 30 – 1000 MHz

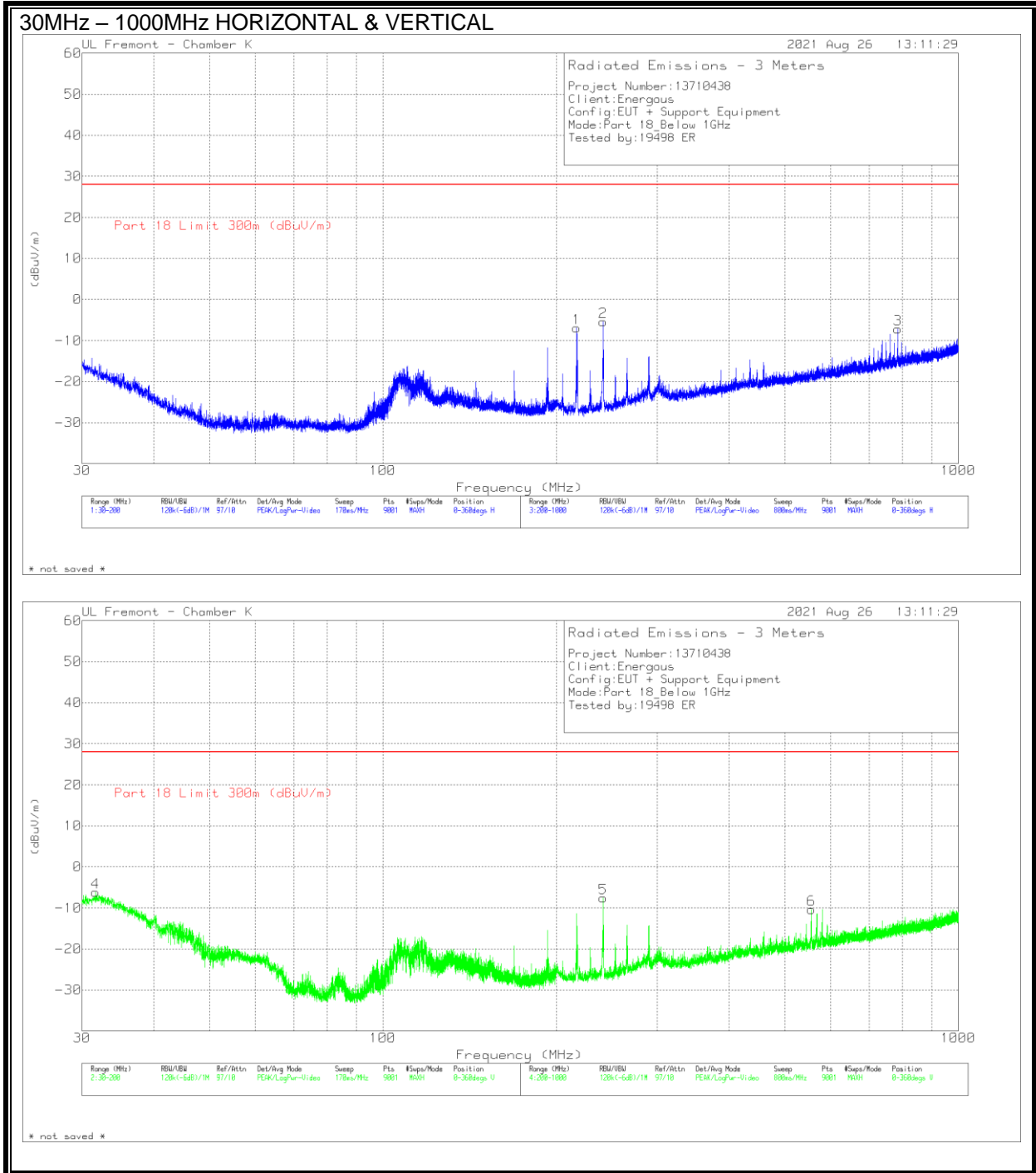

**DATA**

Marker	Frequency (MHz)	Meter Reading (dBuV)	Det	AF 81560 (dB/m)	Amp/Cbl (dB)	Dist Corr (dB)	Corrected Reading (dBuV/m)	Part 18 Limit 300m (dBuV/m)	Margin (dB)	Azimuth (Degs)	Height (cm)	Polarity
4	31.7	38.7	Pk	26.7	-31.6	-40	-6.2	28	-34.2	0-360	97	V
1	217.2445	46.11	Pk	17.1	-30.2	-40	-6.99	28	-34.99	0-360	100	H
2	241.4223	46.67	Pk	18	-30.1	-40	-5.43	28	-33.43	0-360	100	H
	241.4774	45.38	RMS	18	-30.1	-40	-6.72	28	-34.72	203	100	H
3	785.3341	33.27	Pk	27.6	-28	-40	-7.13	28	-35.13	0-360	100	H
5	241.4223	44.53	Pk	18	-30.1	-40	-7.57	28	-35.57	0-360	199	V
6	555.9116	33.99	Pk	24.6	-29	-40	-10.41	28	-38.41	0-360	101	V

Pk - Peak detector  
 RMS - RMS detection

Note:

- Test was performed @ 3 meter distance.
- Distance factor from 3m to 300m =  $20\log(3/300) = -40\text{dB}$

## 8.2.2. CONFIGURATION 2

### Spurious Emissions 30 – 1000 MHz with a Band Reject Filter

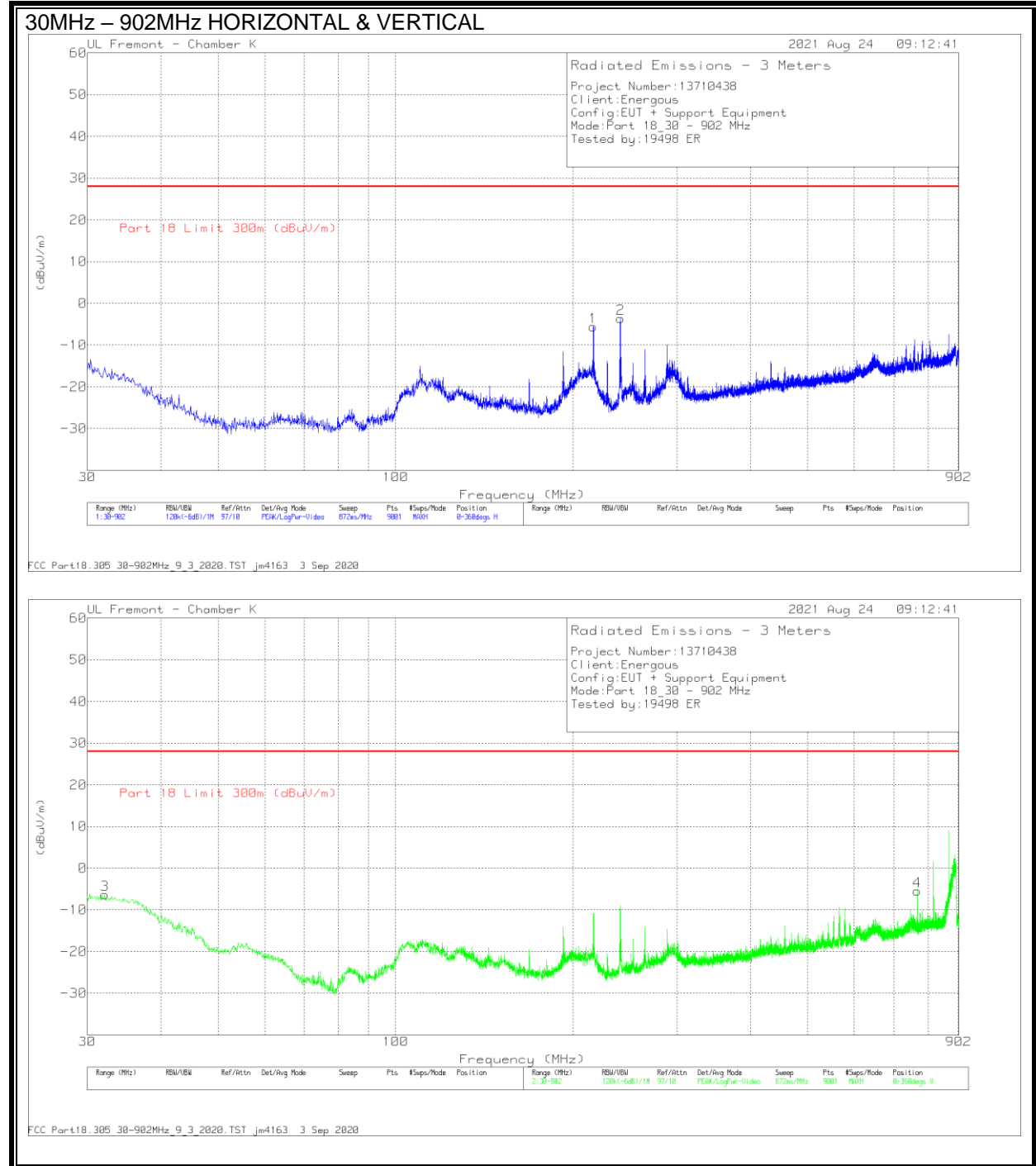

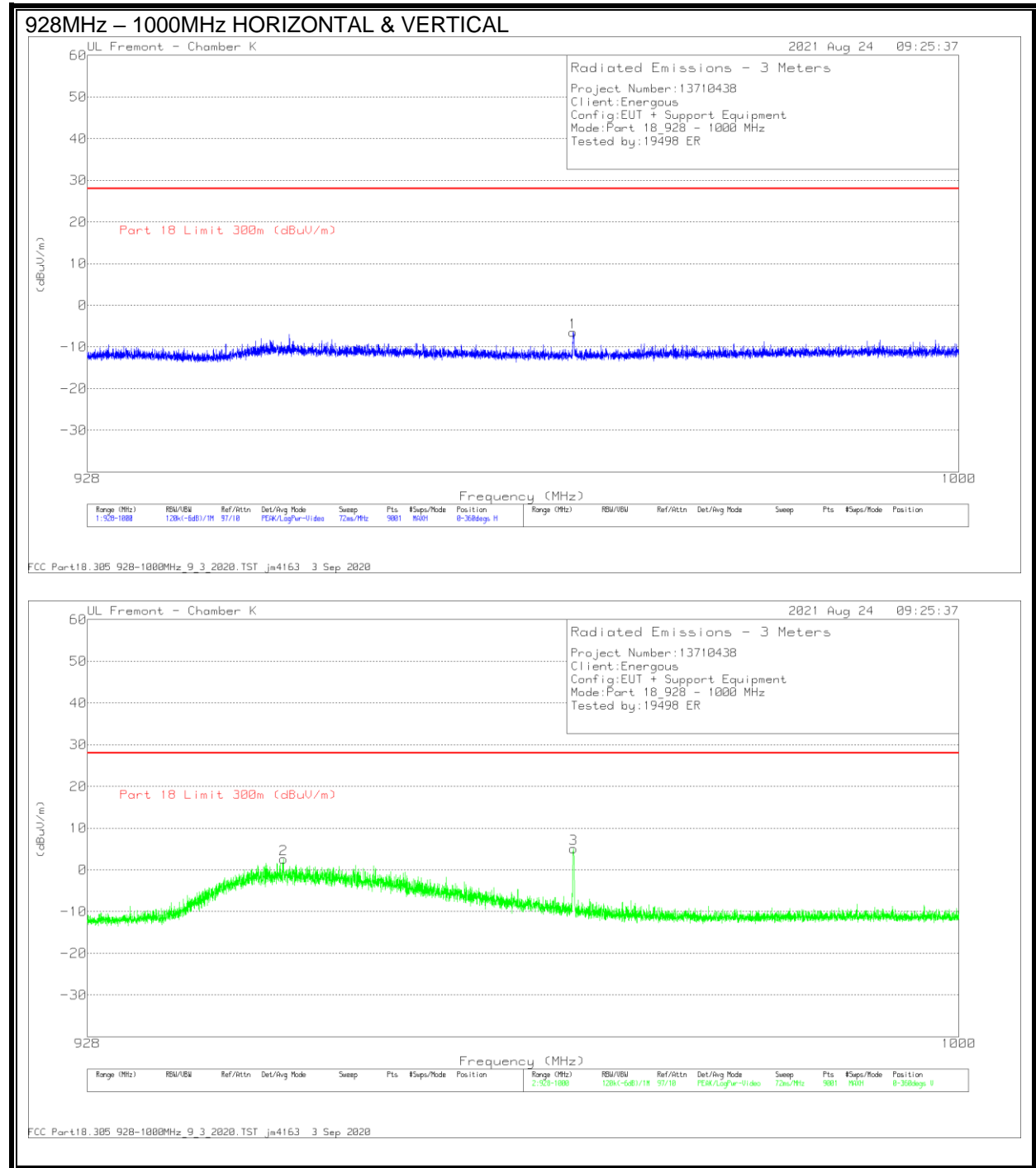

**DATA**

30MHz – 902MHz range

Marker	Frequency (MHz)	Meter Reading (dBuV)	Det	AF 81560 (dB/m)	Amp/Cbl (dB)	Dist Corr (dB)	T1847 BRF (dB)	Corrected Reading (dBuV/m)	Part 18 Limit 300m (dBuV/m)	Margin (dB)	Azimuth (Degs)	Height (cm)	Polarity
1	216.5113	46.8	Pk	17.1	-30.3	-40	.8	-5.6	28	-33.6	0-360	100	H
2	240.6367	47.65	Pk	18	-30.1	-40	.8	-3.65	28	-31.65	0-360	100	H
	240.6787	46.89	RMS	18	-30.1	-40	.8	-4.41	28	-32.41	213	115	H
3	32.1316	38.12	Pk	26.4	-31.6	-40	.8	-6.28	28	-34.28	0-360	100	V
4	767.5191	34.38	Pk	27.4	-28.1	-40	.8	-5.52	28	-33.52	0-360	199	V

Pk - Peak detector  
 RMS - RMS detection

928MHz – 1000MHz range

Marker	Frequency (MHz)	Meter Reading (dBuV)	Det	AF 81560 (dB/m)	Amp/Cbl (dB)	Dist Corr (dB)	T1847 BRF (dB)	Corrected Reading (dBuV/m)	Part 18 Limit 300m (dBuV/m)	Margin (dB)	Azimuth (Degs)	Height (cm)	Polarity
1	967.48	29.67	Pk	29.4	-26.3	-40	.8	-6.43	28	-34.43	0-360	197	H
2	943.744	39.5	Pk	29	-26.7	-40	.8	2.6	28	-25.4	0-360	98	V
3	967.496	41.14	Pk	29.4	-26.3	-40	.8	5.04	28	-22.96	0-360	98	V
	967.502	39.68	RMS	29.3	-26.3	-40	.8	3.48	28	-24.52	225	97	V

Pk - Peak detector  
 RMS - RMS detection

**Note:**

- Test was performed @ 3 meter distance.
- Distance factor from 3m to 300m =  $20\log(3/300) = -40\text{dB}$
- Band Reject Filter was used to prevent system overloading

**Spurious Emissions 800 – 1000 MHz without a Band Reject Filter and without amplifier**

Tested by:	19498 ER
Date:	8/24/2021

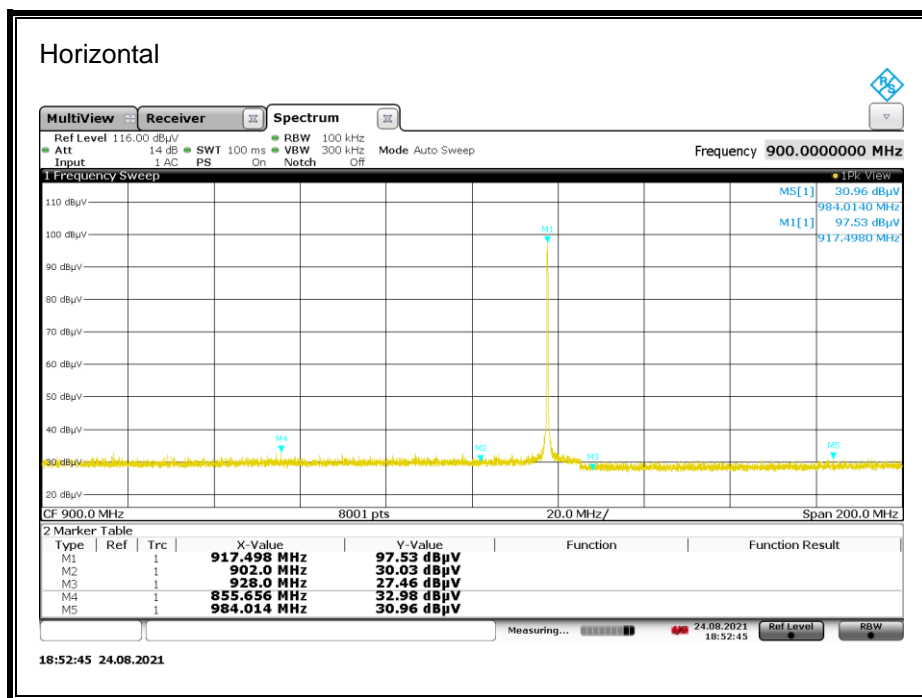

**DATA**

Marker	Frequency (MHz)	Meter Reading (dBuV)	Det	AF 81560 (dB/m)	Bypass Cable (dB)	Dist Corr (dB)	Corrected Reading (dBuV/m)	Part 18 Limit 300m (dBuV/m)	Margin (dB)	Azimuth (Degs)	Height (cm)	Polarity
4	855.656	32.98	Pk	28.1	3.9	-40	24.98	-	-	0-360	100-400	H
	855.4951	-4.23	RMS	28.1	3.9	-40	-12.23	28	-40.23	19	262	H
5	984.014	30.96	Pk	29.7	4.1	-40	24.76	-	-	0-360	100-400	H
	986.2378	-4.1	RMS	29.7	4.1	-40	-10.3	28	-38.3	308	319	H

Pk - Peak detector  
 RMS - RMS detection

Note:

- Test was performed @ 3 meter distance.
- Distance factor from 3m to 300m =  $20\log(3/300) = -40\text{dB}$



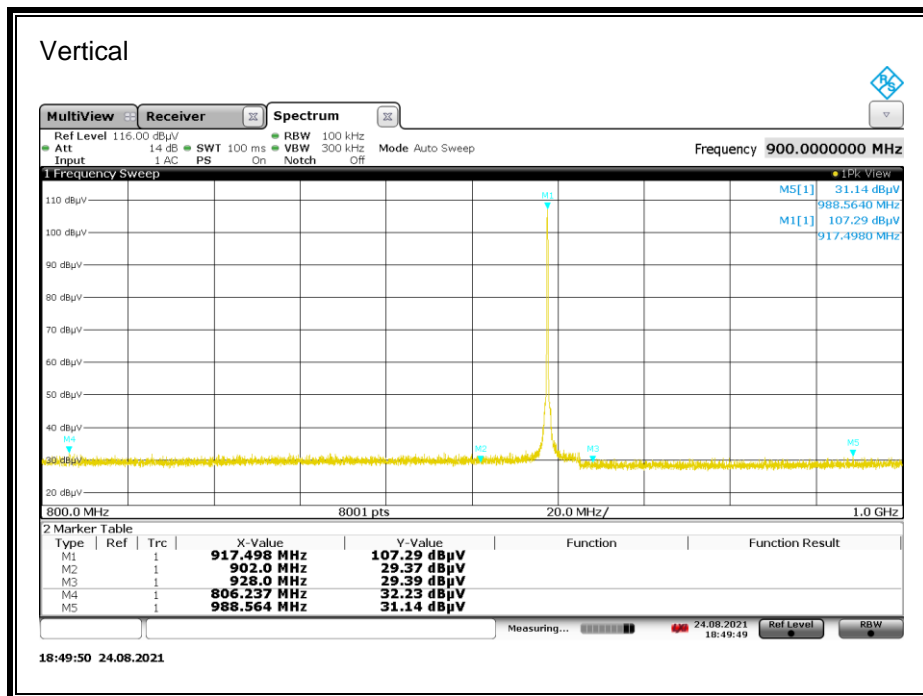

**DATA**

Marker	Frequency (MHz)	Meter Reading (dBuV)	Det	AF 81560 (dB/m)	Bypass Cable (dB)	Dist Corr (dB)	Corrected Reading (dBuV/m)	FCC PART18 300m LIMIT (dBuV/m)	Margin (dB)	Azimuth (Degs)	Height (cm)	Polarity
4	806.237	32.23	Pk	27.8	3.9	-40	23.93	-	-	0-360	100-400	V
	805.5594	-4.34	RMS	27.8	3.9	-40	-12.64	28	-40.64	139	268	V
5	988.564	31.14	Pk	29.7	4.1	-40	24.94	-	-	0-360	100-400	V
	988.7764	-3.97	RMS	29.7	4.1	-40	-10.17	28	-38.17	20	190	V

Pk - Peak detector  
 RMS - RMS detection

Note:

- Test was performed @ 3 meter distance.
- Distance factor from 3m to 300m =  $20\log(3/300) = -40\text{dB}$

### 8.3. SPURIOUS EMISSIONS 1 GHz TO 10 GHz

#### 8.3.1. CONFIGURATION 1

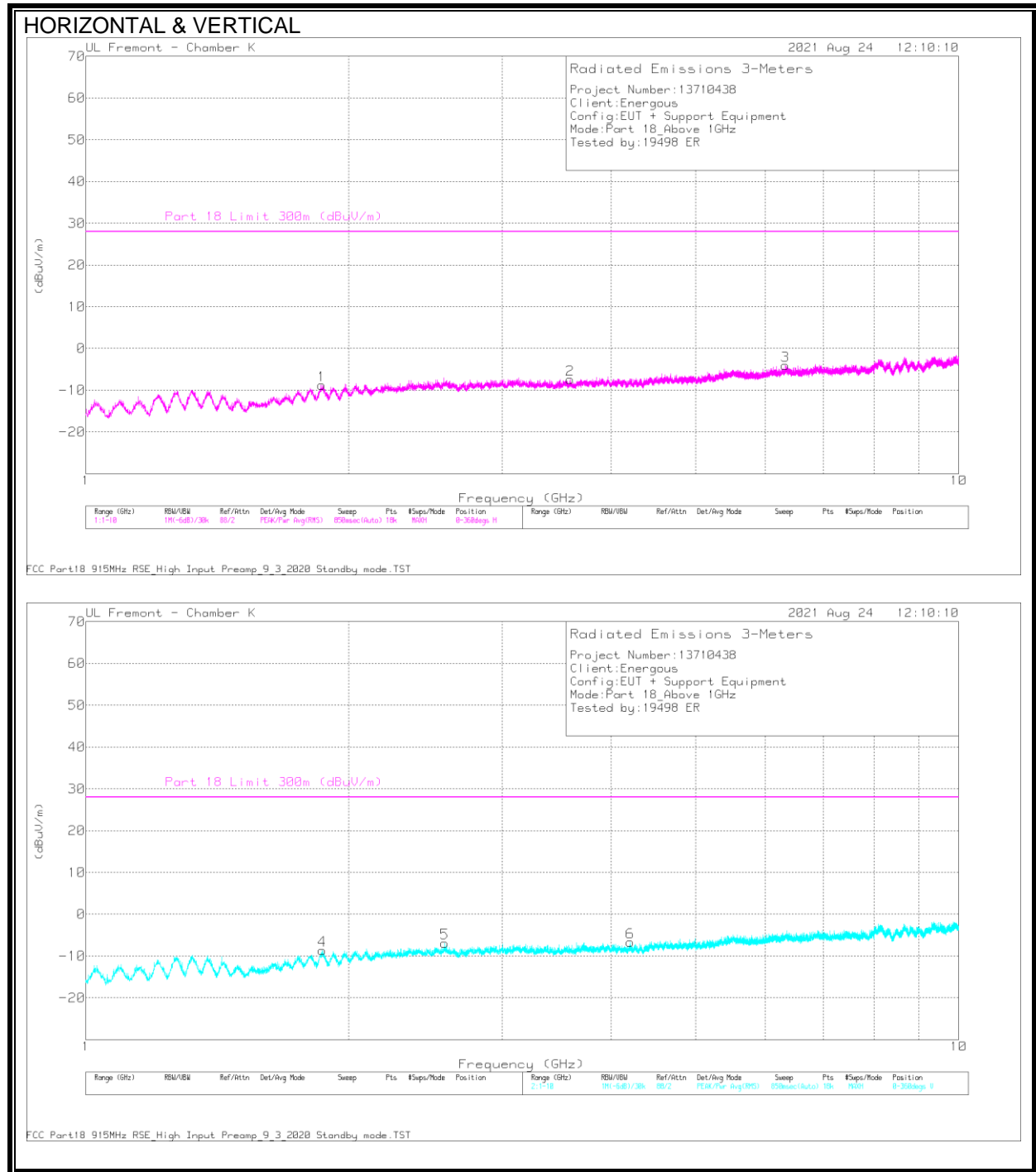

**DATA**

Marker	Frequency (GHz)	Meter Reading (dBuV)	Det	AF T863 (dB/m)	Amp/Cbl (dB)	Dist Corr (dB)	Corrected Reading (dBuV/m)	Part 18 Limit 300m (dBuV/m)	Margin (dB)	Azimuth (Degs)	Height (cm)	Polarity
1	1.86472	45.28	Pk	30.8	-45.8	-40	-9.72	28	-37.72	307	100	H
	1.86472	34.07	RMS	30.8	-45.8	-40	-20.93	28	-48.93	307	100	H
2	3.58732	49.98	Pk	33.2	-41.9	-40	1.28	28	-26.72	287	175	H
	3.58732	37.9	RMS	33.2	-41.9	-40	-10.8	28	-38.8	287	175	H
3	6.329	47.59	Pk	35.8	-38.6	-40	4.79	28	-23.21	157	210	H
	6.329	35.32	RMS	35.8	-38.6	-40	-7.48	28	-35.48	157	210	H
4	1.86495	56.1	Pk	30.8	-45.8	-40	1.1	28	-26.9	87	253	V
	1.86495	43.19	RMS	30.8	-45.8	-40	-11.81	28	-39.81	87	253	V
5	2.57625	52.41	Pk	32.8	-43.8	-40	1.41	28	-26.59	48	100	V
	2.57625	40.42	RMS	32.8	-43.8	-40	-10.58	28	-38.58	48	100	V
6	4.20649	50.32	Pk	33.6	-41.6	-40	2.32	28	-25.68	51	180	V
	4.20649	37.71	RMS	33.6	-41.6	-40	-10.29	28	-38.29	51	180	V

Pk - Peak detector  
 RMS - RMS detection

Note:

- Test was performed @ 3 meter distance.
- Distance factor from 3m to 300m =  $20\log(3/300) = -40\text{dB}$

### 8.3.2. CONFIGURATION 2

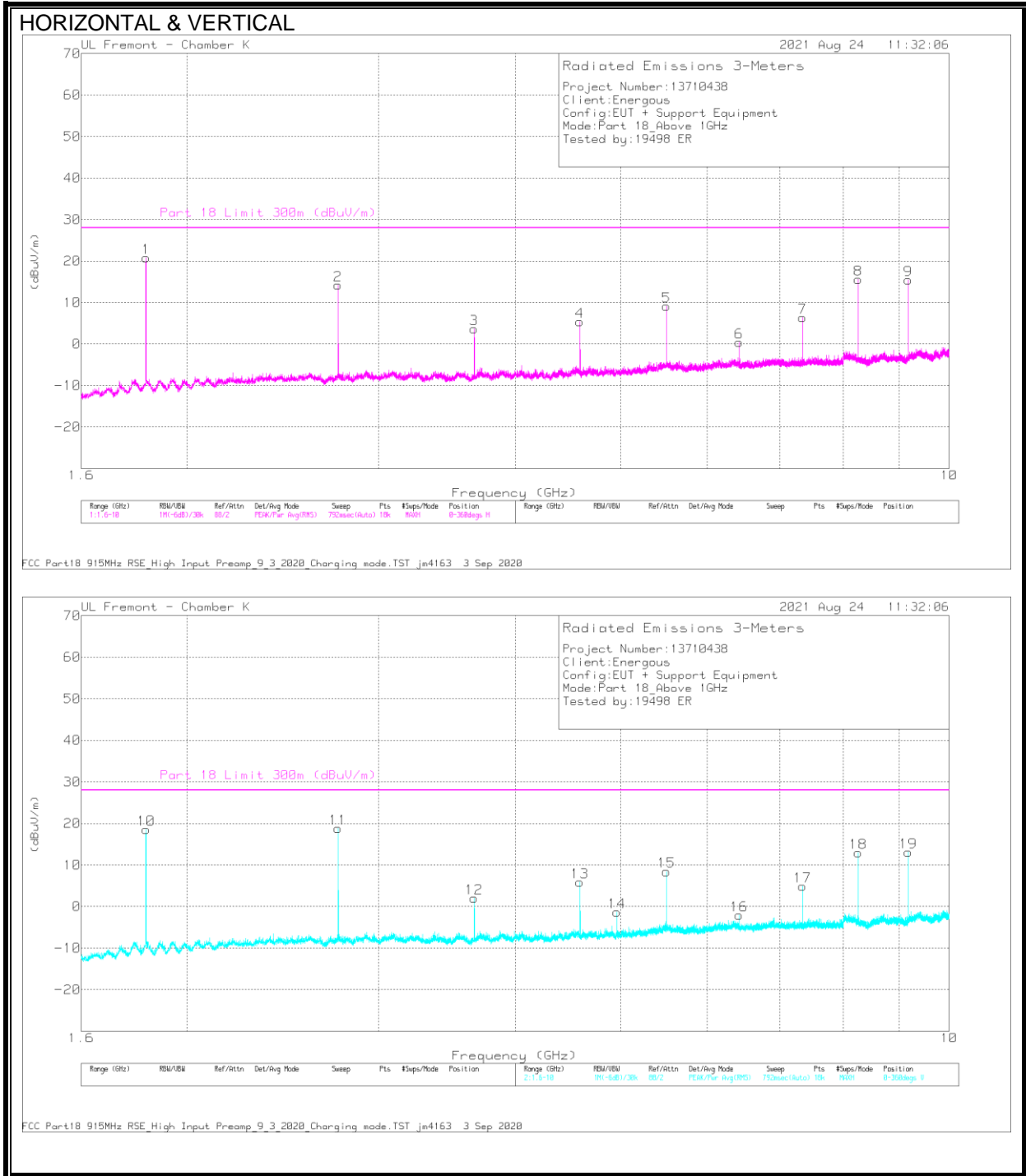

**DATA**

Marker	Frequency (GHz)	Meter Reading (dBuV)	Det	AF T863 (dB/m)	Amp/Cbl (dB)	20478 6 HPF (dB)	Dist Corr (dB)	Corrected Reading (dBuV/m)	Part 18 Limit 300m (dBuV/m)	Margin (dB)	Azimuth (Degs)	Height (cm)	Polarity
1	1.83472	75.23	Pk	30.7	-45.8	.7	-40	20.83	28	-7.17	0-360	100	H
2	2.7526	64.57	Pk	32.5	-43.5	.7	-40	14.27	28	-13.73	0-360	200	H
3	3.67002	51.31	Pk	33.5	-41.9	.7	-40	3.61	28	-24.39	0-360	100	H
4	4.58744	51.83	Pk	34.2	-41.3	.7	-40	5.43	28	-22.57	0-360	200	H
5	5.50485	52.73	Pk	35.7	-40	.7	-40	9.13	28	-18.87	0-360	100	H
6	6.42273	42.88	Pk	35.7	-38.8	.7	-40	.48	28	-27.52	0-360	200	H
7	7.34015	47.59	Pk	36	-37.9	.7	-40	6.39	28	-21.61	0-360	100	H
8	8.25757	55.94	Pk	36.1	-37.2	.7	-40	15.54	28	-12.46	0-360	100	H
9	9.17498	54.72	Pk	36.6	-36.6	.7	-40	15.42	28	-12.58	0-360	200	H
10	1.83472	72.95	Pk	30.7	-45.8	.7	-40	18.55	28	-9.45	0-360	100	V
11	2.75214	69.14	Pk	32.5	-43.5	.7	-40	18.84	28	-9.16	0-360	100	V
12	3.66955	49.83	Pk	33.4	-41.9	.7	-40	2.03	28	-25.97	0-360	100	V
13	4.58744	52.35	Pk	34.2	-41.3	.7	-40	5.95	28	-22.05	0-360	100	V
14	4.96168	44.26	Pk	34.3	-40.6	.7	-40	-1.34	28	-29.34	0-360	100	V
15	5.50485	52.05	Pk	35.7	-40	.7	-40	8.45	28	-19.55	0-360	100	V
16	6.42227	40.36	Pk	35.7	-38.8	.7	-40	-2.04	28	-30.04	0-360	200	V
17	7.34015	46.07	Pk	36	-37.9	.7	-40	4.87	28	-23.13	0-360	100	V
18	8.25757	53.35	Pk	36.1	-37.2	.7	-40	12.95	28	-15.05	0-360	100	V
19	9.17498	52.46	Pk	36.6	-36.6	.7	-40	13.16	28	-14.84	0-360	100	V

**Radiated Emissions**

Marker	Frequency (GHz)	Meter Reading (dBuV)	Det	AF T863 (dB/m)	Amp/Cbl (dB)	20478 6 HPF (dB)	Dist Corr (dB)	Corrected Reading (dBuV/m)	Part 18 Limit 300m (dBuV/m)	Margin (dB)	Azimuth (Degs)	Height (cm)	Polarity
1	1.83495	74.97	RMS	30.7	-45.8	.7	-40	20.57	28	-7.43	151	108	H
2	2.75243	67.36	RMS	32.5	-43.5	.7	-40	17.06	28	-10.94	259	326	H
8	8.25746	56.19	RMS	36.1	-37.2	.7	-40	15.79	28	-12.21	34	181	H
9	9.17505	53.55	RMS	36.6	-36.6	.7	-40	14.25	28	-13.75	71	191	H
10	1.83489	72.61	RMS	30.7	-45.8	.7	-40	18.21	28	-9.79	160	138	V
11	2.75255	71.53	RMS	32.5	-43.5	.7	-40	21.23	28	-6.77	343	131	V

Pk - Peak detector  
 RMS - RMS detection

Note:

- Test was performed @ 3 meter distance.
- Distance factor from 3m to 300m =  $20\log(3/300) = -40\text{dB}$
- Frequency Range 1GHz – 1.6GHz was investigated due to using a 1.5GHz high pass filter. See the following test result of frequency range 1GHz-1.6GHz.

**Spurious Emissions 1GHz – 1.6GHz without a Band Reject Filter, without 1.5 GHz HPF, and without amplifier**

Tested by:	19498 ER
Date:	8/24/2021

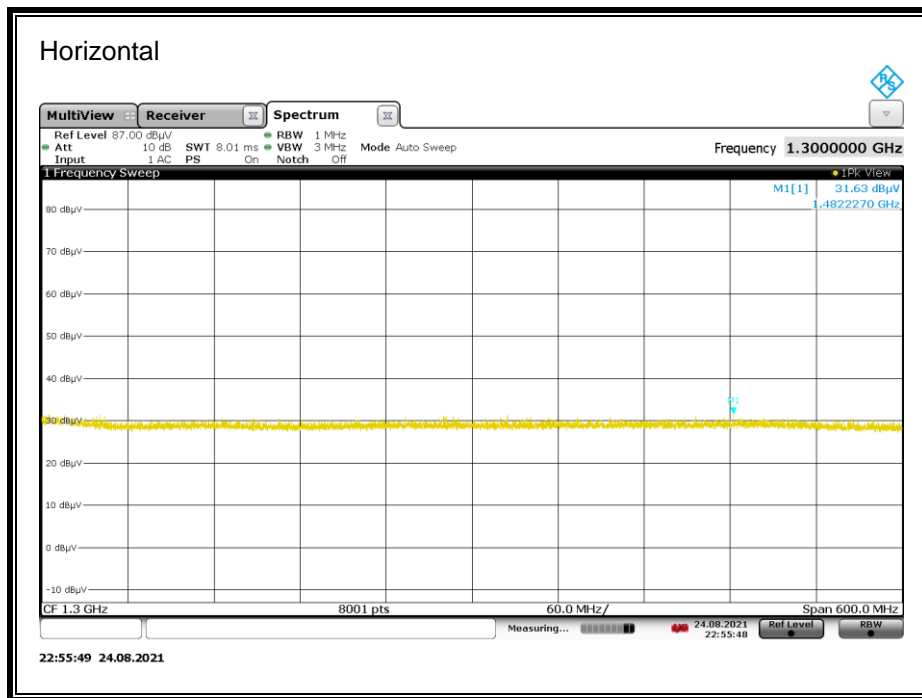

**DATA**

Marker	Frequency (GHz)	Meter Reading (dBuV)	Det	AF T863 (dB/m)	Cable (dB)	Dist Corr (dB)	Corrected Reading (dBuV/m)	FCC PART18 300m LIMIT (dBuV/m)	Margin (dB)	Azimuth (Degs)	Height (cm)	Polarity
1	1.48223	31.63	Pk	27.9	5.6	-40	25.13	-	-	107	166	H
	1.48261	8.41	RMS	27.9	5.6	-40	1.91	28	-26.09	107	166	H

Pk - Peak detector  
 RMS - RMS detection

Note:

- Test was performed @ 3 meter distance.
- Distance factor from 3m to 300m =  $20\log(3/300) = -40\text{dB}$

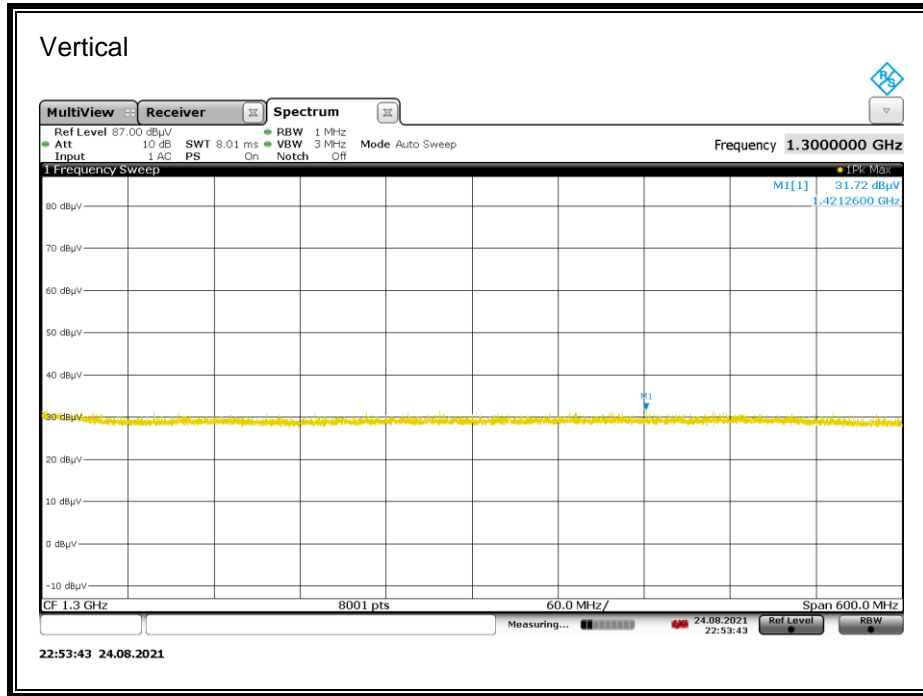

**DATA**

Marker	Frequency (GHz)	Meter Reading (dBuV)	Det	AF T863 (dB/m)	Cable (dB)	Dist Corr (dB)	Corrected Reading (dBuV/m)	FCC PART18 300m LIMIT (dBuV/m)	Margin (dB)	Azimuth (Degs)	Height (cm)	Polarity
1	1.42126	31.72	Pk	28.6	5.5	-40	25.82	-	-	31	124	V
	1.42319	8.22	RMS	28.6	5.5	-40	2.32	28	-25.68	31	124	V

Pk - Peak detector  
 RMS - RMS detection

Note:

- Test was performed @ 3 meter distance.
- Distance factor from 3m to 300m =  $20\log(3/300) = -40\text{dB}$

## 9. AC POWER LINE CONDUCTED EMISSIONS

### LIMITS

§ 18.307 For the following equipment, when designed to be connected to the public utility (AC) power line the radio frequency voltage that is conducted back onto the AC power line on any frequency or frequencies shall not exceed the limits in the following table. Compliance with the provisions of this paragraph shall be based on the measurements of the radio frequency voltage between each power line and ground at the power terminal using a 50  $\mu$ H/50 ohms line impedance stabilization network (LISN).

§ 18.307 (b) All other Part 18 consumer devices:

Frequency of Emission (MHz)	Conducted Limit (dB $\mu$ V)	
	Quasi-peak	Average
0.15-0.5	66 to 56 *	56 to 46 *
0.5-5	56	46
5-30	60	50

\*Decreases with the logarithm of the frequency.

### TEST PROCEDURE

Tested in accordance with FCC / OST MP-5

### RESULTS



## 9.1. CONFIGURATION 1

### LINE 1 RESULTS

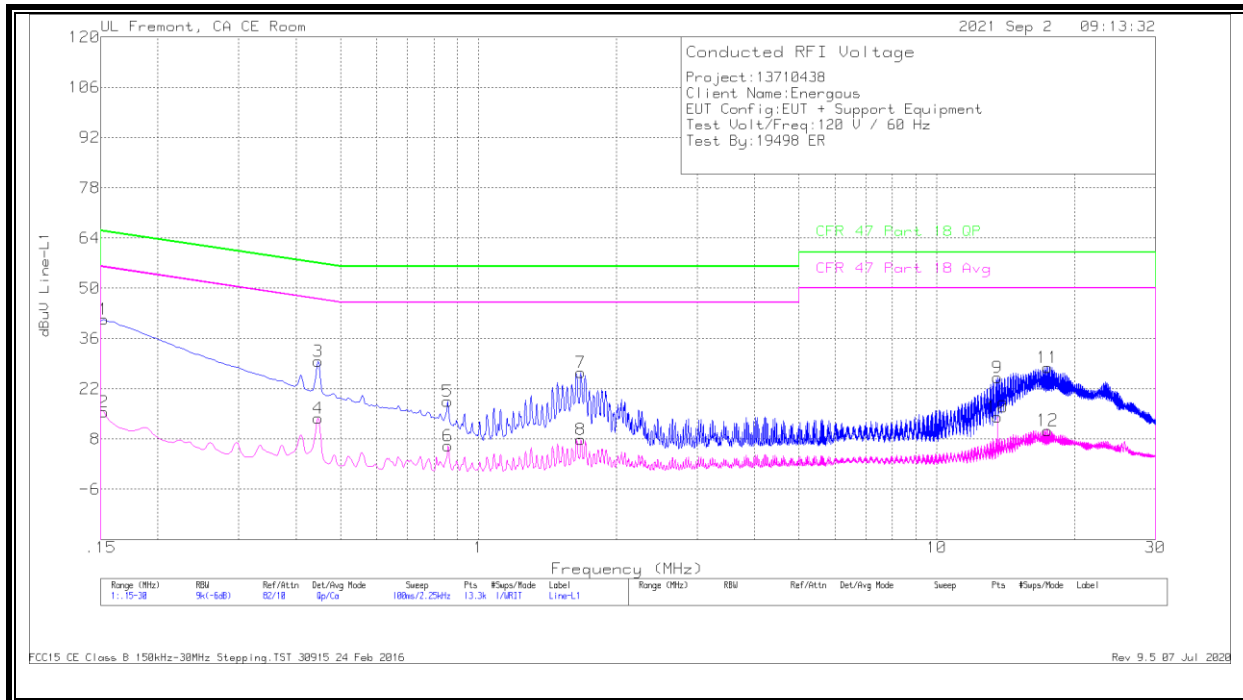

### WORST EMISSIONS

Range 1: Line-L1 .15 - 30MHz											
Marker	Frequency (MHz)	Meter Reading (dBuV)	Det	PRE018644 6 LISN L1	LC Cables C1&C3	Limiter (dB)	Corrected Reading dBuV	CFR 47 Part 18 QP	QP Margin (dB)	CFR 47 Part 18 Avg	Av(CISPR)M argin (dB)
2	.15225	6.11	Ca	.1	0	9.4	15.61	-	-	55.88	-40.27
4	.447	4.55	Ca	0	0	9.3	13.85	-	-	46.93	-33.08
6	.85875	-3.33	Ca	0	.1	9.3	6.07	-	-	46	-39.93
8	1.67325	-1.49	Ca	0	.1	9.3	7.91	-	-	46	-38.09
10	13.56	4.49	Ca	.1	.2	9.3	14.09	-	-	50	-35.91
12	17.46375	.88	Ca	0	.2	9.3	10.38	-	-	50	-39.62
1	.15225	31.85	Qp	.1	0	9.4	41.35	65.88	-24.53	-	-
3	.447	20.33	Qp	0	0	9.3	29.63	56.93	-27.3	-	-
5	.8565	9.02	Qp	0	.1	9.3	18.42	56	-37.58	-	-
7	1.671	17.17	Qp	0	.1	9.3	26.57	56	-29.43	-	-
9	13.56	15.59	Qp	.1	.2	9.3	25.19	60	-34.81	-	-
11	17.46375	18.35	Qp	0	.2	9.3	27.85	60	-32.15	-	-

Qp - Quasi-Peak detector

Ca - CISPR average detection

NOTE: Markers 9 and 10, 13.56MHz is an external NFC signal unrelated to the EUT.

**LINE 2 RESULTS**

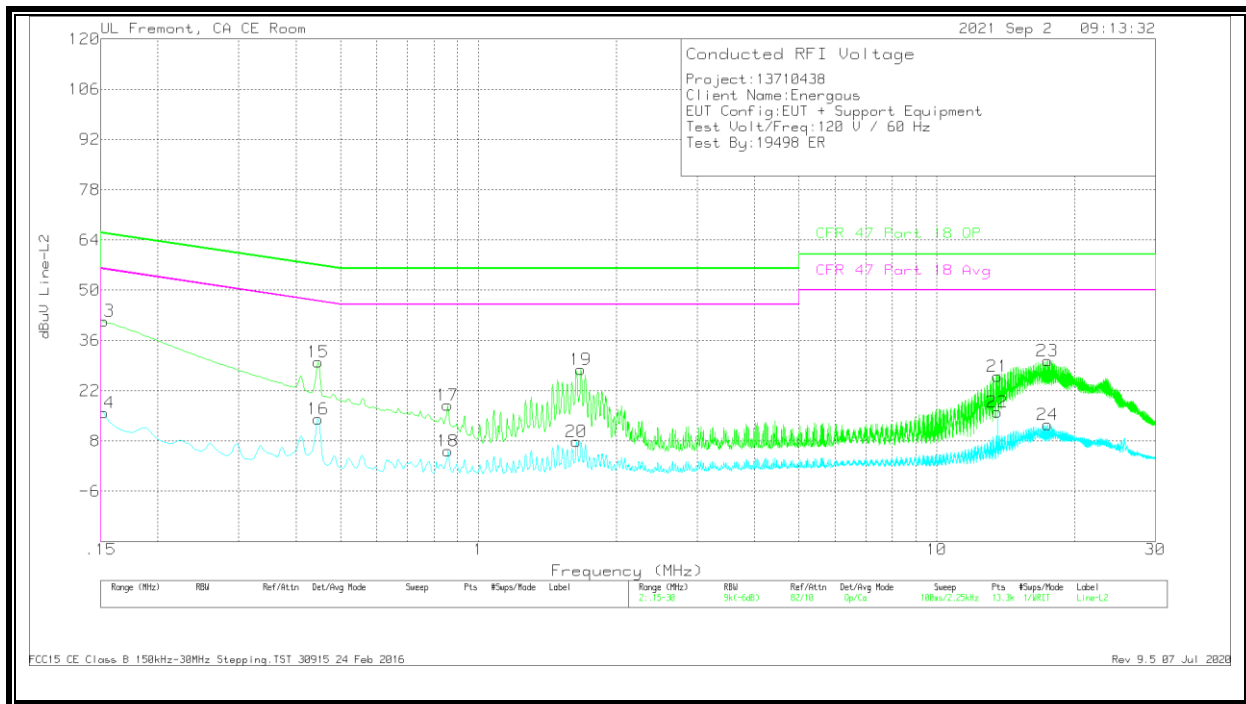

**WORST EMISSIONS**

Range 2: Line-L2 .15 - 30MHz												
Marker	Frequency (MHz)	Meter Reading (dBuV)	Det	PRE018644 6 LISN L2	LC Cables C2&C3	Limiter (dB)	Corrected Reading dBuV	CFR 47 Part 18 QP	QP Margin (dB)	CFR 47 Part 18 Avg	Av(CISPR)Margin (dB)	
14	.15225	6.44	Ca	0	0	9.4	15.84	-	-	55.88	-40.04	
16	.447	4.85	Ca	0	0	9.3	14.15	-	-	46.93	-32.78	
18	.85875	-4.22	Ca	0	.1	9.3	5.18	-	-	46	-40.82	
20	1.63725	-1.47	Ca	0	.1	9.3	7.93	-	-	46	-38.07	
22	13.56	6.53	Ca	.1	.2	9.3	16.13	-	-	50	-33.87	
24	17.43	3.03	Ca	0	.2	9.3	12.53	-	-	50	-37.47	
13	.15225	32.04	Qp	0	0	9.4	41.44	65.88	-24.44	-	-	
15	.447	20.65	Qp	0	0	9.3	29.95	56.93	-26.98	-	-	
17	.8565	8.52	Qp	0	.1	9.3	17.92	56	-38.08	-	-	
19	1.67325	18.59	Qp	0	.1	9.3	27.99	56	-28.01	-	-	
21	13.56	16.42	Qp	.1	.2	9.3	26.02	60	-33.98	-	-	
23	17.42775	20.92	Qp	0	.2	9.3	30.42	60	-29.58	-	-	

Qp - Quasi-Peak detector

Ca - CISPR average detection

NOTE: Markers 21 and 22, 13.56MHz is an external NFC signal unrelated to the EUT.

## 9.2. CONFIGURATION 2

### LINE 1 RESULTS

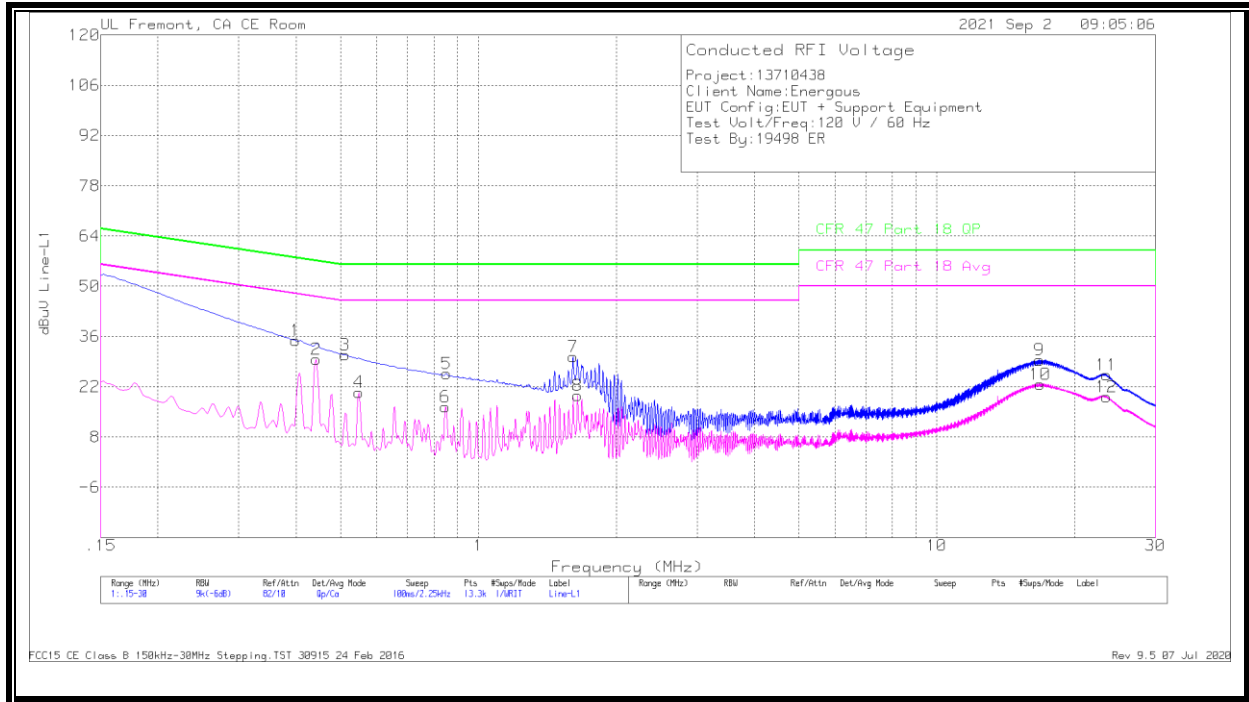

### WORST EMISSIONS

Range 1: Line-L1 .15 - 30MHz											
Marker	Frequency (MHz)	Meter Reading (dBuV)	Det	PRE018644 6 LISN L1	LC Cables C1&C3	Limiter (dB)	Corrected Reading dBuV	CFR 47 Part 18 QP	QP Margin (dB)	CFR 47 Part 18 Avg	Av(CISPR)M argin (dB)
2	.4425	20.32	Ca	0	0	9.3	29.62	-	-	47.01	-17.39
4	.54825	11.2	Ca	0	0	9.3	20.5	-	-	46	-25.5
6	.8475	7.08	Ca	0	.1	9.3	16.48	-	-	46	-29.52
8	1.64625	10.1	Ca	0	.1	9.3	19.5	-	-	46	-26.5
10	16.78425	13.23	Ca	0	.2	9.3	22.73	-	-	50	-27.27
12	23.49825	9.55	Ca	.1	.3	9.3	19.25	-	-	50	-30.75
1	.39975	25.55	Qp	0	0	9.3	34.85	57.86	-23.01	-	-
3	.51225	21.54	Qp	0	0	9.3	30.84	56	-25.16	-	-
5	.852	16.24	Qp	0	.1	9.3	25.64	56	-30.36	-	-
7	1.608	21.02	Qp	0	.1	9.3	30.42	56	-25.58	-	-
9	16.7775	19.91	Qp	0	.2	9.3	29.41	60	-30.59	-	-
11	23.49825	15.57	Qp	.1	.3	9.3	25.27	60	-34.73	-	-

Qp - Quasi-Peak detector  
 Ca - CISPR average detection

**LINE 2 RESULTS**

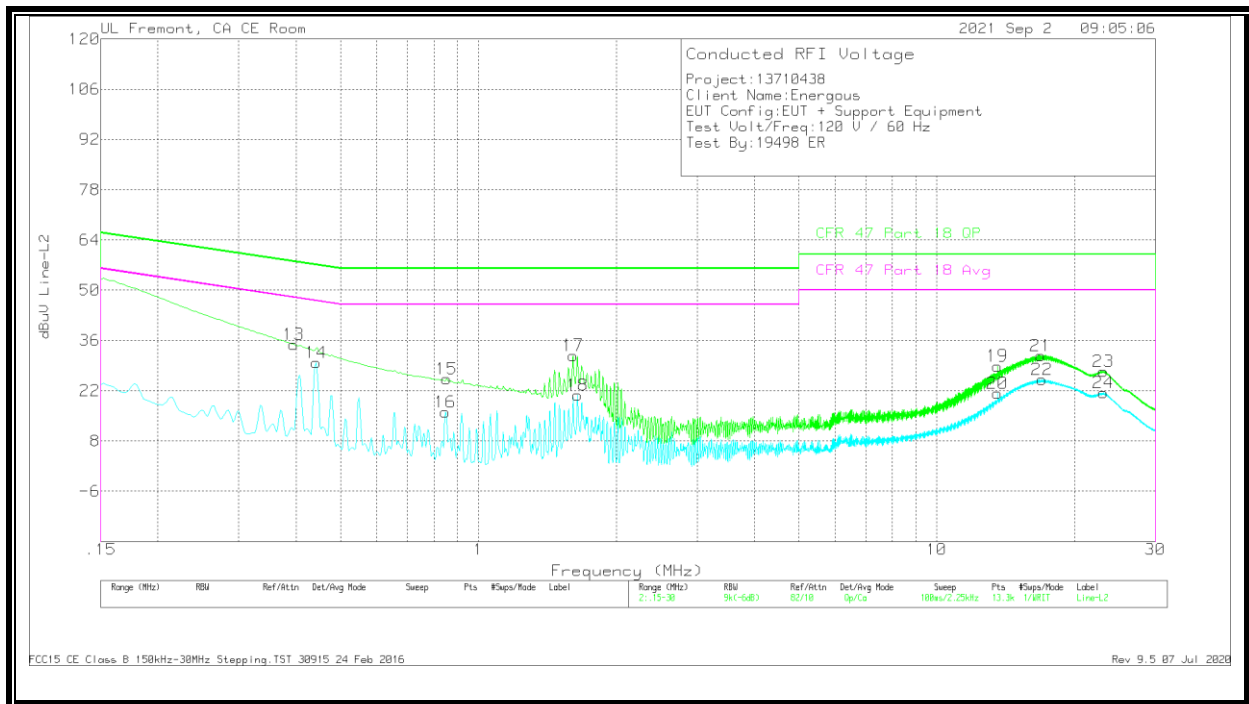

**WORST EMISSIONS**

Range 2: Line-L2 .15 - 30MHz

Marker	Frequency (MHz)	Meter Reading (dBuV)	Det	PRE018644 6 LISN L2	LC Cables C2&C3	Limiter (dB)	Corrected Reading dBuV	CFR 47 Part 18 QP	QP Margin (dB)	CFR 47 Part 18 Avg	Av(CISPR)Margin (dB)
14	.4425	20.53	Ca	0	0	9.3	29.83	-	-	47.01	-17.18
16	.8475	6.73	Ca	0	.1	9.3	16.13	-	-	46	-29.87
18	1.64625	11.42	Ca	0	.1	9.3	20.82	-	-	46	-25.18
20	13.56	11.73	Ca	.1	.2	9.3	21.33	-	-	50	-28.67
22	16.9485	15.58	Ca	0	.2	9.3	25.08	-	-	50	-24.92
24	23.1135	11.73	Ca	.1	.3	9.3	21.43	-	-	50	-28.57
13	.39525	25.59	Qp	0	0	9.3	34.89	57.95	-23.06	-	-
15	.852	15.87	Qp	0	.1	9.3	25.27	56	-30.73	-	-
17	1.608	22.44	Qp	0	.1	9.3	31.84	56	-24.16	-	-
19	13.56	19.28	Qp	.1	.2	9.3	28.88	60	-31.12	-	-
21	16.881	22.22	Qp	0	.2	9.3	31.72	60	-28.28	-	-
23	23.11575	17.69	Qp	.1	.3	9.3	27.39	60	-32.61	-	-

Qp - Quasi-Peak detector  
 Ca - CISPR average detection