



CERTIFICATION TEST REPORT

Report Number. : 12889029-E2V2

Applicant : ENERGOUS CORPORATION
3590 NORTH FIRST STREET
SAN JOSE, CA 95134 U.S.A.

Model : NF-330

FCC ID : 2ADNG-NF330

EUT Description : WIRELESS CHARGER

Test Standard(s) : FCC 47 CFR PART 15 SUBPART C

Date Of Issue:

July 08, 2019

Prepared by:

UL Verification Services Inc.
47173 Benicia Street
Fremont, CA 94538, U.S.A.
TEL: (510) 319-4000
FAX: (510) 661-0888



NVLAP Lab code: 200065-0

Revision History

<u>Rev.</u>	<u>Issue Date</u>	<u>Revisions</u>	<u>Revised By</u>
V1	6/26/2019	Initial Issue	--
V2	7/8/2019	Updated Section 9.3 and Section 11 to address TCB's questions	Tina Chu

TABLE OF CONTENTS

1. ATTESTATION OF TEST RESULTS	5
2. TEST METHODOLOGY	7
3. FACILITIES AND ACCREDITATION	7
4. CALIBRATION AND UNCERTAINTY	8
4.1. MEASURING INSTRUMENT CALIBRATION	8
4.2. SAMPLE CALCULATION	8
4.3. MEASUREMENT UNCERTAINTY.....	8
5. EQUIPMENT UNDER TEST.....	9
5.1. DESCRIPTION OF EUT	9
5.2. MAXIMUM OUTPUT POWER.....	9
5.3. DESCRIPTION OF AVAILABLE ANTENNAS	9
5.4. SOFTWARE AND FIRMWARE.....	9
5.5. WORST-CASE CONFIGURATION AND MODE.....	10
5.6. DESCRIPTION OF TEST SETUP.....	11
6. TEST AND MEASUREMENT EQUIPMENT	14
7. MEASUREMENT METHODS	15
8. ANTENNA PORT TEST RESULTS.....	16
8.1. ON TIME AND DUTY CYCLE.....	16
8.2. 99% BANDWIDTH.....	17
8.3. 6 dB BANDWIDTH.....	18
8.4. OUTPUT POWER.....	19
8.5. AVERAGE POWER.....	20
8.6. POWER SPECTRAL DENSITY	21
8.7. CONDUCTED SPURIOUS EMISSIONS.....	22
9. RADIATED TEST RESULTS.....	24
9.1. LIMITS AND PROCEDURE.....	24
9.2. TRANSMITTER ABOVE 1 GHZ.....	26
9.3. WORST CASE BELOW 30MHZ	36
9.4. WORST CASE BELOW 1 GHZ.....	37
9.5. WORST CASE 18-26 GHZ.....	39

10. AC POWER LINE CONDUCTED EMISSIONS.....41
11. SETUP PHOTOS.....44

1. ATTESTATION OF TEST RESULTS

COMPANY NAME: ENERGOUS CORPORATION
3590 NORTH FIRST STREET
SAN JOSE, CA 95134 U.S.A.

EUT DESCRIPTION: WIRELESS CHARGER

MODEL NUMBER: NF-330

SERIAL NUMBER: R100A (RADIATED); R1016 (CONDUCTED)

DATE TESTED: JUNE 5 – JUNE 06, 2019

APPLICABLE STANDARDS	
STANDARD	TEST RESULTS
CFR 47 Part 15 Subpart C	Complies

UL Verification Services Inc. tested the above equipment in accordance with the requirements set forth in the above standards. The test results show that the equipment tested is capable of demonstrating compliance with the requirements as documented in this report.

The results documented in this report apply only to the tested sample, under the conditions and modes of operation as described herein. It is the manufacturer's responsibility to assure that additional production units of this model are manufactured with identical electrical and mechanical components. All samples tested were in good operating condition throughout the entire test program. Measurement Uncertainties are published for informational purposes only and were not taken into account unless noted otherwise.

This document may not be altered or revised in any way unless done so by UL Verification Services Inc. and all revisions are duly noted in the revisions section. Any alteration of this document not carried out by UL Verification Services Inc. will constitute fraud and shall nullify the document. This report must not be used by the client to claim product certification, approval, or endorsement by NVLAP, NIST, or any agency of the Federal Government.

Approved & Released For
UL Verification Services Inc. By:

Prepared By:

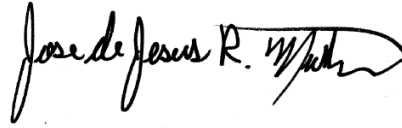

THU CHAN
OPERATIONS LEAD
UL Verification Services Inc.

JOSE MARTINEZ
TEST ENGINEER
UL Verification Services Inc.

Reviewed By:

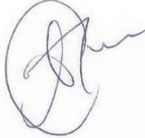

TINA CHU
SENIOR PROJECT ENGINEER
UL Verification Services Inc.

2. TEST METHODOLOGY

The tests documented in this report were performed in accordance with FCC CFR 47 Part 2, FCC CFR 47 Part 15, ANSI C63.10-2013, KDB 558074 D01 15.247 Meas Guidance v05r02.

3. FACILITIES AND ACCREDITATION

The test sites and measurement facilities used to collect data are located at 47173 and 47266 Benicia Street, and 47658 Kato Road, Fremont, California, USA. Line conducted emissions are measured only at the 47173 address. The following table identifies which facilities were utilized for radiated emission measurements documented in this report. Specific facilities are also identified in the test results sections.

47173 Benicia Street	47266 Benicia Street	47658 Kato Road
<input type="checkbox"/> Chamber A	<input type="checkbox"/> Chamber D	<input type="checkbox"/> Chamber I
<input type="checkbox"/> Chamber B	<input type="checkbox"/> Chamber E	<input type="checkbox"/> Chamber J
<input type="checkbox"/> Chamber C	<input type="checkbox"/> Chamber F	<input checked="" type="checkbox"/> Chamber K
	<input type="checkbox"/> Chamber G	<input type="checkbox"/> Chamber L
	<input type="checkbox"/> Chamber H	<input type="checkbox"/> Chamber M

The above test sites and facilities are covered under FCC Test Firm Registration # 208313. Chambers above are covered under Industry Canada company address and respective code: 2324A.

UL Verification Services Inc. is accredited by NVLAP, Laboratory Code 200065-0

4. CALIBRATION AND UNCERTAINTY

4.1. MEASURING INSTRUMENT CALIBRATION

The measuring equipment utilized to perform the tests documented in this report has been calibrated in accordance with the manufacturer's recommendations, and is traceable to recognized national standards.

4.2. SAMPLE CALCULATION

RADIATED EMISSIONS

Where relevant, the following sample calculation is provided:

$$\text{Field Strength (dBuV/m)} = \text{Measured Voltage (dBuV)} + \text{Antenna Factor (dB/m)} + \text{Cable Loss (dB)} - \text{Preamp Gain (dB)}$$

$$36.5 \text{ dBuV} + 18.7 \text{ dB/m} + 0.6 \text{ dB} - 26.9 \text{ dB} = 28.9 \text{ dBuV/m}$$

MAINS CONDUCTED EMISSIONS

Where relevant, the following sample calculation is provided:

$$\text{Final Voltage (dBuV)} = \text{Measured Voltage (dBuV)} + \text{Cable Loss (dB)} + \text{Limiter Factor (dB)} + \text{LISN Insertion Loss.}$$

$$36.5 \text{ dBuV} + 0 \text{ dB} + 10.1 \text{ dB} + 0 \text{ dB} = 46.6 \text{ dBuV}$$

4.3. MEASUREMENT UNCERTAINTY

Where relevant, the following measurement uncertainty levels have been estimated for tests performed on the apparatus:

PARAMETER	UNCERTAINTY
Worst Case Conducted Disturbance, 9KHz to 0.15 MHz	3.84 dB
Worst Case Conducted Disturbance, 0.15 to 30 MHz	3.65 dB
Worst Case Radiated Disturbance, 9KHz to 30 MHz	2.52 dB
Worst Case Radiated Disturbance, 30 to 1000 MHz	4.88 dB
Worst Case Radiated Disturbance, 1000 to 18000 MHz	4.24 dB
Worst Case Radiated Disturbance, 18000 to 26000 MHz	4.37 dB
Worst Case Radiated Disturbance, 26000 to 40000 MHz	5.17 dB

Uncertainty figures are valid to a confidence level of 95%.

5. EQUIPMENT UNDER TEST

5.1. DESCRIPTION OF EUT

The EUT is a RF near-field, contact charger. Wireless power transfer is only transmitting a continuous carrier wave signal at 918 MHz frequency single channel when both receiving devices are placed upon the top surface of the EUT. The charger pad uses BLE to pair with the receiving devices.

This report documents test results of the Bluetooth Low Energy radio portion of the wireless charger.

5.2. MAXIMUM OUTPUT POWER

The transmitter has a maximum peak conducted output power as follows:

Frequency Range (MHz)	Mode	Output Power (dBm)	Output Power (mW)
2402 - 2480	BLE	-1.55	0.70

5.3. DESCRIPTION OF AVAILABLE ANTENNAS

Frequency Band (GHz)	Antenna Peak Gain (dBi)
2.4	2.72

5.4. SOFTWARE AND FIRMWARE

The firmware installed in the EUT during testing was Version: 3.0.1.255
The software installed in the EUT during testing was WattUp app Version: 3.0.52

5.5. WORST-CASE CONFIGURATION AND MODE

Radiated band edge, harmonics, and spurious emissions from 1 GHz to 18GHz were performed with the EUT was set to transmit at the Low/Middle/High channels.

Radiated emission below 30MHz, below 1GHz, above 18GHz, and power line conducted emission were performed with the EUT was set to transmit at the channel with highest output power as worst-case scenario.

The EUT is a tabletop device and it has two ports, one is the USB type C port for power only, second port is for command line interface control, end user will not have access to it. Therefore, all final radiated testing was performed with the EUT in tabletop orientation powered by AC/DC adapter via USB cable.

Worst-case data rate as provided by the client was:
BLE: 1 Mbps.

BLE and WPT bands operate simultaneously, simultaneous operation results are documented in UL document 12889029-E1 WPT report.

5.6. DESCRIPTION OF TEST SETUP

SUPPORT EQUIPMENT

Support Equipment List				
Description	Manufacturer	Model	Serial Number	FCC ID/DoC
EUT AC/DC Adapter	Aukey	PA-Y18	100A	DoC
Laptop	Dell	Latitude E7470	3F94RC2	DoC
Laptop AC/DC adapter	Dell	LA65NM130	CN-03NKWD-72438-38D-0F54-A00	DoC

I/O CABLES (CONDUCTED TEST)

I/O Cable List						
Cable No	Port	# of identical ports	Connector Type	Cable Type	Cable Length (m)	Remarks
1	AC	1	AC	Unshielded	1	AC Mains to AC/DC Adapter
2	DC	1	DC	Unshielded	1.5	AC/DC Adapter to Laptop
3	USB	1	UART	Unshielded	1.5	EUT to Laptop
4	Antenna	1	SMA	Unshielded	0.5	To spectrum analyzer
5	USB	1	USB Type C	Shielded	1	EUT to AC/DC adapter

I/O CABLES (RADIATED TEST / AC POWER CONDUCTED TEST)

I/O Cable List						
Cable No	Port	# of identical ports	Connector Type	Cable Type	Cable Length (m)	Remarks
1	USB	1	USB Type C	shielded	1	EUT to AC/DC adapter

TEST SETUP-CONDUCTED TEST

The EUT was connected to the test laptop via USB cable. Test software exercised the EUT.

SETUP DIAGRAM

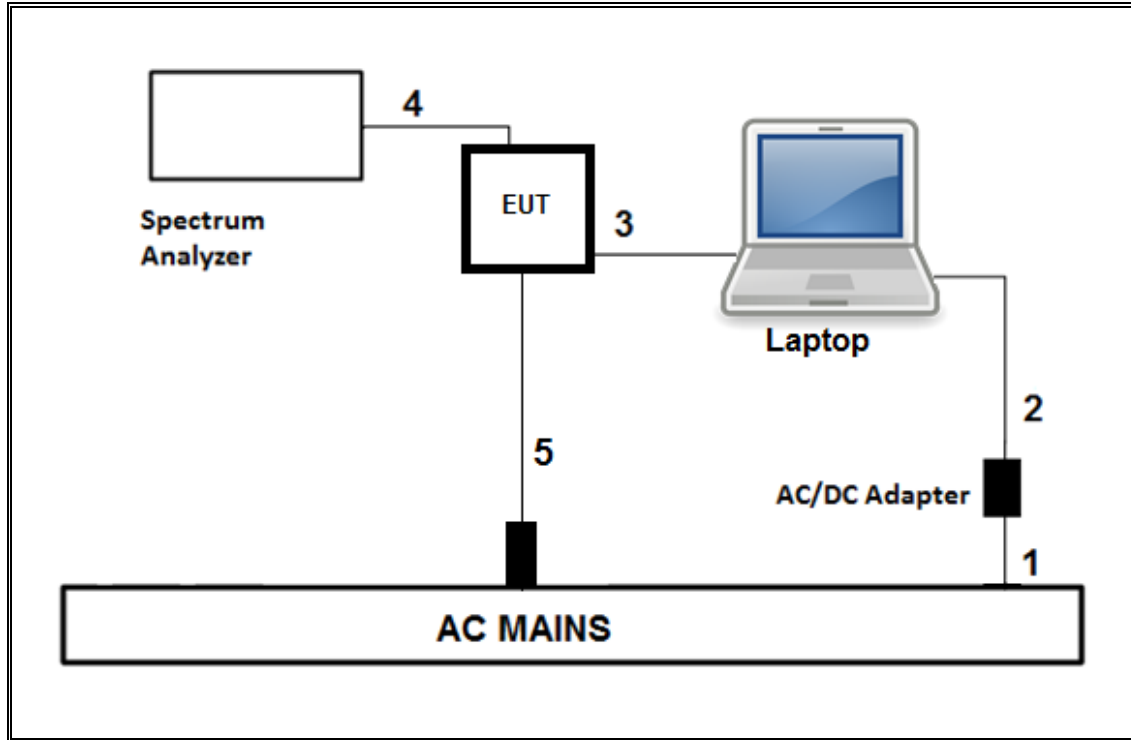

TEST SETUP- RADIATED TEST / AC LINE CONDUCTED TEST

The EUT was powered by an AC/DC adapter via USB cable. Test software exercised the EUT.

SETUP DIAGRAM

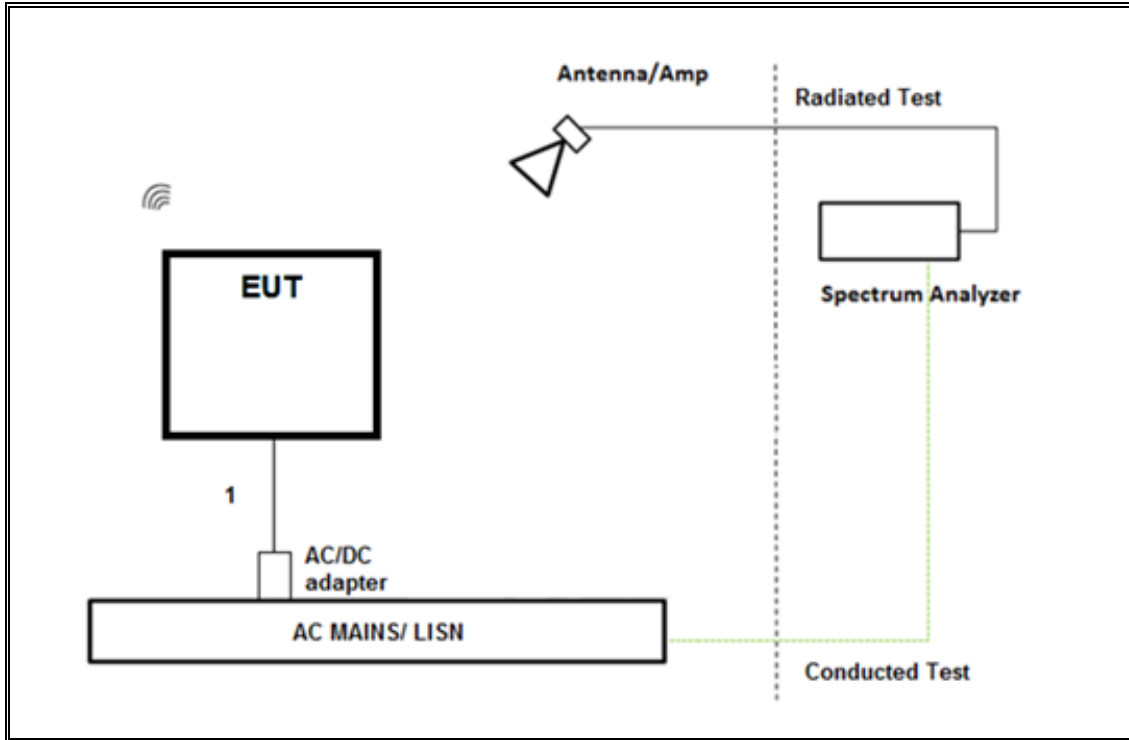

6. TEST AND MEASUREMENT EQUIPMENT

The following test and measurement equipment was utilized for the tests documented in this report:

TEST EQUIPMENT LIST				
Description	Manufacturer	Model	Asset	Cal Due
Antenna, Active Loop 9KHz to 30MHz	COM-POWER	AL-130R	PRE0165308	04/11/2020
EMI TEST RECEIVER	Rohde & Schwarz	ESW44	PRE0179372	02/16/2020
Antenna, Double Ridge Guide Horn Antenna 700MHz to 18GHz	A.H. SYSTEMS, INC.	SAS-571	PRE0190811	07/12/2019
Amplifier, 1 to 18GHz, 35dB	AMPLICAL	AMP1G18-35	T1569	05/04/2020
Antenna, Broadband Hybrid, 30MHz to 3GHz	SunAR rf motion	JB3	PRE0184052	10/24/2019
Amplifier, 100kHz to 1GHz, 32 dB	Agilent (Keysight) Technologies	8447D	PRE0186650	12/13/2019
Antenna, Horn 18 to 26.5GHz	ARA	MWH-1826/B	PRE0182188	08/29/2019
Pre-Amp, 18-26.5GHz	Amplical	AMP18G26.5-60	PRE0181238	05/01/2020
Spectrum Analyzer, PSA, 3Hz to 26.5GHz	Agilent (Keysight) Technologies	E4440A	T200	01/28/2020
Power Meter, P-series single channel	Agilent (Keysight) Technologies	N1911A	T1265	01/29/2020
Power Sensor, P-series, 50MHz to 18GHz, Wideband	Agilent (Keysight) Technologies	N1921A	T1227	02/05/2020
AC Line Conducted				
EMI Receiver	Rohde & Schwarz	ESR	T1436	02/14/2020
LISN for Conducted Emissions CISPR-16	FCC INC.	FCC LISN 50/250	T1310	01/24/2020
Power Cable, Line Conducted Emissions	UL	PR1	T861	10/19/2019
UL AUTOMATION SOFTWARE				
Radiated Software	UL	UL EMC	Ver 9.5, Jun 22, 2018 & Jan 11, 2019	
Antenna Port Software	UL	UL RF	Ver 9.8, May 23, 2019	
AC Line Conducted Software	UL	UL EMC	Ver 9.5, May 26, 2015	

7. MEASUREMENT METHODS

6 dB BW: ANSI C63.10 Subclause -11.8.1

Occupied BW (99%): ANSI C63.10-2013 Section 6.9.3

Output Power: ANSI C63.10 Subclause-11.9.1.3 PKPM1 Peak power meter method

Average Power: ANSI C63.10 Subclause -11.9.2.3.2 Method AVGPM-G (Measurement using a gated RF average-reading power meter)

PSD: ANSI C63.10 Subclause -11.10.2 Method PKPSD (peak PSD)

Radiated emissions non-restricted frequency bands: ANSI C63.10 Subclause -11.11

Radiated emissions restricted frequency bands: ANSI C63.10 Subclause -11.12.1

Conducted emissions in restricted frequency bands: ANSI C63.10 Subclause -11.12.2

Band-edge: ANSI C63.10 Subclause -11.13.3.4 Trace averaging across ON and OFF times of the EUT transmissions followed by duty cycle correction

AC Power Line Conducted Emissions: ANSI C63.10-2013, Section 6.2.

Radiated Spurious Emissions Below 30MHz: ANSI C63.10-2013 Section 6.4

8. ANTENNA PORT TEST RESULTS

8.1. ON TIME AND DUTY CYCLE

LIMITS

None; for reporting purposes only.

PROCEDURE

KDB 558074 Zero-Span Spectrum Analyzer Method.

ON TIME AND DUTY CYCLE RESULTS

Mode	ON Time B (msec)	Period (msec)	Duty Cycle x (linear)	Duty Cycle (%)	Duty Cycle Correction Factor (dB)
2.4GHz Band					
BLE 1Mbps	0.40	0.63	0.633	63.26%	1.99

DUTY CYCLE PLOTS

Tester ID: 10649

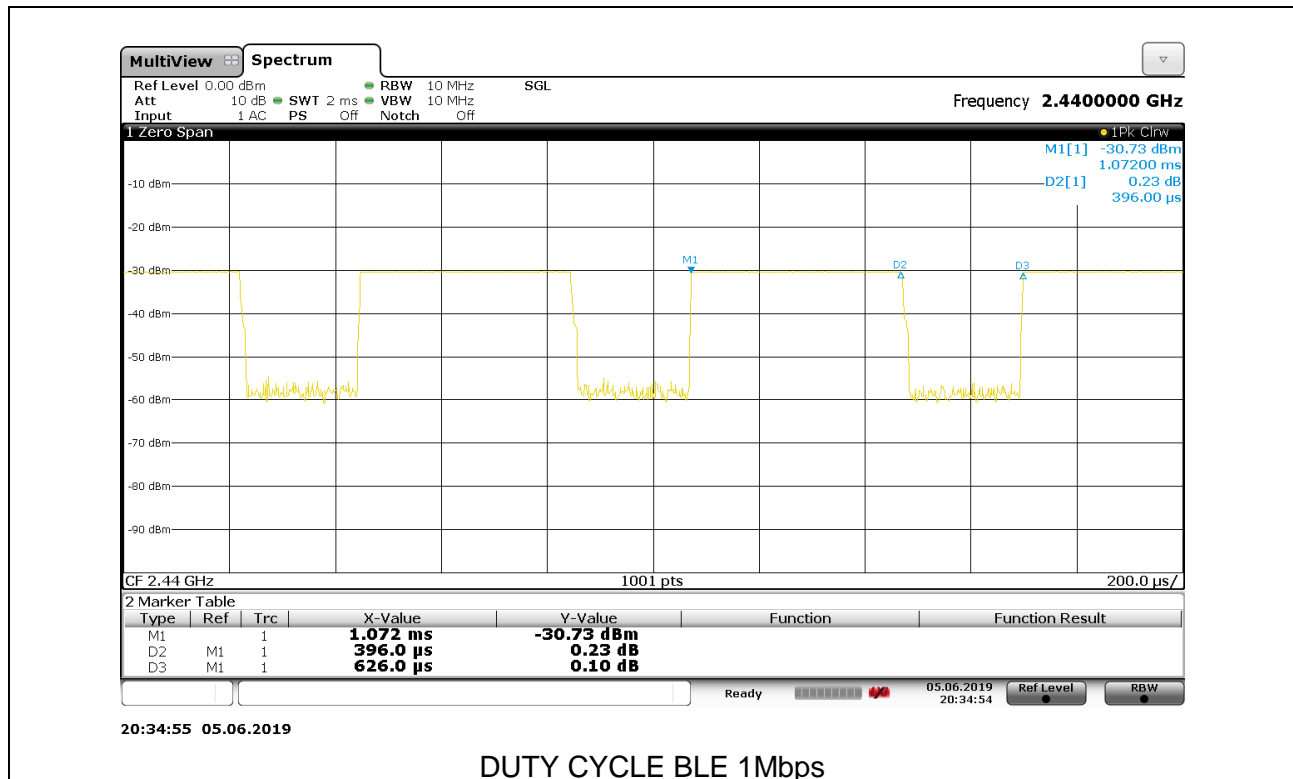

8.2. 99% BANDWIDTH

LIMITS

None; for reporting purposes only.

RESULTS

Channel	Frequency (MHz)	99% Bandwidth (MHz)
Low	2402	1.039
Middle	2440	1.039
High	2480	1.045

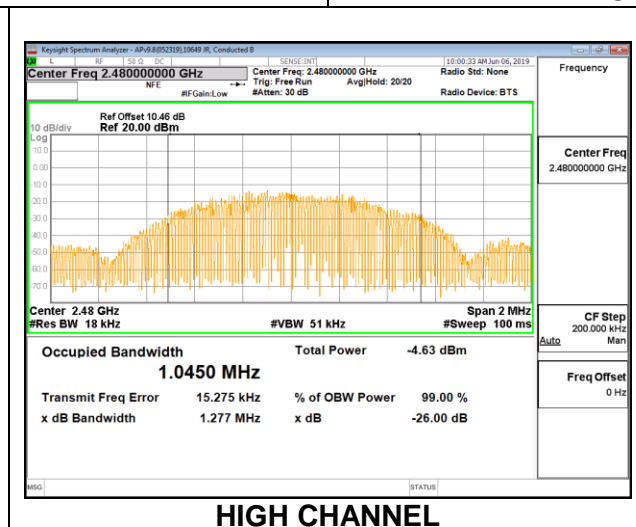
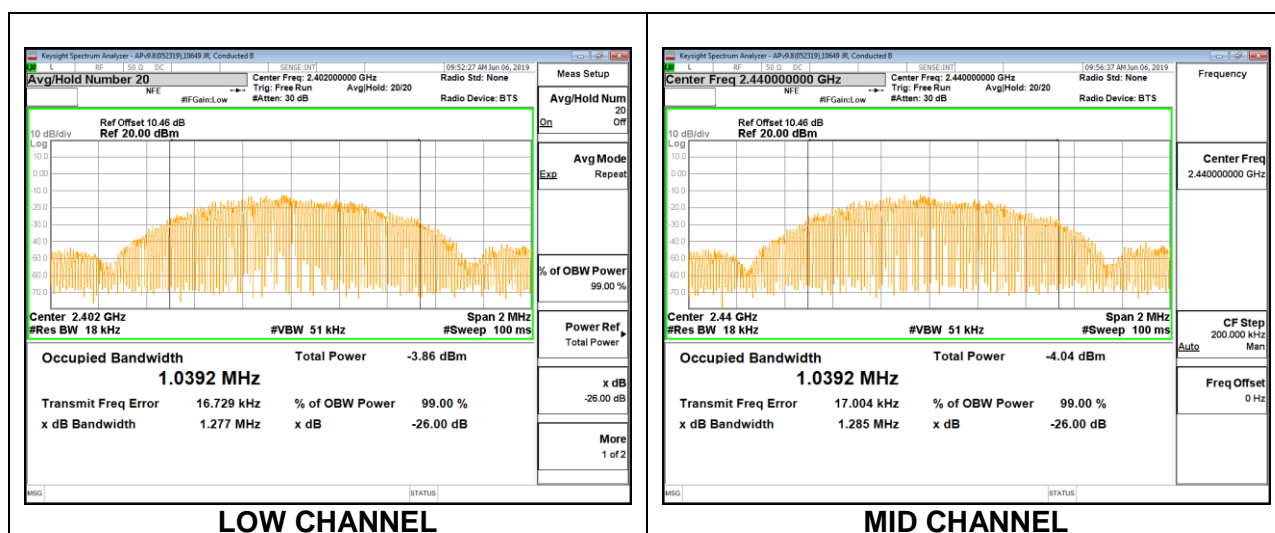

8.3. 6 dB BANDWIDTH

LIMITS

FCC §15.247 (a) (2)

The minimum 6 dB bandwidth shall be at least 500 kHz.

RESULTS

Channel	Frequency (MHz)	6 dB Bandwidth (MHz)	Minimum Limit (MHz)
Low	2402	0.663	0.5
Middle	2440	0.651	0.5
High	2480	0.666	0.5

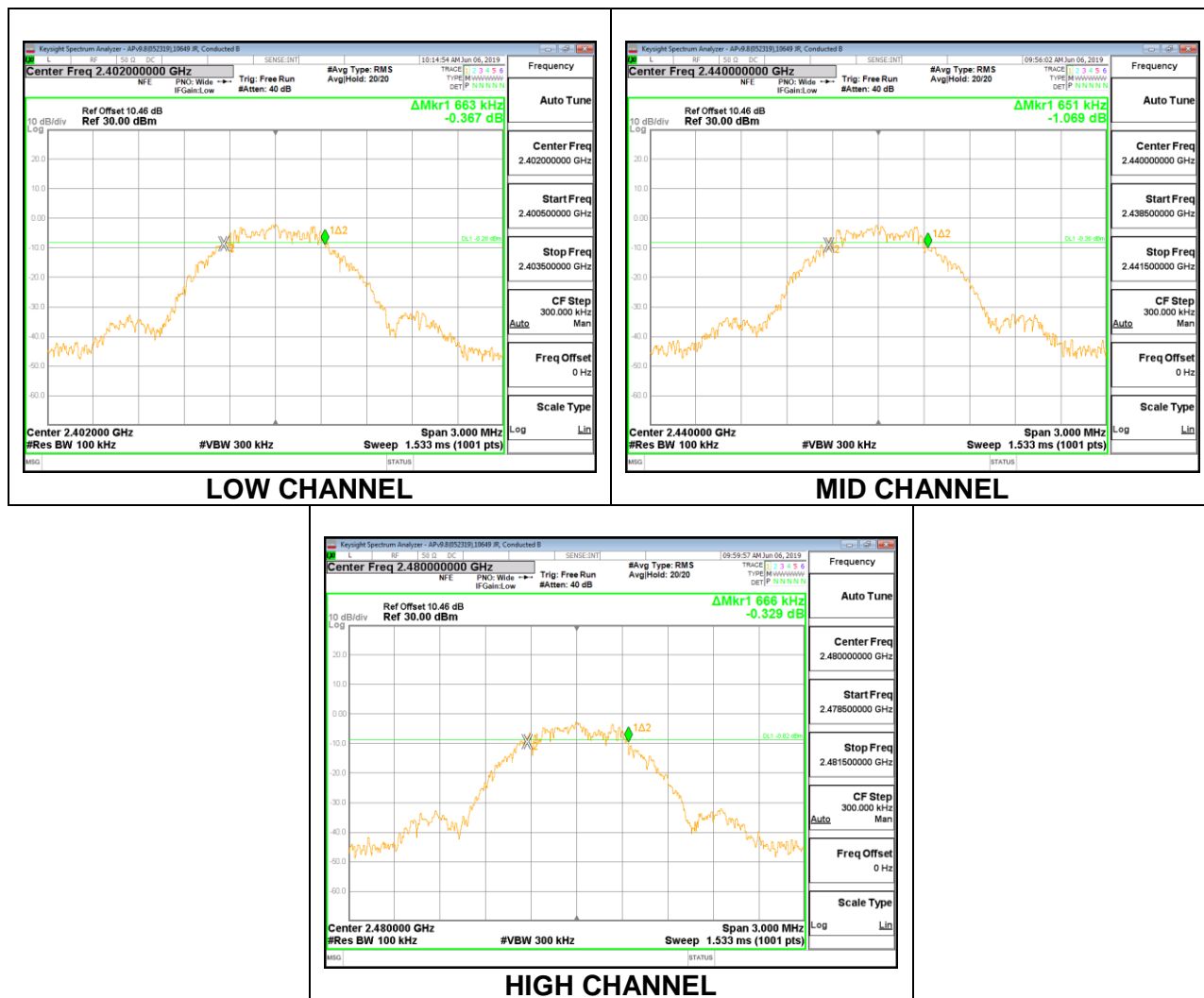

8.4. OUTPUT POWER

LIMITS

FCC §15.247 (b) (3)

The maximum antenna gain is less than or equal to 6 dBi, therefore the limit is 30 dBm.

TEST PROCEDURE

The transmitter output is connected to a power meter.

RESULTS

Tested By:	10649
Date:	6/5/2019

Channel	Frequency (MHz)	Peak Power Reading (dBm)	Limit (dBm)	Margin (dB)
Low	2402	-1.55	30	-31.550
Middle	2440	-1.73	30	-31.730
High	2480	-2.09	30	-32.090

8.5. AVERAGE POWER

LIMITS

None; for reporting purposes only.

TEST PROCEDURE

The transmitter output is connected to a power meter.

RESULTS

Tested By:	10649
Date:	6/5/2019

Channel	Frequency (MHz)	AV power (dBm)
Low	2402	-1.87
Middle	2440	-2.08
High	2480	-2.46

8.6. POWER SPECTRAL DENSITY

LIMITS

FCC §15.247 (e)

The power spectral density conducted from the transmitter to the antenna shall not be greater than 8 dBm in any 3 kHz band during any time interval of continuous transmission.

RESULTS

Channel	Frequency (MHz)	PSD (dBm/3kHz)	Limit (dBm/3kHz)	Margin (dB)
Low	2402	-16.31	8	-24.31
Middle	2440	-16.60	8	-24.60
High	2480	-17.46	8	-25.46

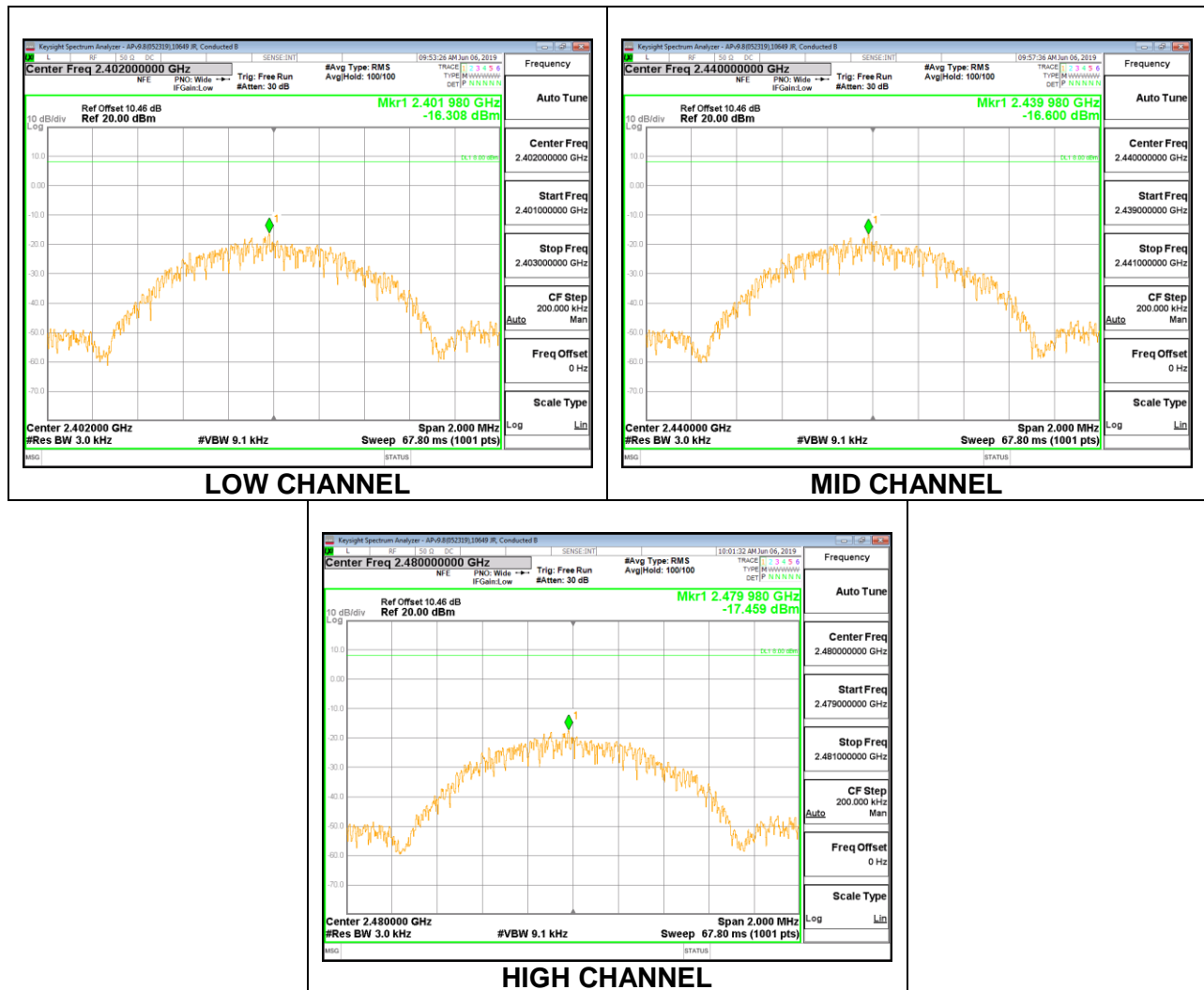

8.7. CONDUCTED SPURIOUS EMISSIONS

LIMITS

FCC §15.247 (d)

Output power was measured based on the use of a peak measurement, therefore the required attenuation is 20 dB.

RESULTS

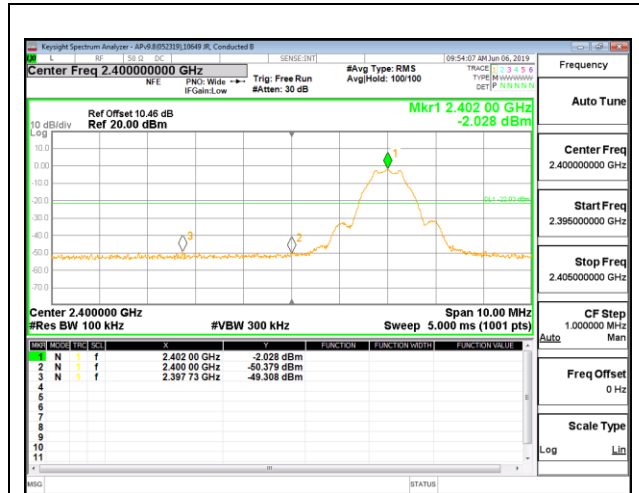

LOW CHANNEL BANDEDGE

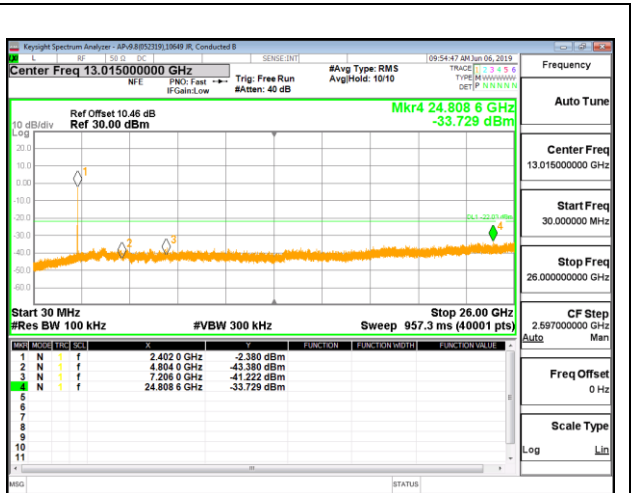

OUT-OF-BAND LOW CHANNEL

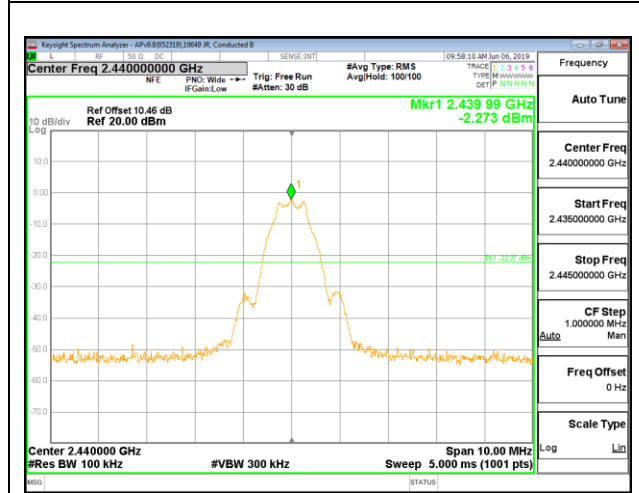

IN-BAND REFERENCE LEVEL

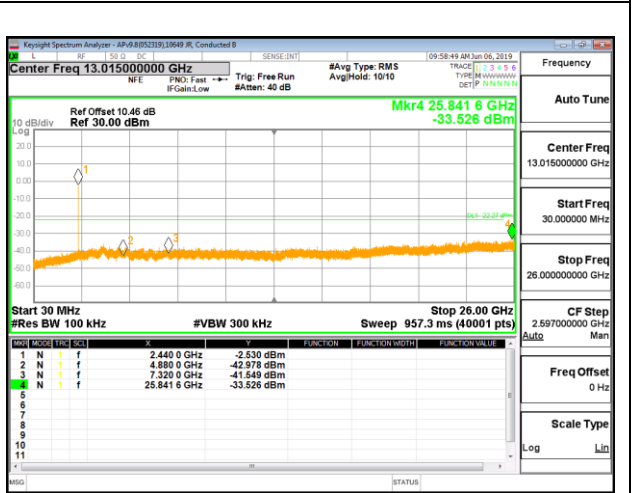

OUT-OF-BAND MID CHANNEL

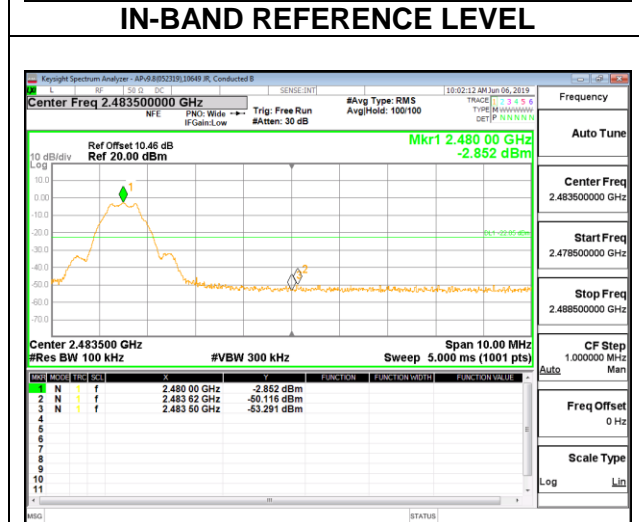

HIGH CHANNEL BANDEDGE

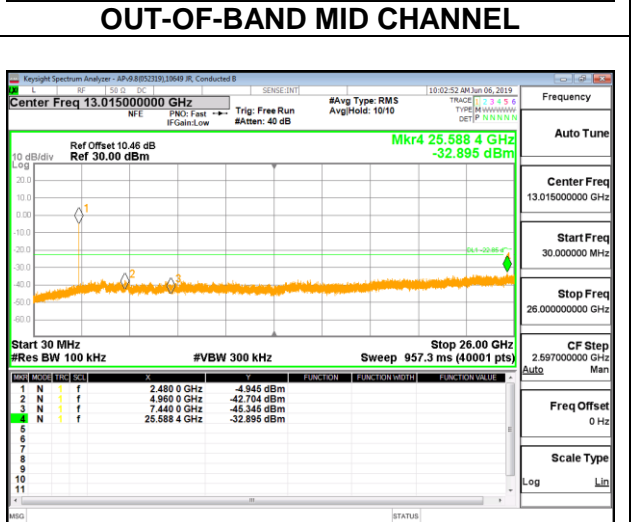

OUT-OF-BAND HIGH CHANNEL

9. RADIATED TEST RESULTS

9.1. LIMITS AND PROCEDURE

LIMITS

FCC §15.205 and §15.209

RSS-GEN, Section 8.9 and 8.10.

Frequency Range (MHz)	Field Strength Limit (uV/m) at 3 m	Field Strength Limit (dBuV/m) at 3 m
0.009-0.490	2400/F(kHz) @ 300 m	-
0.490-1.705	24000/F(kHz) @ 30 m	-
1.705 - 30	30 @ 30m	-
30 - 88	100	40
88 - 216	150	43.5
216 - 960	200	46
Above 960	500	54

TEST PROCEDURE

Tested in accordance with ANSI C63.10-2013

The EUT is placed on a non-conducting table 80 cm above the ground plane for measurement below 1GHz; 1.5 m above the ground plane for measurement above 1GHz. The antenna to EUT distance is 3 meters. The EUT is configured in accordance with ANSI C63.10. The EUT is set to transmit in a continuous mode.

For measurements below 1 GHz the resolution bandwidth is set to 100 kHz for peak detection measurements or 120 kHz for quasi-peak detection measurements. Peak detection is used unless otherwise noted as quasi-peak.

For pre-scans above 1 GHz the resolution bandwidth is set to 1 MHz; the video bandwidth is set to 30 KHz for peak measurements.

For final measurements above 1 GHz the resolution bandwidth is set to 1 MHz; the video bandwidth is set to 3 MHz for peak measurements and as applicable for average measurements.

The spectrum from 1 GHz to 18 GHz is investigated with the transmitter set to the lowest, middle, and highest channels in each applicable band. Below 1GHz and above 18GHz emissions, the channel with the highest output power was tested.

The frequency range of interest is monitored at a fixed antenna height and EUT azimuth. The EUT is rotated through 360 degrees to maximize emissions received. The antenna is scanned from 1 to 4 meters above the ground plane to further maximize the emission. Measurements are made with the antenna polarized in both the vertical and the horizontal positions.

For below 30MHz testing, investigation was done on three antenna orientations (parallel, perpendicular, and ground-parallel), parallel and perpendicular are the worst orientations, therefore final testing was performed on these two orientations only.

KDB 414788 Open Field Site(OFS) and Chamber Correlation Justification

Base on FCC 15.31 (f) (2): measurements may be performed at a distance closer than that specified in the regulations; however, an attempt should be made to avoid making measurements in the near field.

OFS and chamber correlation testing had been performed and chamber measured test result is the worst case test result.

9.2. TRANSMITTER ABOVE 1 GHz

BANDEDGE (LOW CHANNEL)

HORIZONTAL RESULT

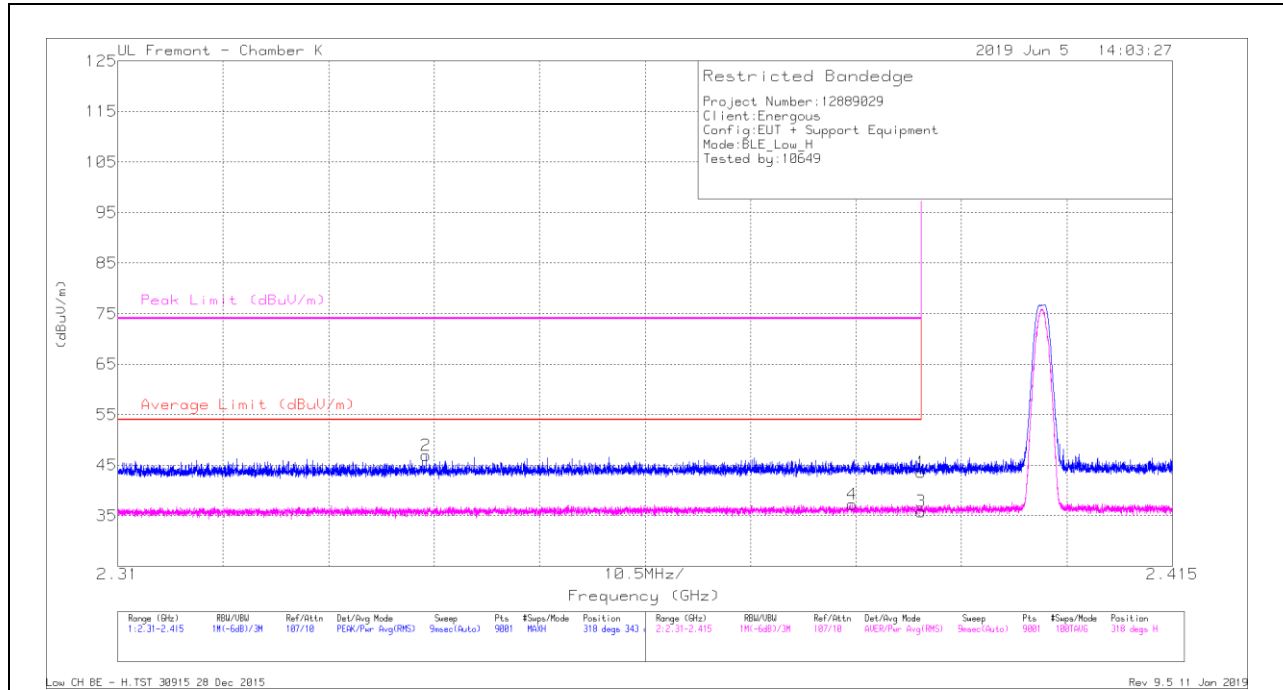

Marker	Frequency (GHz)	Meter Reading (dBu)	Det	AF PRE0190811 (dBm)	Amp/Cb/Fltr/Pad (dB)	DC Corr (dB)	Corrected Reading (dBuV/m)	Average Limit (dBuV/m)	Margin (dB)	Peak Limit (dBuV/m)	PK Margin (dB)	Azimuth (Degs)	Height (cm)	Polarity
1	* 2.39	40.19	Pk	28.1	-24.7	0	43.59	-	-	74	-30.41	318	343	H
2	* 2.341	43.89	Pk	27.7	-24.7	0	46.89	-	-	74	-27.11	318	343	H
3	* 2.39	30.44	RMS	28.1	-24.7	1.99	35.83	54	-18.17	-	-	318	343	H
4	* 2.383	32	RMS	28	-24.7	1.99	37.29	54	-16.71	-	-	318	343	H

* - indicates frequency in CFR47 Pt 15 / IC RSS-Restricted Band
 Pk - Peak detector
 RMS - RMS detection

VERTICAL RESULT

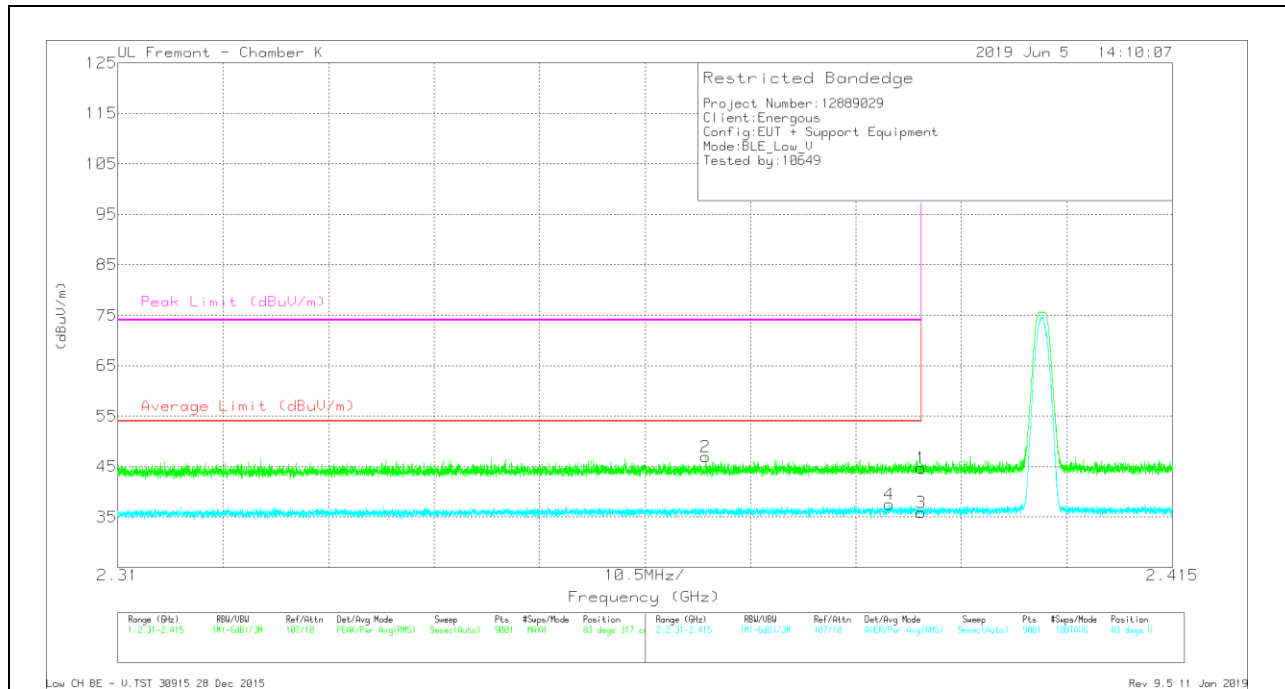

Marker	Frequency (GHz)	Meter Reading (dBuV)	Det	AF PRE0190811 (dB/m)	Amp/CDF/Fltr/Pad (dB)	DC Corr (dB)	Corrected Reading (dBuV/m)	Average Limit (dBuV/m)	Margin (dB)	Peak Limit (dBuV/m)	PK Margin (dB)	Azimuth (Degs)	Height (cm)	Polarity
1	* 2.39	41.31	Pk	28.1	-24.7	0	44.71	-	-	74	-29.29	83	317	V
2	* 2.369	43.69	Pk	27.9	-24.6	0	46.99	-	-	74	-27.01	83	317	V
3	* 2.39	30.52	RMS	28.1	-24.7	1.99	35.91	54	-18.09	-	-	83	317	V
4	* 2.387	32.02	RMS	28.1	-24.6	1.99	37.51	54	-16.49	-	-	83	317	V

* - indicates frequency in CFR47 Pt 15 / IC RSS-Restricted Band
 Pk - Peak detector
 RMS - RMS detection

BANDEDGE (HIGH CHANNEL)

HORIZONTAL RESULT

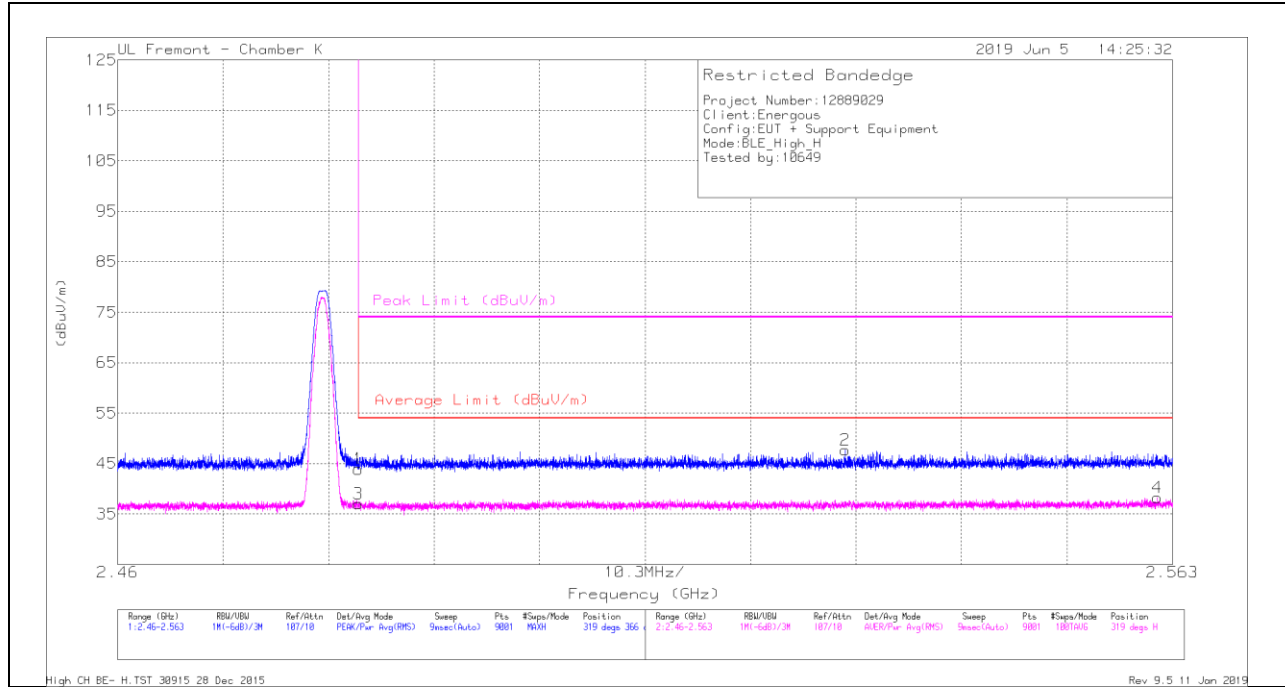

Marker	Frequency (GHz)	Meter Reading (dBuV)	Det	AF PREB190811 (dBm)	Amp/Cb/Filtr/Pad (dB)	DC Corr (dB)	Corrected Reading (dBuV/m)	Average Limit (dBuV/m)	Margin (dB)	Peak Limit (dBuV/m)	PK Margin (dB)	Azimuth (Degs)	Height (cm)	Polarity
1	* 2.484	40.2	Pk	28.5	-24.8	0	43.9	-	-	74	-30.1	319	366	H
2	2.531	43.64	Pk	28.8	-24.7	0	47.74	-	-	74	-26.26	319	366	H
3	* 2.484	31.37	RMS	28.5	-24.8	1.99	37.06	54	-16.94	-	-	319	366	H
4	2.562	32.12	RMS	28.9	-24.8	1.99	38.21	54	-15.79	-	-	319	366	H

* - indicates frequency in CFR47 Pt 15 / IC RSS-Restricted Band
 Pk - Peak detector
 RMS - RMS detection

VERTICAL RESULT

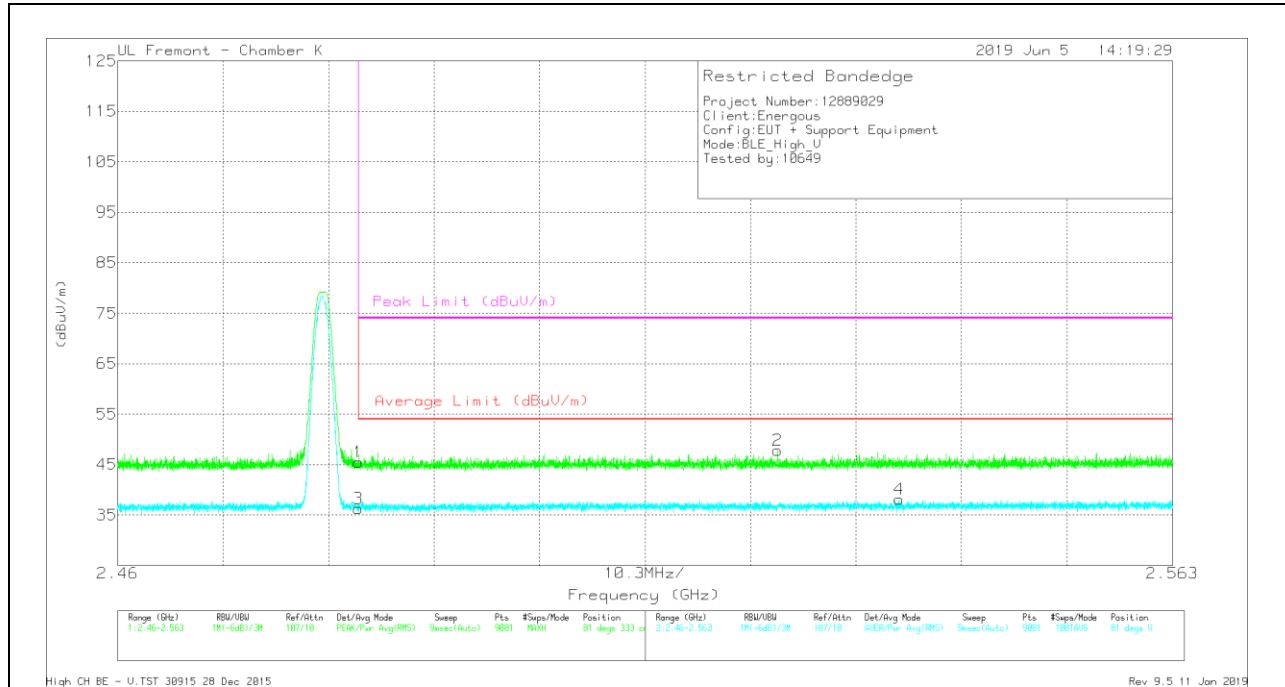

Marker	Frequency (GHz)	Meter Reading (dBuV)	Det	AF PRE0190811 (dBm)	Amp/CDF/Filter/Pad (dB)	DC Corr (dB)	Corrected Reading (dBuV/m)	Average Limit (dBuV/m)	Margin (dB)	Peak Limit (dBuV/m)	PK Margin (dB)	Azimuth (Degs)	Height (cm)	Polarity
1	* 2.484	41.73	Pk	28.5	-24.8	0	45.43	-	-	74	-28.57	81	333	V
2	2.524	43.8	Pk	28.8	-24.8	0	47.8	-	-	74	-26.2	81	333	V
3	* 2.484	30.6	RMS	28.5	-24.8	1.99	36.29	54	-17.71	-	-	81	333	V
4	2.536	32.08	RMS	28.8	-24.8	1.99	38.07	54	-15.93	-	-	81	333	V

* - indicates frequency in CFR47 Pt 15 / IC RSS-Restricted Band
 Pk - Peak detector
 RMS - RMS detection

HARMONICS AND SPURIOUS EMISSIONS

LOW CHANNEL RESULTS

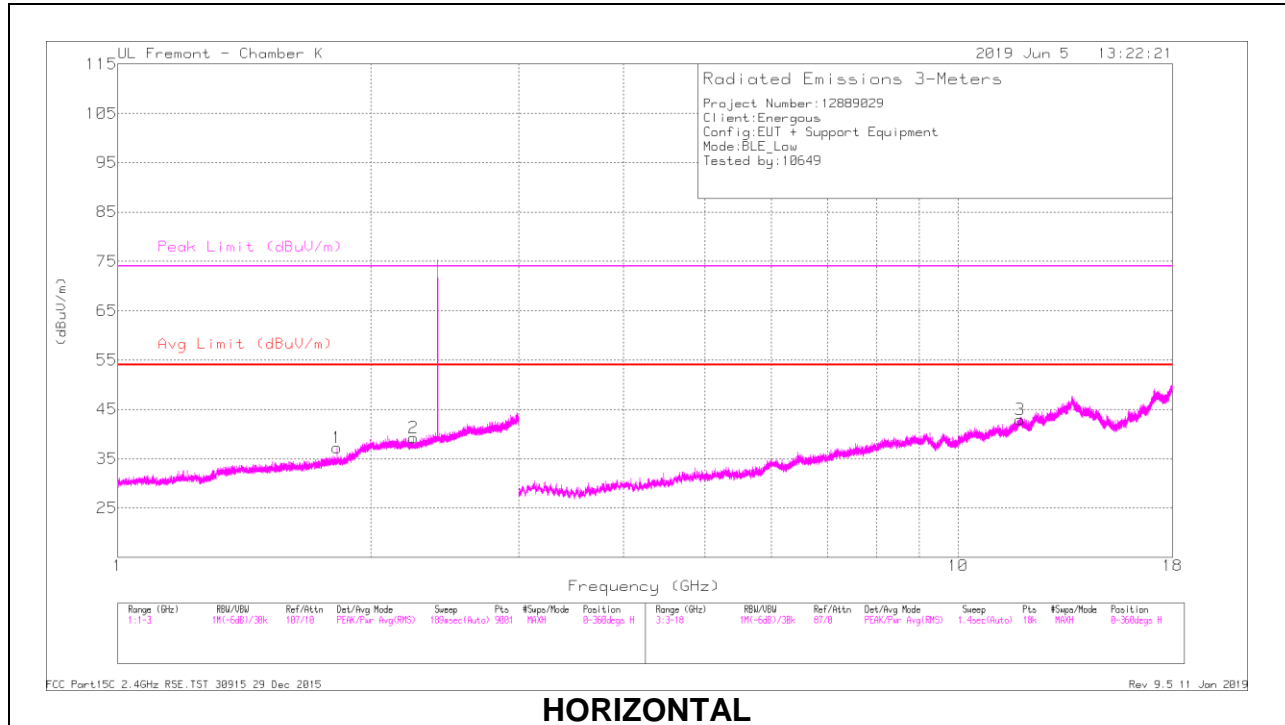

HORIZONTAL

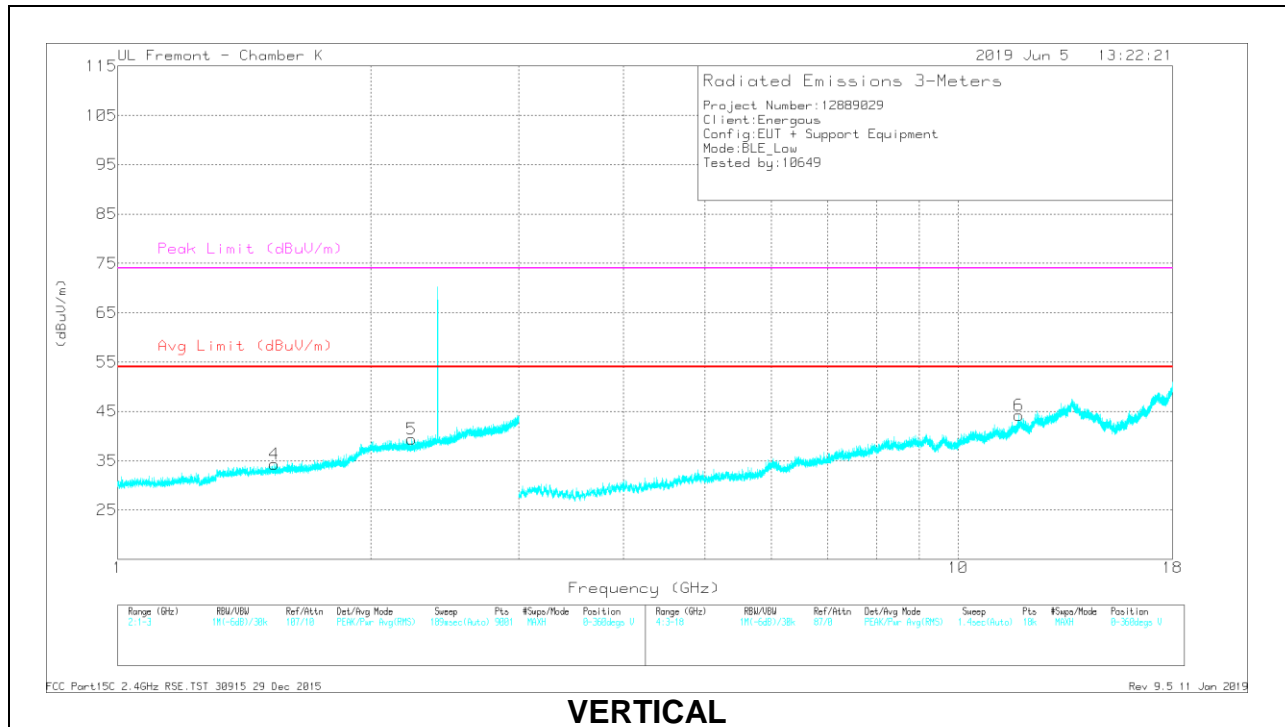

VERTICAL

RADIATED EMISSIONS

Marker	Frequency (GHz)	Meter Reading (dBuV)	Det	AF PRE0190811 (dB/m)	Amp/Cb/ Filt/Pad (dB)	DC Corr (dB)	Corrected Reading (dBuV/m)	Avg Limit (dBuV/m)	Margin (dB)	Peak Limit (dBuV/m)	PK Margin (dB)	Azimuth (Degs)	Height (cm)	Polarity
1	1.826	32	PK2	25.7	-15.6	0	42.1	-	-	-	-	321	277	H
2	* 2.249	33.09	PK2	27.3	-14.7	0	45.69	-	-	74	-28.31	168	101	H
	* 2.252	22.97	MAv1	27.3	-14.7	1.99	37.56	54	-16.44	-	-	168	101	H
4	* 1.536	32.75	PK2	24.7	-16.4	0	41.05	-	-	74	-32.95	203	186	V
	* 1.536	22.69	MAv1	24.7	-16.4	1.99	32.98	54	-21.02	-	-	203	186	V
5	* 2.237	32.63	PK2	27.3	-14.7	0	45.23	-	-	74	-28.77	236	245	V
	* 2.237	22.84	MAv1	27.3	-14.7	1.99	37.43	54	-16.57	-	-	236	245	V
3	* 11.865	29.6	PK2	40	-19.8	0	49.8	-	-	74	-24.2	309	170	H
	* 11.867	20.3	MAv1	40	-19.8	1.99	42.49	54	-11.51	-	-	309	170	H
6	* 11.809	29.83	PK2	39.9	-19.6	0	50.13	-	-	74	-23.87	142	347	V
	* 11.807	20.12	MAv1	39.9	-19.6	1.99	42.41	54	-11.59	-	-	142	347	V

* - indicates frequency in CFR47 Pt 15 / IC RSS-Restricted Band

PK2 - KDB558074 Method: Maximum Peak

MAv1 - KDB558074 Option 1 Maximum RMS Average

MID CHANNEL RESULTS

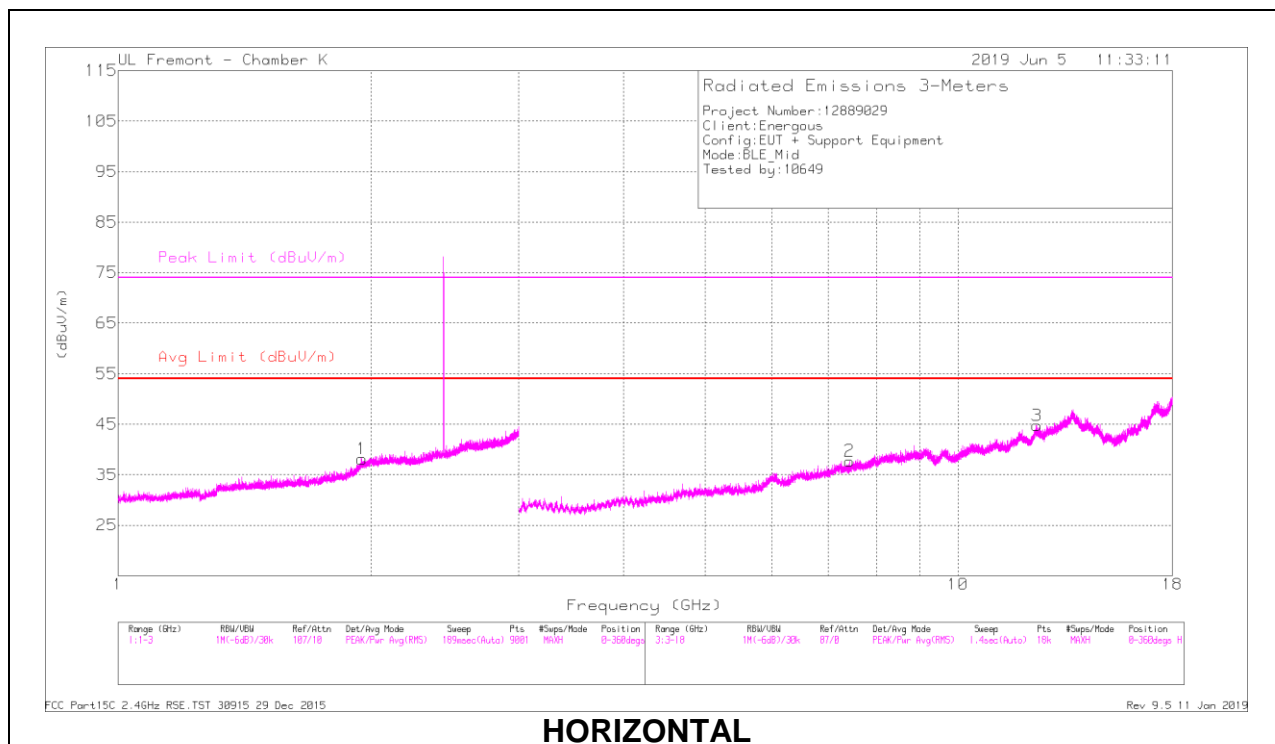

HORIZONTAL

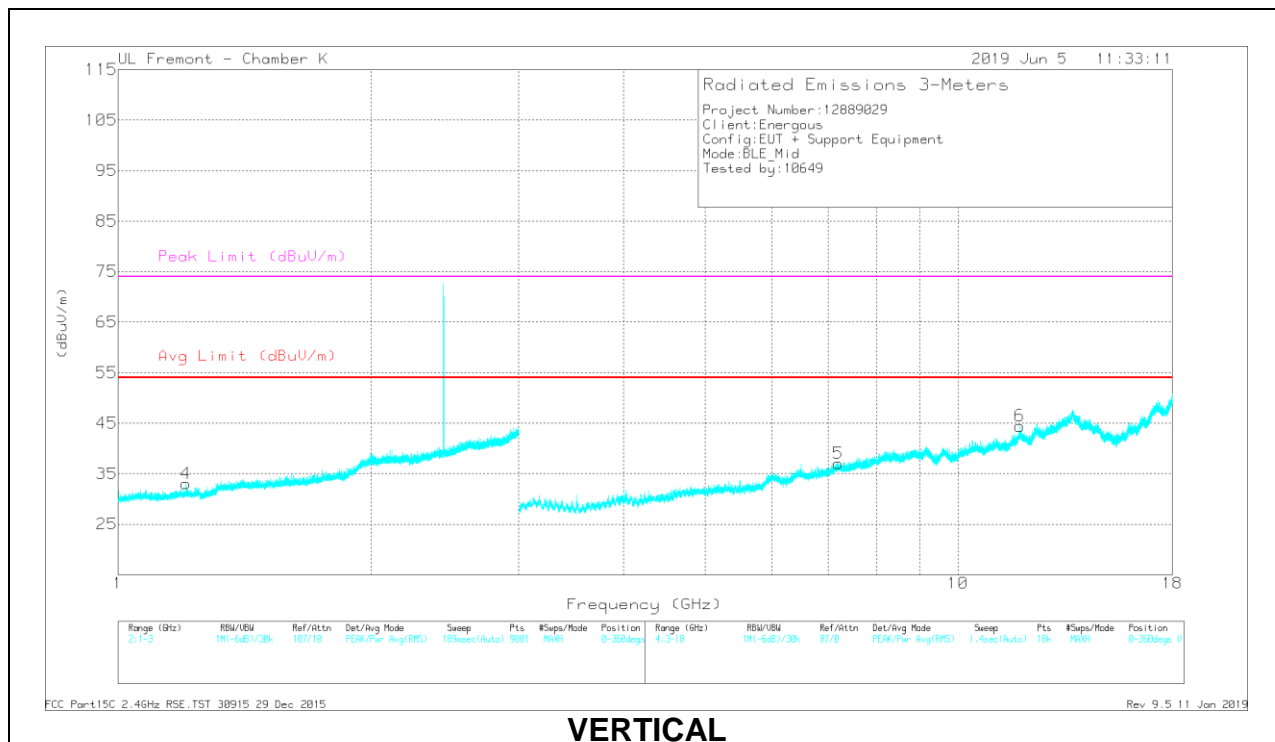

VERTICAL

RADIATED EMISSIONS

Marker	Frequency (GHz)	Meter Reading (dBuV)	Det	AF PRE0190811 (dB/m)	Amp/Cb/ Filt/Pad (dB)	DC Corr (dB)	Corrected Reading (dBuV/m)	Avg Limit (dBuV/m)	Margin (dB)	Peak Limit (dBuV/m)	PK Margin (dB)	Azimuth (Degs)	Height (cm)	Polarity
1	1.953	31.61	PK2	27.4	-15.1	0	43.91	-	-	-	-	341	326	H
4	* 1.204	30.77	PK2	24.1	-17.4	0		-	-	-	-	356	286	H
	* 1.204	20.32	MAv1	24.1	-17.4	1.99		-	-	-	-	356	286	H
2	* 7.423	32.98	PK2	37.1	-26.4	0	43.68	-	-	74	-30.32	316	242	H
	* 7.424	23.94	MAv1	37.1	-26.4	1.99	36.63	54	-17.37	-	-	316	242	H
3	* 12.417	28.55	PK2	40.9	-20.1	0	49.35	-	-	74	-24.65	284	317	H
	* 12.418	20.83	MAv1	40.9	-20.1	1.99	43.62	54	-10.38	-	-	284	317	H
5	7.202	32.67	PK2	37	-26.1	0	43.57	-	-	-	-	36	142	V
6	* 11.838	28.13	PK2	40	-19.7	0	48.43	-	-	74	-25.57	80	133	V
	* 11.841	20.12	MAv1	40	-19.8	1.99	42.31	54	-11.69	-	-	80	133	V

* - indicates frequency in CFR47 Pt 15 / IC RSS-Restricted Band

PK2 - KDB558074 Method: Maximum Peak

MAv1 - KDB558074 Option 1 Maximum RMS Average

HIGH CHANNEL RESULTS

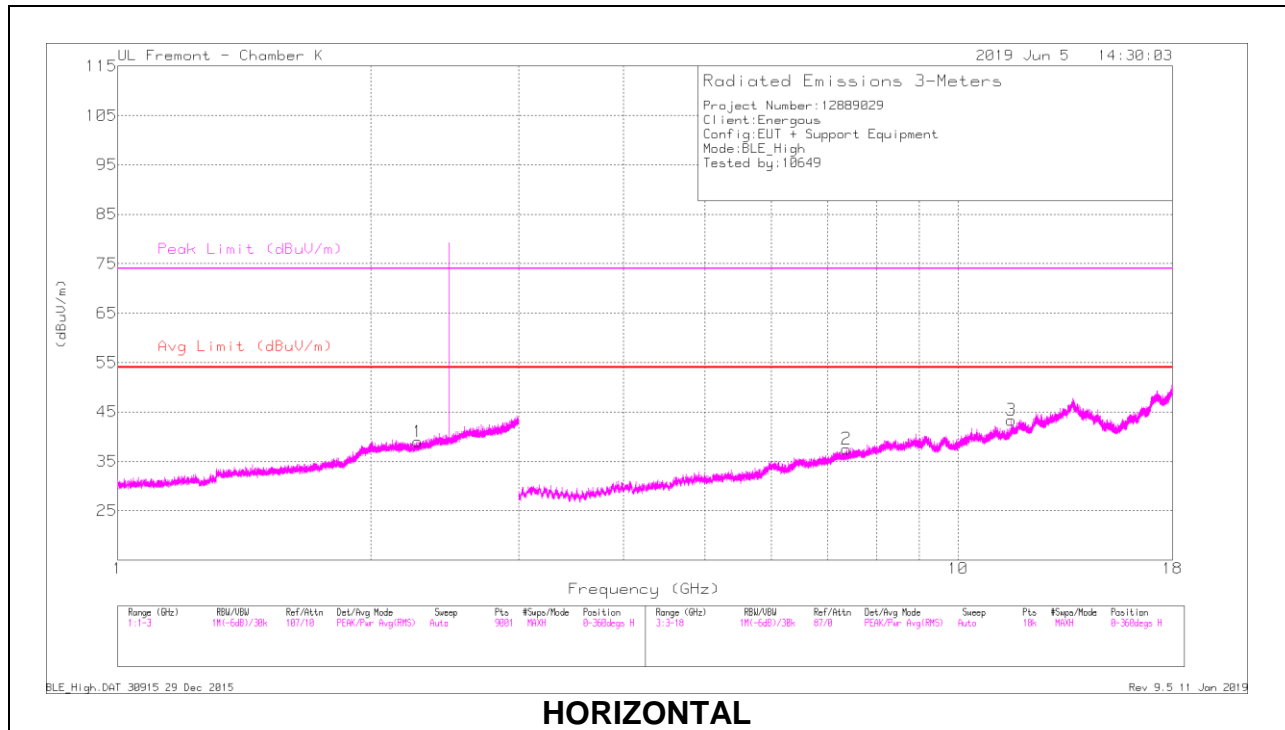

HORIZONTAL

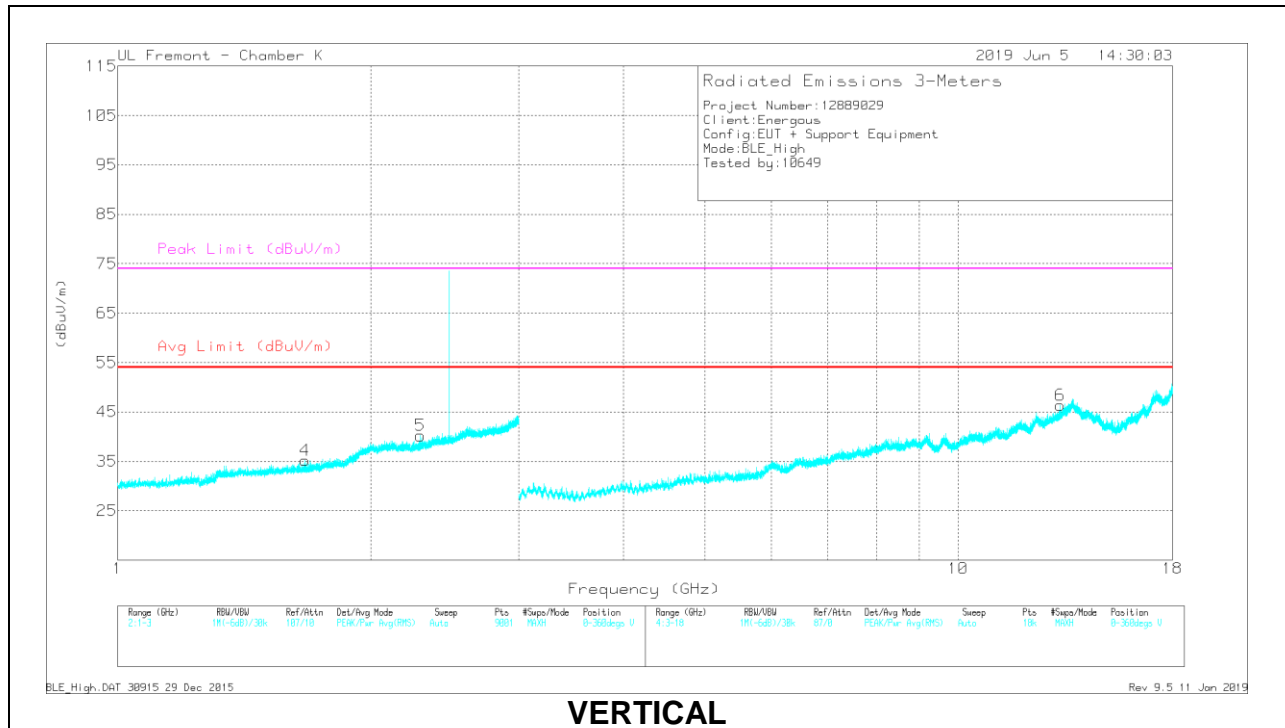

VERTICAL

RADIATED EMISSIONS

Frequency (GHz)	Meter Reading (dBuV)	Det	AF PRE0190811 (dB/m)	Amp/Cbl/Filtr/Pad (dB)	DC Corr (dB)	Corrected Reading (dBuV/m)	Avg Limit (dBuV/m)	Margin (dB)	Peak Limit (dBuV/m)	PK Margin (dB)	Azimuth (Degs)	Height (cm)	Polarity
* 2.275	32.81	PK2	27.4	-14.7	0	45.51	-	-	74	-28.49	9	306	H
* 2.273	22.9	MAv1	27.4	-14.7	1.99	37.59	54	-16.41	-	-	9	306	H
* 1.671	32.06	PK2	24.9	-16.2	0	40.76	-	-	74	-33.24	223	171	V
* 1.672	22.16	MAv1	24.9	-16.2	1.99	32.85	54	-21.15	-	-	223	171	V
* 2.293	33.57	PK2	27.5	-14.7	0	46.37	-	-	74	-27.63	345	320	V
* 2.294	22.52	MAv1	27.5	-14.6	1.99	37.41	54	-16.59	-	-	345	320	V
* 7.368	33.54	PK2	37.1	-26.4	0	44.24	-	-	74	-29.76	144	167	H
* 7.368	23.43	MAv1	37.1	-26.4	1.99	36.12	54	-17.88	-	-	144	167	H
* 11.57	29.59	PK2	39.5	-20.6	0	48.49	-	-	74	-25.51	244	181	H
* 11.57	20.63	MAv1	39.5	-20.6	1.99	41.52	54	-12.48	-	-	244	181	H
13.231	29.62	PK2	42.5	-20	0	52.12	-	-	-	-	195	397	V

* - indicates frequency in CFR47 Pt 15 / IC RSS-Restricted Band

PK2 - KDB558074 Method: Maximum Peak

MAv1 - KDB558074 Option 1 Maximum RMS Average

9.3. WORST CASE BELOW 30MHZ

SPURIOUS EMISSIONS BELOW 30 MHz (WORST-CASE CONFIGURATION)

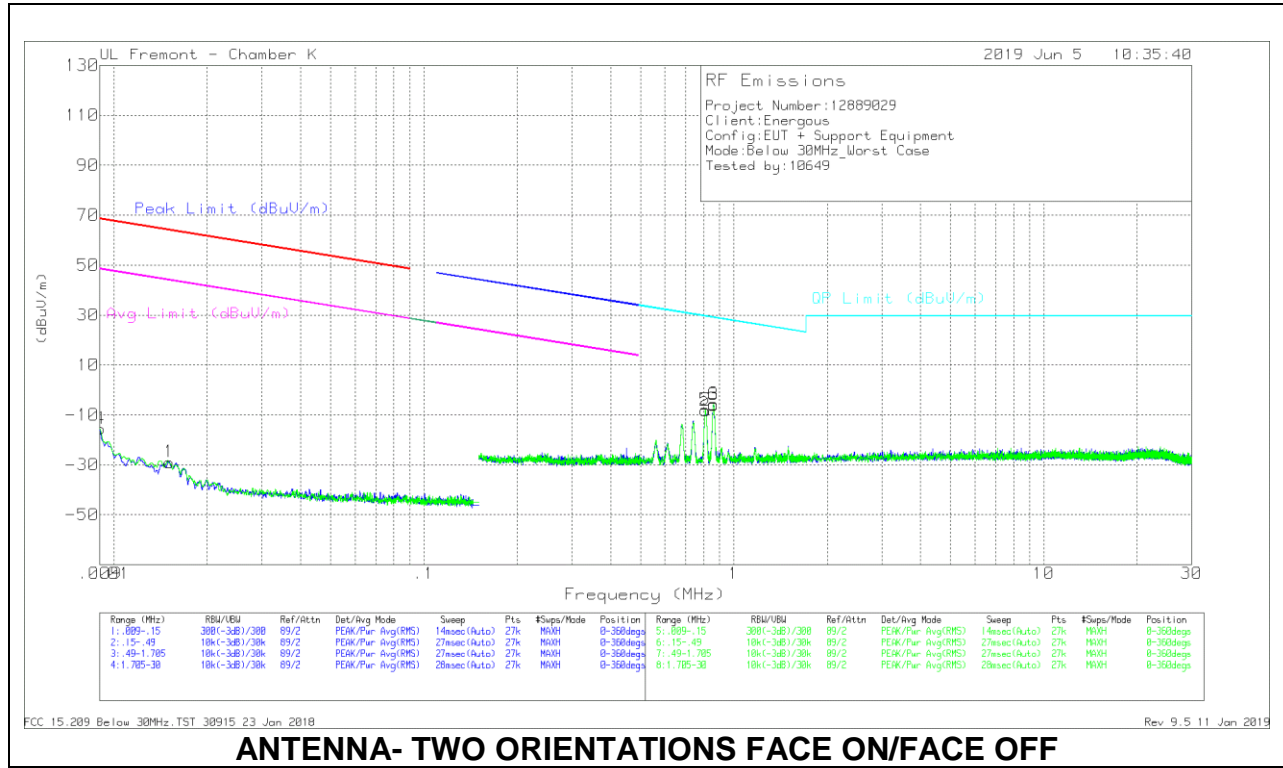

ANTENNA- TWO ORIENTATIONS FACE ON/FACE OFF

Below 30MHz Data

Marker	Frequency (MHz)	Meter Reading (dBuV)	Det	Loop Antenna (dB/m)	Cables (dB)	Dist Corr 300m	Corrected Reading (dBuV/m)	Peak Limit (dBuV/m)	Margin (dB)	Avg Limit (dBuV/m)	Margin (dB)	Azimuth (Degs)
1	.0151	-3.94	Pk	15	0	-40	-28.94	64.01	-92.95	44.01	-72.95	0-360
4	.00901	8.55	Pk	15.9	0	-40	-15.55	68.49	-84.04	48.49	-64.04	0-360

Marker	Frequency (MHz)	Meter Reading (dBuV)	Det	Loop Antenna (dB/m)	Cables (dB)	Dist Corr 30m (dB) 40Log	Corrected Reading (dBuV/m)	QP Limit (dBuV/m)	Margin (dB)	Azimuth (Degs)
2	.81024	17.63	Pk	14.1	.1	-40	-8.17	29.44	-37.61	0-360
3	.86008	19.73	Pk	14.2	.1	-40	-5.97	28.93	-34.9	0-360
5	.80869	17.74	Pk	14.1	.1	-40	-8.06	29.46	-37.52	0-360
6	.86107	20.01	Pk	14.2	.1	-40	-5.69	28.92	-34.61	0-360

Pk - Peak detector

9.4. WORST CASE BELOW 1 GHZ

SPURIOUS EMISSIONS 30 TO 1000 MHz (WORST-CASE CONFIGURATION)

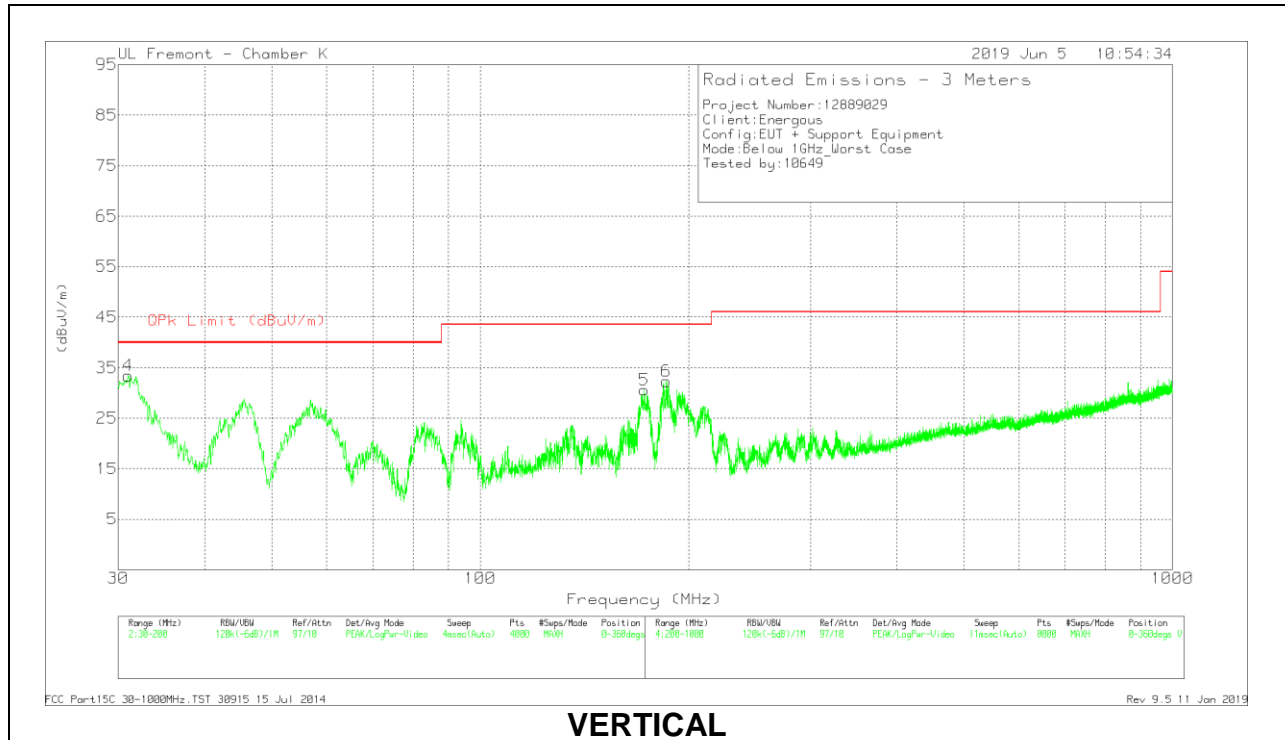
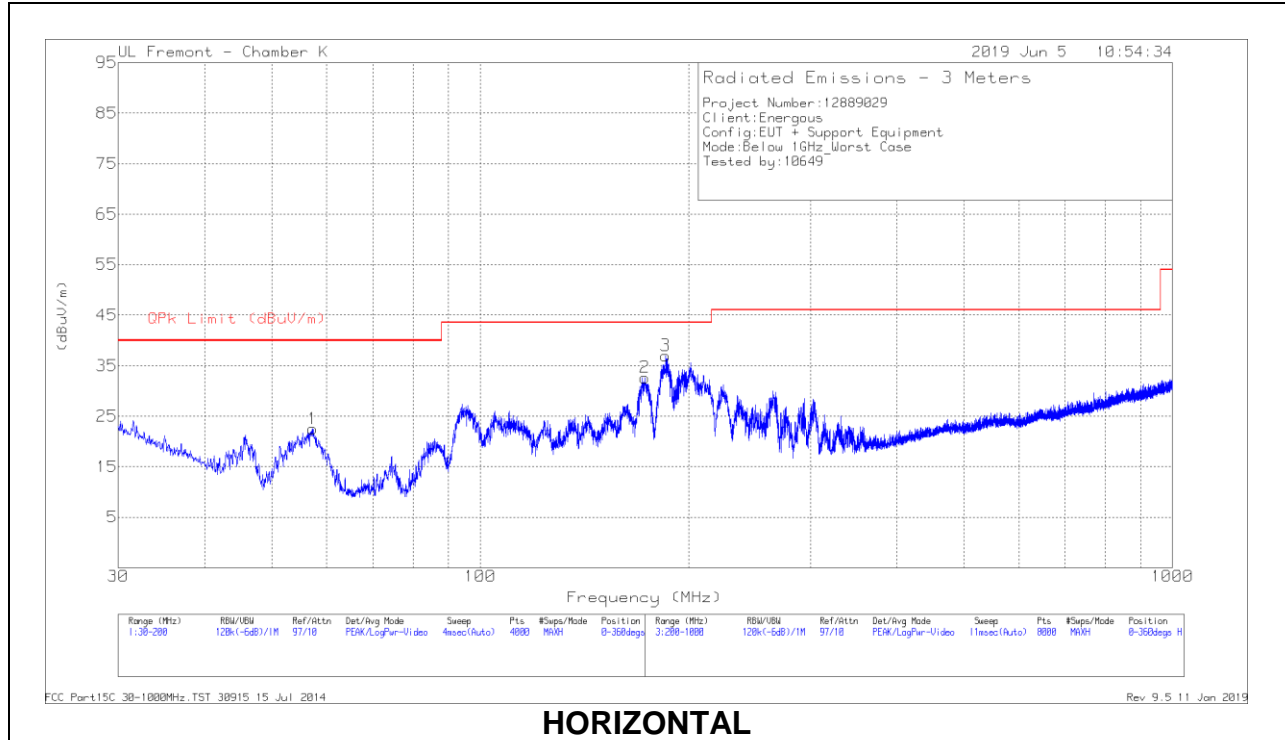

Below 1GHz Data

Marker	Frequency (MHz)	Meter Reading (dBuV)	Det	AF PRE0184052 (dB/m)	Amp/Cbl (dB)	Corrected Reading (dBuV/m)	QPk Limit (dBuV/m)	Margin (dB)	Azimuth (Degs)	Height (cm)	Polarity
1	57.3346	40.68	Pk	13.1	-31.3	22.48	40	-17.52	0-360	399	H
2	* 172.9645	45.66	Pk	17.4	-30.4	32.66	43.52	-10.86	0-360	199	H
3	185.4202	50.28	Pk	17	-30.3	36.98	43.52	-6.54	0-360	199	H
	185.4955	47.49	Qp	17	-30.3	34.19	43.52	-9.33	241	119	H
4	31.0203	39.12	Pk	25.9	-31.6	33.42	40	-6.58	0-360	100	V
5	* 172.5819	43.6	Pk	17.4	-30.4	30.6	43.52	-12.92	0-360	100	V
6	185.8453	45.61	Pk	17	-30.3	32.31	43.52	-11.21	0-360	100	V

Pk - Peak detector

Qp - Quasi-Peak detector

9.5. WORST CASE 18-26 GHZ

SPURIOUS EMISSIONS 18-26 GHz (WORST-CASE CONFIGURATION)

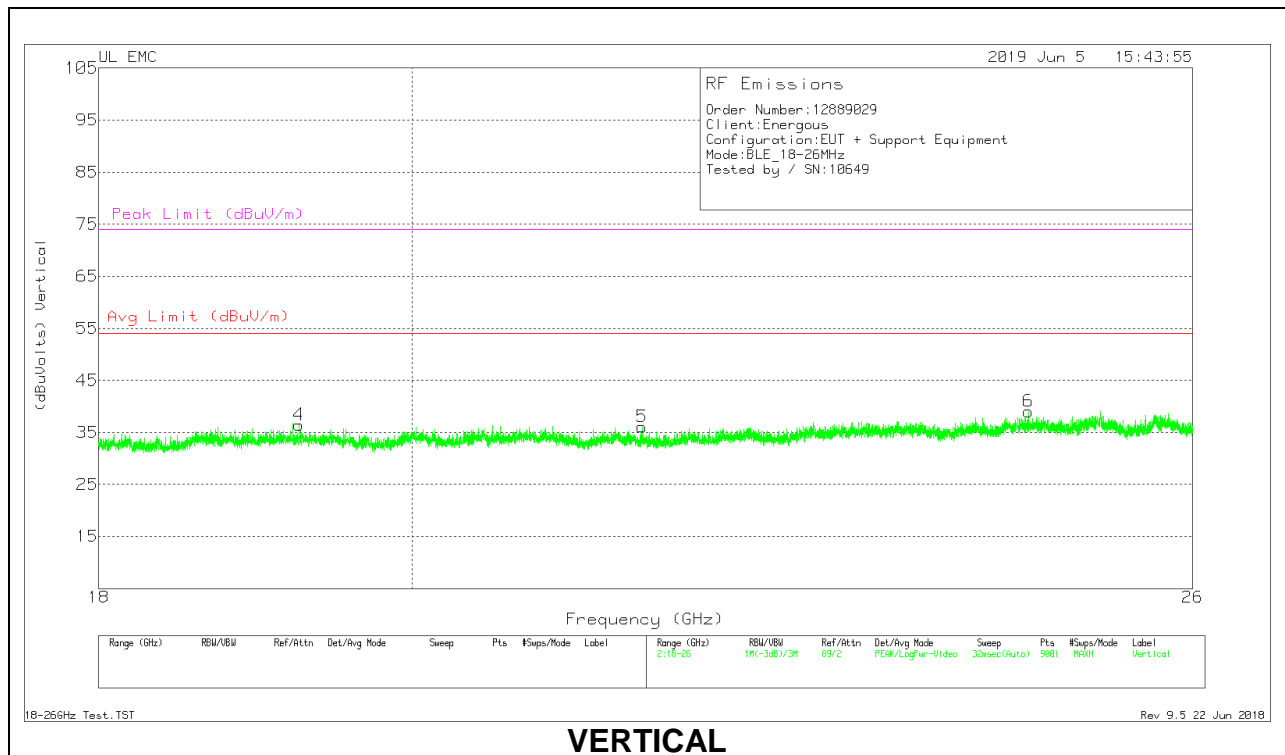
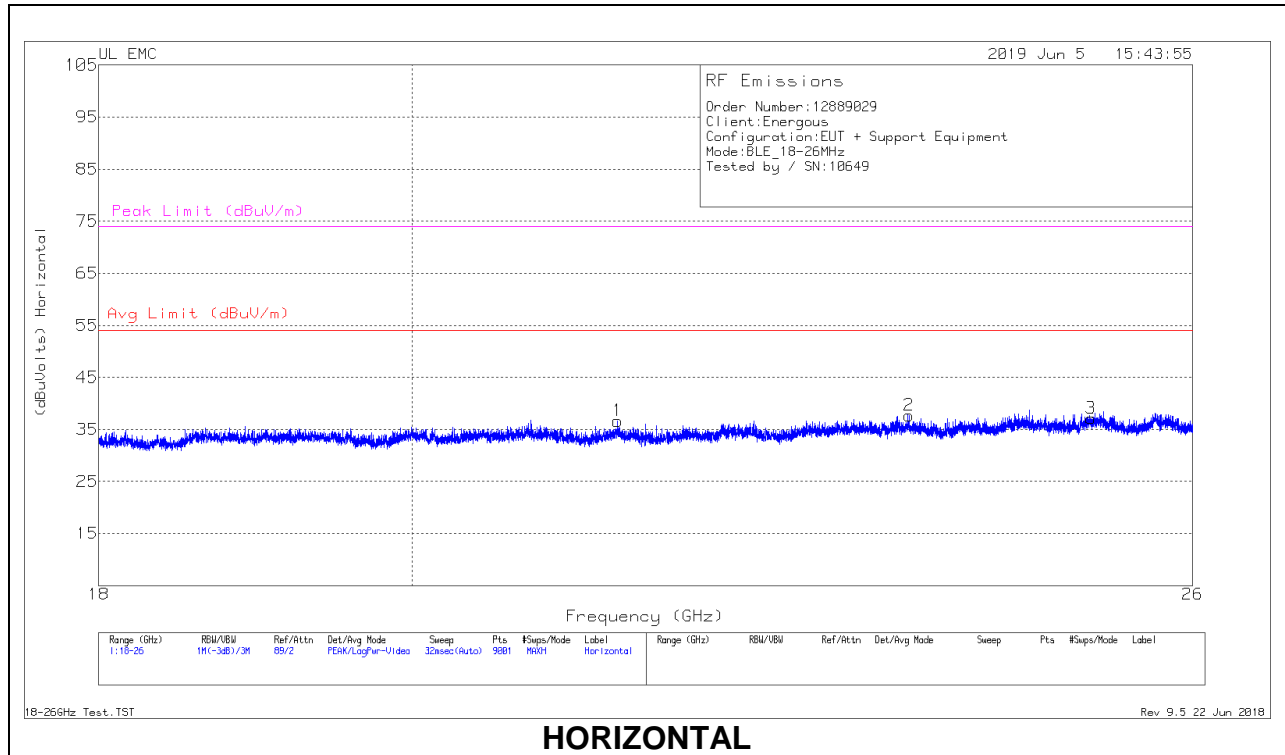

18 – 26GHz Data

Marker	Frequency (GHz)	Meter Reading (dBuV)	Det	AF PRE0182188 (dB/m)	Amp/Cbl (dB)	Dist Corr (dB)	Corrected Reading (dBuVolts)	Avg Limit (dBuV/m)	Margin (dB)	Peak Limit (dBuV/m)	PK Margin (dB)
1	21.43	69.44	Pk	33.7	-57	-9.5	36.64	54	-17.36	74	-37.36
2	23.636	69.79	Pk	34.5	-57.1	-9.5	37.69	54	-16.31	74	-36.31
3	25.126	66.93	Pk	34.9	-55.2	-9.5	37.13	54	-16.87	74	-36.87
4	19.252	69.93	Pk	33.3	-57.3	-9.5	36.43	54	-17.57	74	-37.57
5	21.606	69.07	Pk	33.7	-57.2	-9.5	36.07	54	-17.93	74	-37.93
6	24.603	69.94	Pk	34.7	-56.1	-9.5	39.04	54	-14.96	74	-34.96

Pk - Peak detector

10. AC POWER LINE CONDUCTED EMISSIONS

LIMITS

FCC §15.207 (a)

Frequency of Emission (MHz)	Conducted Limit (dB μ V)	
	Quasi-peak	Average
0.15-0.5	66 to 56 *	56 to 46 *
0.5-5	56	46
5-30	60	50

*Decreases with the logarithm of the frequency.

TEST PROCEDURE

Tested in accordance with ANSI C63.10-2013

The EUT is placed on a non-conducting table 40 cm from the vertical ground plane and 80 cm above the horizontal ground plane. The EUT is configured in accordance with ANSI C63.4.

The receiver is set to a resolution bandwidth of 9 kHz. Peak detection is used unless otherwise noted as quasi-peak or average.

Line conducted data is recorded for both NEUTRAL and HOT lines.

RESULTS

LINE 1 RESULTS

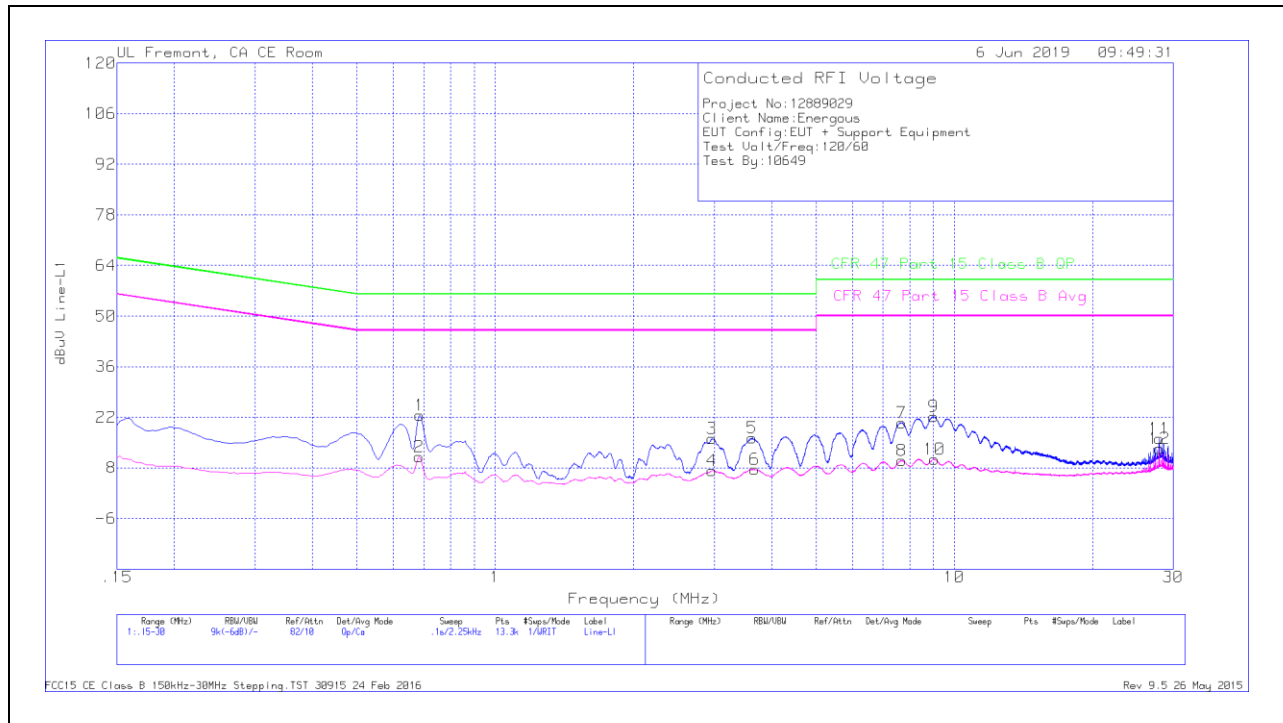

Range 1: Line-L1 .15 - 30MHz										
Marker	Frequency (MHz)	Meter Reading (dBuV)	Det	LISN L1	LC Cables C1&C3	Corrected Reading dBuV	CFR 47 Part 15 Class B QP	Margin (dB)	CFR 47 Part 15 Class B Avg	Margin (dB)
1	.6855	12.47	Qp	0	0	10.1	22.57	56	-33.43	-
2	.68325	.97	Ca	0	0	10.1	11.07	-	-	46
3	2.967	5.84	Qp	0	.1	10.1	16.04	56	-39.96	-
4	2.97038	-2.9	Ca	0	.1	10.1	7.3	-	-	46
5	3.633	6.02	Qp	0	.1	10.1	16.22	56	-39.78	-
6	3.6735	-2.59	Ca	0	.1	10.1	7.61	-	-	46
7	7.68075	10.12	Qp	0	.2	10.2	20.52	60	-39.48	-
8	7.692	-.32	Ca	0	.2	10.2	10.08	-	-	50
9	9.01163	11.79	Qp	0	.2	10.2	22.19	60	-37.81	-
10	9.04538	-.01	Ca	0	.2	10.2	10.39	-	-	50
11	27.93525	5.03	Qp	.1	.4	10.5	16.03	60	-43.97	-
12	27.93525	2.32	Ca	.1	.4	10.5	13.32	-	-	50

Qp - Quasi-Peak detector

Ca - CISPR average detection

LINE 2 RESULTS

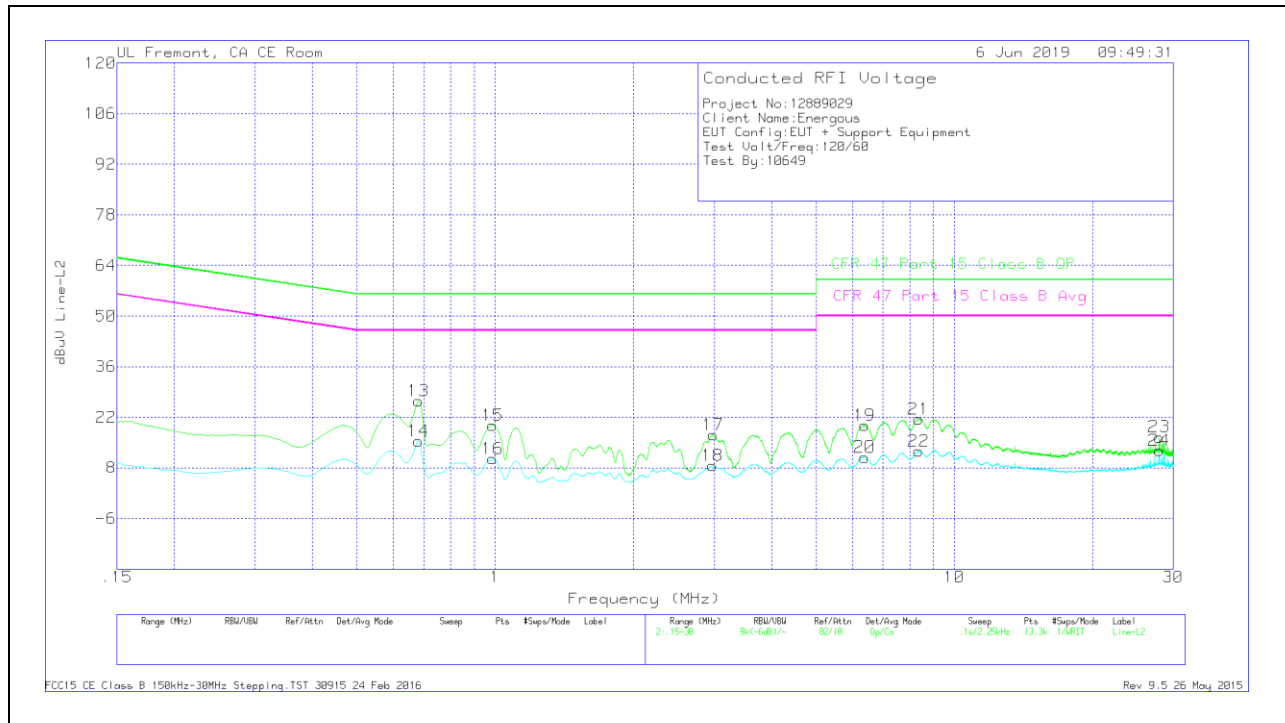

Range 2: Line-L2 .15 - 30MHz										
Marker	Frequency (MHz)	Meter Reading (dBuV)	Det	LISN L2	LC Cables C2&C3	Corrected Reading dBuV	CFR 47 Part 15 Class B QP	Margin (dB)	CFR 47 Part 15 Class B Avg	Margin (dB)
13	.681	16.37	Qp	0	0	10.1	26.47	56	-29.53	-
14	.681	5.37	Ca	0	0	10.1	15.47	-	-	46
15	.98812	9.62	Qp	0	.1	10.1	19.82	56	-36.18	-
16	.98812	.3	Ca	0	.1	10.1	10.5	-	-	46
17	2.98725	6.94	Qp	0	.1	10.1	17.14	56	-38.86	-
18	2.976	-1.53	Ca	0	.1	10.1	8.67	-	-	46
19	6.3825	9.31	Qp	0	.2	10.2	19.71	60	-40.29	-
20	6.38588	.57	Ca	0	.2	10.2	10.97	-	-	50
21	8.37038	11.14	Qp	0	.2	10.2	21.54	60	-38.46	-
22	8.35575	2.22	Ca	0	.2	10.2	12.62	-	-	50
23	27.93525	5.54	Qp	.1	.4	10.5	16.54	60	-43.46	-
24	27.93525	1.74	Ca	.1	.4	10.5	12.74	-	-	50

Qp - Quasi-Peak detector

Ca - CISPR average detection