



FCC 47 CFR PART 18 SUBPART C

CERTIFICATION TEST REPORT

FOR

CLOSE COUPLED 5.8 GHz CHARGER PAD

MODEL NUMBER: MT-100

FCC ID: 2ADNG-MT100

REPORT NUMBER: 16U23305-E1V5

ISSUE DATE: JULY 19, 2016

Prepared for
ENERGOUS CORPORATION
3590 NORTH FIRST STREET
SAN JOSE, CA 95134

Prepared by
UL VERIFICATION SERVICES INC.
47173 BENICIA STREET
FREMONT, CA 94538, U.S.A.
TEL: (510) 771-1000
FAX: (510) 661-0888



NVLAP LAB CODE 200065-0

Revision History

<u>Rev.</u>	<u>Issue Date</u>	<u>Revisions</u>	<u>Revised By</u>
V1	5/10/2016	Initial Issue	M. Heckrotte
V2	5/16/2016	Updated Equipment list in Section 6, Added note and updated tabular data in Section 7.3.1, Updated Section 7.3.3.	C. Vergonio
V3	5/17/2016	Inserted the Average tabular data in Section 7.3.3	C. Vergonio
V4	5/17/2016	Removed notes in the tabular data that reference to Part 15 restricted band.	C. Vergonio
V5	7/19/2016	Revised Sections 5.1, 5.3 and 7.3.1. Corrected typographical errors in Sections 7.3, 7.3.1, 7.3.2, 7.3.3, 7.3.4, 7.3.5, and 7.4.	M. Heckrotte

TABLE OF CONTENTS

1. ATTESTATION OF TEST RESULTS	4
2. TEST METHODOLOGY	5
3. FACILITIES AND ACCREDITATION	5
4. CALIBRATION AND UNCERTAINTY	5
4.1. <i>MEASURING INSTRUMENT CALIBRATION</i>	<i>5</i>
4.2. <i>SAMPLE CALCULATION</i>	<i>5</i>
4.3. <i>MEASUREMENT UNCERTAINTY.....</i>	<i>6</i>
5. EQUIPMENT UNDER TEST	7
5.1. <i>DESCRIPTION OF EUT</i>	<i>7</i>
5.2. <i>SOFTWARE AND FIRMWARE.....</i>	<i>7</i>
5.3. <i>CONFIGURATIONS INVESTIGATED.....</i>	<i>8</i>
5.4. <i>MODIFICATIONS</i>	<i>8</i>
5.5. <i>DETAILS OF TESTED SYSTEM</i>	<i>8</i>
6. TEST AND MEASUREMENT EQUIPMENT	10
7. APPLICABLE LIMITS AND TEST RESULTS	11
7.1. <i>OPERATING FREQUENCY</i>	<i>11</i>
7.2. <i>EUT CONTROL</i>	<i>12</i>
7.3. <i>RADIATED EMISSIONS.....</i>	<i>14</i>
7.3.1. <i>SPURIOUS EMISSIONS 9 kHz - 30 MHz</i>	<i>15</i>
7.3.2. <i>SPURIOUS EMISSIONS 30 - 1000 MHz</i>	<i>18</i>
7.3.3. <i>SPURIOUS EMISSIONS 1 - 18 GHz</i>	<i>24</i>
7.3.4. <i>SPURIOUS EMISSIONS 18 - 26 GHz</i>	<i>30</i>
7.3.5. <i>SPURIOUS EMISSIONS 26 - 40 GHz</i>	<i>36</i>
7.3.6. <i>SPURIOUS EMISSIONS 40 - 50 GHz</i>	<i>42</i>
7.3.7. <i>SPURIOUS EMISSIONS 50 - 60 GHz</i>	<i>44</i>
7.4. <i>AC MAINS LINE CONDUCTED EMISSIONS</i>	<i>46</i>
8. SETUP PHOTOS.....	53

1. ATTESTATION OF TEST RESULTS

COMPANY NAME: ENERGOUS CORPORATION
3590 NORTH FIRST STREET
SAN JOSE, CA 95134 USA

EUT DESCRIPTION: CLOSE COUPLED 5.8 GHZ CHARGER PAD

MODEL: MT-100

SERIAL NUMBER: 059 with Antenna 1

DATE TESTED: April 27 – May 10, 2016

APPLICABLE STANDARDS	
STANDARD	TEST RESULTS
FCC PART 18	Pass

UL Verification Services Inc. tested the above equipment in accordance with the requirements set forth in the above standards. All indications of Pass/Fail in this report are opinions expressed by UL Verification Services Inc. based on interpretations and/or observations of test results. Measurement Uncertainties were not taken into account and are published for informational purposes only. The test results show that the equipment tested is capable of demonstrating compliance with the requirements as documented in this report.

Note: The results documented in this report apply only to the tested sample, under the conditions and modes of operation as described herein. This document may not be altered or revised in any way unless done so by UL Verification Services Inc. and all revisions are duly noted in the revisions section. Any alteration of this document not carried out by UL Verification Services Inc. will constitute fraud and shall nullify the document. This report must not be used by the client to claim product certification, approval, or endorsement by NVLAP, NIST, any agency of the Federal Government, or any agency of any government.

Approved & Released For
UL Verification Services Inc. By:

Tested By:



MICHAEL HECKROTTE
PRINCIPAL ENGINEER
UL Verification Services Inc.

JEFFREY WU
WISE ENGINEER
UL Verification Services Inc.

2. TEST METHODOLOGY

The tests documented in this report were performed in accordance with FCC / OST MP-5, "FCC Methods of Measurements of Radio Noise Emissions from Industrial, Scientific, and Medical Equipment."

3. FACILITIES AND ACCREDITATION

The test sites and measurement facilities used to collect data are located at 47173 Benicia Street, Fremont, California, USA.

The test sites and measurement facilities used to collect data are located at 47173 and 47266 Benicia Street, Fremont, California, USA. Line conducted emissions are measured only at the 47173 address. The following table identifies which facilities were utilized for radiated emission measurements documented in this report. Specific facilities are also identified in the test results sections.

47173 Benicia Street	47266 Benicia Street
<input type="checkbox"/> Chamber A	<input type="checkbox"/> Chamber D
<input checked="" type="checkbox"/> Chamber B	<input type="checkbox"/> Chamber E
<input type="checkbox"/> Chamber C	<input type="checkbox"/> Chamber F
	<input type="checkbox"/> Chamber G
	<input type="checkbox"/> Chamber H

The above test sites and facilities are covered under FCC Test Firm Registration # 208313. Chambers A through H are covered under Industry Canada company address code 2324B with site numbers 2324B -1 through 2324B-8, respectively.

UL Verification Services Inc. is accredited by NVLAP, Laboratory Code 200065-0. The full scope of accreditation can be viewed at <http://ts.nist.gov/standards/scopes/2000650.htm>.

4. CALIBRATION AND UNCERTAINTY

4.1. MEASURING INSTRUMENT CALIBRATION

The measuring equipment utilized to perform the tests documented in this report has been calibrated in accordance with the manufacturer's recommendations, and is traceable to recognized national standards.

4.2. SAMPLE CALCULATION

Where relevant, the following sample calculation is provided:

$$\begin{aligned} \text{Field Strength (dBuV/m)} &= \text{Measured Voltage (dBuV)} + \text{Antenna Factor (dB/m)} + \\ &\text{Cable Loss (dB)} - \text{Preamp Gain (dB)} \\ 36.5 \text{ dBuV} + 18.7 \text{ dB/m} + 0.6 \text{ dB} - 26.9 \text{ dB} &= 28.9 \text{ dBuV/m} \end{aligned}$$

4.3. MEASUREMENT UNCERTAINTY

Where relevant, the following measurement uncertainty levels have been estimated for tests performed on the apparatus:

PARAMETER	UNCERTAINTY
Conducted Disturbance, 0.15 to 30 MHz	3.52 dB
Radiated Disturbance, 9 kHz to 30 MHz	2.14 dB
Radiated Disturbance, 30 to 1000 MHz	4.98 dB
Radiated Disturbance, 1 to 6 GHz	3.86 dB
Radiated Disturbance, 6 to 18 GHz	4.23 dB
Radiated Disturbance, 18 to 26 GHz	5.30 dB
Radiated Disturbance, 26 to 40 GHz	5.23 dB
Radiated Disturbance, 40 to 50 GHz	3.48 dB
Radiated Disturbance, 50 to 60 GHz	3.48 dB

Uncertainty figures are valid to a confidence level of 95%.

5. EQUIPMENT UNDER TEST

5.1. DESCRIPTION OF EUT

The EUT is a close-coupled 5.8 GHz charger pad.

The charger pad is a single client RF near-field, contact charger that operates when a receiving device is placed on the charger pad's surface.

GENERAL INFORMATION

Power Requirements	100-240 VAC / 50-60 Hz / 300 mA
List of frequencies generated or used by the EUT, and purpose	10 MHz: Reference for Synthesizer PLL 24 MHz: Microcontroller Clock 5862.5 MHz: Operating Frequency, locked to 10 MHz Reference
Chassis Material	Base Bottom and Heatsink: Aluminum Base Top: Polycarbonate Plastic Cap: Polycarbonate

SUBASSEMBLIES

The EUT was constructed using the following subassemblies:

Subassembly Description	Manufacturer	Part Number
Base Bottom & Heatsink	Energous	N/A
Base Top	Energous	N/A
Plastic Cap	Energous	N/A
Antenna PCB	Energous	N/A
Main PCB	Energous	N/A
AC Adapter	Zeskit	AD566

5.2. SOFTWARE AND FIRMWARE

The firmware installed in the EUT during testing was r4254_etxnf_2.1.1.

5.3. CONFIGURATIONS INVESTIGATED

SPEAG precision low dielectric and low permittivity foam spacer material is used to vary the gap between the Charger Pad and the Load. These spacers are designed for SAR measurements and have a thickness accuracy of 0.1 mm. For test purposes the Plastic Cap was removed and the SPEAG spacers were used to adjust the gap in a repeatable manner.

Maximum power transference occurs when there is no gap. Minimum power transference occurs when there is a maximum gap.

Tests were performed over a larger range of gaps than will occur during normal use, yielding worst-case results based on configurations that are more extreme than normal operation. The z-direction gap between the TX and RX antenna PCBs ranged from zero to 2 mm. At a spacing of 3 mm the RX magnet was not close enough to energize the device. A larger z-direction gap was simulated by artificially activating the magnet switch with no load.

Configuration	Description
No Load with Magnet	Load was removed. Magnet was placed on the EUT to activate the device
Load with 0 mm Spacing	Load was placed directly on the EUT TX antenna PCB
Load with 2 mm Spacing	Load was placed on the EUT TX antenna PCB with 2 mm foam in between

5.4. MODIFICATIONS

No modifications were made during testing.

5.5. DETAILS OF TESTED SYSTEM

CABLES

I/O CABLE LIST						
Cable No.	Port	# of Identical Ports	Connector Type	Cable Type	Cable Length	Remarks
1	AC	1	USB type-A	SHIELDED	0.9m	Use for Below 1 GHz Emission Scan
1	AC	1	USB type-A	SHIELDED	1.8m	Use for Above 1 GHz Emission Scan

TEST SETUP

The EUT is stand-alone unit.

SETUP DIAGRAM FOR TESTS

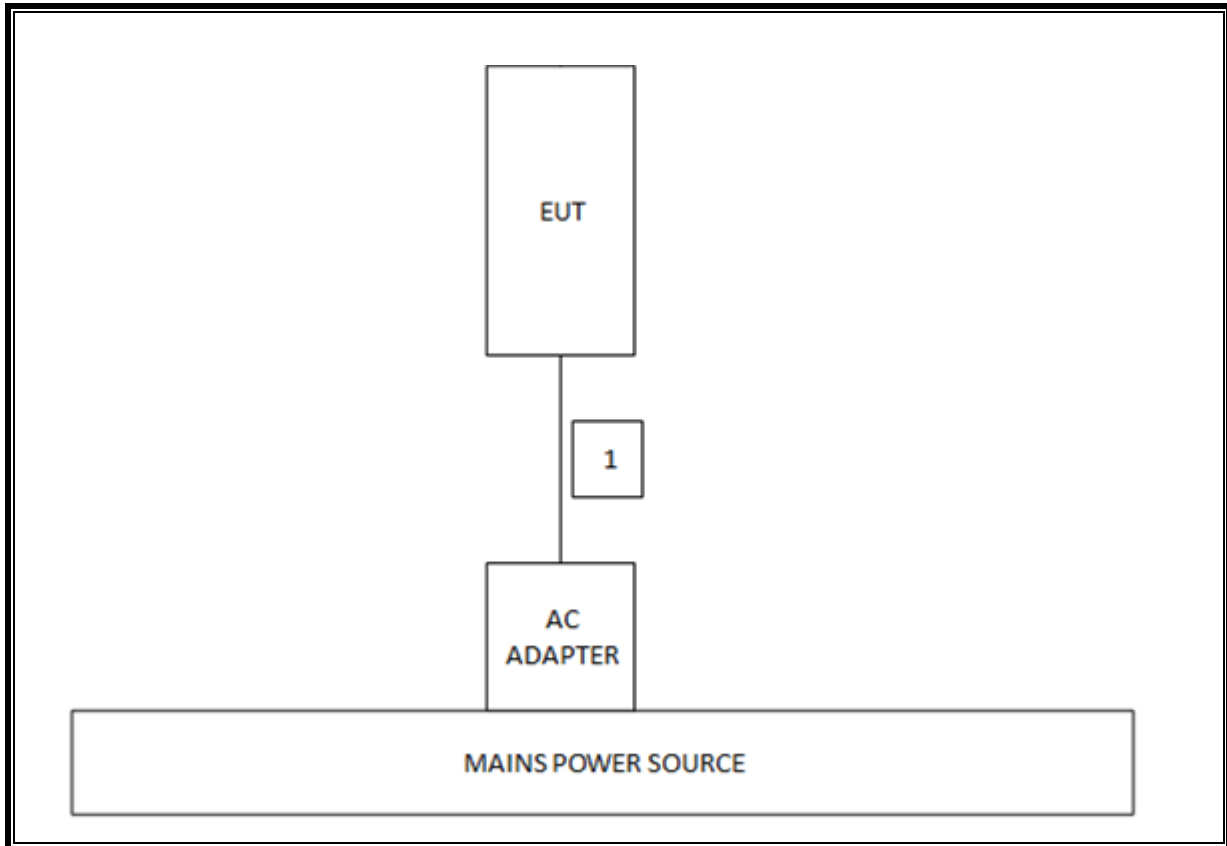

6. TEST AND MEASUREMENT EQUIPMENT

The following test and measurement equipment was utilized for the tests documented in this report:

Test Equipment List				
Description	Manufacturer	Model	T Number	Cal Due
Amplifier, 1-18GHz	Miteq	AFS42-00101800-25-S-42	493	03/09/17
Amplifier, 1-8GHz, 35 dB	Miteq	AMF-4D-01000800-30-29P	1156	03/09/17
Antenna, Biconolog, 30MHz-1 GHz	Sunol Sciences	JB1	130	09/01/16
Antenna, Horn, 18GHz	ETS Lindgren	3117	345	02/22/17
Antenna, Horn, 26.5 GHz	ARA	MWH-1826/B	447	05/12/16
Antenna, Horn, 40 GHz	ARA	MWH-2640	90	07/28/16
ESR7 EMI Test Receiver 7GHz	Rohde & Schwarz	ESR	1436	12/19/16
High Pass Filter 3GHz	Micro-Tronics	HPS17543	485	03/09/17
High Pass Filter 3GHz	Micro-Tronics	HPS17543	486	07/20/16
High Pass Filter 6GHz	Micro-Tronics	HPS17542	483	03/09/17
High Pass Filter 6GHz	Micro-Tronics	HPS17542	484	07/20/16
LISN, 30 MHz	FCC	FCC-LISN-50/250-25-2	24	02/09/17
Loop Antenna	ETS Lindgren	6502	757	05/21/16
Low Pass Filter 5GHz	Micro-Tronics	LPS17541	482	03/09/17
Low Pass Filter 5GHz	Micro-Tronics	LPS17541	481	07/20/16
RF Preamp, 1GHz - 26.5GHz	HP	8449B	404	06/29/16
RF Preamp, 26GHz - 40GHz	Miteq	NSP4000-SP2	88	04/07/17
Spectrum Analyzer, 40 GHz	Agilent / HP	8564E	106	08/14/16
Spectrum Analyzer, 44 GHz	Keysight	N9030A	907	01/06/17
Spectrum Analyzer, 50 GHz	Agilent	N9030A	313	08/04/16
Horn Antenna, 50 GHz	ATM	22-442-6	NA	CNR
Low Pass Filter, 50 GHz	SPACEK LABS	LPF5-50-8-22	T1099	06/01/16
RF Preamp, 40-50 GHz,	SPACEK LABS	sl4510-33-4W	NA	06/01/16
Horn Antenna, 75 GHz	CMI	HO15R	NA	CNR
Harmonic Mixer, 50 to 80 GHz	Agilent	M1970V	MY51390830	08/12/16

Test Software List			
Description	Manufacturer	Model	Version
Radiated Software	UL	UL EMC	Ver 9.5, Apr 12, 2016
Conducted Software	UL	UL EMC	Ver 9.5, May 26, 2015

7. APPLICABLE LIMITS AND TEST RESULTS

7.1. OPERATING FREQUENCY

LIMIT

§18.301 The following frequency bands, in accordance with §2.106 of the rules, are allocated for use by ISM equipment:

ISM frequency	Tolerance
6.78 MHz	±15.0 kHz
13.56 MHz	±7.0 kHz
27.12 MHz	±163.0 kHz
40.68 MHz	±20.0 kHz
915 MHz	±13.0 MHz
2,450 MHz	±50.0 MHz
5,800 MHz	±75.0 MHz
24,125 MHz	±125.0 MHz
61.25 GHz	±250.0 MHz
122.50 GHz	±500.0 MHz
245.00 GHz	±1.0 GHz

NOTE: The use of the 6.78 MHz ±15 kHz frequency band is subject to the conditions of footnote 524 of the Table of Allocations. See §2.106.

TEST PROCEDURE

FCC / OST MP-5

RESULTS

Configuration	Frequency (MHz)	Lower Limit (MHz)	Upper Limit (MHz)
No Load with Magnet	5861.915370	5725	5875
Load with 0 mm Spacing	5861.918176	5725	5875
Load with 2 mm Spacing	5861.941423	5725	5875

7.2. EUT CONTROL

LIMIT

Reporting requirement.

TEST PROCEDURE

Place load on charger, confirm by observation of emissions at fundamental frequency that device is operating.

Remove load from charger, confirm by observation of emissions at fundamental frequency that device is not operating.

RESULTS

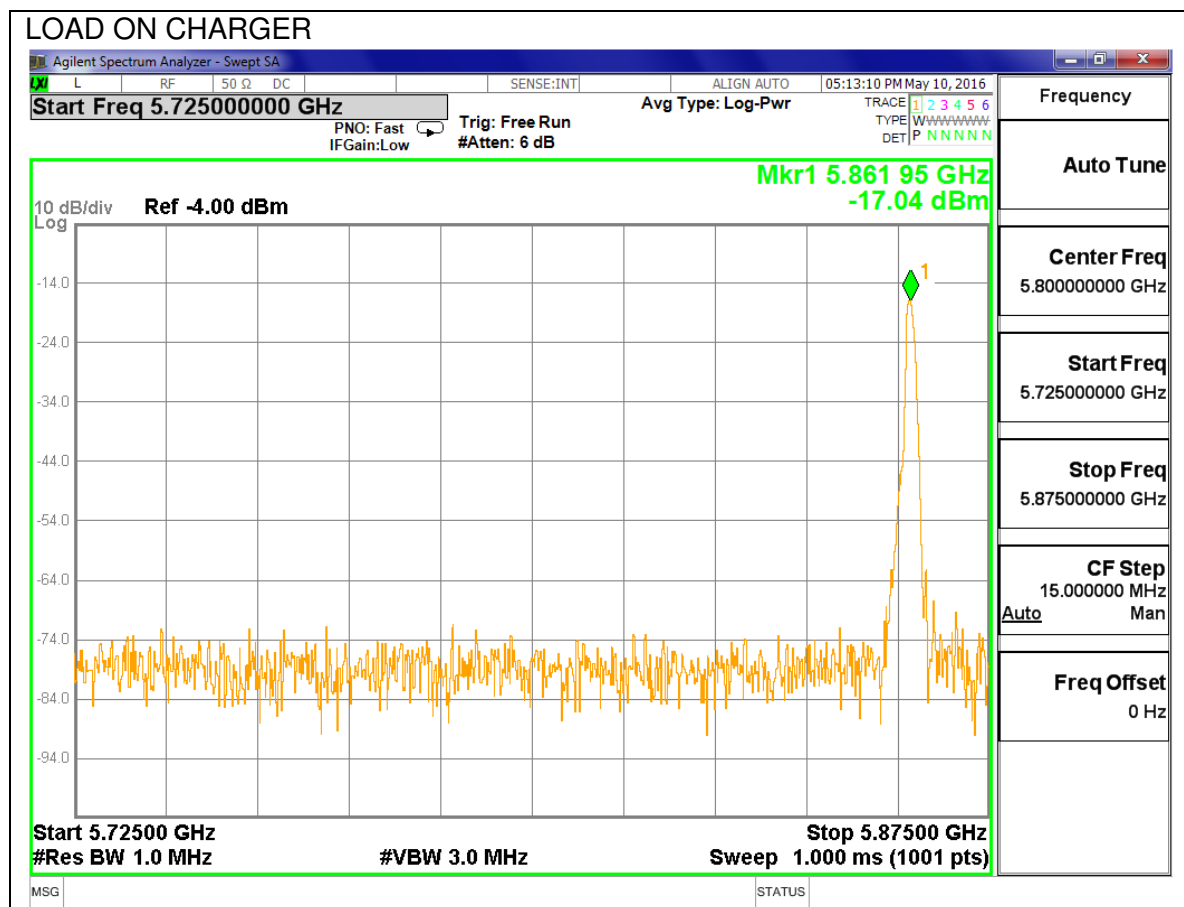

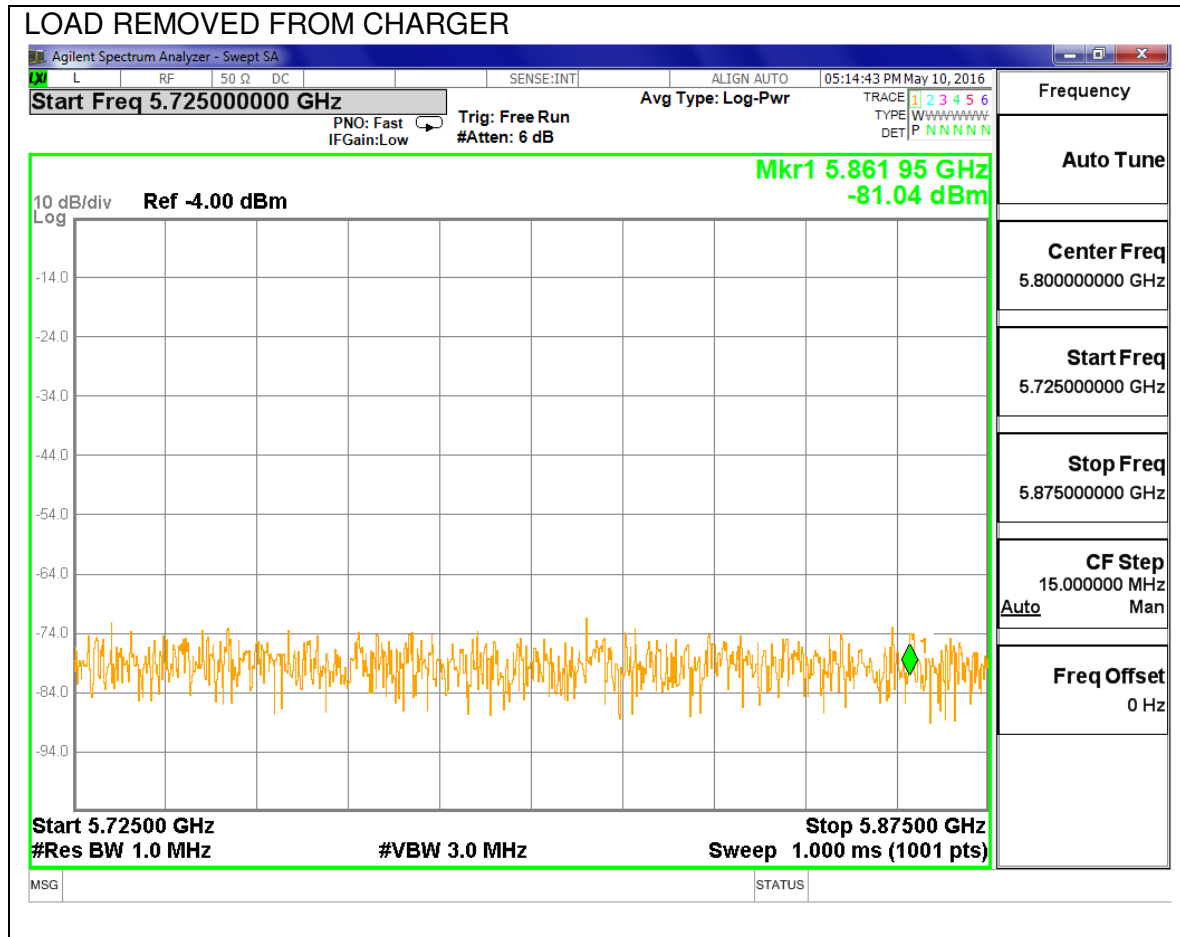

7.3. RADIATED EMISSIONS

LIMIT

§18.305 (b) The field strength levels of emissions which lie outside the bands specified in §18.301, unless otherwise indicated, shall not exceed the following:

Equipment	Operating frequency	RF Power generated by equipment (watts)	Field strength limit (uV/m)	Distance (meters)
Any type unless otherwise specified (miscellaneous)	Any ISM frequency	Below 500 500 or more	25 25×SQRT (power/500)	300 ¹ 300

¹Field strength may not exceed 10 µV/m at 1600 meters. Consumer equipment operating below 1000 MHz is not permitted the increase in field strength otherwise permitted here for power over 500 watts.

The RF Power generated by the equipment is below 500 W therefore the field strength limit is 25 uV/m at 300 m.

TEST PROCEDURE

FCC / OST MP-5

The frequency range was investigated from 9 kHz to 60 GHz.

RESULTS

No non-compliance noted:

7.3.1. SPURIOUS EMISSIONS 9 kHz - 30 MHz

Configuration 1: No Load with Magnet

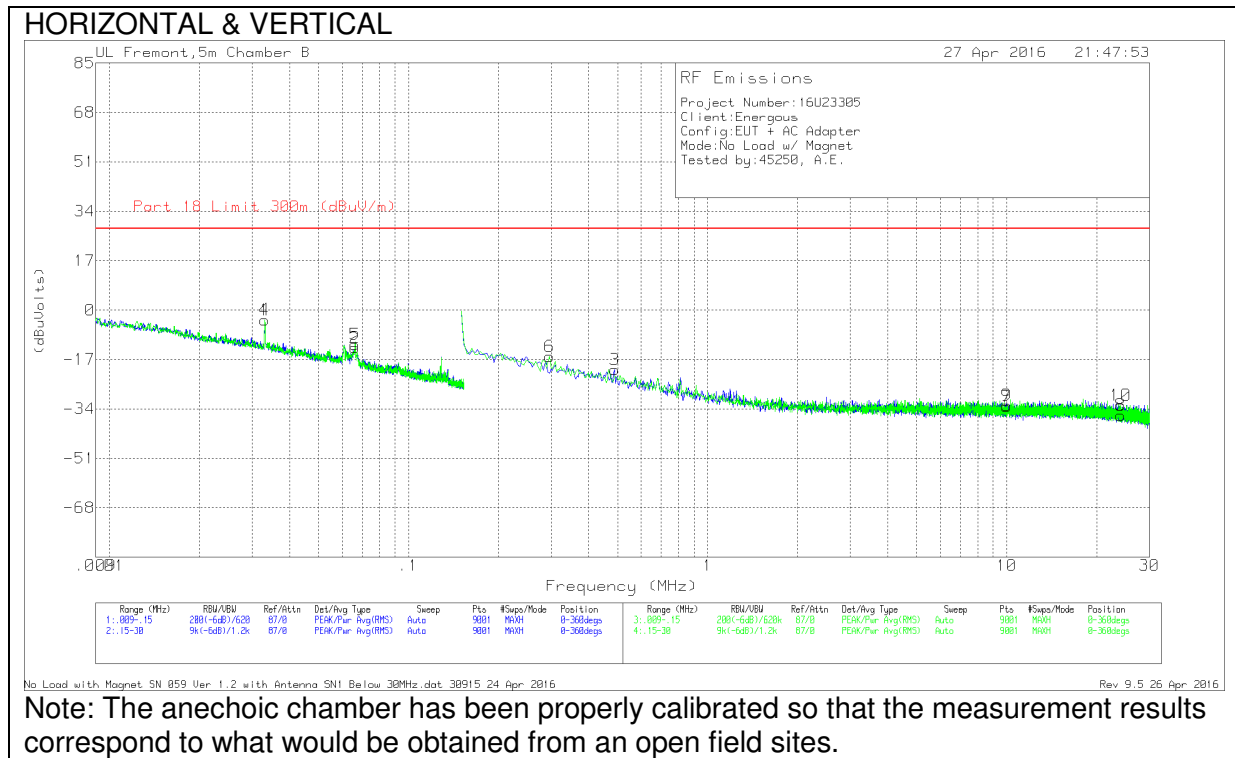

Trace Markers

Marker	Frequency (MHz)	Meter Reading (dBuV)	Det	Loop Antenna (dB/m)	Dist Corr (dB)	Corrected Reading (dBuVolts)	Part 18 Limit 300m (dBuV/m)	Margin (dB)	Azimuth (Degs)
4	.03308	23.99	Pk	12.7	-40	-3.31	28	-31.31	0-360
1	.0331	23.93	Pk	12.7	-40	-3.37	28	-31.37	0-360
2	.06609	16.03	Pk	11	-40	-12.97	28	-40.97	0-360
5	.06628	17.09	Pk	11	-40	-11.91	28	-39.91	0-360
6	.29595	13.2	Pk	10.8	-40	-16	28	-44	0-360
3	.48833	8.95	Pk	10.6	-40	-20.45	28	-48.45	0-360
7	9.99817	-4.07	Pk	10.8	-40	-33.27	28	-61.27	0-360
9	10.00812	-3.47	Pk	10.8	-40	-32.67	28	-60.67	0-360
10	23.98928	-2.18	Pk	9.4	-40	-32.78	28	-60.78	0-360
8	23.99591	-5.51	Pk	9.4	-40	-36.11	28	-64.11	0-360

Pk - Peak detector

Configuration 2: Load with 0 mm Spacing

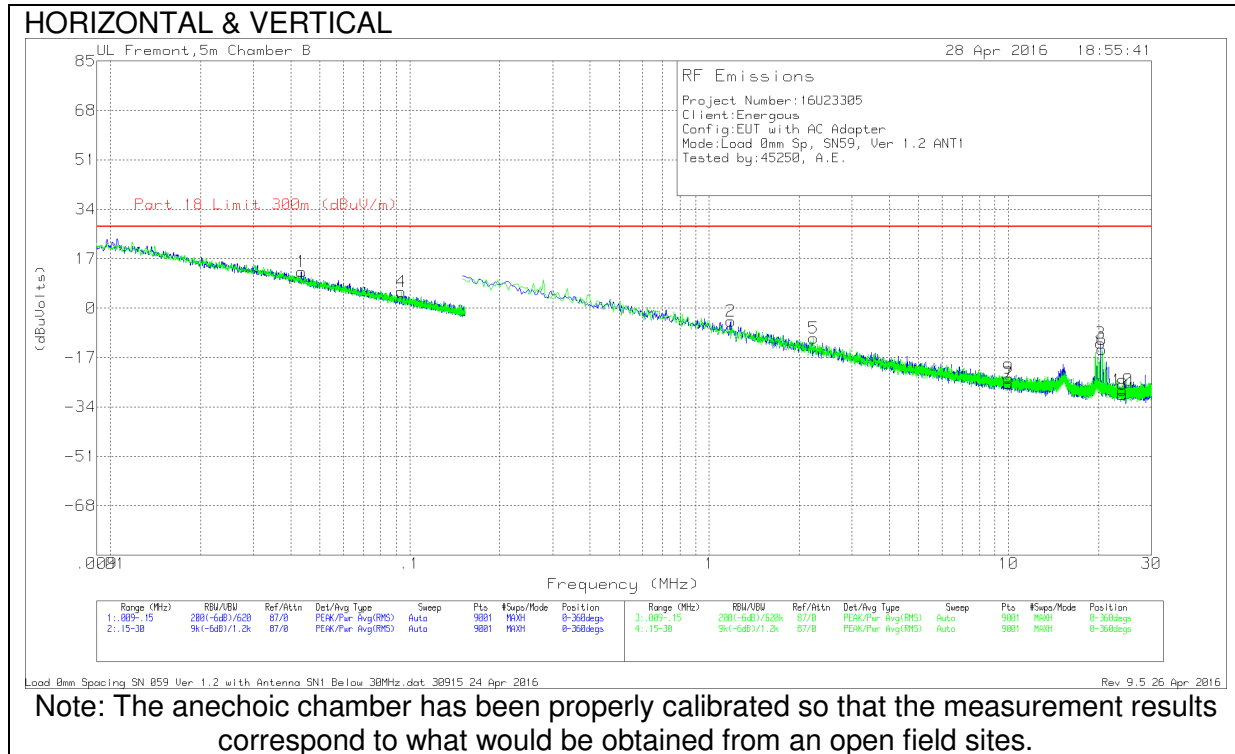

Trace Markers

Marker	Frequency (MHz)	Meter Reading (dBuV)	Det	Loop Antenna (dB/m)	Dist Corr (dB)	Corrected Reading (dBuVolts)	Part 18 Limit 300m (dBuV/m)	Margin (dB)	Azimuth (Degs)
1	.04343	40.79	Pk	11.8	-40	12.59	28	-15.41	0-360
4	.09353	34.65	Pk	10.9	-40	5.55	28	-22.45	0-360
2	1.18159	24.71	Pk	10.7	-40	-4.59	28	-32.59	0-360
5	2.23639	18.8	Pk	10.8	-40	-10.4	28	-38.4	0-360
9	9.99486	5.05	Pk	10.8	-40	-24.15	28	-52.15	0-360
7	10.00149	3.3	Pk	10.8	-40	-25.9	28	-53.9	0-360
3	20.30741	17.98	Pk	10	-40	-12.02	28	-40.02	0-360
6	20.54292	15.74	Pk	10	-40	-14.26	28	-42.26	0-360
8	23.99923	.95	Pk	9.4	-40	-29.65	28	-57.65	0-360
10	23.99923	2.39	Pk	9.4	-40	-28.21	28	-56.21	0-360

Pk - Peak detector

Configuration 3: Load with 2 mm Spacing

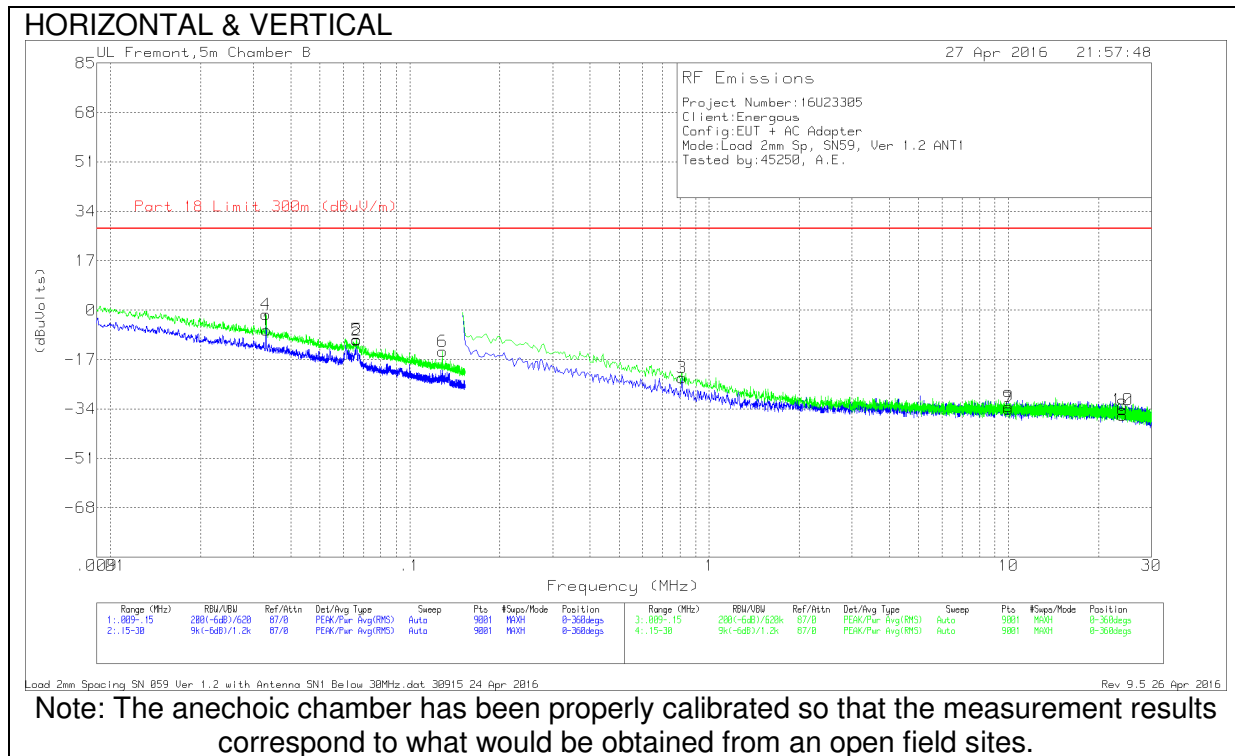

Trace Markers

Marker	Frequency (MHz)	Meter Reading (dBUV)	Det	Loop Antenna (dB/m)	Dist Corr (dB)	Corrected Reading (dBUVolts)	Part 18 Limit 300m (dBUV/m)	Margin (dB)	Azimuth (Degs)
4	.03313	25.76	Pk	12.7	-40	-1.54	28	-29.54	0-360
1	.03319	20.38	Pk	12.7	-40	-6.92	28	-34.92	0-360
5	.06638	18.91	Pk	11	-40	-10.09	28	-38.09	0-360
2	.06642	18.73	Pk	11	-40	-10.27	28	-38.27	0-360
6	.12872	14.91	Pk	10.8	-40	-14.29	28	-42.29	0-360
3	.81008	6.13	Pk	10.6	-40	-23.27	28	-51.27	0-360
9	9.99817	-4.04	Pk	10.8	-40	-33.24	28	-61.24	0-360
7	10.00149	-4.75	Pk	10.8	-40	-33.95	28	-61.95	0-360
8	24.01582	-5.56	Pk	9.4	-40	-36.16	28	-64.16	0-360
10	24.01913	-3.66	Pk	9.4	-40	-34.26	28	-62.26	0-360

Pk - Peak detector

7.3.2. SPURIOUS EMISSIONS 30 - 1000 MHz

Configuration 1: No Load with Magnet

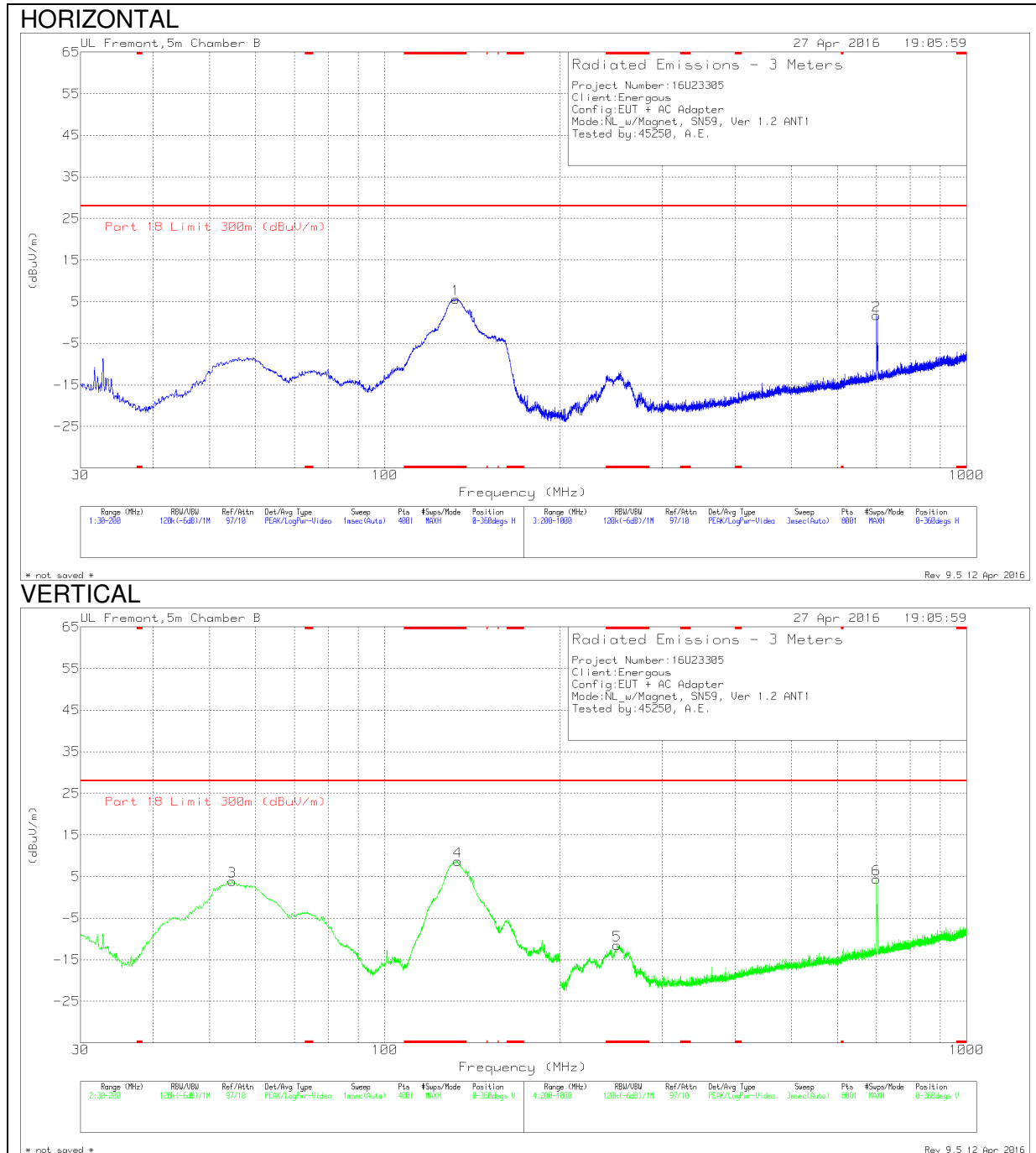

Trace Markers

Marker	Frequency (MHz)	Meter Reading (dBuV)	Det	AF T130 (dB/m)	Amp/Cbl (dB)	Dist Corr (dB)	Corrected Reading (dBuV/m)	Part 18 Limit 300m (dBuV/m)	Margin (dB)	Azimuth (Degs)	Height (cm)	Polarity
1	132.425	55.59	Pk	17.7	-27.7	-40	5.59	28	-22.41	0-360	200	H
4	133.4238	58.84	Pk	17.6	-27.8	-40	8.64	28	-19.36	0-360	100	V
5	250.8	39.64	Pk	15.4	-26.6	-40	-11.56	28	-39.56	0-360	200	V
3	54.6925	61.29	Pk	11.1	-28.5	-40	3.89	28	-24.11	0-360	100	V
2	699.8	42.92	Pk	24.2	-25.4	-40	1.72	28	-26.28	0-360	100	H
6	699.9	45.51	Pk	24.2	-25.4	-40	4.31	28	-23.69	0-360	300	V

Pk - Peak detector

Configuration 2: Load with 0 mm Spacing

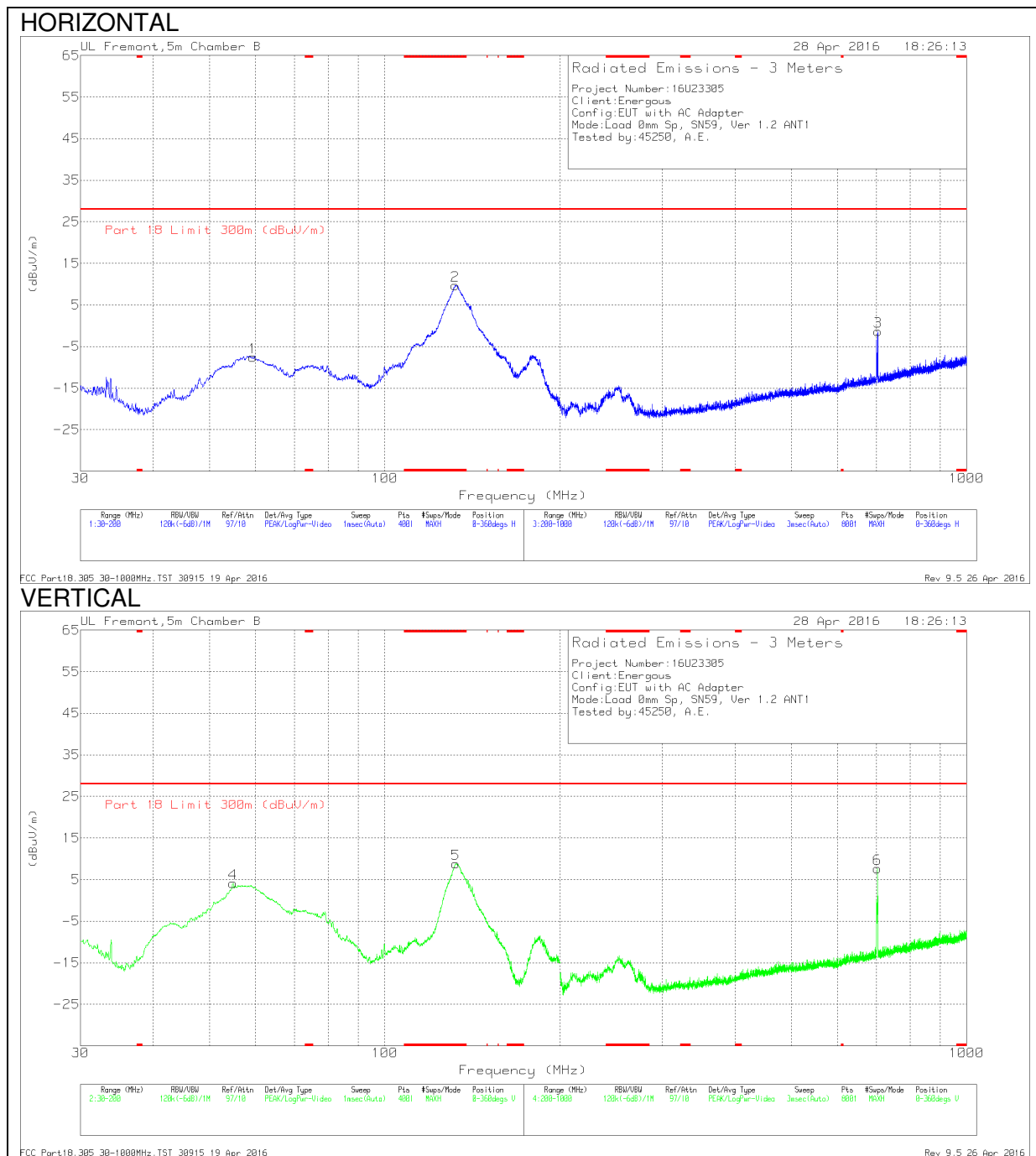

Trace Markers

Marker	Frequency (MHz)	Meter Reading (dBuV)	Det	AF T130 (dB/m)	Amp/Cbl (dB)	Dist Corr (dB)	Corrected Reading (dBuV/m)	Part 18 Limit 300m (dBuV/m)	Margin (dB)	Azimuth (Degs)	Height (cm)	Polarity
2	132.2975	59.66	Pk	17.7	-27.7	-40	9.66	28	-18.34	0-360	200	H
5	132.5525	58.87	Pk	17.6	-27.7	-40	8.77	28	-19.23	0-360	100	V
4	54.8625	61.27	Pk	11.1	-28.3	-40	4.07	28	-23.93	0-360	100	V
1	59.3675	49.44	Pk	11.5	-28.5	-40	-7.56	28	-35.56	0-360	400	H
6	703.1	48.78	Pk	24.2	-25.3	-40	7.68	28	-20.32	0-360	300	V
3	703.5	39.69	Pk	24.2	-25.3	-40	-1.41	28	-29.41	0-360	200	H

Pk - Peak detector

Configuration 3: Load with 2 mm Spacing

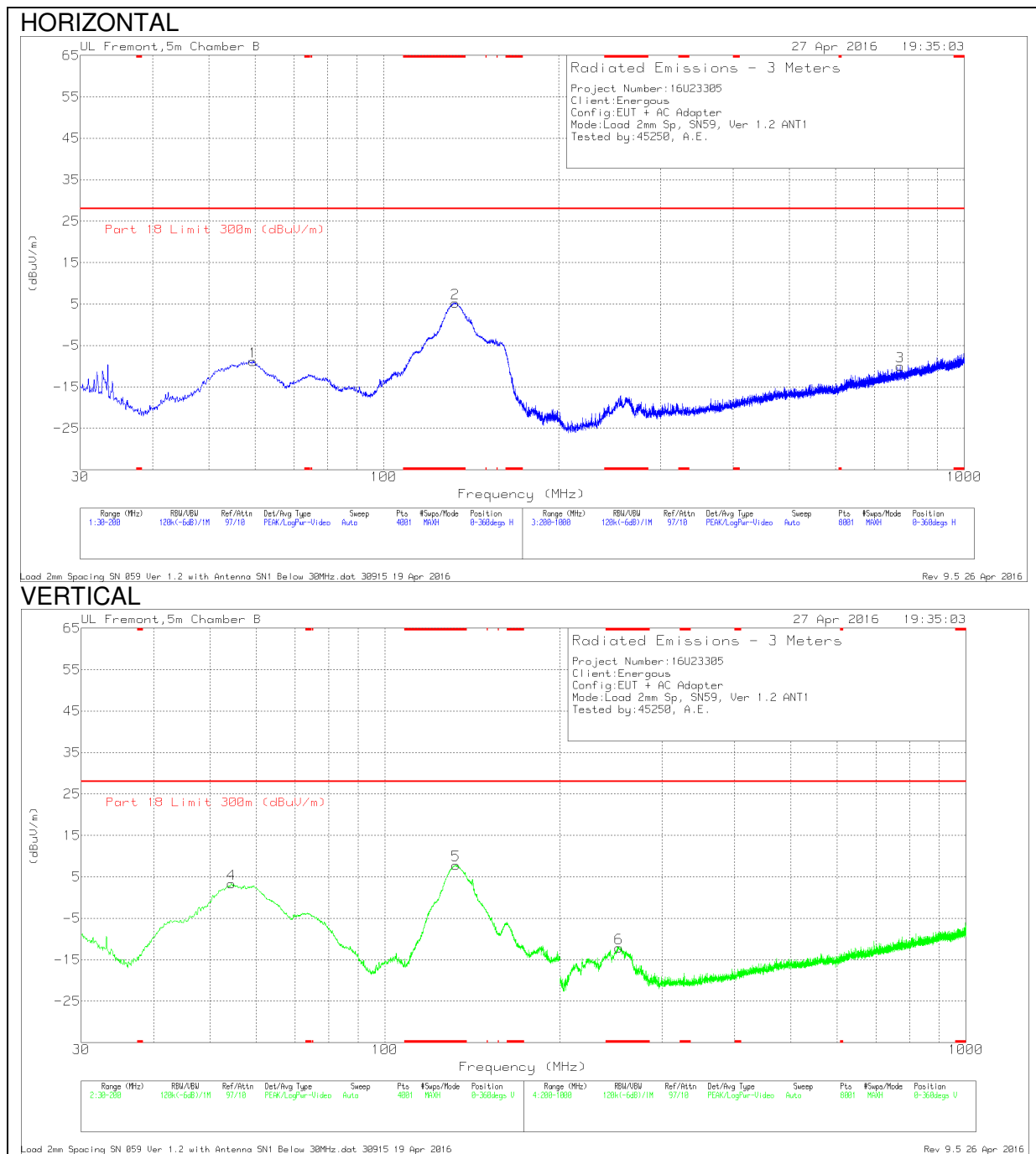

Trace Markers

Marker	Frequency (MHz)	Meter Reading (dBuV)	Det	AF T130 (dB/m)	Amp/Cbl (dB)	Dist Corr (dB)	Corrected Reading (dBuV/m)	Part 18 Limit 300m (dBuV/m)	Margin (dB)	Azimuth (Degs)	Height (cm)	Polarity
2	132.8288	55.45	Pk	17.6	-27.8	-40	5.25	28	-22.75	0-360	200	H
5	132.3825	57.85	Pk	17.7	-27.7	-40	7.85	28	-20.15	0-360	100	V
6	252.9	38.84	Pk	15.5	-26.5	-40	-12.16	28	-40.16	0-360	200	V
4	54.395	60.98	Pk	11	-28.6	-40	3.38	28	-24.62	0-360	100	V
1	59.495	48.17	Pk	11.5	-28.5	-40	-8.83	28	-36.83	0-360	400	H
3	774.8	29.81	Pk	25	-24.8	-40	-9.99	28	-37.99	0-360	300	H

Pk - Peak detector

7.3.3. SPURIOUS EMISSIONS 1 - 18 GHz

Configuration 1: No Load with Magnet

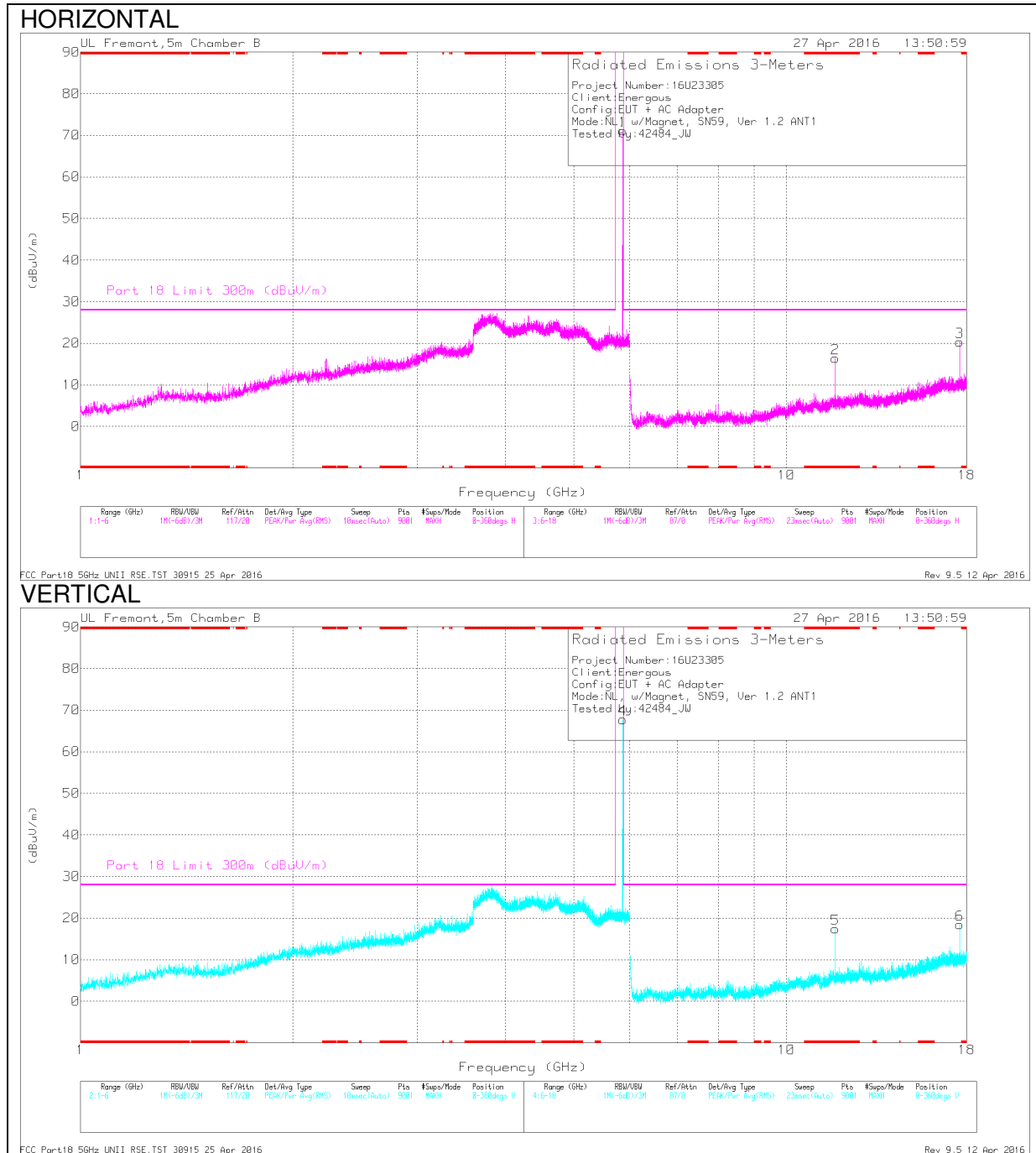

Trace Markers

Marker	Frequency (GHz)	Meter Reading (dBuV)	Det	AF T345 (dB/m)	Amp/Cbl/Filtr/Pad (dB)	Dist Corr (dB)	Corrected Reading (dBuV/m)	Part 18 Limit 300m (dBuV/m)	Margin (dB)	Azimuth (Degs)	Height (cm)	Polarity
2	11.724	43.73	Pk	38.6	-25.9	-40	16.43	28	-11.57	0-360	100	H
5	11.724	44.76	Pk	38.6	-25.9	-40	17.46	28	-10.54	0-360	199	V
1	5.862	97.45	Pk	35.2	-21.5	-40	71.15	-	-	0-360	199	H
4	5.862	93.86	Pk	35.2	-21.3	-40	67.76	-	-	0-360	100	V
3	17.585	41.74	Pk	41.4	-22.8	-40	20.34	28	-7.66	0-360	199	H
6	17.585	39.88	Pk	41.4	-22.8	-40	18.48	28	-9.52	0-360	199	V

Pk - Peak detector

Radiated Emissions

Frequency (GHz)	Meter Reading (dBuV)	Det	AF T345 (dB/m)	Amp/Cbl/Filtr/Pad (dB)	Dist Corr (dB)	Corrected Reading (dBuV/m)	Part 18 Limit 300m (dBuV/m)	Margin (dB)	Azimuth (Degs)	Height (cm)	Polarity
11.724	43.65	ADR	38.6	-25.9	-40	16.35	28	-11.65	213	172	H
11.724	47.27	ADR	38.6	-25.9	-40	20.97	28	-8.03	10	342	V
5.862	97.91	ADR	35.2	-21.4	-40	71.71	-	-	224	240	H
5.862	93.84	ADR	35.2	-21.4	-40	67.64	-	-	6	371	V
17.586	39.47	ADR	41.4	-22.8	-40	18.07	28	-9.93	122	171	H
17.586	39.95	ADR	41.4	-22.8	-40	18.55	28	-9.45	119	392	V

ADR - RMS average

Configuration 2: Load with 0 mm Spacing

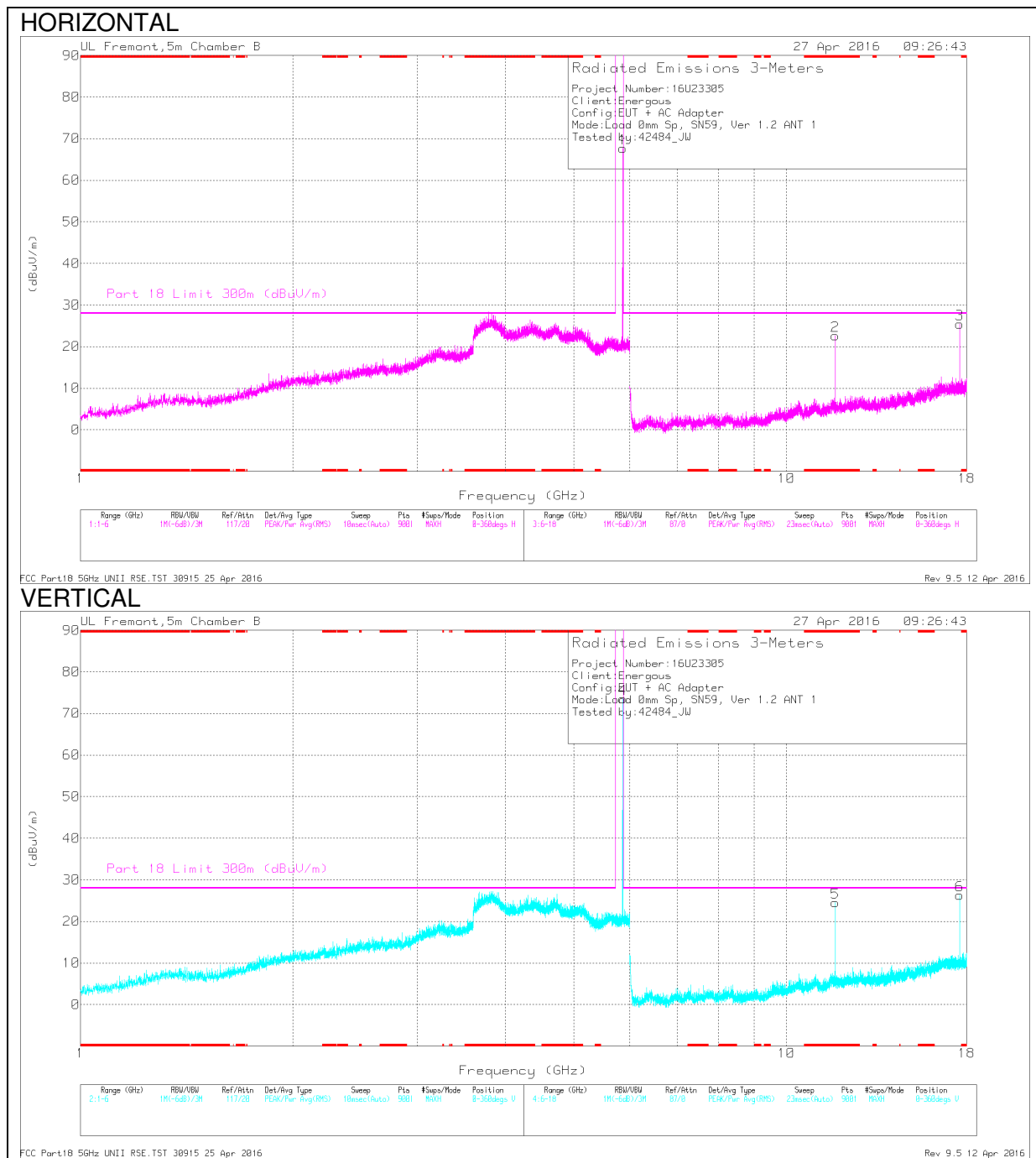

Trace Markers

Marker	Frequency (GHz)	Meter Reading (dBuV)	Det	AF T345 (dB/m)	Amp/Cbl/Filtr/Pad (dB)	Dist Corr (dB)	Corrected Reading (dBuV/m)	Part 18 Limit 300m (dBuV/m)	Margin (dB)	Azimuth (Degs)	Height (cm)	Polarity
2	11.724	49.97	Pk	38.6	-25.9	-40	22.67	28	-5.33	0-360	199	H
5	11.724	51.78	Pk	38.6	-25.9	-40	24.48	28	-3.52	0-360	199	V
1	5.862	94.04	Pk	35.2	-21.5	-40	67.74	-	-	0-360	199	H
4	5.862	99.64	Pk	35.2	-21.3	-40	73.54	-	-	0-360	199	V
3	17.585	46.81	Pk	41.4	-22.8	-40	25.41	28	-2.59	0-360	199	H
6	17.585	47.73	Pk	41.4	-22.8	-40	26.33	28	-1.67	0-360	199	V

Pk - Peak detector

Radiated Emissions

Frequency (GHz)	Meter Reading (dBuV)	Det	AF T345 (dB/m)	Amp/Cbl/Filtr/Pad (dB)	Dist Corr (dB)	Corrected Reading (dBuV/m)	Part 18 Limit 300m (dBuV/m)	Margin (dB)	Azimuth (Degs)	Height (cm)	Polarity
11.724	49.4	ADR	38.6	-25.9	-40	22.1	28	-5.9	123	256	H
11.724	52.23	ADR	38.6	-25.9	-40	24.93	28	-3.07	344	245	V
5.862	94.68	ADR	35.2	-21.4	-40	68.48	-	-	179	229	H
5.862	100.61	ADR	35.2	-21.4	-40	74.41	-	-	19	356	V
17.586	44.86	ADR	41.4	-22.8	-40	23.46	28	-4.54	148	387	H
17.586	47.49	ADR	41.4	-22.8	-40	26.09	28	-1.91	266	359	V

ADR - RMS average

Configuration 3: Load with 2 mm Spacing

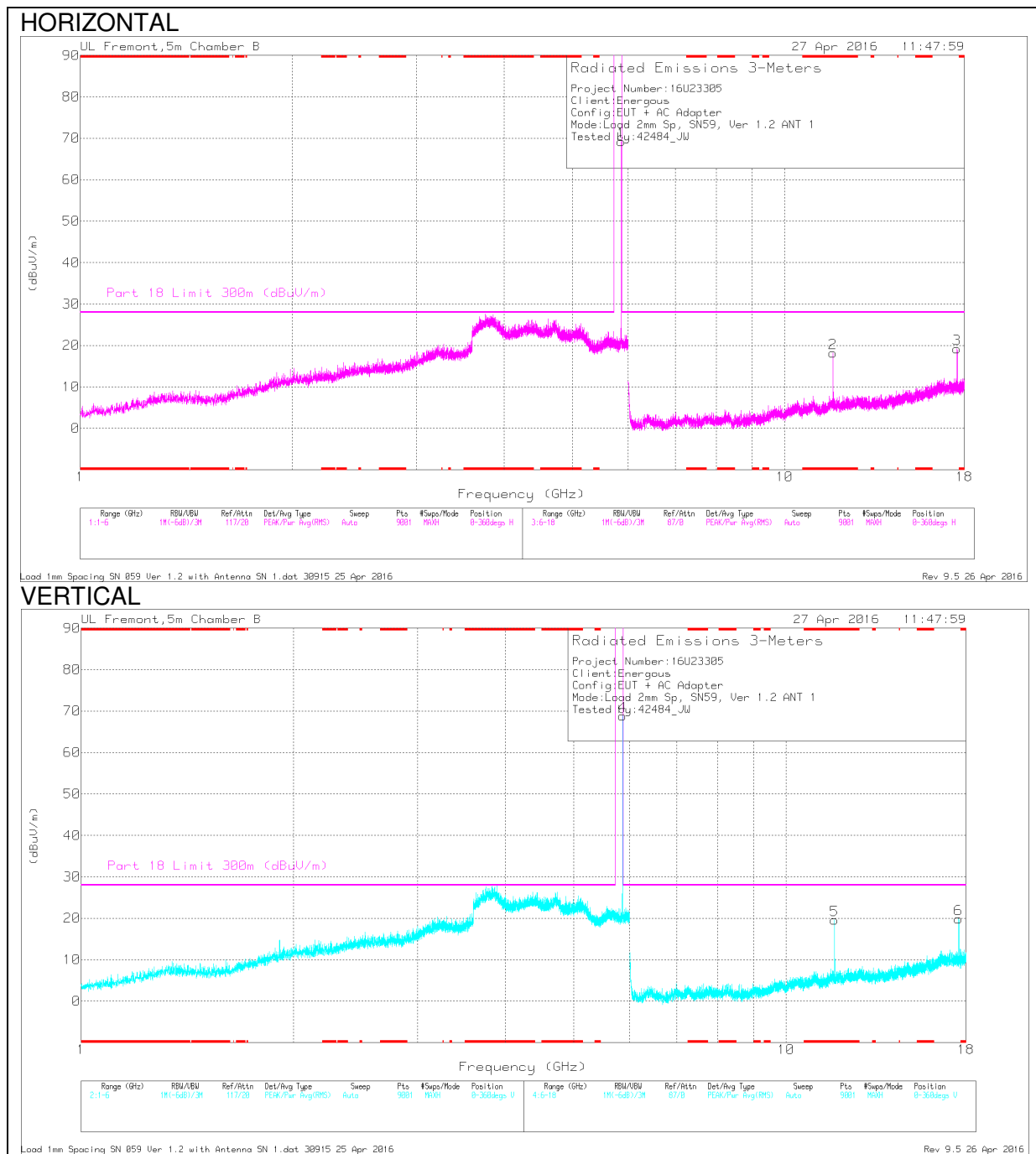

Trace Markers

Marker	Frequency (GHz)	Meter Reading (dBuV)	Det	AF T345 (dB/m)	Amp/Cbl/Filtr/Pad (dB)	Dist Corr (dB)	Corrected Reading (dBuV/m)	Part 18 Limit 300m (dBuV/m)	Margin (dB)	Azimuth (Degs)	Height (cm)	Polarity
2	11.724	45.51	Pk	38.6	-25.9	-40	18.21	28	-9.79	0-360	199	H
5	11.724	46.92	Pk	38.6	-25.9	-40	19.62	28	-8.38	0-360	199	V
1	5.862	95.51	Pk	35.2	-21.5	-40	69.21	-	-	0-360	255	H
4	5.862	94.88	Pk	35.2	-21.3	-40	68.78	-	-	0-360	101	V
3	17.585	40.62	Pk	41.4	-22.8	-40	19.22	28	-8.78	0-360	199	H
6	17.585	41.25	Pk	41.4	-22.8	-40	19.85	28	-8.15	0-360	199	V

Pk - Peak detector

Radiated Emissions

Frequency (GHz)	Meter Reading (dBuV)	Det	AF T345 (dB/m)	Amp/Cbl/Filtr/Pad (dB)	Dist Corr (dB)	Corrected Reading (dBuV/m)	Part 18 Limit 300m (dBuV/m)	Margin (dB)	Azimuth (Degs)	Height (cm)	Polarity
11.724	44.35	ADR	38.6	-25.9	-40	17.05	28	-10.95	0	165	H
11.724	49.05	ADR	38.6	-25.9	-40	21.75	28	-6.25	16	307	V
5.862	95.8	ADR	35.2	-21.4	-40	69.6	-	-	225	241	H
5.862	95.09	ADR	35.2	-21.4	-40	68.89	-	-	8	381	V
17.586	40.81	ADR	41.4	-22.8	-40	19.41	28	-8.59	143	152	H
17.586	41.22	ADR	41.4	-22.8	-40	19.82	28	-8.18	119	382	V

ADR - RMS average

7.3.4. SPURIOUS EMISSIONS 18 - 26 GHz

Configuration 1: No Load with Magnet

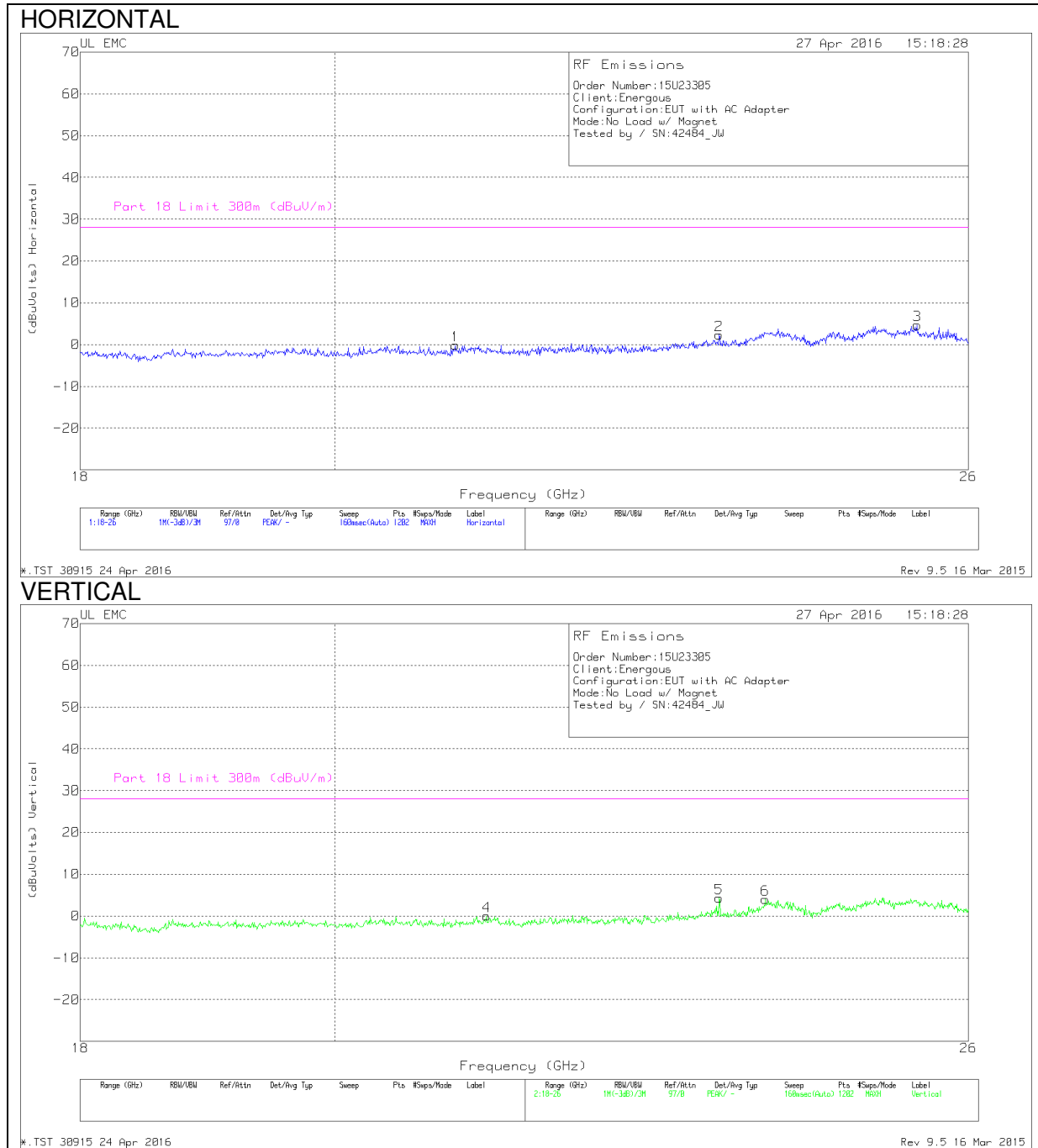

Trace Markers

Marker	Frequency (GHz)	Meter Reading (dBuV)	Det	T477 AF (dB/m)	Amp/Cbl (dB)	Dist Corr (dB)	Corrected Reading (dBuV/m)	Part 18 Limit 300m (dBuV/m)	Margin (dB)
1	21.024	41.83	Pk	32.9	-25.4	-49.5	-.17	28	-28.17
2	23.449	42.63	Pk	33.9	-24.7	-49.5	2.33	28	-25.67
3	25.454	44.47	Pk	34.2	-24.5	-49.5	4.67	28	-23.33
4	21.297	42	Pk	33	-25.5	-49.5	0	28	-28
5	23.449	44.63	Pk	33.9	-24.7	-49.5	4.33	28	-23.67
6	23.902	43.7	Pk	33.7	-23.9	-49.5	4	28	-24

Pk - Peak detector

Configuration 2: Load with 0 mm Spacing

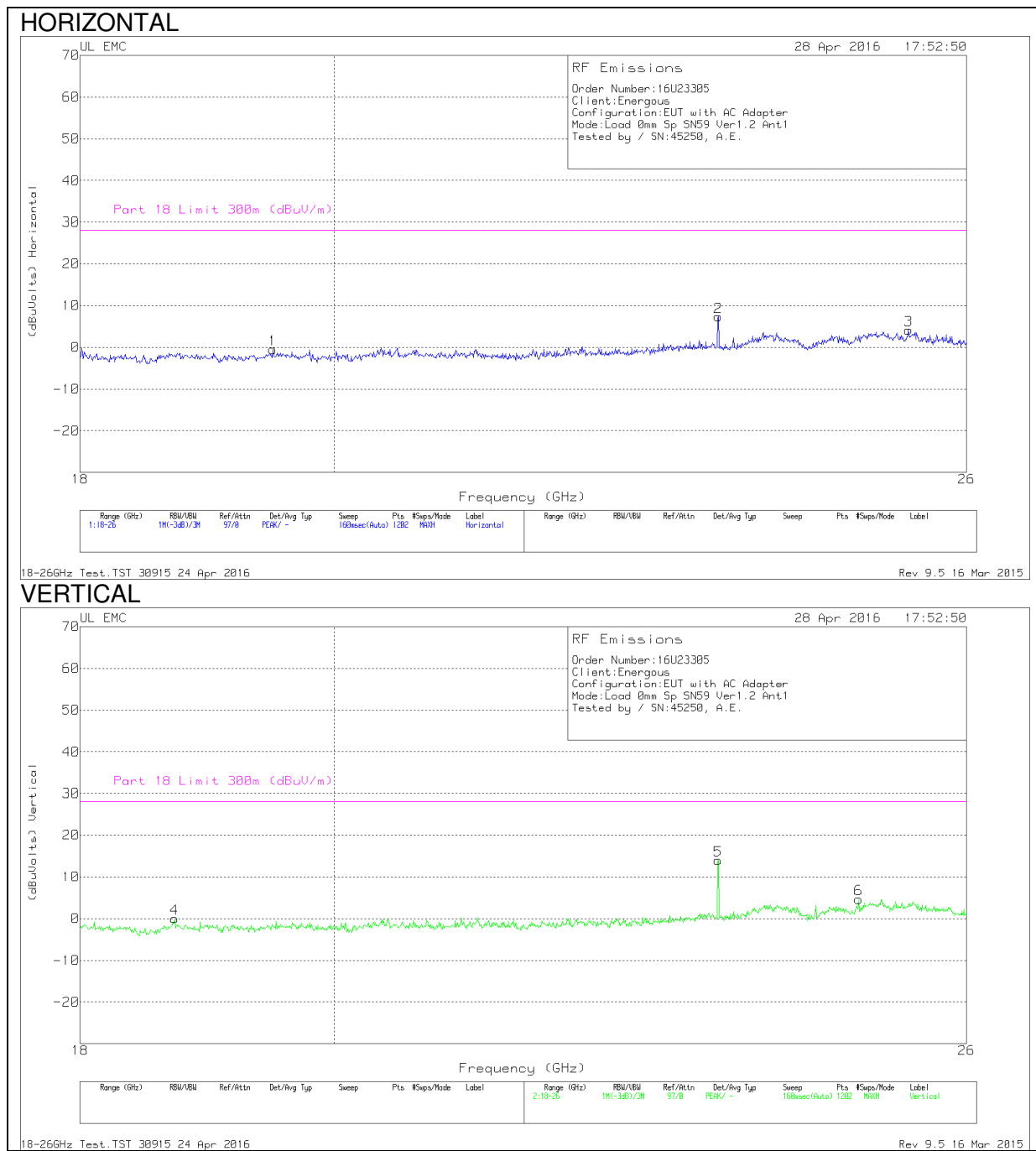

Trace Markers

Marker	Frequency (GHz)	Meter Reading (dBuV)	Det	T477 AF (dB/m)	Amp/Cbl (dB)	Dist Corr (dB)	Corrected Reading (dBuV/m)	Part 18 Limit 300m (dBuV/m)	Margin (dB)
1	19.499	41.5	Pk	32.6	-25.1	-49.5	-.5	28	-28.5
2	23.455	47.73	Pk	33.9	-24.8	-49.5	7.33	28	-20.67
3	25.381	43.97	Pk	34.2	-24.5	-49.5	4.17	28	-23.83
4	18.719	41.9	Pk	32.3	-24.7	-49.5	0	28	-28
5	23.452	54.3	Pk	33.9	-24.7	-49.5	14	28	-14
6	24.861	44.57	Pk	34	-24.4	-49.5	4.67	28	-23.33

Pk - Peak detector

Configuration 3: Load with 2 mm Spacing

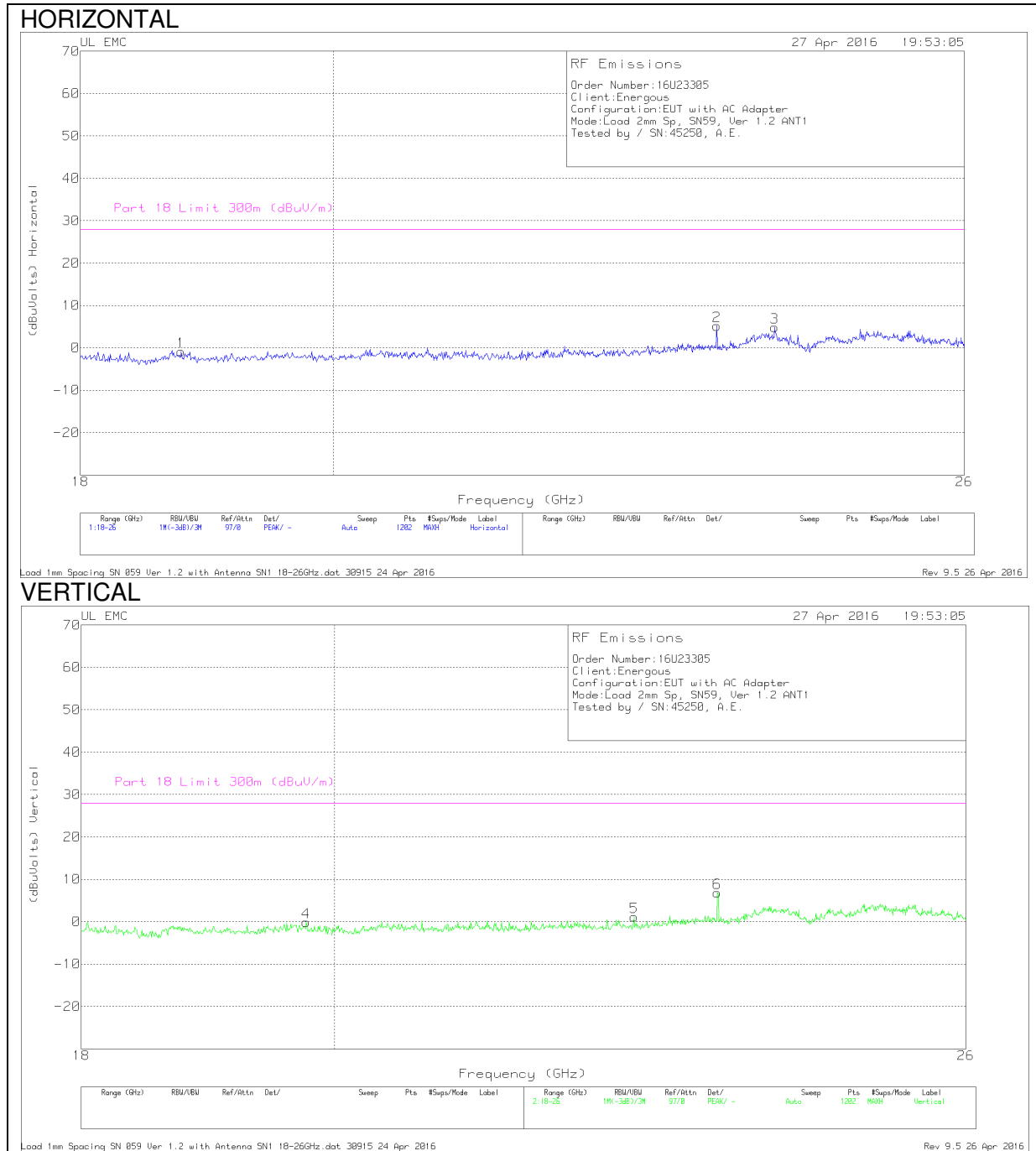

Trace Markers

Marker	Frequency (GHz)	Meter Reading (dBuV)	Det	T477 AF (dB/m)	Amp/Cbl (dB)	Dist Corr (dB)	Corrected Reading (dBuV/m)	Part 18 Limit 300m (dBuV/m)	Margin (dB)
1	18.773	41.47	Pk	32.3	-25.1	-49.5	-.833	28	-28.83
2	23.455	45.57	Pk	33.9	-24.8	-49.5	5.17	28	-22.83
3	24.028	44.83	Pk	33.6	-24.1	-49.5	4.83	28	-23.17
4	19.765	41.33	Pk	32.8	-24.8	-49.5	-.167	28	-28.17
5	22.649	42.37	Pk	33.4	-25.1	-49.5	1.17	28	-26.83
6	23.449	47.13	Pk	33.9	-24.7	-49.5	6.83	28	-21.17

Pk - Peak detector

7.3.5. SPURIOUS EMISSIONS 26 - 40 GHz

Configuration 1: No Load with Magnet

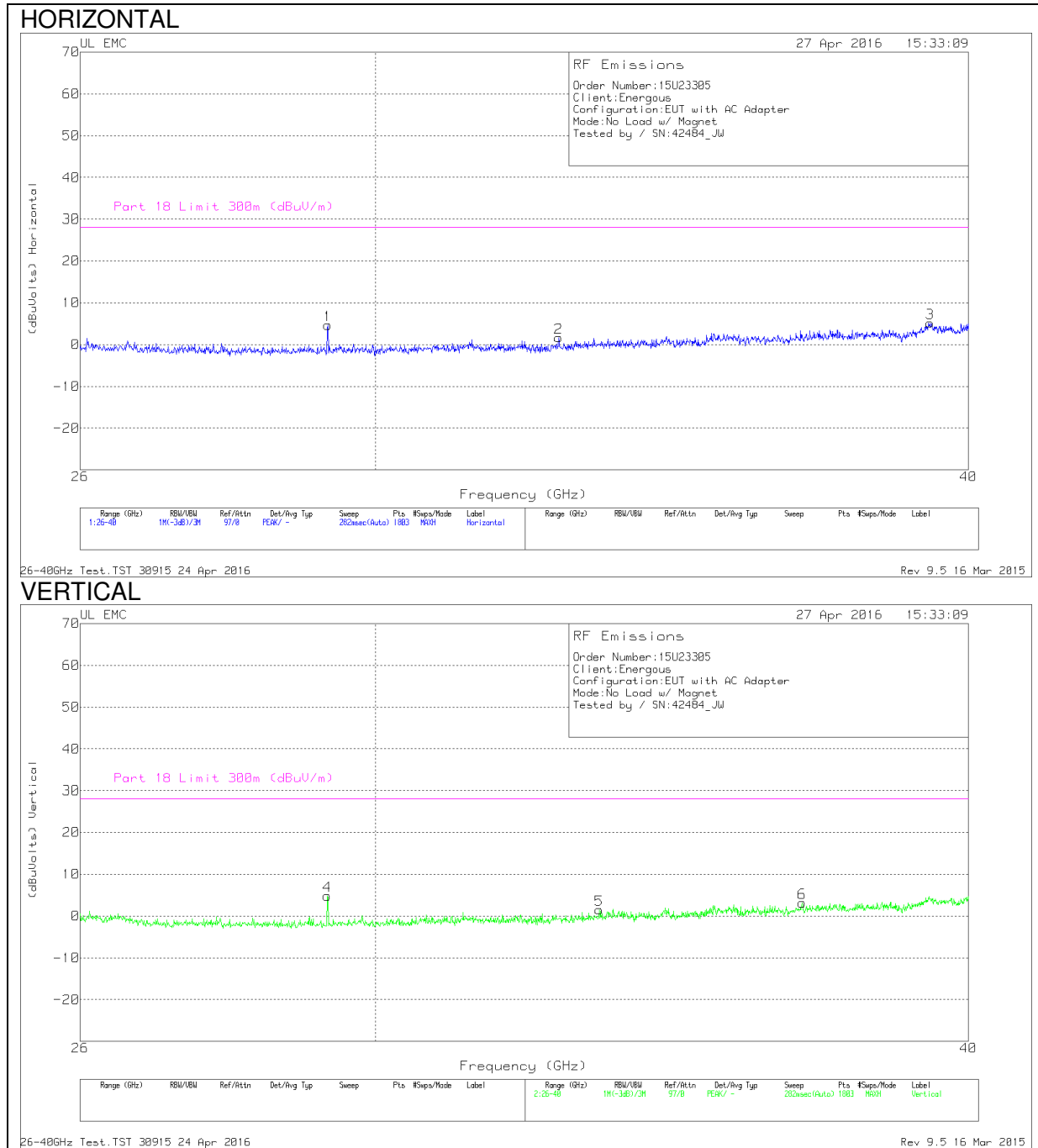

Trace Markers

Marker	Frequency (GHz)	Meter Reading (dBuV)	Det	T90 AF (dB/m)	Amp/Cbl (dB)	Dist Corr (dB)	Corrected Reading (dBuV/m)	Part 18 Limit 300m (dBuV/m)	Margin (dB)
1	29.317	50.97	Pk	35.9	-32.7	-49.5	4.67	28	-23.33
2	32.79	48.07	Pk	36.6	-33.5	-49.5	1.67	28	-26.33
3	39.262	48.47	Pk	38.6	-32.4	-49.5	5.17	28	-22.83
4	29.31	51.13	Pk	35.9	-32.7	-49.5	4.83	28	-23.17
5	33.443	47.4	Pk	37.1	-33.5	-49.5	1.5	28	-26.5
6	36.9	50.07	Pk	37.2	-34.6	-49.5	3.17	28	-24.83

Pk - Peak detector

Configuration 2: Load with 0 mm Spacing

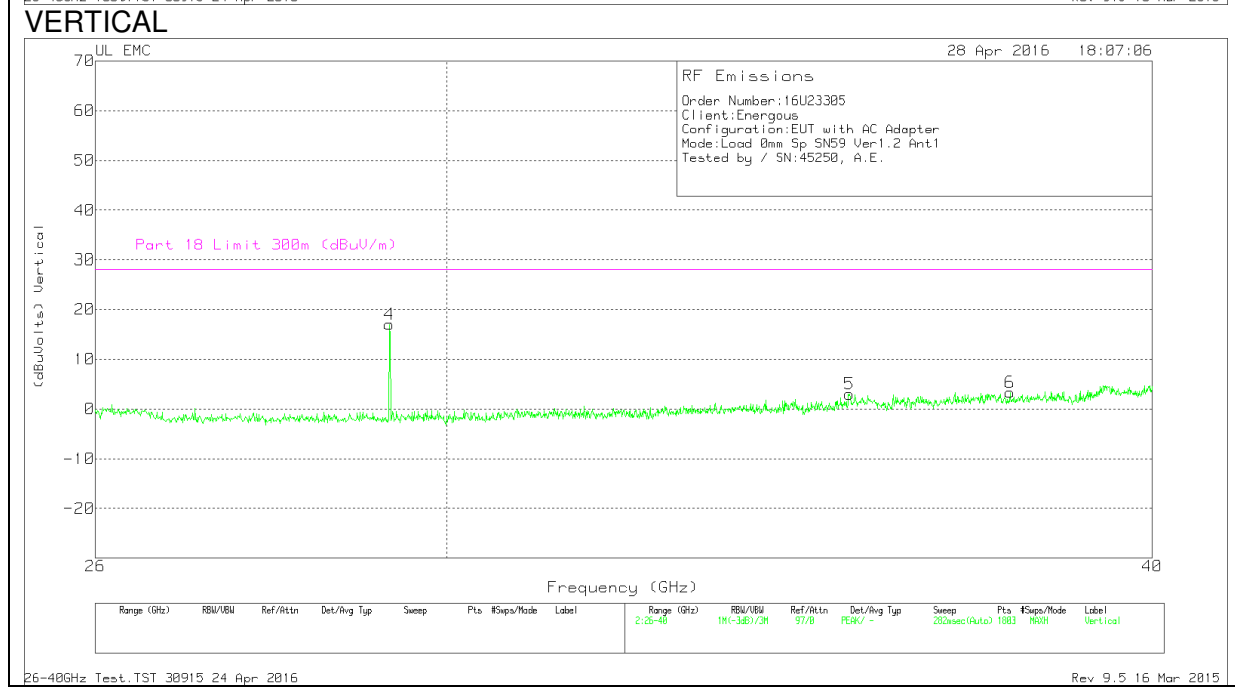
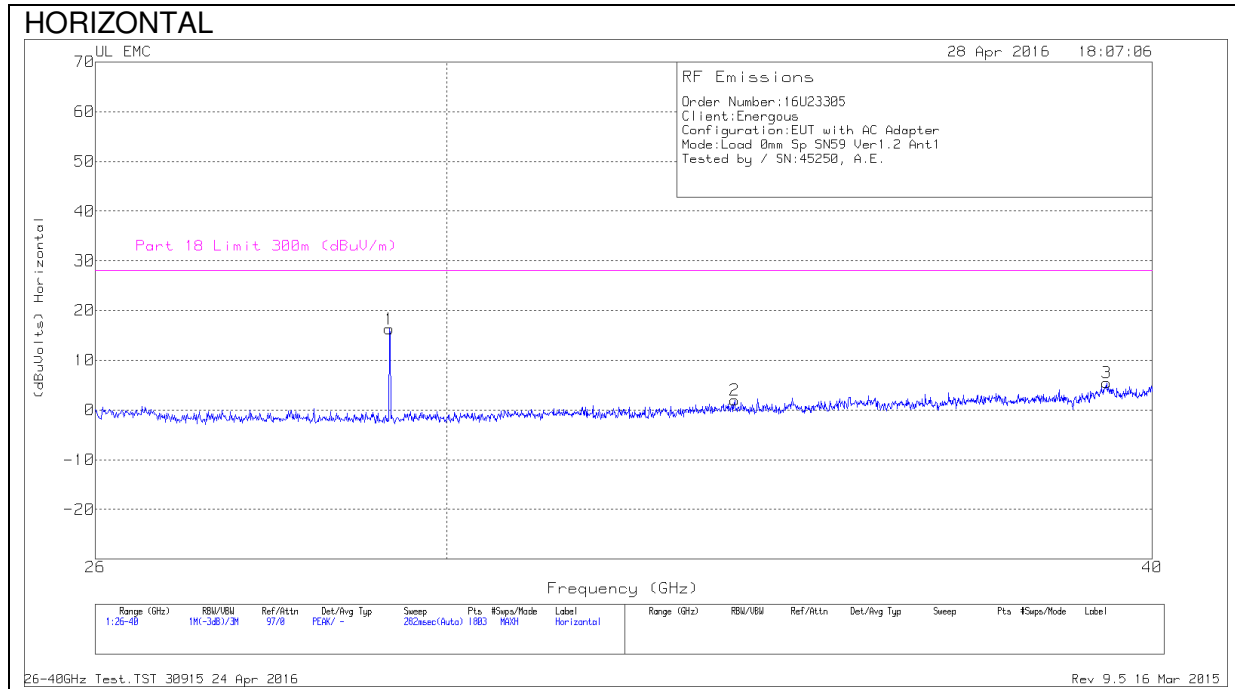

Trace Markers

Marker	Frequency (GHz)	Meter Reading (dBuV)	Det	T90 AF (dB/m)	Amp/Cbl (dB)	Dist Corr (dB)	Corrected Reading (dBuV/m)	Part 18 Limit 300m (dBuV/m)	Margin (dB)
1	29.31	62.63	Pk	35.9	-32.7	-49.5	16.33	28	-11.67
2	33.738	48.1	Pk	36.8	-33.4	-49.5	2	28	-26
3	39.262	48.8	Pk	38.6	-32.4	-49.5	5.5	28	-22.5
4	29.31	63.3	Pk	35.9	-32.7	-49.5	17	28	-11
5	35.354	48.3	Pk	37.8	-33.6	-49.5	3	28	-25
6	37.747	49.93	Pk	37	-34.1	-49.5	3.33	28	-24.67

Pk - Peak detector

Configuration 3: Load with 2 mm Spacing

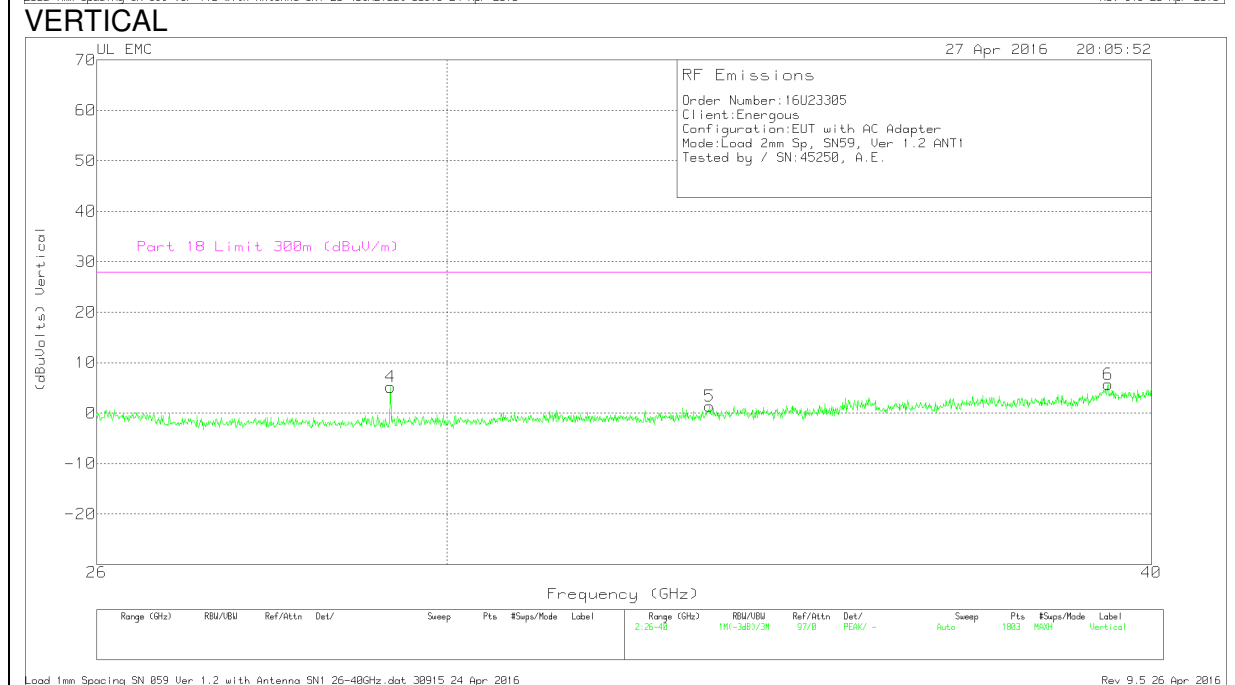

Trace Markers

Marker	Frequency (GHz)	Meter Reading (dBuV)	Det	T90 AF (dB/m)	Amp/Cbl (dB)	Dist Corr (dB)	Corrected Reading (dBuV/m)	Part 18 Limit 300m (dBuV/m)	Margin (dB)
1	29.31	50.47	Pk	35.9	-32.7	-49.5	4.17	28	-23.83
2	34.165	49.1	Pk	36.9	-33.5	-49.5	3	28	-25
3	38.671	49.57	Pk	36.8	-33.2	-49.5	3.67	28	-24.33
4	29.317	51.47	Pk	35.9	-32.7	-49.5	5.17	28	-22.83
5	33.396	47.33	Pk	37	-33.5	-49.5	1.33	28	-26.67
6	39.301	49.37	Pk	38.3	-32.5	-49.5	5.67	28	-22.33

Pk - Peak detector

7.3.6. SPURIOUS EMISSIONS 40 - 50 GHz

No emissions observed above noise floor in any of the Configurations.

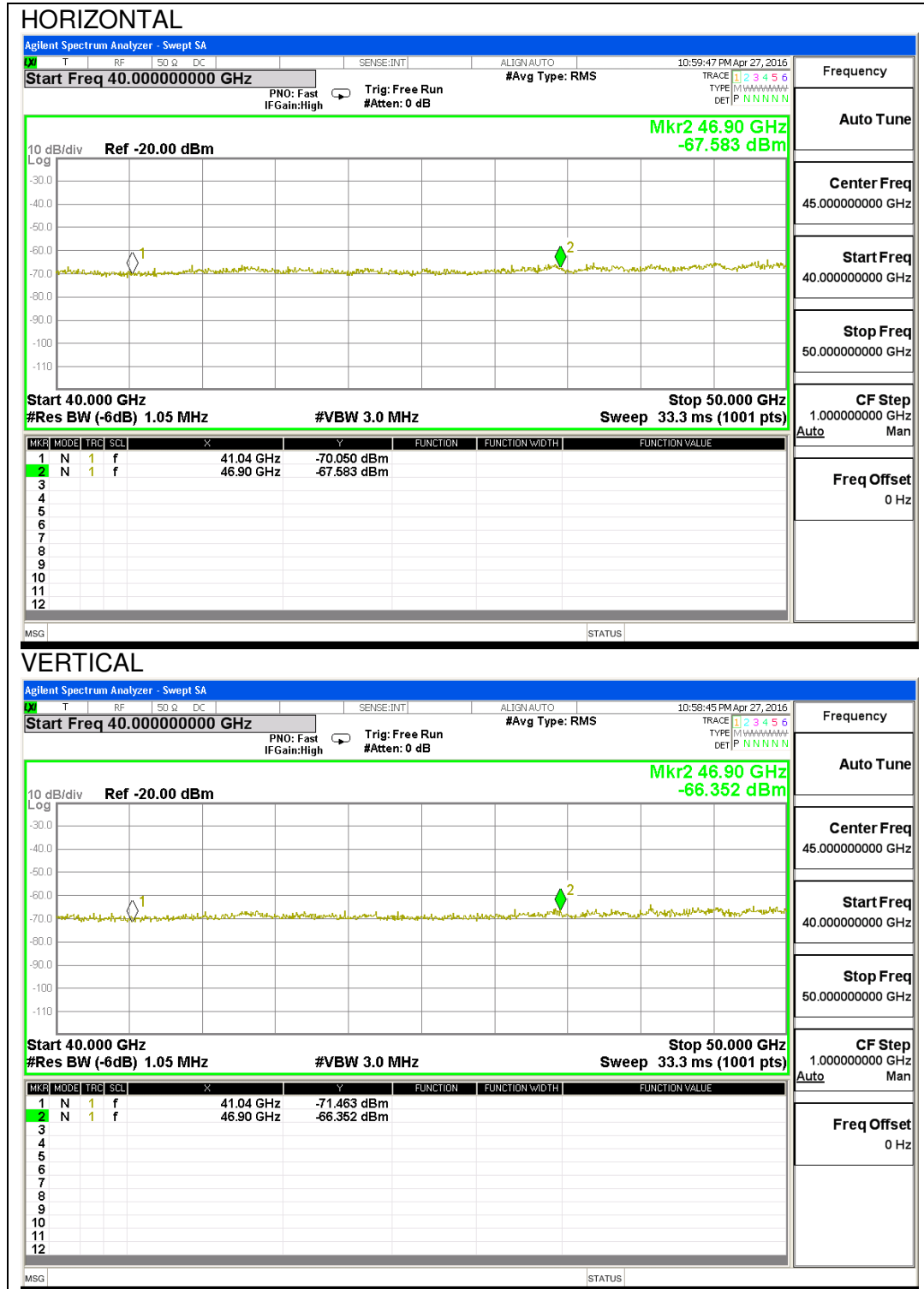

Noise floor / Emissions levels at harmonics of fundamental; peak levels compared to average limits.

7th Harmonic

Horizontal

Frequency (GHz)	Measurement Distance (m)	Peak Power (dBm)	Antenna Assy Gain (dBi)	EIRP (dBm)
41.04	1.0	-70.05	48.86	-54.2
Field Strength (dBuV/m @ 3 m)	Specification Distance (m)	Field Strength (dBuV/m @ 300 m)	F.S. Limit (dBuV/m @ 300 m)	Margin (dB)
41.0	300	0.99	27.96	-26.97

8th Harmonic

Horizontal

Frequency (GHz)	Measurement Distance (m)	Peak Power (dBm)	Antenna Assy Gain (dBi)	EIRP (dBm)
46.09	1.0	-67.58	48.41	-50.3
Field Strength (dBuV/m @ 3 m)	Specification Distance (m)	Field Strength (dBuV/m @ 300 m)	F.S. Limit (dBuV/m @ 300 m)	Margin (dB)
44.9	300	4.92	27.96	-23.04

7th Harmonic

Vertical

Frequency (GHz)	Measurement Distance (m)	Peak Power (dBm)	Antenna Assy Gain (dBi)	EIRP (dBm)
41.04	1.0	-71.46	48.86	-55.6
Field Strength (dBuV/m @ 3 m)	Specification Distance (m)	Field Strength (dBuV/m @ 300 m)	F.S. Limit (dBuV/m @ 300 m)	Margin (dB)
39.6	300	-0.42	27.96	-28.38

8th Harmonic

Vertical

Frequency (GHz)	Measurement Distance (m)	Peak Power (dBm)	Antenna Assy Gain (dBi)	EIRP (dBm)
46.09	1.0	-66.35	48.41	-49.1
Field Strength (dBuV/m @ 3 m)	Specification Distance (m)	Field Strength (dBuV/m @ 300 m)	F.S. Limit (dBuV/m @ 300 m)	Margin (dB)
46.1	300	6.15	27.96	-21.81

7.3.7. SPURIOUS EMISSIONS 50 - 60 GHz

No emissions observed above noise floor in any of the Configurations.

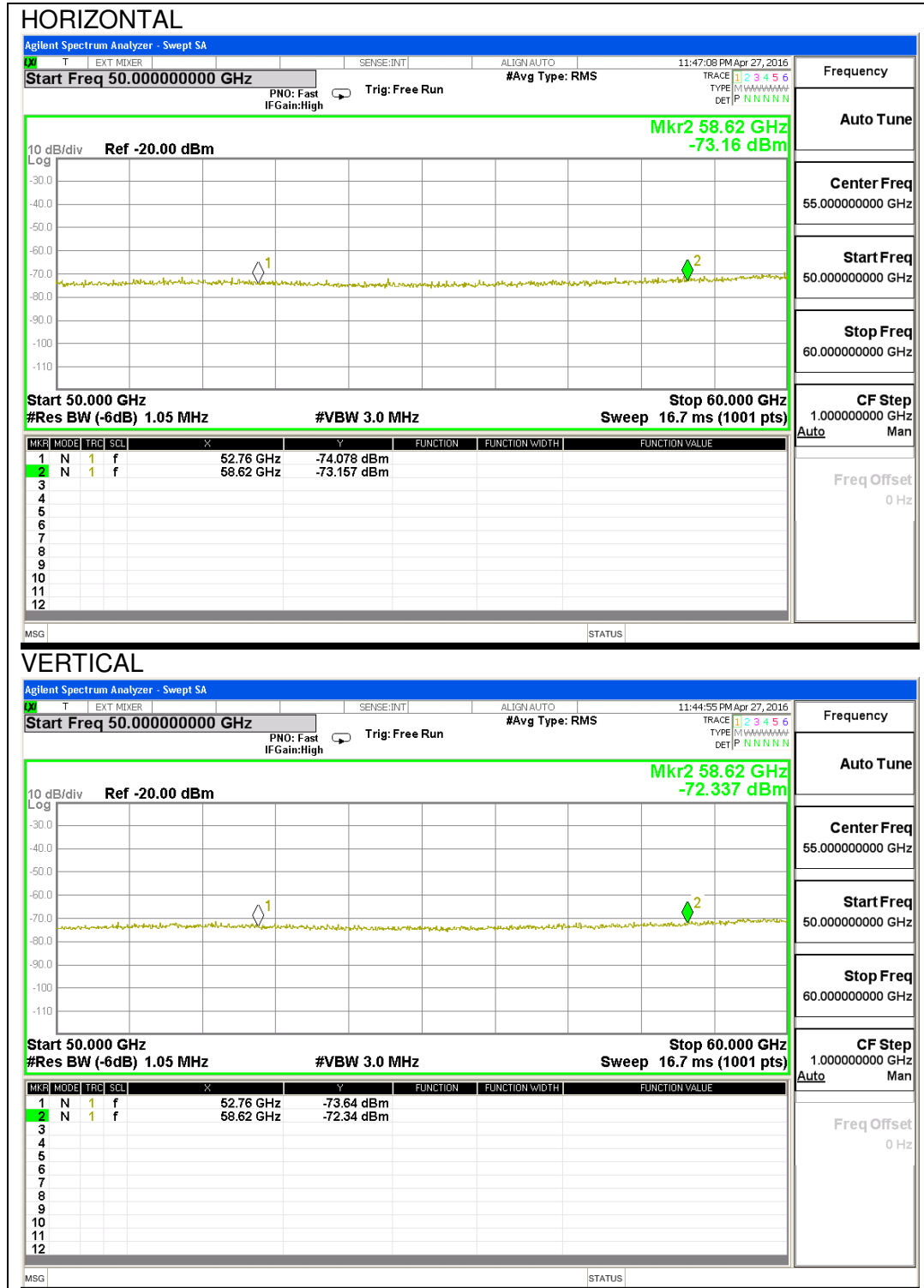

Noise floor / Emissions levels at harmonics of fundamental; peak levels compared to average limits.

9th Harmonic

Horizontal

Frequency (GHz)	Measurement Distance (m)	Peak Power (dBm)	Antenna Assy Gain (dBi)	EIRP (dBm)
52.76	1.0	-74.08	40.44	-47.6
Field Strength (dBuV/m @ 3 m)	Specification Distance (m)	Field Strength (dBuV/m @ 300 m)	F.S. Limit (dBuV/m @ 300 m)	Margin (dB)
47.6	300	7.56	27.96	-20.40

10th Harmonic

Horizontal

Frequency (GHz)	Measurement Distance (m)	Peak Power (dBm)	Antenna Assy Gain (dBi)	EIRP (dBm)
58.62	1.0	-73.16	40.49	-45.9
Field Strength (dBuV/m @ 3 m)	Specification Distance (m)	Field Strength (dBuV/m @ 300 m)	F.S. Limit (dBuV/m @ 300 m)	Margin (dB)
49.3	300	9.35	27.96	-18.61

9th Harmonic

Vertical

Frequency (GHz)	Measurement Distance (m)	Peak Power (dBm)	Antenna Assy Gain (dBi)	EIRP (dBm)
52.76	1.0	-73.64	40.44	-47.2
Field Strength (dBuV/m @ 3 m)	Specification Distance (m)	Field Strength (dBuV/m @ 300 m)	F.S. Limit (dBuV/m @ 300 m)	Margin (dB)
48.0	300	8.00	27.96	-19.96

10th Harmonic

Vertical

Frequency (GHz)	Measurement Distance (m)	Peak Power (dBm)	Antenna Assy Gain (dBi)	EIRP (dBm)
58.62	1.0	-72.34	40.49	-45.0
Field Strength (dBuV/m @ 3 m)	Specification Distance (m)	Field Strength (dBuV/m @ 300 m)	F.S. Limit (dBuV/m @ 300 m)	Margin (dB)
50.2	300	10.17	27.96	-17.79

7.4. AC MAINS LINE CONDUCTED EMISSIONS

LIMIT

§ 18.307 For the following equipment, when designed to be connected to the public utility (AC) power line the radio frequency voltage that is conducted back onto the AC power line on any frequency or frequencies shall not exceed the limits in the following table. Compliance with the provisions of this paragraph shall be based on the measurements of the radio frequency voltage between each power line and ground at the power terminal using a 50 μ H/50 ohms line impedance stabilization network (LISN).

§ 18.307 (b) All other Part 18 consumer devices:

Frequency range (MHz)	Limits (dB μ V)	
	Quasi-peak	Average
0.15 to 0.50	66 to 56*	56 to 46*
0.50 to 5	56	46
5 to 30	60	50

* Decreases with the logarithm of the frequency.

TEST PROCEDURE

FCC / OST MP-5

RESULTS

No non-compliance noted:

Configuration 1: No Load with Magnet

LINE 1 PLOT

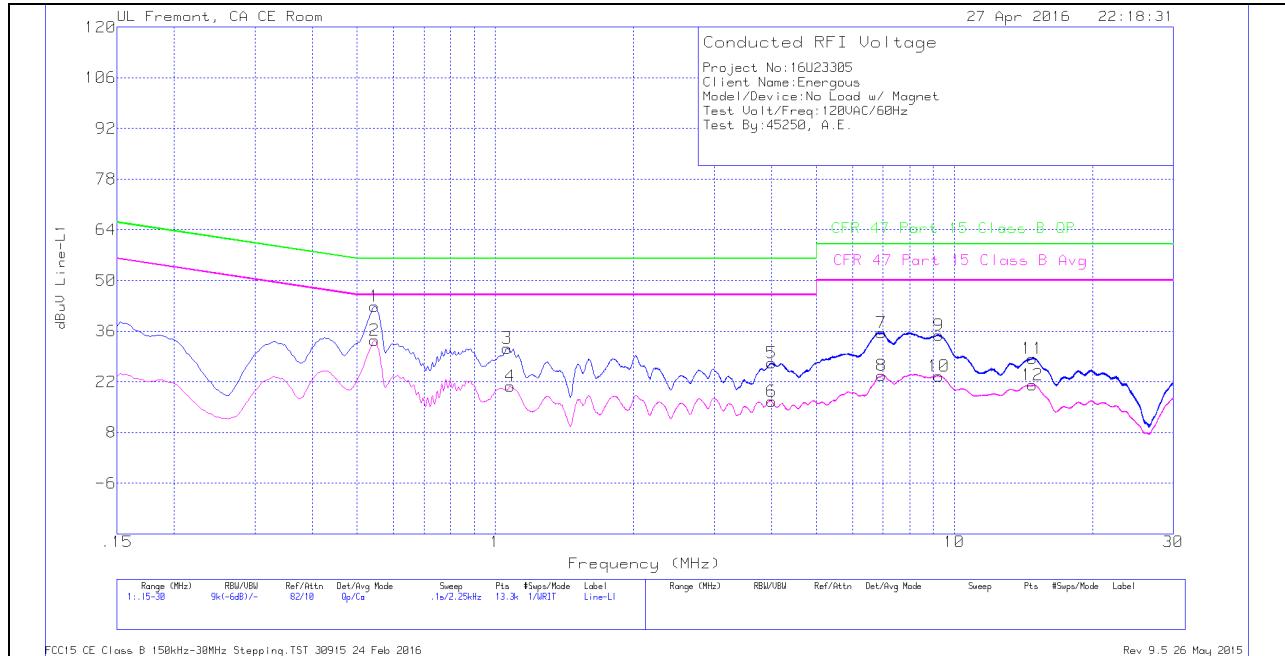

LINE 1 RESULTS

Range 1: Line-L1 .15 - 30MHz

Marker	Frequency (MHz)	Meter Reading (dBuV)	Det	T24 IL L1	LC Cables 1&3	Limiter (dB)	Corrected Reading dBuV	CFR 47 Part 15 Class B QP	QP Margin (dB)	CFR 47 Part 15 Class B Avg	Av(CISPR) Margin (dB)
1	.546	32.55	Qp	.3	0	10.1	42.95	56	-13.05	-	-
2	.546	23.03	Ca	.3	0	10.1	33.43	-	-	46	-12.57
3	1.06125	20.91	Qp	.3	0	10.1	31.31	56	-24.69	-	-
4	1.077	10.47	Ca	.3	0	10.1	20.87	-	-	46	-25.13
5	4.00425	16.79	Qp	.2	.1	10.1	27.19	56	-28.81	-	-
6	4.00425	6.15	Ca	.2	.1	10.1	16.55	-	-	46	-29.45
7	6.936	25.1	Qp	.2	.1	10.2	35.6	60	-24.4	-	-
8	6.95625	13.19	Ca	.2	.1	10.2	23.69	-	-	50	-26.31
9	9.25125	24.32	Qp	.2	.1	10.2	34.82	60	-25.18	-	-
10	9.24225	13.12	Ca	.2	.1	10.2	23.62	-	-	50	-26.38
11	14.80875	17.92	Qp	.2	.2	10.2	28.52	60	-31.48	-	-
12	14.80538	10.49	Ca	.2	.2	10.2	21.09	-	-	50	-28.91

Qp - Quasi-Peak detector

Ca - CISPR average detection

LINE 2 PLOT

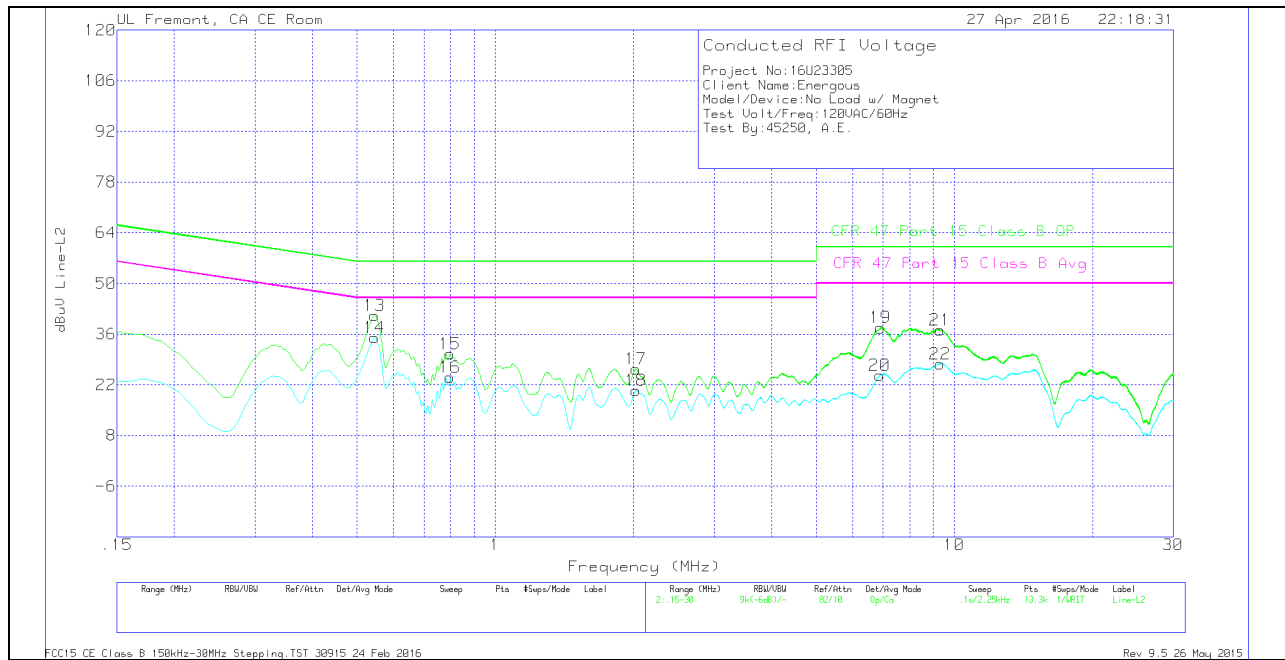

LINE 2 RESULTS

Range 2: Line-L2 .15 - 30MHz

Marker	Frequency (MHz)	Meter Reading (dBuV)	Det	T24 IL L2	LC Cables 2&3	Limiter (dB)	Corrected Reading dBuV	CFR 47 Part 15 Class B QP	QP Margin (dB)	CFR 47 Part 15 Class B Avg	Av(CISPR) Margin (dB)
13	.546	30.74	Qp	.3	0	10.1	41.14	56	-14.86	-	-
14	.546	24.69	Ca	.3	0	10.1	35.09	-	-	46	-10.91
15	.798	20.19	Qp	.3	0	10.1	30.59	56	-25.41	-	-
16	.798	13.62	Ca	.3	0	10.1	24.02	-	-	46	-21.98
17	2.02425	15.88	Qp	.2	.1	10.1	26.28	56	-29.72	-	-
18	2.02425	10.05	Ca	.2	.1	10.1	20.45	-	-	46	-25.55
19	6.89325	27.25	Qp	.2	.1	10.2	37.75	60	-22.25	-	-
20	6.88875	14.11	Ca	.2	.1	10.2	24.61	-	-	50	-25.39
21	9.30075	26.66	Qp	.2	.1	10.2	37.16	60	-22.84	-	-
22	9.31875	17.31	Ca	.2	.1	10.2	27.81	-	-	50	-22.19

Qp - Quasi-Peak detector

Ca - CISPR average detection

Configuration 2: Load with 0 mm Spacing

LINE 1 PLOT

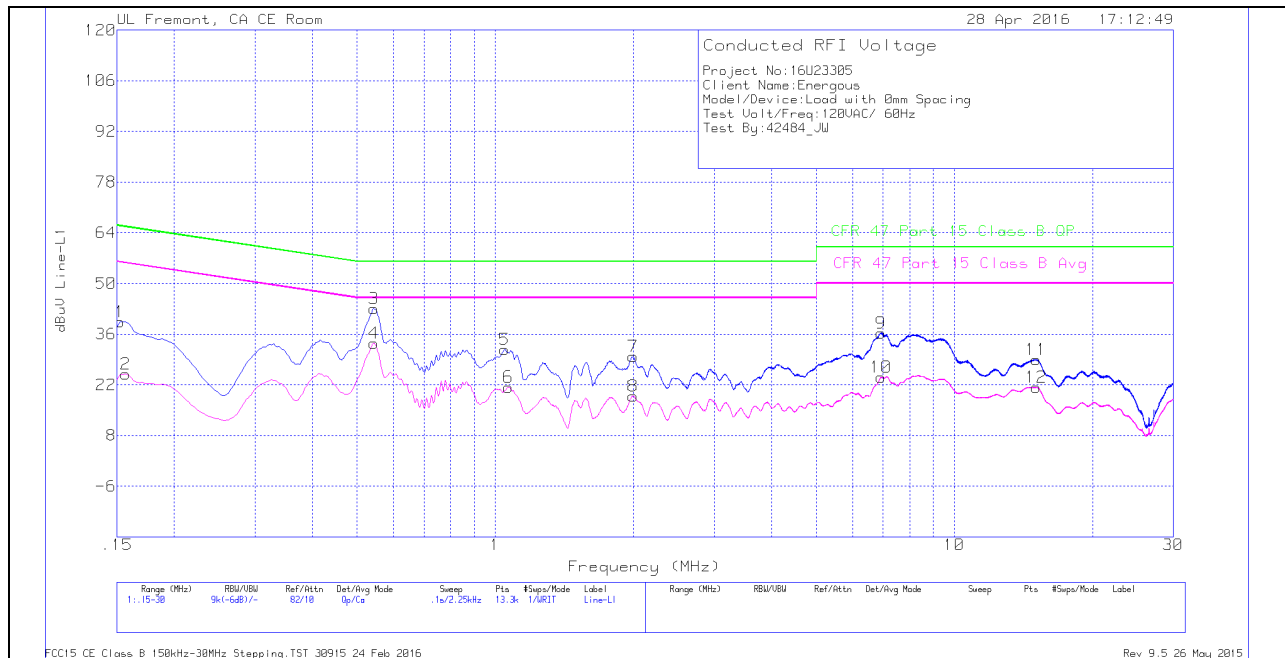

LINE 1 RESULTS

Range 1: Line-L1 .15 - 30MHz

Marker	Frequency (MHz)	Meter Reading (dBuV)	Det	T24 IL L1	LC Cables 1&3	Limiter (dB)	Corrected Reading dBuV	CFR 47 Part 15 Class B QP	QP Margin (dB)	CFR 47 Part 15 Class B Avg	Av(CISPR) Margin (dB)
1	.15225	27.92	Qp	1.4	0	10.1	39.42	65.88	-26.46	-	-
2	.15675	13.54	Ca	1.3	0	10.1	24.94	-	-	55.63	-30.69
3	.54375	32.58	Qp	.3	0	10.1	42.98	56	-13.02	-	-
4	.54375	23.1	Ca	.3	0	10.1	33.5	-	-	46	-12.5
5	1.04775	21.34	Qp	.3	0	10.1	31.74	56	-24.26	-	-
6	1.068	11	Ca	.3	0	10.1	21.4	-	-	46	-24.6
7	1.99725	19.41	Qp	.2	.1	10.1	29.81	56	-26.19	-	-
8	1.99725	8.45	Ca	.2	.1	10.1	18.85	-	-	46	-27.15
9	6.92925	25.81	Qp	.2	.1	10.2	36.31	60	-23.69	-	-
10	6.9315	13.66	Ca	.2	.1	10.2	24.16	-	-	50	-25.84
11	15.09225	18.3	Qp	.3	.2	10.2	29	60	-31	-	-
12	15.0945	10.62	Ca	.3	.2	10.2	21.32	-	-	50	-28.68

Qp - Quasi-Peak detector

Ca - CISPR average detection

LINE 2 PLOT

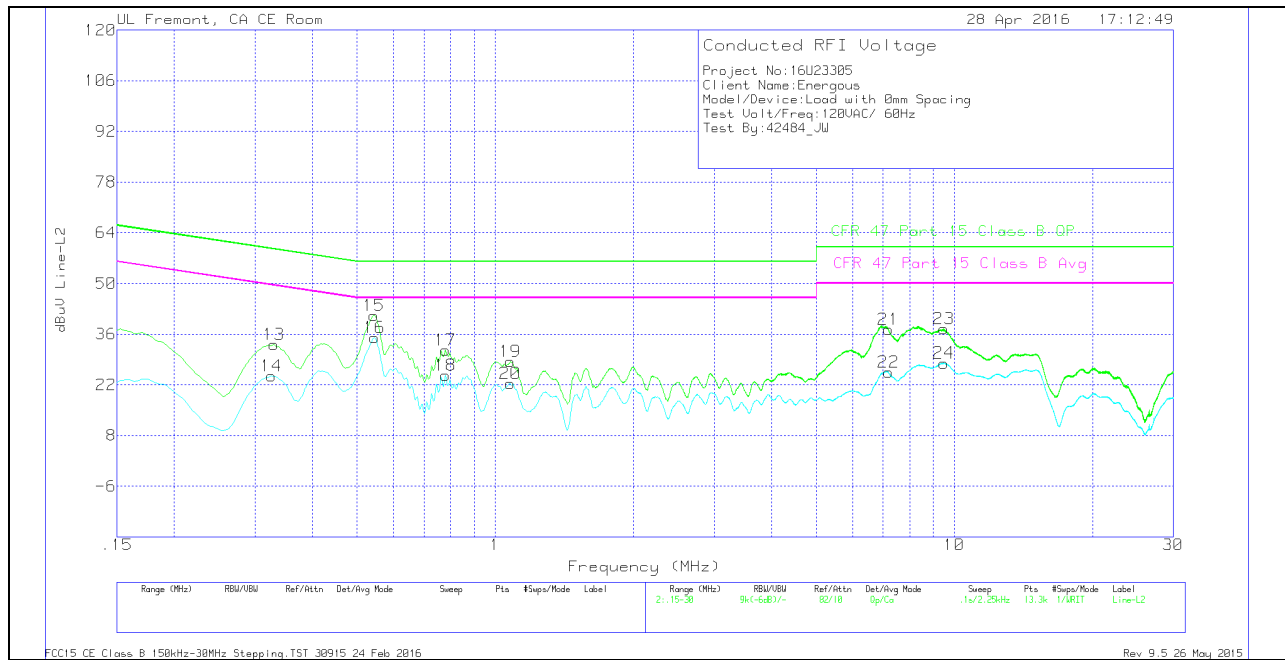

LINE 2 RESULTS

Range 2: Line-L2 .15 - 30MHz

Marker	Frequency (MHz)	Meter Reading (dBuV)	Det	T24 IL L2	LC Cables 2&3	Limiter (dB)	Corrected Reading dBuV	CFR 47 Part 15 Class B QP	QP Margin (dB)	CFR 47 Part 15 Class B Avg	Av(CISPR) Margin (dB)
13	.33	22.46	Qp	.5	0	10.1	33.06	59.45	-26.39	-	-
14	.3255	13.84	Ca	.5	0	10.1	24.44	-	-	49.57	-25.13
15	.54487	30.78	Qp	.3	0	10.1	41.18	56	-14.82	-	-
16	.546	24.6	Ca	.3	0	10.1	35	-	-	46	-11
17	.78	21.24	Qp	.3	0	10.1	31.64	56	-24.36	-	-
18	.78	14.19	Ca	.3	0	10.1	24.59	-	-	46	-21.41
19	1.07925	17.97	Qp	.2	.1	10.1	28.37	56	-27.63	-	-
20	1.077	11.97	Ca	.2	.1	10.1	22.37	-	-	46	-23.63
21	7.19025	26.8	Qp	.2	.1	10.2	37.3	60	-22.7	-	-
22	7.188	14.94	Ca	.2	.1	10.2	25.44	-	-	50	-24.56
23	9.48075	26.94	Qp	.2	.1	10.2	37.44	60	-22.56	-	-
24	9.48075	17.51	Ca	.2	.1	10.2	28.01	-	-	50	-21.99

Qp - Quasi-Peak detector

Ca - CISPR average detection

Configuration 3: Load with 2 mm Spacing

LINE 1 PLOT

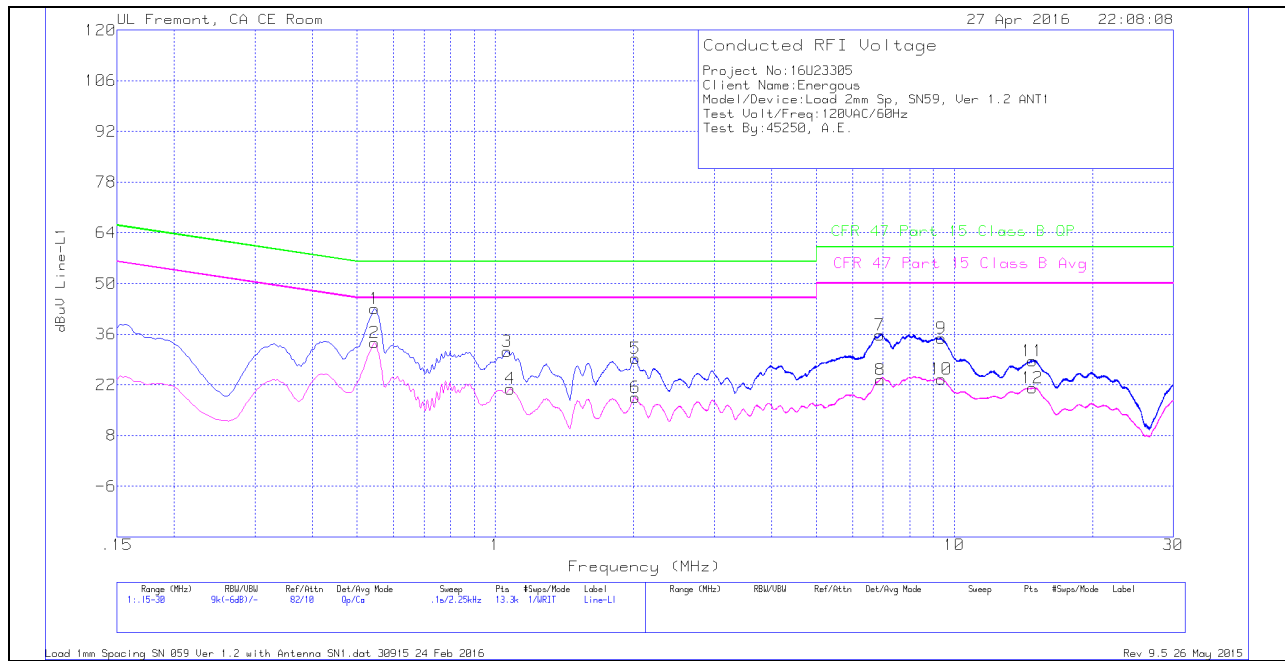

LINE 1 RESULTS

Range 1: Line-L1 .15 - 30MHz

Marker	Frequency (MHz)	Meter Reading (dBuV)	Det	T24 IL L1	LC Cables 1&3	Limiter (dB)	Corrected Reading dBuV	CFR 47 Part 15 Class B QP	QP Margin (dB)	CFR 47 Part 15 Class B Avg	Av(CISPR) Margin (dB)
1	.546	32.61	Qp	.3	0	10.1	43.01	56	-12.99	-	-
2	.546	23.26	Ca	.3	0	10.1	33.66	-	-	46	-12.34
3	1.06012	20.85	Qp	.3	0	10.1	31.25	56	-24.75	-	-
4	1.07925	10.49	Ca	.3	0	10.1	20.89	-	-	46	-25.11
5	2.022	18.9	Qp	.2	.1	10.1	29.3	56	-26.7	-	-
6	2.022	8.08	Ca	.2	.1	10.1	18.48	-	-	46	-27.52
7	6.87975	25.24	Qp	.2	.1	10.2	35.74	60	-24.26	-	-
8	6.89325	12.98	Ca	.2	.1	10.2	23.48	-	-	50	-26.52
9	9.36825	24.28	Qp	.2	.2	10.2	34.88	60	-25.12	-	-
10	9.375	13.03	Ca	.2	.2	10.2	23.63	-	-	50	-26.37
11	14.793	18.05	Qp	.2	.2	10.2	28.65	60	-31.35	-	-
12	14.79075	10.51	Ca	.2	.2	10.2	21.11	-	-	50	-28.89

Qp - Quasi-Peak detector

Ca - CISPR average detection

LINE 2 PLOT

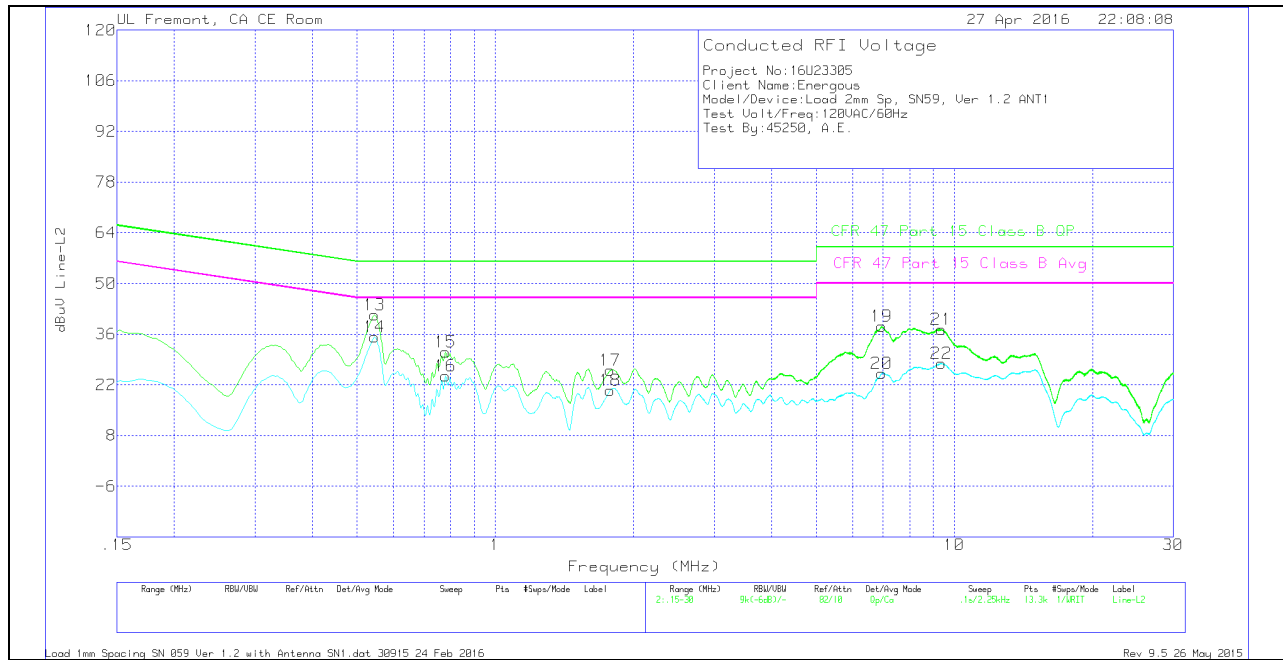

LINE 2 RESULTS

Range 2: Line-L2 .15 - 30MHz

Marker	Frequency (MHz)	Meter Reading (dBuV)	Det	T24 IL L2	LC Cables 2&3	Limiter (dB)	Corrected Reading dBuV	CFR 47 Part 15 Class B QP	QP Margin (dB)	CFR 47 Part 15 Class B Avg	Av(CISPR) Margin (dB)
13	.546	30.83	Qp	.3	0	10.1	41.23	56	-14.77	-	-
14	.546	24.75	Ca	.3	0	10.1	35.15	-	-	46	-10.85
15	.78	20.6	Qp	.3	0	10.1	31	56	-25	-	-
16	.78	14.05	Ca	.3	0	10.1	24.45	-	-	46	-21.55
17	1.78125	15.58	Qp	.2	.1	10.1	25.98	56	-30.02	-	-
18	1.78125	10.11	Ca	.2	.1	10.1	20.51	-	-	46	-25.49
19	6.954	27.61	Qp	.2	.1	10.2	38.11	60	-21.89	-	-
20	6.95625	14.71	Ca	.2	.1	10.2	25.21	-	-	50	-24.79
21	9.366	26.87	Qp	.2	.1	10.2	37.37	60	-22.63	-	-
22	9.36488	17.44	Ca	.2	.1	10.2	27.94	-	-	50	-22.06

Qp - Quasi-Peak detector

Ca - CISPR average detection