

## *EMC Test Report*

### *Application for Grant of Equipment Authorization*

#### *FCC Part 15 Subpart C*

**Model: MLA-1599**

FCC ID: 2ADNG-MLA1599

APPLICANT: Energous  
3590 North First Street, Suite 210  
San Jose, CA 95134

TEST SITE(S): National Technical Systems - Silicon Valley  
41039 Boyce Road.  
Fremont, CA. 94538-2435

IC SITE REGISTRATION #: 2845B-4

REPORT DATE: December 3, 2014

REISSUE DATE: December 30, 2014

FINAL TEST DATES: November 24, 25, December 23 and 30, 2014

TOTAL NUMBER OF PAGES: 55

PROGRAM MGR /  
TECHNICAL REVIEWER:



David W. Bare  
Chief Engineer

QUALITY ASSURANCE DELEGATE /  
FINAL REPORT PREPARER:



David Guidotti  
Senior Technical Writer



National Technical Systems - Silicon Valley is accredited by the A2LA, certificate number 0214.26, to perform the test(s) listed in this report, except where noted otherwise. This report and the information contained herein represent the results of testing test articles identified and selected by the client performed to specifications and/or procedures selected by the client. National Technical Systems (NTS) makes no representations, expressed or implied, that such testing is adequate (or inadequate) to demonstrate efficiency, performance, reliability, or any other characteristic of the articles being tested, or similar products. This report should not be relied upon as an endorsement or certification by NTS of the equipment tested, nor does it represent any statement whatsoever as to its merchantability or fitness of the test article, or similar products, for a particular purpose. This report shall not be reproduced except in full



**REVISION HISTORY**

Rev#	Date	Comments	Modified By
-	December 3, 2014	First release	
1	December 30, 2014	Changed frequency band to 2404-2480 MHz with new results for 2404 MHz channel	dwb

**TABLE OF CONTENTS**

<b>REVISION HISTORY</b> .....	<b>2</b>
<b>TABLE OF CONTENTS</b> .....	<b>3</b>
<b>SCOPE</b> .....	<b>4</b>
<b>OBJECTIVE</b> .....	<b>4</b>
<b>STATEMENT OF COMPLIANCE</b> .....	<b>5</b>
<b>DEVIATIONS FROM THE STANDARDS</b> .....	<b>5</b>
<b>TEST RESULTS SUMMARY</b> .....	<b>6</b>
DIGITAL TRANSMISSION SYSTEMS (2400 – 2483.5MHZ) .....	6
GENERAL REQUIREMENTS APPLICABLE TO ALL BANDS .....	6
MEASUREMENT UNCERTAINTIES .....	7
<b>EQUIPMENT UNDER TEST (EUT) DETAILS</b> .....	<b>8</b>
GENERAL.....	8
ANTENNA SYSTEM .....	8
ENCLOSURE.....	8
MODIFICATIONS .....	8
SUPPORT EQUIPMENT .....	8
EUT INTERFACE PORTS .....	9
EUT OPERATION .....	9
<b>TEST SITE</b> .....	<b>10</b>
GENERAL INFORMATION .....	10
CONDUCTED EMISSIONS CONSIDERATIONS .....	10
RADIATED EMISSIONS CONSIDERATIONS .....	10
<b>MEASUREMENT INSTRUMENTATION</b> .....	<b>11</b>
RECEIVER SYSTEM .....	11
INSTRUMENT CONTROL COMPUTER .....	11
LINE IMPEDANCE STABILIZATION NETWORK (LISN).....	11
FILTERS/ATTENUATORS .....	12
ANTENNAS.....	12
ANTENNA MAST AND EQUIPMENT TURNTABLE.....	12
INSTRUMENT CALIBRATION.....	12
<b>TEST PROCEDURES</b> .....	<b>13</b>
EUT AND CABLE PLACEMENT .....	13
CONDUCTED EMISSIONS.....	13
RADIATED EMISSIONS .....	14
CONDUCTED EMISSIONS FROM ANTENNA PORT .....	17
BANDWIDTH MEASUREMENTS .....	17
SPECIFICATION LIMITS AND SAMPLE CALCULATIONS .....	18
CONDUCTED EMISSIONS SPECIFICATION LIMITS: FCC 15.207; FCC 15.107(A) .....	18
GENERAL TRANSMITTER RADIATED EMISSIONS SPECIFICATION LIMITS .....	19
OUTPUT POWER LIMITS – DIGITAL TRANSMISSION SYSTEMS .....	19
TRANSMIT MODE SPURIOUS RADIATED EMISSIONS LIMITS – FHSS AND DTS SYSTEMS.....	19
SAMPLE CALCULATIONS - CONDUCTED EMISSIONS .....	20
SAMPLE CALCULATIONS - RADIATED EMISSIONS.....	20
SAMPLE CALCULATIONS - FIELD STRENGTH TO EIRP CONVERSION.....	21
<b>APPENDIX A TEST EQUIPMENT CALIBRATION DATA</b> .....	<b>22</b>
<b>APPENDIX B TEST DATA</b> .....	<b>23</b>
<b>END OF REPORT</b> .....	<b>55</b>

## SCOPE

An electromagnetic emissions test has been performed on the Energos model MLA-1599, pursuant to the following rules:

FCC Part 15 Subpart C

Conducted and radiated emissions data has been collected, reduced, and analyzed within this report in accordance with measurement guidelines set forth in the following reference standards and as outlined in National Technical Systems - Silicon Valley test procedures:

ANSI C63.10-2009

FCC DTS Measurement Guidance KDB558074

The intentional radiator above has been tested in a simulated typical installation to demonstrate compliance with the relevant Industry Canada performance and procedural standards.

Final system data was gathered in a mode that tended to maximize emissions by varying orientation of EUT, orientation of power and I/O cabling, antenna search height, and antenna polarization.

Every practical effort was made to perform an impartial test using appropriate test equipment of known calibration. All pertinent factors have been applied to reach the determination of compliance.

## OBJECTIVE

The primary objective of the manufacturer is compliance with the regulations outlined in the previous section.

Prior to marketing in the USA, all unlicensed transmitters and transceivers require certification. Receive-only devices operating between 30 MHz and 960 MHz are subject to either certification or a manufacturer's declaration of conformity, with all other receive-only devices exempt from the technical requirements.

Certification is a procedure where the manufacturer submits test data and technical information to a certification body and receives a certificate or grant of equipment authorization upon successful completion of the certification body's review of the submitted documents. Once the equipment authorization has been obtained, the label indicating compliance must be attached to all identical units, which are subsequently manufactured.

Maintenance of compliance is the responsibility of the manufacturer. Any modification of the product which may result in increased emissions should be checked to ensure compliance has been maintained (i.e., printed circuit board layout changes, different line filter, different power supply, harnessing or I/O cable changes, etc.).

**STATEMENT OF COMPLIANCE**

The tested sample of Energous model MLA-1599 complied with the requirements of the following regulations:

FCC Part 15 Subpart C

Maintenance of compliance is the responsibility of the manufacturer. Any modifications to the product should be assessed to determine their potential impact on the compliance status of the device with respect to the standards detailed in this test report.

The test results recorded herein are based on a single type test of Energous model MLA-1599 and therefore apply only to the tested sample. The sample was selected and prepared by FW Miller of Energous.

**DEVIATIONS FROM THE STANDARDS**

No deviations were made from the published requirements listed in the scope of this report.

**TEST RESULTS SUMMARY**
**DIGITAL TRANSMISSION SYSTEMS (2400 – 2483.5MHz)**

FCC Rule Part	Description	Measured Value / Comments	Limit / Requirement	Result
15.247(a)	Digital Modulation	Systems uses GFSK digital modulation	System must utilize a digital transmission technology	Complies
15.247 (a) (2)	6dB Bandwidth	741 kHz	>500kHz	Complies
15.247 (b) (3)	Output Power (multipoint systems)	2.3 dBm (0.0017 Watts) EIRP = 0.0021 W <small>Note 1</small>	1Watt, EIRP limited to 4 Watts.	Complies
15.247(d)	Power Spectral Density	0.7 dBm / 100kHz	8dBm/3kHz	Complies
15.247(c) / 15.209	Radiated Spurious Emissions 30MHz – 25 GHz	51.2 dBμV/m @ 7211.5 MHz (-2.8 dB)	15.207 in restricted bands, all others < -20dBc	Complies
Note 1: Power calculated from measured field strength converted to EIRP using antenna gain of +1 dBi for the highest EIRP system.				

**GENERAL REQUIREMENTS APPLICABLE TO ALL BANDS**

FCC Rule Part	Description	Measured Value / Comments	Limit / Requirement	Result (margin)
15.203	RF Connector	Integral PIFA Antenna	Unique or integral antenna required	Complies
15.207	AC Conducted Emissions	43.6 dBμV @ 3.473 MHz (-12.4 dB)	Refer to page 18	Complies
15.247 (b) (5) 15.407 (f)	RF Exposure Requirements	Refer to calculations in separate exhibit	Refer to OET 65, FCC	Complies
-	Occupied Bandwidth	1.8 MHz	Information only	N/A

**MEASUREMENT UNCERTAINTIES**

ISO/IEC 17025 requires that an estimate of the measurement uncertainties associated with the emissions test results be included in the report. The measurement uncertainties given below are based on a 95% confidence level and were calculated in accordance with UKAS document LAB 34.

Measurement Type	Measurement Unit	Frequency Range	Expanded Uncertainty
RF power, conducted (power meter)	dBm	25 to 7000 MHz	$\pm 0.52$ dB
RF power, conducted (Spectrum analyzer)	dBm	25 to 7000 MHz	$\pm 0.7$ dB
Conducted emission of transmitter	dBm	25 to 26500 MHz	$\pm 0.7$ dB
Conducted emission of receiver	dBm	25 to 26500 MHz	$\pm 0.7$ dB
Radiated emission (substitution method)	dBm	25 to 26500 MHz	$\pm 2.5$ dB
Radiated emission (field strength)	dB $\mu$ V/m	25 to 1000 MHz	$\pm 3.6$ dB
		1000 to 40000 MHz	$\pm 6.0$ dB
Conducted Emissions (AC Power)	dB $\mu$ V	0.15 to 30 MHz	$\pm 2.4$ dB

**EQUIPMENT UNDER TEST (EUT) DETAILS****GENERAL**

The Energous model MLA-1599 is a Bluetooth wireless accessory. It is rated at 5V, maximum 7W.

The sample was received on November 24, 2014 and tested on November 24, 25, December 23 and 30, 2014. The EUT consisted of the following component(s):

Company	Model	Description	Serial Number	FCC ID
Energous	MLA-1599	Bluetooth wireless accessory	BT37140006	2ADNG-MLA1599

**ANTENNA SYSTEM**

The antenna system consists of an integral +1.0 dBi maximum gain PIFA antenna

**ENCLOSURE**

The EUT enclosure measures approximately 5.75 inches tall by 6.5 inches wide by 3 inches deep. It is primarily constructed of uncoated plastic.

**MODIFICATIONS**

No modifications were made to the EUT during the time the product was at NTS Silicon Valley.

**SUPPORT EQUIPMENT**

The following equipment was used as support equipment for testing:

Company	Model	Description	Serial Number	FCC ID
Dell	Latitude	Laptop	13597079797	-

No remote support equipment was used during testing.



**EUT INTERFACE PORTS**

The I/O cabling configuration during testing was as follows:

**EUT**

Port	Connected To	Description	Cable(s)	
			Shielded or Unshielded	Length(m)
EUT / Micro USB	AC/DC Adapter	USB Cable	Shielded	1
EUT / 6Pin Port	USB Adapter Board	6Pin Cable	Unshielded	0.25
USB Adapter Board	Laptop	USB Cable	Shielded	1

**Additional on Support Equipment**

Port	Connected To	Description	Cable(s)	
			Shielded or Unshielded	Length(m)
Power	AC Mains	3 Wire	Unshielded	0.5

**EUT OPERATION**

During emissions testing the EUT was exercised by BlueTool software to transmit continuously on the selected channel at the default power.

**TEST SITE****GENERAL INFORMATION**

Final test measurements were taken at the test sites listed below. Pursuant to section 2.948 of the FCC's Rules, construction, calibration, and equipment data has been filed with the Commission.

Site	Designation / Registration Numbers		Location
	FCC	Canada	
Chamber 4	US0027	2845B-4	41039 Boyce Road Fremont, CA 94538-2435

ANSI C63.4 recommends that ambient noise at the test site be at least 6 dB below the allowable limits. Ambient levels are below this requirement. The test site(s) contain separate areas for radiated and conducted emissions testing. Considerable engineering effort has been expended to ensure that the facilities conform to all pertinent requirements of ANSI C63.4.

**CONDUCTED EMISSIONS CONSIDERATIONS**

Conducted emissions testing is performed in conformance with ANSI C63.10. Measurements are made with the EUT connected to the public power network through a nominal, standardized RF impedance, which is provided by a line impedance stabilization network, known as a LISN. A LISN is inserted in series with each current-carrying conductor in the EUT power cord.

**RADIATED EMISSIONS CONSIDERATIONS**

The FCC has determined that radiation measurements made in a shielded enclosure are not suitable for determining levels of radiated emissions. Radiated measurements are performed in an open field environment or in a semi-anechoic chamber. The test sites are maintained free of conductive objects within the CISPR defined elliptical area incorporated in ANSI C63.4 guidelines and meet the Normalized Site Attenuation (NSA) requirements of ANSI C63.4.

## MEASUREMENT INSTRUMENTATION

### RECEIVER SYSTEM

An EMI receiver as specified in CISPR 16-1-1 is used for emissions measurements. The receivers used can measure over the frequency range of 9 kHz up to 2000 MHz. These receivers allow both ease of measurement and high accuracy to be achieved. The receivers have Peak, Average, and CISPR (Quasi-peak) detectors built into their design so no external adapters are necessary. The receiver automatically sets the required bandwidth for the CISPR detector used during measurements. If the repetition frequency of the signal being measured is below 20Hz, peak measurements are made in lieu of Quasi-Peak measurements.

For measurements above the frequency range of the receivers, a spectrum analyzer is utilized because it provides visibility of the entire spectrum along with the precision and versatility required to support engineering analysis. Average measurements above 1000MHz are performed on the spectrum analyzer using the linear-average method with a resolution bandwidth of 1 MHz and a video bandwidth of 10 Hz, unless the signal is pulsed in which case the average (or video) bandwidth of the measuring instrument is reduced to onset of pulse desensitization and then increased.

### INSTRUMENT CONTROL COMPUTER

The receivers utilize either a Rohde & Schwarz EZM Spectrum Monitor/Controller or contain an internal Spectrum Monitor/Controller to view and convert the receiver measurements to the field strength at an antenna or voltage developed at the LISN measurement port, which is then compared directly with the appropriate specification limit. This provides faster, more accurate readings by performing the conversions described under Sample Calculations within the Test Procedures section of this report. Results are printed in a graphic and/or tabular format, as appropriate. A personal computer is used to record all measurements made with the receivers.

The Spectrum Monitor provides a visual display of the signal being measured. In addition, the controller or a personal computer run automated data collection programs which control the receivers. This provides added accuracy since all site correction factors, such as cable loss and antenna factors are added automatically.

### LINE IMPEDANCE STABILIZATION NETWORK (LISN)

Line conducted measurements utilize a fifty microhenry Line Impedance Stabilization Network as the monitoring point. The LISN used also contains a 250 uH CISPR adapter. This network provides for calibrated radio frequency noise measurements by the design of the internal low pass and high pass filters on the EUT and measurement ports, respectively.

### *FILTERS/ATTENUATORS*

External filters and precision attenuators are often connected between the receiving antenna or LISN and the receiver. This eliminates saturation effects and non-linear operation due to high amplitude transient events.

### *ANTENNAS*

A loop antenna is used below 30 MHz. For the measurement range 30 MHz to 1000 MHz either a combination of a biconical antenna and a log periodic or a bi-log antenna is used. Above 1000 MHz, horn antennas are used. The antenna calibration factors to convert the received voltage to an electric field strength are included with appropriate cable loss and amplifier gain factors to determine an overall site factor, which is then programmed into the test receivers or incorporated into the test software.

### *ANTENNA MAST AND EQUIPMENT TURNTABLE*

The antennas used to measure the radiated electric field strength are mounted on a non-conductive antenna mast equipped with a motor-drive to vary the antenna height. Measurements below 30 MHz are made with the loop antenna at a fixed height of 1m above the ground plane.

ANSI C63.10 specifies that the test height above ground for table mounted devices shall be 80 centimeters. Floor mounted equipment shall be placed on the ground plane if the device is normally used on a conductive floor or separated from the ground plane by insulating material from 3 to 12 mm if the device is normally used on a non-conductive floor as specified in ANSI C63.4. During radiated measurements, the EUT is positioned on a motorized turntable in conformance with this requirement.

### *INSTRUMENT CALIBRATION*

All test equipment is regularly checked to ensure that performance is maintained in accordance with the manufacturer's specifications. All antennas are calibrated at regular intervals with respect to tuned half-wave dipoles. An exhibit of this report contains the list of test equipment used and calibration information.

## TEST PROCEDURES

### EUT AND CABLE PLACEMENT

The regulations require that interconnecting cables be connected to the available ports of the unit and that the placement of the unit and the attached cables simulate the worst case orientation that can be expected from a typical installation, so far as practicable. To this end, the position of the unit and associated cabling is varied within the guidelines of ANSI C63.10, and the worst-case orientation is used for final measurements.

### CONDUCTED EMISSIONS

Conducted emissions are measured at the plug end of the power cord supplied with the EUT. Excess power cord length is wrapped in a bundle between 30 and 40 centimeters in length near the center of the cord. Preliminary measurements are made to determine the highest amplitude emission relative to the specification limit for all the modes of operation. Placement of system components and varying of cable positions are performed in each mode. A final peak mode scan is then performed in the position and mode for which the highest emission was noted on all current carrying conductors of the power cord.

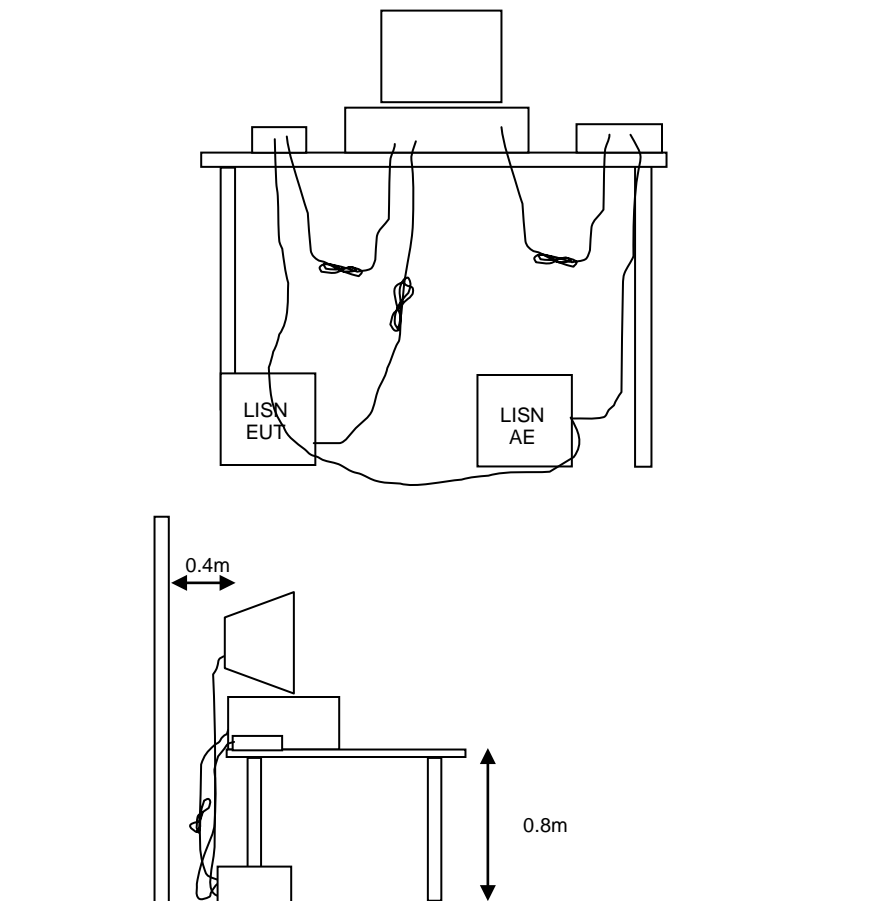

**Figure 1 Typical Conducted Emissions Test Configuration**

## **RADIATED EMISSIONS**

A preliminary scan of the radiated emissions is performed in which all significant EUT frequencies are identified with the system in a nominal configuration. At least two scans are performed, one scan for each antenna polarization (horizontal and vertical; loop parallel and perpendicular to the EUT). During the preliminary scans, the EUT is rotated through 360°, the antenna height is varied (for measurements above 30 MHz) and cable positions are varied to determine the highest emission relative to the limit. Preliminary scans may be performed in a fully anechoic chamber for the purposes of identifying the frequencies of the highest emissions from the EUT.

A speaker is provided in the receiver to aid in discriminating between EUT and ambient emissions. Other methods used during the preliminary scan for EUT emissions involve scanning with near field magnetic loops, monitoring I/O cables with RF current clamps, and cycling power to the EUT.

Final maximization is a phase in which the highest amplitude emissions identified in the spectral search are viewed while the EUT azimuth angle is varied from 0 to 360 degrees relative to the receiving antenna. The azimuth, which results in the highest emission is then maintained while varying the antenna height from one to four meters (for measurements above 30 MHz, measurements below 30 MHz are made with the loop antenna at a fixed height of 1m). The result is the identification of the highest amplitude for each of the highest peaks. Each recorded level is corrected in the receiver using appropriate factors for cables, connectors, antennas, and preamplifier gain.

When testing above 18 GHz, the receive antenna is located at 1 meter from the EUT and the antenna height is restricted to a maximum of 2.5 meters.

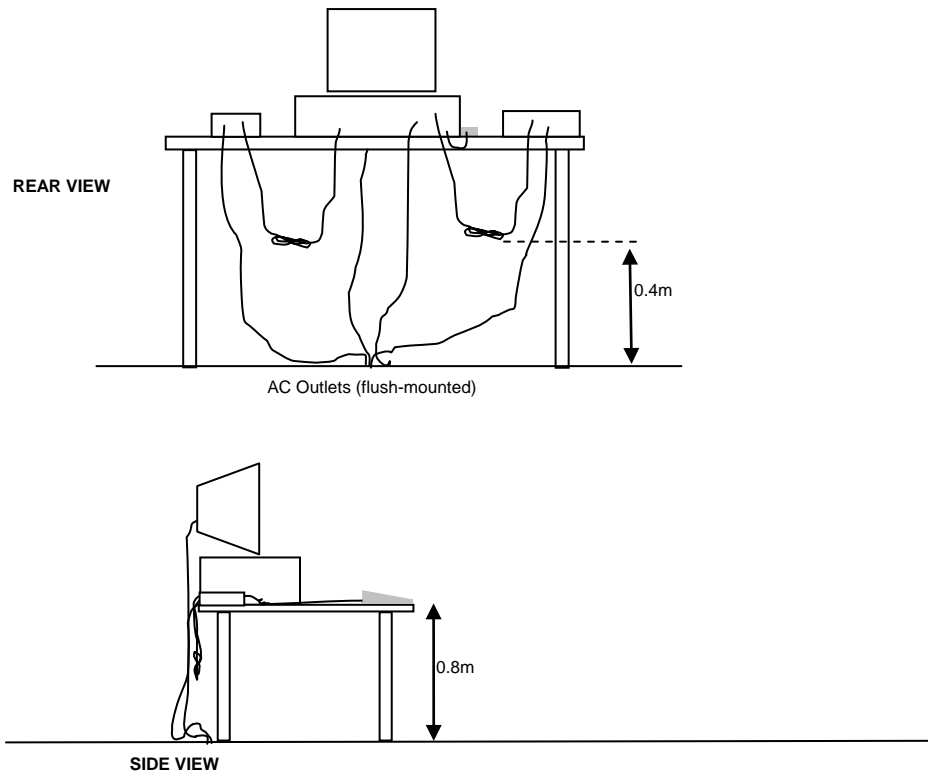

Typical Test Configuration for Radiated Field Strength Measurements

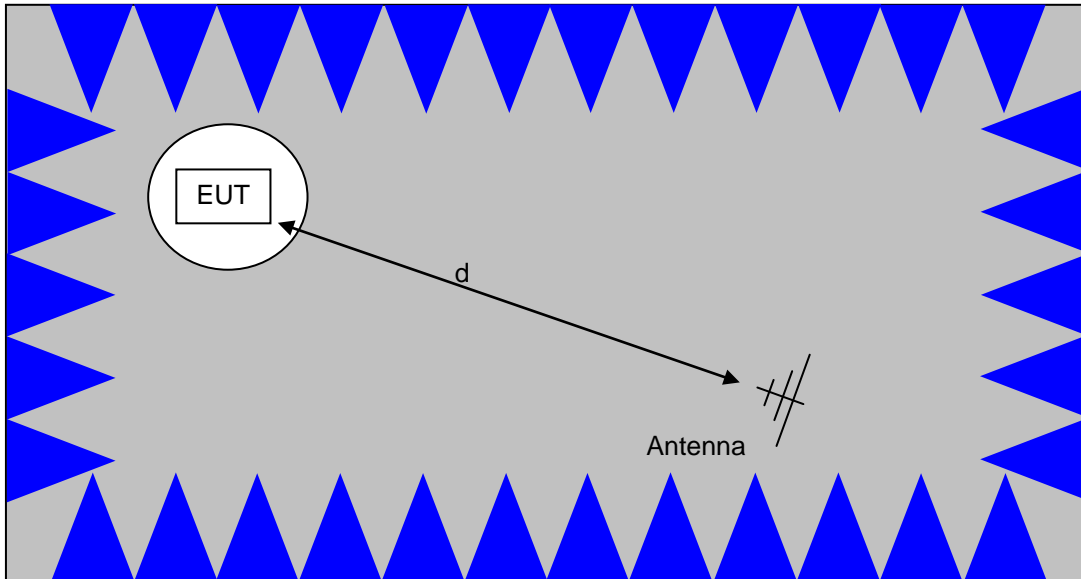

The anechoic materials on the walls and ceiling ensure compliance with the normalized site attenuation requirements of CISPR 16 / CISPR 22 / ANSI C63.4 for an alternate test site at the measurement distances used.

Floor-standing equipment is placed on the floor with insulating supports between the unit and the ground plane.

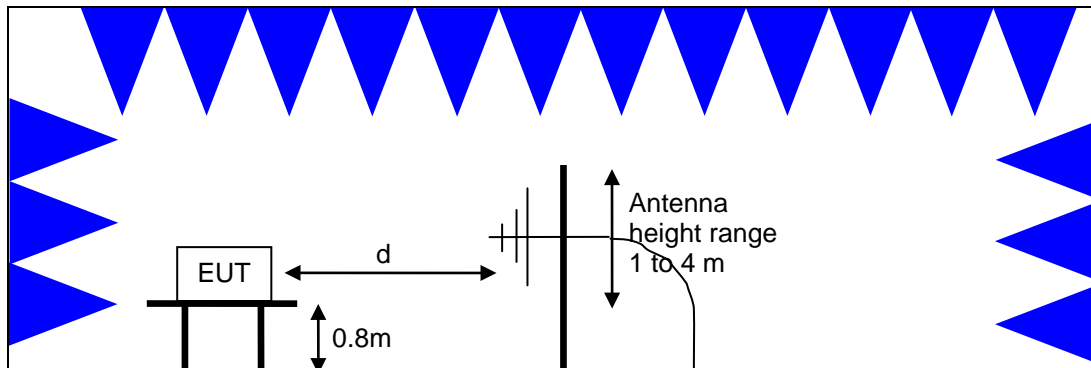

Test Configuration for Radiated Field Strength Measurements  
Semi-Anechoic Chamber, Plan and Side Views



### CONDUCTED EMISSIONS FROM ANTENNA PORT

Direct measurements of power, bandwidth and power spectral density are performed, where possible, with the antenna port of the EUT connected to either the power meter or spectrum analyzer via a suitable attenuator and/or filter. These are used to ensure that the front end of the measurement instrument is not overloaded by the fundamental transmission.

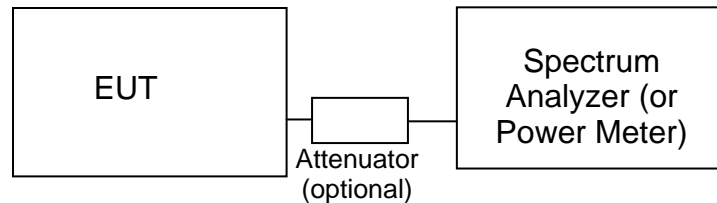

#### Test Configuration for Antenna Port Measurements

Measurement bandwidths (video and resolution) are set in accordance with the relevant standards and NTS Silicon Valley's test procedures for the type of radio being tested. When power measurements are made using a resolution bandwidth less than the signal bandwidth the power is calculated by summing the power across the signal bandwidth using either the analyzer channel power function or by capturing the trace data and calculating the power using software. In both cases the summed power is corrected to account for the equivalent noise bandwidth (ENBW) of the resolution bandwidth used.

If power averaging is used (typically for certain digital modulation techniques), the EUT is configured to transmit continuously. Power averaging is performed using either the built-in function of the analyzer or, if the analyzer does not feature power averaging, using external software. In both cases the average power is calculated over a number of sweeps (typically 100). When the EUT cannot be configured to continuously transmit then either the analyzer is configured to perform a gated sweep to ensure that the power is averaged over periods that the device is transmitting or power averaging is disabled and a max-hold feature is used.

If a power meter is used to make output power measurements the sensor head type (peak or average) is stated in the test data table.

### BANDWIDTH MEASUREMENTS

The 6dB, 20dB, 26dB and/or 99% signal bandwidth are measured using the bandwidths recommended by ANSI C63.10.

**SPECIFICATION LIMITS AND SAMPLE CALCULATIONS**

The limits for conducted emissions are given in units of microvolts, and the limits for radiated emissions are given in units of microvolts per meter at a specified test distance. Data is measured in the logarithmic form of decibels relative to one microvolt, or dB microvolts (dBuV). For radiated emissions, the measured data is converted to the field strength at the antenna in dB microvolts per meter (dBuV/m). The results are then converted to the linear forms of uV and uV/m for comparison to published specifications.

For reference, converting the specification limits from linear to decibel form is accomplished by taking the base ten logarithm, then multiplying by 20. These limits in both linear and logarithmic form are as follows:

*CONDUCTED EMISSIONS SPECIFICATION LIMITS: FCC 15.207; FCC 15.107(a)*

The table below shows the limits for the emissions on the AC power line from an intentional radiator and a receiver.

Frequency (MHz)	Average Limit (dBuV)	Quasi Peak Limit (dBuV)
0.150 to 0.500	Linear decrease on logarithmic frequency axis between 56.0 and 46.0	Linear decrease on logarithmic frequency axis between 66.0 and 56.0
0.500 to 5.000	46.0	56.0
5.000 to 30.000	50.0	60.0

### GENERAL TRANSMITTER RADIATED EMISSIONS SPECIFICATION LIMITS

The table below shows the limits for the spurious emissions from transmitters that fall in restricted bands<sup>1</sup> (with the exception of transmitters operating under FCC Part 15 Subpart D), the limits for all emissions from a low power device operating under the FCC Part 15 Subpart C section 15.209.

Frequency Range (MHz)	Limit (uV/m)	Limit (dBuV/m @ 3m)
0.009-0.490	2400/F <sub>KHz</sub> @ 300m	67.6-20*log <sub>10</sub> (F <sub>KHz</sub> ) @ 300m
0.490-1.705	24000/F <sub>KHz</sub> @ 30m	87.6-20*log <sub>10</sub> (F <sub>KHz</sub> ) @ 30m
1.705 to 30	30 @ 30m	29.5 @ 30m
30 to 88	100 @ 3m	40 @ 3m
88 to 216	150 @ 3m	43.5 @ 3m
216 to 960	200 @ 3m	46.0 @ 3m
Above 960	500 @ 3m	54.0 @ 3m

### OUTPUT POWER LIMITS – DIGITAL TRANSMISSION SYSTEMS

The table below shows the limits for output power and output power density. Where the signal bandwidth is less than 20 MHz the maximum output power is reduced to the power spectral density limit plus 10 times the log of the bandwidth (in MHz).

Operating Frequency (MHz)	Output Power	Power Spectral Density
902 – 928	1 Watt (30 dBm)	8 dBm/3kHz
2400 – 2483.5	1 Watt (30 dBm)	8 dBm/3kHz
5725 – 5850	1 Watt (30 dBm)	8 dBm/3kHz

The maximum permitted output power is reduced by 1dB for every dB the antenna gain exceeds 6dBi. Fixed point-to-point applications using the 5725 – 5850 MHz band are not subject to this restriction.

### TRANSMIT MODE SPURIOUS RADIATED EMISSIONS LIMITS – FHSS and DTS SYSTEMS

The limits for unwanted (spurious) emissions from the transmitter falling in the restricted bands are those specified in the general limits sections of FCC Part 15. All other unwanted (spurious) emissions shall be at least 20dB below the level of the highest in-band signal level (30dB if the power is measured using the sample detector/power averaging method).

<sup>1</sup> The restricted bands are detailed in FCC 15.203

**SAMPLE CALCULATIONS - CONDUCTED EMISSIONS**

Receiver readings are compared directly to the conducted emissions specification limit (decibel form) as follows:

$$R_r - S = M$$

where:

$R_r$  = Receiver Reading in dBuV

$S$  = Specification Limit in dBuV

$M$  = Margin to Specification in +/- dB

**SAMPLE CALCULATIONS - RADIATED EMISSIONS**

Receiver readings are compared directly to the specification limit (decibel form). The receiver internally corrects for cable loss, preamplifier gain, and antenna factor. The calculations are in the reverse direction of the actual signal flow, thus cable loss is added and the amplifier gain is subtracted. The Antenna Factor converts the voltage at the antenna coaxial connector to the field strength at the antenna elements.

A distance factor, when used for electric field measurements above 30MHz, is calculated by using the following formula:

$$F_d = 20 * \text{LOG}_{10} (D_m/D_s)$$

where:

$F_d$  = Distance Factor in dB

$D_m$  = Measurement Distance in meters

$D_s$  = Specification Distance in meters

For electric field measurements below 30MHz the extrapolation factor is either determined by making measurements at multiple distances or a theoretical value is calculated using the formula:

$$F_d = 40 * \text{LOG}_{10} (D_m/D_s)$$

Measurement Distance is the distance at which the measurements were taken and Specification Distance is the distance at which the specification limits are based. The antenna factor converts the voltage at the antenna coaxial connector to the field strength at the antenna elements.

The margin of a given emission peak relative to the limit is calculated as follows:

$$R_c = R_r + F_d$$

and

$$M = R_c - L_s$$

where:

$R_r$  = Receiver Reading in dBuV/m

$F_d$  = Distance Factor in dB

- $R_C$  = Corrected Reading in dBuV/m  
 $L_S$  = Specification Limit in dBuV/m  
 $M$  = Margin in dB Relative to Spec

**SAMPLE CALCULATIONS - FIELD STRENGTH TO EIRP CONVERSION**

Where the radiated electric field strength is expressed in terms of the equivalent isotropic radiated power (eirp), or where a field strength measurement of output power is made in lieu of a direct measurement, the following formula is used to convert between eirp and field strength at a distance of  $d$  (meters) from the equipment under test:

$$E = \frac{1000000 \sqrt{30 P}}{d} \text{ microvolts per meter}$$

where  $P$  is the eirp (Watts)

For a measurement at 3m the conversion from a logarithmic value for field strength (dBuV/m) to an eirp power (dBm) is -95.3dB.

## Appendix A Test Equipment Calibration Data

### Radiated Emissions, 1000 - 25,000 MHz, 24-Nov-14

<u>Manufacturer</u>	<u>Description</u>	<u>Model</u>	<u>Asset #</u>	<u>Calibrated</u>	<u>Cal Due</u>
Hewlett Packard	Microwave Preamplifier, 1-26.5GHz	8449B	263	3/25/2014	3/25/2015
EMCO	Antenna, Horn, 1-18 GHz	3115	487	7/29/2014	7/29/2016
Hewlett Packard	SpecAn 30 Hz -40 GHz, SV (SA40) Red	8564E (84125C)	1148	9/20/2014	9/20/2015
Hewlett Packard	High Pass filter, 8.2 GHz (Red System)	P/N 84300-80039 (84125C)	1152	8/1/2014	8/1/2015
Micro-Tronics	Band Reject Filter, 2400-2500 MHz	BRM50702-02	2238	9/16/2014	9/16/2015
Hewlett Packard	Head (Inc flex cable, 1143, 2198) Red	84125C	1145	6/17/2014	6/17/2015
A. H. Systems	Red System Horn, 18-40GHz	SAS-574	2161	7/9/2014	7/9/2015

### Conducted Emissions - AC Power Ports, 25-Nov-14

<u>Manufacturer</u>	<u>Description</u>	<u>Model</u>	<u>Asset #</u>	<u>Calibrated</u>	<u>Cal Due</u>
EMCO	LISN, 10 kHz-100 MHz	3825/2	1293	2/13/2014	2/13/2015
Rohde & Schwarz	Pulse Limiter	ESH3 Z2	1401	5/15/2014	5/15/2015
Rohde & Schwarz	EMI Test Receiver, 20 Hz-7 GHz	ESIB7	1630	6/21/2014	6/21/2015
Fischer Custom Comm	LISN, 25A, 150kHz to 30MHz, 25 Amp,	FCC-LISN-50-25-2-09	2001	4/4/2014	4/4/2015

### Radiated Emissions, 30 - 1,000 MHz, 25-Nov-14

<u>Manufacturer</u>	<u>Description</u>	<u>Model</u>	<u>Asset #</u>	<u>Calibrated</u>	<u>Cal Due</u>
Rohde & Schwarz	EMI Test Receiver, 20 Hz-7 GHz	ESIB7	1630	6/21/2014	6/21/2015
Sunol Sciences	Biconilog, 30-3000 MHz	JB3	2237	8/29/2014	8/29/2016
Com-Power	Preamplifier, 1-1000 MHz	PAM-103	2885	10/22/2014	10/22/2015

### Radio Antenna Port (Power and Spurious Emissions), 25-Nov-14

<u>Manufacturer</u>	<u>Description</u>	<u>Model</u>	<u>Asset #</u>	<u>Calibrated</u>	<u>Cal Due</u>
EMCO	Antenna, Horn, 1-18 GHz	3115	487	7/29/2014	7/29/2016
Rohde & Schwarz	EMI Test Receiver, 20 Hz-7 GHz	ESIB7	1630	6/21/2014	6/21/2015

### Radio Antenna Port (Power and Spurious Emissions), 23-Dec-14

<u>Manufacturer</u>	<u>Description</u>	<u>Model</u>	<u>Asset #</u>	<u>Calibrated</u>	<u>Cal Due</u>
EMCO	Antenna, Horn, 1-18 GHz	3115	487	7/29/2014	7/29/2016
Rohde & Schwarz	EMI Test Receiver, 20 Hz-7 GHz	ESIB7	1630	6/21/2014	6/21/2015

### Radiated Spurious Emissions, 1000 - 12,000 MHz, 30-Dec-14

<u>Manufacturer</u>	<u>Description</u>	<u>Model</u>	<u>Asset #</u>	<u>Calibrated</u>	<u>Cal Due</u>
Hewlett Packard	Microwave Preamplifier, 1-26.5GHz	8449B	263	3/25/2014	3/25/2015
EMCO	Antenna, Horn, 1-18 GHz	3115	487	7/29/2014	7/29/2016
Hewlett Packard	SpecAn 30 Hz -40 GHz, SV (SA40) Red	8564E (84125C)	1148	9/20/2014	9/20/2015
Rohde & Schwarz	EMI Test Receiver, 20 Hz-7 GHz	ESIB7	1630	6/21/2014	6/21/2015
Micro-Tronics	Band Reject Filter, 2400-2500 MHz	BRM50702-02	2249	10/3/2014	10/3/2015



## Appendix B Test Data

T96943 Pages 24 – 54



# EMC Test Data

Client:	Energous	Job Number:	J96937
Product	MLA-1599	T-Log Number:	T96943
		Project Manager:	Irene Rademacher
Contact:	FW Miller	Project Coordinator:	
Emissions Standard(s):	FCC 15.247	Class:	-
Immunity Standard(s):	-	Environment:	Radio

## EMC Test Data

For The

### Energous

Product

MLA-1599

Date of Last Test: 12/30/2014





# EMC Test Data

Client: Energous	Job Number: J96937
Model: MLA-1599	T-Log Number: T96943
	Project Manager: Irene Rademacher
Contact: FW Miller	Project Coordinator: -
Standard: FCC 15.247	Class: N/A

## RSS 210 and FCC 15.247 (DTS) Radiated Spurious Emissions

### Test Specific Details

Objective: The objective of this test session is to perform Final Qualification testing of the EUT with respect to the specification listed above.

### General Test Configuration

The EUT and all local support equipment were located on the turntable for radiated spurious emissions testing. For radiated emissions testing the measurement antenna was located 3 meters from the EUT, unless otherwise noted.

### Ambient Conditions:

Temperature: 21.4 °C  
Rel. Humidity: 38 %

### Summary of Results - Device Operating in the 2400-2483.5 MHz Band

Run #	Mode	Channel	Target Power	Power Setting	Test Performed	Limit	Result / Margin
1	BLE	2404 MHz	-	Default	Restricted Band Edge (2390 MHz)	FCC Part 15.209 / 15.247(c)	38.5 dBµV/m @ 2367.1 MHz (-15.5 dB)

### Modifications Made During Testing

No modifications were made to the EUT during testing

### Deviations From The Standard

No deviations were made from the requirements of the standard.

### Sample Notes

Sample S/N: BT37140006



# EMC Test Data

Client:	Energous	Job Number:	J96937
Model:	MLA-1599	T-Log Number:	T96943
Contact:	FW Miller	Project Manager:	Irene Rademacher
Standard:	FCC 15.247	Project Coordinator:	-
		Class:	N/A

## Procedure Comments:

Measurements performed in accordance with FCC KDB 558074

Peak measurements performed with: RBW=1MHz, VBW=3MHz, peak detector, max hold, auto sweep time

Unless otherwise stated/noted, emission has duty cycle  $\geq 98\%$  and was measured using RBW=1MHz, VBW=10Hz, peak detector, linear average mode, auto sweep time, max hold.

Mode	Data Rate	Duty Cycle (x)	Constant DC?	T (ms)	Pwr Cor Factor*	Lin Volt Cor Factor**	Min VBW for FS (Hz)
BLE	-	0.64	Yes	0.619	1.9	3.9	1616

## Measurement Specific Notes:

Note 1:	Emission in non-restricted band, but limit of 15.209 used.
Note 2:	Emission in non-restricted band, the limit was set 30dB below the level of the fundamental and measured in 100kHz.
Note 3:	Emission has duty cycle $< 98\%$ , but constant, average measurement performed: RBW=1MHz, VBW=10Hz, peak detector, linear averaging, auto sweep, trace average 100 traces, measurement corrected by Linear Voltage correction factor
Note 6:	Plots of the average and peak bandedge do not account for any duty cycle correction. Refer to the tabular results for final measurements.



# EMC Test Data

Client: Energous	Job Number: J96937
Model: MLA-1599	T-Log Number: T96943
Contact: FW Miller	Project Manager: Irene Rademacher
Standard: FCC 15.247	Project Coordinator: -
	Class: N/A

### Run #1: Radiated Bandedge Measurements

Date of Test: 12/30/2014 0:00

Test Engineer: John Caizzi

Test Location: FT Chamber #4

Config. Used: 1

Config Change: None

EUT Voltage: 120V/60Hz

Channel: 2404 MHz Mode: BLE

Tx Chain: Main Data Rate:

### Band Edge Signal Field Strength - Direct measurement of field strength

Frequency	Level	Pol	15.209 / 15.247		Detector	Azimuth	Height	Comments
MHz	dB $\mu$ V/m	v/h	Limit	Margin	Pk/QP/Avg	degrees	meters	
2355.930	37.8	H	54.0	-16.2	AVG	236	1.21	Notes 3 & 6
2389.600	55.2	H	74.0	-18.8	PK	236	1.21	
2367.070	38.5	V	54.0	-15.5	AVG	89	1.03	Notes 3 & 6
2374.930	48.4	V	74.0	-25.6	PK	89	1.03	

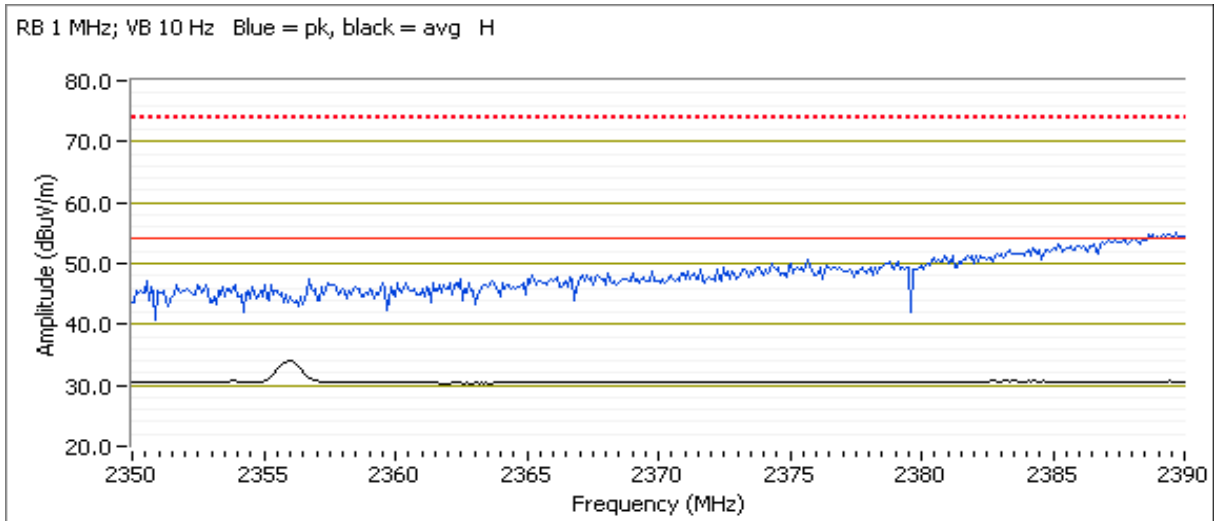

Client: Energous	Job Number: J96937
Model: MLA-1599	T-Log Number: T96943
	Project Manager: Irene Rademacher
Contact: FW Miller	Project Coordinator: -
Standard: FCC 15.247	Class: N/A

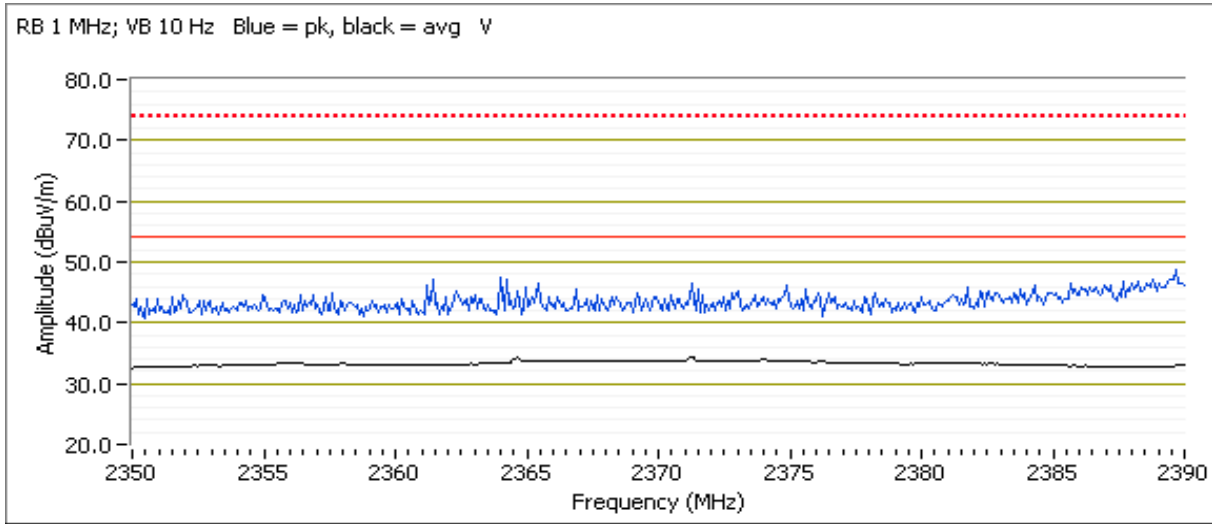



# EMC Test Data

Client: Energous	Job Number: J96937
Model: MLA-1599	T-Log Number: T96943
Contact: FW Miller	Project Manager: Irene Rademacher
Standard: FCC 15.247	Project Coordinator: -
	Class: N/A

## RSS 210 and FCC 15.247 (DTS) Radiated Spurious Emissions

### Test Specific Details

Objective: The objective of this test session is to perform Final Qualification testing of the EUT with respect to the specification listed above.

### General Test Configuration

The EUT and all local support equipment were located on the turntable for radiated spurious emissions testing.

For radiated emissions testing the measurement antenna was located 3 meters from the EUT, unless otherwise noted.

### Ambient Conditions:

Temperature: 21.4 °C  
Rel. Humidity: 38 %

### Summary of Results - Device Operating in the 2400-2483.5 MHz Band

Run #	Mode	Channel	Target Power	Power Setting	Test Performed	Limit	Result / Margin
1	BLE	2404 MHz	-	Default	Radiated Spurious Emissions	FCC Part 15.209 / 15.247( c)	51.2 dBµV/m @ 7211.5 MHz (-2.8 dB)

### Modifications Made During Testing

No modifications were made to the EUT during testing

### Deviations From The Standard

No deviations were made from the requirements of the standard.

### Sample Notes

Sample S/N: BT37140006

### Procedure Comments:

Measurements performed in accordance with FCC KDB 558074

Peak measurements performed with: RBW=1MHz, VBW=3MHz, peak detector, max hold, auto sweep time

Unless otherwise stated/noted, emission has duty cycle ≥ 98% and was measured using RBW=1MHz, VBW=10Hz, peak detector, linear average mode, auto sweep time, max hold.

2.4GHz band reject filter used



# EMC Test Data

Client:	Energous	Job Number:	J96937
Model:	MLA-1599	T-Log Number:	T96943
Contact:	FW Miller	Project Manager:	Irene Rademacher
Standard:	FCC 15.247	Project Coordinator:	-
		Class:	N/A

Mode	Data Rate	Duty Cycle (x)	Constant DC?	T (ms)	Pwr Cor Factor*	Lin Volt Cor Factor**	Min VBW for FS (Hz)
BLE	-	0.64	Yes	0.619	1.9	3.9	1616

### Measurement Specific Notes:

Note 1:	Emission in non-restricted band, but limit of 15.209 used.
Note 2:	Emission in non-restricted band, the limit was set 30dB below the level of the fundamental and measured in 100kHz.
Note 3:	Emission has duty cycle < 98%, but constant, average measurement performed: RBW=1MHz, VBW=10Hz, peak detector, linear averaging, auto sweep, trace average 100 traces, measurement corrected by Linear Voltage correction factor

Client: Energous	Job Number: J96937
Model: MLA-1599	T-Log Number: T96943
Contact: FW Miller	Project Manager: Irene Rademacher
Standard: FCC 15.247	Project Coordinator: -
	Class: N/A

**Run #1: Radiated Spurious Emissions, 30 - 25000 MHz. Operating Mode: BLE**

Date of Test: 12/30/2014 0:00  
 Test Engineer: John Caizzi  
 Test Location: FT Chamber #4

Config. Used: 1  
 Config Change: None  
 EUT Voltage: 120V/60Hz

**Run #1a: Low Channel**

Channel: 2404 MHz                      Mode: BLE  
 Tx Chain: Main

Frequency MHz	Level dB $\mu$ V/m	Pol v/h	15.209 / 15.247		Detector Pk/QP/Avg	Azimuth degrees	Height meters	Comments
			Limit	Margin				
1596.200	29.8	V	54.0	-24.2	AVG	144	1.0	Note 3
1595.870	37.5	V	74.0	-36.5	PK	144	1.0	
4807.860	42.1	H	54.0	-11.9	AVG	221	1.26	Note 3
4808.560	47.6	H	74.0	-26.4	PK	221	1.26	
7211.450	51.2	V	54.0	-2.8	AVG	84	1.23	Notes 1 & 3
7212.450	55.6	V	74.0	-14.4	PK	84	1.23	

Note 4: Measurements not taken < 1 GHz and > 12 GHz as previous scans on other channels showed no emissions above 12 GHz, and all emissions below 1 GHz were independent of the operating channel.

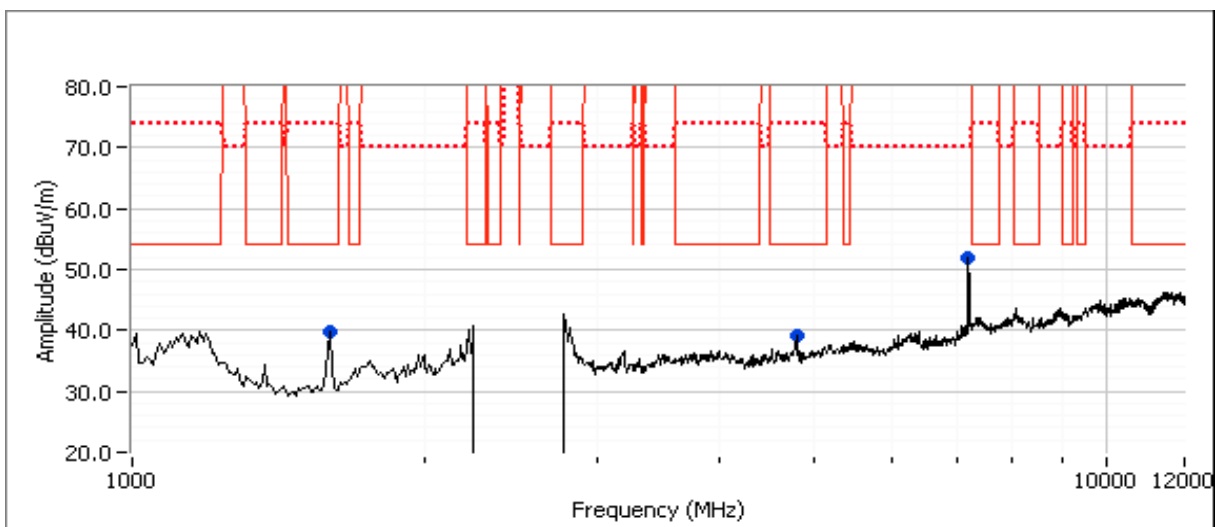



# EMC Test Data

Client: Energous	Job Number: J96937
Model: MLA-1599	T-Log Number: T96943
	Project Manager: Irene Rademacher
Contact: FW Miller	Project Coordinator: -
Standard: FCC 15.247	Class: N/A

## RSS 210 and FCC 15.247 (DTS) Antenna Port Measurements Power, PSD, Bandwidth and Spurious Emissions

### Test Specific Details

Objective: The objective of this test session is to perform final qualification testing of the EUT with respect to the specification listed above.

Date of Test: 12/23/2014  
 Test Engineer: Joseph Cadigal  
 Test Location: Fremont Chamber #4

Config. Used: 1  
 Config Change: None  
 EUT Voltage: 120V/60Hz

### General Test Configuration

The EUT was connected to the spectrum analyzer or power meter via a suitable attenuator. All measurements were made on a single chain.

All measurements have been corrected to allow for the external attenuators used.

### Ambient Conditions:

Temperature: 20.6 °C  
 Rel. Humidity: 38 %

### Summary of Results

Run #	Pwr setting	Avg Pwr	Test Performed	Limit	Pass / Fail	Result / Margin
1	Default		Output Power	15.247(b)	Pass	3.3 dBm
2	Default		Power spectral Density (PSD)	15.247(d)	Pass	0.7 dBm/100kHz
3	Default		Minimum 6dB Bandwidth	15.247(a)	Pass	0.782 MHz
3	Default		99% Bandwidth	RSS GEN	-	1.8 MHz

### Modifications Made During Testing

No modifications were made to the EUT during testing

### Deviations From The Standard

No deviations were made from the requirements of the standard.





# EMC Test Data

Client: Energous	Job Number: J96937
Model: MLA-1599	T-Log Number: T96943
	Project Manager: Irene Rademacher
Contact: FW Miller	Project Coordinator: -
Standard: FCC 15.247	Class: N/A

## Procedure Comments:

Measurements performed in accordance with FCC KDB 558074

Mode	Data Rate	Duty Cycle (x)	Constant DC?	T (ms)	Pwr Cor Factor*	Lin Volt Cor Factor**	Min VBW for FS (Hz)
BLE	-	0.64	yes	0.619	1.9	3.9	1616

## Sample Notes

Sample S/N: BT37140006

Client: Energous	Job Number: J96937
Model: MLA-1599	T-Log Number: T96943
Contact: FW Miller	Project Manager: Irene Rademacher
Standard: FCC 15.247	Project Coordinator: -
	Class: N/A

### Run #1: Output Power

Mode: BLE

Power Setting <sup>2</sup>	Frequency (MHz)	Output Power (EIRP)		Antenna Gain (dBi)	Result	Output Power		Output Power	
		(dBm) <sup>1</sup>	mW			dBm	W	(dBm) <sup>3</sup>	mW
Default	2404	3.3	2.1	1.0	Pass	2.3	0.0017		

- Note 1: Output power calculated from measured field strength using an analyzer (Radiated Method), Max Hold, Peak Detector, 60 sweeps, RBW 3MHz and VBW 3MHz
- Note 2: Power setting - the software power setting used during testing, included for reference only.
- Note 3: Power measured using average power meter (non-gated) and is included for reference only.

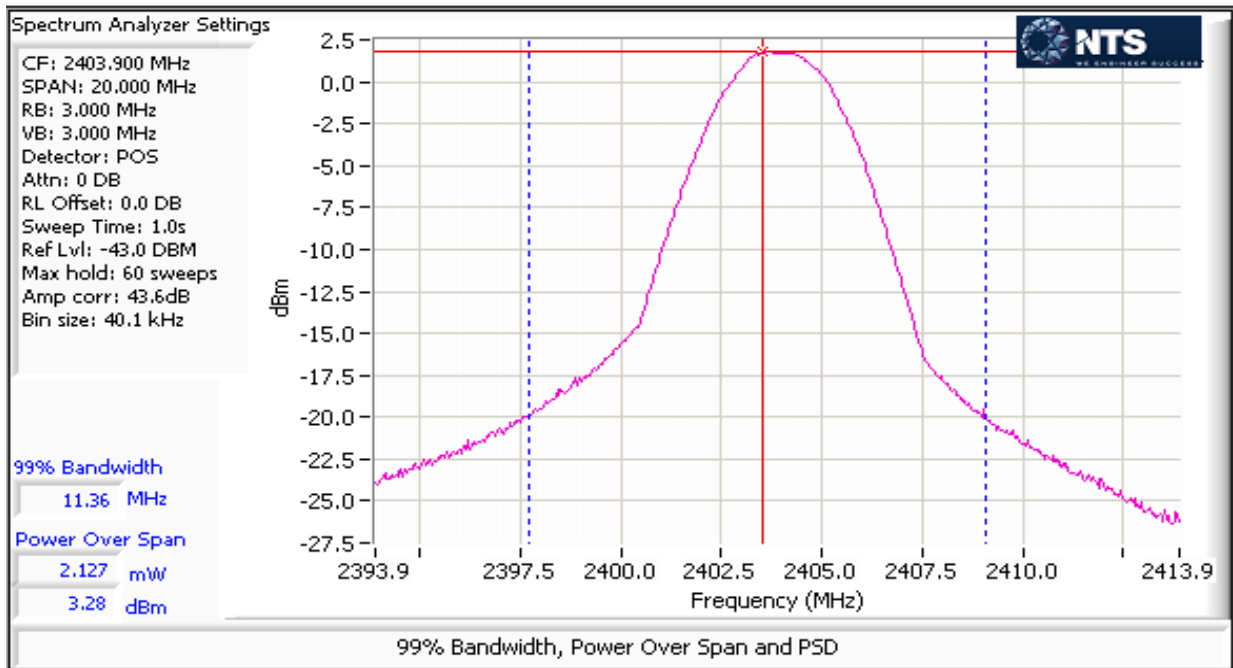



# EMC Test Data

Client: Energous	Job Number: J96937
Model: MLA-1599	T-Log Number: T96943
Contact: FW Miller	Project Manager: Irene Rademacher
Standard: FCC 15.247	Project Coordinator: -
	Class: N/A

## Run #2: Power spectral Density

Mode: BLE

Power Setting	Frequency (MHz)	PSD	Limit	Result
		(dBm/100kHz) <small>Note 1</small>		
Default	2404	0.7	8.0	Pass

Note 1: Test performed per method PKSPD, in KDB 558074. Power spectral density measured using:  $3\text{kHz} \leq \text{RBW} \leq 100\text{kHz}$ ,  $\text{VBW}=3*\text{RBW}$ , peak detector, span =  $1.5*\text{DTS BW}$ , auto sweep time, max hold.

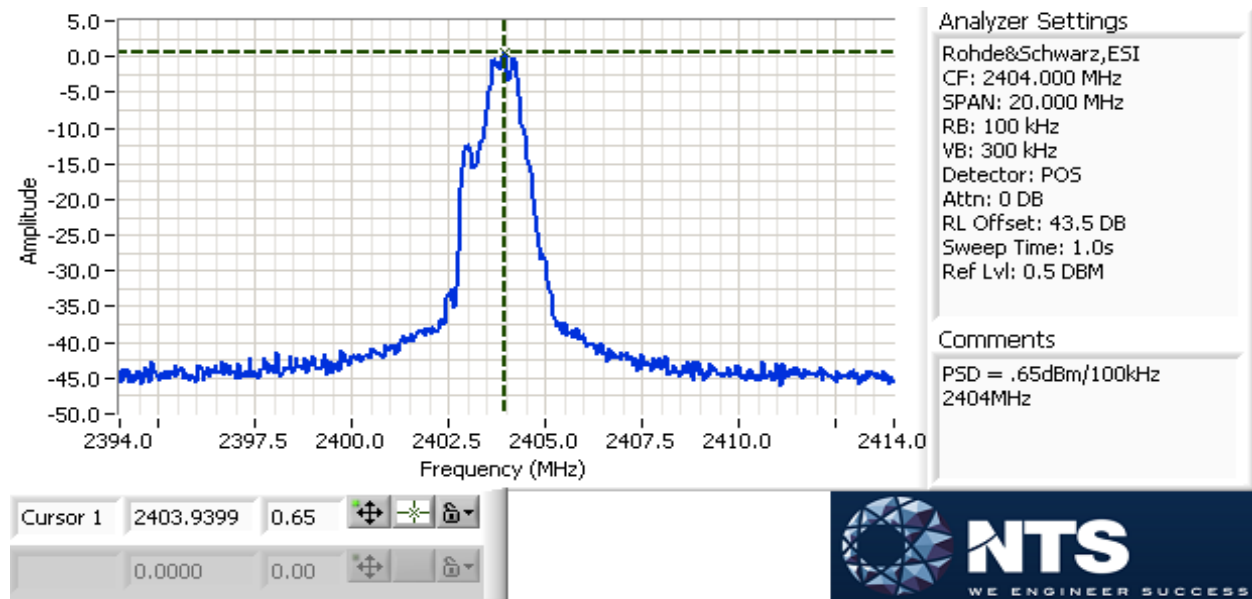

The plot shows that outside the 2400-2483.5 MHz band, the signal is more than 20 dB below the in band level.

Client: Energous	Job Number: J96937
Model: MLA-1599	T-Log Number: T96943
Contact: FW Miller	Project Manager: Irene Rademacher
Standard: FCC 15.247	Project Coordinator: -
	Class: N/A

### Run #3: Signal Bandwidth

Mode: BLE

Power Setting	Frequency (MHz)	Bandwidth (MHz)		RBW Setting (MHz)	
		6dB	99%	6dB	99%
Default	2404	0.782	1.8	100kHz	10kHz

Note 1: DTS BW: RBW=100kHz, VBW ≥ 3\*RBW, peak detector, max hold, auto sweep time.  
 99% BW: RBW=1-5% of of 99%BW, VBW ≥ 3\*RBW, peak detector, max hold, auto sweep time.

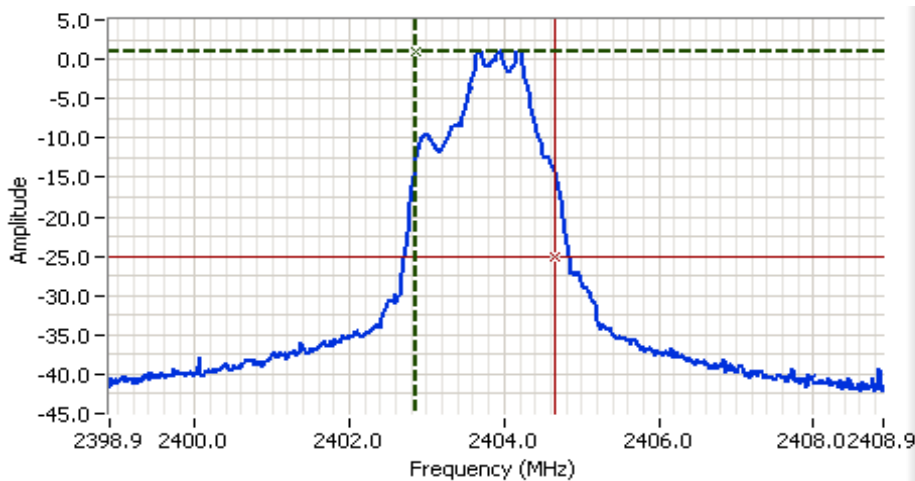

#### Analyzer Settings

Rohde&Schwarz, ESI  
 CF: 2403.900 MHz  
 SPAN: 10.000 MHz  
 RB: 100 kHz  
 VB: 300 kHz  
 Detector: POS  
 Attn: 0 DB  
 RL Offset: 43.5 DB  
 Sweep Time: 1.0s  
 Ref Lvl: 0.5 DBM

#### Comments

99% power BW: 1.800 MHz  
 2404MHz

Cursor 1	2402.8600	1.00	
Cursor 2	2404.6600	-25.00	

Delta Freq. 1.800  
 Delta Amplitude 26.00



Client: Energous	Job Number: J96937
Model: MLA-1599	T-Log Number: T96943
Contact: FW Miller	Project Manager: Irene Rademacher
Standard: FCC 15.247	Project Coordinator: -
	Class: N/A

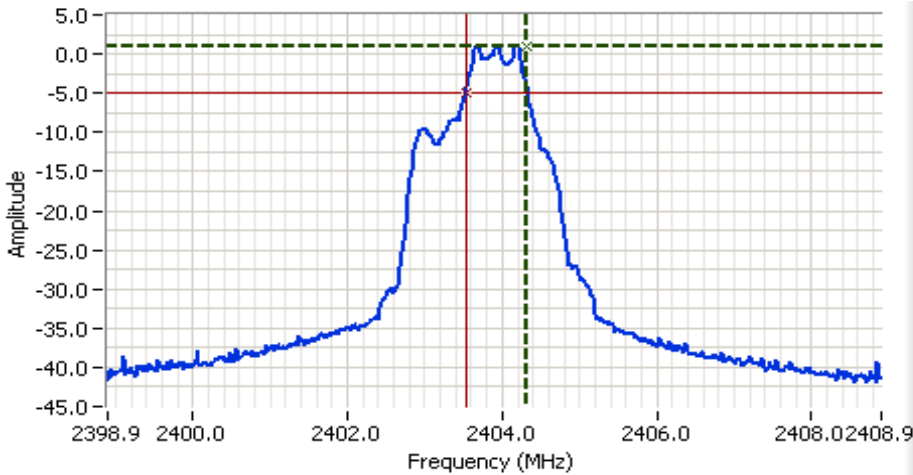

**Analyzer Settings**

Rohde&Schwarz,ESI  
 CF: 2403.900 MHz  
 SPAN: 10.000 MHz  
 RB: 100 kHz  
 VB: 300 kHz  
 Detector: POS  
 Attn: 0 DB  
 RL Offset: 43.5 DB  
 Sweep Time: 1.0s  
 Ref Lvl: 0.5 DBM

**Comments**

6dB BW: 782 kHz  
 2404MHz

Cursor 1	2404.3108	1.01	
Cursor 2	2403.5293	-4.99	

Delta Freq.	782 kHz
Delta Amplitude	6.00





# EMC Test Data

Client: Energous	Job Number: J96937
Model: MLA-1599	T-Log Number: T96943
	Project Manager: Irene Rademacher
Contact: FW Miller	Project Coordinator: -
Standard: FCC 15.247	Class: N/A

## RSS 210 and FCC 15.247 (DTS) Measurements Power, PSD and Bandwidth

### Test Specific Details

Objective: The objective of this test session is to perform final qualification testing of the EUT with respect to the specification listed above.

Date of Test: 11/25/2014  
 Test Engineer: Rafael Varelas  
 Test Location: Fremont Chamber #4

Config. Used: 1  
 Config Change: None  
 EUT Voltage: 120V/60Hz

### General Test Configuration

The EUT and all local support equipment were located on the turntable for radiated spurious emissions testing. For radiated emissions testing the measurement antenna was located 3 meters from the EUT, unless otherwise noted.

### Ambient Conditions:

Temperature: 20.6 °C  
 Rel. Humidity: 38 %

### Summary of Results

Run #	Pwr setting	Test Performed	Limit	Pass / Fail	Result / Margin
1	Default	Output Power	15.247(b)	Pass	-4.1 dBm
2	Default	Power spectral Density (PSD)	15.247(d)	Pass	-7.4 dBm/100kHz
3	Default	Minimum 6dB Bandwidth	15.247(a)	Pass	0.741 MHz
3	Default	99% Bandwidth	RSS GEN	-	1.24 MHz

### Modifications Made During Testing

No modifications were made to the EUT during testing

### Deviations From The Standard

No deviations were made from the requirements of the standard.



# EMC Test Data

Client: Energous	Job Number: J96937
Model: MLA-1599	T-Log Number: T96943
	Project Manager: Irene Rademacher
Contact: FW Miller	Project Coordinator: -
Standard: FCC 15.247	Class: N/A

## Procedure Comments:

Measurements performed in accordance with FCC KDB 558074

Mode	Data Rate	Duty Cycle (x)	Constant DC?	T (ms)	Pwr Cor Factor*	Lin Volt Cor Factor**	Min VBW for FS (Hz)
BLE	-	0.64	yes	0.619	1.9	3.9	1616

## Sample Notes

Sample S/N: BT37140006

### Run #1: Output Power

Mode: BLE

Power Setting <sup>2</sup>	Frequency (MHz)	Output Power (EIRP)		Antenna Gain (dBi)	Result	Output Power		Output Power	
		(dBm) <sup>1</sup>	mW			dBm	W	(dBm) <sup>3</sup>	mW
Default	2440	-4.1	0.4	1.0	Pass	-5.1	0.000		
Default	2480	-6.1	0.2	1.0	Pass	-7.1	0.000		

Note 1:	Output power calculated from measured field strength using an analyzer (Radiated Method), Max Hold, Peak Detector, 60 sweeps, RBW 3MHz and VBW 3MHz
Note 2:	Power setting - the software power setting used during testing, included for reference only.
Note 3:	Power measured using average power meter (non-gated) and is included for reference only.

Client: Energous	Job Number: J96937
Model: MLA-1599	T-Log Number: T96943
Contact: FW Miller	Project Manager: Irene Rademacher
Standard: FCC 15.247	Project Coordinator: -
	Class: N/A

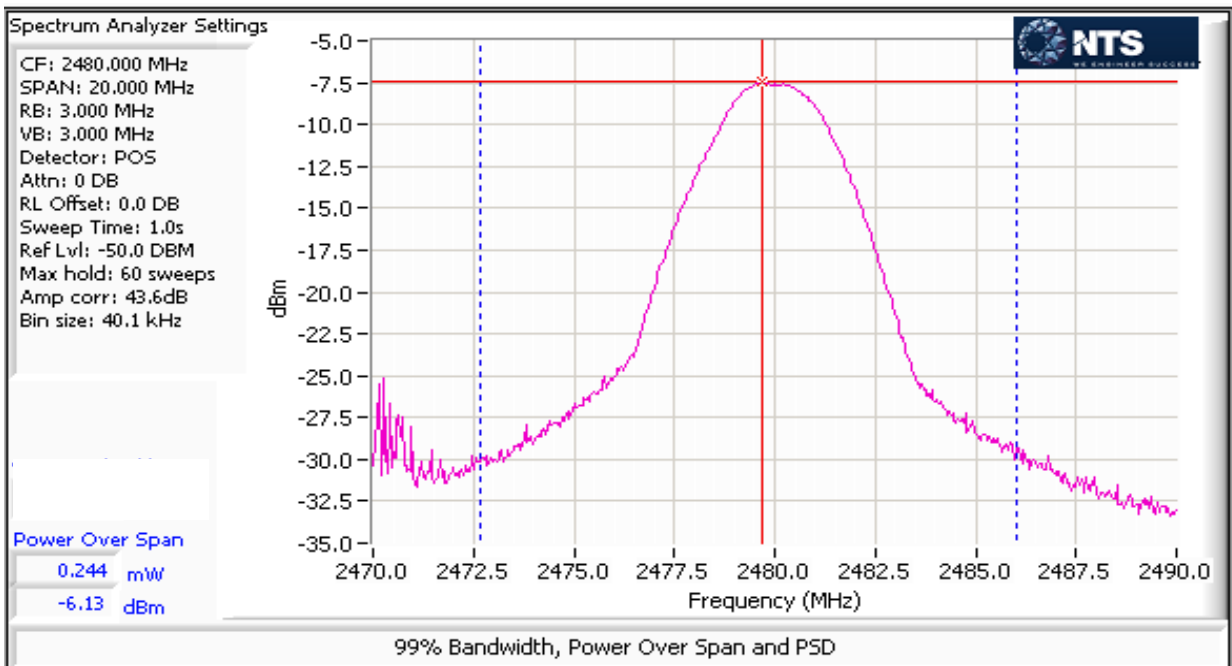
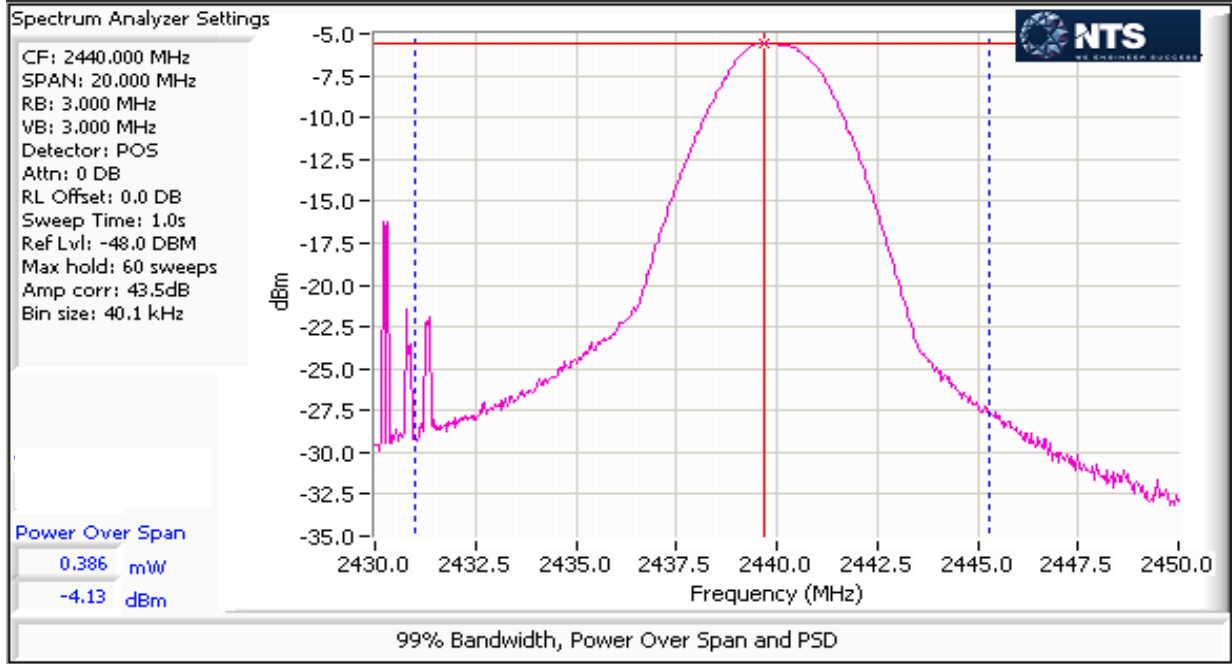



Client: Energous	Job Number: J96937
Model: MLA-1599	T-Log Number: T96943
Contact: FW Miller	Project Manager: Irene Rademacher
Standard: FCC 15.247	Project Coordinator: -
	Class: N/A

## Run #2: Power spectral Density

Mode: BLE

Power Setting	Frequency (MHz)	PSD (EIRP) (dBm/100kHz) <sup>Note 1</sup>	Antenna Gain	PSD dBm	Limit dBm/3kHz	Result
Default	2440	-6.4	1.0	-7.4	8.0	Pass
Default	2480	-8.7	1.0	-9.7	8.0	Pass

Note 1: Test performed per method PKSPD, in KDB 558074. Power spectral density measured using:  $3\text{kHz} \leq \text{RBW} \leq 100\text{kHz}$ ,  $\text{VBW}=3*\text{RBW}$ , peak detector, span =  $1.5*\text{DTS BW}$ , auto sweep time, max hold.

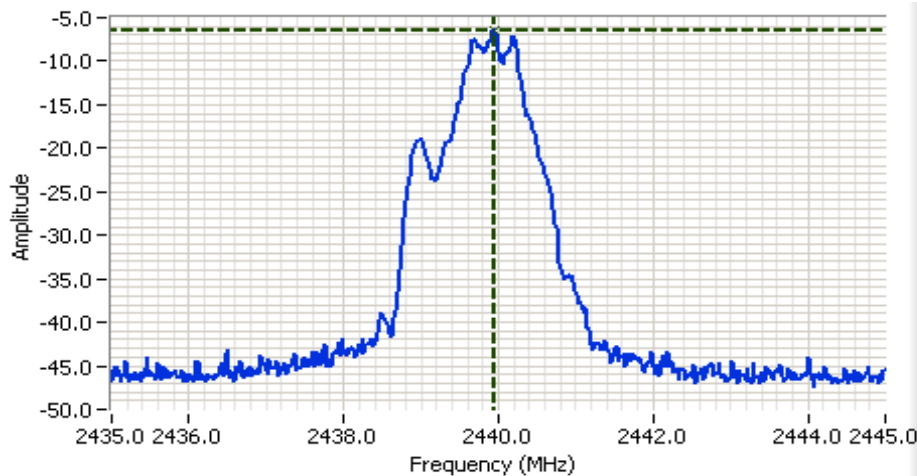

### Analyzer Settings

Rohde&Schwarz,ESI  
 CF: 2440.000 MHz  
 SPAN: 10.000 MHz  
 RB: 100 kHz  
 VB: 300 kHz  
 Detector: POS  
 Attn: 0 DB  
 RL Offset: 43.5 DB  
 Sweep Time: 1.0s  
 Ref Lvl: 0.5 DBM

### Comments

PSD = -6.4 dBm/100kHz  
 2440 MHz

Cursor 1	2439.9499	-6.40	
	0.0000	0.00	

Client: Energous	Job Number: J96937
Model: MLA-1599	T-Log Number: T96943
Contact: FW Miller	Project Manager: Irene Rademacher
Standard: FCC 15.247	Project Coordinator: -
	Class: N/A

### Run #3: Signal Bandwidth

Mode: BLE

Power Setting	Frequency (MHz)	Bandwidth (MHz)		RBW Setting (MHz)	
		6dB	99%	6dB	99%
Default	2440	0.741	1.24	100kHz	10kHz
Default	2480	0.741	1.22	100kHz	10kHz

Note 1: DTS BW: RBW=100kHz, VBW ≥ 3\*RBW, peak detector, max hold, auto sweep time.  
 99% BW: RBW=1-5% of of 99%BW, VBW ≥ 3\*RBW, peak detector, max hold, auto sweep time.

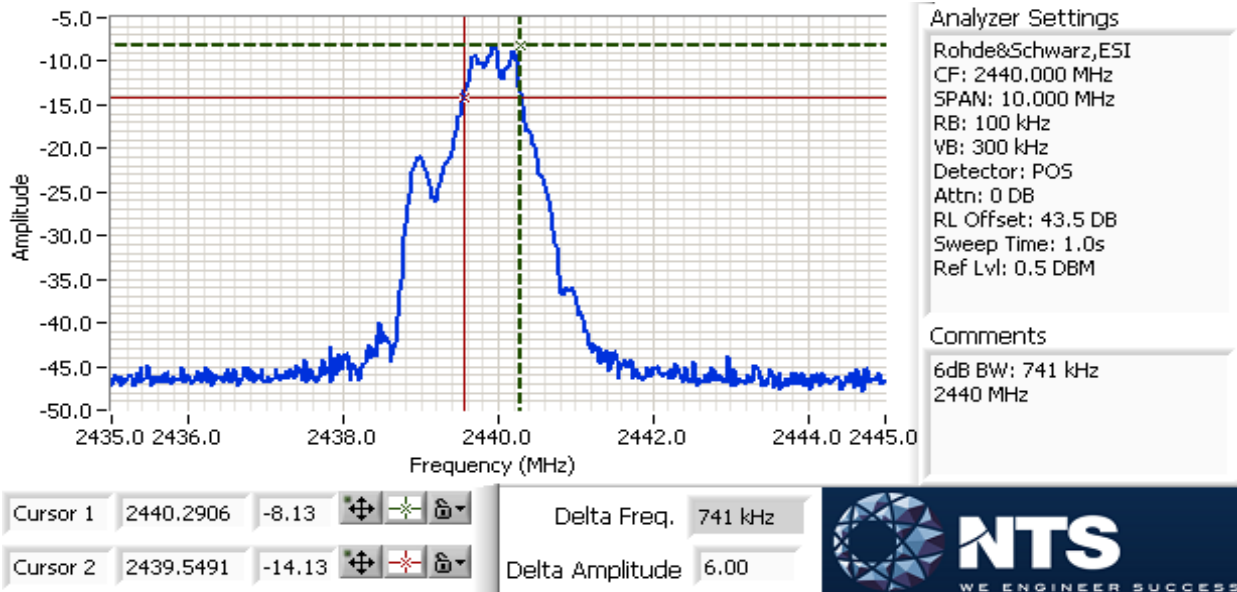



# EMC Test Data

Client: Energous	Job Number: J96937
Model: MLA-1599	T-Log Number: T96943
	Project Manager: Irene Rademacher
Contact: FW Miller	Project Coordinator: -
Standard: FCC 15.247	Class: N/A

## RSS 210 and FCC 15.247 (DTS) Radiated Spurious Emissions

### Test Specific Details

Objective: The objective of this test session is to perform Final Qualification testing of the EUT with respect to the specification listed above.

### General Test Configuration

The EUT and all local support equipment were located on the turntable for radiated spurious emissions testing. For radiated emissions testing the measurement antenna was located 3 meters from the EUT, unless otherwise noted.

### Ambient Conditions:

Temperature: 21.4 °C  
Rel. Humidity: 38 %

### Summary of Results - Device Operating in the 2400-2483.5 MHz Band

Run #	Mode	Channel	Target Power	Power Setting	Test Performed	Limit	Result / Margin
1	BLE	2480 MHz	-	Default	Restricted Band Edge (2483.5 MHz)	FCC Part 15.209 / 15.247( c)	34.9 dBµV/m @ 2493.6 MHz (-19.2 dB)

### Modifications Made During Testing

No modifications were made to the EUT during testing

### Deviations From The Standard

No deviations were made from the requirements of the standard.

### Sample Notes

Sample S/N: BT37140006



# EMC Test Data

Client:	Energous	Job Number:	J96937
Model:	MLA-1599	T-Log Number:	T96943
		Project Manager:	Irene Rademacher
Contact:	FW Miller	Project Coordinator:	-
Standard:	FCC 15.247	Class:	N/A

## Procedure Comments:

Measurements performed in accordance with FCC KDB 558074

Peak measurements performed with: RBW=1MHz, VBW=3MHz, peak detector, max hold, auto sweep time

Unless otherwise stated/noted, emission has duty cycle  $\geq 98\%$  and was measured using RBW=1MHz, VBW=10Hz, peak detector, linear average mode, auto sweep time, max hold.

Mode	Data Rate	Duty Cycle (x)	Constant DC?	T (ms)	Pwr Cor Factor*	Lin Volt Cor Factor**	Min VBW for FS (Hz)
BLE	-	0.64	yes	0.619	1.9	3.9	1616

## Measurement Specific Notes:

Note 1:	Emission in non-restricted band, but limit of 15.209 used.
Note 2:	Emission in non-restricted band, the limit was set 30dB below the level of the fundamental and measured in 100kHz.
Note 2:	Emission has duty cycle $\geq 98\%$ , average measurement performed: RBW=1MHz, VBW=3MHz, RMS, Power averaging, auto sweep, trace average 100 traces
Note 3:	Emission has duty cycle $< 98\%$ , but constant, average measurement performed: RBW=1MHz, VBW=10Hz, peak detector, linear averaging, auto sweep, trace average 100 traces, measurement corrected by Linear Voltage correction factor
Note 4:	Emission has duty cycle $< 98\%$ and is NOT constant, average measurement performed: RBW=1MHz, VBW $> 1/T$ , peak detector, linear average mode, sweep time auto, max hold. Max hold for $50 \cdot (1/DC)$ traces
Note 5:	Emission has duty cycle $< 98\%$ , but constant, average measurement performed: RBW=1MHz, VBW=3MHz, RMS, Power averaging, auto sweep, trace average 100 traces, measurement corrected by Pwr correction factor
Note 6:	Plots of the average and peak bandedge do not account for any duty cycle correction. Refer to the tabular results for final measurements.



# EMC Test Data

Client: Energous	Job Number: J96937
Model: MLA-1599	T-Log Number: T96943
	Project Manager: Irene Rademacher
Contact: FW Miller	Project Coordinator: -
Standard: FCC 15.247	Class: N/A

### Run #1: Radiated Bandedge Measurements

Date of Test: 11/24/2014 0:00

Config. Used: 1

Test Engineer: Rafael Varelas

Config Change: None

Test Location: FT Chamber #4

EUT Voltage: 120V/60Hz

Channel: 2480 MHz Mode: BLE

Tx Chain: Main Data Rate:

### Band Edge Signal Field Strength - Direct measurement of field strength

Frequency	Level	Pol	15.209 / 15.247		Detector	Azimuth	Height	Comments
MHz	dB $\mu$ V/m	v/h	Limit	Margin	Pk/QP/Avg	degrees	meters	
2493.590	34.9	H	54.0	-19.2	AVG	154	1.0	Note 3, POS; RB 1 MHz; VB: 10 Hz
2484.100	56.2	H	74.0	-17.8	PK	154	1.0	POS; RB 1 MHz; VB: 3 MHz
2493.680	34.8	V	54.0	-19.3	AVG	292	1.0	Note 3, POS; RB 1 MHz; VB: 10 Hz
2483.830	51.9	V	74.0	-22.1	PK	292	1.0	POS; RB 1 MHz; VB: 3 MHz

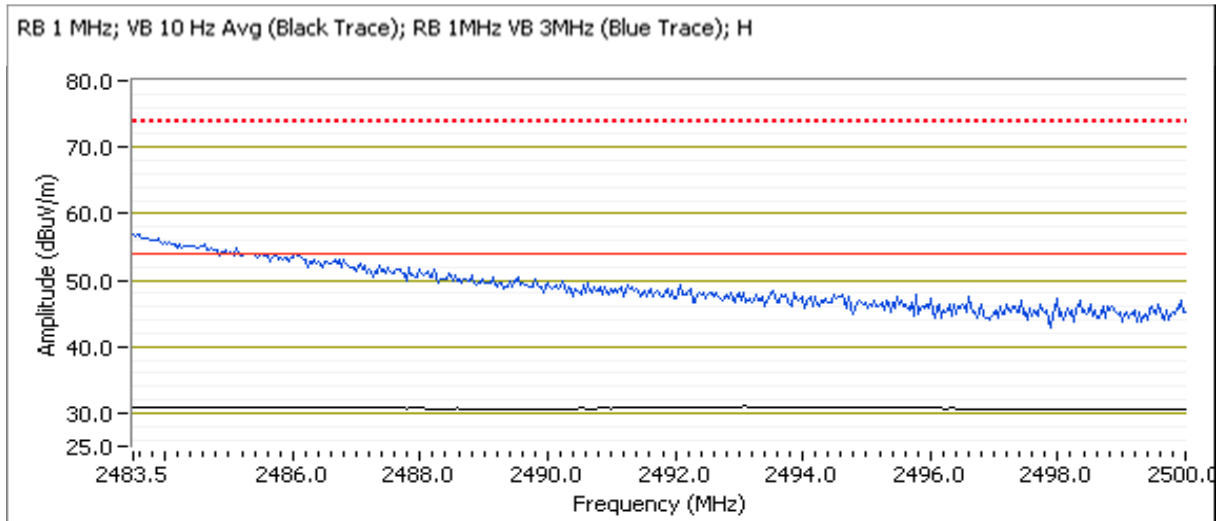



# EMC Test Data

Client: Energous	Job Number: J96937
Model: MLA-1599	T-Log Number: T96943
	Project Manager: Irene Rademacher
Contact: FW Miller	Project Coordinator: -
Standard: FCC 15.247	Class: N/A

## RSS 210 and FCC 15.247 (DTS) Radiated Spurious Emissions

### Test Specific Details

Objective: The objective of this test session is to perform Final Qualification testing of the EUT with respect to the specification listed above.

### General Test Configuration

The EUT and all local support equipment were located on the turntable for radiated spurious emissions testing.

For radiated emissions testing the measurement antenna was located 3 meters from the EUT, unless otherwise noted.

### Ambient Conditions:

Temperature: 21.4 °C  
Rel. Humidity: 38 %

### Summary of Results - Device Operating in the 2400-2483.5 MHz Band

Run #	Mode	Channel	Target Power	Power Setting	Test Performed	Limit	Result / Margin
1	BLE	2440 MHz	-	Default	Radiated Emissions, 30 MHz - 25 GHz	FCC Part 15.209 / 15.247( c)	48.6 dBµV/m @ 7319.2 MHz (-5.5 dB)
	BLE	2480 MHz	-	Default	Radiated Emissions, 30 MHz - 25 GHz	FCC Part 15.209 / 15.247( c)	47.6 dBµV/m @ 7439.2 MHz (-6.5 dB)

### Modifications Made During Testing

No modifications were made to the EUT during testing

### Deviations From The Standard

No deviations were made from the requirements of the standard.

### Sample Notes

Sample S/N: BT37140006



# EMC Test Data

Client:	Energous	Job Number:	J96937
Model:	MLA-1599	T-Log Number:	T96943
Contact:	FW Miller	Project Manager:	Irene Rademacher
Standard:	FCC 15.247	Project Coordinator:	-
		Class:	N/A

## Procedure Comments:

Measurements performed in accordance with FCC KDB 558074

Peak measurements performed with: RBW=1MHz, VBW=3MHz, peak detector, max hold, auto sweep time

Unless otherwise stated/noted, emission has duty cycle  $\geq 98\%$  and was measured using RBW=1MHz, VBW=10Hz, peak detector, linear average mode, auto sweep time, max hold.

2.4GHz band reject filter used

Mode	Data Rate	Duty Cycle (x)	Constant DC?	T (ms)	Pwr Cor Factor*	Lin Volt Cor Factor**	Min VBW for FS (Hz)
BLE	-	0.64	yes	0.619	1.9	3.9	1616

## Measurement Specific Notes:

Note 1:	Emission in non-restricted band, but limit of 15.209 used.
Note 2:	Emission in non-restricted band, the limit was set 30dB below the level of the fundamental and measured in 100kHz.
Note 2:	Emission has duty cycle $\geq 98\%$ , average measurement performed: RBW=1MHz, VBW=3MHz, RMS, Power averaging, auto sweep, trace average 100 traces
Note 3:	Emission has duty cycle $< 98\%$ , but constant, average measurement performed: RBW=1MHz, VBW=10Hz, peak detector, linear averaging, auto sweep, trace average 100 traces, measurement corrected by Linear Voltage correction factor
Note 4:	Emission has duty cycle $< 98\%$ and is NOT constant, average measurement performed: RBW=1MHz, VBW $> 1/T$ , peak detector, linear average mode, sweep time auto, max hold. Max hold for $50 \cdot (1/DC)$ traces
Note 5:	Emission has duty cycle $< 98\%$ , but constant, average measurement performed: RBW=1MHz, VBW=3MHz, RMS, Power averaging, auto sweep, trace average 100 traces, measurement corrected by Pwr correction factor
Note 6:	Plots of the average and peak bandedge do not account for any duty cycle correction. Refer to the tabular results for final measurements.



# EMC Test Data

Client: Energous	Job Number: J96937
Model: MLA-1599	T-Log Number: T96943
Contact: FW Miller	Project Manager: Irene Rademacher
Standard: FCC 15.247	Project Coordinator: -
	Class: N/A

Run #1: Radiated Spurious Emissions, 30 - 25000 MHz. Operating Mode: BLE  
 Date of Test: 11/24 & 11/25/14 Config. Used: 1  
 Test Engineer: Rafael Varelas Config Change: None  
 Test Location: FT Chamber #4 EUT Voltage: 120V/60Hz

### Run #1a: Center Channel

Channel: 2440 MHz Mode: BLE  
 Tx Chain: Main Data Rate:

Frequency	Level	Pol	15.209 / 15.247		Detector	Azimuth	Height	Comments
MHz	dB $\mu$ V/m	v/h	Limit	Margin	Pk/QP/Avg	degrees	meters	
7319.230	48.6	V	54.0	-5.5	AVG	323	1.4	Note 3, RB 1 MHz;VB 10 Hz;Peak
7320.620	55.2	V	74.0	-18.8	PK	323	1.4	RB 1 MHz;VB 3 MHz;Peak
4879.920	38.4	H	54.0	-15.7	AVG	161	1.0	Note 3, RB 1 MHz;VB 10 Hz;Peak
4880.210	46.1	H	74.0	-27.9	PK	161	1.0	RB 1 MHz;VB 3 MHz;Peak
1595.880	35.1	V	54.0	-19.0	AVG	347	1.0	Note 3, RB 1 MHz;VB 10 Hz;Peak
1595.490	41.8	V	74.0	-32.2	PK	347	1.0	RB 1 MHz;VB 3 MHz;Peak
38.086	9.0	V	40.0	-31.0	QP	5	1.0	QP (1.00s)
120.001	23.0	V	43.5	-20.5	QP	44	1.0	QP (1.00s)
192.171	13.3	V	43.5	-30.2	QP	78	1.0	Note 1, QP (1.00s)
108.000	12.5	V	43.5	-31.0	QP	92	0.9	note 1, QP (1.00s)

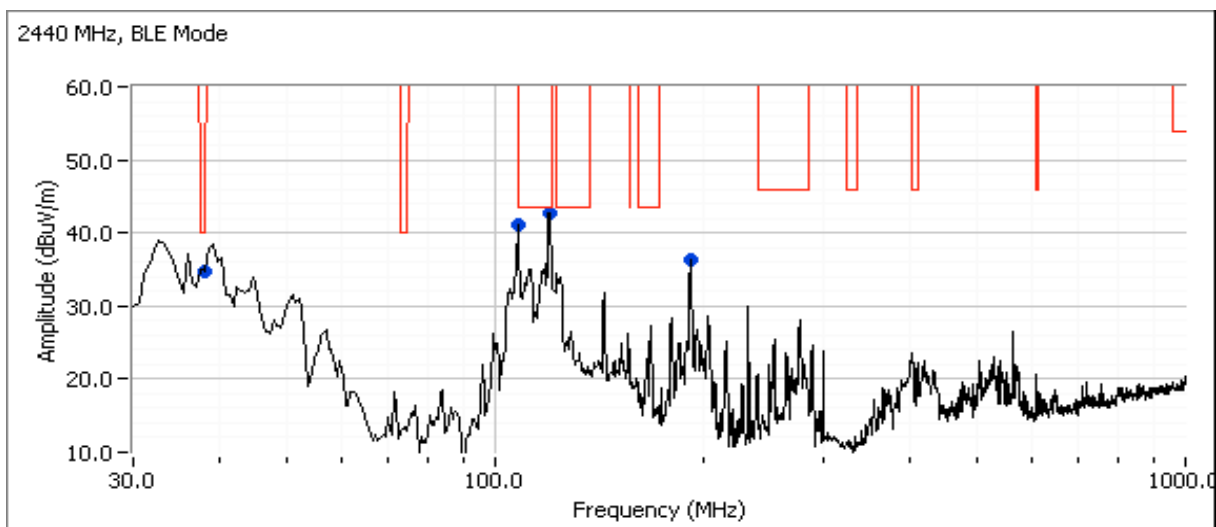



Client: Energous	Job Number: J96937
Model: MLA-1599	T-Log Number: T96943
Contact: FW Miller	Project Manager: Irene Rademacher
Standard: FCC 15.247	Project Coordinator: -
	Class: N/A

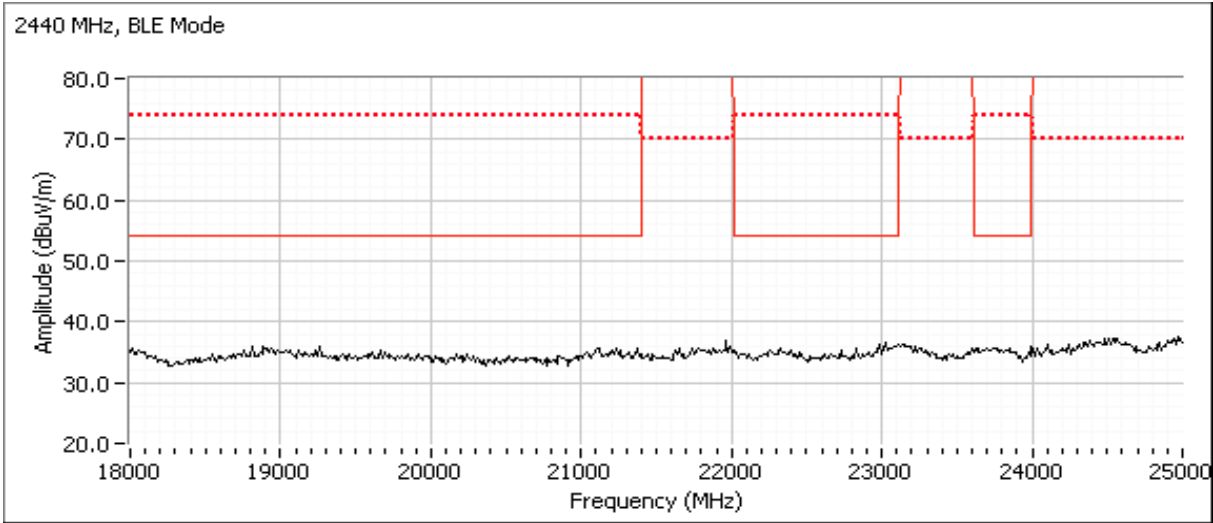
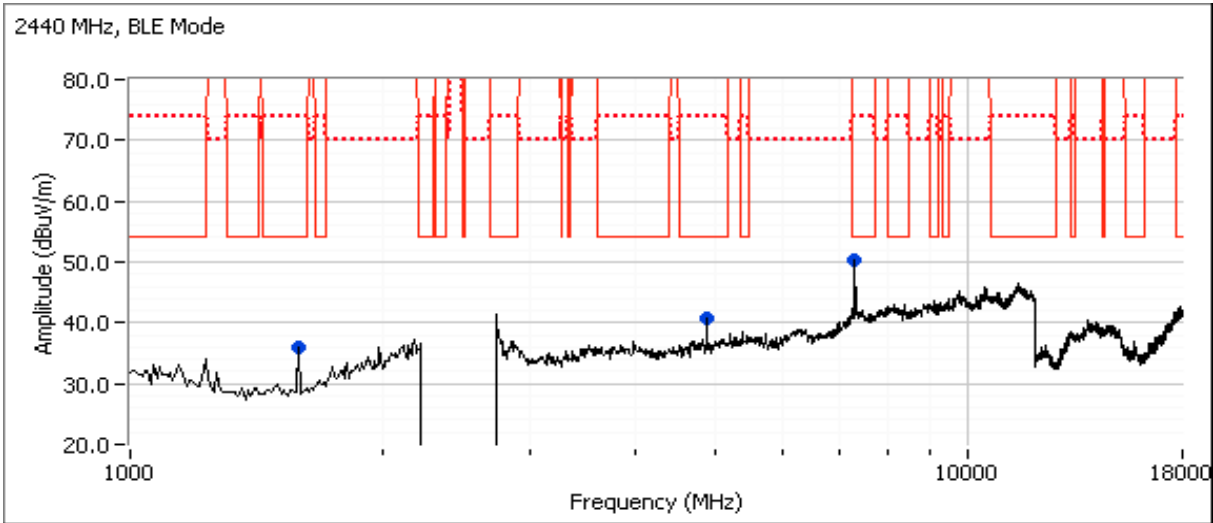

Client: Energous	Job Number: J96937
Model: MLA-1599	T-Log Number: T96943
Contact: FW Miller	Project Manager: Irene Rademacher
Standard: FCC 15.247	Project Coordinator: -
	Class: N/A

### Run #1b: High Channel

Channel: 2480 MHz      Mode: BLE  
 Tx Chain: Main      Data Rate:

Frequency MHz	Level dB $\mu$ V/m	Pol v/h	15.209 / 15.247		Detector Pk/QP/Avg	Azimuth degrees	Height meters	Comments
			Limit	Margin				
7439.230	47.6	V	54.0	-6.5	AVG	292	1.0	Note 3, RB 1 MHz;VB 10 Hz;Peak
7439.000	53.6	V	74.0	-20.4	PK	292	1.0	RB 1 MHz;VB 3 MHz;Peak
3192.580	38.0	V	54.0	-16.1	AVG	178	1.0	Note 1, Note 3, RB 1 MHz;VB 10 Hz;
3192.670	45.9	V	74.0	-28.1	PK	178	1.0	Note 1, RB 1 MHz;VB 3 MHz;Peak
4959.890	39.5	V	54.0	-14.6	AVG	304	1.2	Note 3, RB 1 MHz;VB 10 Hz;Peak
4960.730	46.4	V	74.0	-27.6	PK	304	1.2	RB 1 MHz;VB 3 MHz;Peak
1592.120	29.1	V	54.0	-25.0	AVG	336	1.0	Note 3, RB 1 MHz;VB 10 Hz;Peak
1593.240	36.5	V	74.0	-37.5	PK	336	1.0	RB 1 MHz;VB 3 MHz;Peak
37.778	7.9	V	40.0	-32.1	QP	41	1.0	QP (1.00s)
119.996	23.5	V	43.5	-20.0	QP	63	1.0	QP (1.00s)
191.998	11.9	V	43.5	-31.6	QP	66	1.0	Note 1, QP (1.00s)
107.984	11.5	V	43.5	-32.0	QP	109	1.0	Note 1, QP (1.00s)

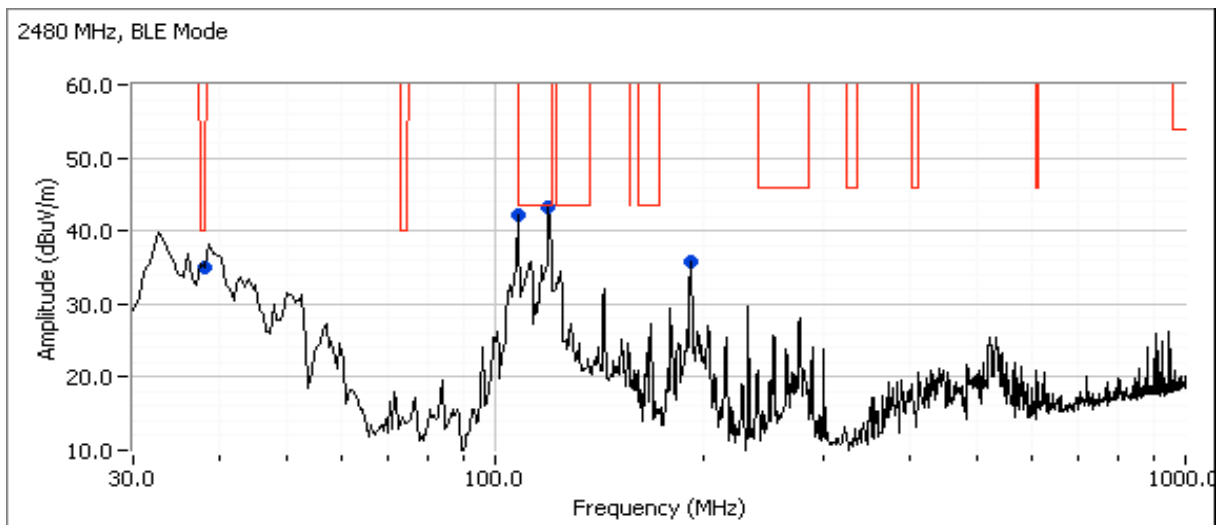

Client: Energous	Job Number: J96937
Model: MLA-1599	T-Log Number: T96943
Contact: FW Miller	Project Manager: Irene Rademacher
Standard: FCC 15.247	Project Coordinator: -
	Class: N/A

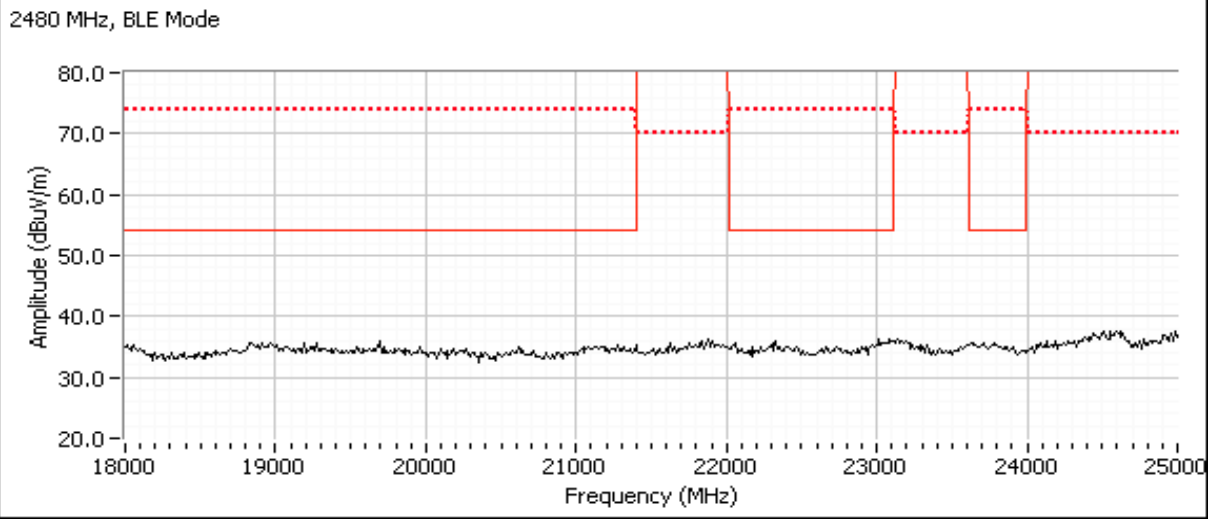
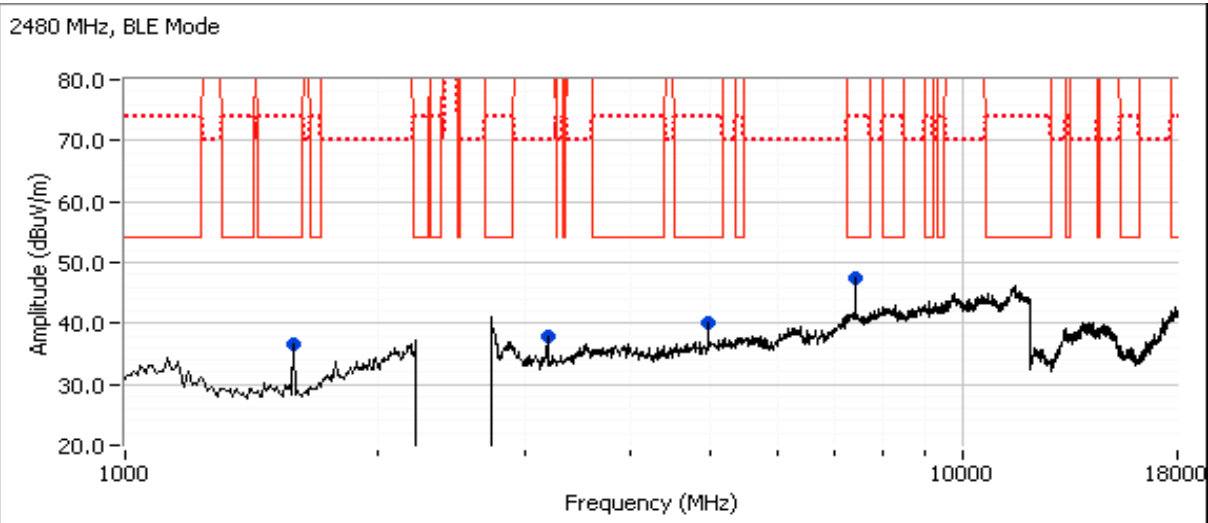



# EMC Test Data

Client: Energous	Job Number: J96937
Model: MLA-1599	T-Log Number: T96943
	Project Manager: Irene Rademacher
Contact: FW Miller	Project Coordinator: -
Standard: FCC 15.247	Class: -

## Conducted Emissions

*(NTS Silicon Valley, Fremont Facility, Semi-Anechoic Chamber)*

### Test Specific Details

Objective: The objective of this test session is to perform final qualification testing of the EUT with respect to the specification listed above.

Date of Test: 11/25/2014	Config. Used: 1
Test Engineer: Rafael Varelas	Config Change: None
Test Location: Fremont Chamber #4	EUT Voltage: 120V/60Hz

### General Test Configuration

For tabletop equipment, the EUT was located on a wooden table inside the semi-anechoic chamber, 40 cm from a vertical coupling plane and 80cm from the LISN. A second LISN was used for all local support equipment. Remote support equipment was located outside of the semi-anechoic chamber. Any cables running to remote support equipment were routed through metal conduit and when possible passed through a ferrite clamp upon exiting the chamber.

Ambient Conditions:	Temperature:	20.6 °C
	Rel. Humidity:	38 %

### Summary of Results

Run #	Test Performed	Limit	Result	Margin
1	CE, AC Power, 120V/60Hz	Class B	Pass	43.6 dBµV @ 3.473 MHz (-12.4 dB)

### Modifications Made During Testing

No modifications were made to the EUT during testing

### Deviations From The Standard

No deviations were made from the requirements of the standard.

Client: Energous	Job Number: J96937
Model: MLA-1599	T-Log Number: T96943
Contact: FW Miller	Project Manager: Irene Rademacher
Standard: FCC 15.247	Project Coordinator: -
	Class: -

Run #1: AC Power Port Conducted Emissions, 0.15 - 30MHz, 120V/60Hz

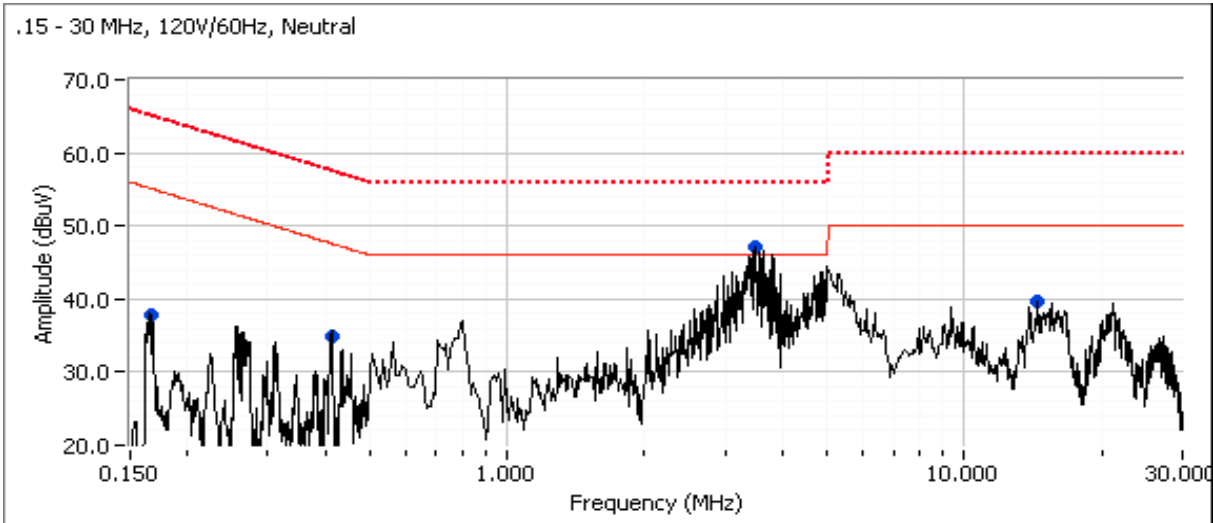
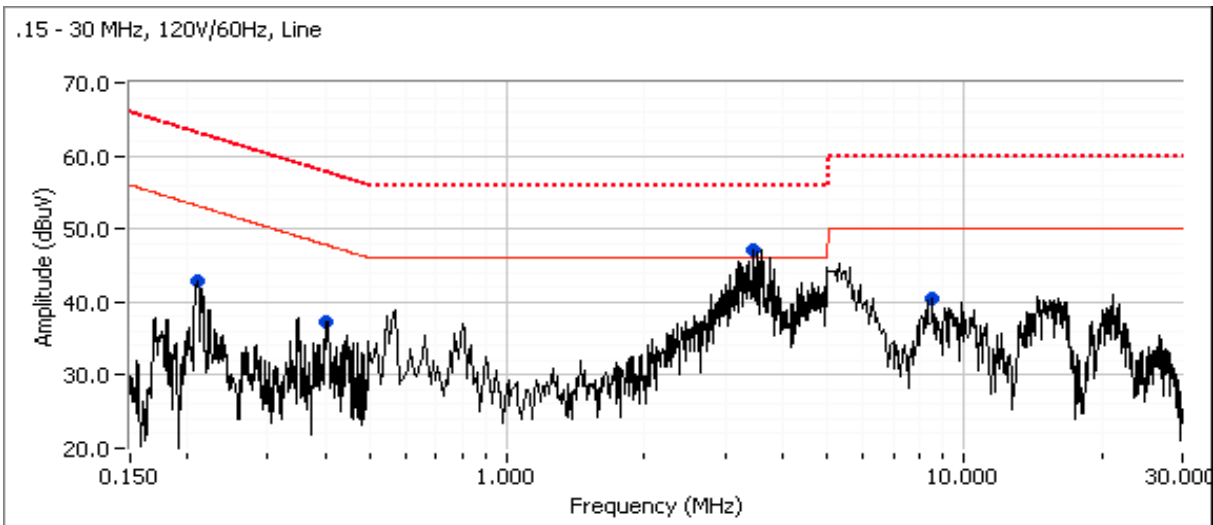



# EMC Test Data

Client: Energous	Job Number: J96937
Model: MLA-1599	T-Log Number: T96943
	Project Manager: Irene Rademacher
Contact: FW Miller	Project Coordinator: -
Standard: FCC 15.247	Class: -

**Preliminary peak readings captured during pre-scan (peak readings vs. average limit)**

Frequency MHz	Level dB $\mu$ V	AC Line	Class B		Detector QP/Ave	Comments
			Limit	Margin		
0.212	42.9	Line 1	53.2	-10.3	Peak	
0.403	37.4	Line 1	47.8	-10.4	Peak	
3.473	47.1	Line 1	46.0	1.1	Peak	
8.561	40.6	Line 1	50.0	-9.4	Peak	
0.166	37.7	Neutral	55.1	-17.4	Peak	
0.414	35.0	Neutral	47.6	-12.6	Peak	
3.499	47.1	Neutral	46.0	1.1	Peak	
14.401	39.7	Neutral	50.0	-10.3	Peak	

**Final quasi-peak and average readings**

Frequency MHz	Level dB $\mu$ V	AC Line	Class B		Detector QP/Ave	Comments
			Limit	Margin		
3.473	43.6	Line 1	56.0	-12.4	QP	QP (1.00s)
3.473	32.5	Line 1	46.0	-13.5	AVG	AVG (0.10s)
3.499	29.9	Neutral	46.0	-16.1	AVG	AVG (0.10s)
3.499	39.9	Neutral	56.0	-16.1	QP	QP (1.00s)
14.401	33.7	Neutral	50.0	-16.3	AVG	AVG (0.10s)
0.403	26.3	Line 1	47.8	-21.5	AVG	AVG (0.10s)
8.561	28.3	Line 1	50.0	-21.7	AVG	AVG (0.10s)
0.403	36.0	Line 1	57.8	-21.8	QP	QP (1.00s)
14.401	37.5	Neutral	60.0	-22.5	QP	QP (1.00s)
8.561	35.8	Line 1	60.0	-24.2	QP	QP (1.00s)
0.414	29.2	Neutral	57.6	-28.4	QP	QP (1.00s)
0.414	18.3	Neutral	47.6	-29.3	AVG	AVG (0.10s)
0.212	23.5	Line 1	53.1	-29.6	AVG	AVG (0.10s)
0.212	33.3	Line 1	63.1	-29.8	QP	QP (1.00s)
0.166	34.5	Neutral	65.2	-30.7	QP	QP (1.00s)
0.166	17.8	Neutral	55.2	-37.4	AVG	AVG (0.10s)

*End of Report*

This page is intentionally blank and marks the last page of this test report.