FCC Test Report

Report No.: AGC04999170105FE03

FCC ID : 2ADM5-VZ60030BT
APPLICATION PURPOSE : Original Equipment
PRODUCT DESIGNATION : VIVITAR Bluetooth speaker
BRAND NAME : VIVITAR
MODEL NAME : VZ60030BT
CLIENT : Zeeva International Limited
DATE OF ISSUE : Jan.20, 2017
STANDARD(S) : FCC Part 15 Rules
TEST PROCEDURE(S)
REPORT VERSION : V1.0

Attestation of Global Compliance (Shenzhen) Co., Ltd



CAUTION:

This report shall not be reproduced except in full without the written permission of the test laboratory and shall not be quoted out of context.



Report Revise Record

Report Version	Revise Time	Issued Date	Valid Version	Notes
V1.0	/	Jan.20, 2017	Valid	Original Report

TABLE OF CONTENTS

1. VERIFICATION OF CONFORMITY	4
2. GENERAL INFORMATION	5
2.1. PRODUCT DESCRIPTION	5
2.2. TABLE OF CARRIER FREQUENCYS	5
3. MEASUREMENT UNCERTAINTY.....	6
4. DESCRIPTION OF TEST MODES.....	6
5. SYSTEM TEST CONFIGURATION	8
5.1. CONFIGURATION OF EUT SYSTEM.....	8
5.2. EQUIPMENT USED IN EUT SYSTEM.....	8
5.3. SUMMARY OF TEST RESULTS.....	8
6. TEST FACILITY	9
TEST METHODOLOGY.....	9
7. ALL TEST EQUIPMENT LIST	9
8. RADIATED EMISSION	11
8.1TEST LIMIT.....	11
8.2. MEASUREMENT PROCEDURE.....	12
8.3. TEST SETUP.....	14
8.4. TEST RESULT	16
9. BAND EDGE EMISSION	31
9.1. MEASUREMENT PROCEDURE.....	31
9.2 TEST SETUP.....	31
9.3 RADIATED TEST RESULT	32
10. 20DB BANDWIDTH.....	36
10.1. MEASUREMENT PROCEDURE.....	36
10.2. TEST SET-UP.....	36
10.3. LIMITS AND MEASUREMENT RESULTS.....	36
11. FCC LINE CONDUCTED EMISSION TEST	43
11.1. LIMITS OF LINE CONDUCTED EMISSION TEST	43
11.2. BLOCK DIAGRAM OF LINE CONDUCTED EMISSION TEST	43
11.3. PRELIMINARY PROCEDURE OF LINE CONDUCTED EMISSION TEST	44
11.4. FINAL PROCEDURE OF LINE CONDUCTED EMISSION TEST	44
11.5. TEST RESULT OF LINE CONDUCTED EMISSION TEST	45
APPENDIX A: PHOTOGRAPHS OF TEST SETUP	47
APPENDIX B: PHOTOGRAPHS OF EUT	50

1. VERIFICATION OF CONFORMITY

Applicant	Zeeva International Limited
Address	Suite 1007B,10th Floor, Exchange Tower 33 Wang Chiu Road, Kowloon Bay, HongKong, China
Manufacturer	Zeeva International Limited
Address	Suite 1007B,10th Floor, Exchange Tower 33 Wang Chiu Road, Kowloon Bay, HongKong, China
Product Designation	VIVITAR Bluetooth speaker
Brand Name	VIVITAR
Test Model	VZ60030BT
Date of test	Jan.17, 2017 to Jan.20, 2017
Deviation	None
Condition of Test Sample	Normal
Report Template	AGCRT-US-BR/RF

We hereby certify that:

The above equipment was tested by Dongguan Precise Testing Service Co., Ltd. The test data, the energy emitted by the sample tested as described in this report is in compliance with the requirements of FCC Rules Part 15.249.

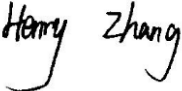
Tested By 
Henry Zhang(Zhang Zhuorui) Jan.20, 2017

Reviewed By 
Forrest Lei(Lei Yonggang) Jan.20, 2017

Approved By 
Solger Zhang(Zhang Hongyi)
Authorized Officer Jan.20, 2017

2. GENERAL INFORMATION

2.1. PRODUCT DESCRIPTION

A major technical description of EUT is described as following

Operation Frequency	2.402 GHz to 2.480GHz
RF Output Power	0.38dBm(Max EIRP Power=Max radiation field-95.2)
Bluetooth Version	V4.1
Modulation	GFSK ,π /4-DQPSK, 8DPSK
Number of channels	79 for BR/EDR
Hardware Version	V2.0
Software Version	V3.0
Antenna Designation	PCB Antenna (Met 15.203 Antenna requirement)
Antenna Gain	0dBi
Power Supply	DC 3.7V by battery
<p>Note: 1. The USB port only be used for charging and can't be used to transfer data with PC. 2. The EUT didn't support BLE.</p>	

2.2. TABLE OF CARRIER FREQUENCIES

BR/EDR channel List

Frequency Band	Channel Number	Frequency
2400~2483.5MHz	0	2402MHz
	1	2403MHz
	:	:
	38	2440 MHz
	39	2441 MHz
	40	2442 MHz
	:	:
	77	2479 MHz
	78	2480 MHz

3. MEASUREMENT UNCERTAINTY

The reported uncertainty of measurement $y \pm U$, where expanded uncertainty U is based on a standard uncertainty multiplied by a coverage factor of $k=2$, providing a level of confidence of approximately 95 %.

No.	Item	Uncertainty
1	Conducted Emission Test	± 3.18 dB
2	All emissions, radiated	± 3.91 dB
3	Temperature	± 0.5 °C
4	Humidity	± 2 %

4. DESCRIPTION OF TEST MODES

NO.	TEST MODE DESCRIPTION
1	Low channel GFSK
2	Middle channel GFSK
3	High channel GFSK
4	Low channel $\pi/4$ -DQPSK
5	Middle channel $\pi/4$ -DQPSK
6	High channel $\pi/4$ -DQPSK
7	Low channel 8DPSK
8	Middle channel 8DPSK
9	High channel 8DPSK
10	BT Link with charging
11	BT Link

Note:

1. All the test modes can be supply by battery, only the result of the worst case was recorded in the report, if no other cases.
2. For Radiated Emission, 3axis were chosen for testing for each applicable mode.
3. The EUT used fully-charged battery when tested.

Software Setting

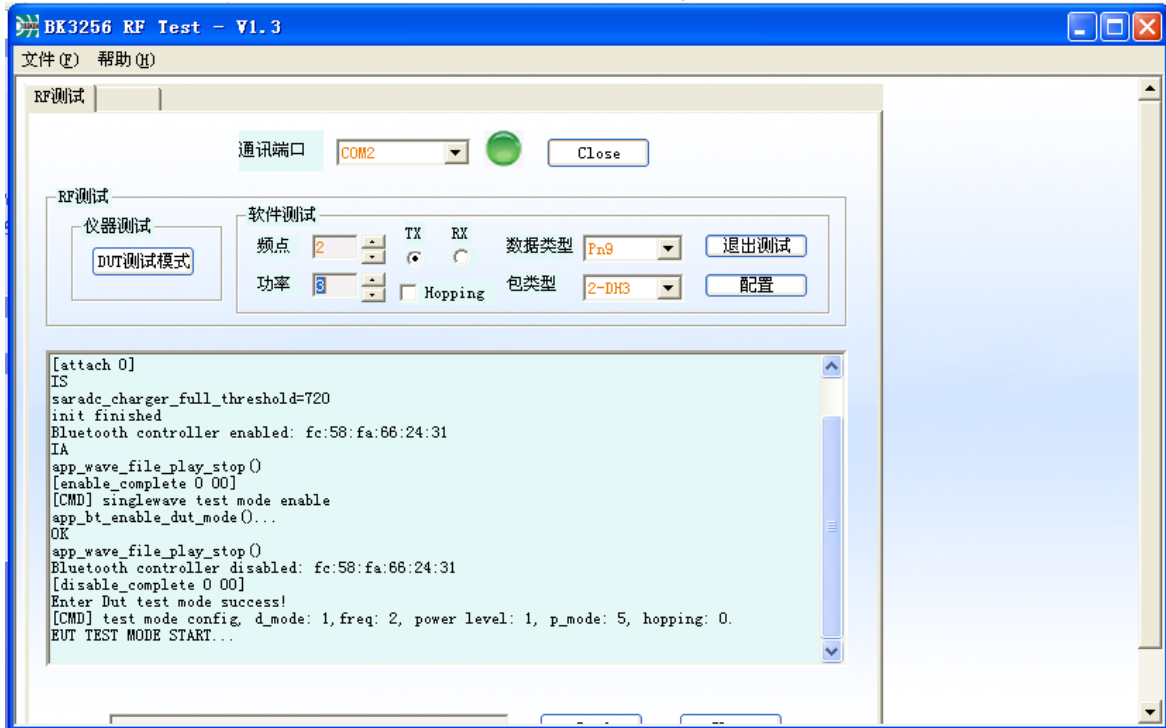

5. SYSTEM TEST CONFIGURATION

5.1. CONFIGURATION OF EUT SYSTEM

Configure 1: (Normal hopping)

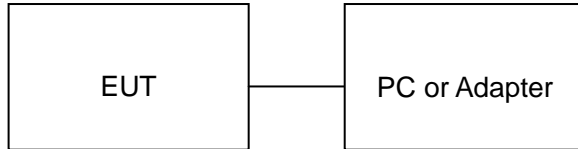

Note: Owing to the EUT has own battery, Testing will be performed while PC or adapter remove.

Configure 2: (Control continuous TX)

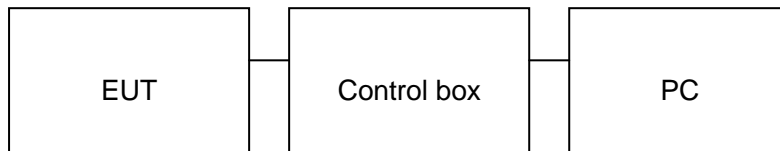

5.2. EQUIPMENT USED IN EUT SYSTEM

Item	Equipment	Mfr/Brand	Model/Type No.	Remark
1	VIVITAR Bluetooth speaker	VIVITAR	VZ60030BT	EUT
2	Battery	Lithium battery	18650#	Accessory
3	PC	Sony	E1412AYCW	A.E
4	Control box	BEKEN	N/A	A.E
5	Adapter	IPRO	NTR-S01	A.E

5.3. SUMMARY OF TEST RESULTS

FCC RULES	DESCRIPTION OF TEST	RESULT
§15.249(a)	Radiated Emission	Compliant
§15.249(d)	Band Edges	Compliant
§15.207	Conduction Emission	Compliant
§15.215	Bandwidth	Compliant

6. TEST FACILITY

Site	Dongguan Precise Testing Service Co., Ltd.
Location	Building D, Baoding Technology Park, Guangming Road 2, Dongcheng District, Dongguan, Guangdong, China,
FCC Registration No.	371540
Description	The test site is constructed and calibrated to meet the FCC requirements in documents ANSI C63.4:2014.

TEST METHODOLOGY

All measurements contained in this report were conducted with ANSI C63.10-2013

7. ALL TEST EQUIPMENT LIST

FOR RADIATED EMISSION TEST (BELOW 1GHz)

Radiated Emission Test Site					
Name of Equipment	Manufacturer	Model Number	Serial Number	Last Calibration	Due Calibration
EMI Test Receiver	ROHDE&SCHWARZ	ESCI	101417	July 4, 2016	July 3, 2017
Trilog Broadband Antenna (25M-1GHz)	SCHWARZBECK	VULB9160	9160-3355	July 4, 2016	July 3, 2017
Signal Amplifier	SCHWARZBECK	BBV 9475	9745-0013	July 4, 2016	July 3, 2017
RF Cable	SCHWARZBECK	AK9515E	96221	July 4, 2016	July 3, 2017
3m Anechoic Chamber	CHENGYU	966	PTS-001	June 6, 2016	June 5, 2017
MULTI-DEVICE Positioning Controller	MAX-FULL	MF-7802	MF780208339	N/A	N/A
Active loop antenna (9K-30MHz)	SCHWARZBECK	FMZB1519	1519-038	June 6, 2016	June 5, 2017
Spectrum analyzer	AGILENT	E4407B	MY46185649	June 6, 2016	June 5, 2017
Radiation Cable 1	MXT	RS1	R005	June 6, 2016	June 5, 2017
Radiation Cable 2	MXT	RS1	R006	June 6, 2016	June 5, 2017

FOR RADIATED EMISSION TEST (1GHz ABOVE)

Radiated Emission Test Site					
Name of Equipment	Manufacturer	Model Number	Serial Number	Last Calibration	Due Calibration
EMI Test Receiver	ROHDE&SCHWARZ	ESCI	101417	July 4, 2016	July 3, 2017
Horn Antenna (1G-18GHz)	SCHWARZBECK	BBHA9120D	9120D-1246	July 11, 2016	July 10, 2017
Spectrum Analyzer	AGILENT	E4411B	MY4511453	July 4, 2016	July 3, 2017
Signal Amplifier	SCHWARZBECK	BBV 9718	9718-269	July 7, 2016	July 6, 2017
RF Cable	SCHWARZBECK	AK9515H	96220	July 8, 2016	July 7, 2017
3m Anechoic Chamber	CHENGYU	966	PTS-001	June 6, 2016	June 5, 2017
MULTI-DEVICE Positioning Controller	MAX-FULL	MF-7802	MF780208339	N/A	N/A
Horn Ant (18G-40GHz)	SCHWARZBECK	BBHA 9170	9170-181	June 6, 2016	June 5, 2017
Radiation Cable 1	MXT	RS1	R005	June 6, 2016	June 5, 2017
Radiation Cable 2	MXT	RS1	R006	June 6, 2016	June 5, 2017

Conducted Emission Test Site					
Name of Equipment	Manufacturer	Model Number	Serial Number	Last Calibration	Due Calibration
EMI Test Receiver	ROHDE&SCHWARZ	ESCI	101417	July 4, 2016	July 3, 2017
Artificial Mains Network	NARDA	L2-16B	000WX31025	July 8, 2016	July 7, 2017
Artificial Mains Network (AUX)	NARDA	L2-16B	000WX31026	July 8, 2016	July 7, 2017
RF Cable	SCHWARZBECK	AK9515E	96222	July 4, 2016	July 3, 2017
Shielded Room	CHENGYU	843	PTS-002	June 6, 2016	June 5, 2017
Conduction Cable	MXT	SE1	S003	June 6, 2016	June 5, 2017

8. RADIATED EMISSION

8.1 TEST LIMIT

Standard FCC15.249

Fundamental Frequency	Field Strength of Fundamental (millivolts/meter)	Field Strength of Harmonics (microvolts/meter)
900-928MHz	50	500
2400-2483.5MHz	50	500
5725-5875MHz	50	500
24.0-24.25GHz	250	2500

Standard FCC 15.209

Frequency (MHz)	Distance Meters	Field Strengths Limit	
		μ V/m	dB(μ V)/m
0.009 ~ 0.490	300	2400/F(kHz)	---
0.490 ~ 1.705	30	24000/F(kHz)	---
1.705 ~ 30	30	30	---
30 ~ 88	3	100	40.0
88 ~ 216	3	150	43.5
216 ~ 960	3	200	46.0
960 ~ 1000	3	500	54.0
Above 1000	3	Other:74.0 dB(μ V)/m (Peak) 54.0 dB(μ V)/m (Average)	

Remark: (1) Emission level $\text{dB}\mu\text{V} = 20 \log \text{Emission level } \mu\text{V/m}$
(2) The smaller limit shall apply at the cross point between two frequency bands.
(3) Distance is the distance in meters between the measuring instrument, antenna and the closest point of any part of the device or system.

8.2. MEASUREMENT PROCEDURE

1. The measuring distance of 3m shall be used for measurements. The EUT was placed on the top of a rotating table 0.8 meter above the ground at a 3 meter semi-anechoic chamber. The table was rotated 360 degrees to determine the position of the highest radiation(Below 1GHz)
2. The measuring distance of 3m shall used for measurements. The EUT was placed on the top of a rotating table 1.5 meter above the ground at a 3 meter semi-anechoic chamber. The table was rotated 360 degrees to determine the position of the highest radiation(Above 1GHz)
3. The height of the test antenna shall vary between 1m to 4m.Both horizontal and vertical polarization Of the antenna are set to make the measurement.
4. The initial step in collecting radiated emission data is a receive peak detector mode. Pre-scanning the measurement frequency range. Significant peaks are then marked and then Quasi Peak detector mode re-measured.
5. All readings are peak unless otherwise stated QP in column of Note. Peak denoted that the Peak reading compliance with the QP limits and then QP Mode measurement didn't perform(Below 1GHz)
6. All readings are Peak mode value unless otherwise stated AVG in column of Note. If the Peak mode measured value compliance with the Peak limits and lower than AVG Limits, the EUT shall be deemed to meet Peak&AVG limits and then only Peak mode was measured, but AVG mode didn't perform.(Above 1GHz)

The following table is the setting of spectrum analyzer and receiver.

Spectrum Parameter	Setting
Start ~Stop Frequency	9KHz~150KHz/RB 200Hz for QP
Start ~Stop Frequency	150KHz~30MHz/RB 9KHz for QP
Start ~Stop Frequency	30MHz~1000MHz/RB 120KHz for QP
Start ~Stop Frequency	1GHz~26.5GHz 1MHz/3MHz for Peak, 1MHz/10Hz for Average
Receiver Parameter	Setting
Start ~Stop Frequency	9KHz~150KHz/RB 200Hz for QP
Start ~Stop Frequency	150KHz~30MHz/RB 9KHz for QP
Start ~Stop Frequency	30MHz~1000MHz/RB 120KHz for QP

8.3. TEST SETUP

Radiated Emission Test-Setup Frequency Below 30MHz

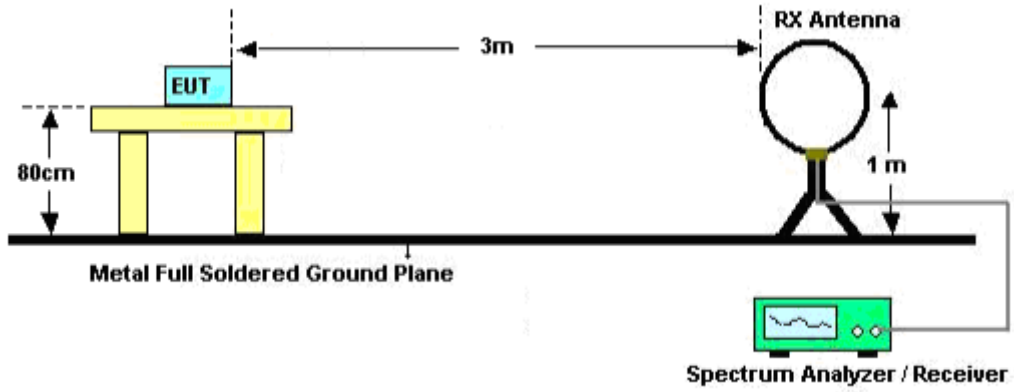

RADIATED EMISSION TEST SETUP 30MHz-1000MHz

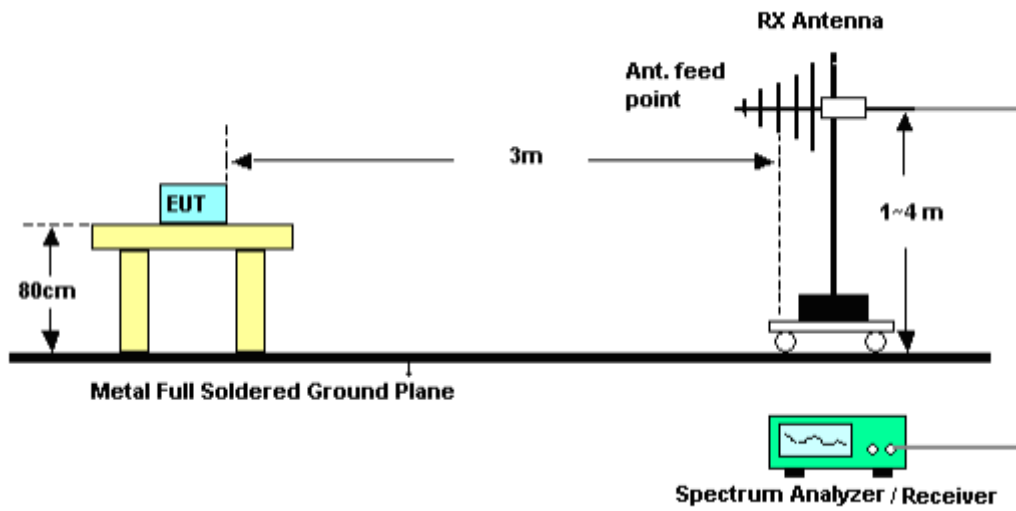

RADIATED EMISSION TEST SETUP ABOVE 1000MHz

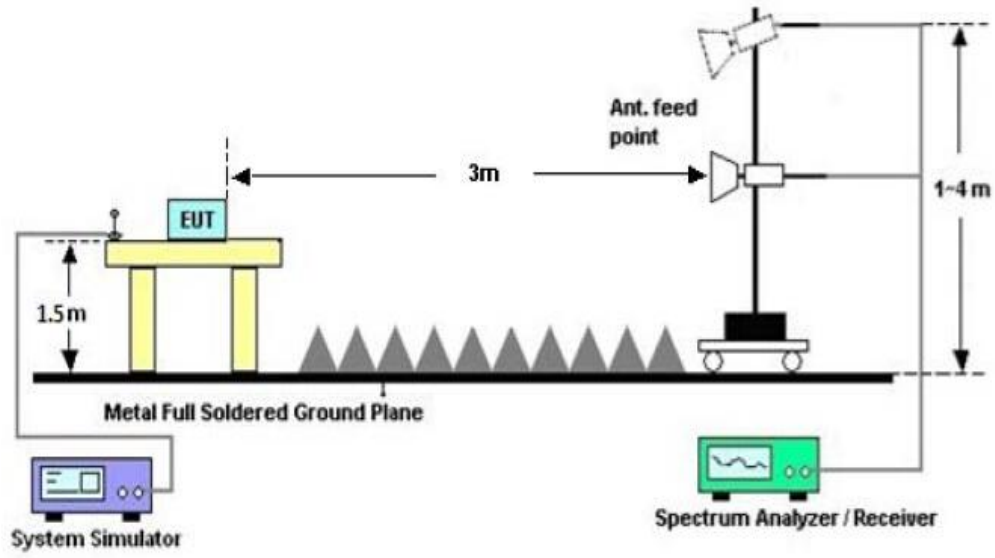

8.4. TEST RESULT

(Worst modulation:GFSK)

FOR BR/EDR

RADIATED EMISSION BELOW 30MHz

No emission found between lowest internal used/generated frequencies to 30MHz.

RADIATED EMISSION BELOW 1GHz

RADIATED EMISSION TEST- (30MHz-1GHz)-LOW CHANNEL-HORIZONTAL

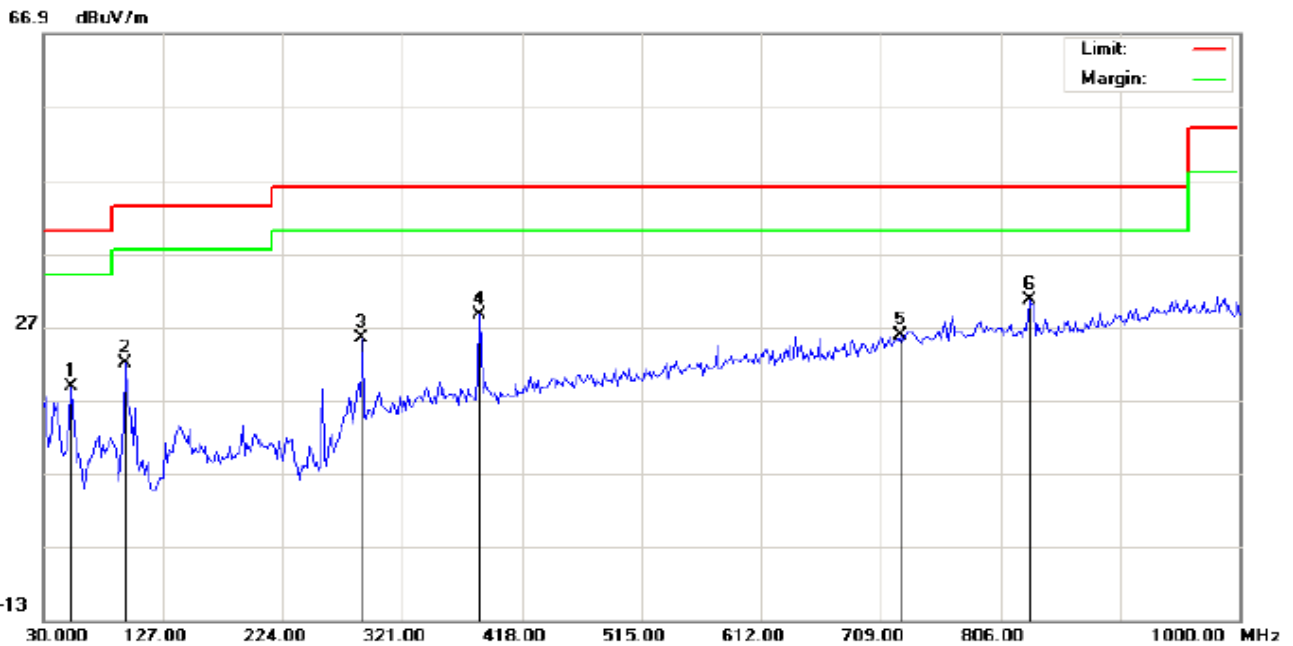

Site: site #1
Limit: FCC Class B 3M Radiation
EUT:VIVITAR Bluetooth speaker
M/N:VZ60030BT
Mode:Low Channel TX
Note:

Polarization: *Horizontal*
Power:
Distance:

Temperature: 22.2
Humidity: 54.3 %

No.	Mk	Freq.	Reading	Factor	Measurement	Limit	Over	Detector	Antenna Height	Table Degree	Comment
		MHz	dBuV	dB/m	dBuV/m	dBuV/m	dB		cm	degree	
1		52.6333	10.34	8.41	18.75	40.00	-21.25	peak			
2		96.2833	15.23	6.77	22.00	43.50	-21.50	peak			
3		288.6666	11.99	13.48	25.47	46.00	-20.53	peak			
4		384.0500	9.55	18.96	28.51	46.00	-17.49	peak			
5		725.1667	-0.09	25.91	25.82	46.00	-20.18	peak			
6	*	830.2500	3.20	27.31	30.51	46.00	-15.49	peak			

RESULT: PASS

RADIATED EMISSION TEST- (30MHz-1GHz)-LOW CHANNEL -VERTICAL

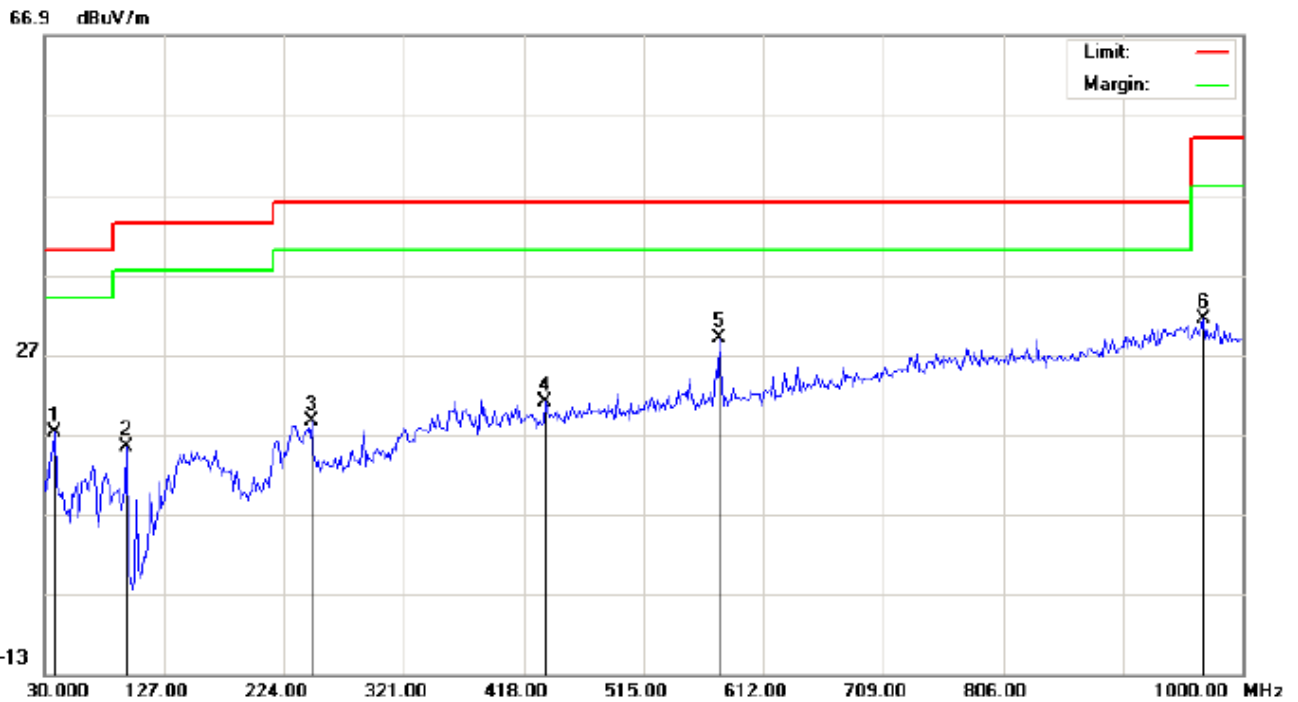

Site: site #1
Limit: FCC Class B 3M Radiation
EUT:VIVITAR Bluetooth speaker
M/N:VZ60030BT
Mode:Low Channel TX
Note:

Polarization: *Vertical*
Power:
Distance:

Temperature: 22.2
Humidity: 54.3 %

No.	Mk	Freq.	Reading	Factor	Measurement	Limit	Over	Detector	Antenna Height	Table Degree	Comment
		MHz	dBuV	dB/m	dBuV/m	dBuV/m	dB		cm	degree	
1		38.0833	10.90	6.39	17.29	40.00	-22.71	peak			
2		96.2833	15.29	0.05	15.34	43.50	-28.16	peak			
3		246.6333	5.06	13.57	18.63	46.00	-27.37	peak			
4		435.7833	0.83	20.16	20.99	46.00	-25.01	peak			
5	*	576.4333	6.37	22.61	28.98	46.00	-17.02	peak			
6		967.6667	1.56	29.83	31.39	54.00	-22.61	peak			

RESULT: PASS

Note: 1. Factor=Antenna Factor + Cable loss, Margin=Measurement-Limit.

2. The "Factor" value can be calculated automatically by software of measurement system.

RADIATED EMISSION TEST- (30MHz-1GHz)-MIDDLE CHANNEL-HORIZONTAL

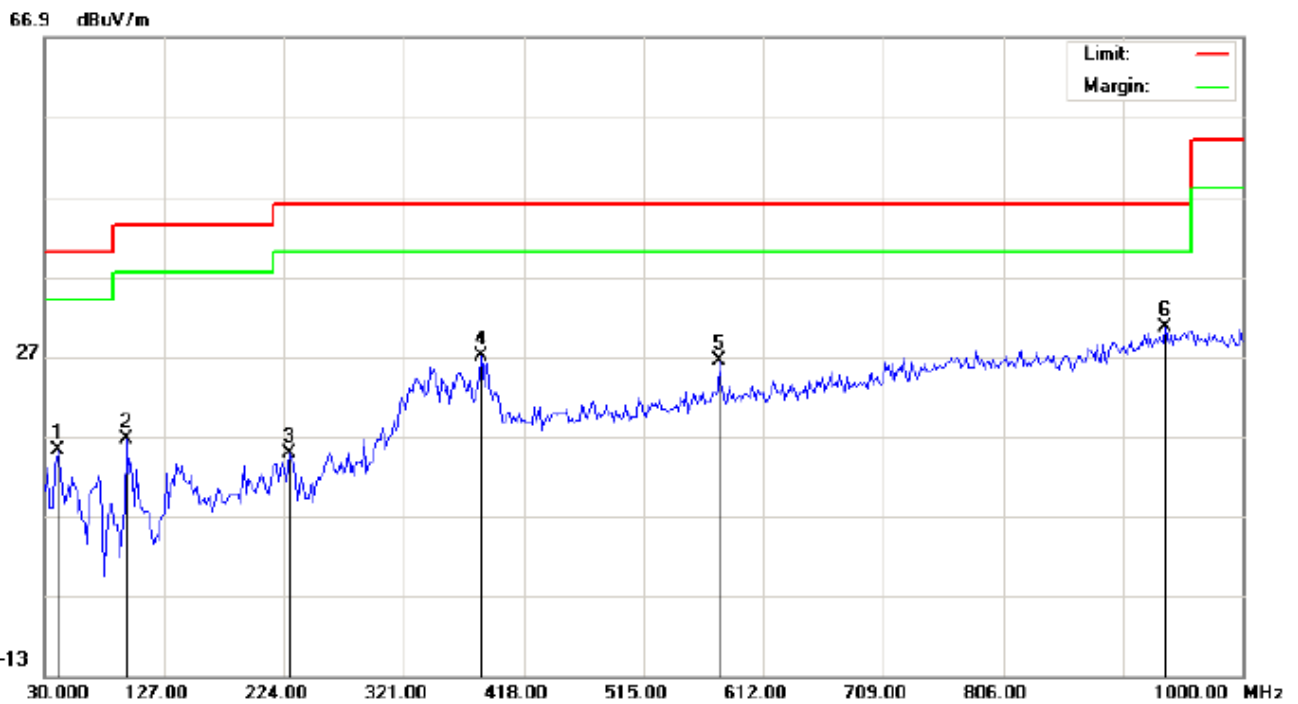

Site: site #1
Limit: FCC Class B 3M Radiation
EUT:VIVITAR Bluetooth speaker
M/N:VZ60030BT
Mode:Middle Channel TX
Note:

Polarization: *Horizontal*
Power:
Distance:

Temperature: 22.2
Humidity: 54.3 %

No.	Mk	Freq.	Reading	Factor	Measurement	Limit	Over	Detector	Antenna Height	Table Degree	Comment
		MHz	dBuV	dB/m	dBuV/m	dBuV/m	dB		cm	degree	
1		41.3167	3.32	11.81	15.13	40.00	-24.87	peak			
2		96.2833	9.90	6.77	16.67	43.50	-26.83	peak			
3		228.8500	5.73	9.06	14.79	46.00	-31.21	peak			
4		384.0500	8.12	18.96	27.08	46.00	-18.92	peak			
5		576.4333	3.18	23.14	26.32	46.00	-19.68	peak			
6	*	936.9500	0.89	29.64	30.53	46.00	-15.47	peak			

RESULT: PASS

RADIATED EMISSION TEST- (30MHz-1GHz)- MIDDLE CHANNEL -VERTICAL

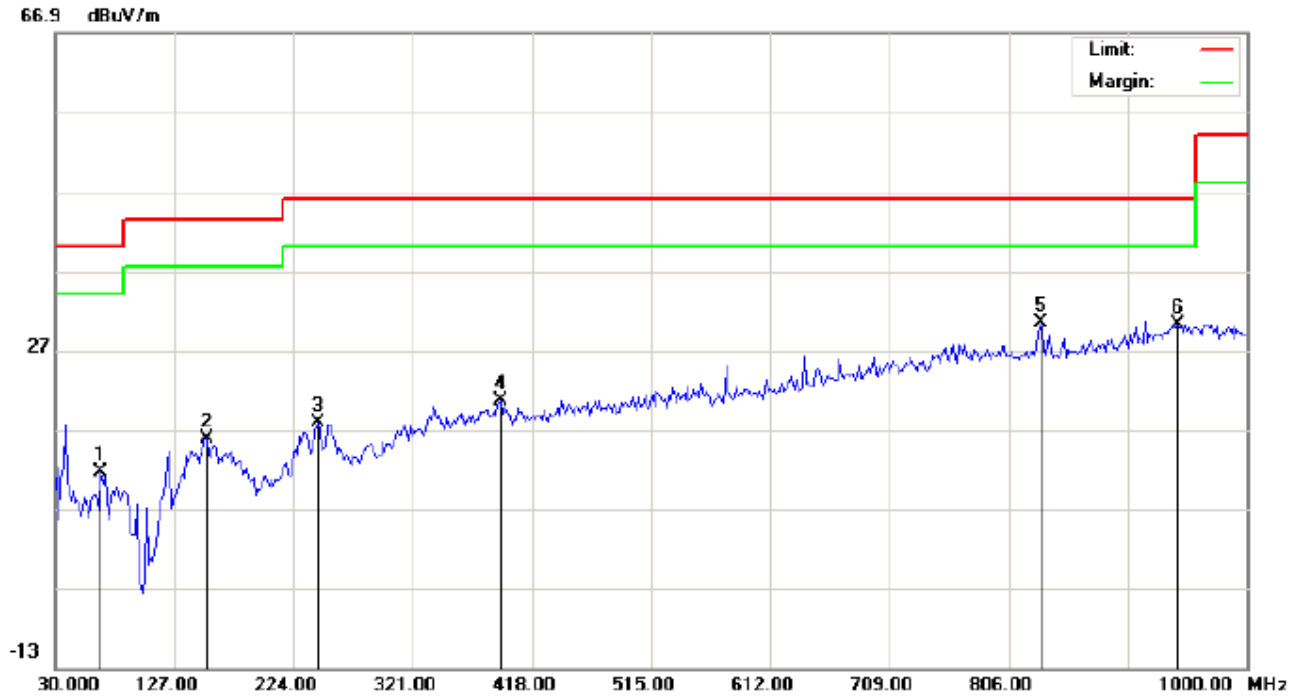

Site: site #1
Limit: FCC Class B 3M Radiation
EUT:VIVITAR Bluetooth speaker
M/N:VZ60030BT
Mode:Middle Channel TX
Note:

Polarization: *Vertical*
Power:
Distance:

Temperature: 22.2
Humidity: 54.3 %

No.	Mk	Freq.	Reading	Factor	Measurement	Limit	Over	Detector	Antenna Height	Table Degree	Comment
		MHz	dBuV	dB/m	dBuV/m	dBuV/m	dB		cm	degree	
1		67.1833	6.16	5.36	11.52	40.00	-28.48	peak			
2		152.8667	0.58	15.28	15.86	43.50	-27.64	peak			
3		243.4000	4.56	13.25	17.81	46.00	-28.19	peak			
4		392.1333	1.55	19.02	20.57	46.00	-25.43	peak			
5	*	831.8667	3.00	27.31	30.31	46.00	-15.69	peak			
6		943.4167	0.39	29.82	30.21	46.00	-15.79	peak			

RESULT: PASS

Note: 1. Factor=Antenna Factor + Cable loss, Margin=Measurement-Limit.

2. The "Factor" value can be calculated automatically by software of measurement system.

RADIATED EMISSION TEST- (30MHz-1GHz)-HIGH CHANNEL-HORIZONTAL

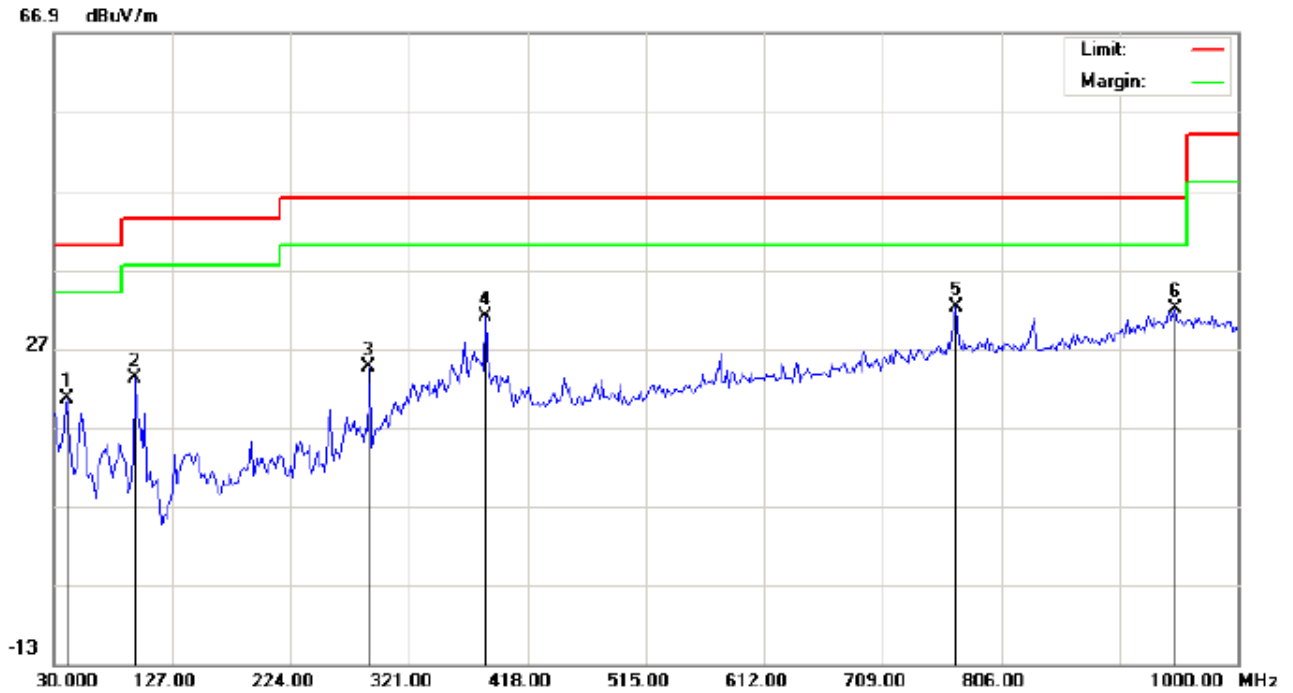

Site: site #1
Limit: FCC Class B 3M Radiation
EUT:VIVITAR Bluetooth speaker
M/N:VZ60030BT
Mode:High Channel TX
Note:

Polarization: *Horizontal*
Power:
Distance:

Temperature: 22.2
Humidity: 54.3 %

No.	Mk	Freq.	Reading	Factor	Measurement	Limit	Over	Detector	Antenna Height	Table Degree	Comment
		MHz	dBuV	dB/m	dBuV/m	dBuV/m	dB		cm	degree	
1		41.3167	8.72	11.81	20.53	40.00	-19.47	peak			
2		96.2833	16.41	6.77	23.18	43.50	-20.32	peak			
3		288.6666	11.11	13.48	24.59	46.00	-21.41	peak			
4		384.0500	12.09	18.96	31.05	46.00	-14.95	peak			
5	*	768.8167	5.39	26.89	32.28	46.00	-13.72	peak			
6		948.2667	2.06	29.95	32.01	46.00	-13.99	peak			

RESULT: PASS

RADIATED EMISSION TEST- (30MHz-1GHz)-HIGH CHANNEL -VERTICAL

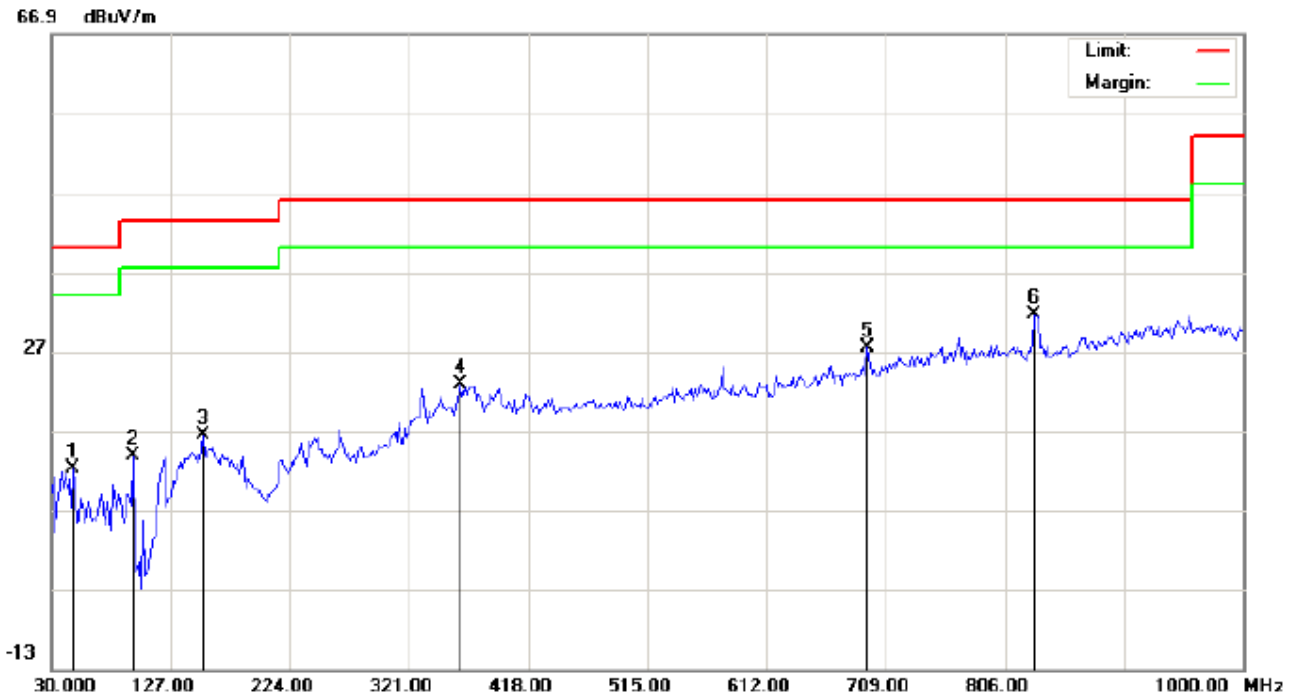

Site: site #1
 Limit: FCC Class B 3M Radiation
 EUT:VIVITAR Bluetooth speaker
 M/N:VZ60030BT
 Mode:High Channel TX
 Note:

Polarization: *Vertical*
 Power:
 Distance:

Temperature: 22.2
 Humidity: 54.3 %

No.	Mk	Freq.	Reading	Factor	Measurement	Limit	Over	Detector	Antenna Height	Table Degree	Comment
		MHz	dBuV	dB/m	dBuV/m	dBuV/m	dB		cm	degree	
1		47.7833	3.91	8.39	12.30	40.00	-27.70	peak			
2		96.2833	13.78	0.05	13.83	43.50	-29.67	peak			
3		152.8667	1.06	15.28	16.34	43.50	-27.16	peak			
4		363.0333	4.05	18.83	22.88	46.00	-23.12	peak			
5		694.4500	2.27	25.04	27.31	46.00	-18.69	peak			
6	*	830.2500	4.25	27.31	31.56	46.00	-14.44	peak			

RESULT: PASS

Note: 1. Factor=Antenna Factor + Cable loss, Margin=Measurement-Limit.

2. The "Factor" value can be calculated automatically by software of measurement system.

RADIATED EMISSION TEST- (ABOVE 1GHz)-MIDDLE CHANNEL-HORIZONTAL

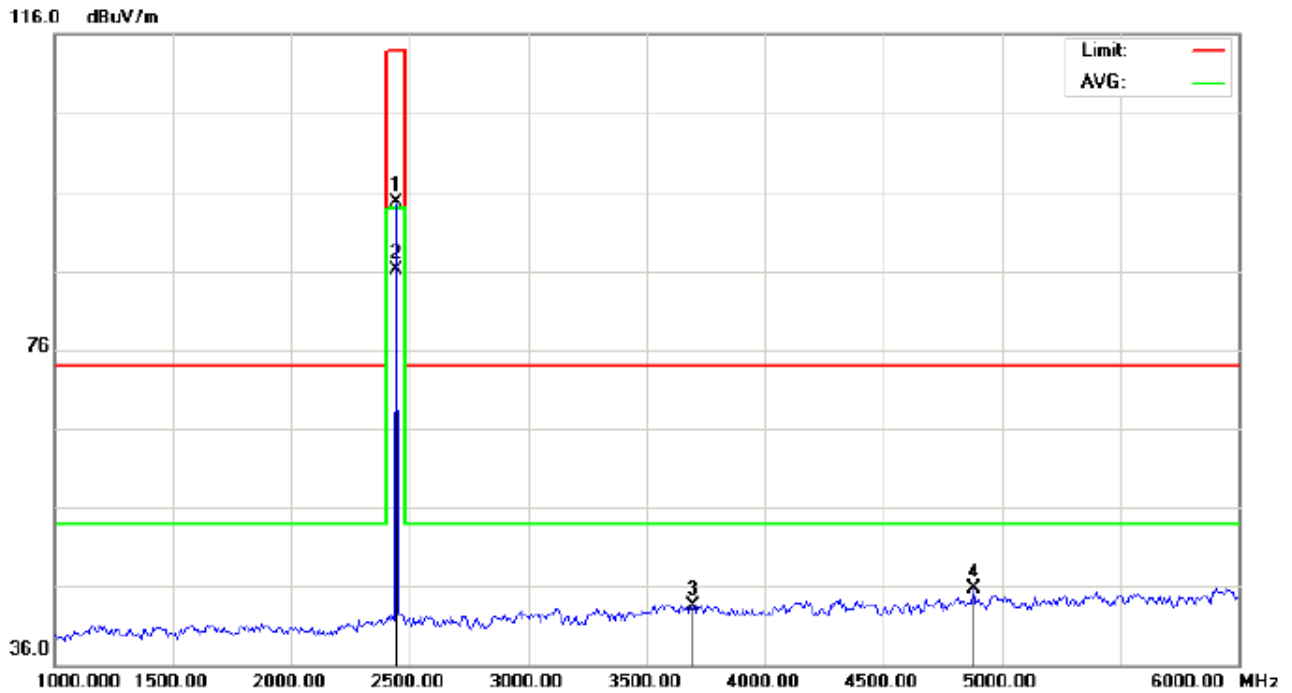

Site: site #1 Polarization: *Horizontal* Temperature: 22.7
Limit: FCC Class B 3M Radiation above 1GHz(PK)- Power: Humidity: 53.6 %
EUT:VIVITAR Bluetooth speaker Distance:
M/N:VZ60030BT
Mode: Middle Channel TX
Note:

No.	Mk	Freq.	Reading	Factor	Measurement	Limit	Over	Detector	Antenna Height	Table Degree	Comment
		MHz	dBuV	dB/m	dBuV/m	dBuV/m	dB		cm	degree	
1		2441.000	84.27	10.36	94.63	114.00	-19.37	peak			
2	*	2441.000	75.80	10.36	86.16	94.00	-7.84	AVG	100	40	
3		3695.000	30.24	13.31	43.55	74.00	-30.45	peak			
4		4882.000	37.88	7.89	45.77	74.00	-28.23	peak			

RESULT: PASS

RADIATED EMISSION TEST- (ABOVE 1GHz)-MIDDLE CHANNEL- VERTICAL

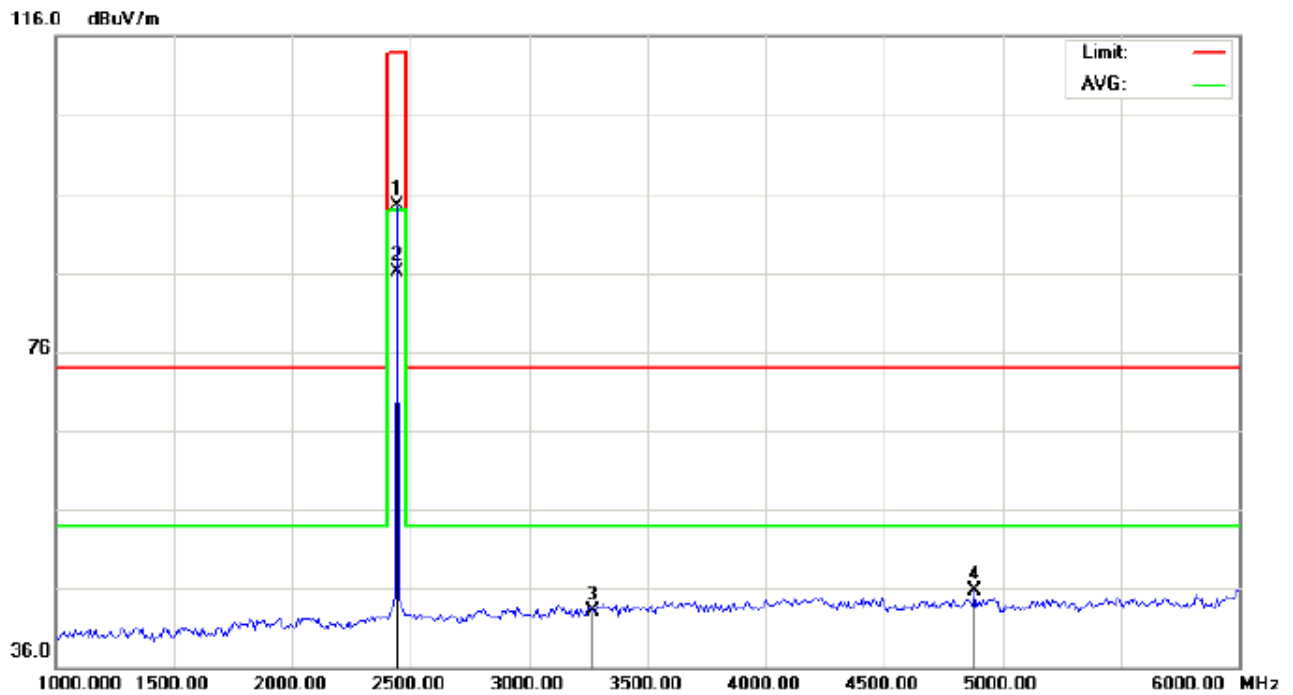

Site: site #1 Polarization: *Vertical* Temperature: 22.7
Limit: FCC Class B 3M Radiation above 1GHz(PK)- Power: Humidity: 53.6 %
EUT:VIVITAR Bluetooth speaker Distance:
M/N:VZ60030BT
Mode: Middle Channel TX
Note:

No.	Mk	Freq.	Reading	Factor	Measurement	Limit	Over	Detector	Antenna Height	Table Degree	Comment
		MHz	dBuV	dB/m	dBuV/m	dBuV/m	dB		cm	degree	
1		2441.000	84.09	10.36	94.45	114.00	-19.55	peak			
2	*	2441.000	75.66	10.36	86.02	94.00	-7.98	AVG	100	16	
3		3267.000	31.14	11.89	43.03	74.00	-30.97	peak			
4		4882.000	37.81	7.89	45.70	74.00	-28.30	peak			

RESULT: PASS

RADIATED EMISSION TEST- (ABOVE 1GHz)-HIGH CHANNEL-HORIZONTAL

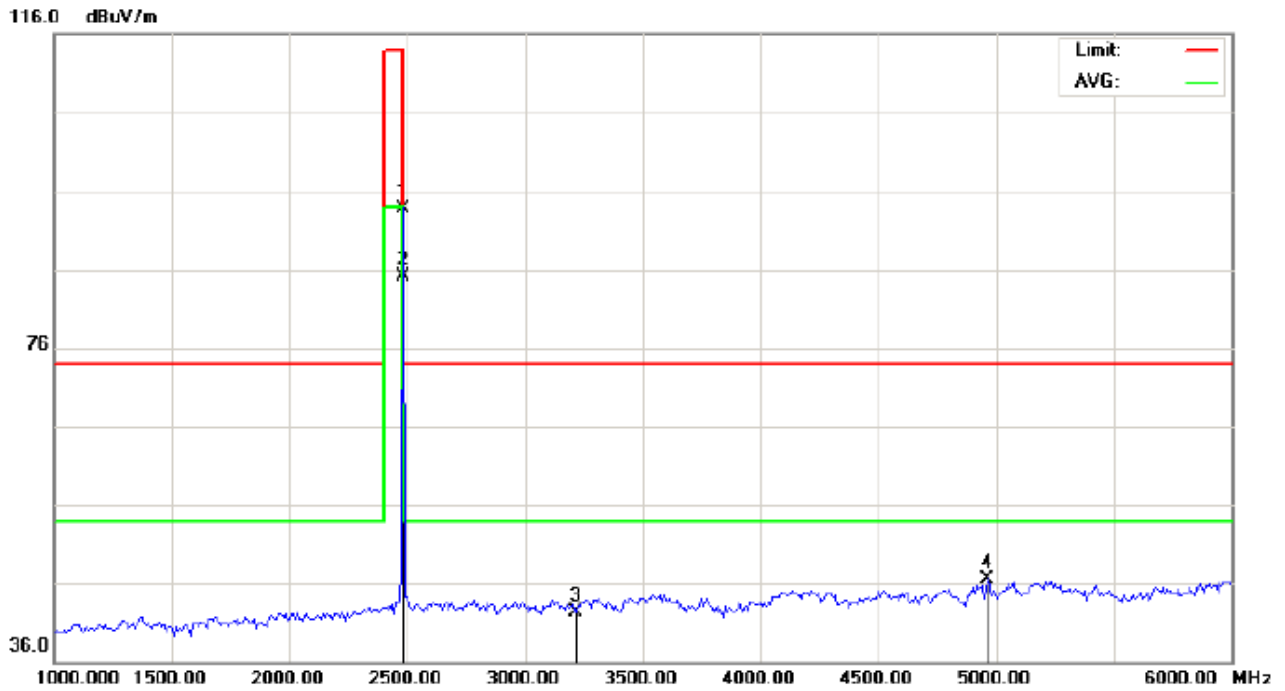

Site: site #1
Limit: FCC Class B 3M Radiation above 1GHz(PK)-
EUT:VIVITAR Bluetooth speaker
M/N:VZ60030BT
Mode: High Channel TX
Note:

Polarization: *Horizontal*
Power:
Distance:

Temperature: 22.7
Humidity: 53.6 %

No.	Mk	Freq.	Reading	Factor	Measurement	Limit	Over	Detector	Antenna Height	Table Degree	Comment
		MHz	dBuV	dB/m	dBuV/m	dBuV/m	dB		cm	degree	
1		2480.000	83.27	10.41	93.68	114.00	-20.32	peak			
2	*	2480.000	74.76	10.41	85.17	94.00	-8.83	AVG	100	41	
3		3215.000	30.42	11.84	42.26	74.00	-31.74	peak			
4		4960.000	38.51	8.09	46.60	74.00	-27.40	peak			

RESULT: PASS

RADIATED EMISSION TEST- (ABOVE 1GHz)-HIGH CHANNEL- VERTICAL

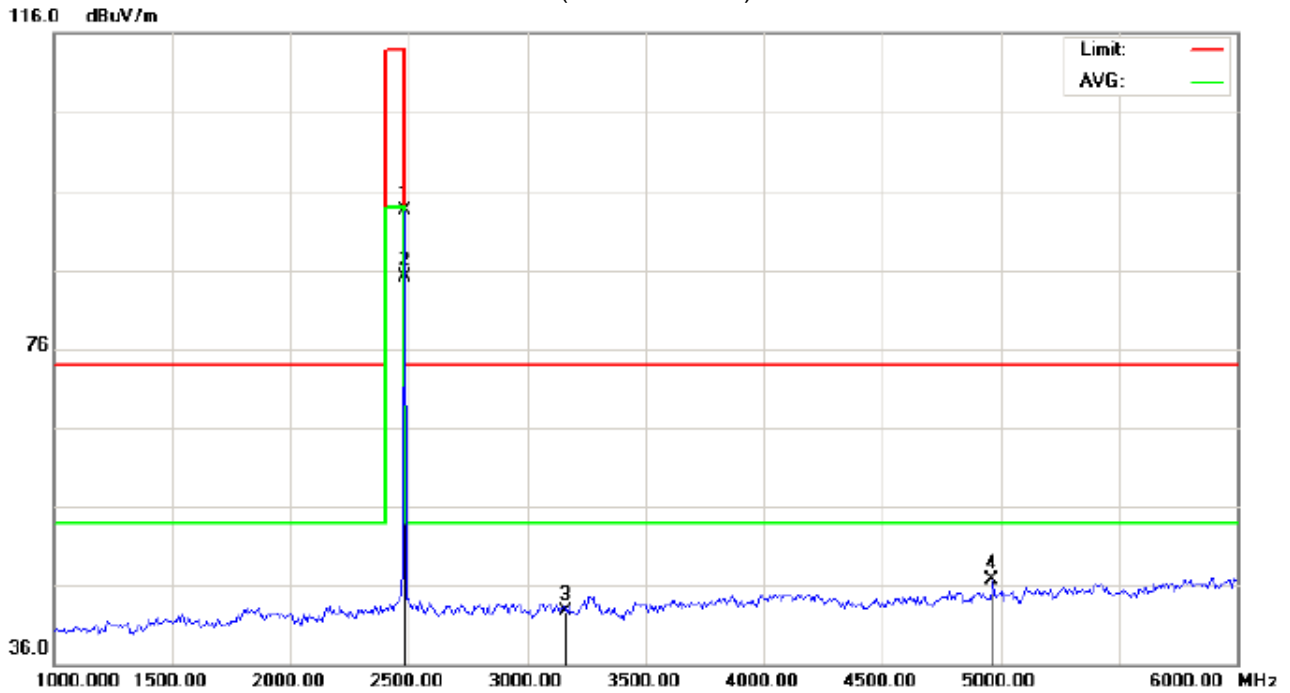

Site: site #1
 Limit: FCC Class B 3M Radiation above 1GHz(PK)-
 EUT:VIVITAR Bluetooth speaker
 M/N:VZ60030BT
 Mode: High Channel TX
 Note:

Polarization: *Vertical*
 Power:
 Distance:

Temperature: 22.7
 Humidity: 53.6 %

No.	Mk	Freq.	Reading	Factor	Measurement	Limit	Over	Detector	Antenna Height	Table Degree	Comment
		MHz	dBuV	dB/m	dBuV/m	dBuV/m	dB		cm	degree	
1		2480.000	83.18	10.41	93.59	114.00	-20.41	peak			
2	*	2480.000	74.71	10.41	85.12	94.00	-8.88	AVG	100	18	
3		3163.000	30.83	11.79	42.62	74.00	-31.38	peak			
4		4960.000	38.66	8.09	46.75	74.00	-27.25	peak			

RESULT: PASS

Note: 6~25GHz at least have 20dB margin. No recording in the test report.

Factor=Antenna Factor + Cable loss - Amplifier gain, Margin=Measurement-Limit.

The "Factor" value can be calculated automatically by software of measurement system.

Field strength of the fundamental signal**1Mbps Result:****Peak value**

Frequency	Reading Level	Factor	Measurement	Limit	Over	Antenna
(MHz)	(dBuv)	(dB/m)	(dBuv/m)	(dBuv/m)	(dB)	Polarization
2402	85.26	10.32	95.58	114	-18.42	Horizontal
2402	85.17	10.32	95.49	114	-18.51	Vertical
2441	84.27	10.36	94.63	114	-19.37	Horizontal
2441	84.09	10.36	94.45	114	-19.55	Vertical
2480	83.27	10.41	93.68	114	-20.32	Horizontal
2480	83.18	10.41	93.59	114	-20.41	Vertical

Average value

Frequency	Reading Level	Factor	Measurement	Limit	Over	Antenna
(MHz)	(dBuv)	(dB/m)	(dBuv/m)	(dBuv/m)	(dB)	Polarization
2402	76.80	10.32	87.12	94	-6.88	Horizontal
2402	76.74	10.32	87.06	94	-6.94	Vertical
2441	75.80	10.36	86.16	94	-7.84	Horizontal
2441	75.66	10.36	86.02	94	-7.98	Vertical
2480	74.76	10.41	85.17	94	-8.83	Horizontal
2480	74.71	10.41	85.12	94	-8.88	Vertical

2Mbps Result:**Peak value**

Frequency	Reading Level	Factor	Measurement	Limit	Over	Antenna
(MHz)	(dBuv)	(dB/m)	(dBuv/m)	(dBuv/m)	(dB)	Polarization
2402	85.25	10.32	95.57	114	-18.43	Horizontal
2402	85.14	10.32	95.46	114	-18.54	Vertical
2441	84.23	10.36	94.59	114	-19.41	Horizontal
2441	84.06	10.36	94.42	114	-19.58	Vertical
2480	83.26	10.41	93.67	114	-20.33	Horizontal
2480	83.13	10.41	93.54	114	-20.46	Vertical

Average value

Frequency	Reading Level	Factor	Measurement	Limit	Over	Antenna
(MHz)	(dBuv)	(dB/m)	(dBuv/m)	(dBuv/m)	(dB)	Polarization
2402	76.77	10.32	87.09	94	-6.91	Horizontal
2402	76.71	10.32	87.03	94	-6.97	Vertical
2441	75.75	10.36	86.11	94	-7.89	Horizontal
2441	75.60	10.36	85.96	94	-8.04	Vertical
2480	74.74	10.41	85.15	94	-8.85	Horizontal
2480	74.70	10.41	85.11	94	-8.89	Vertical

3Mbps Result:**Peak value**

Frequency	Reading Level	Factor	Measurement	Limit	Over	Antenna
(MHz)	(dBuv)	(dB/m)	(dBuv/m)	(dBuv/m)	(dB)	Polarization
2402	85.20	10.32	95.52	114	-18.48	Horizontal
2402	85.11	10.32	95.43	114	-18.57	Vertical
2441	84.18	10.36	94.54	114	-19.46	Horizontal
2441	84.03	10.36	94.39	114	-19.61	Vertical
2480	83.22	10.41	93.63	114	-20.37	Horizontal
2480	83.10	10.41	93.51	114	-20.49	Vertical

Average value

Frequency	Reading Level	Factor	Measurement	Limit	Over	Antenna
(MHz)	(dBuv)	(dB/m)	(dBuv/m)	(dBuv/m)	(dB)	Polarization
2402	76.73	10.32	87.05	94	-6.95	Horizontal
2402	76.65	10.32	86.97	94	-7.03	Vertical
2441	75.71	10.36	86.07	94	-7.93	Horizontal
2441	75.56	10.36	85.92	94	-8.08	Vertical
2480	74.57	10.41	84.98	94	-9.02	Horizontal
2480	74.46	10.41	84.87	94	-9.13	Vertical

9. BAND EDGE EMISSION

9.1. MEASUREMENT PROCEDURE

1The EUT operates at hopping-off test mode. The lowest or highest channels are tested to verify the largest transmission and spurious emissions power at the continuous transmission mode.

2Max hold the trace of the setup 1, and the EUT operates at hopping-on test mode to verify the largest spurious emissions power.

3Set the spectrum analyzer in the following setting in order to capture the lower and upper band-edges of the emission

9.2 TEST SETUP

RADIATED EMISSION TEST SETUP

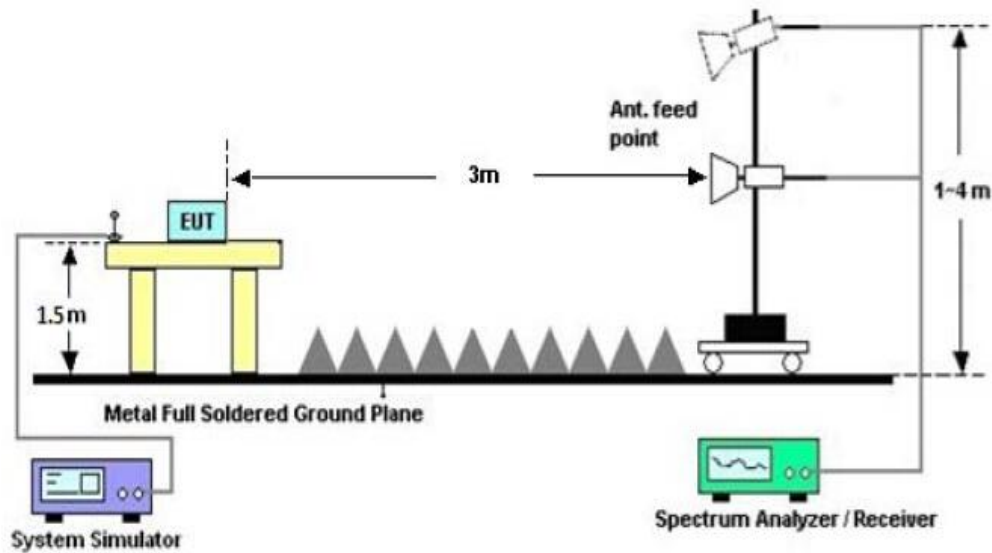

9.3 RADIATED TEST RESULT

(Worst modulation: GFSK)

FOR BR/EDR

TEST PLOT OF BAND EDGE FOR LOW CHANNEL-Horizontal

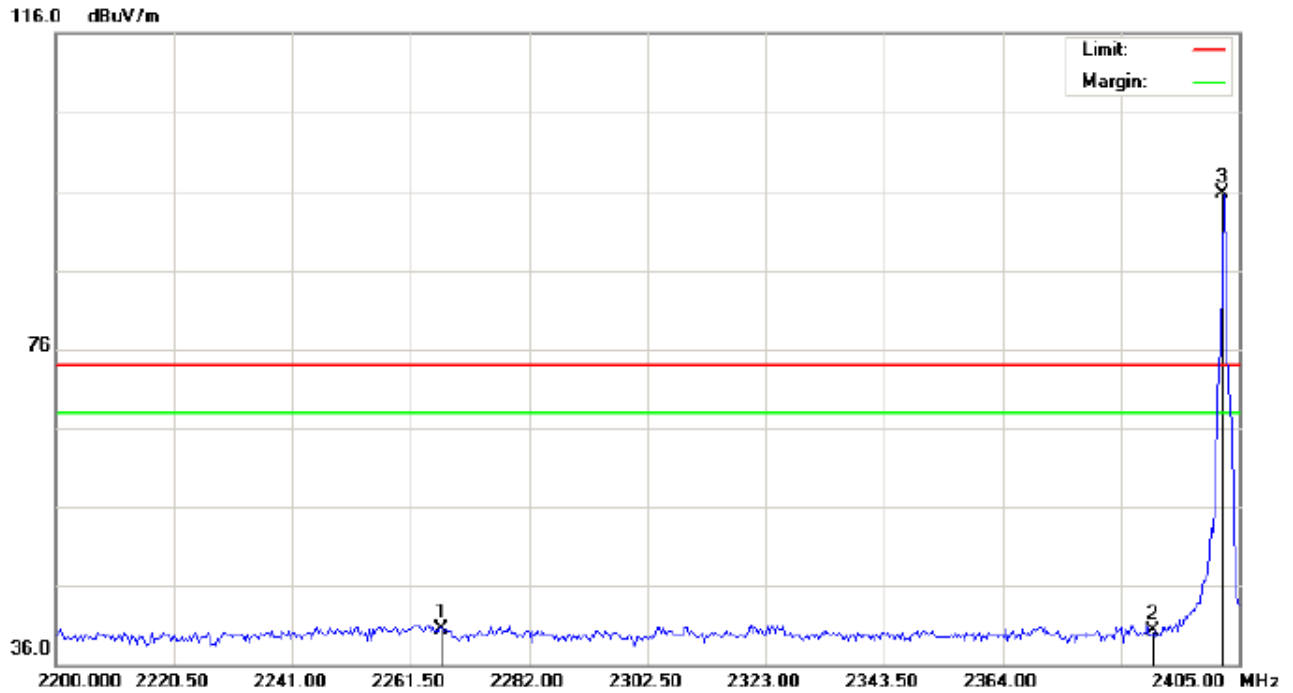

Site: site #1
Limit: FCC Class B 3M Radiation above 1GHz(PK)
EUT:VIVITAR Bluetooth speaker
M/N:VZ60030BT
Mode: Low Channel TX
Note:

Polarization: *Horizontal*
Power:
Distance:

Temperature: 26
Humidity: 60 %

No.	Mk	Freq.	Reading	Factor	Measurement	Limit	Over	Detector	Antenna Height	Table Degree	Comment
		MHz	dBuV	dB/m	dBuV/m	dBuV/m	dB		cm	degree	
1		2266.966	30.37	10.17	40.54	74.00	-33.46	peak			
2		2390.000	30.00	10.31	40.31	74.00	-33.69	peak			
3	*	2402.000	85.29	10.32	95.61	74.00	21.61	peak			

TEST PLOT OF BAND EDGE FOR HIGH CHANNEL -Horizontal

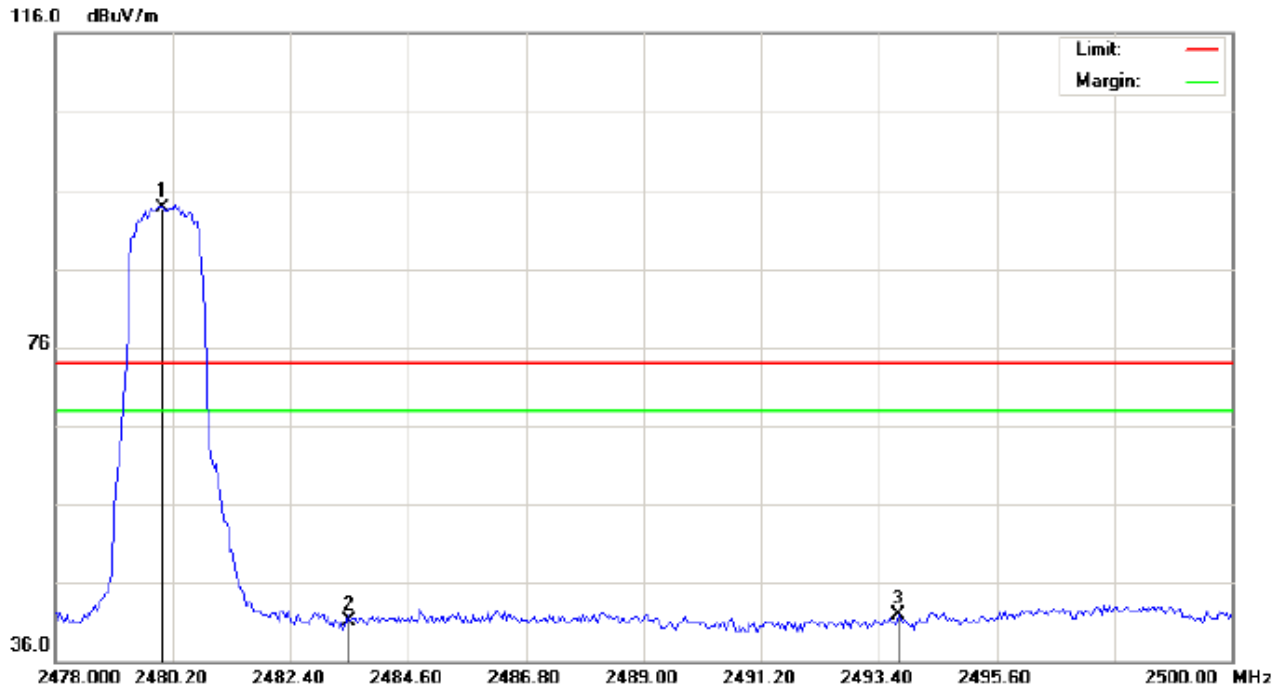

Site: site #1 Polarization: *Horizontal* Temperature: 26
Limit: FCC Class B 3M Radiation above 1GHz(PK) Power: Humidity: 60 %
EUT:VIVITAR Bluetooth speaker Distance:
M/N:VZ60030BT
Mode: High Channel TX
Note:

No.	Mk	Freq.	Reading	Factor	Measurement	Limit	Over	Detector	Antenna Height	Table Degree	Comment
		MHz	dBuV	dB/m	dBuV/m	dBuV/m	dB		cm	degree	
1	*	2480.000	83.25	10.41	93.66	74.00	19.66	peak			
2		2483.500	30.69	10.41	41.10	74.00	-32.90	peak			
3		2493.767	31.53	10.42	41.95	74.00	-32.05	peak			

10. 20DB BANDWIDTH

10.1. MEASUREMENT PROCEDURE

1. Connect EUT RF output port to the Spectrum Analyzer through an RF attenuator
2. Set the EUT Work on the top, the middle and the bottom operation frequency individually.
3. Set Span = approximately 2 to 3 times the 20 dB bandwidth, centered on a hoping channel
 $RBW \geq 1\%$ of the 20 dB bandwidth, $VBW \geq RBW$; Sweep = auto; Detector function = peak
4. Set SPA Trace 1 Max hold, then View.

10.2. TEST SET-UP

(BLOCK DIAGRAM OF CONFIGURATION)

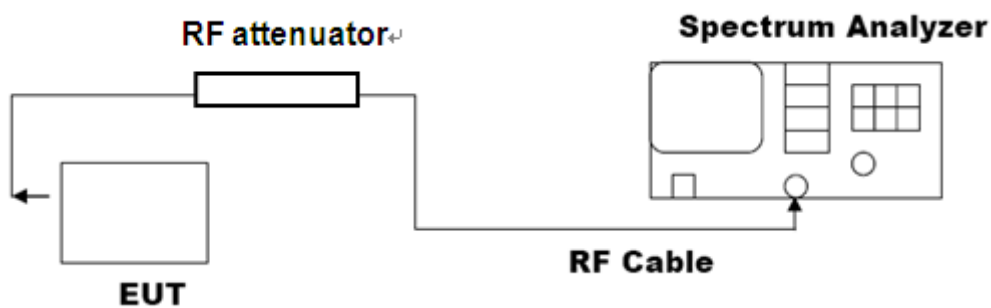

Note: The EUT has been used temporary antenna connector for testing.

10.3. LIMITS AND MEASUREMENT RESULTS

FOR BR/EDR

BLUETOOTH 1MBPS LIMITS AND MEASUREMENT RESULT				
Applicable Limits	Measurement Result			
	Test Data (MHz)			Result
		99%OBW (MHz)	-20dB BW(MHz)	
N/A	Low Channel	1.016	1.188	PASS
	Middle Channel	1.013	1.184	PASS
	High Channel	1.010	1.188	PASS

TEST PLOT OF BANDWIDTH FOR LOW CHANNEL

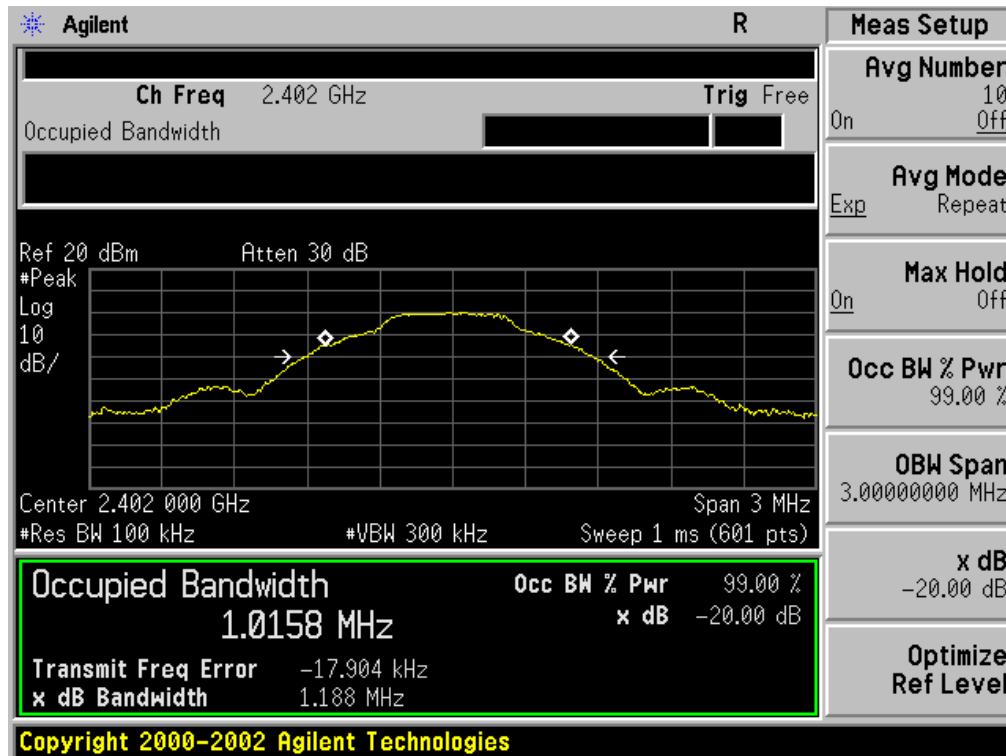

TEST PLOT OF BANDWIDTH FOR MIDDLE CHANNEL

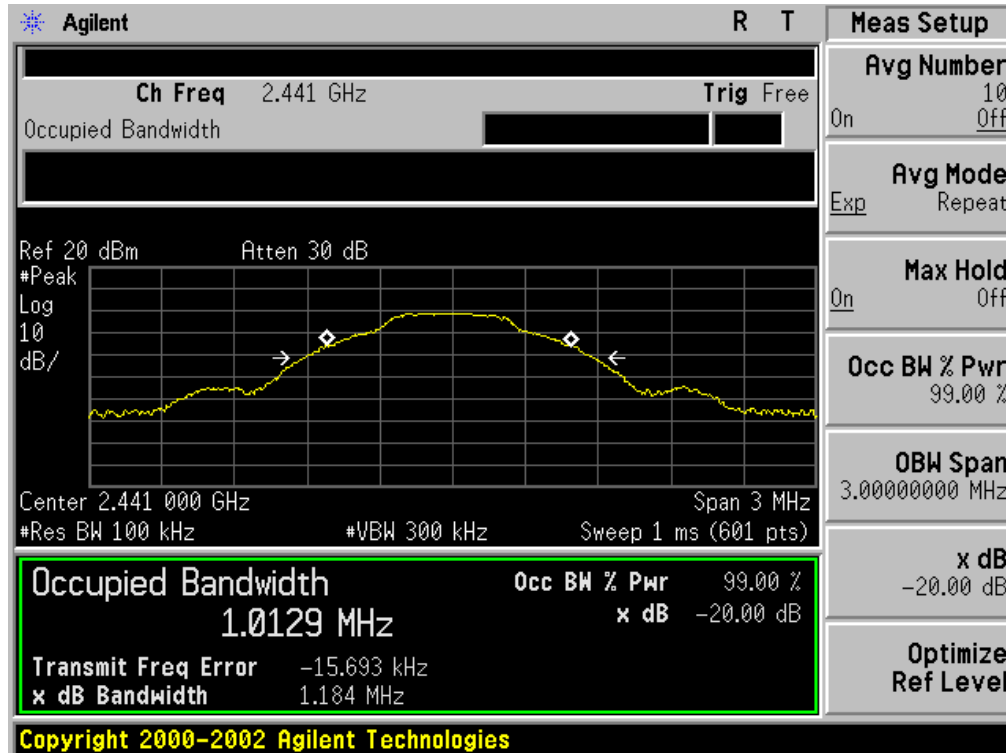

TEST PLOT OF BANDWIDTH FOR HIGH CHANNEL

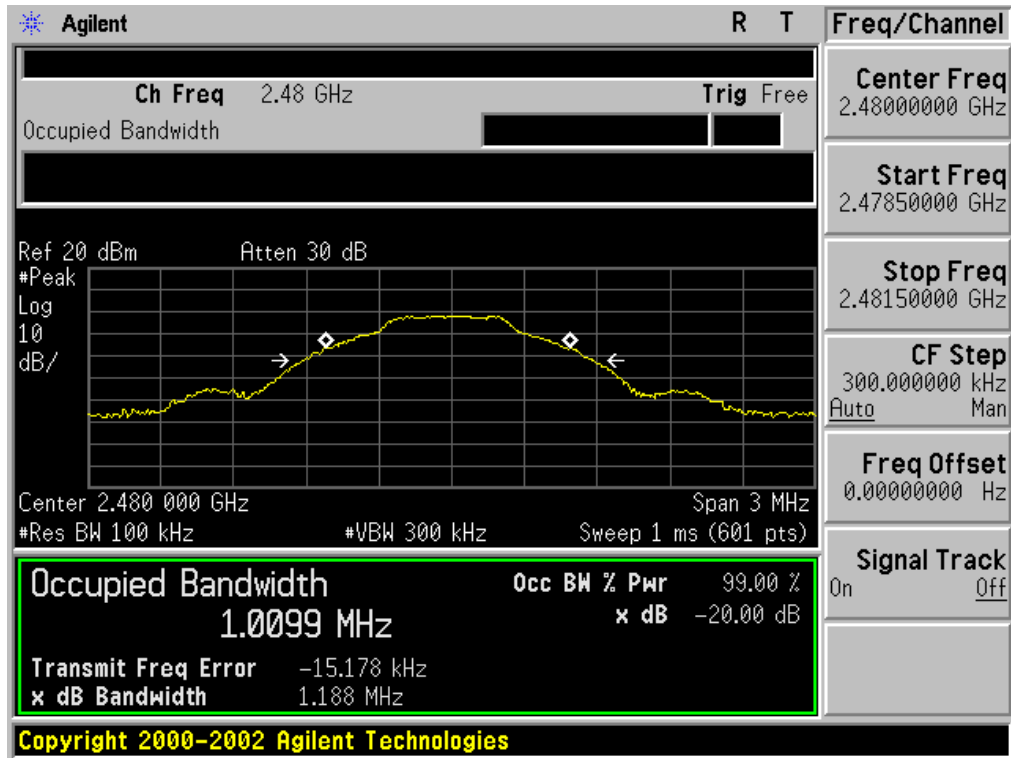

BLUETOOTH 2MBPS LIMITS AND MEASUREMENT RESULT				
Applicable Limits	Measurement Result			
	Test Data (MHz)			Result
		99%OBW (MHz)	-20dB BW(MHz)	
N/A	Low Channel	1.297	1.444	PASS
	Middle Channel	1.275	1.431	PASS
	High Channel	1.273	1.434	PASS

TEST PLOT OF BANDWIDTH FOR LOW CHANNEL

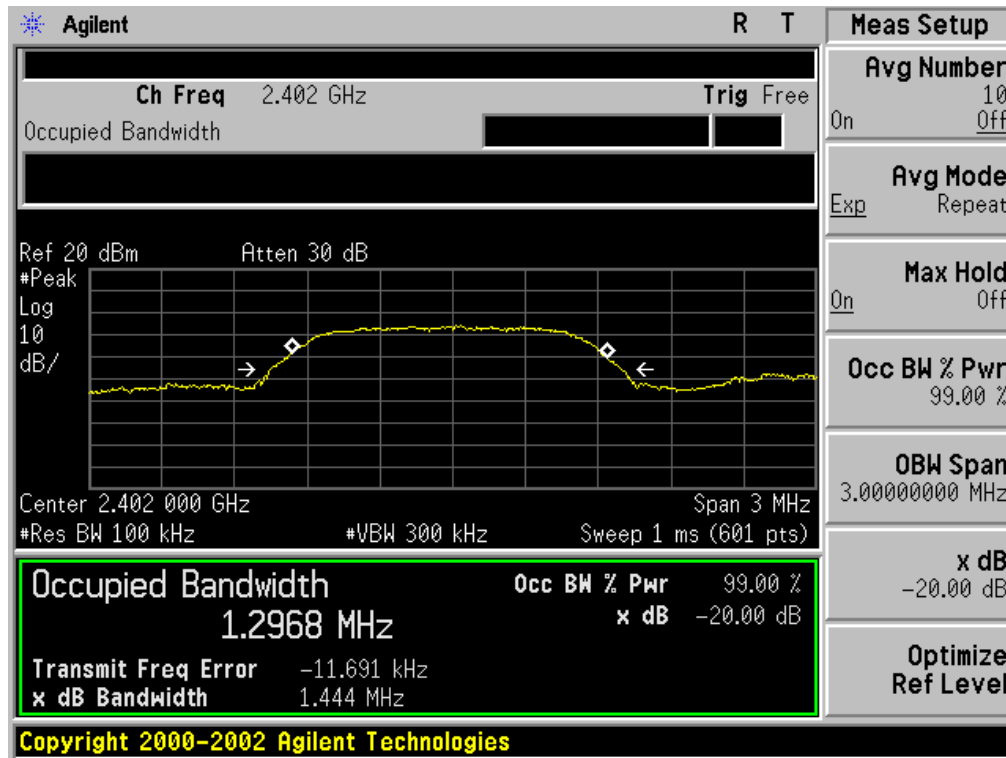

TEST PLOT OF BANDWIDTH FOR MIDDLE CHANNEL

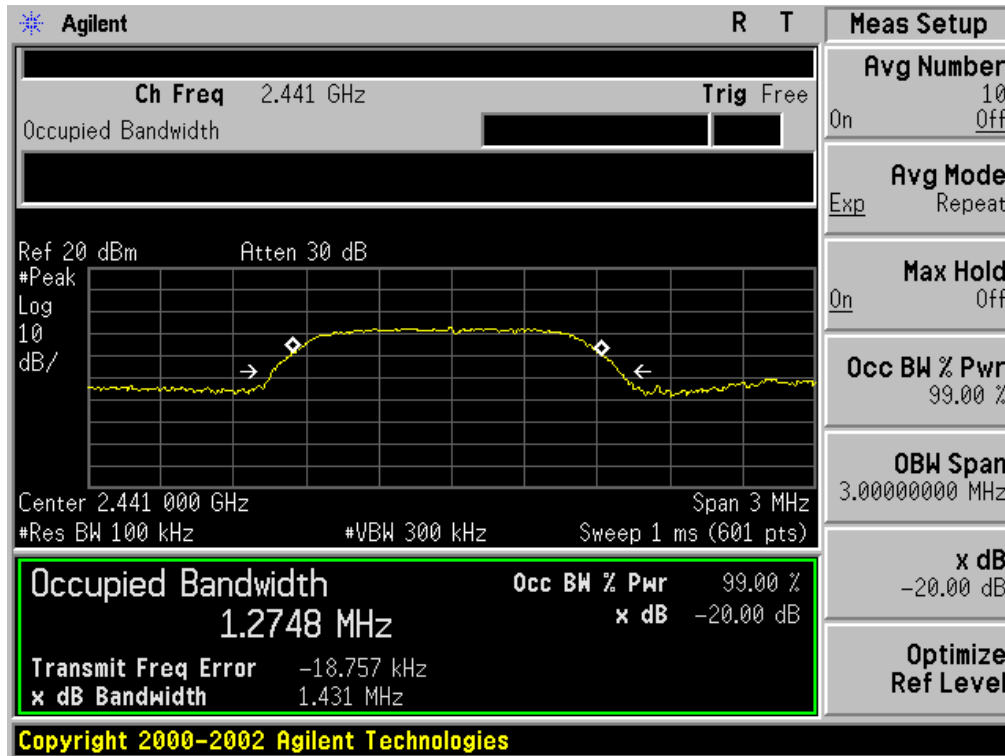

TEST PLOT OF BANDWIDTH FOR HIGH CHANNEL

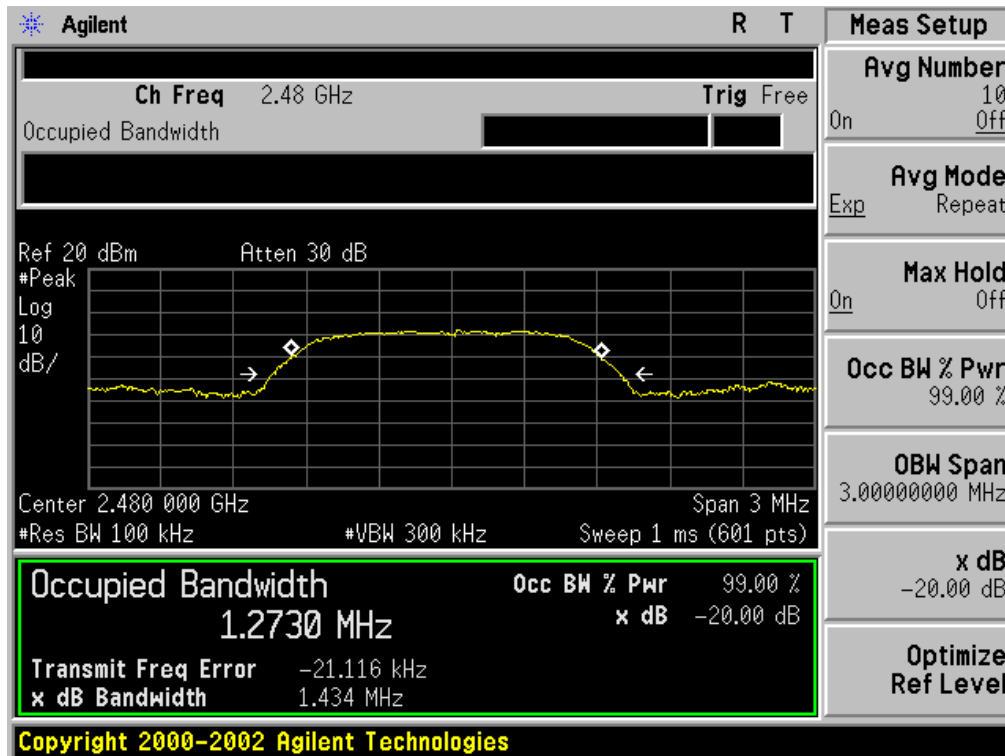

BLUETOOTH 3MBPS LIMITS AND MEASUREMENT RESULT				
Applicable Limits	Measurement Result			
	Test Data (MHz)			Result
		99%OBW (MHz)	-20dB BW(MHz)	
N/A	Low Channel	1.328	1.437	PASS
	Middle Channel	1.324	1.425	PASS
	High Channel	1.326	1.418	PASS

TEST PLOT OF BANDWIDTH FOR LOW CHANNEL

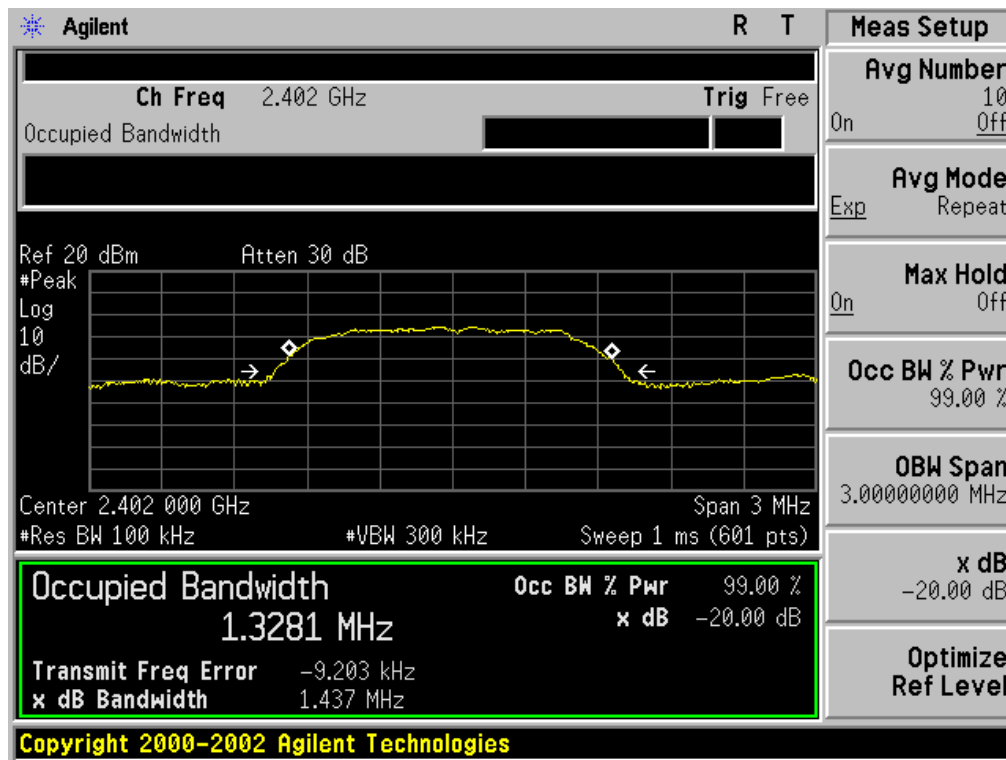

TEST PLOT OF BANDWIDTH FOR MIDDLE CHANNEL

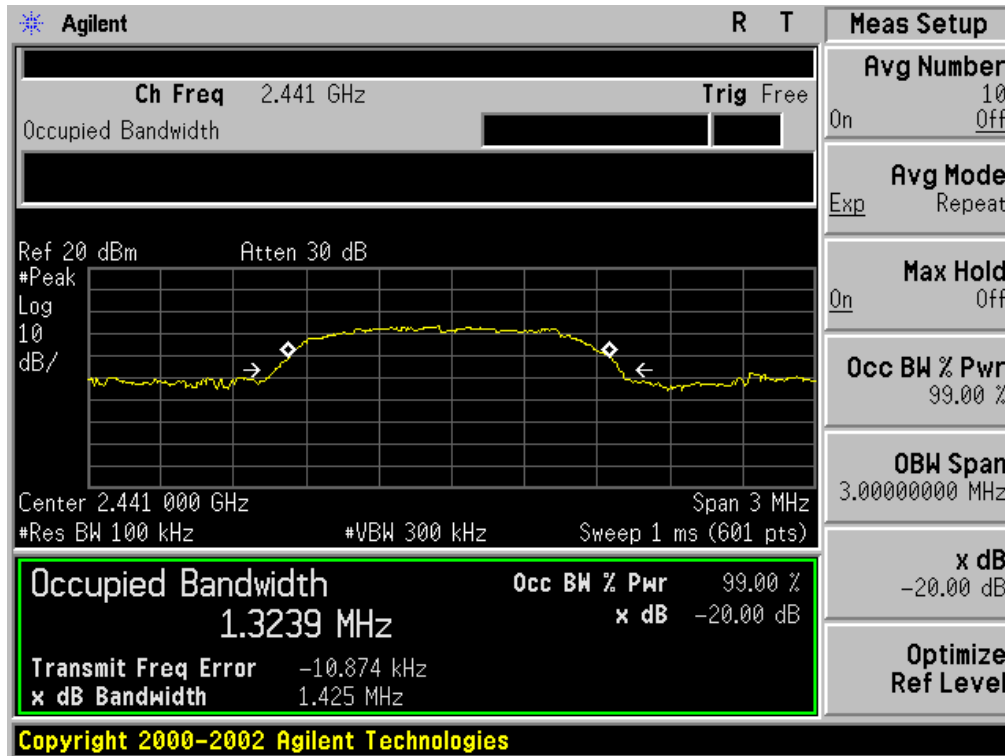

TEST PLOT OF BANDWIDTH FOR HIGH CHANNEL

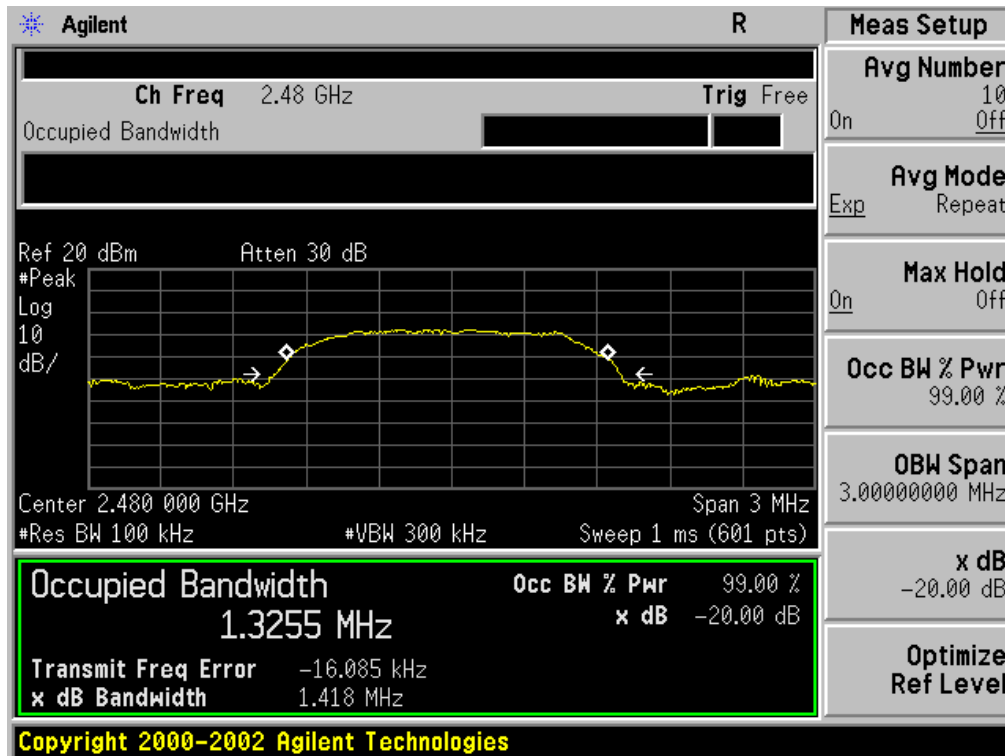

11. FCC LINE CONDUCTED EMISSION TEST

11.1. LIMITS OF LINE CONDUCTED EMISSION TEST

Frequency	Maximum RF Line Voltage	
	Q.P.(dBuV)	Average(dBuV)
150kHz~500kHz	66-56	56-46
500kHz~5MHz	56	46
5MHz~30MHz	60	50

Note:

1. The lower limit shall apply at the transition frequency.
2. The limit decreases linearly with the logarithm of the frequency in the range 0.15 MHz to 0.50 MHz.

11.2. BLOCK DIAGRAM OF LINE CONDUCTED EMISSION TEST

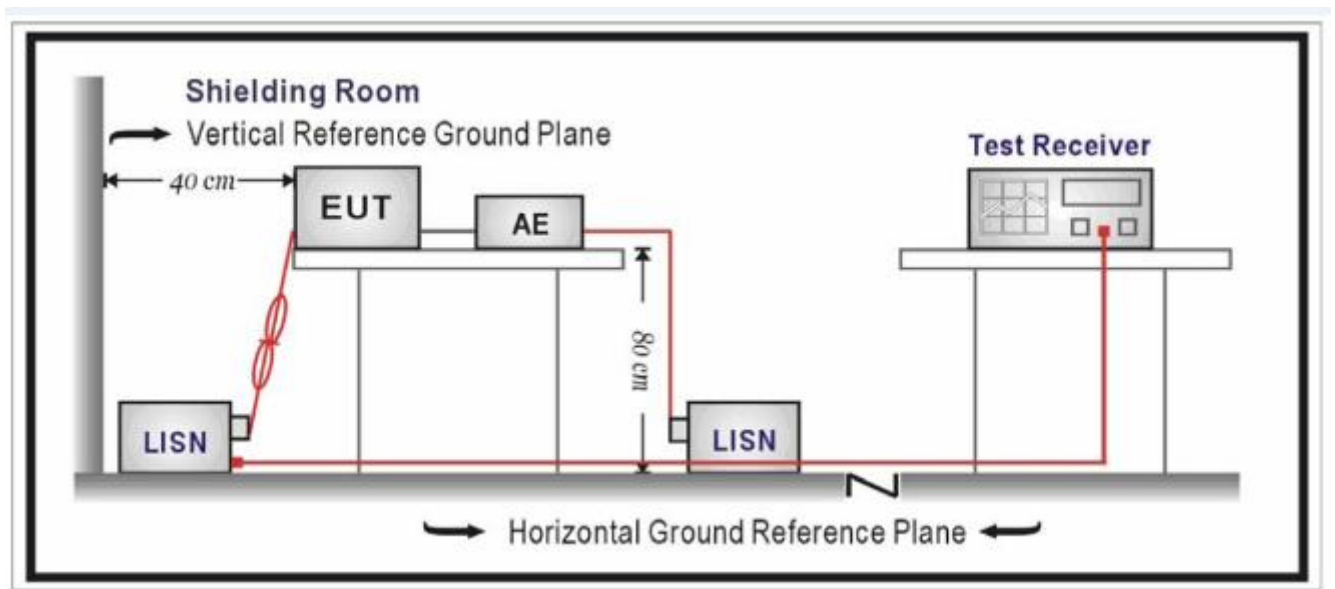

11.3. PRELIMINARY PROCEDURE OF LINE CONDUCTED EMISSION TEST

1. The equipment was set up as per the test configuration to simulate typical actual usage per the user's manual. When the EUT is a tabletop system, a wooden table with a height of 0.8 meters is used and is placed on the ground plane as per ANSI C63.10 (see Test Facility for the dimensions of the ground plane used). When the EUT is a floor-standing equipment, it is placed on the ground plane which has a 3-12 mm non-conductive covering to insulate the EUT from the ground plane.
2. Support equipment, if needed, was placed as per ANSI C63.10.
3. All I/O cables were positioned to simulate typical actual usage as per ANSI C63.10.
4. All support equipments received AC120V/60Hz power from a LISN, if any.
5. The EUT received DC charging voltage by adapter or PC which received 120V/60Hz power by a LISN.
6. The test program was started. Emissions were measured on each current carrying line of the EUT using a spectrum Analyzer / Receiver connected to the LISN powering the EUT. The LISN has two monitoring points: Line 1 (Hot Side) and Line 2 (Neutral Side). Two scans were taken: one with Line 1 connected to Analyzer / Receiver and Line 2 connected to a 50 ohm load; the second scan had Line 1 connected to a 50 ohm load and Line 2 connected to the Analyzer / Receiver.
7. Analyzer / Receiver scanned from 150 kHz to 30MHz for emissions in each of the test modes.
8. During the above scans, the emissions were maximized by cable manipulation.
9. The test mode(s) were scanned during the preliminary test.

Then, the EUT configuration and cable configuration of the above highest emission level were recorded for reference of final testing.

11.4. FINAL PROCEDURE OF LINE CONDUCTED EMISSION TEST

1. EUT and support equipment was set up on the test bench as per step 2 of the preliminary test.
2. A scan was taken on both power lines, Line 1 and Line 2, recording at least the six highest emissions. Emission frequency and amplitude were recorded into a computer in which correction factors were used to calculate the emission level and compare reading to the applicable limit. If EUT emission level was less -2dB to the A.V. limit in Peak mode, then the emission signal was re-checked using Q.P and Average detector.
3. The test data of the worst case condition(s) was reported on the Summary Data page.

11.5. TEST RESULT OF LINE CONDUCTED EMISSION TEST

By adapter(worst case)
FOR BR/EDR

Line Conducted Emission Test Line 1-L

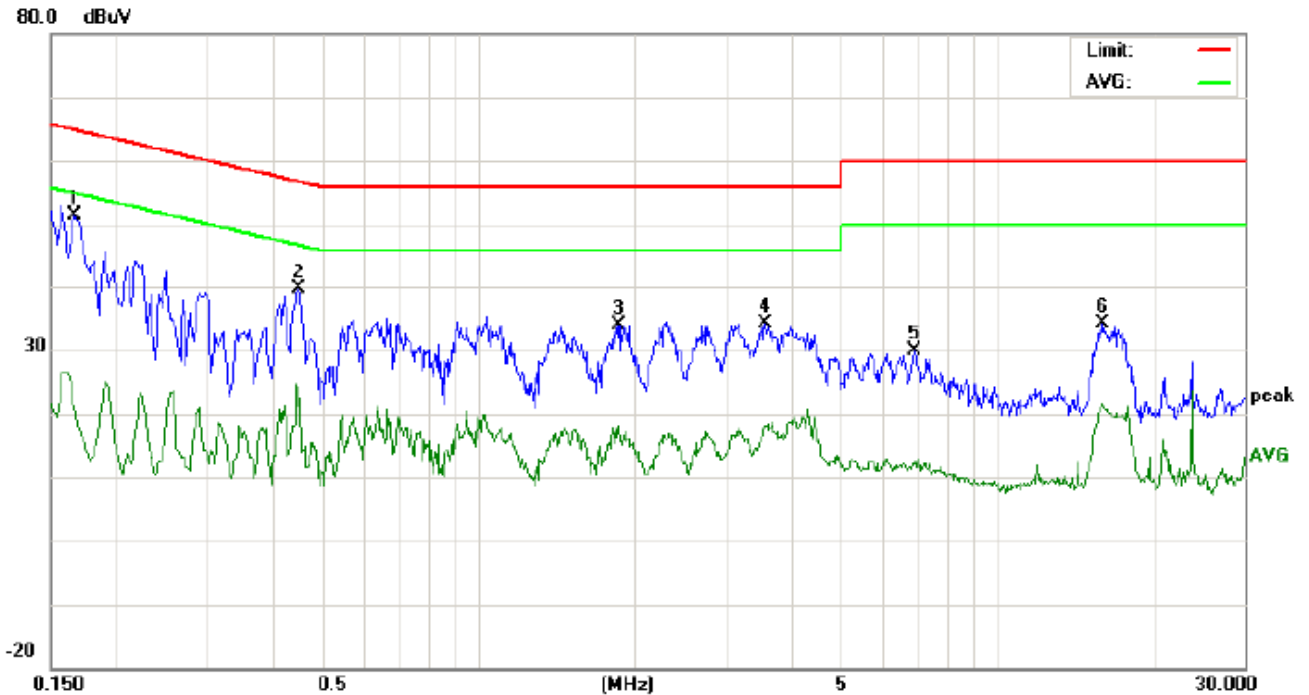

Site: Conduction Phase: **L1** Temperature: 26
 Limit: FCC Class B Conduction(QP) Power: Humidity: 60 %
 EUT:VIVITAR Bluetooth speaker
 M/N:VZ60030BT
 Mode:BT Link with charging
 Note:

No.	Freq. (MHz)	Reading_Level (dBuV)			Correct Factor (dB)	Measurement (dBuV)			Limit (dBuV)		Margin (dB)		P/F	Comment
		Peak	QP	AVG		Peak	QP	AVG	QP	AVG	QP	AVG		
1	0.1660	41.27		10.68	10.18	51.45		20.86	65.15	55.15	-13.70	-34.29	P	
2	0.4500	29.21		10.69	10.37	39.58		21.06	56.87	46.87	-17.29	-25.81	P	
3	1.8660	23.62		7.87	10.26	33.88		18.13	56.00	46.00	-22.12	-27.87	P	
4	3.5740	23.50		7.51	10.50	34.00		18.01	56.00	46.00	-22.00	-27.99	P	
5	6.9499	19.48		2.08	10.35	29.83		12.43	60.00	50.00	-30.17	-37.57	P	
6	15.9699	23.90		11.41	10.11	34.01		21.52	60.00	50.00	-25.99	-28.48	P	

Line Conducted Emission Test Line 2-N

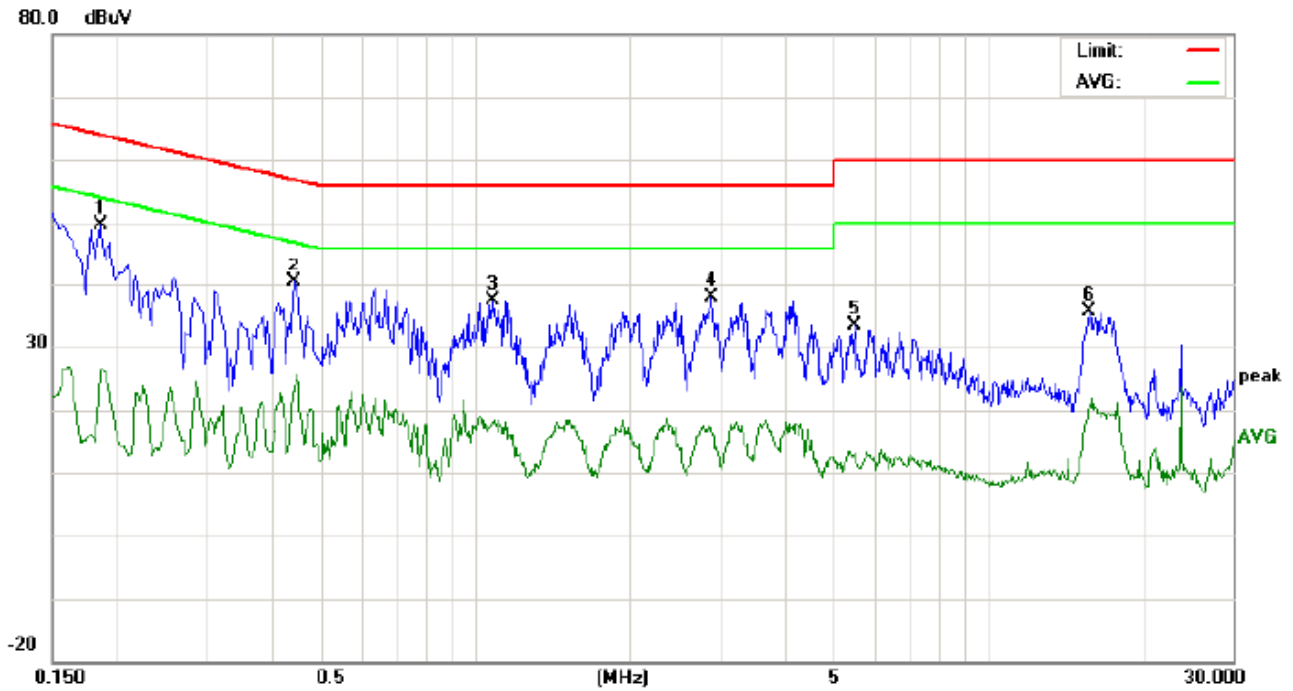

Site: Conduction Phase: **N** Temperature: 26
Limit: FCC Class B Conduction(QP) Power: Humidity: 60 %
EUT:VIVITAR Bluetooth speaker
M/N:VZ60030BT
Mode:BT Link with charging
Note:

No.	Freq. (MHz)	Reading_Level (dBuV)			Correct Factor (dB)	Measurement (dBuV)			Limit (dBuV)		Margin (dB)		P/F	Comment
		Peak	QP	AVG		Peak	QP	AVG	QP	AVG	QP	AVG		
1	0.1860	39.41		16.12	10.20	49.61		26.32	64.21	54.21	-14.60	-27.89	P	
2	0.4460	30.06		13.47	10.36	40.42		23.83	56.95	46.95	-16.53	-23.12	P	
3	1.0780	27.04		7.71	10.37	37.41		18.08	56.00	46.00	-18.59	-27.92	P	
4	2.8900	41.01		11.58	10.52	51.53		22.10	56.00	46.00	-4.47	-23.90	P	
5	5.4939	23.12		2.80	10.25	33.37		13.05	60.00	50.00	-26.63	-36.95	P	
6	15.7579	25.44		10.26	10.11	35.55		20.37	60.00	50.00	-24.45	-29.63	P	

APPENDIX A: PHOTOGRAPHS OF TEST SETUP

FCC LINE CONDUCTED EMISSION TEST SETUP

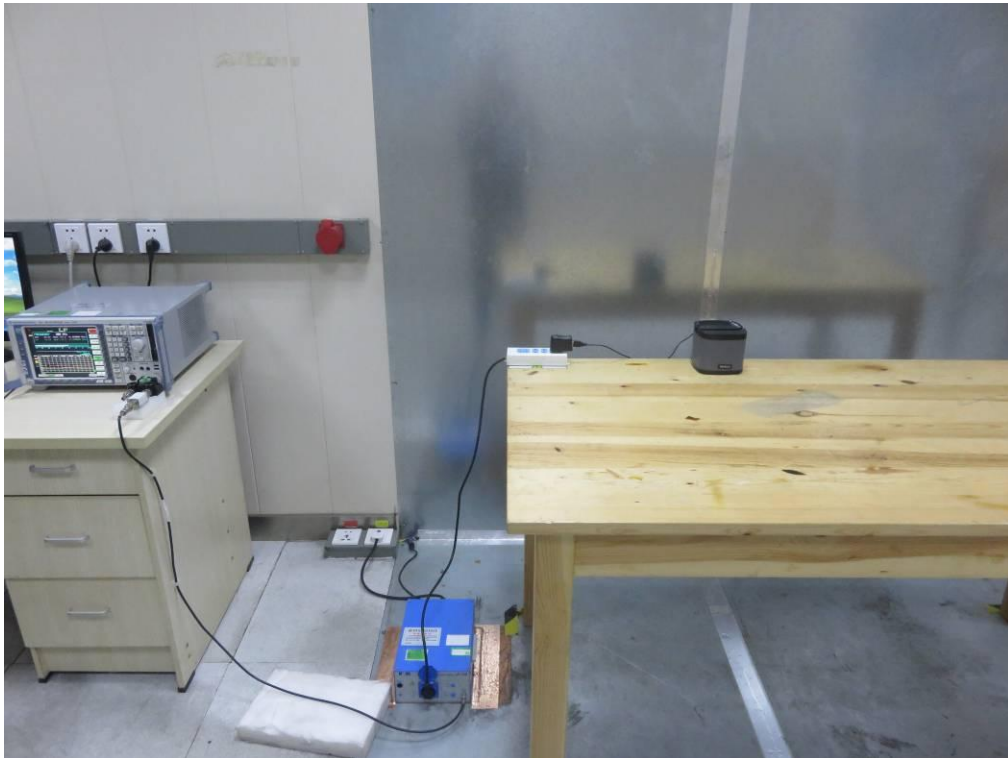

FCC RADIATED EMISSION TEST SETUP

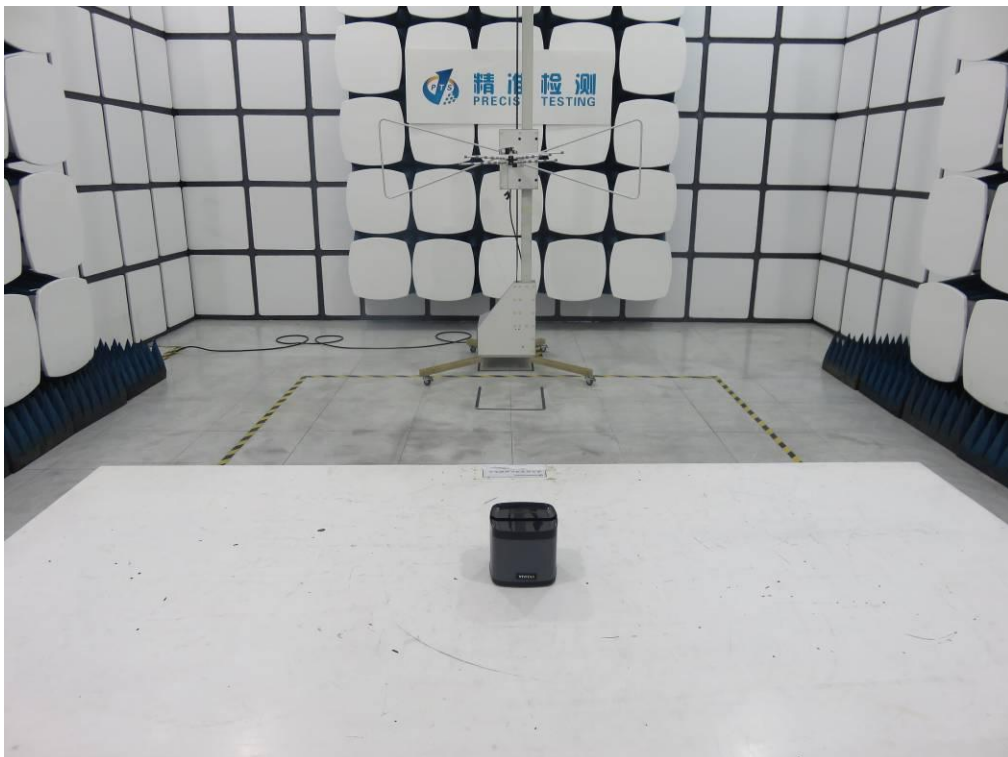

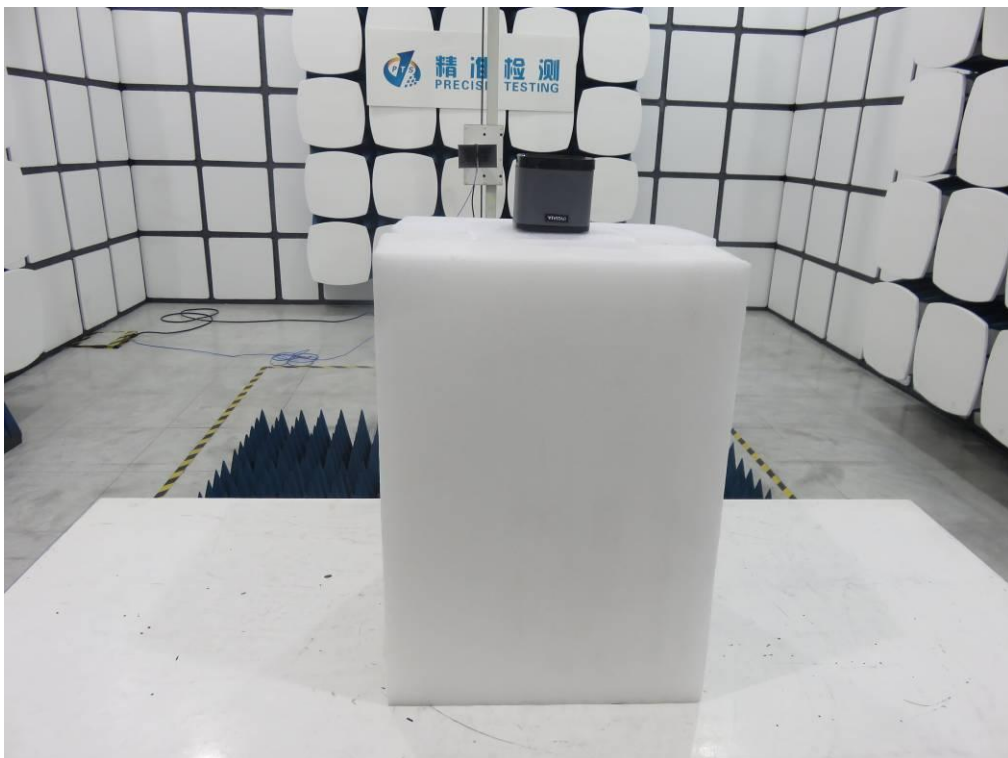
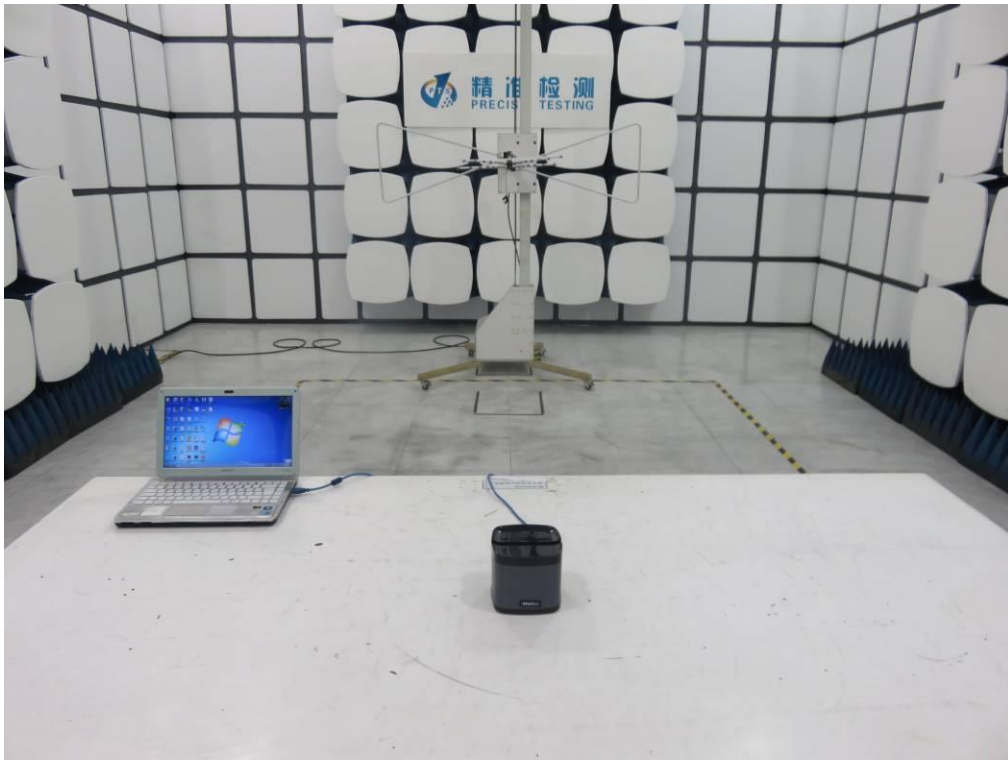

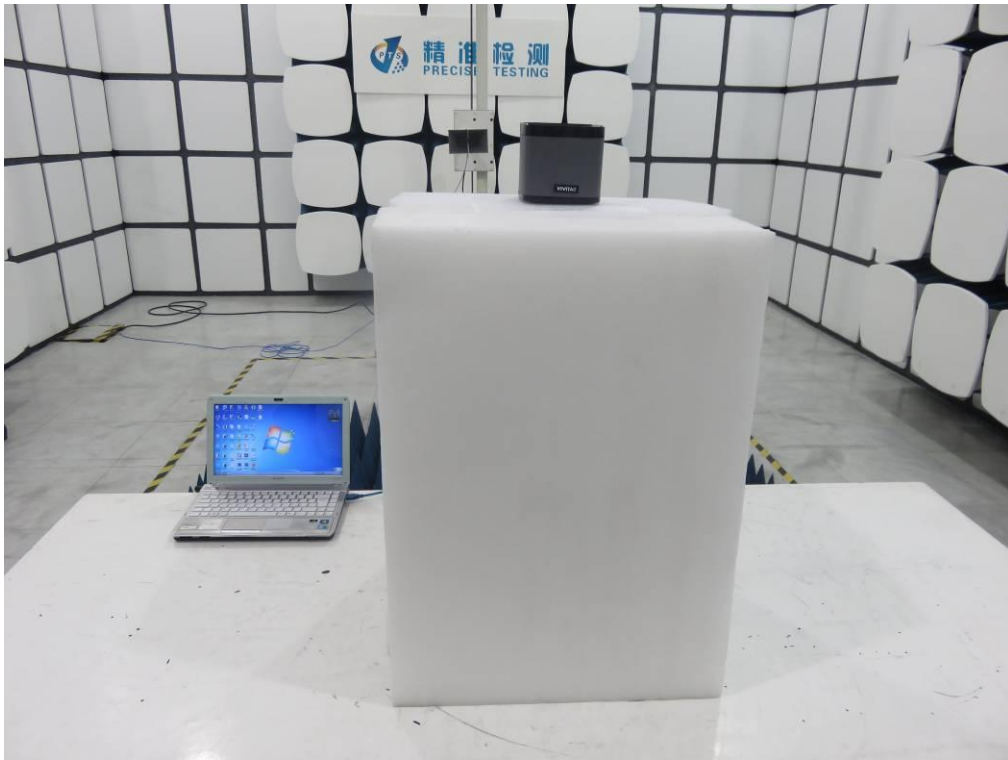

APPENDIX B: PHOTOGRAPHS OF EUT
WHOLE VIEW OF EUT



TOP VIEW OF EUT



BOTTOM VIEW OF EUT

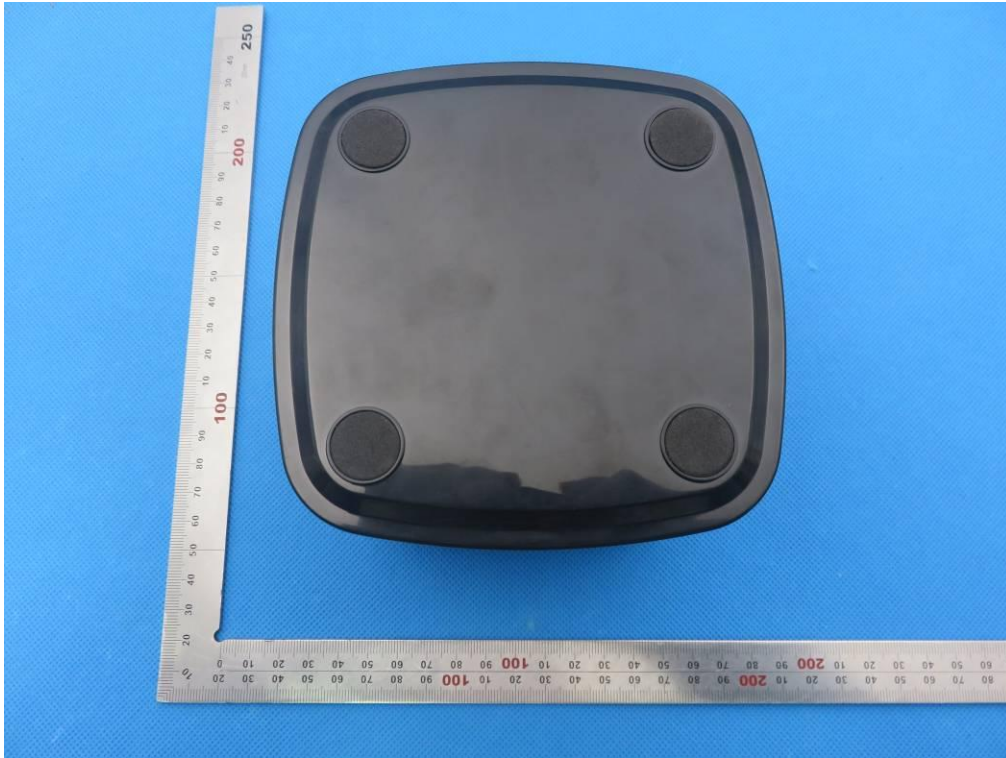

FRONT VIEW OF EUT

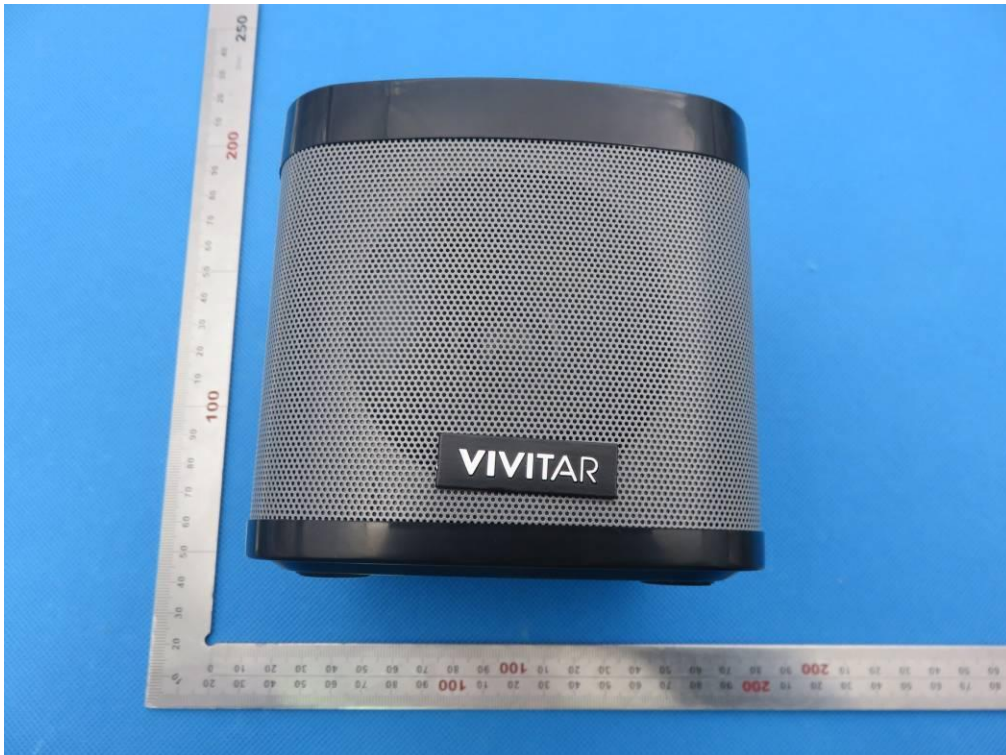

BACK VIEW OF EUT

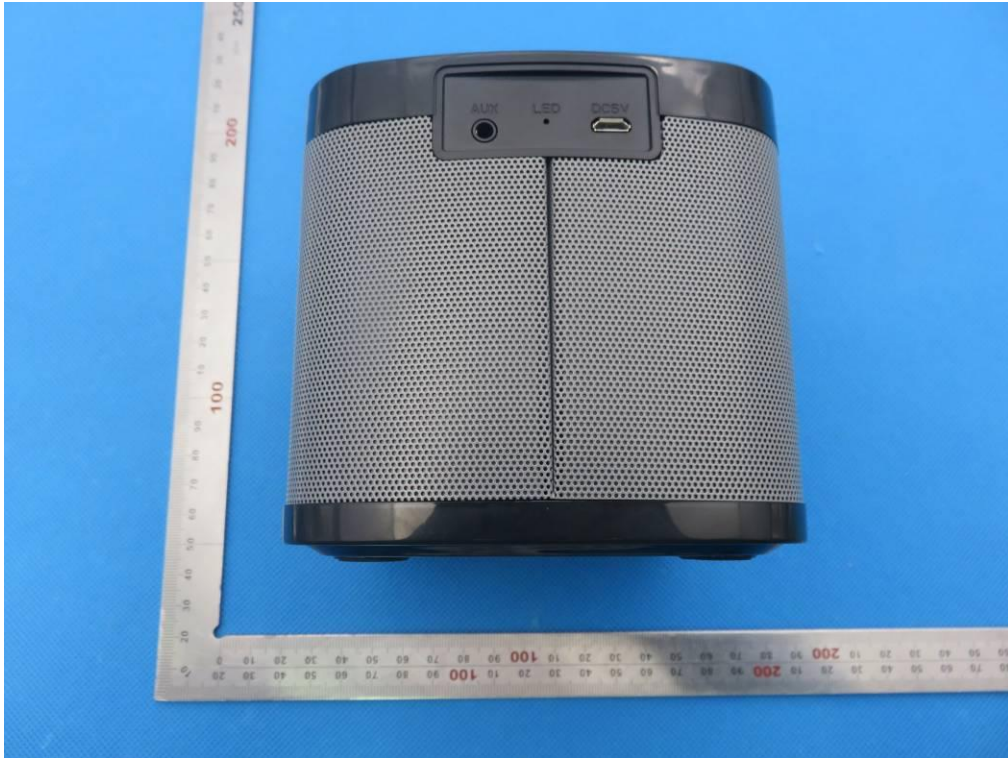

LEFT VIEW OF EUT

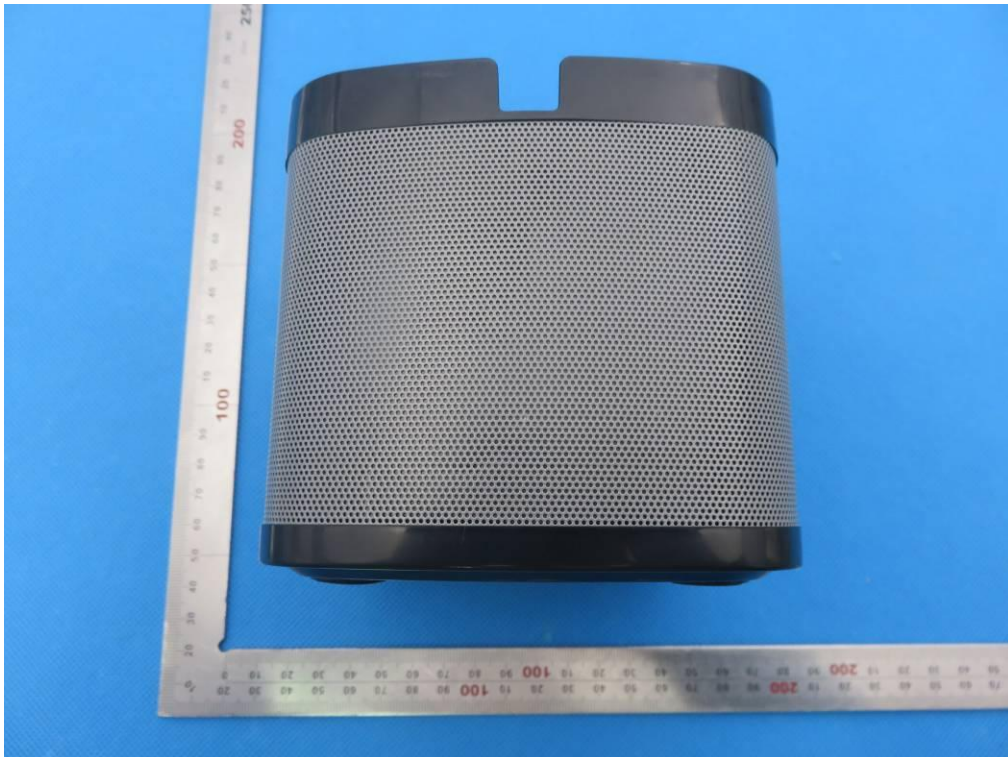

RIGHT VIEW OF EUT

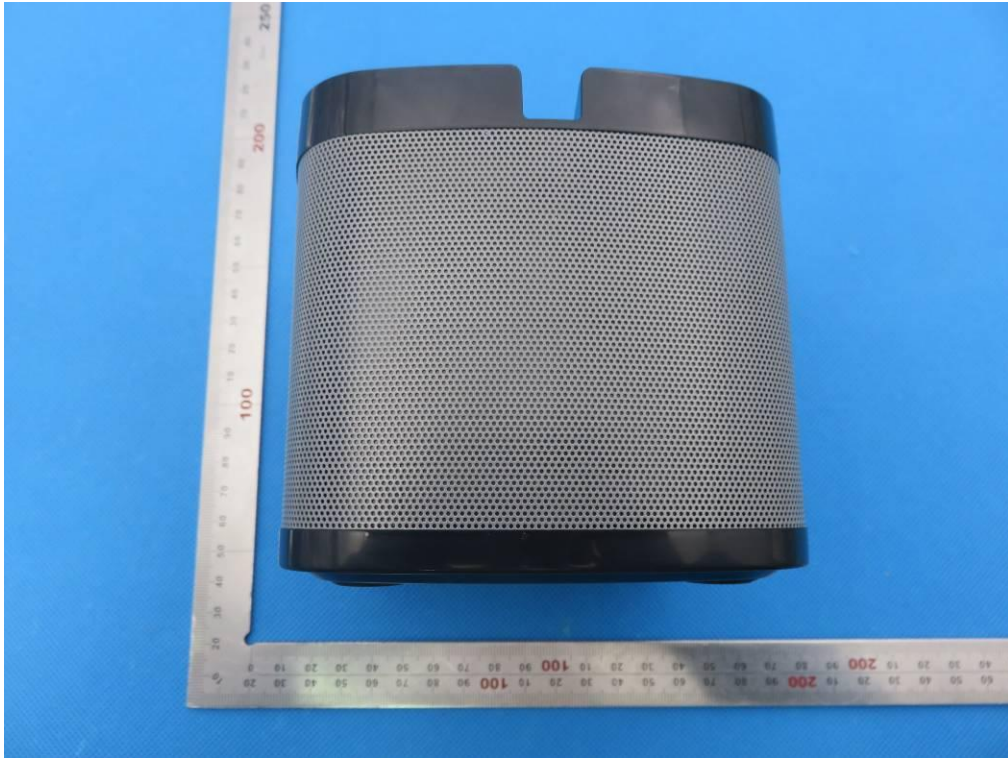

VIEW OF EUT (PORT)



OPEN VIEW OF EUT

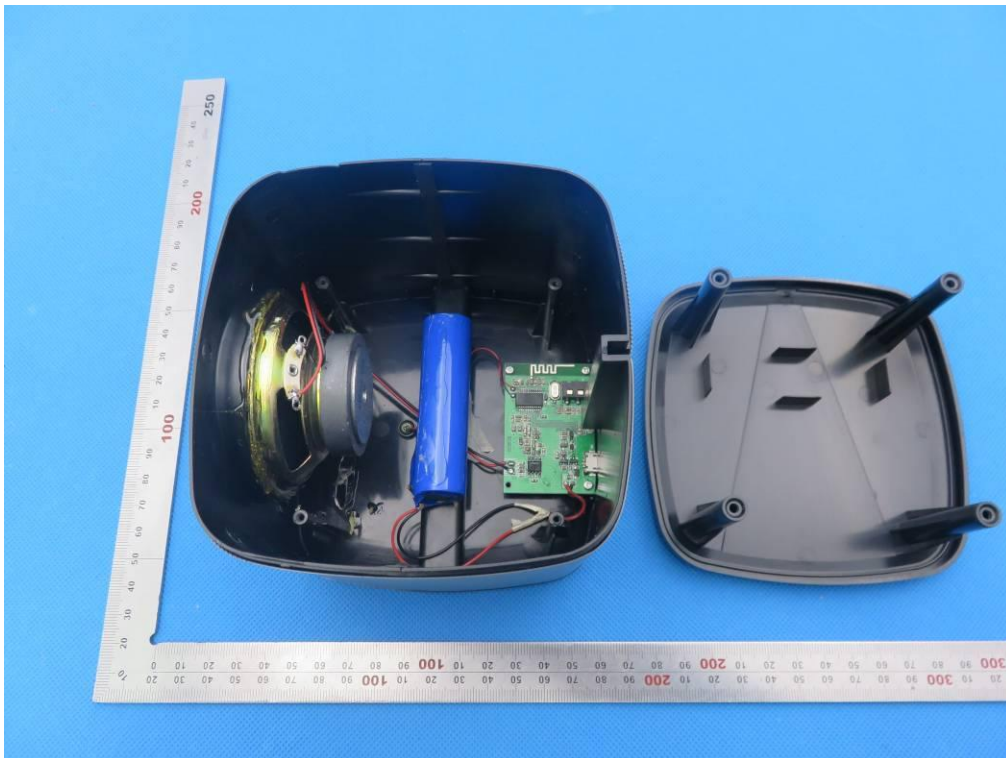

INTERNAL VIEW OF EUT-1

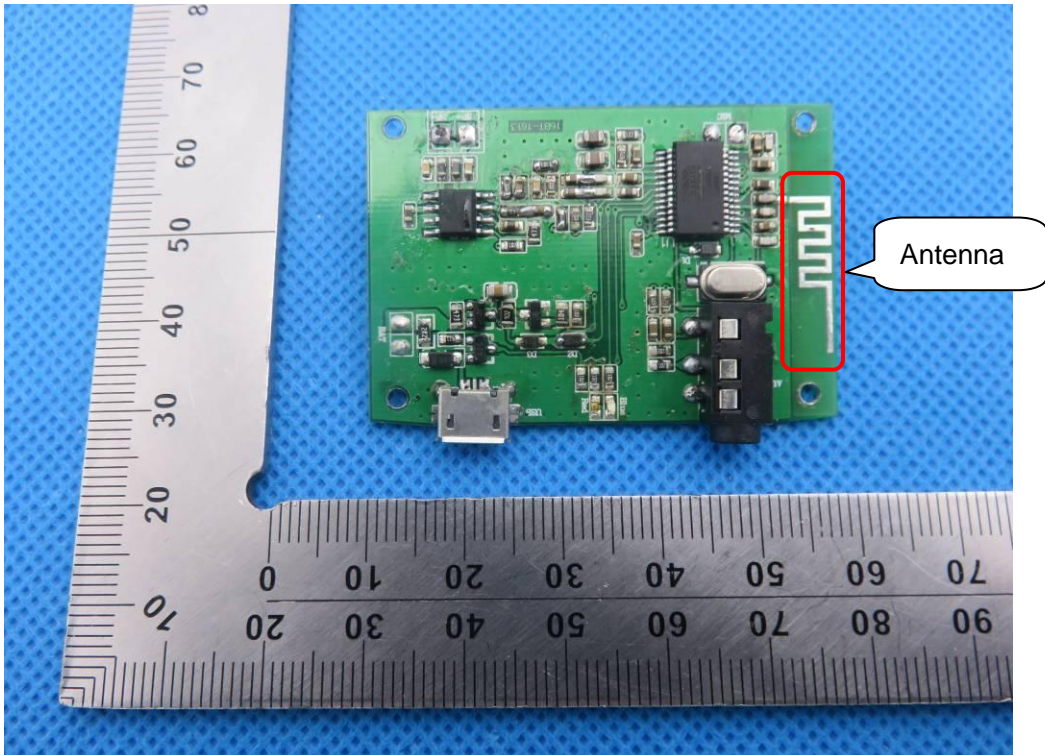

INTERNAL VIEW OF EUT-2

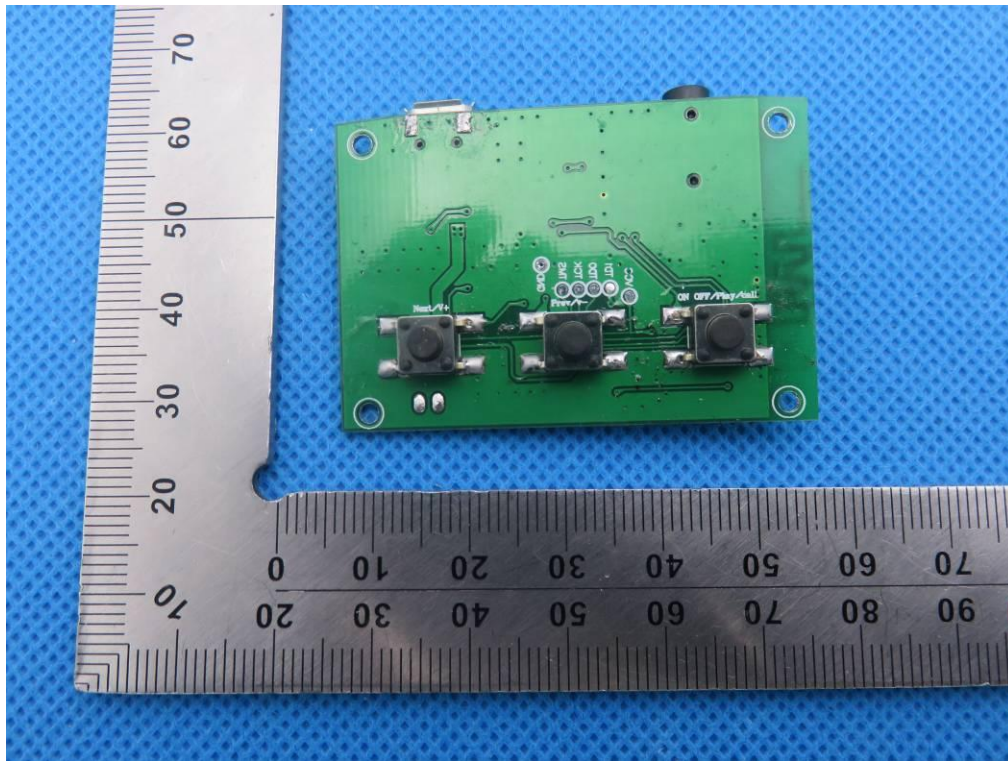

INTERNAL VIEW OF EUT-3

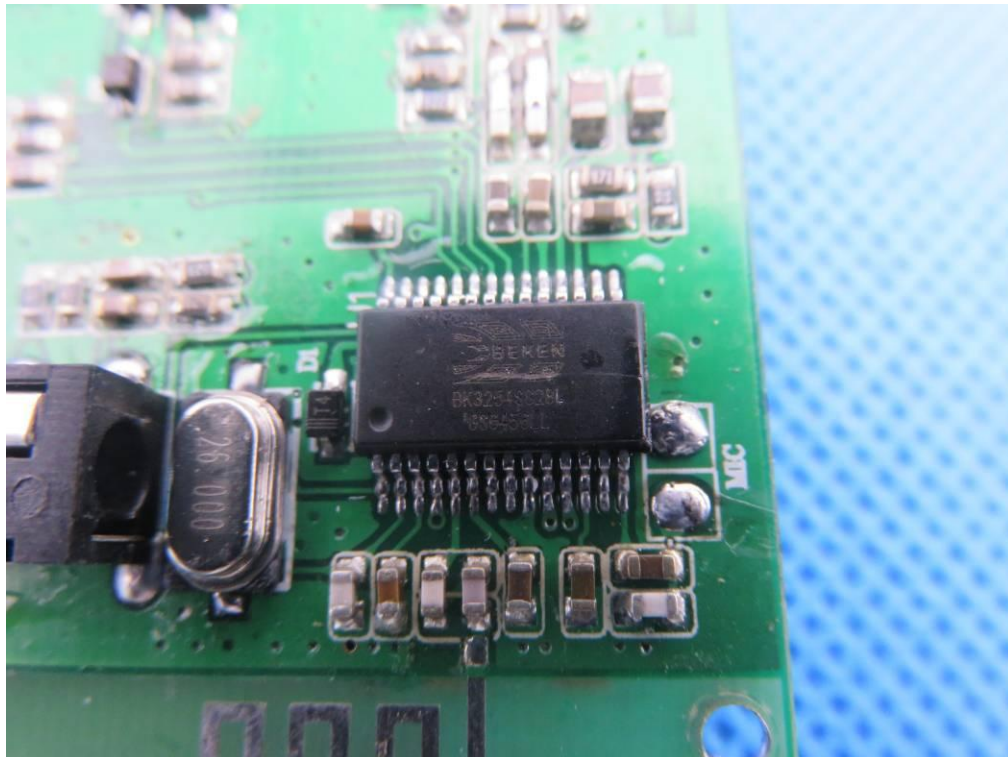

VIEW OF ADAPTER(AE)



The adapter was supplied by AGC

----END OF REPORT----