

NO.	Test item	Remark
1	VSWR	--
2	Gain and efficiency	--
3	Radiation pattern	--

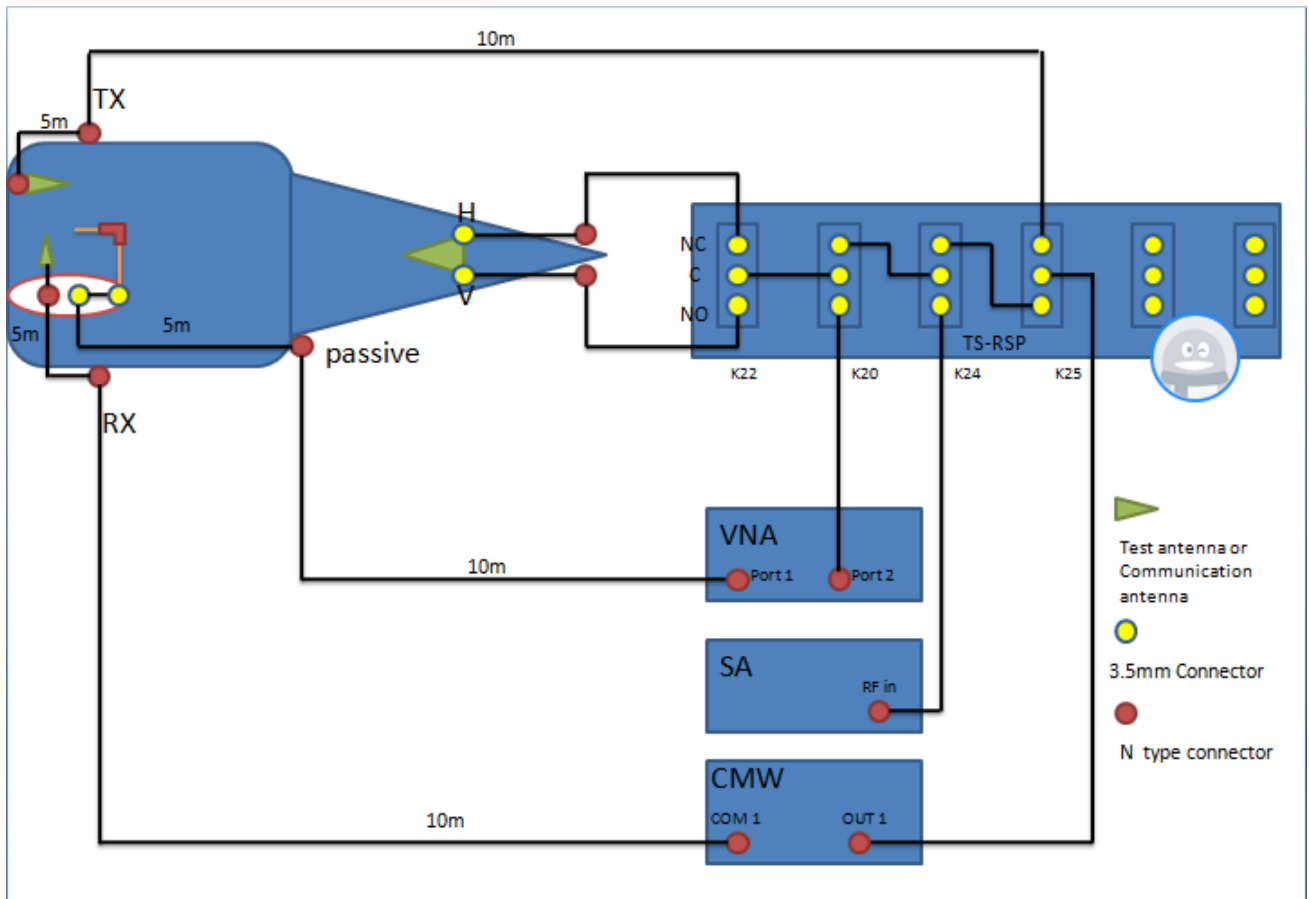

Shenzhen Bluetrum Technology Co.,Ltd
Address: Building A, Wisdom Plaza, o.4068 Qiaoxiang Road, Gaofa Community,
Shahe Street, Nanshan District, Shenzhen China
Model:F245C

Antenna Photo

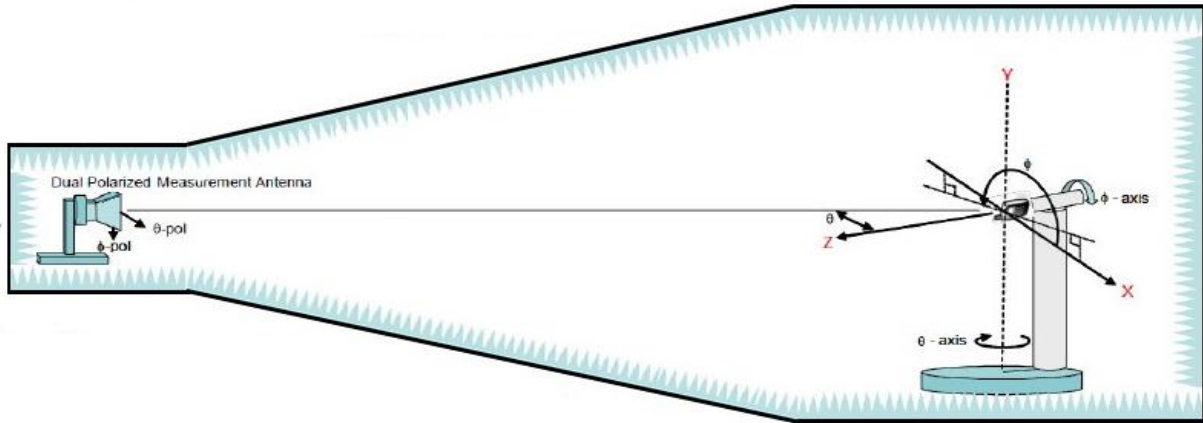
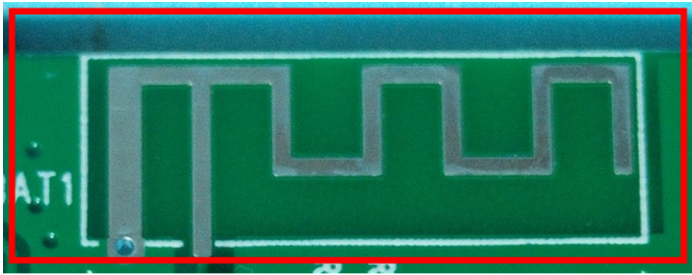

Frequency(MHz)	VSWR
2402	1.139:1
2450	1.155:1
2480	1.116:1

Frequency(MHz)	Efficiency(dB)	Efficiency(%)	Gain(dBi)
2400	-4.914	32.248	1.885
2410	-4.653	34.247	2.235
2420	-4.636	34.387	2.244
2430	-4.182	35.174	2.586
2440	-3.473	35.939	3.171
2450	-3.058	36.445	3.437
2460	-3.202	36.833	3.125
2470	-3.845	37.250	2.193
2480	-3.879	37.933	1.915
2490	-3.413	38.566	2.185
2500	-2.954	38.642	2.617

2D POLAR RADIATION PATTERN

FREQUENCY=2400MHZ

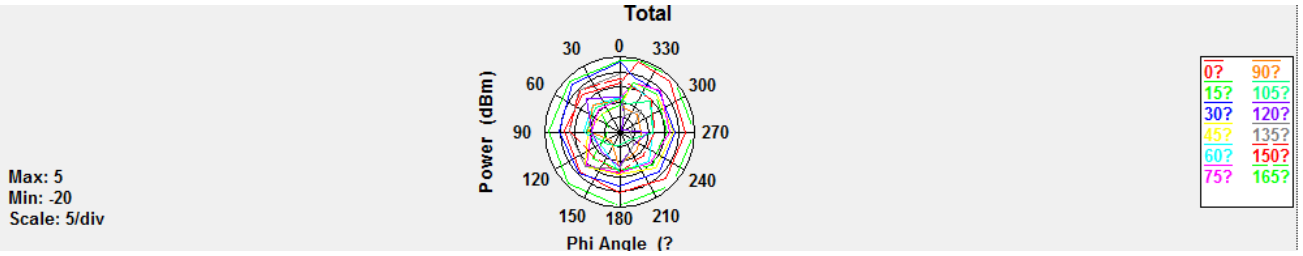

FREQUENCY=2450MHZ

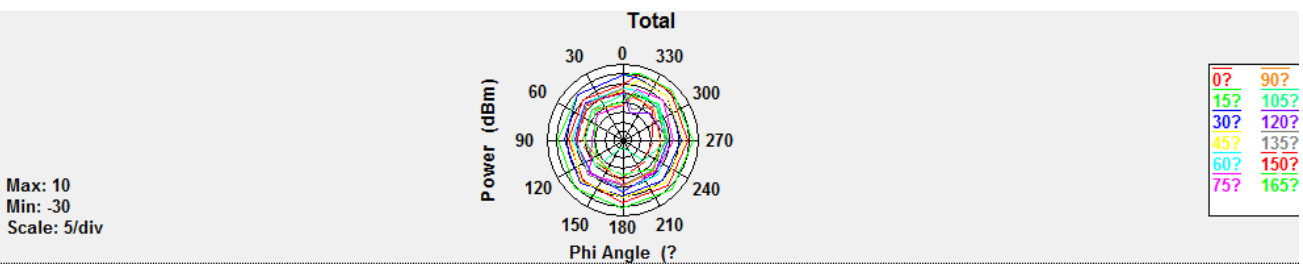

FREQUENCY=2500MHZ

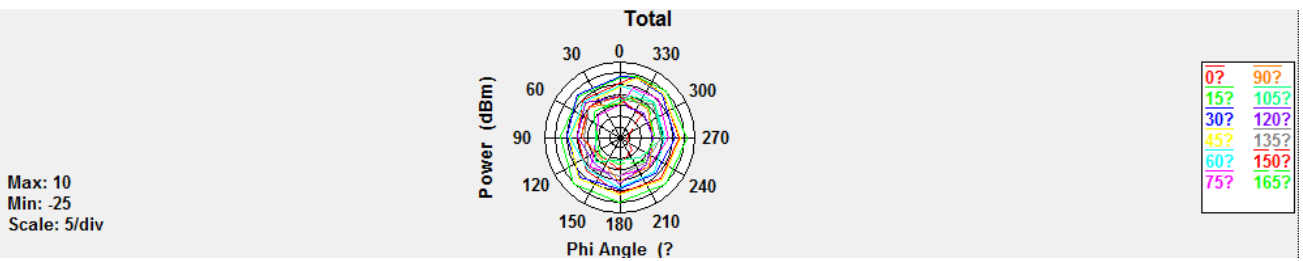

3D RADIATION PATTERN
FREQUENCY=2400MHZ

Total

Azimuth = 0.0
Elevation = 0.0
Roll = 0.0

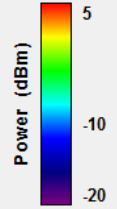
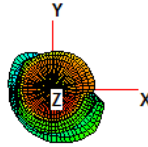

FREQUENCY=2450MHZ

Total

Azimuth = 0.0
Elevation = 0.0
Roll = 0.0

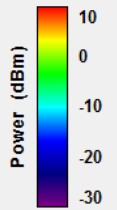
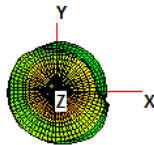

FREQUENCY=2500MHZ

Total

Azimuth = 0.0
Elevation = 0.0
Roll = 0.0

