

---

# FCC Test Report

---

Report No.: AGC01824160401FE08

**FCC ID** : 2ADM5-MA-1999  
**APPLICATION PURPOSE** : Original Equipment  
**PRODUCT DESIGNATION** : Bluetooth headset  
**BRAND NAME** : MUVE ACOUSTICS  
**MODEL NAME** : MA-1999  
**CLIENT** : Zeeva International Limited  
**DATE OF ISSUE** : Jun.03, 2016  
**STANDARD(S)** : FCC Part 15 Rules  
**REPORT VERSION** : V1.0

Attestation of Global Compliance (Shenzhen) Co., Ltd



**CAUTION:**

This report shall not be reproduced except in full without the written permission of the test laboratory and shall not be quoted out of context.



### Report Revise Record

Report Version	Revise Time	Issued Date	Valid Version	Notes
V1.0	/	Jun.03, 2016	Valid	Original Report

## TABLE OF CONTENTS

<b>1. VERIFICATION OF COMPLIANCE</b> .....	<b>5</b>
<b>2. GENERAL INFORMATION</b> .....	<b>6</b>
2.1 PRODUCT DESCRIPTION .....	6
2.2 RELATED SUBMITTAL(S)/GRANT(S).....	6
2.3 TEST METHODOLOGY .....	6
2.4 TEST FACILITY.....	6
2.5 SPECIAL ACCESSORIES.....	6
2.6 EQUIPMENT MODIFICATIONS.....	6
2.7 MEASUREMENT UNCERTAINTY .....	6
<b>3. SYSTEM TEST CONFIGURATION</b> .....	<b>7</b>
3.1 CONFIGURATION OF TESTED SYSTEM .....	7
3.2 EQUIPMENT USED IN TESTED SYSTEM .....	7
3.3. SUMMARY OF TEST RESULTS .....	8
<b>4. DESCRIPTION OF TEST MODES</b> .....	<b>9</b>
<b>5. ANTENNA REQUIREMENT</b> .....	<b>10</b>
5.1. STANDARD APPLICABLE .....	10
5.2. TEST RESULT .....	10
<b>6. TEST FACILITY</b> .....	<b>11</b>
<b>7. RADIATED EMISSION</b> .....	<b>12</b>
7.1 MEASUREMENT PROCEDURE.....	12
7.2 TEST SETUP.....	13
7.3 LIMITS AND MEASUREMENT RESULT .....	15
7.4 TEST RESULT (WORST MODULATION: GFSK) .....	16
<b>8. BAND EDGE EMISSION</b> .....	<b>28</b>
8.1. MEASUREMENT PROCEDURE.....	28
8.2. TEST SET-UP .....	28
8.3. TEST RESULT .....	29
<b>9. 6DB BANDWIDTH</b> .....	<b>33</b>
9.1. TEST PROCEDURE.....	33
9.2. SUMMARY OF TEST RESULTS/PLOTS .....	33
<b>10. CONDUCTED OUTPUT POWER</b> .....	<b>35</b>
10.1. MEASUREMENT PROCEDURE.....	35
10.2. TEST SET-UP (BLOCK DIAGRAM OF CONFIGURATION).....	35
10.3. LIMITS AND MEASUREMENT RESULT .....	36
<b>11. MAXIMUM CONDUCTED OUTPUT POWER SPECTRAL DENSITY</b> .....	<b>38</b>
11.1 MEASUREMENT PROCEDURE.....	38

11.2 TEST SET-UP (BLOCK DIAGRAM OF CONFIGURATION).....38

11.3 LIMITS AND MEASUREMENT RESULT .....38

**12. FCC LINE CONDUCTED EMISSION TEST .....41**

12.1 LIMITS .....41

12.2 TEST SETUP .....41

12.3 PRELIMINARY PROCEDURE .....42

12.4 FINAL TEST PROCEDURE .....42

12.5 TEST RESULT OF POWER LINE .....43

**APPENDIX A: PHOTOGRAPHS OF TEST SETUP .....44**

**APPENDIX B: PHOTOGRAPHS OF EUT .....45**

## 1. VERIFICATION OF COMPLIANCE

<b>Applicant</b>	Zeeva International Limited
<b>Address</b>	Suite 1007B,10th Floor, Exchange Tower 33 Wang Chiu Road, Kowloon Bay, HongKong
<b>Manufacturer</b>	Dong Guan Siyoto Electronice Co., Ltd.
<b>Address</b>	He cheng industrial District,Dongjiang Qiaotou Town,DongGuan city Guangdong China
<b>Product Designation</b>	Bluetooth headset
<b>Brand Name</b>	MUVE ACOUSTICS
<b>Test Model</b>	MA-1999
<b>Date of test</b>	Apr.19, 2016 to Apr.21, 2016
<b>Deviation</b>	None
<b>Condition of Test Sample</b>	Normal
<b>Report Template</b>	AGCRT-US-BLE/RF (2013-03-01)

We hereby certify that:

The above equipment was tested by Dongguan Precise Testing Service Co., Ltd. The test data, the energy emitted by the sample tested as described in this report is in compliance with the requirements of FCC Rules Part 15.247.

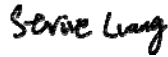
Tested By   
Strive Liang(Liang Faqiang) Jun.03, 2016

Reviewed By   
Forrest Lei(Lei Yonggang) Jun.03, 2016

Approved By   
Solger Zhang(Zhang Hongyi)  
Authorized Officer Jun.03, 2016

## 2.GENERAL INFORMATION

### 2.1PRODUCT DESCRIPTION

The EUT is designed as a “Bluetooth headset”. It is designed by way of utilizing the FHSS technology to achieve the system operation.

A major technical description of EUT is described as following

<b>Operation Frequency</b>	2.402 GHz to 2.480GHz
<b>Bluetooth Version</b>	V4.1
<b>Modulation</b>	GFSK
<b>Number of channels</b>	40 Channel(37 Hopping Channel,3 advertising Channel)
<b>Antenna Designation</b>	PCB Antenna
<b>Antenna Gain</b>	3dBi
<b>Hardware Version</b>	HDV1.0_18_20160324
<b>Software Version</b>	HDV1.0_18_20160324
<b>Power Supply</b>	DC3.7V by Battery
Note: 1. The USB Port can not be used for communication with PC. It's only for charging. 2.The EUT support BLE function 3.The EUT was not active when charging.	

### 2.2 RELATED SUBMITTAL(S)/GRANT(S)

This submittal(s) (test report) is intended for **FCC ID: 2ADM5-MA-1999** filing to comply with Section 15.247of the FCC Part 15, Subpart C Rules.

### 2.3TEST METHODOLOGY

All measurements contained in this report were conducted with ANSI C63.10-2013.

### 2.4 TEST FACILITY

All measurement facilities used to collect the measurement data are located at Dongguan Precise Testing Service Co., Ltd.

Building D,Baoding Technology Park,Guangming Road2,Dongcheng District, Dongguan, Guangdong, China,

### 2.5 SPECIAL ACCESSORIES

Refer to section 2.2.

### 2.6 EQUIPMENT MODIFICATIONS

Not available for this EUT intended for grant.

### 2.7 MEASUREMENT UNCERTAINTY

Radiation Emission:+/-3.2

Conduction Emission:+/-2.5

### 3. SYSTEM TEST CONFIGURATION

#### 3.1 CONFIGURATION OF TESTED SYSTEM

Configure 1: (Normal hopping)



**Configuration:** Continuous TX

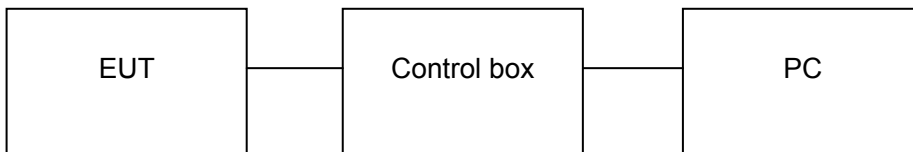

#### 3.2 EQUIPMENT USED IN TESTED SYSTEM

Item	Equipment	Mfr/Brand	Model/Type No.	Remark
1	Bluetooth headset	MUVE ACOUSTICS	MA-1999	EUT
2	PC	Sony	E1412AYCW	A.E
3	Control box	CSR	N/A	A.E
4	Temporary Antenna Connector	T10	N/A	A.E

### 3.3. SUMMARY OF TEST RESULTS

FCC RULES	DESCRIPTION OF TEST	RESULT
§ 15.203	Antenna Requirement	Compliant
§15.209 §15.247(d)	Radiated Emission	Compliant
§15.247(d)	Band Edges	Compliant
§15.247	6 dB Bandwidth	Compliant
§15.247(b)	Conducted Power	Compliant
§15.247(e)	Maximum Conducted Output Power SPECTRAL Density	Compliant
§15.207	Line Conduction Emission	N/A

Note: N/A means it's not applicable to this item.



#### 4. DESCRIPTION OF TEST MODES

The EUT has been operated in one modulation: GFSK .

NO.	TEST MODE DESCRIPTION
1	Low channel GFSK
2	Middle channel GFSK
3	High channel GFSK
4	BT Link

Note:

1. Only the result of the worst case was recorded in the report if no any records.
2. For Radiated Emission, 3axis were chosen for testing for each applicable mode.
3. Transmitting duty cycle >98%, The average correction factor is about -0.18
- 4.The EUT used fully-charged battery when tested.

## **5. ANTENNA REQUIREMENT**

### **5.1. STANDARD APPLICABLE**

According to FCC 15.203, An intentional radiator shall be designed to ensure that no antenna other than that furnished by the responsible party shall be used with the device. The use of a permanently attached antenna or of an antenna that uses a unique coupling to the intentional radiator shall be considered sufficient to comply with the provisions of this Section. The manufacturer may design the unit so that a broken antenna can be replaced by the user, but the use of a standard antenna jack or electrical connector is prohibited. This requirement does not apply to carrier current devices or to devices operated under the provisions of Sections 15.211, 15.213, 15.217, 15.219, or 15.221. Further, this requirement does not apply to intentional radiators that must be professionally installed, such as perimeter protection systems and some field disturbance sensors, or to other intentional radiators which, in accordance with Section 15.31(d), must be measured at the installation site. However, the installer shall be responsible for ensuring that the proper antenna is employed so that the limits in this Part are not exceeded.

### **5.2. TEST RESULT**

This product has a permanent antenna, fulfill the requirement of this section.

## 6. TEST FACILITY

<b>Site</b>	Dongguan Precise Testing Service Co., Ltd.
<b>Location</b>	Building D,Baoding Technology Park,Guangming Road2,Dongcheng District, Dongguan, Guangdong, China,
<b>FCC Registration No.</b>	371540
<b>Description</b>	The test site is constructed and calibrated to meet the FCC requirements in documents ANSI C63.10:2013.

### ALL TEST EQUIPMENT LIST

#### FOR RADIATED EMISSION TEST (BELOW 1GHZ)

Radiated Emission Test Site					
Name of Equipment	Manufacturer	Model Number	Serial Number	Last Calibration	Due Calibration
EMI Test Receiver	Rohde & Schwarz	ESCI	101417	July 4, 2015	July 3, 2016
Trilog Broadband Antenna (25M-1GHz)	SCHWARZBECK	VULB9160	9160-3355	July 4, 2015	July 3, 2016
Signal Amplifier	SCHWARZBECK	BBV 9475	9745-0013	July 4, 2015	July 3, 2016
RF Cable	SCHWARZBECK	AK9515E	96221	July 4, 2015	July 3, 2016
3m Anechoic Chamber	CHENGYU	966	PTS-001	June 6, 2015	June 5, 2016
MULTI-DEVICE Positioning Controller	Max-Full	MF-7802	MF780208339	N/A	N/A
Active loop antenna (9K-30MHz)	Schwarzbeck	FMZB1519	1519-038	June 6, 2015	June 5, 2016
Spectrum analyzer	Agilent	E4407B	MY46185649	June 6, 2015	June 5, 2016

#### FOR RADIATED EMISSION TEST (1GHZ ABOVE)

Radiated Emission Test Site					
Name of Equipment	Manufacturer	Model Number	Serial Number	Last Calibration	Due Calibration
EMI Test Receiver	Rohde & Schwarz	ESCI	101417	July 4, 2015	July 3, 2016
Horn Antenna (1G-18GHz)	SCHWARZBECK	BBHA9120D	9120D-1246	July 11, 2015	July 10, 2016
Spectrum Analyzer	Agilent	E4411B	MY4511453	July 4, 2015	July 3, 2016
Signal Amplifier	SCHWARZBECK	BBV 9718	9718-269	July 7, 2015	July 6, 2016
RF Cable	SCHWARZBECK	AK9515H	96220	July 8, 2015	July 7, 2016
3m Anechoic Chamber	CHENGYU	966	PTS-001	June 6, 2015	June 5, 2016
MULTI-DEVICE Positioning Controller	Max-Full	MF-7802	MF780208339	N/A	N/A
Horn Ant (18G-40GHz)	Schwarzbeck	BBHA 9170	9170-181	June 6, 2015	June 5, 2016

## 7. RADIATED EMISSION

### 7.1 MEASUREMENT PROCEDURE

1. The measuring distance of 3m shall be used for measurements. The EUT was placed on the top of a rotating table 0.8 meter above the ground at a 3 meter semi-anechoic chamber. The table was rotated 360 degrees to determine the position of the highest radiation(below 1GHz)
2. The measuring distance of 3m shall used for measurements. The EUT was placed on the top of a rotating table 1.5 meter above the ground at a 3 meter semi-anechoic chamber. The table was rotated 360 degrees to determine the position of the highest radiation(above 1GHz)
3. The height of the test antenna shall vary between 1m to 4m.Both horizontal and vertical polarization Of the antenna are set to make the measurement.
4. The initial step in collecting radiated emission data is a receive peak detector mode. Pre-scanning the measurement frequency range. Significant peaks are then marked and then Quasi Peak detector mode re-measured.
5. All readings are peak unless otherwise stated QP in column of Note. Peak denoted that the Peak reading compliance with the QP limits and then QP Mode measurement didn't perform(Below 1GHz)
6. All readings are Peak mode value unless otherwise stated AVG in column of Note. If the Peak mode measured value compliance with the Peak limits and lower than AVG Limits, the EUT shall be deemed to meet Peak&AVG limits and then only Peak mode was measured, but AVG mode didn't perform.(above 1GHz)

## 7.2 TEST SETUP

### Radiated Emission Test-Setup Frequency Below 30MHz

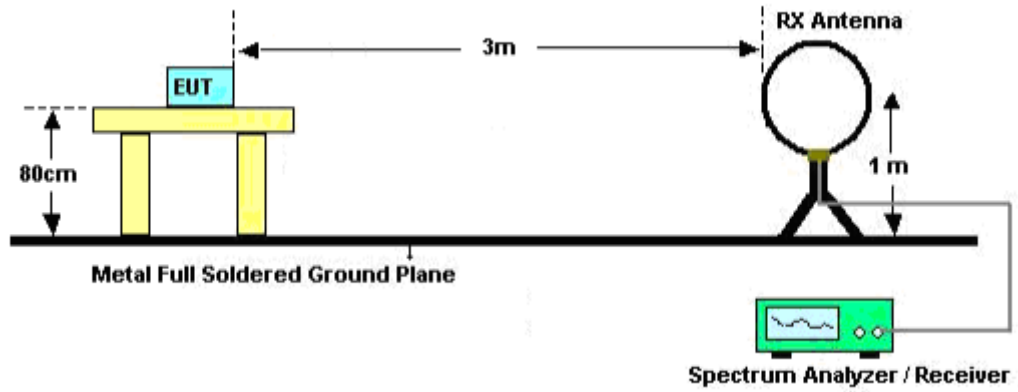

### RADIATED EMISSION TEST SETUP 30MHz-1000MHz

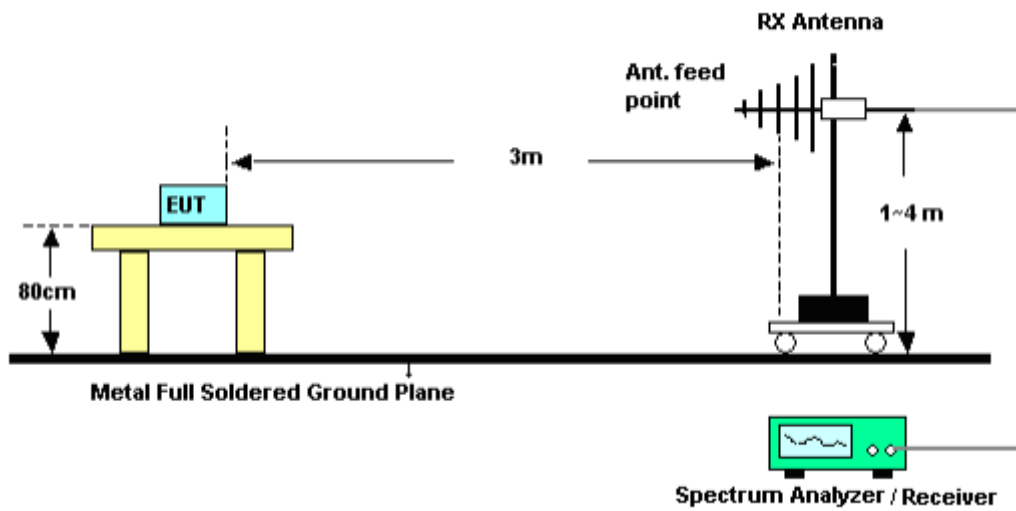

RADIATED EMISSION TEST SETUP ABOVE 1000MHz

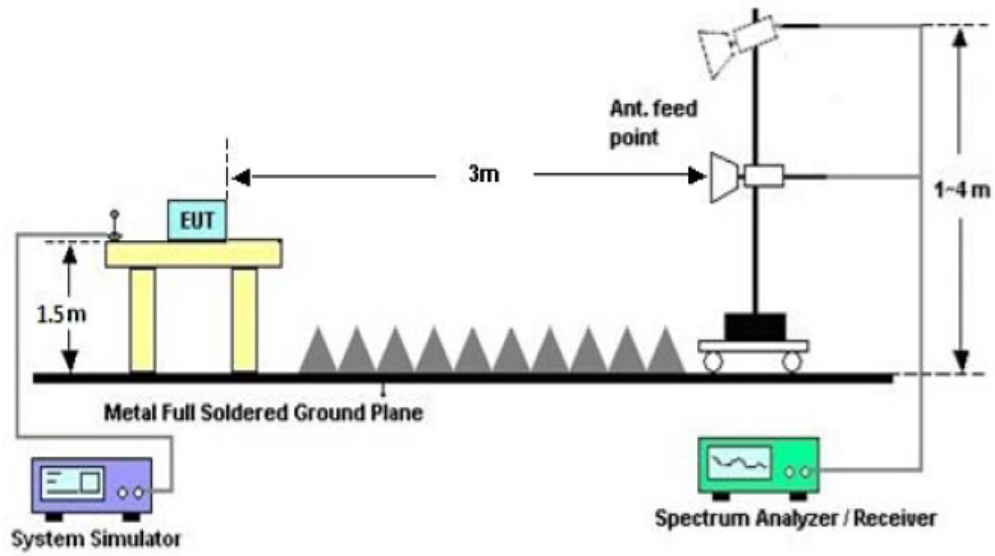

**7.3 LIMITS AND MEASUREMENT RESULT**

15.209 Limit in the below table has to be followed

<b>Frequencies (MHz)</b>	<b>Field Strength (micorvolts/meter)</b>	<b>Measurement Distance (meters)</b>
0.009~0.490	2400/F(KHz)	300
0.490~1.705	24000/F(KHz)	30
1.705~30.0	30	30
30~88	100	3
88~216	150	3
216~960	200	3
Above 960	500	3

Note: All modes were tested For restricted band radiated emission,  
the test records reported below are the worst result compared to other modes.

**7.4 TEST RESULT (Worst Modulation: GFSK)**

**RADIATED EMISSION BELOW 30MHZ**

No emission found between lowest internal used/generated frequencies to 30MHz.

**RADIATED EMISSION BELOW 1GHZ**

RADIATED EMISSION TEST- (30MHZ-1GHZ)-LOW CHANNEL-HORIZONTAL

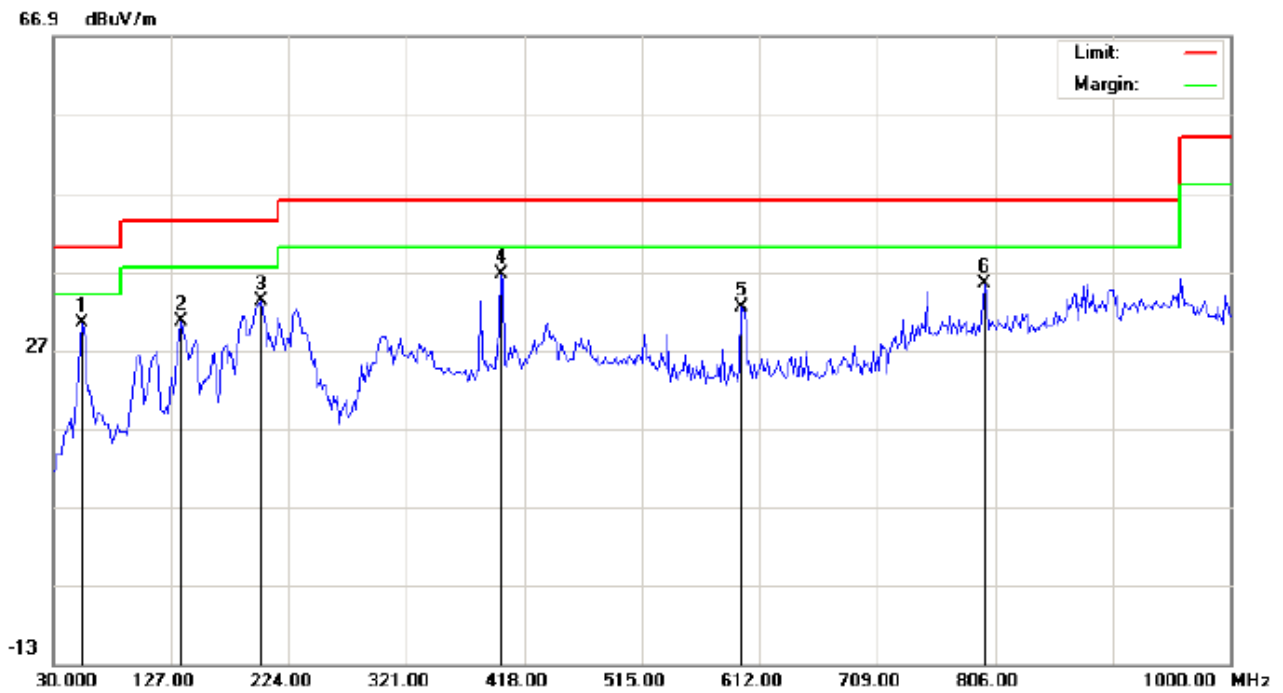

Site: site #1	Polarization: <i>Horizontal</i>	Temperature: 23.4
Limit: FCC Class B 3M Radiation	Power:	Humidity: 56.4 %
EUT:Bluetooth headset	Distance:	
M/N: MA-1999		
Mode:Low Channel TX		
Note:		

No.	Mk	Freq.	Reading	Factor	Measurement	Limit	Over	Detector	Antenna Height	Table Degree	Comment
		MHz	dBuV	dB/m	dBuV/m	dBuV/m	dB		cm	degree	
1		54.2500	23.63	6.68	30.31	40.00	-9.69	peak			
2		135.0833	17.65	12.90	30.55	43.50	-12.95	peak			
3		201.3667	21.33	11.86	33.19	43.50	-10.31	peak			
4	*	398.6000	17.52	19.06	36.58	46.00	-9.42	peak			
5		597.4500	8.68	23.67	32.35	46.00	-13.65	peak			
6		797.9166	8.03	27.29	35.32	46.00	-10.68	peak			

**RESULT: PASS**



RADIATED EMISSION TEST- (30MHZ-1GHZ)-LOW CHANNEL -VERTICAL

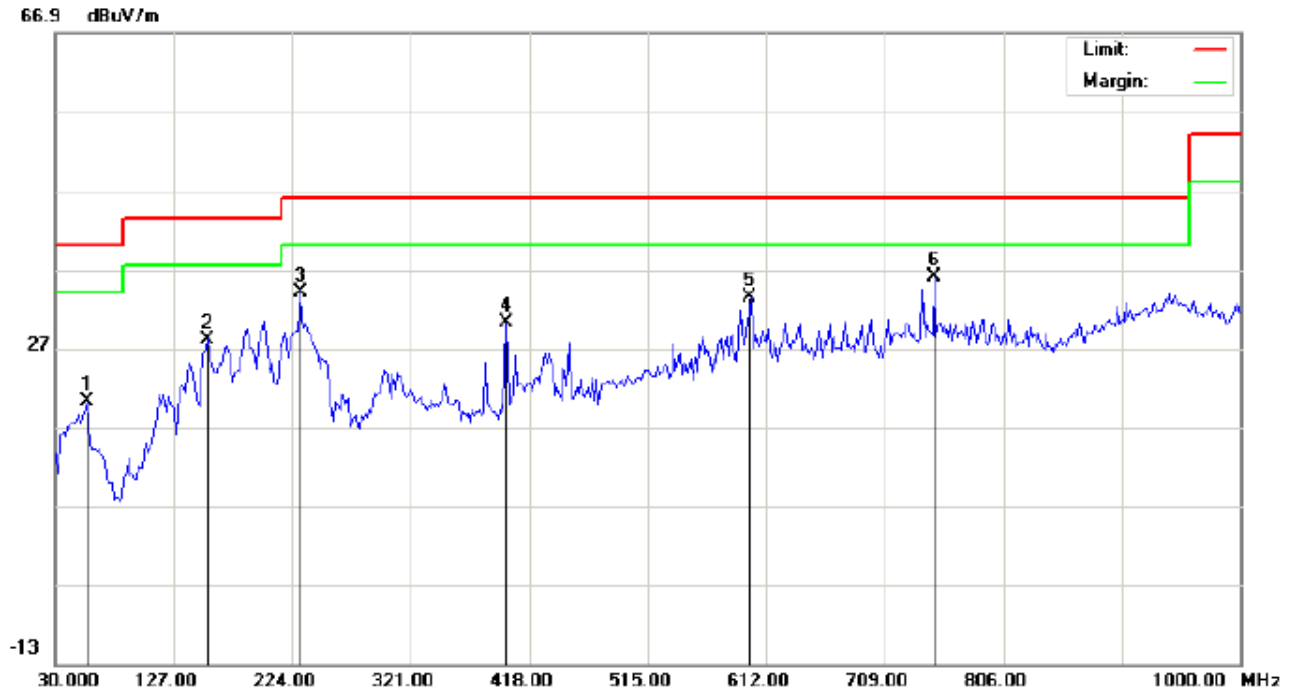

Site: site #1  
 Limit: FCC Class B 3M Radiation  
 EUT: Bluetooth headset  
 M/N: MA-1999  
 Mode: Low Channel TX  
 Note:

Polarization: **Vertical**  
 Power:  
 Distance:

Temperature: 23.4  
 Humidity: 56.4 %

No.	Mk	Freq.	Reading	Factor	Measurement	Limit	Over	Detector	Antenna Height	Table Degree	Comment
		MHz	dBuV	dB/m	dBuV/m	dBuV/m	dB		cm	degree	
1		55.8667	11.98	8.19	20.17	40.00	-19.83	peak			
2		154.4833	12.81	15.29	28.10	43.50	-15.40	peak			
3		230.4667	22.02	11.99	34.01	46.00	-11.99	peak			
4		398.6000	11.15	19.06	30.21	46.00	-15.79	peak			
5		599.0665	10.71	22.73	33.44	46.00	-12.56	peak			
6	*	749.4166	9.47	26.61	36.08	46.00	-9.92	peak			

**RESULT: PASS**

**Note:** 1. Factor=Antenna Factor + Cable loss, Margin=Measurement-Limit.

2. The "Factor" value can be calculated automatically by software of measurement system.

RADIATED EMISSION TEST- (30MHZ-1GHZ)-MIDDLE CHANNEL-HORIZONTAL

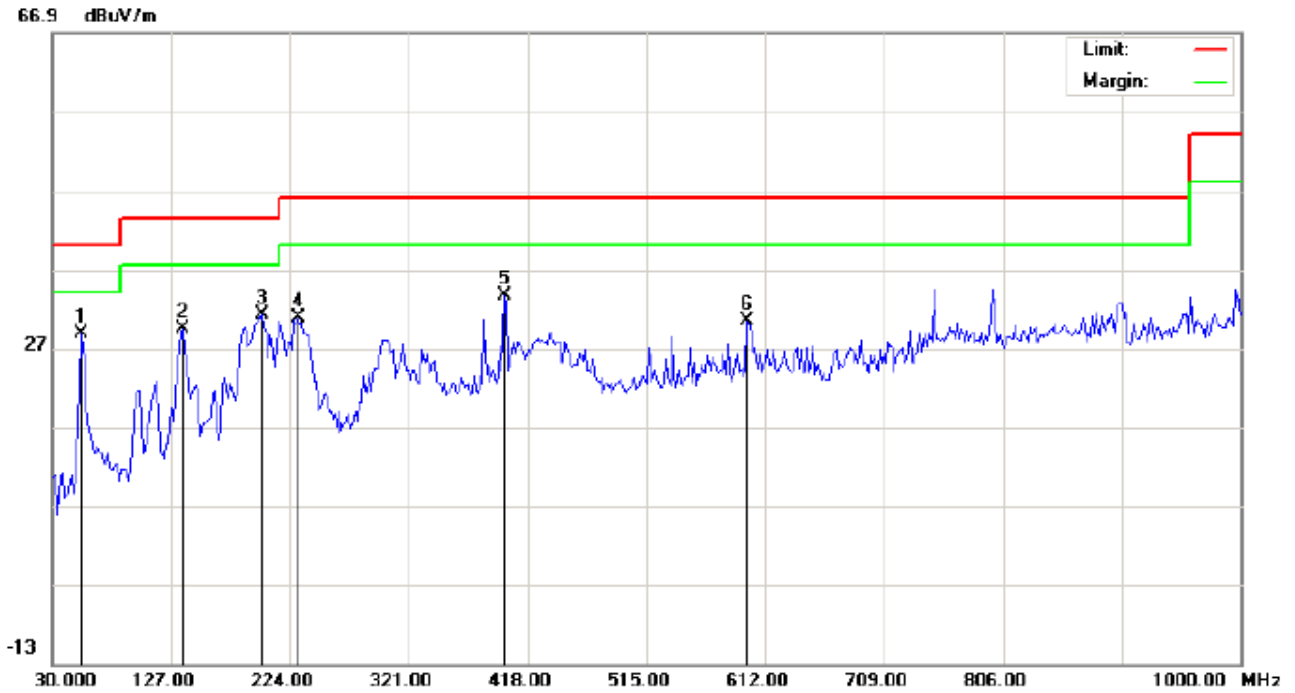

Site: site #1  
Limit: FCC Class B 3M Radiation  
EUT:Bluetooth headset  
M/N: MA-1999  
Mode:Middle Channel TX  
Note:

Polarization: *Horizontal*  
Power:  
Distance:

Temperature: 23.4  
Humidity: 56.4 %

No.	Mk	Freq.	Reading	Factor	Measurement	Limit	Over	Detector	Antenna	Table	Comment
		MHz	dBuV	dB/m	dBuV/m	dBuV/m	dB		Height	Degree	
									cm	degree	
1	*	54.2500	22.13	6.68	28.81	40.00	-11.19	peak			
2		136.6999	15.74	13.66	29.40	43.50	-14.10	peak			
3		201.3667	19.33	11.86	31.19	43.50	-12.31	peak			
4		230.4667	21.83	8.89	30.72	46.00	-15.28	peak			
5		398.6000	14.52	19.06	33.58	46.00	-12.42	peak			
6		597.4500	6.68	23.67	30.35	46.00	-15.65	peak			

**RESULT: PASS**

RADIATED EMISSION TEST- (30MHZ-1GHZ)- MIDDLE CHANNEL -VERTICAL

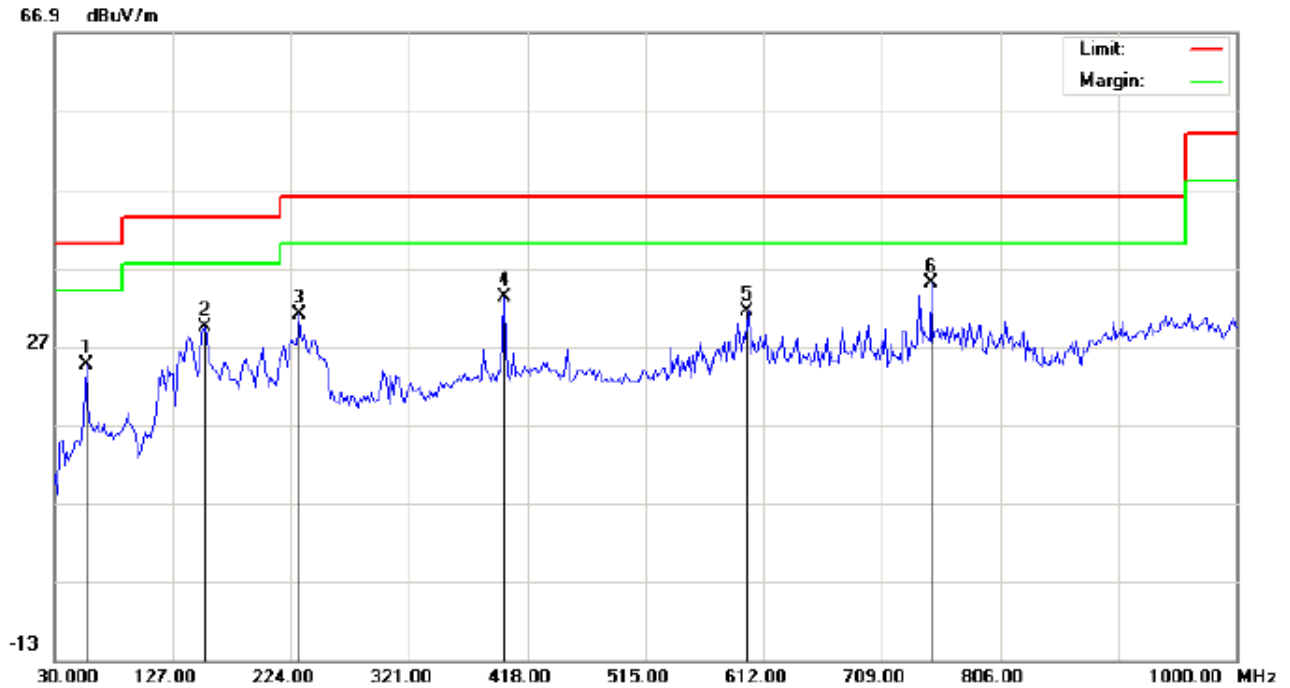

Site: site #1  
Limit: FCC Class B 3M Radiation  
EUT:Bluetooth headset  
M/N: MA-1999  
Mode:Middle Channel TX  
Note:

Polarization: *Vertical*  
Power:  
Distance:

Temperature: 23.4  
Humidity: 56.4 %

No.	Mk	Freq.	Reading	Factor	Measurement	Limit	Over	Detector	Antenna Height	Table Degree	Comment
		MHz	dBuV	dB/m	dBuV/m	dBuV/m	dB		cm	degree	
1		55.8667	16.48	8.19	24.67	40.00	-15.33	peak			
2		152.8667	14.07	15.28	29.35	43.50	-14.15	peak			
3		230.4667	19.02	11.99	31.01	46.00	-14.99	peak			
4		398.6000	14.15	19.06	33.21	46.00	-12.79	peak			
5		599.0665	8.71	22.73	31.44	46.00	-14.56	peak			
6	*	749.4166	8.47	26.61	35.08	46.00	-10.92	peak			

**RESULT: PASS**

**Note:** 1. Factor=Antenna Factor + Cable loss, Margin=Measurement-Limit.

2. The "Factor" value can be calculated automatically by software of measurement system.

RADIATED EMISSION TEST- (30MHZ-1GHZ)-HIGH CHANNEL-HORIZONTAL

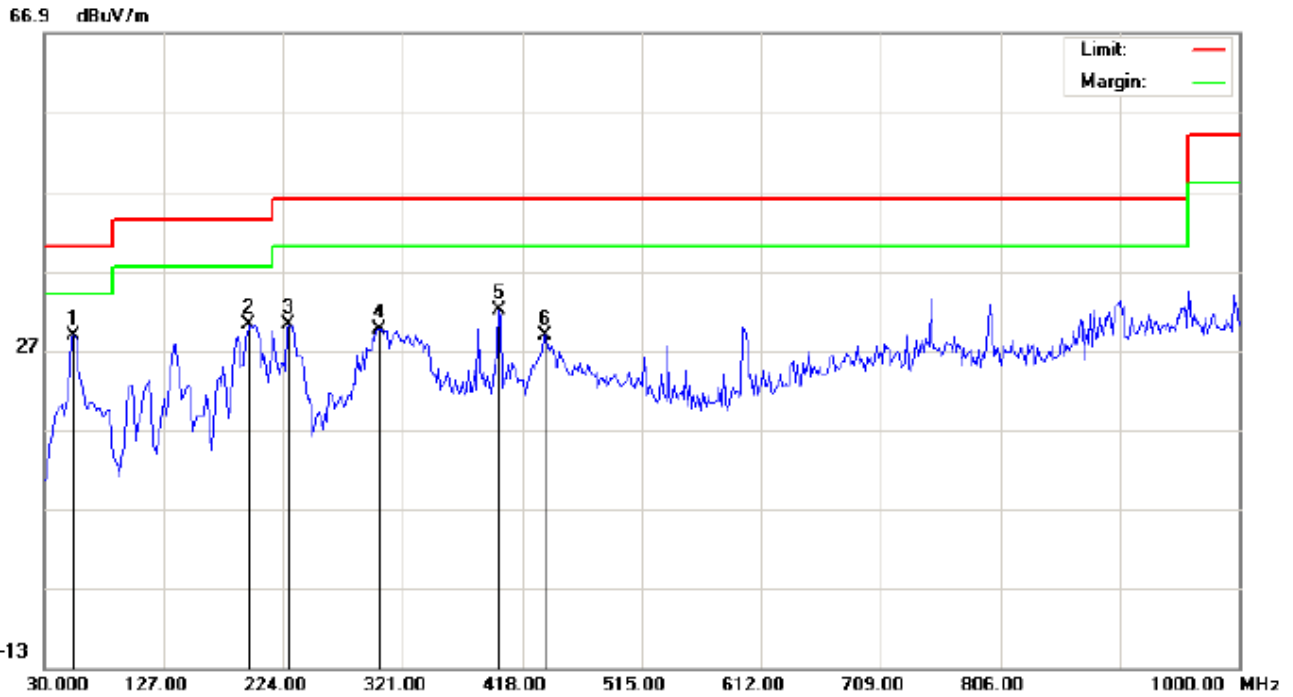

Site: site #1  
Limit: FCC Class B 3M Radiation  
EUT:Bluetooth headset  
M/N: MA-1999  
Mode:High Channel TX  
Note:

Polarization: *Horizontal*  
Power:  
Distance:

Temperature: 23.4  
Humidity: 56.4 %

No.	Mk	Freq.	Reading	Factor	Measurement	Limit	Over	Detector	Antenna Height	Table Degree	Comment
		MHz	dBuV	dB/m	dBuV/m	dBuV/m	dB		cm	degree	
1	*	54.2500	22.13	6.68	28.81	40.00	-11.19	peak			
2		196.5166	18.36	11.84	30.20	43.50	-13.30	peak			
3		228.8499	21.19	9.06	30.25	46.00	-15.75	peak			
4		301.6000	14.08	15.52	29.60	46.00	-16.40	peak			
5		398.6000	13.02	19.06	32.08	46.00	-13.92	peak			
6		437.3999	8.61	20.21	28.82	46.00	-17.18	peak			

**RESULT: PASS**

RADIATED EMISSION TEST- (30MHZ-1GHZ)-HIGH CHANNEL -VERTICAL

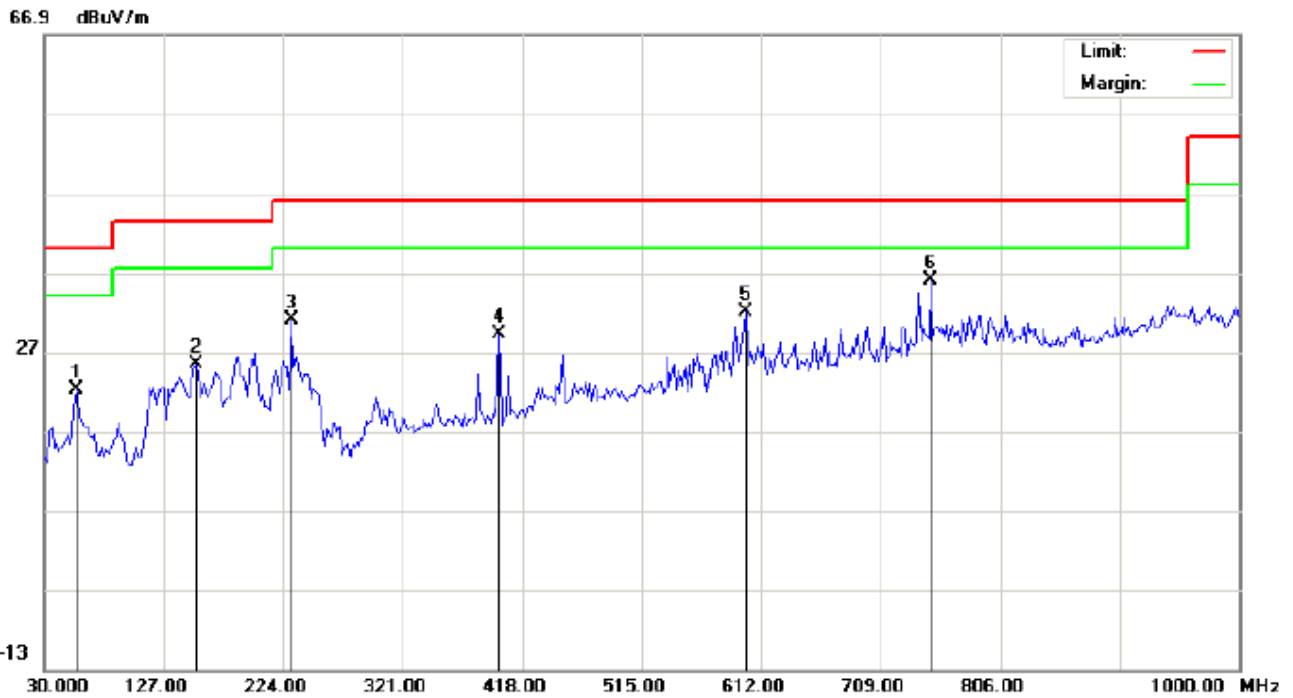

Site: site #1  
Limit: FCC Class B 3M Radiation  
EUT:Bluetooth headset  
M/N: MA-1999  
Mode:High Channel TX  
Note:

Polarization: *Vertical*  
Power:  
Distance:

Temperature: 23.4  
Humidity: 56.4 %

No.	Mk	Freq.	Reading	Factor	Measurement	Limit	Over	Detector	Antenna Height	Table Degree	Comment
		MHz	dBuV	dB/m	dBuV/m	dBuV/m	dB		cm	degree	
1		55.8667	13.98	8.19	22.17	40.00	-17.83	peak			
2		152.8667	10.07	15.28	25.35	43.50	-18.15	peak			
3		230.4667	19.02	11.99	31.01	46.00	-14.99	peak			
4		398.6000	10.15	19.06	29.21	46.00	-16.79	peak			
5		599.0667	9.21	22.73	31.94	46.00	-14.06	peak			
6	*	749.4167	9.47	26.61	36.08	46.00	-9.92	peak			

**RESULT: PASS**

**Note:** 1. Factor=Antenna Factor + Cable loss, Margin=Measurement-Limit.  
2. The "Factor" value can be calculated automatically by software of measurement system.

**RADIATED EMISSION ABOVE 1GHZ**

**RADIATED EMISSION TEST- (ABOVE 1GHZ)-LOW CHANNEL-HORIZONTAL**

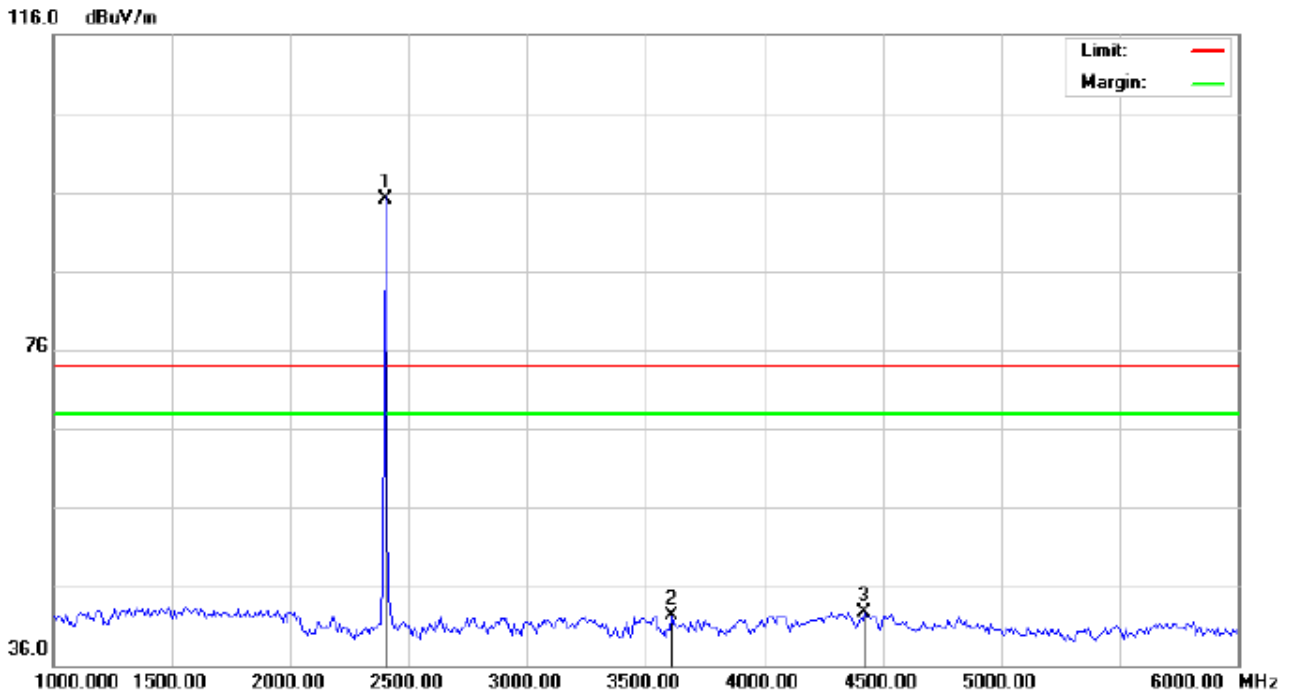

Site: Conduction Polarization: *Horizontal* Temperature: 26  
 Limit: FCC Class B 3M Radiation above 1GHZ(PK) Power: Humidity: 60 %  
 EUT:Bluetooth headset Distance:  
 M/N: MA-1999  
 Mode: Low Channel TX  
 Note:

No.	Mk	Freq.	Reading	Factor	Measurement	Limit	Over	Detector	Antenna Height	Table Degree	Comment
		MHz	dBuV	dBuV/m	dBuV/m	dBuV/m	dB		cm	degree	
1	*	2402.000	84.81	10.32	95.13	74.00	21.13	peak			
2		3608.333	29.50	12.78	42.28	74.00	-31.72	peak			
3		4425.000	34.54	8.13	42.67	74.00	-31.33	peak			

**RESULT: PASS**

RADIATED EMISSION TEST-(ABOVE 1GHZ)-LOW CHANNEL-VERTICAL

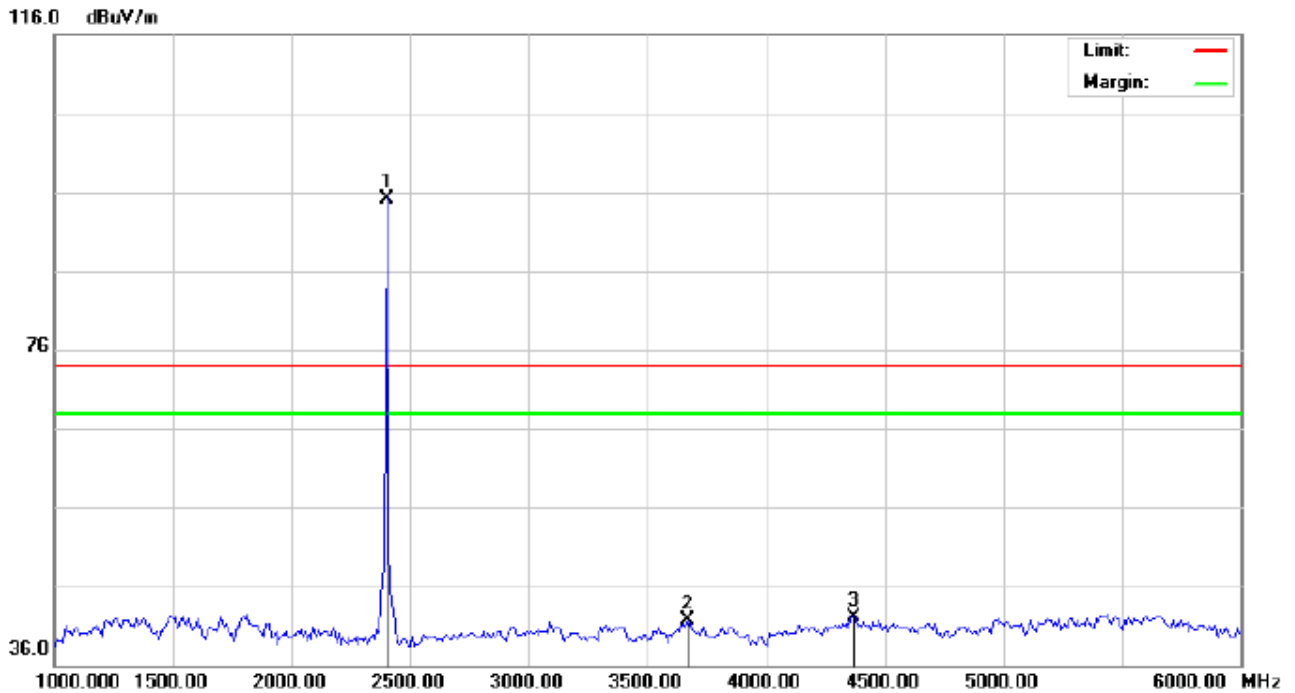

Site: Conduction Polarization: *Vertical* Temperature: 26  
 Limit: FCC Class B 3M Radiation above 1GHZ(PK) Power: Humidity: 60 %  
 EUT:Bluetooth headset Distance:  
 M/N: MA-1999  
 Mode: Low Channel TX  
 Note:

No.	Mk	Freq.	Reading	Factor	Measurement	Limit	Over	Detector	Antenna Height	Table Degree	Comment
		MHz	dBuV	dBuV/m	dBuV/m	dBuV/m	dB		cm	degree	
1	*	2402.000	84.87	10.32	95.19	74.00	21.19	peak			
2		3666.667	28.61	13.14	41.75	74.00	-32.25	peak			
3		4366.667	33.08	9.10	42.18	74.00	-31.82	peak			

**RESULT: PASS**

**Note:** 1. Factor=Antenna Factor + Cable loss, Margin=Measurement-Limit.

2. The "Factor" value can be calculated automatically by software of measurement system.

RADIATED EMISSION TEST-(ABOVE 1GHZ)-MIDDLE CHANNEL-HORIZONTAL

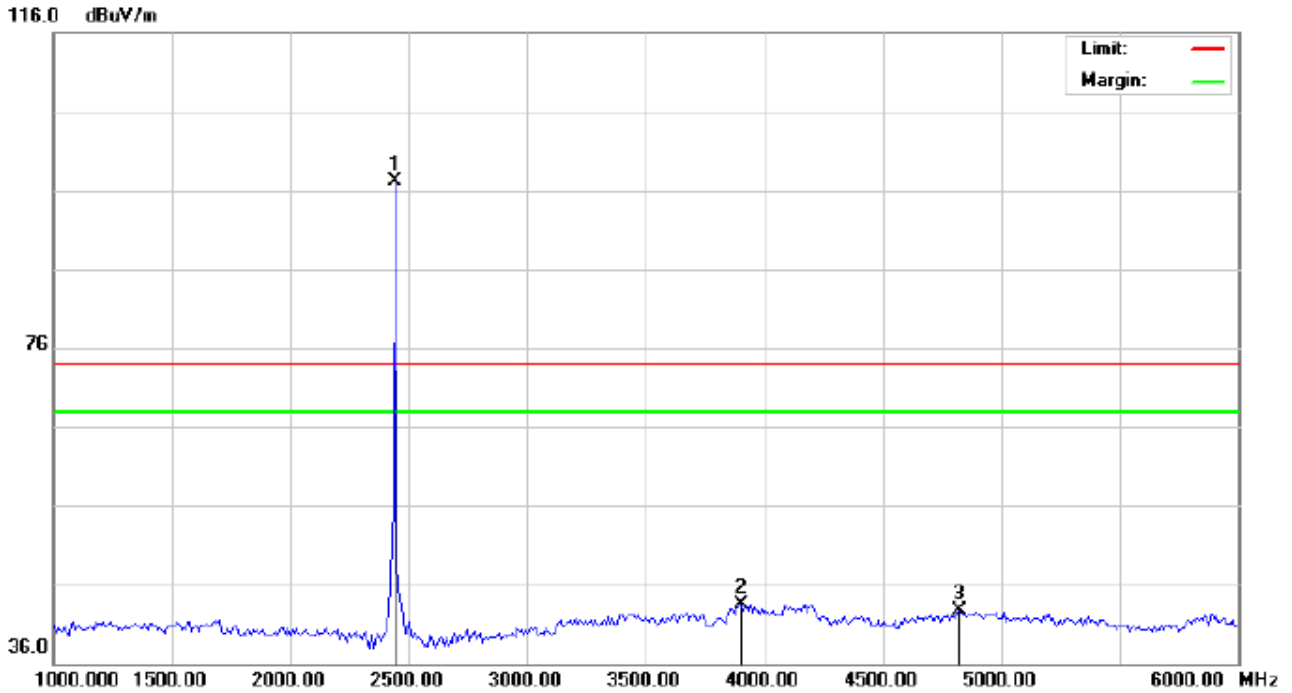

Site: Conduction Polarization: *Horizontal* Temperature: 26  
Limit: FCC Class B 3M Radiation above 1GHZ(PK) Power: Humidity: 60 %  
EUT:Bluetooth headset Distance:  
M/N: MA-1999  
Mode: Middle Channel TX  
Note:

No.	Mk	Freq.	Reading	Factor	Measurement	Limit	Over	Detector	Antenna Height	Table Degree	Comment
		MHz	dBuV	dBuV/m	dBuV/m	dBuV/m	dB		cm	degree	
1	*	2440.000	86.83	10.36	97.19	74.00	23.19	peak			
2		3900.000	28.87	14.57	43.44	74.00	-30.56	peak			
3		4825.000	34.94	7.74	42.68	74.00	-31.32	peak			

**RESULT: PASS**



RADIATED EMISSION TEST-(ABOVE 1GHZ)-MIDDLE CHANNEL-VERTICAL

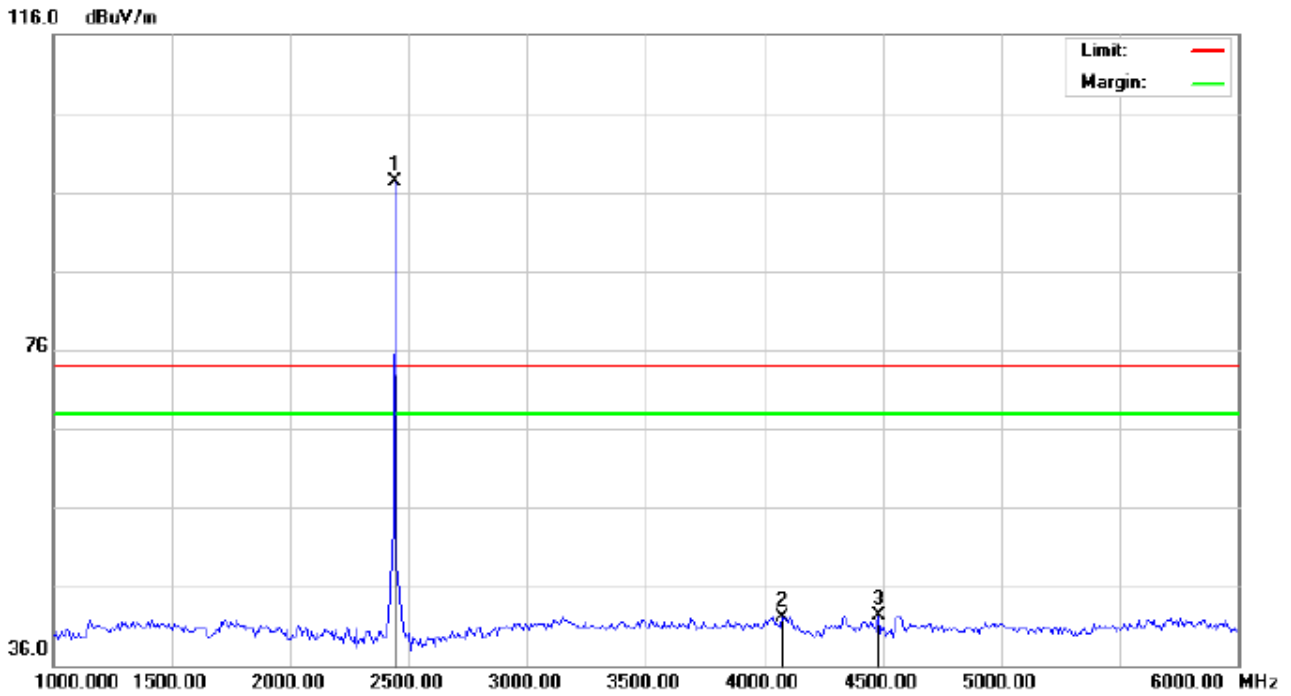

Site: Conduction Polarization: *Vertical* Temperature: 26  
 Limit: FCC Class B 3M Radiation above 1GHZ(PK) Power: Humidity: 60 %  
 EUT:Bluetooth headset Distance:  
 M/N: MA-1999  
 Mode: Middle Channel TX  
 Note:

No.	Mk	Freq.	Reading	Factor	Measurement	Limit	Over	Detector	Antenna Height	Table Degree	Comment
		MHz	dBuV	dBuV/m	dBuV/m	dBuV/m	dB		cm	degree	
1	*	2440.000	86.89	10.36	97.25	74.00	23.25	peak			
2		4075.000	28.22	13.94	42.16	74.00	-31.84	peak			
3		4483.333	35.15	7.17	42.32	74.00	-31.68	peak			

**RESULT: PASS**

**Note:** 1. Factor=Antenna Factor + Cable loss, Margin=Measurement-Limit.  
 2. The "Factor" value can be calculated automatically by software of measurement system.

RADIATED EMISSION TEST-(ABOVE 1GHZ)-HIGH CHANNEL-HORIZONTAL

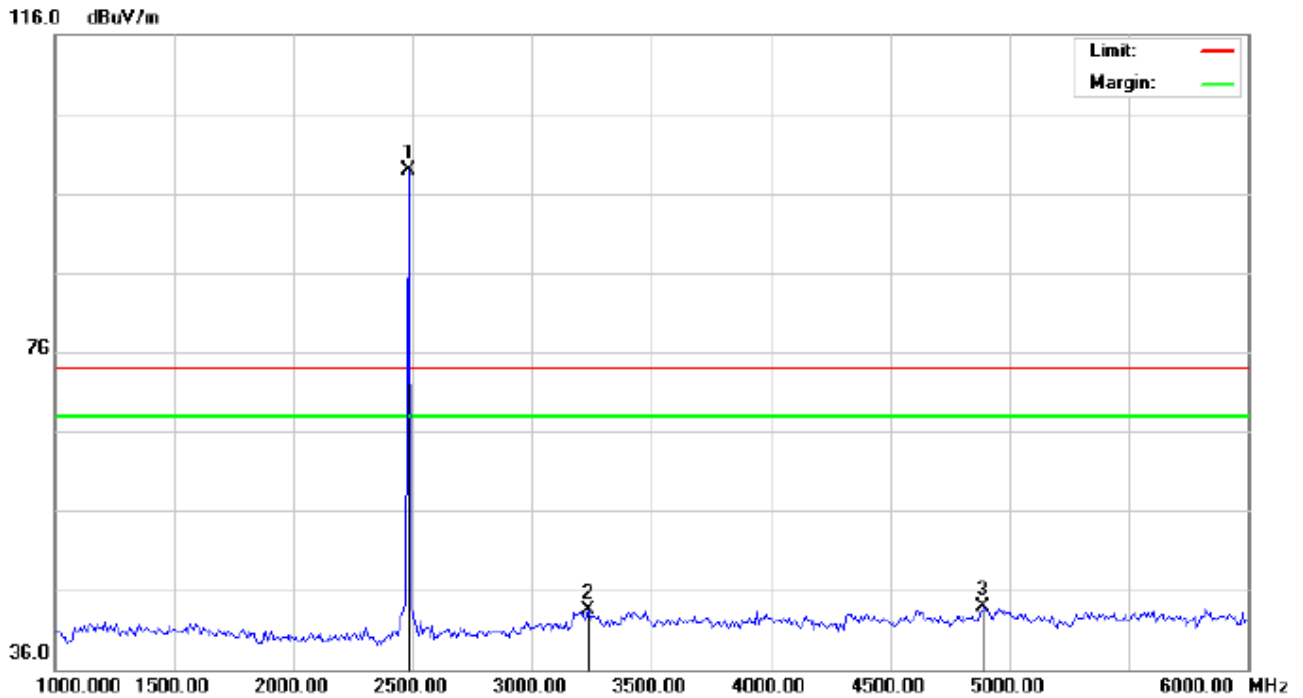

Site: Conduction Polarization: *Horizontal* Temperature: 26  
Limit: FCC Class B 3M Radiation above 1GHZ(PK) Power: Humidity: 60 %  
EUT:Bluetooth headset Distance:  
M/N: MA-1999  
Mode: High Channel TX  
Note:

No.	Mk	Freq.	Reading	Factor	Measurement	Limit	Over	Detector	Antenna Height	Table Degree	Comment
		MHz	dBuV	dBuV/m	dBuV/m	dBuV/m	dB		cm	degree	
1	*	2480.000	88.43	10.41	98.84	74.00	24.84	peak			
2		3233.333	31.65	11.86	43.51	74.00	-30.49	peak			
3		4891.667	36.02	7.92	43.94	74.00	-30.06	peak			

**RESULT: PASS**

RADIATED EMISSION TEST-(ABOVE 1GHZ)-HIGH CHANNEL-VERTICAL

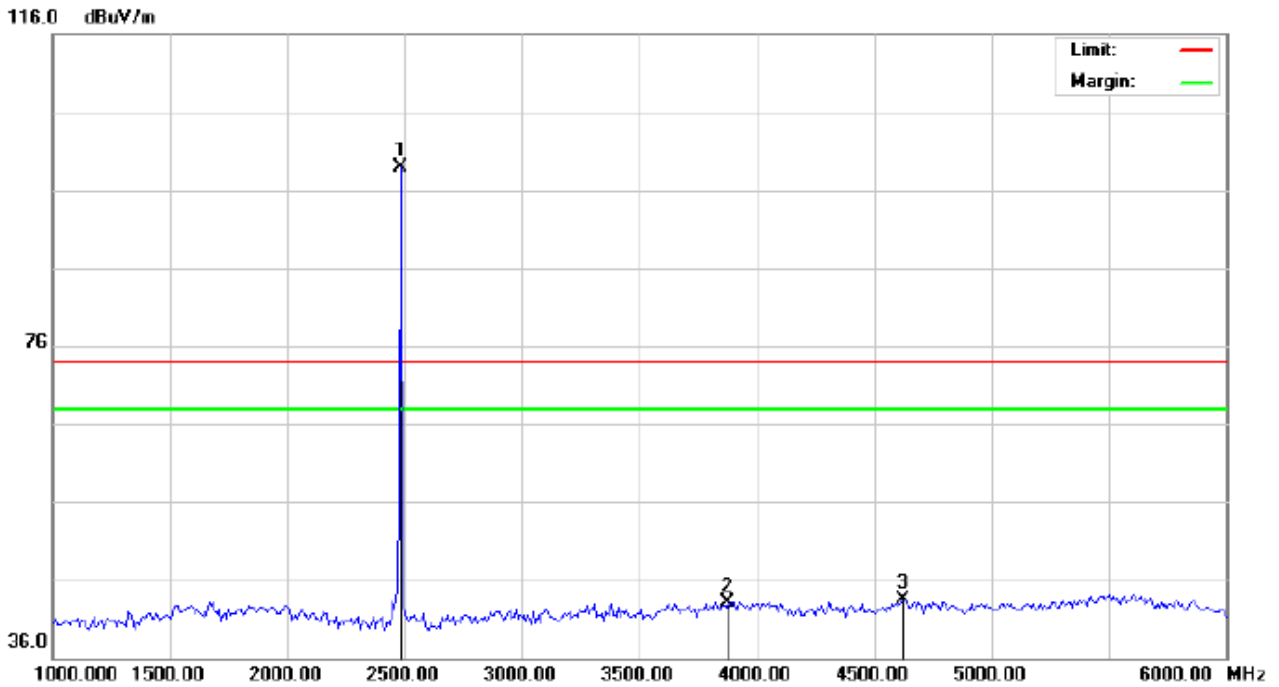

Site: Conduction Polarization: *Vertical* Temperature: 26  
 Limit: FCC Class B 3M Radiation above 1GHZ(PK) Power: Humidity: 60 %  
 EUT:Bluetooth headset Distance:  
 M/N:MA-1999  
 Mode:High Channel TX  
 Note:

No.	Mk	Freq.	Reading	Factor	Measurement	Limit	Over	Detector	Antenna Height	Table Degree	Comment
		MHz	dBuV	dBuV/m	dBuV/m	dBuV/m	dB		cm	degree	
1	*	2480.000	88.47	10.41	98.88	74.00	24.88	peak			
2		3875.000	28.73	14.42	43.15	74.00	-30.85	peak			
3		4625.000	36.24	7.22	43.46	74.00	-30.54	peak			

**RESULT: PASS**

**Note:** 6~25GHz at least have 20dB margin. No recording in the test report.

Factor=Antenna Factor+ Cable loss-Amplifier gain,

Margin=Measurement-Limit.

The "Factor" value can be calculated automatically by software of measurement system.

## 8. BAND EDGE EMISSION

### 8.1. MEASUREMENT PROCEDURE

1. Set the EUT Work on the top, the bottom operation frequency individually.
2. Set SPA Start or Stop Frequency=Operation Frequency,  $RBW \geq 100\text{kHz}$ ,  $VBW \geq 3 \cdot RBW$ ,  
Center frequency =Operation frequency
3. The band edges was measured and recorded.

### 8.2. TEST SET-UP

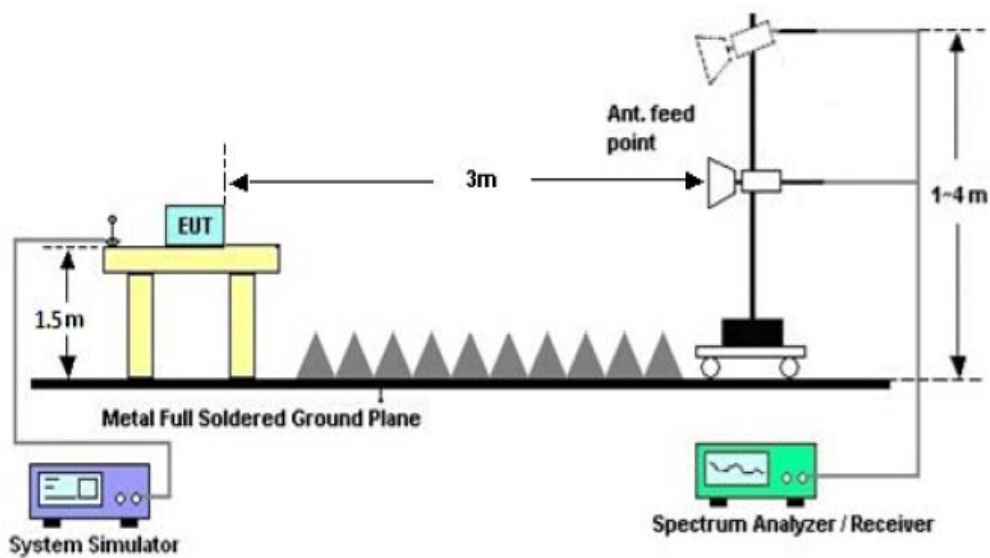

### 8.3. TEST RESULT

TEST PLOT OF BAND EDGE FOR LOW CHANNEL -Horizontal

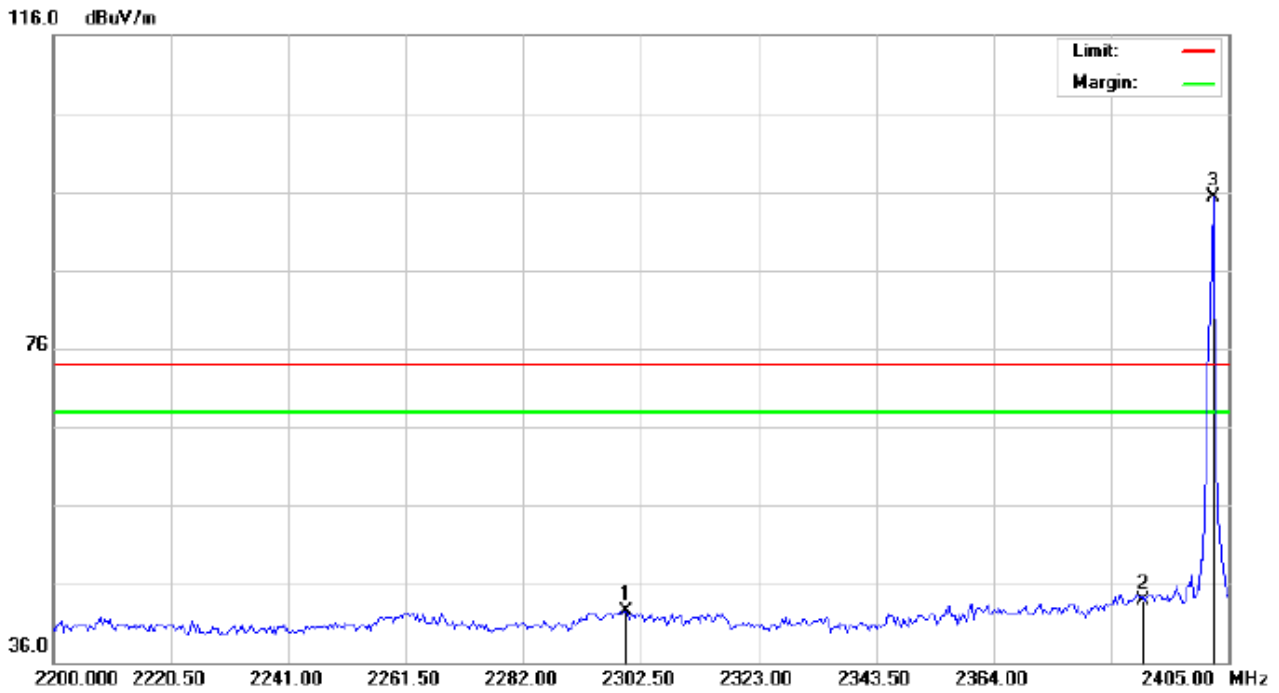

Site: Conduction	Polarization: <i>Horizontal</i>	Temperature: 26
Limit: FCC Class B 3M Radiation above 1GHZ(PK)	Power:	Humidity: 60 %
EUT:Bluetooth headset	Distance:	
M/N: MA-1999		
Mode: Low Channel TX		
Note:		

No.	Mk	Freq.	Reading	Factor	Measurement	Limit	Over	Detector	Antenna Height	Table Degree	Comment
		MHz	dBuV	dBuV/m	dBuV/m	dBuV/m	dB		cm	degree	
1		2299.767	32.30	10.21	42.51	74.00	-31.49	peak			
2		2390.000	33.62	10.31	43.93	74.00	-30.07	peak			
3	*	2402.000	84.91	10.32	95.23	74.00	21.23	peak			

TEST PLOT OF BAND EDGE FOR LOW CHANNEL - Vertical

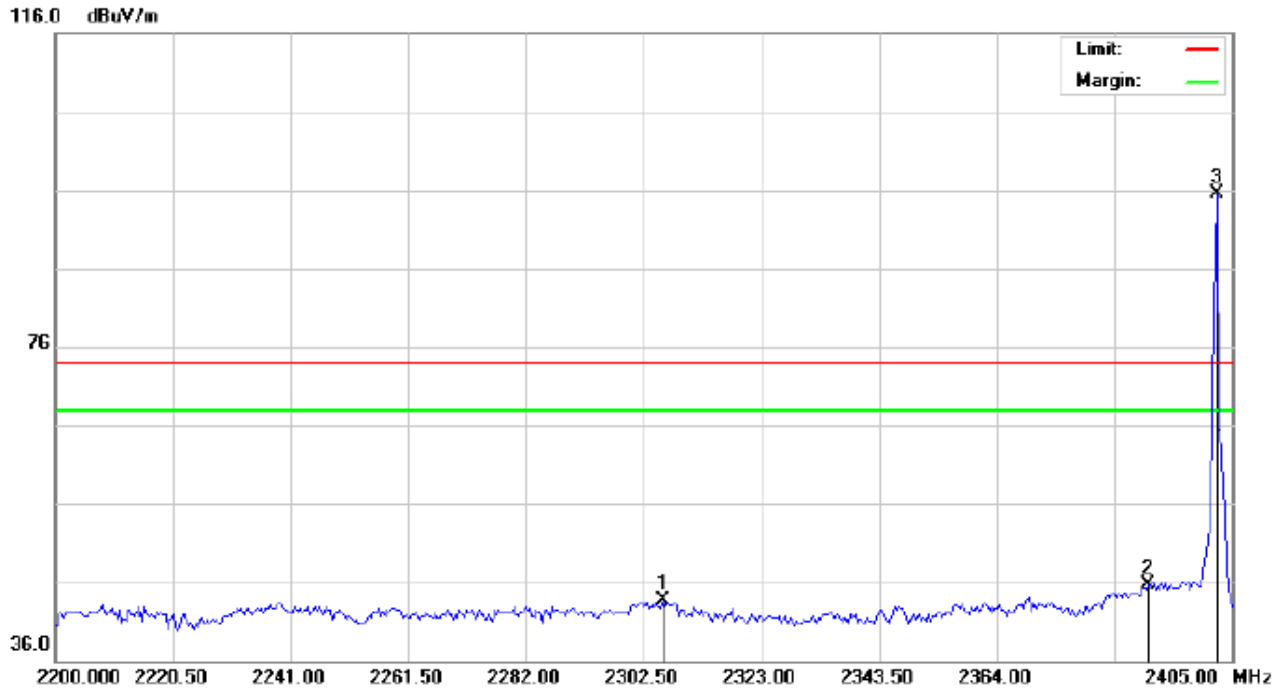

Site: Conduction

Polarization: *Vertical*

Temperature: 26

Limit: FCC Class B 3M Radiation above 1GHZ(PK)

Power:

Humidity: 60 %

EUT:Bluetooth headset

Distance:

M/N: MA-1999

Mode: Low Channel TX

Note:

No.	Mk	Freq.	Reading	Factor	Measurement	Limit	Over	Detector	Antenna Height	Table Degree	Comment
		MHz	dBuV	dBuV/m	dBuV/m	dBuV/m	dB		cm	degree	
1		2305.917	33.41	10.22	43.63	74.00	-30.37	peak			
2		2390.000	35.35	10.31	45.66	74.00	-28.34	peak			
3	*	2402.000	85.26	10.32	95.58	74.00	21.58	peak			

**RESULT: PASS**

TEST PLOT OF BAND EDGE FOR HIGH CHANNEL –Horizontal

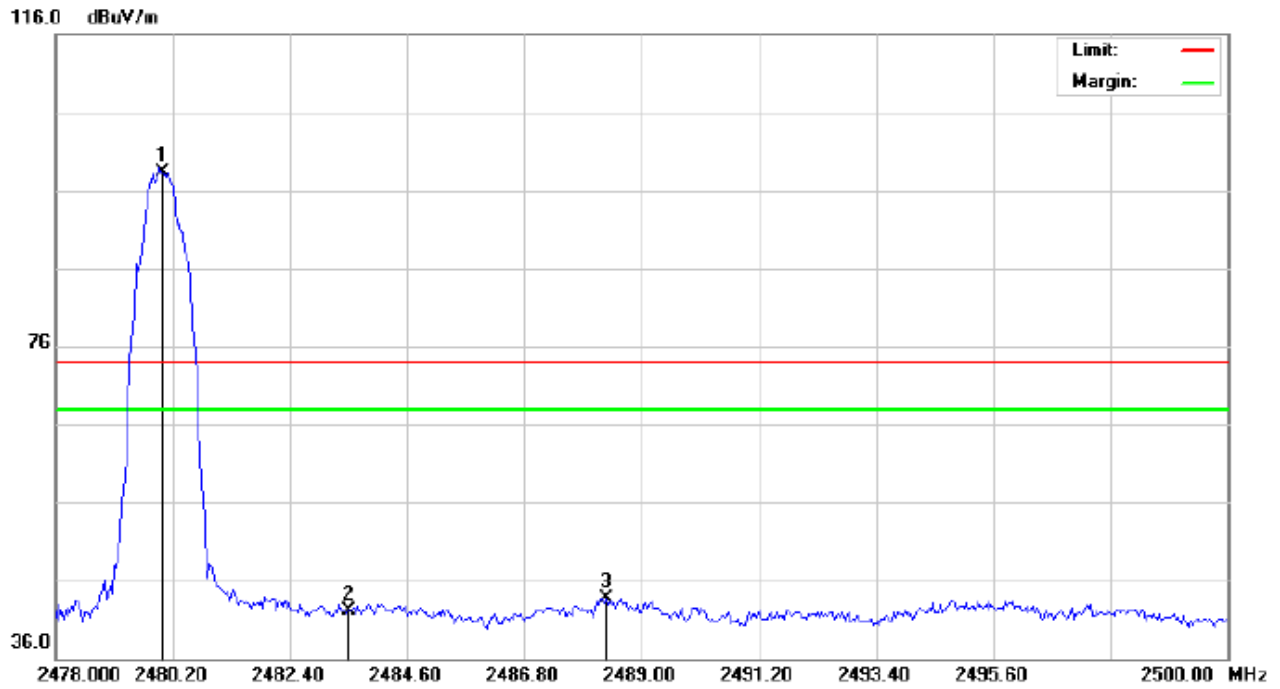

Site: Conduction Polarization: *Horizontal* Temperature: 26  
 Limit: FCC Class B 3M Radiation above 1GHZ(PK) Power: Humidity: 60 %  
 EUT:Bluetooth headset Distance:  
 M/N: MA-1999  
 Mode: High Channel TX  
 Note:

No.	Mk	Freq.	Reading	Factor	Measurement	Limit	Over	Detector	Antenna Height	Table Degree	Comment
		MHz	dBuV	dBuV/m	dBuV/m	dBuV/m	dB		cm	degree	
1	*	2480.000	87.96	10.41	98.37	74.00	24.37	peak			
2		2483.500	31.75	10.41	42.16	74.00	-31.84	peak			
3		2488.340	33.37	10.42	43.79	74.00	-30.21	peak			

TEST PLOT OF BAND EDGE FOR HIGH CHANNEL -Vertical

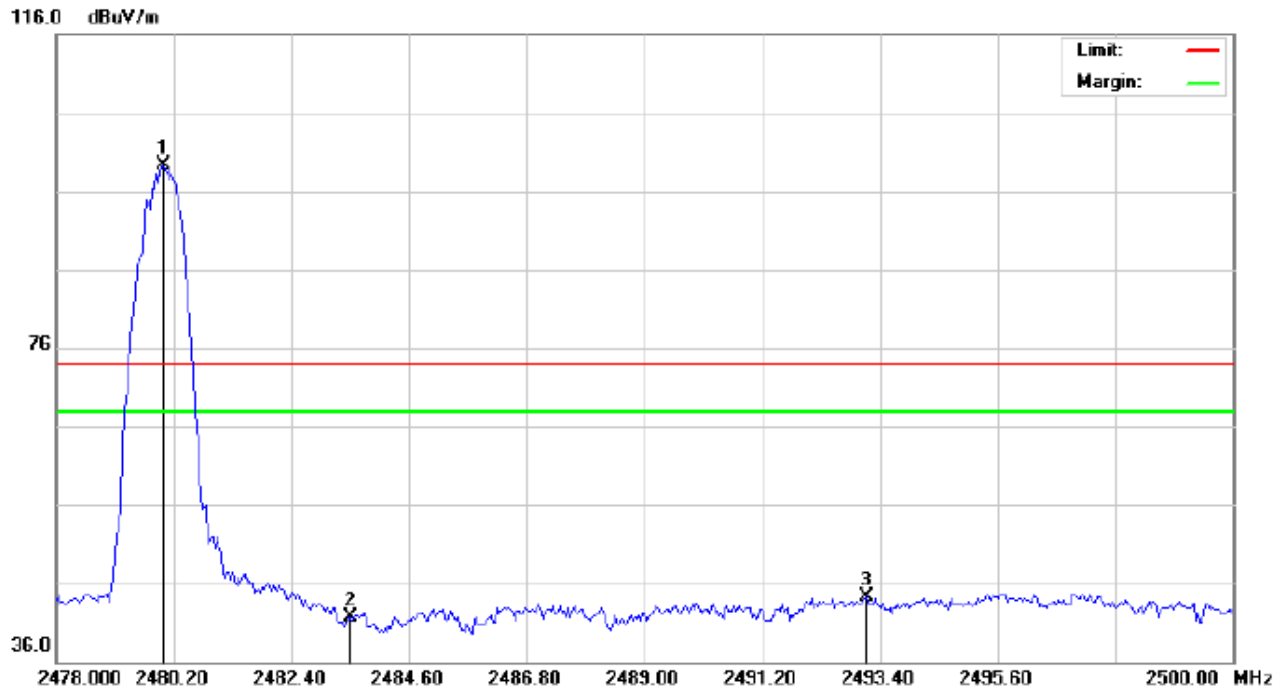

Site: Conduction	Polarization: <i>Vertical</i>	Temperature: 26
Limit: FCC Class B 3M Radiation above 1GHZ(PK)	Power:	Humidity: 60 %
EUT:Bluetooth headset	Distance:	
M/N: MA-1999		
Mode: High Channel TX		
Note:		

No.	Mk	Freq.	Reading	Factor	Measurement	Limit	Over	Detector	Antenna Height	Table Degree	Comment
		MHz	dBuV	dBuV/m	dBuV/m	dBuV/m	dB		cm	degree	
1	*	2480.000	88.85	10.41	99.26	74.00	25.26	peak			
2		2483.500	31.37	10.41	41.78	74.00	-32.22	peak			
3		2493.143	33.85	10.42	44.27	74.00	-29.73	peak			

RESULT: PASS



## 9. 6DB BANDWIDTH

### 9.1. TEST PROCEDURE

1. Connect EUT RF output port to the Spectrum Analyzer through an RF attenuator
2. Set the EUT Work on the top, the middle and the bottom operation frequency individually.
3. Set SPA Centre Frequency = Operation Frequency, RBW= 100 KHz, VBW $\geq$ 3\*RBW.
4. Set SPA Trace 1 Max hold, then View.

### 9.2. SUMMARY OF TEST RESULTS/PLOTS

Channel	6dB Bandwidth (KHz)	Minimum Limit (KHz)	Pass/Fail
Low	0.674	500KHz	Pass
Middle	0.667		Pass
High	0.670		Pass

TEST PLOT OF BANDWIDTH FOR LOW CHANNEL

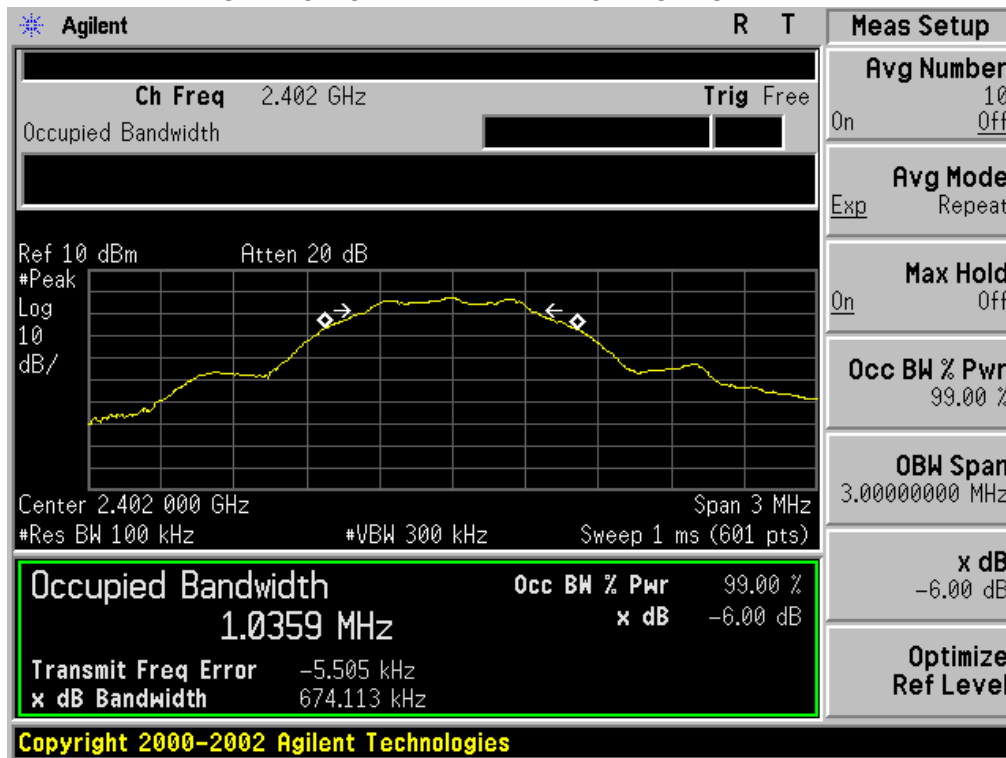

TEST PLOT OF BANDWIDTH FOR MIDDLE CHANNEL

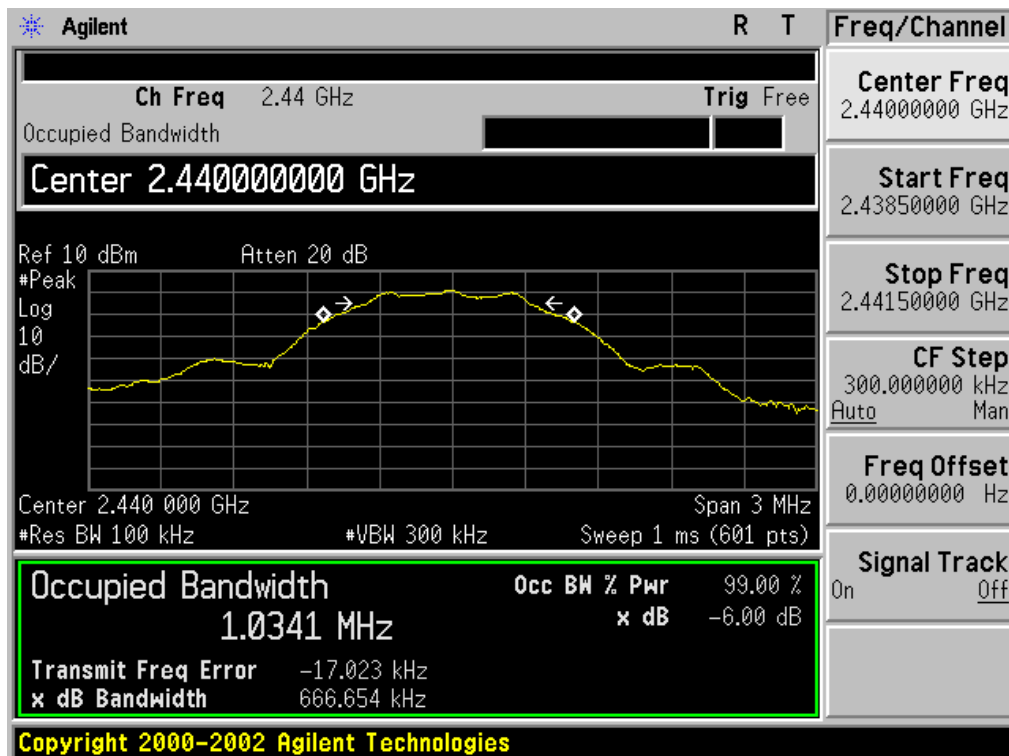

TEST PLOT OF BANDWIDTH FOR HIGH CHANNEL

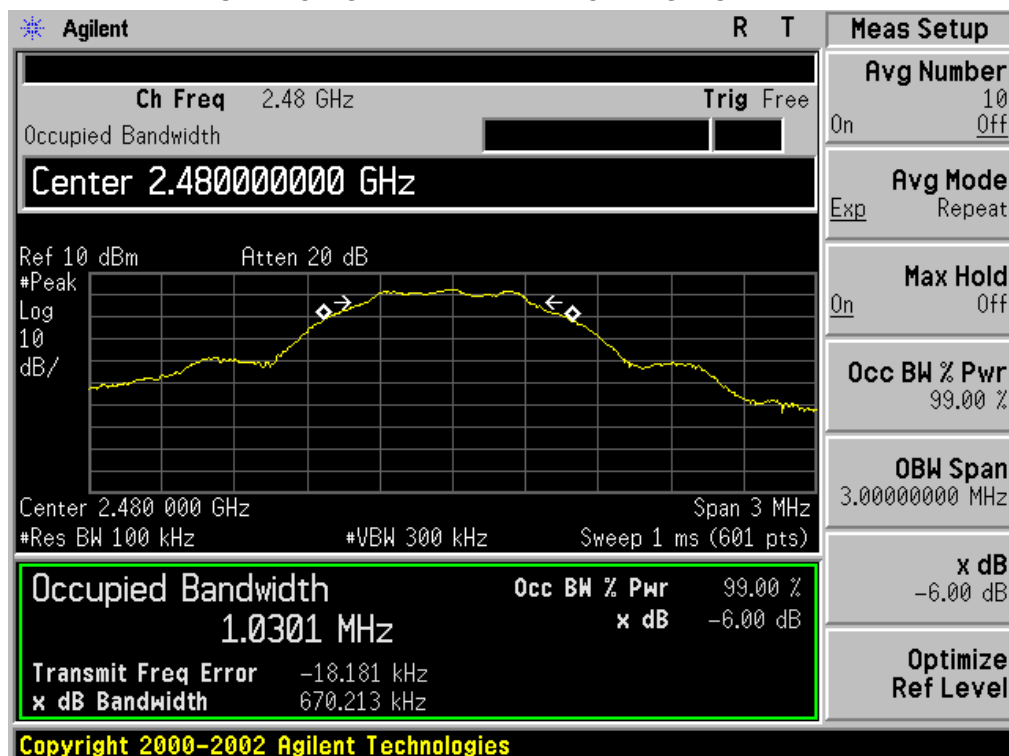

## 10. CONDUCTED OUTPUT POWER

### 10.1. MEASUREMENT PROCEDURE

For peak power test:

1. Connect EUT RF output port to the Spectrum Analyzer through an RF attenuator
2. Set the EUT Work on the top, middle and the bottom operation frequency individually.
3. Use the following spectrum analyzer settings:
  - a) Set the RBW  $\geq$  DTS bandwidth.
  - b) Set VBW  $\geq 3$  RBW.
  - c) Set span  $\geq 3 \times$  RBW
  - d) Sweep time = auto couple.
  - e) Detector = peak.
  - f) Trace mode = max hold.
  - g) Allow trace to fully stabilize.
  - h) Use peak marker function to determine the peak amplitude level.
4. Allow the trace to stabilize.
5. Record the result form the Spectrum Analyzer.

### 10.2. TEST SET-UP (BLOCK DIAGRAM OF CONFIGURATION)

Setup Diagram for Peak Power

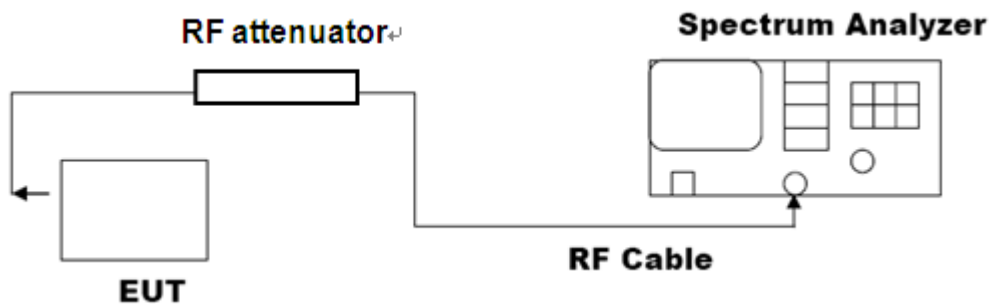

10.3. LIMITS AND MEASUREMENT RESULT

Channel	Peak Power (dBm)	Applicable Limits (dBm)	Pass/Fail
Low Channel	-3.11	30	Pass
Middle Channel	-1.10	30	Pass
High Channel	0.63	30	Pass

The Low Channel Result

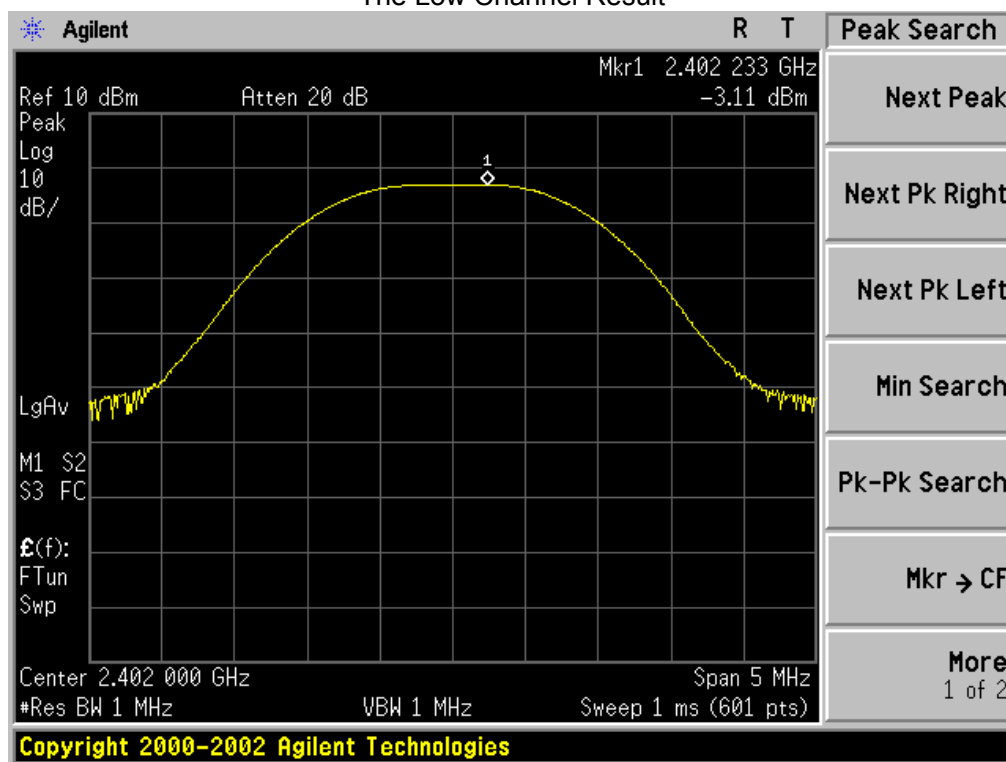

The Middle Channel Result

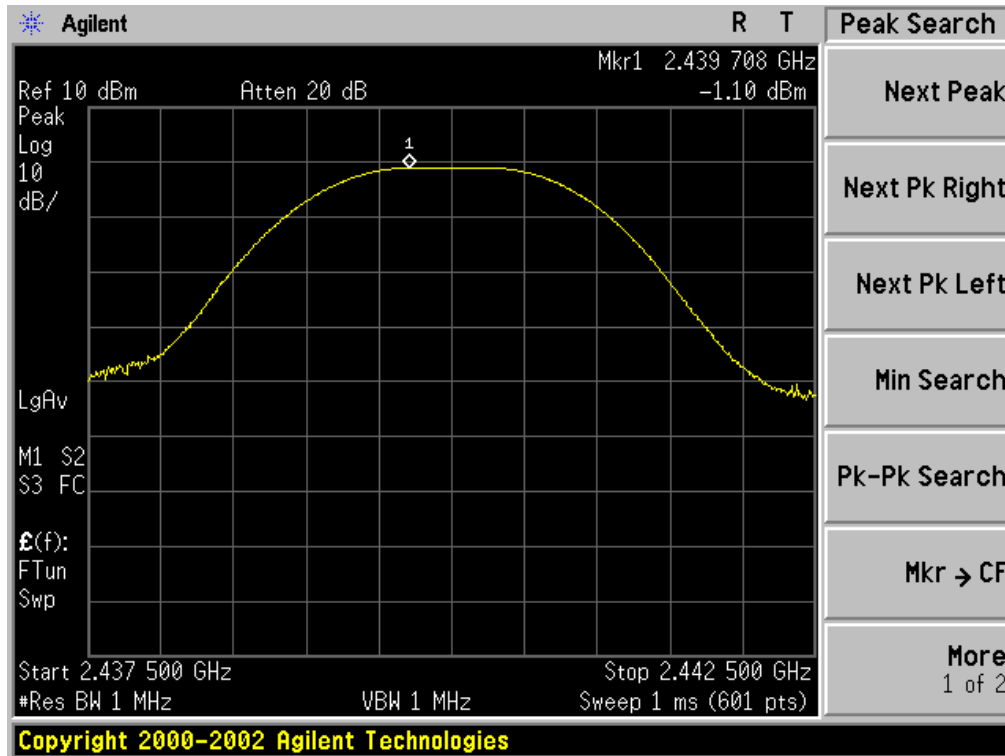

The High Channel Result

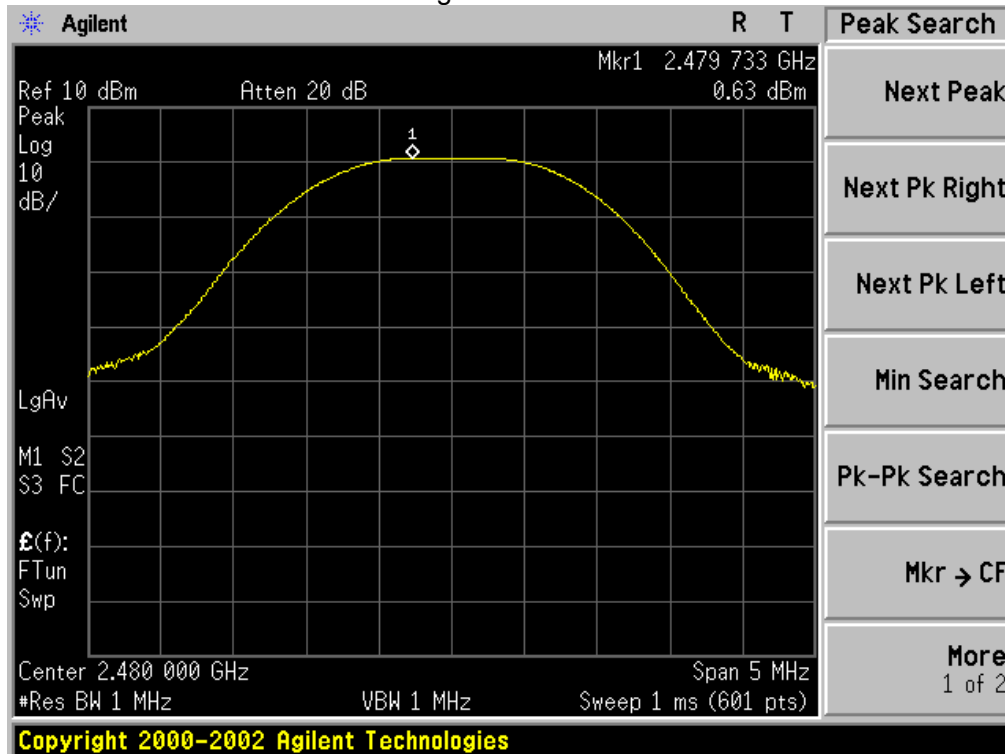

## 11. MAXIMUM CONDUCTED OUTPUT POWER SPECTRAL DENSITY

### 11.1 MEASUREMENT PROCEDURE

- (1). Connect EUT RF output port to the Spectrum Analyzer through an RF attenuator
- (2). Set the EUT Work on the top, the middle and the bottom operation frequency individually.
- (3). Set the span to 1.5times the DTS bandwidth, RBW:  $3\text{kHz} \leq \text{RBW} \leq 100\text{kHz}$ ,  $\text{VBW} = 3 * \text{RBW}$
- 4). Set SPA Trace 1 Max hold, then View.

Note: The EUT was tested according to KDB 558074 for compliance to FCC 47CFR 15.247 requirements.

### 11.2 TEST SET-UP (BLOCK DIAGRAM OF CONFIGURATION)

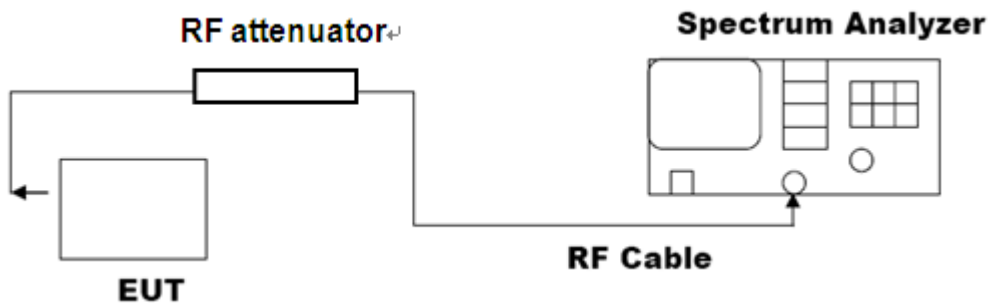

### 11.3 LIMITS AND MEASUREMENT RESULT

Channel No.	PSD (dBm/3KHz)	Limit (dBm/3KHz)	Result
Low Channel	-18.42	8	Pass
Middle Channel	-14.84	8	Pass
High Channel	-13.16	8	Pass

TEST PLOT OF SPECTRAL DENSITY FOR LOW CHANNEL

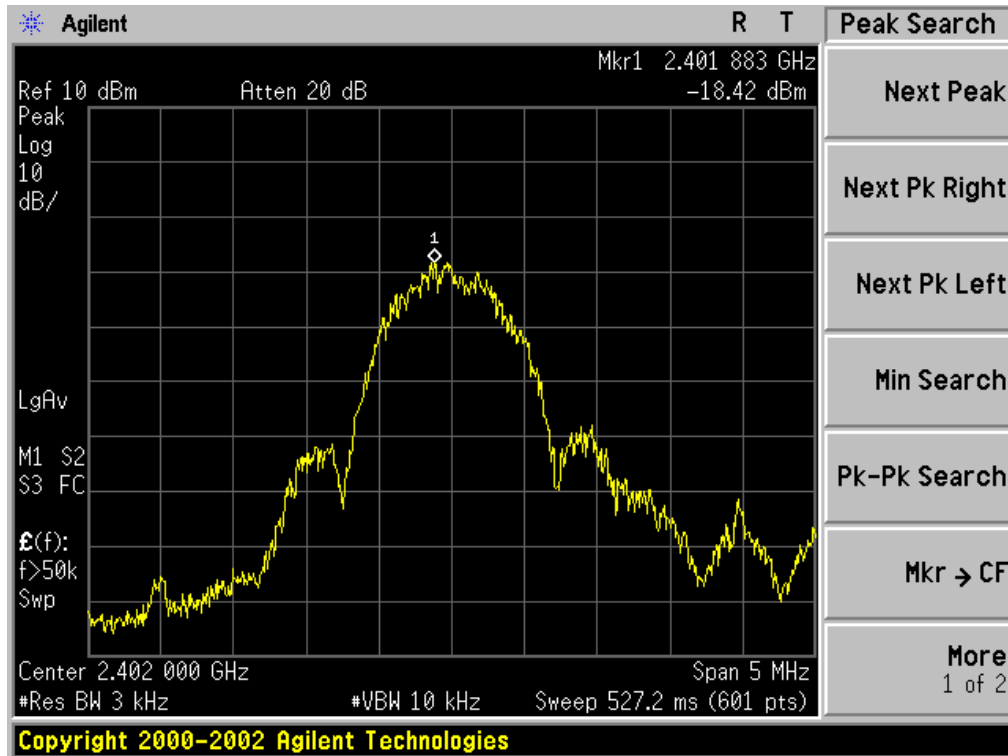

TEST PLOT OF SPECTRAL DENSITY FOR MIDDLE CHANNEL

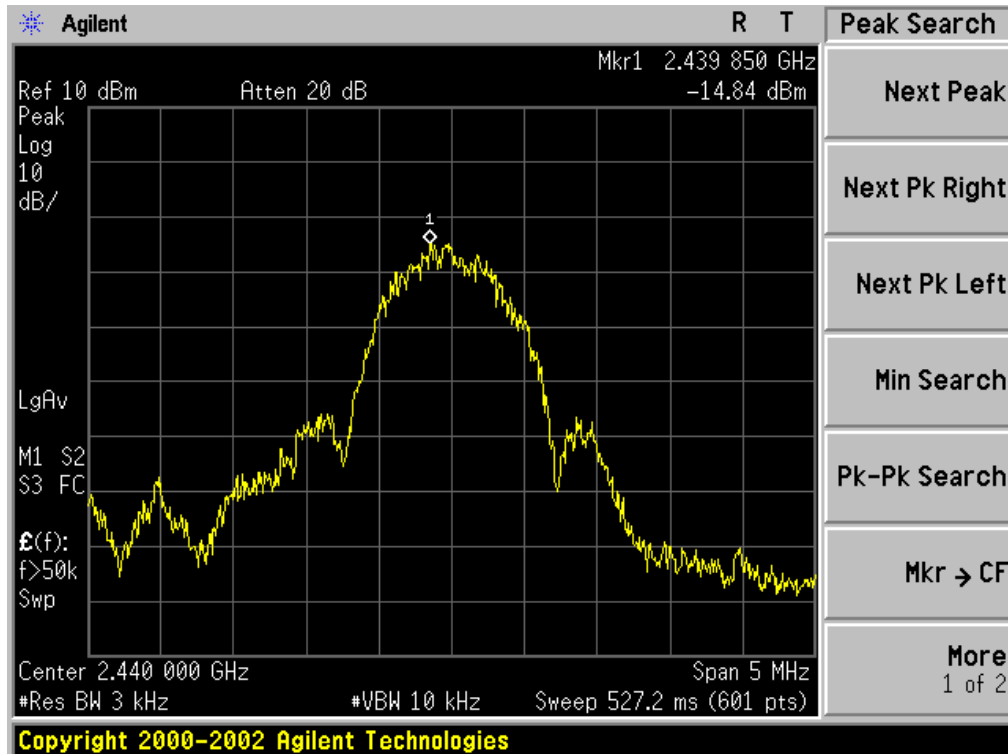

TEST PLOT OF SPECTRAL DENSITY FOR HIGH CHANNEL

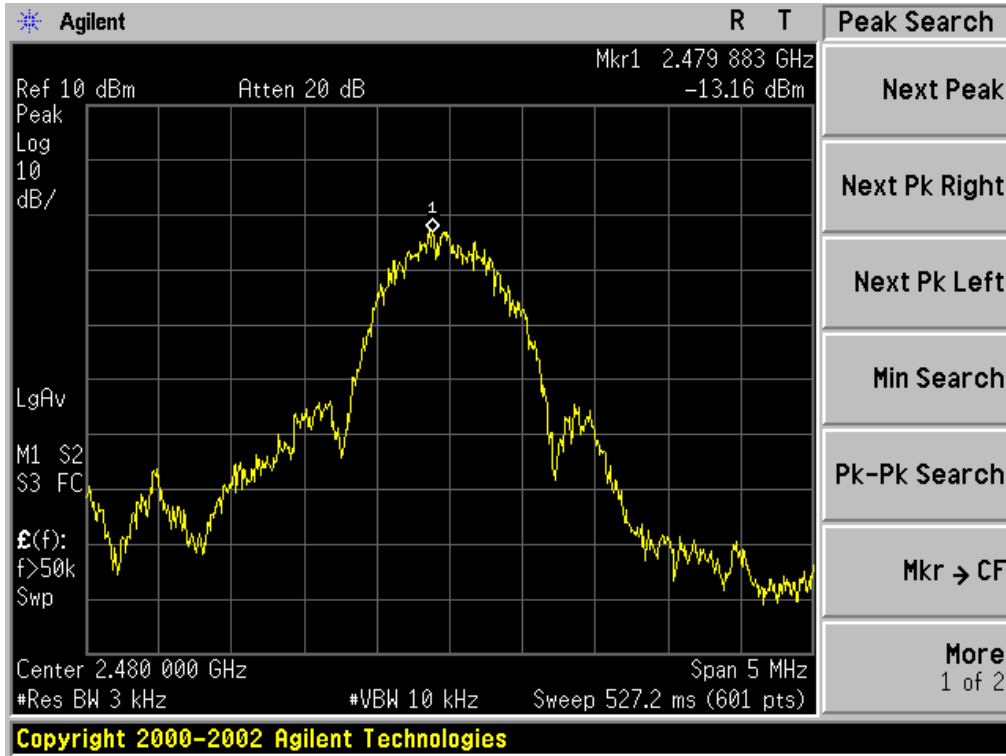



## 12. FCC LINE CONDUCTED EMISSION TEST

### 12.1 LIMITS

Frequency	Maximum RF Line Voltage	
	Q.P.( dBuV)	Average( dBuV)
150kHz~500kHz	66-56	56-46
500kHz~5MHz	56	46
5MHz~30MHz	60	50

- \*\*Note:** 1. The lower limit shall apply at the transition frequency.  
2. The limit decreases linearly with the logarithm of the frequency in the range 0.15 MHz to 0.50 MHz

### 12.2 TEST SETUP

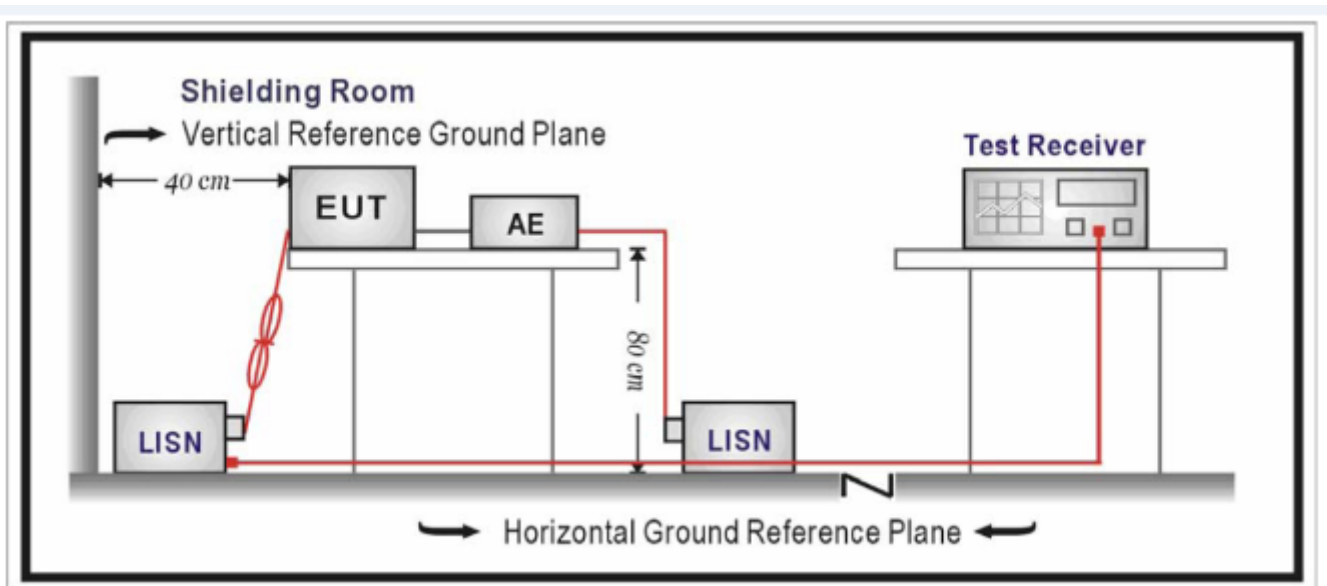

### 12.3 PRELIMINARY PROCEDURE

- 1) The equipment was set up as per the test configuration to simulate typical actual usage per the user's manual. When the EUT is a tabletop system, a wooden table with a height of 0.8 meters is used and is placed on the ground plane as per ANSI C63.10 (see Test Facility for the dimensions of the ground plane used). When the EUT is a floor-standing equipment, it is placed on the ground plane which has a 3-12 mm non-conductive covering to insulate the EUT from the ground plane.
- 2) Support equipment, if needed, was placed as per ANSI C63.10.
- 3) All I/O cables were positioned to simulate typical actual usage as per ANSI C63.10.
- 4) All support equipments received AC120V/60Hz power from a LISN, if any.
- 5) The EUT received DC charging voltage by PC or by adapter which received 120V/60Hz power by a LISN.
- 6) The test program was started. Emissions were measured on each current carrying line of the EUT using a spectrum Analyzer / Receiver connected to the LISN powering the EUT. The LISN has two monitoring points: Line 1 (Hot Side) and Line 2 (Neutral Side). Two scans were taken: one with Line 1 connected to Analyzer / Receiver and Line 2 connected to a 50 ohm load; the second scan had Line 1 connected to a 50 ohm load and Line 2 connected to the Analyzer / Receiver.
- 7) Analyzer / Receiver scanned from 150 kHz to 30MHz for emissions in each of the test modes.
- 8) During the above scans, the emissions were maximized by cable manipulation.
- 9) The following test mode(s) were scanned during the preliminary test.  
Then, the EUT configuration and cable configuration of the above highest emission level were recorded for reference of final testing.

### 12.4 FINAL TEST PROCEDURE

- 1) EUT and support equipment was set up on the test bench as per step 2 of the preliminary test.
- 2) A scan was taken on both power lines, Line 1 and Line 2, recording at least the six highest emissions. Emission frequency and amplitude were recorded into a computer in which correction factors were used to calculate the emission level and compare reading to the applicable limit. If EUT emission level was less -2dB to the A.V. limit in Peak mode, then the emission signal was re-checked using Q.P and Average detector.
- 3) The test data of the worst case condition(s) was reported on the Summary Data page.

## **12.5 TEST RESULT OF POWER LINE**

N/A

Note: Owing to the EUT is not active when charging, So the test item is not applicable.

## APPENDIX A: PHOTOGRAPHS OF TEST SETUP

### FCC RADIATED EMISSION TEST SETUP

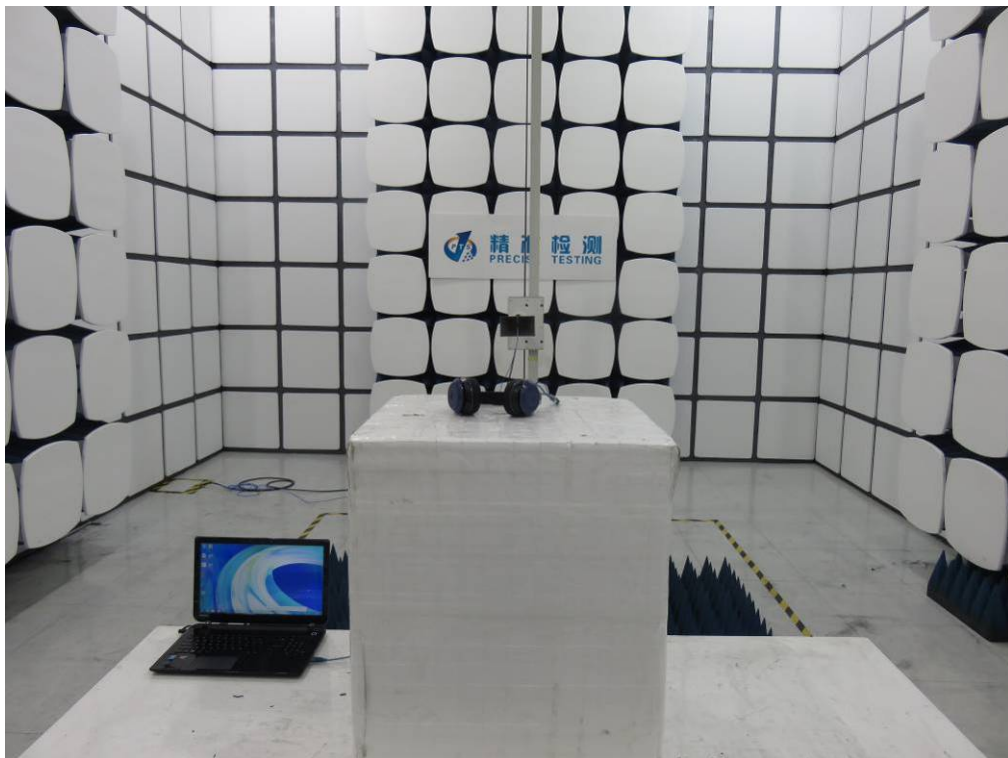
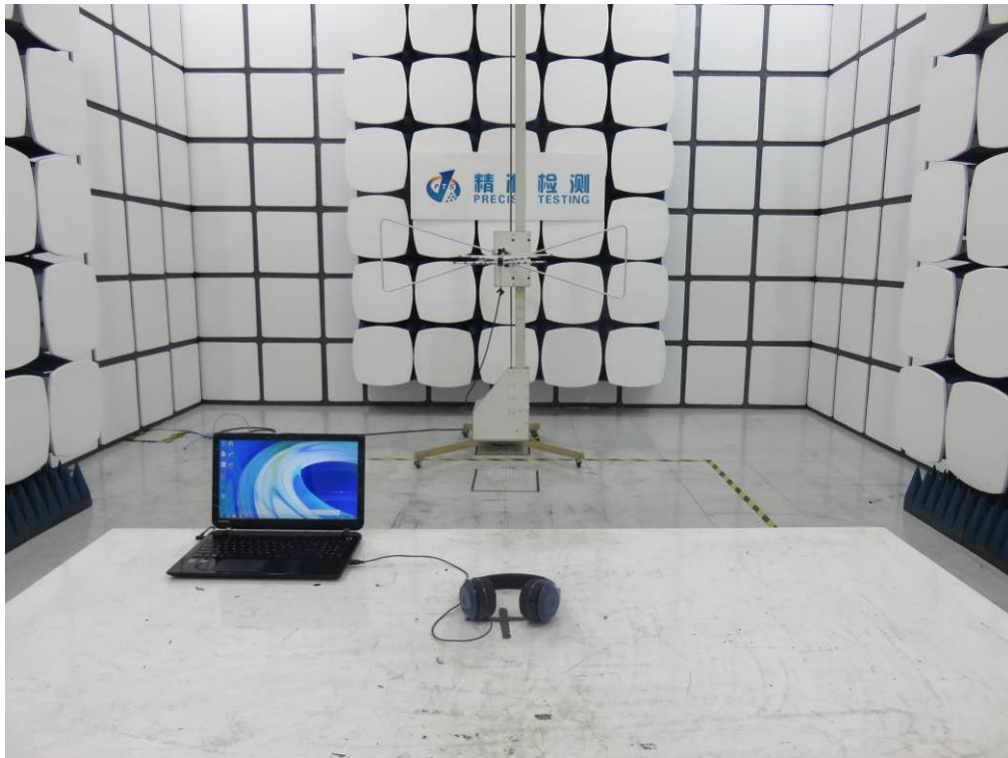

## APPENDIX B: PHOTOGRAPHS OF EUT

### WHOLE VIEW OF EUT



TOP VIEW OF EUT



BOTTOM VIEW OF EUT



FRONT VIEW OF EUT



BACK VIEW OF EUT



LEFT VIEW OF EUT



RIGHT VIEW OF EUT



VIEW OF EUT (PORT)





VIEW OF EUT (OPEN)



INTERNAL VIEW OF EUT-1

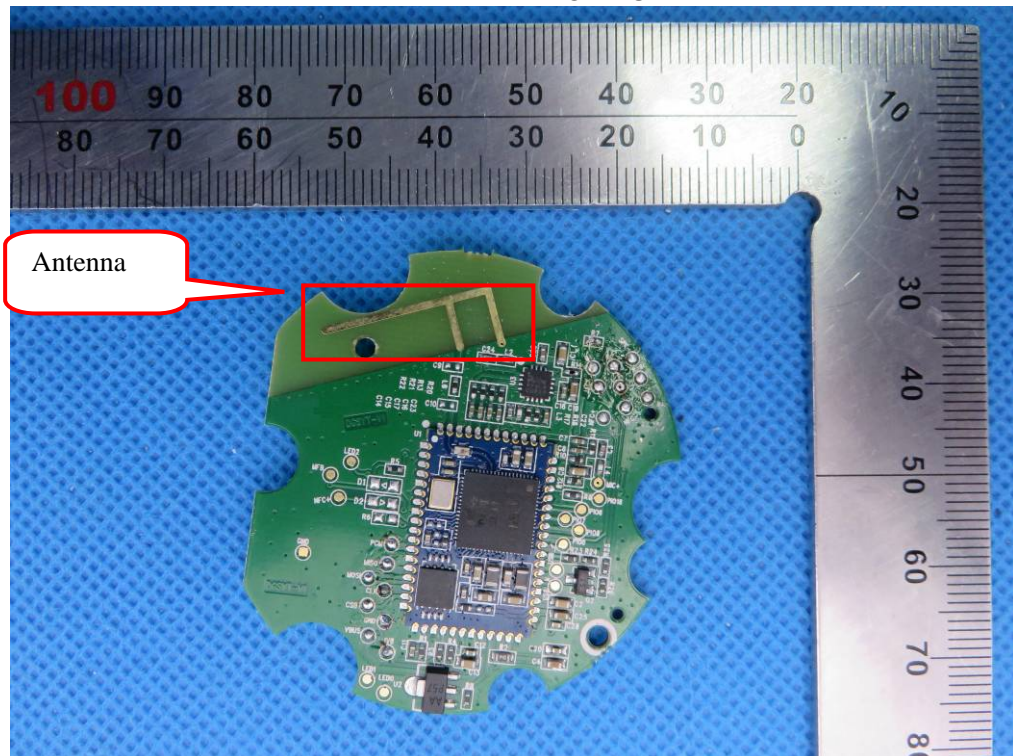

INTERNAL VIEW OF EUT-2

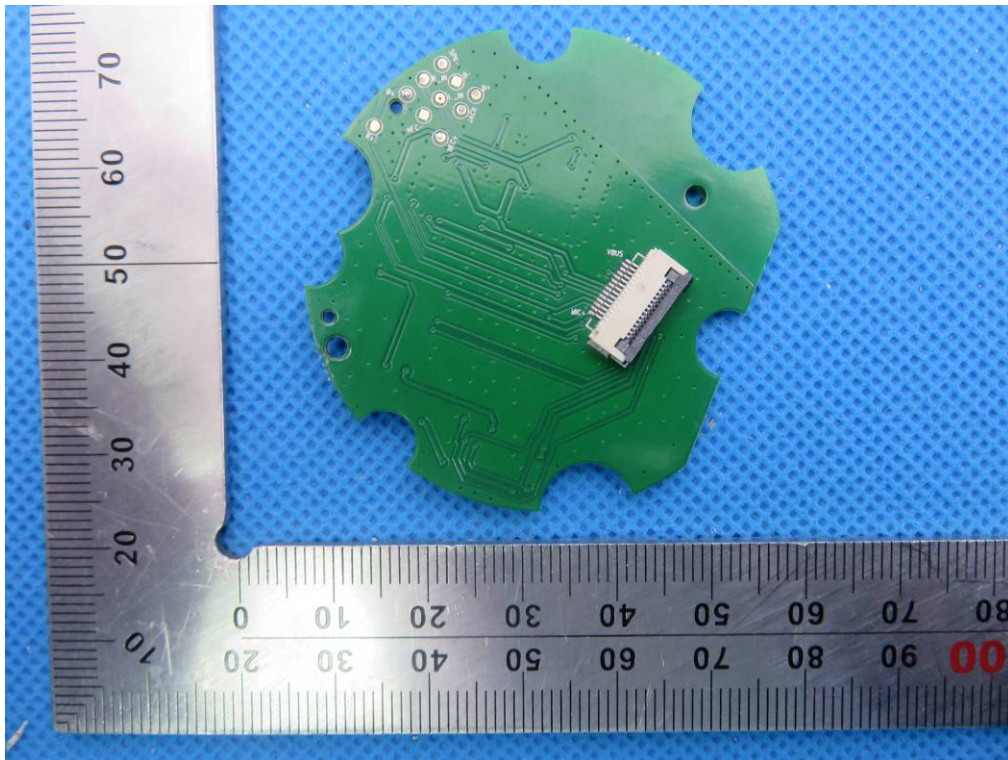

INTERNAL VIEW OF EUT-3

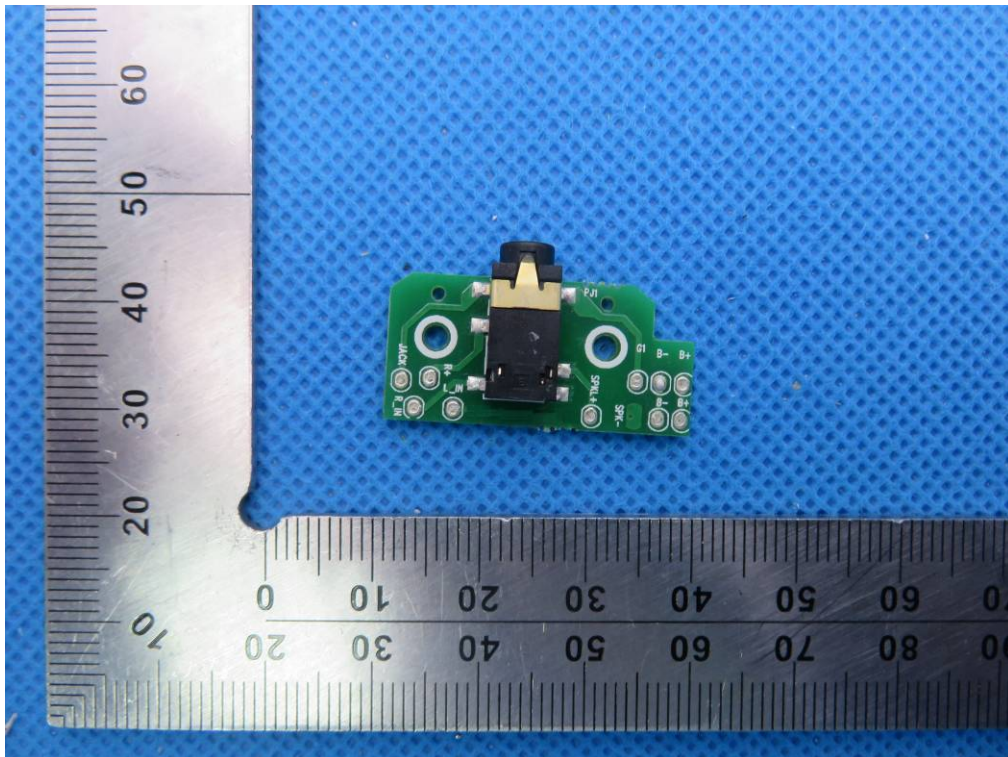

INTERNAL VIEW OF EUT-4

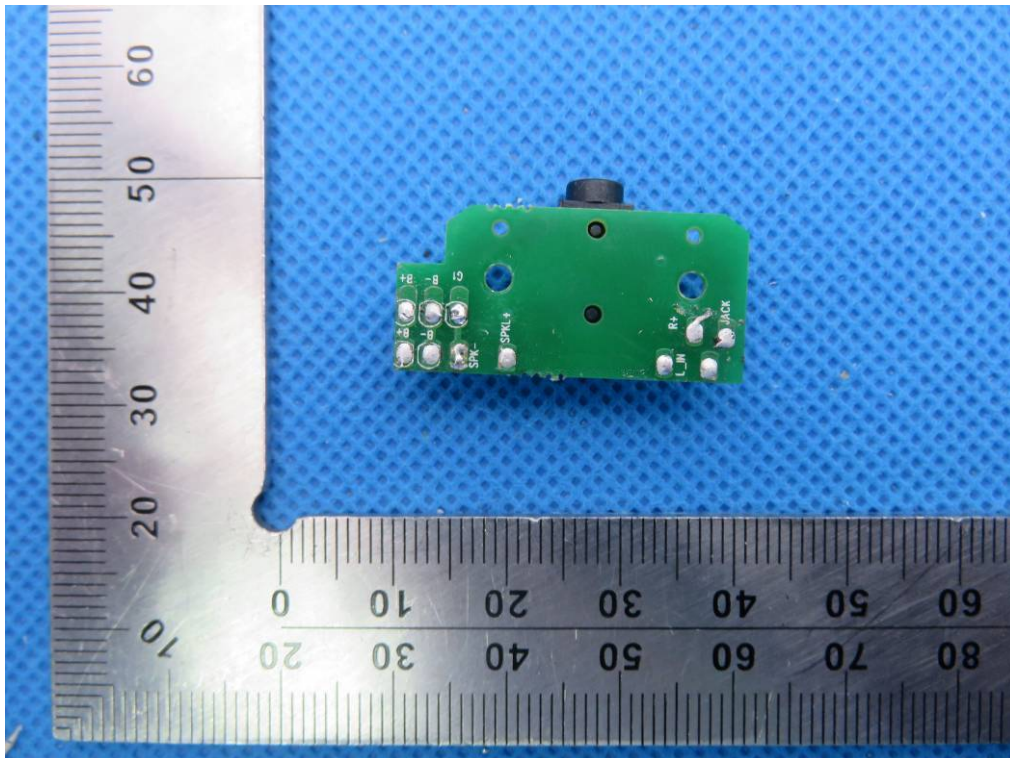

INTERNAL VIEW OF EUT-5

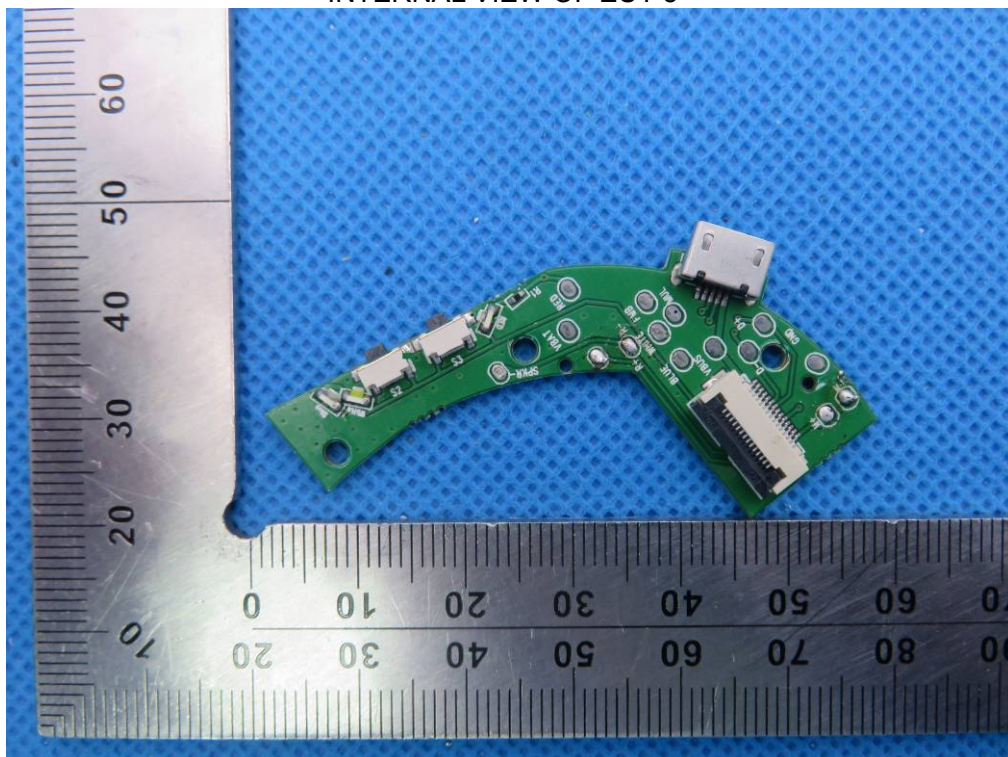

INTERNAL VIEW OF EUT-6

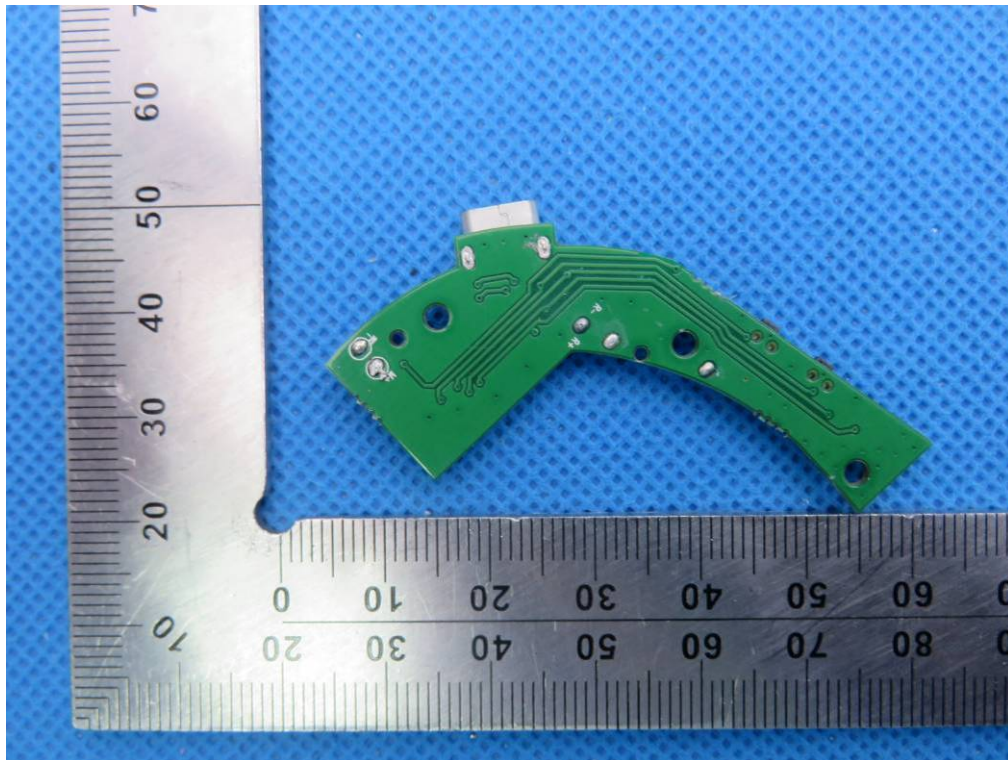

----END OF REPORT----