

TEST REPORT

Product Name : RC BIRTHDAY HELLO KITTY
Model Number : ET-0904
FCC ID : 2ADM5-ET-0904

Prepared for : Zeeva International Limited
Address : Suite 1007B, 10th Floor, Exchange Tower, 33 Wang Chiu Road, Kowloon Bay, Hong Kong, China

Prepared by : EMTEK (DONGGUAN) CO., LTD.
Address : -1&2/F., Building 2, Zone A, Zhongda Marine Biotechnology Research and Development Base, No.9, Xincheng Avenue, Songshanhu High-technology Industrial Development Zone, Dongguan, Guangdong, China

TEL: +86-0769-22807078
FAX: +86-0769-22807079

Report Number : EDG2404280041E00101R
Date(s) of Tests : May 06, 2024 to May 20, 2024
Date of issue : May 21, 2024

TEST REPORT DESCRIPTION

Applicant : Zeeva International Limited
 Address : Suite 1007B, 10th Floor, Exchange Tower, 33 Wang Chiu Road, Kowloon Bay, Hong Kong, China
 Manufacturer : Zeeva International Limited
 Address : Suite 1007B, 10th Floor, Exchange Tower, 33 Wang Chiu Road, Kowloon Bay, Hong Kong, China
 EUT : RC BIRTHDAY HELLO KITTY
 Model Name : ET-0904
 Trademark : N/A

Measurement Procedure Used:

APPLICABLE STANDARDS	
STANDARD	TEST RESULT
FCC 47 CFR Part 2, Subpart J FCC 47 CFR Part 15, Subpart C	PASS

The above equipment was tested by EMTEK(DONGGUAN) CO., LTD. The test data, data evaluation, test procedures, and equipment configurations shown in this report were made in accordance with the procedures given in ANSI C63.10-2013 and the energy emitted by the sample EUT tested as described in this report is in compliance with conducted and radiated emission limits of FCC Rules Part 15.227.

Date of Test : May 06, 2024 to May 20, 2024

Warren Deng

Prepared by : Warren Deng /Editor

Tim Dong

Reviewer : Tim Dong/ Supervisor

Approved & Authorized Signer : 

Sam Lv / Manager



Modified History

Version	Report No.	Revision Date	Summary
	EDG2404280041E00101R	/	Original Report



Table of Contents

1. GENERAL INFORMATION	5
1.1 PRODUCT DESCRIPTION	5
2. SYSTEM TEST CONFIGURATION	6
2.1 EUT CONFIGURATION	6
2.2 EUT EXERCISE	6
2.3 TEST PROCEDURE	6
2.4 LIMITATION	7
2.5 CONFIGURATION OF TESTED SYSTEM	8
3. SUMMARY OF TEST RESULTS	9
4. DESCRIPTION OF TEST MODES	10
5. TEST FACILITY	11
6. TEST SYSTEM UNCERTAINTY	12
7. CONDUCTED EMISSIONS TEST	13
7.1 MEASUREMENT PROCEDURE:	13
7.2 TEST SET-UP (BLOCK DIAGRAM OF CONFIGURATION)	13
7.3 MEASUREMENT EQUIPMENT USED:	13
7.4 MEASUREMENT RESULT:	13
7.5 CONDUCTED MEASUREMENT PHOTOS:	13
8. RADIATED EMISSION TEST	14
8.1 MEASUREMENT PROCEDURE	14
8.2 TEST SET-UP (BLOCK DIAGRAM OF CONFIGURATION)	14
8.3 MEASUREMENT EQUIPMENT USED:	15
8.4 RADIATED EMISSION LIMIT	16
FIELD STRENGTH OF THE FUNDAMENTAL SIGNAL	16
8.5 MEASUREMENT RESULTS	17
8.6 RADIATED MEASUREMENT PHOTOS:	22
9. OCCUPIED BANDWIDTH	23
9.1 MEASUREMENT PROCEDURE	23
9.2 TEST SET-UP (BLOCK DIAGRAM OF CONFIGURATION)	23
9.3 MEASUREMENT EQUIPMENT USED:	23
9.4 MEASUREMENT REQUIREMENTS:	23
10. ANTENNA APPLICATION	25
10.1 ANTENNA REQUIREMENT	25
10.2 RESULT	25

1. GENERAL INFORMATION

1.1 Product Description

Characteristics	Description
Product Name	RC BIRTHDAY HELLO KITTY
Model number	ET-0904
SKU#	9148888
UPC#	1922341059006
Color	WHITE MULTI
Power Supply	DC 3V from Battery
Operating Frequency Range	27.145MHz
Modulation	FSK
Number of Channels	1 channel
Max Field Strength	54.06 dBuV@3m
Antenna Type	Hose antenna
Temperature Range:	-10°C ~ +60°C
Remark: The EUT continues to transmit while button is being pressed. Modulation by IC, and type is pulse modulation.	

Note: for more details, please refer to the User's manual of the EUT.

2. System Test Configuration

2.1 EUT Configuration

The EUT configuration for testing is installed on RF field strength measurement to meet the Commissions requirement and operating in a manner which intends to maximize its emission characteristics in a continuous normal application.

2.2 EUT Exercise

The Transmitter was operated in the normal operating mode. the Tx frequency was fixed which was for the purpose of the measurements.

2.3 Test Procedure

2.3.1 Conducted Emissions

The EUT is a placed on as turn table which is 0.8 m above ground plane. According to the requirements in Section 13.1.4.1 of ANSI C63.10-2013. Conducted emissions from the EUT measured in the **frequency range between 0.15 MHz and 30MHz** using **CISPR Quasi-Peak and average detector mode**.

2.3.2 Radiated Emissions

The EUT is a placed on as turn table which is 0.8 m above ground plane. The turn table shall rotate 360 degrees to determine the position of maximum emission level. EUT is set 3m away from the receiving antenna which varied from 1m to 4m to find out the highest emission. And also, each emission was to be maximized by changing the polarization of receiving antenna both horizontal and vertical. In order to find out the max. emission, the relative positions of this hand-held transmitter(EUT) was rotated through three orthogonal axes according to the requirements in Section 13.1.4.1 of ANSI C63.10-2013

2.4 Limitation

(1) Conducted Emission

According to section 15.207(a) Conducted Emission Limits is as following.

Frequency range MHz	Limits dB(uV)	
	Quasi-peak	Average
0.15 to 0.50	66 to 56	56 to 46
0.50 to 5	56	46
5 to 30	60	50

Note

- The lower limit shall apply at the transition frequencies
- The limit decreases linearly with the logarithm of the frequency in the range 0.15 MHz to 0.50 MHz.

(2) Radiated Emission

- The field strength of any emission within this band (26.96-27.28 MHz.) shall not exceed 10,000 microvolts/meter at 3 meters. The emission limit in this paragraph is based on measurement instrumentation employing an average detector. The provisions in § 15.35 for limiting peak emissions apply.
- The field strength of any emissions which appear outside of this band shall not exceed the general radiated emission limits in § 15.209.

Frequency (MHz)	Field strength $\mu\text{V/m}$	Distance(m)	Field strength at 3m $\text{dB}\mu\text{V/m}$
1.705-30	30	30	69.54
30-88	100	3	40
88-216	150	3	43.5
216-960	200	3	46
Above 960	500	3	54

- Remark:
- Emission level in $\text{dBuV/m} = 20 \log(\mu\text{V/m})$
 - Measurement was performed at an antenna to the closed point of EUT distance of meters.
 - Only spurious frequency is permitted to locate within the Restricted Bands specified in provision of § 15.205
 - Emission spurious frequency which appearing within the Restricted Bands specified in provision of § 15.205, then the general radiated emission limits in § 15.209 apply.

2.5 Configuration of Tested System

Fig. 2-1 Configuration of Tested System

EUT

Table 2-1 Equipment Used in Tested System

Item	Equipment	Trademark	Model No.	FCC ID	Series No.	Note
1	RC BIRTHDAY HELLO KITTY	N/A	ET-0904	2ADM5-ET-0904	N/A	EUT

Note:

- (1) Unless otherwise denoted as EUT in 『Remark』 column , device(s) used in tested system is a support equipment.

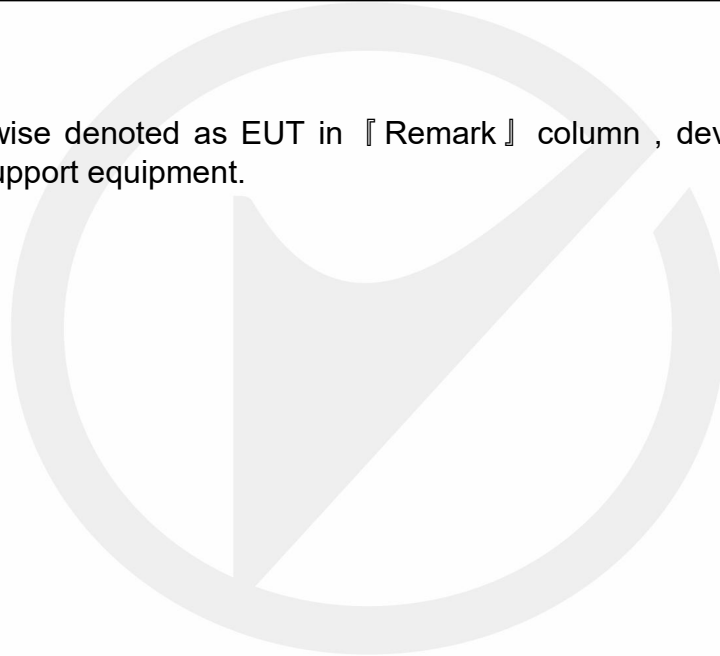

3. Summary of Test Results

FCC Rules	Description Of Test	Result
§15.207	Conducted Emission	N/A
§15.227	Radiated Emission	Compliant
§15.227	Bandwidth Test	Compliant
§15.203	Antenna Requirement	Compliant



4. Description of test modes

The EUT (RC BIRTHDAY HELLO KITTY) has been tested under normal operating condition. The EUT stay in continuous transmitting mode. The Frequency 27.145MHz is chosen for testing.

For Radiated: The EUT's antenna was pre-tested under the following modes:

Test Mode	Description
Mode A	X-Y axis
Mode B	Y-Z axis
Mode C	X-Z axis

From the above modes, the worst case was found in Mode A. Therefore only the test data of the mode was recorded in this report.



5. Test Facility

Site Description
EMC Lab.

: **Accredited by CNAS**
The Laboratory has been assessed and proved to be in compliance with
CNAS-CL01:2018
The Certificate Registration Number is L3150

Accredited by FCC
Designation Number: CN1300
Test Firm Registration Number: 945551

Accredited by A2LA
The Certificate Registration Number is 4321.02

Accredited by Industry Canada
The Certificate Registration Number is CN0113

Name of Firm

: EMTEK (DONGGUAN) CO., LTD.

Site Location

: -1&2/F., Building 2, Zone A, Zhongda Marine Biotechnology Research
and Development Base, No.9, Xincheng Avenue, Songshanhu
High-technology Industrial Development Zone, Dongguan, Guangdong,
China

6. TEST SYSTEM UNCERTAINTY

The following measurement uncertainty levels have been estimated for tests performed on the apparatus:

Parameter	Uncertainty
Radio Frequency	$\pm 1 \times 10^{-5}$
Maximum Peak Output Power Test	$\pm 1.0\text{dB}$
Conducted Emissions Test	$\pm 2.0\text{dB}$
Radiated Emission Test	$\pm 2.0\text{dB}$
Power Density	$\pm 2.0\text{dB}$
Occupied Bandwidth Test	$\pm 1.0\text{dB}$
Band Edge Test	$\pm 3\text{dB}$
All emission, radiated	$\pm 3\text{dB}$
Antenna Port Emission	$\pm 3\text{dB}$
Temperature	$\pm 0.5^\circ\text{C}$
Humidity	$\pm 3\%$

Measurement Uncertainty for a level of Confidence of 95%



7. Conducted Emissions Test

7.1 Measurement Procedure:

1. The EUT was placed on a table which is 0.8m above ground plane.
2. Maximum procedure was performed on the six highest emissions to ensure EUT compliance.
3. Repeat above procedures until all frequency measured were complete.

7.2 Test SET-UP (Block Diagram of Configuration)

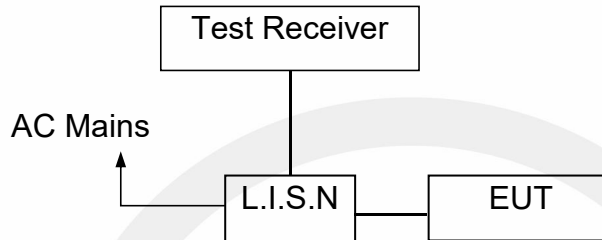

7.3 Measurement Equipment Used:

Equipment	Manufacturer	Model No.	Serial No.	Last Cal.	Cal. Interval
EMI Test Receiver	Rohde&Schwarz	ESCI	100137	2024/4/29	1Year
AMN	Rohde&Schwarz	ENV216	101209	2024/4/28	1Year
AMN	Rohde&Schwarz	ENV216	100017	2024/4/28	1Year
RF Switching Unit	CDS	RSU-M2	38401	2024/4/28	1Year
AMN	Schwarzbeck	NNLK8121	8121-641	2024/4/28	1Year
AMN	Rohde&Schwarz	ESH3-Z6	101101	2024/4/28	1Year
AMN	Rohde&Schwarz	ESH3-Z6	101102	2024/4/28	1Year
Power Splitters & Dividers	Weinschel Associates	WA1506A	A1066	2024/4/28	1Year
Current Probe	FCC	F-52	8377	2024/4/28	1Year
Passive voltage probe	Rohde&Schwarz	ESH2-Z3	100122	2024/4/28	1Year

7.4 Measurement Result:

N/A.

7.5 Conducted Measurement Photos:

N/A

8. Radiated Emission Test

8.1 Measurement Procedure

1. The EUT was placed on a turntable which is 0.8m above ground plane.
2. Maximum procedure was performed on the six highest emissions to ensure EUT compliance.
3. And also, each emission was to be maximized by changing the polarization of receiving antenna both horizontal and vertical.
4. Repeat above procedures until all frequency measured were complete.

8.2 Test SET-UP (Block Diagram of Configuration)

(A) Radiated Emission Test Set-Up, Frequency Below 30MHz

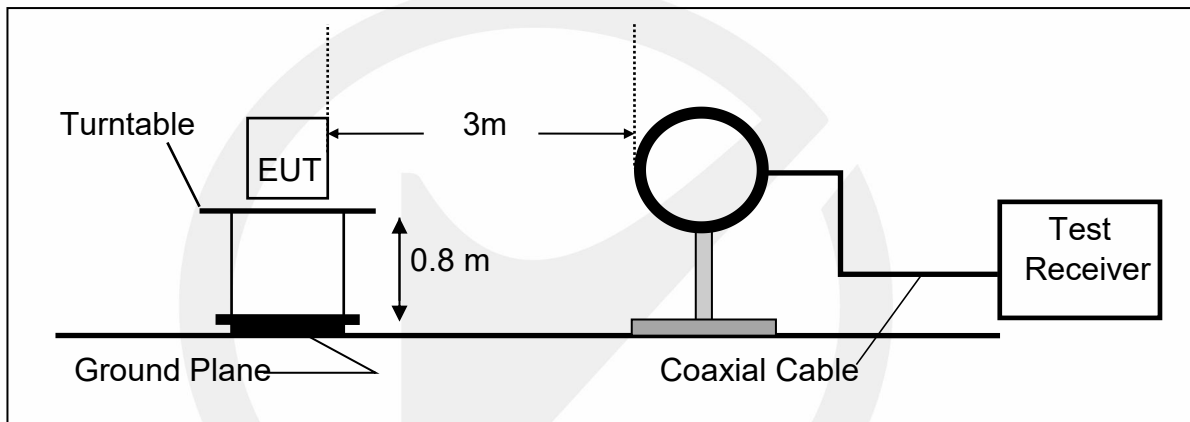

(B) Radiated Emission Test Set-Up, Frequency Above 30MHz

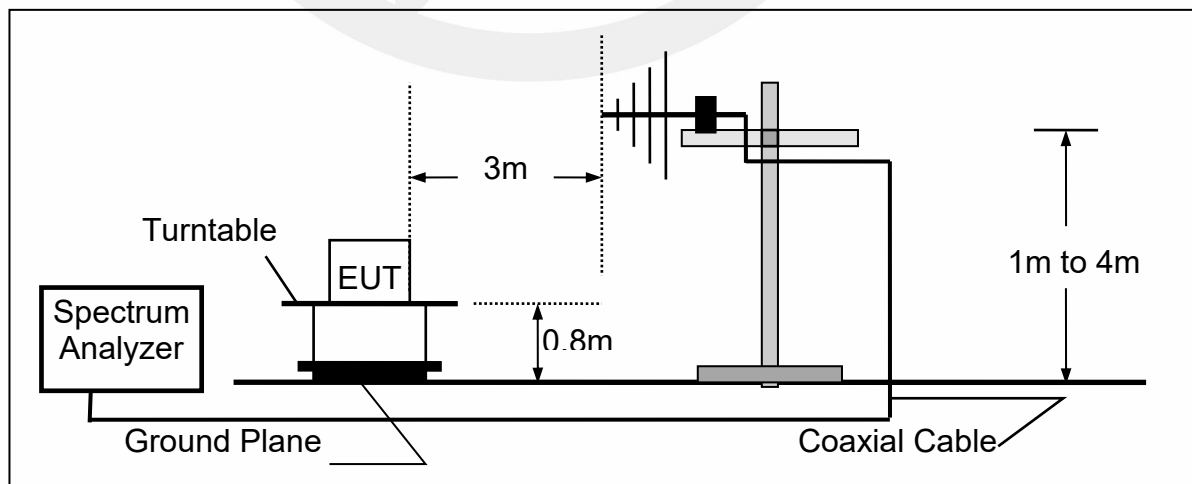

8.3 Measurement Equipment Used:

Equipment	Manufacturer	Model No.	Serial No.	Last Cal.	Cal. Interval
EMI Test Receiver	Rohde&Schwarz	ESCI	101415	2024/4/28	1Year
Bi-log Hybrid Antenna	Schwarzbeck	VULB9163	141	2024/5/5	1Year
Pre-Amplifie	HP	8447F	OPH64	2024/4/28	1 Year
Signal Analyzer	R&S	FSV30	103039	2024/4/28	1 Year
Horn Antenna	Schwarzbeck	BBHA9120D	1272	2024/5/5	1Year
Horn Antenna	Schwarzbeck	BBHA9170	9170-567	2024/5/5	1Year
Pre-Amplifie	LUNAR EM	PM1-18-40	J10100000081	2024/4/28	1Year
Loop antenna	Schwarzbeck	FMZB1519	1519-012	2024/5/5	1Year



8.4 Radiated Emission Limit

The emissions from an intentional radiator shall not exceed the field strength levels specified in the following table 15.209(a):

Frequencies (MHz)	Field Strength (microrvolts/meter)	Measurement Distance (meters)
0.009~0.490	2400/F(KHz)	300
0.490~1.705	24000/F(KHz)	30
1.705~30.0	30	30
30~88	100	3
88~216	150	3
216~960	200	3
Above 960	500	3

Restricted bands of operation

MHz	MHz	MHz	GHz
0.090 - 0.110	16.42 - 16.423	399.9 - 410	4.5 - 5.15
¹ 0.495 - 0.505	16.69475 - 16.69525	608 - 614	5.35 - 5.46
2.1735 - 2.1905	16.80425 - 16.80475	960 - 1240	7.25 - 7.75
4.125 - 4.128	25.5 - 25.67	1300 - 1427	8.025 - 8.5
4.17725 - 4.17775	37.5 - 38.25	1435 - 1626.5	9.0 - 9.2
4.20725 - 4.20775	73 - 74.6	1645.5 - 1646.5	9.3 - 9.5
6.215 - 6.218	74.8 - 75.2	1660 - 1710	10.6 - 12.7
6.26775 - 6.26825	108 - 121.94	1718.8 - 1722.2	13.25 - 13.4
6.31175 - 6.31225	123 - 138	2200 - 2300	14.47 - 14.5
8.291 - 8.294	149.9 - 150.05	2310 - 2390	15.35 - 16.2
8.362 - 8.366	156.52475 - 156.52525	2483.5 - 2500	17.7 - 21.4
8.37625 - 8.38675	156.7 - 156.9	2690 - 2900	22.01 - 23.12
8.41425 - 8.41475	162.0125 - 167.17	3260 - 3267	23.6 - 24.0
12.29 - 12.293	167.72 - 173.2	3332 - 3339	31.2 - 31.8
12.51975 - 12.52025	240 - 285	3345.8 - 3358	36.43 - 36.5
12.57675 - 12.57725	322 - 335.4	3600 - 4400	(²)

Remark 1. Emission level in dBuV/m=20 log (uV/m)

- :
- Measurement was performed at an antenna to the closed point of EUT distance of meters.
 - Only spurious frequency is permitted to locate within the Restricted Bands specified in provision of ξ 15.205, and the emissions located in restricted bands also comply with 15.209 limit.

Field Strength of the fundamental signal

FCC Part15 (15.227) , Subpart C		
Fundamental Frequency	Field Strength Of Fundamental	
27.145MHz	PK:100 dBuV/m at 3m distance	AV:80 dBuV/m at 3m distance

8.5 Measurement Results

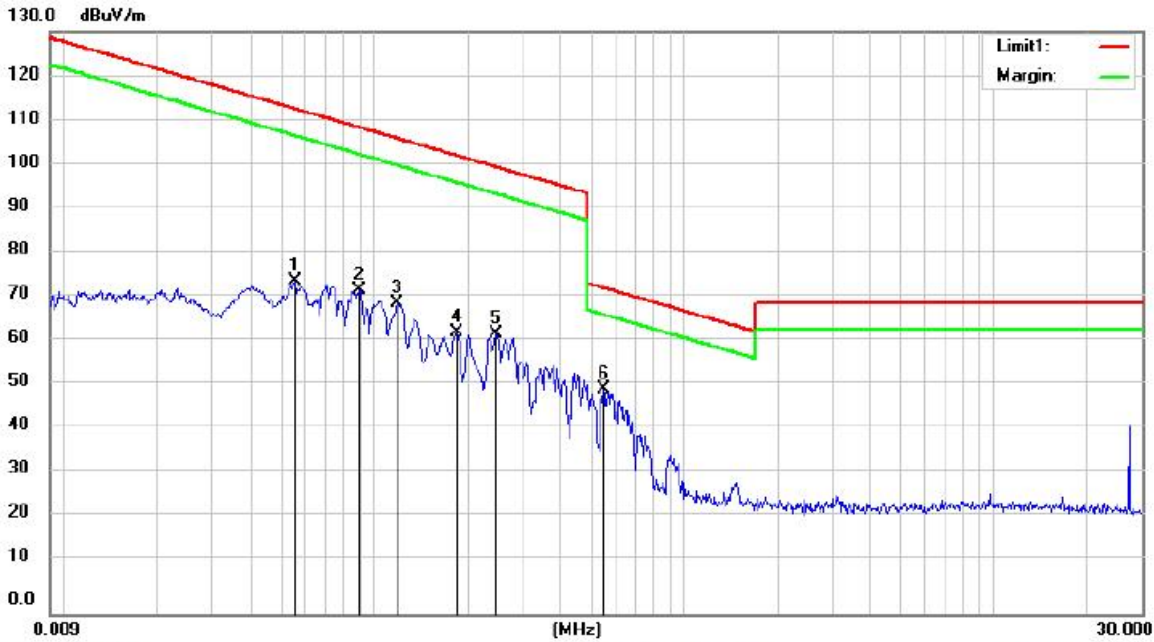

Site Chamber #1

Polarization: 0

Temperature: 22.4 C

No.	Mk.	Freq. MHz	Reading Level dBuV	Ant. Factor dB/m	Pre Amp Gain dB	Cable loss dB	Measure- ment dBuV/m	Limit dBuV/m	Over dB	HI	Degree	Comment
1		0.0553	82.60	20.24	28.53	0.03	74.34	112.74	-38.40	peak		
2		0.0892	80.49	20.16	28.51	0.07	72.21	108.59	-36.38	peak		
3		0.1187	77.77	20.08	28.57	0.08	69.36	106.11	-36.75	peak		
4		0.1853	71.49	20	28.84	0.08	62.73	102.24	-39.51	peak		
5		0.2463	71.65	20.01	29.08	0.08	62.66	99.77	-37.11	peak		
6	*	0.5500	59.83	20.04	29.81	0.1	50.16	72.80	-22.64	peak		

*:Maximum data x:Over limit !:over margin

Operator: Cyf

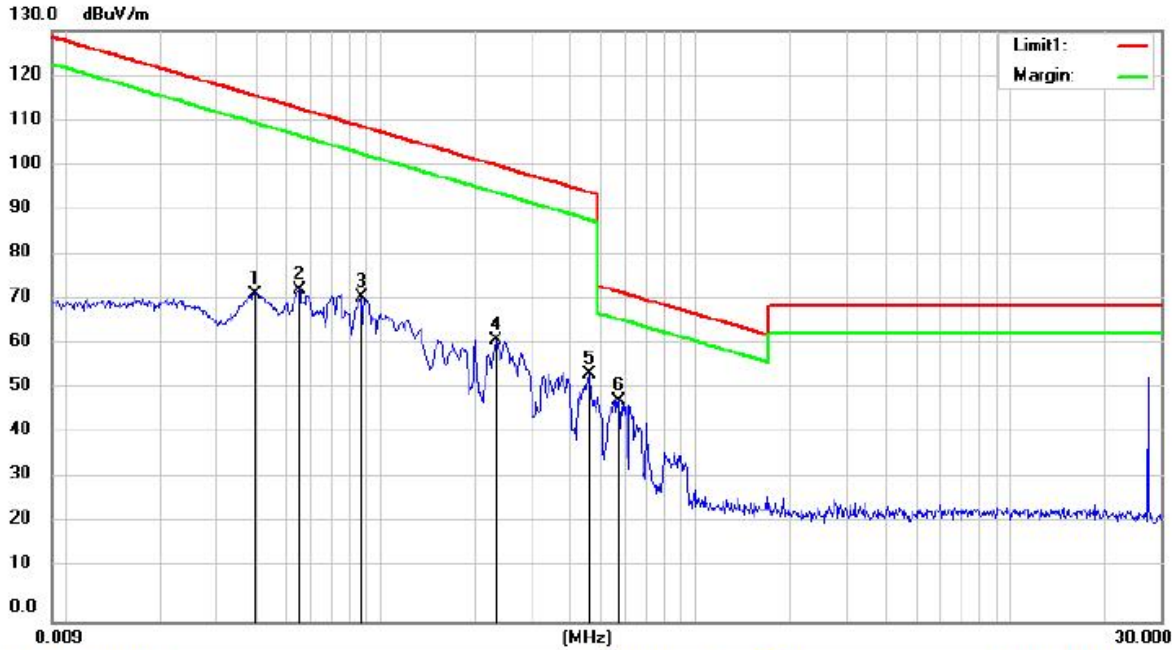

Site Chamber #1 Polarization: 90 Temperature: 22.4 C

No.	Mk.	Freq. MHz	Reading Level dBuV	Ant. Factor dB/m	Pre Amp Gain dB	Cable loss dB	Measure- ment dBuV/m	Limit dBuV/m	Over dB	HI	Degree	Comment
1		0.0396	80.32	20.28	28.54	0.03	72.09	115.64	-43.55	peak		
2		0.0550	81.15	20.24	28.53	0.03	72.89	112.79	-39.90	peak		
3		0.0865	79.62	20.16	28.51	0.06	71.33	108.86	-37.53	peak		
4		0.2328	70.87	20.01	29.02	0.08	61.94	100.26	-38.32	peak		
5		0.4564	63.83	20.03	29.62	0.09	54.33	94.42	-40.09	peak		
6	*	0.5681	58.40	20.04	29.85	0.1	48.69	72.52	-23.83	peak		

*:Maximum data x:Over limit !:over margin

Operator: Ccyf

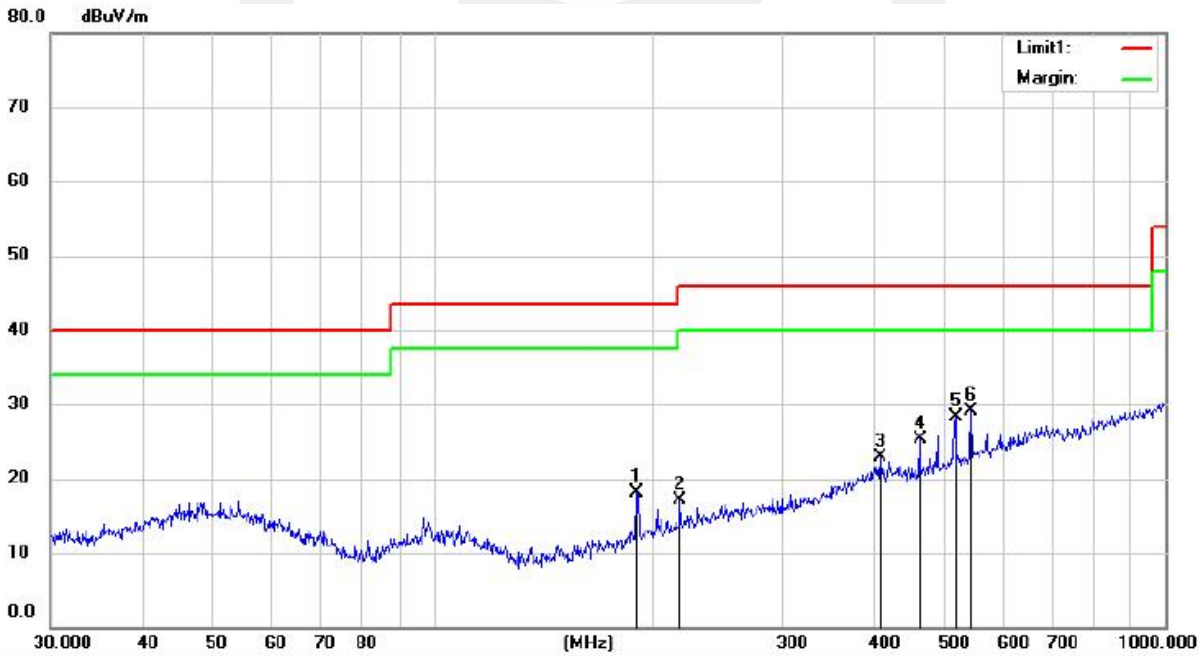
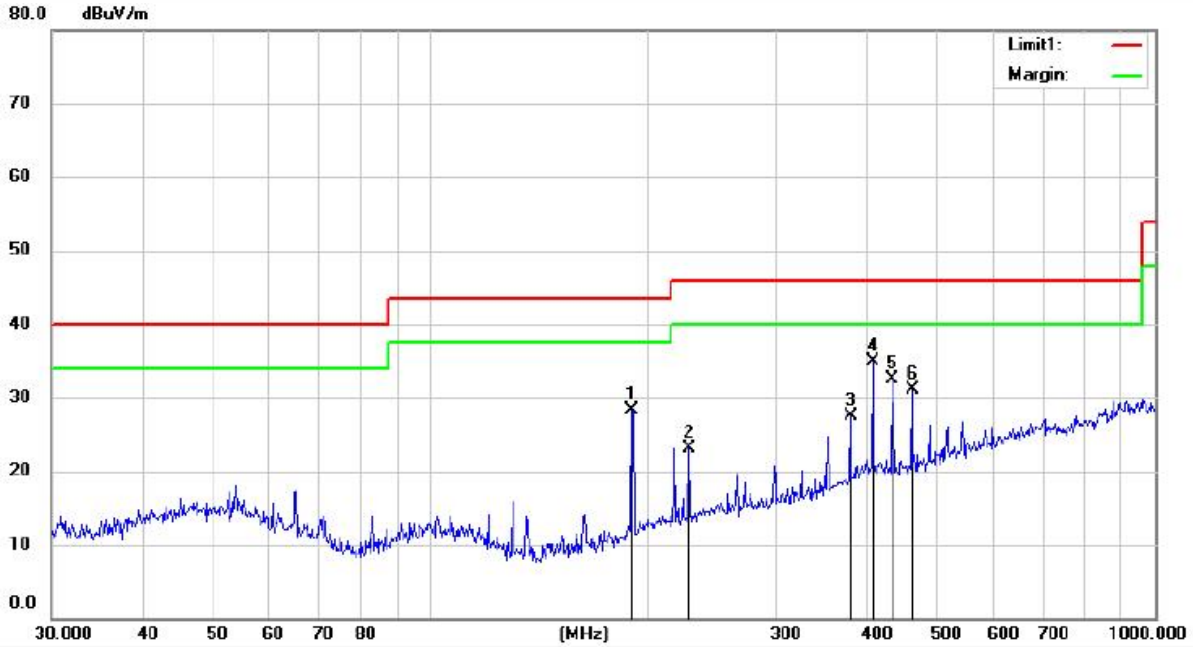

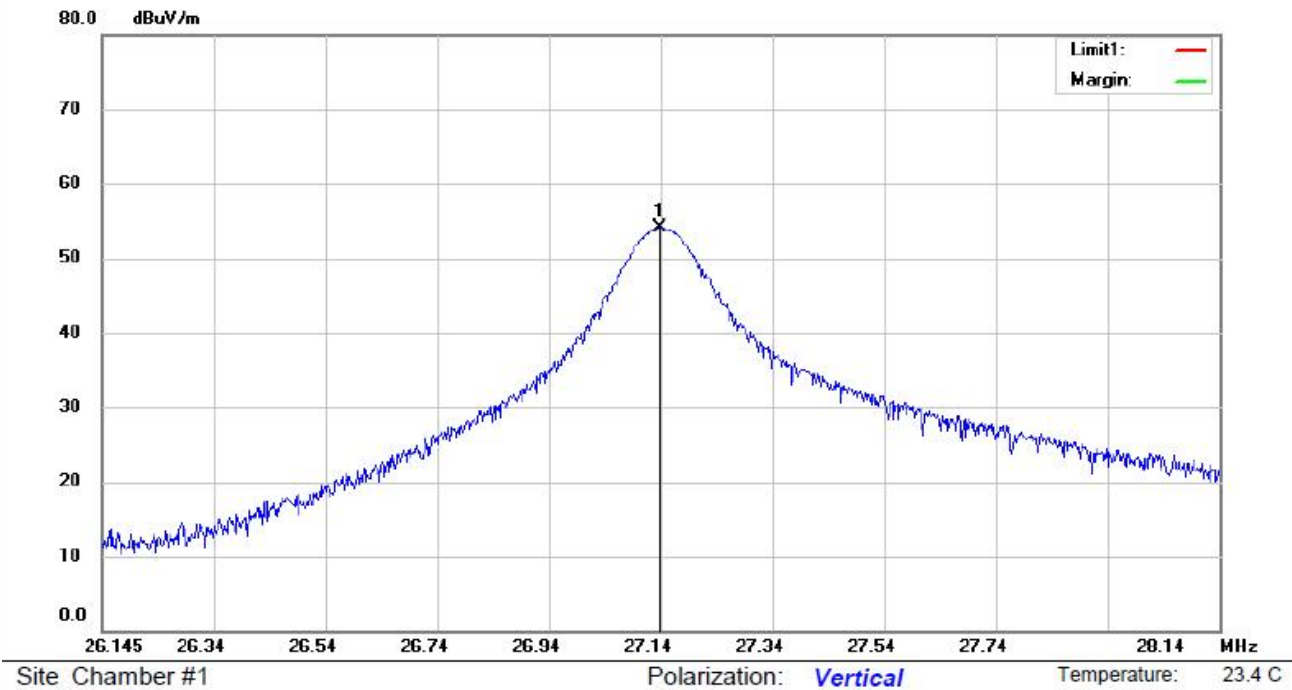
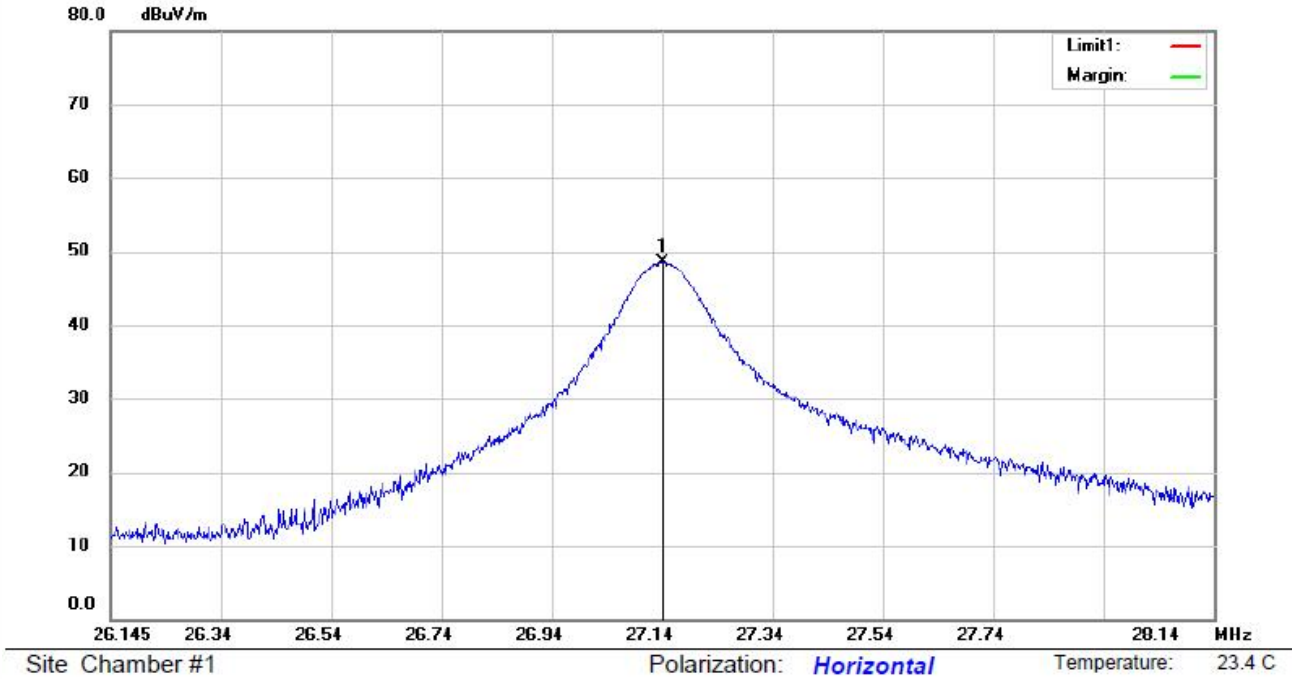

Remark:

1. Measurement (dB μ V/m) = Antenna Factor(dB) -Amp Factor(dB) +Cable Loss(dB) + Reading(dB μ V/m)
2. Over (dB) = Measurement (dB μ V/m) - Limit (dB μ V/m)

Test Result: **PASS** Test By: **Ccyf**
 Frequency Range: **30M-1GHz** Fundamental Frequency: **27.145 MHz**

Frequency (MHz)	Ant.Pol. (V/H)	Emission Level (dBuV/m)	Limit 3m (dBuV/m)	Margin (dB)	Note
27.1470	H	48.50	100.00	-51.50	Peak
27.1470	H	26.75	80.00	-53.25	AVG
189.7385	H	28.26	43.50	-15.24	QP
227.6906	H	23.06	46.00	-22.94	QP
379.9141	H	27.47	46.00	-18.53	QP
407.5145	H	34.98	46.00	-11.02	QP
434.0651	H	32.51	46.00	-13.49	QP
462.3455	H	31.02	46.00	-14.98	QP
27.1430	V	54.06	100.00	-45.94	Peak
27.1430	V	21.64	80.00	-58.36	AVG
189.7385	V	18.19	43.50	-25.31	QP
217.5443	V	17.10	46.00	-28.90	QP
407.5145	V	22.83	46.00	-23.17	QP
462.3455	V	25.34	46.00	-20.66	QP
517.2480	V	28.30	46.00	-17.70	QP
543.2742	V	29.05	46.00	-16.95	QP

No others harmonics emissions are higher than 20dB below the limits of 47 CFR Part 15.209.

8.6 Radiated Measurement Photos:

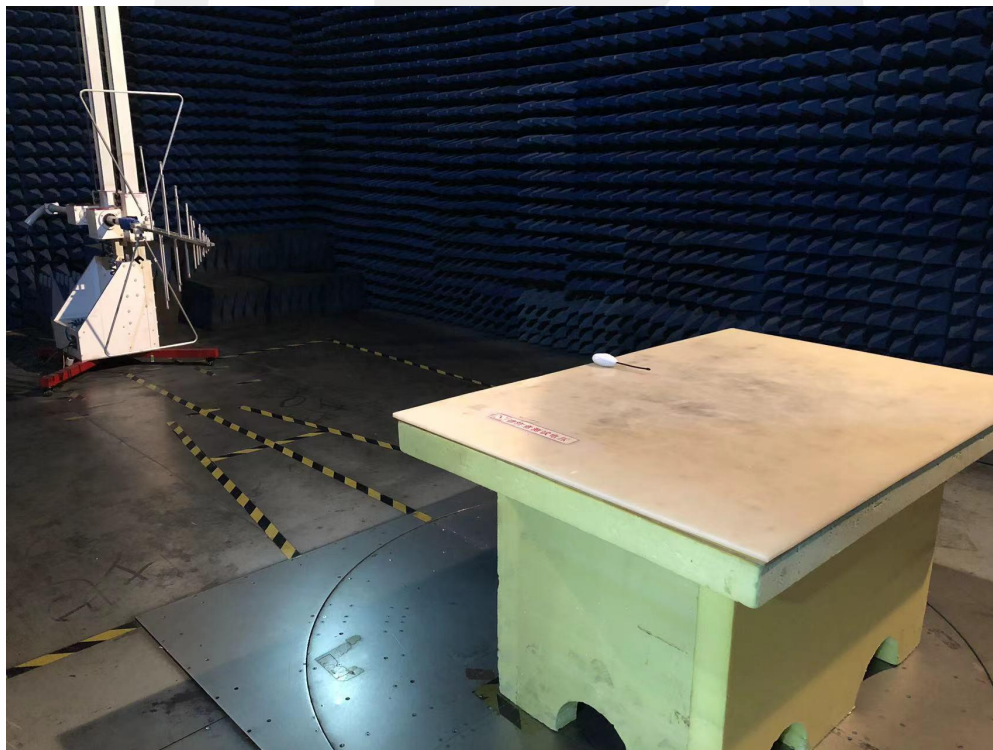
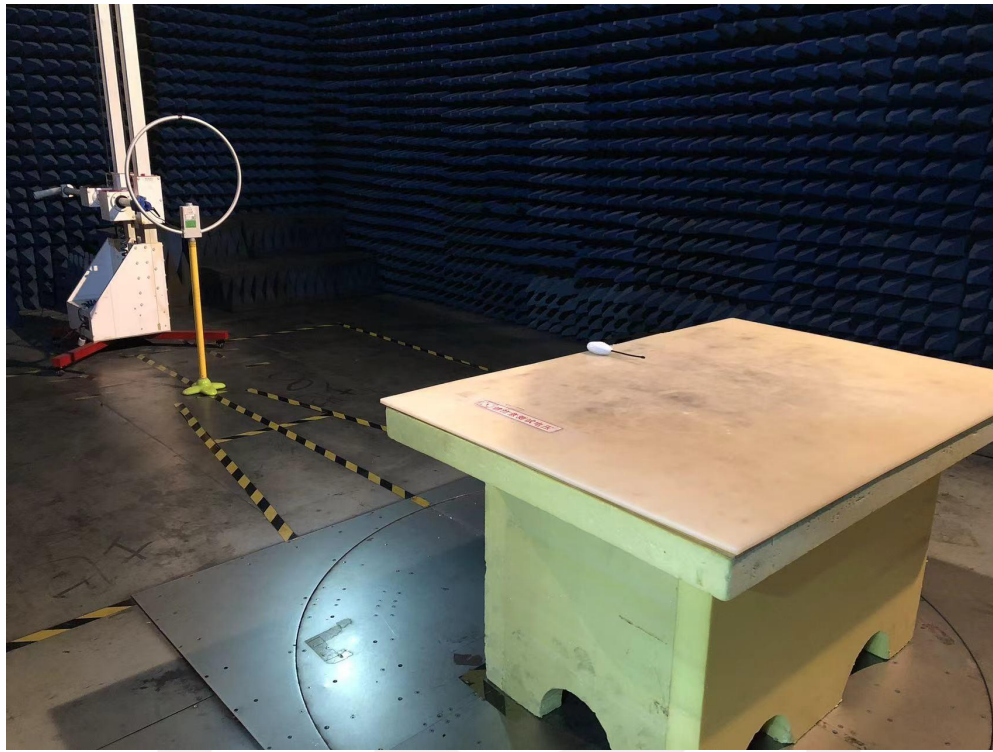

9. Occupied Bandwidth

9.1 Measurement Procedure

1. Set EUT as normal operation
2. Set SPA Center Frequency = fundamental frequency, RBW=1Hz,VBW= 3Hz
3. Set SPA Max hold. Mark peak.

9.2 Test SET-UP (Block Diagram of Configuration)

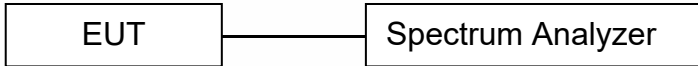

9.3 Measurement Equipment Used:

Equipment	Manufacturer	Model No.	Serial No.	Last Cal.	Cal. Interval
Signal Analyzer	R&S	FSV30	103039	2024/4/28	1 Year

9.4 Measurement Requirements:

Pass.

Limits for 20 dB Bandwidth of Fundamental Emission:

Frequency (MHz)	20dB Bandwidth (Hz)	Limits (MHz)
27.145	12.86	Within 27.141-27.150

Refer to attached data chart.

Band Width Test Data

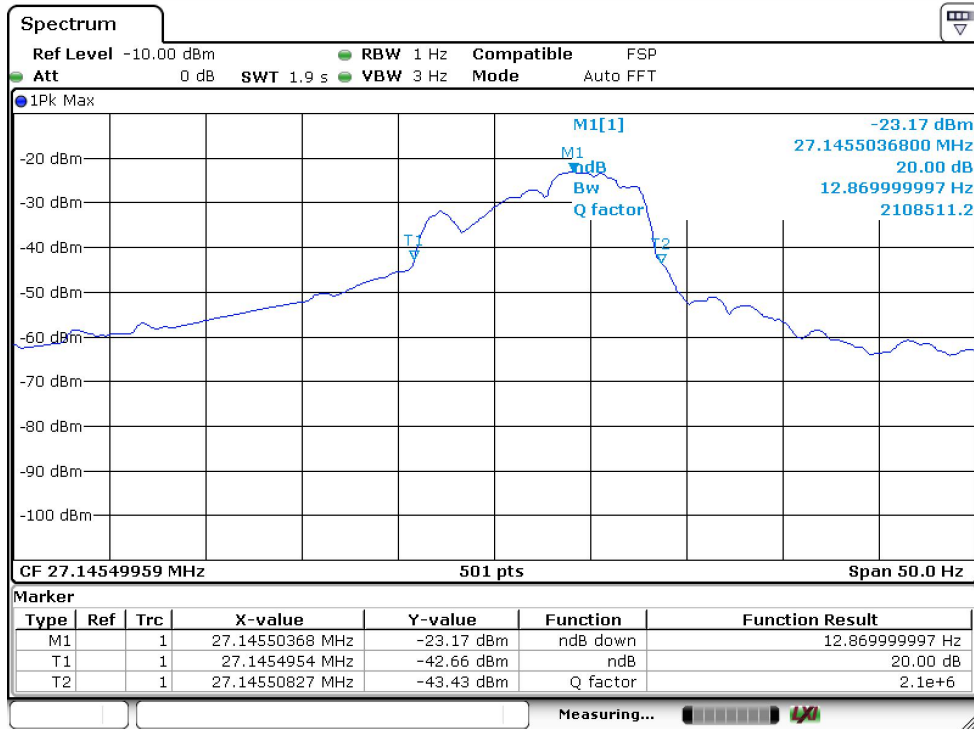

10. Antenna Application

10.1 Antenna requirement

The EUT'S antenna is met the requirement of FCC part 15C section 15.203.

Systems operating in the 27.145MHz that are used exclusively for fixed, point-to-point operations may employ transmitting antennas with directional gain greater than 6dBi provided the maximum peak output power of the intentional radiator is reduced by 1dB for every 3dB that the directional gain of the antenna exceeds 6dBi.

10.2 Result

The EUT's antenna is permanent attached antenna, external antenna. The antenna is not replaceable or user serviceable. The requirement of FCC part 15C section 15.203 is met.



*** End of Report ***