

TEST REPORT

Product Name : WOW Drone
Model Number : ET-0784
FCC ID : 2ADM5-ET-0784-RX

Prepared for : Zeeva International Limited
Address : Suite 1007B, 10th Floor, Exchange Tower, 33 Wang Chiu Road, Kowloon Bay, Hong Kong, China

Prepared by : EMTEK (DONGGUAN) CO., LTD.
Address : -1&2/F., Building 2, Zone A, Zhongda Marine Biotechnology Research and Development Base, No.9, Xincheng Avenue, Songshanhu High-technology Industrial Development Zone, Dongguan, Guangdong, China

TEL: +86-0769-22807078
FAX: +86-0769-22807079

Report Number : EDG2306080168E00301R
Date(s) of Tests : June 08, 2023 to July 18, 2023
Date of issue : July 18, 2023

TABLE OF CONTENTS

| | |
|--|-----------|
| 1 TEST RESULT CERTIFICATION | 3 |
| 2 EUT TECHNICAL DESCRIPTION | 5 |
| 3 SUMMARY OF TEST RESULT | 6 |
| 4 TEST METHODOLOGY | 7 |
| 4.1 GENERAL DESCRIPTION OF APPLIED STANDARDS | 7 |
| 4.2 MEASUREMENT EQUIPMENT USED | 7 |
| 4.3 DESCRIPTION OF TEST MODES | 8 |
| 5 FACILITIES AND ACCREDITATIONS | 9 |
| 5.1 FACILITIES | 9 |
| 5.2 LABORATORY ACCREDITATIONS AND LISTINGS | 9 |
| 6 TEST SYSTEM UNCERTAINTY | 10 |
| 7 SETUP OF EQUIPMENT UNDER TEST | 11 |
| 7.1 RADIO FREQUENCY TEST SETUP 1 | 11 |
| 7.2 RADIO FREQUENCY TEST SETUP 2 | 11 |
| 7.3 CONDUCTED EMISSION TEST SETUP | 14 |
| 7.4 BLOCK DIAGRAM CONFIGURATION OF TEST SYSTEM | 15 |
| 7.5 SUPPORT EQUIPMENT | 15 |
| 8 TEST REQUIREMENTS | 16 |
| 8.1 DTS 6DB BANDWIDTH | 16 |
| 8.2 DTS 99% BANDWIDTH | 22 |
| 8.3 MAXIMUM PEAK CONDUCTED OUTPUT POWER | 28 |
| 8.4 MAXIMUM POWER SPECTRAL DENSITY | 35 |
| 8.5 UNWANTED EMISSIONS IN NON-RESTRICTED FREQUENCY BANDS | 41 |
| 8.6 RADIATED SPURIOUS EMISSION | 48 |
| 8.7 CONDUCTED EMISSION TEST | 56 |
| 8.8 ANTENNA APPLICATION | 59 |

1 TEST RESULT CERTIFICATION

Applicant : Zeeva International Limited
 Address: Suite 1007B, 10th Floor, Exchange Tower, 33 Wang Chiu Road, Kowloon Bay, Hong Kong, China
 Manufacturer : Zeeva International Limited
 Address: Suite 1007B, 10th Floor, Exchange Tower, 33 Wang Chiu Road, Kowloon Bay, Hong Kong, China
 EUT : WOW Drone
 Model Name : ET-0784
 Trademark : N/A

Measurement Procedure Used:

| APPLICABLE STANDARDS | |
|--|-------------|
| STANDARD | TEST RESULT |
| FCC 47 CFR Part 2 , Subpart J FCC 47 CFR Part 15, Subpart C | PASS |

The above equipment was tested by EMTEK (DONGGUAN) CO., LTD. The test data, data evaluation, test procedures, and equipment configurations shown in this report were made in accordance with the procedures given in ANSI C63.10 (2013) and the energy emitted by the sample EUT tested as described in this report is in compliance with the requirements of FCC Rules Part 2 and Part 15.247

The test results of this report relate only to the tested sample identified in this report.

Date of Test : June 08, 2023 to July 18, 2023

Prepared by : Xia Yang
 Xia Yang /Editor

Reviewer : Tim Dong
 Tim Dong/ Supervisor

Approved & Authorized Signer : [Signature]
 Sam Lv / Manager

Modified History

| Version | Report No. | Revision Date | Summary |
|---------|----------------------|---------------|-----------------|
| | EDG2306080168E00301R | / | Original Report |
| | | | |
| | | | |



2 EUT TECHNICAL DESCRIPTION

| Characteristics | Description |
|---|--|
| Product: | WOW Drone |
| Model Number: | ET-0784 |
| Sample Number: | 2# |
| SKU#: | 9087505 |
| UPC#: | 1922342811191 |
| IEEE 802.11 WLAN Mode Supported: | 802.11b 802.11g 802.11n(20MHz channel bandwidth) |
| Modulation: | DSSS with DBPSK/DQPSK/CCK for 802.11b; OFDM with BPSK/QPSK/16QAM/64QAM for 802.11g/n; |
| Operating Frequency Range: | 2412-2462MHz for 802.11b/g/n(HT20); |
| Number of Channels: | 11 channels for 802.11b/g/n(HT20); |
| Transmit Power Max: | 5.50 dBm(0.003548W) |
| Antenna Type: | Integrated antenna |
| Antenna Gain: | 2.31 dBi |
| Power Supply: | DC 3.7V/1800mAh from battery |
| Temperature Range | 10°C ~ +40°C |

Note: for more details, please refer to the User's manual of the EUT.

3 SUMMARY OF TEST RESULT

| FCC Part Clause | Test Parameter | Verdict | Remark |
|-------------------------------|---|---------|--------|
| 15.247(a)(2) | Emission Bandwidth | PASS | |
| 15.247(b)(3) | Maximum Peak Conducted Output Power | PASS | |
| 15.247(e) | Maximum Power Spectral Density Level | PASS | |
| 15.247(d) | Unwanted Emission Into Non-Restricted Frequency Bands | PASS | |
| 15.247(d) | Unwanted Emission Into Restricted Frequency Bands (conducted) | PASS | |
| 15.247(d) 15.209 15.205 | Radiated Spurious Emission | PASS | |
| 15.207 | Conducted Emission Test | PASS | |
| 15.203 15.247(b) | Antenna Application | PASS | |

RELATED SUBMITTAL(S) / GRANT(S):

This submittal(s) (test report) is intended for **FCC ID: 2ADM5-ET-0784-RX** filing to comply with Section 15.247 of the FCC Part 15, Subpart C Rules.

4 TEST METHODOLOGY

4.1 GENERAL DESCRIPTION OF APPLIED STANDARDS

According to its specifications, the EUT must comply with the requirements of the following standards:

FCC 47 CFR Part 2, Subpart J

FCC 47 CFR Part 15, Subpart C

IC RSS-GEN, Issue 5(04-2018)+A1(03-2019)+A2(02-2021)

IC RSS-247 Issue 2(02-2017)

FCC KDB 558074 D01 15.247 Meas Guidance v05r02

FCC KDB 662911 D01 Multiple Transmitter Output v02r01

4.2 MEASUREMENT EQUIPMENT USED

For Conducted Emission Test Equipment

| Equipment | Manufacturer | Model No. | Serial No. | Last Cal. | Cal. Interval |
|-----------------------|---------------|-----------|--------------|-----------|---------------|
| EMI Test Receiver | Rohde&Schwarz | ESCI | 101415 | 2023/5/11 | 1Year |
| Bi-log Hybrid Antenna | Schwarzbeck | VULB9163 | 141 | 2023/5/15 | 1Year |
| Pre-Amplifie | HP | 8447F | OPTH64 | 2023/5/11 | 1 Year |
| Signal Analyzer | R&S | FSV30 | 103039 | 2023/5/11 | 1 Year |
| Horn Antenna | Schwarzbeck | BBHA9120D | 1272 | 2023/5/15 | 1Year |
| Horn Antenna | Schwarzbeck | BBHA9170 | 9170-567 | 2023/5/15 | 1Year |
| Pre-Amplifie | LUNAR EM | PM1-18-40 | J10100000081 | 2023/5/11 | 1Year |
| Loop antenna | Schwarzbeck | FMZB1519 | 1519-012 | 2023/5/15 | 1Year |

For Spurious Emissions Test

| Equipment | Manufacturer | Model No. | Serial No. | Last Cal. | Cal. Interval |
|-----------------------|---------------|-----------|--------------|-----------|---------------|
| EMI Test Receiver | Rohde&Schwarz | ESCI | 101415 | 2023/5/11 | 1Year |
| Bi-log Hybrid Antenna | Schwarzbeck | VULB9163 | 141 | 2023/5/15 | 1Year |
| Pre-Amplifie | HP | 8447F | OPTH64 | 2023/5/11 | 1 Year |
| Signal Analyzer | R&S | FSV30 | 103039 | 2023/5/11 | 1 Year |
| Horn Antenna | Schwarzbeck | BBHA9120D | 1272 | 2023/5/15 | 1Year |
| Horn Antenna | Schwarzbeck | BBHA9170 | 9170-567 | 2023/5/15 | 1Year |
| Pre-Amplifie | LUNAR EM | PM1-18-40 | J10100000081 | 2023/5/11 | 1Year |
| Loop antenna | Schwarzbeck | FMZB1519 | 1519-012 | 2023/5/15 | 1Year |

For other test items:

| Equipment | Manufacturer | Model No. | Serial No. | Last Cal. | Cal. Interval |
|-----------------------------------|--------------|-----------|------------|------------|---------------|
| Wireless Connectivity Tester | R&S | CMW270 | 102543 | 2023/05/11 | 1Year |
| Automatic Control Unit | Tonscend | JS0806-2 | 2118060480 | 2023/05/11 | 1Year |
| Signal Analyzer | KEYSIGHT | N9010B | MY60242456 | 2023/05/11 | 1Year |
| Analog Signal Generator | KEYSIGHT | N5173B | MY61252625 | 2023/05/11 | 1Year |
| UP/DOWN-Converter | R&S | CMW-Z800A | 100274 | 2023/05/11 | 1Year |
| Vector Signal Generator | KEYSIGHT | N5182B | MY61252674 | 2023/05/11 | 1Year |
| Frequency Extender | KEYSIGHT | N5182BX07 | MY59362541 | 2023/05/11 | 1Year |
| Temperature&Humidity test chamber | ESPEC | EL-02KA | 12107166 | 2023/05/11 | 1Year |

Remark: Each piece of equipment is scheduled for calibration once a year.

4.3 DESCRIPTION OF TEST MODES

The EUT has been tested under its typical operating condition.

The EUT configuration for testing is installed on RF field strength measurement to meet the Commissions requirement and operating in a manner which intends to maximize its emission characteristics in a continuous normal application.

The Transmitter was operated in the normal operating mode. The TX frequency was fixed which was for the purpose of the measurements.

Test of channel included the lowest and middle and highest frequency to perform the test, then record on this report.

Those data rates (802.11b: 1 Mbps; 802.11g: 6 Mbps; 802.11n (HT20): MCS0;) were used for all test.

Pre-defined engineering program for regulatory testing used to control the EUT for staying in continuous transmitting and receiving mode is programmed.

Frequency and Channel list for 802.11 b/g/n(HT20):

| Channel | Frequency (MHz) | Channel | Frequency (MHz) | Channel | Frequency (MHz) |
|---------|-----------------|---------|-----------------|---------|-----------------|
| 1 | 2412 | 5 | 2432 | 9 | 2452 |
| 2 | 2417 | 6 | 2437 | 10 | 2457 |
| 3 | 2422 | 7 | 2442 | 11 | 2462 |
| 4 | 2427 | 8 | 2447 | | |

Test Frequency and Channel for 802.11 b/g/n(HT20):

| Lowest Frequency | | Middle Frequency | | Highest Frequency | |
|------------------|-----------------|------------------|-----------------|-------------------|-----------------|
| Channel | Frequency (MHz) | Channel | Frequency (MHz) | Channel | Frequency (MHz) |
| 1 | 2412 | 6 | 2437 | 11 | 2462 |

Multi-antenna correlation:

| | |
|--------------------------|--|
| <input type="checkbox"/> | Transmit Signals are Correlated Directional gain = $10 \log[(10^{G1/20} + 10^{G2/20} + \dots + 10^{GN/20})^2 / N_{ANT}]$ dBi |
| <input type="checkbox"/> | All Transmit Signals are Completely Uncorrelated Directional gain = $10 \log[(10^{G1/10} + 10^{G2/10} + \dots + 10^{GN/10}) / N_{ANT}]$ dBi |

Not Applicable.

5 FACILITIES AND ACCREDITATIONS

5.1 FACILITIES

All measurement facilities used to collect the measurement data are located at:

EMTEK (DONGGUAN) CO., LTD.

-1&2/F., Building 2, Zone A, Zhongda Marine Biotechnology Research and Development Base, No.9, Xincheng Avenue, Songshanhu High-technology Industrial Development Zone, Dongguan, Guangdong, ChinaEQUIPMENT

Radiated emissions are measured with one or more of the following types of linearly polarized antennas: tuned dipole, biconical, log periodic, bi-log, and/or ridged waveguide, horn. Spectrum analyzers with preselectors and quasi-peak detectors are used to perform radiated measurements.

Conducted emissions are measured with Line Impedance Stabilization Networks and EMI Test Receivers.

Calibrated wideband preamplifiers, coaxial cables, and coaxial attenuators are also used for making measurements.

All receiving equipment conforms to CISPR Publication 16-1, "Radio Interference Measuring Apparatus and Measurement Methods."

5.2 LABORATORY ACCREDITATIONS AND LISTINGS

Site Description

EMC Lab.

: **Accredited by CNAS**

The Laboratory has been assessed and proved to be in compliance with CNAS-CL01:2018

The Certificate Registration Number is L3150

Accredited by FCC

Designation Number: CN1300

Test Firm Registration Number: 945551

Accredited by A2LA

The Certificate Registration Number is 4321.02

Accredited by Industry Canada

The Certificate Registration Number is CN0113

Name of Firm

: EMTEK (DONGGUAN) CO., LTD.

Site Location

: -1&2/F., Building 2, Zone A, Zhongda Marine Biotechnology Research and Development Base, No.9, Xincheng Avenue, Songshanhu High-technology Industrial Development Zone, Dongguan, Guangdong, China

6 TEST SYSTEM UNCERTAINTY

The following measurement uncertainty levels have been estimated for tests performed on the apparatus:

| Test Parameter | Measurement Uncertainty |
|--------------------------------|-------------------------|
| Radio Frequency | $\pm 1 \times 10^{-5}$ |
| Maximum Peak Output Power Test | $\pm 1.0\text{dB}$ |
| Conducted Emissions Test | $\pm 2.0\text{dB}$ |
| Radiated Emission Test | $\pm 2.0\text{dB}$ |
| Power Density | $\pm 2.0\text{dB}$ |
| Occupied Bandwidth Test | $\pm 1.0\text{dB}$ |
| Band Edge Test | $\pm 3\text{dB}$ |
| All emission, radiated | $\pm 3\text{dB}$ |
| Antenna Port Emission | $\pm 3\text{dB}$ |
| Temperature | $\pm 0.5^\circ\text{C}$ |
| Humidity | $\pm 3\%$ |

Measurement Uncertainty for a level of Confidence of 95%

7 SETUP OF EQUIPMENT UNDER TEST

7.1 RADIO FREQUENCY TEST SETUP 1

The WLAN component's antenna ports(s) of the EUT are connected to the measurement instrument per an appropriate attenuator. The EUT is controlled by PC/software to emit the specified signals for the purpose of measurements.

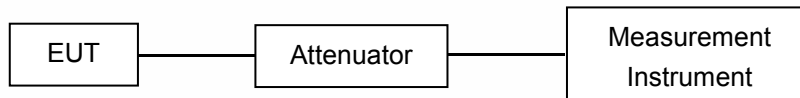

7.2 RADIO FREQUENCY TEST SETUP 2

The test site semi-anechoic chamber has met the requirement of NSA tolerance 4 dB according to the standards: ANSI C63.10. The test distance is 3m. The setup is according to the requirements in Section 13.1.4.1 of ANSI C63.10-2013 and CAN/CSA-CEI/IEC CISPR 22.

The maximal emission value is acquired by adjusting the antenna height, polarisation and turntable azimuth. Normally, the height range of antenna is 1 m to 4 m, the azimuth range of turntable is 0° to 360°, and the receive antenna has two polarizations Vertical (V) and Horizontal (H).

Below 30MHz:

The EUT is placed on a turntable 0.8 meters above the ground in the chamber, 3 meter away from the antenna (loop antenna). The Antenna should be positioned with its plane vertical at the specified distance from the EUT and rotated about its vertical axis for maximum response at each azimuth about the EUT. The center of the loop shall be 1 m above the ground. For certain applications, the loop antenna plane may also need to be positioned horizontally at the specified distance from the EUT.

Above 30MHz:

The EUT is placed on a turntable 0.8 meters above the ground in the chamber, 3 meter away from the antenna. The maximal emission value is acquired by adjusting the antenna height, polarisation and turntable azimuth. Normally, the height range of antenna is 1 m to 4 m, the azimuth range of turntable is 0° to 360°, and the receive antenna has two polarizations Vertical (V) and Horizontal (H).

Above 1GHz:

The EUT is placed on a turntable 1.5 meters above the ground in the chamber, 3 meter away from the antenna. The maximal emission value is acquired by adjusting the antenna height, polarisation and turntable azimuth. Normally, the height range of antenna is 1 m to 4 m, the azimuth range of turntable is 0° to 360°, and the receive antenna has two polarizations Vertical (V) and Horizontal (H).

Measurements shall be taken, using the following steps, at a test site that has been validated using the procedures of ANSI C63.4 or the latest CISPR 16-1-4 for measurements above 1 GHz, so as to simulate a near free-space environment (see RSS-Gen for applicable versions of ANSI and CISPR standards).

- (1) Line the ground plane with absorbers between the transmitter and the receive antenna to minimize reflections. The absorbers used should have a minimum-rated attenuation of 20 dB through the measurement frequency range of interest. The absorbers shall be positioned to replicate the layout used when compliance with the applicable acceptability criterion was achieved, as set forth in the aforementioned standards on site validation.
- (2) Set the height of the receive antenna to 1.5 m. The receive antenna must be one that was designed and fabricated to operate over the entire frequency range of interest, for example, an appropriate standard gain horn.
- (3) The distance between the receive antenna and the radiating source shall be sufficient in order to ensure far-field conditions.
- (4) Mount the transmitter at a height of 1.5 m.
- (5) Configure the device under test (DUT) to produce the maximum power spectral density as measured while assessing compliance with Section 6.2.2 (i.e. channel frequency, modulation type and data rate). If the DUT is equipped with a detachable antenna and the antenna is intended for remote installation (i.e.

tower-mounted), the DUT may be substituted with a suitable signal generator. The level and frequency settings on the generator shall be set so as to reproduce the maximum power spectral density, measured within a 1 MHz bandwidth, obtained while assessing compliance to Section 6.2.2.

(6) Position the transmitter or the radiating antenna so that elevation pattern measurements can be taken.

(7) Find the 0° reference point in the horizontal plane.

(8) Care should be taken when positioning the receive antenna to avoid cross-polarization. Antennas of known mounting polarization should be assessed with the receive antenna oriented in the same polarity. If the polarization of the transmit antenna is unknown or the transmit antenna can be mounted in either polarization, e.i.r.p. measurements should be performed to find which mounting polarity provides the highest e.i.r.p. value. Testing shall be carried out with the receive antenna and the DUT mounted in each polarity.

(9) The emission shall be centred on the display of the spectrum analyzer with the following settings:

i. If the power spectral density of the DUT was assessed with a peak detector and the antenna cannot be detached from the DUT, the spectrum analyzer shall be set to a peak detector with a resolution bandwidth and video bandwidth of 1 MHz.

ii. If the power spectral density of the DUT was assessed using a sample detector with power averaging and the antenna cannot be detached from the DUT, the spectrum analyzer shall be set to a sample detector, configured to produce 100 power averages and set with a resolution bandwidth, as well as a video bandwidth of 1 MHz.

iii. If the antenna can be detached from the DUT, a continuous wave (CW) signal equal to that of the power spectral density measurement may be used, the spectrum analyzer shall be set to peak detector with a resolution bandwidth and video bandwidth of 1 MHz.

(10) Rotate the turntable 360° recording the field strength at each step. Throughout the main beam of the antenna, the step size shall be kept to a maximum of 1°.

Once outside the main beam of the antenna, the maximum step size shall be as follows, when compared to the requirements of Section 6.2.2:

i. Between 0° and 8°, maximum step size of 2°;

ii. Between 8° and 40°, maximum step size of 4°;

iii. Between 40° and 45°, maximum step size of 1°;

iv. Between 45° and 90°, maximum step size of 5°.

Once the mask reaches 90°, the mask will be inverted and the step size will follow in the same manner as above.

For the purpose of this procedure, the main beam of the antenna is defined as the 3 dB beamwidth.

(11) Convert the measured field strength values in terms of e.i.r.p. density (dBW/1 MHz) using the following equation:

$$\text{e.i.r.p. density (dBW/MHz)} = 10 \log((E \cdot r)^2 / 30)$$

E = field strength in V/m

r = measurement distance in metres

(12) Plot the results against the emission mask with reference to the horizontal plane.

(13) Using the plot, the 0° can be rotated to determine the worst-case installation tilt angle.

(14) Testing shall be performed using the highest gain antenna for every antenna type, if applicable.

(15) Antenna type(s), antenna model number(s), and worst-case tilt angle(s) necessary to remain compliant with the elevation mask requirement set forth in Section 6.2.2(3) of RSS-247 shall be clearly indicated in the user manual.

The following figure is an example of a polar elevation mask measured using the Method 1 reference to dBμV/m at 3 m.

(a) Radiated Emission Test Set-Up, Frequency Below 30MHz

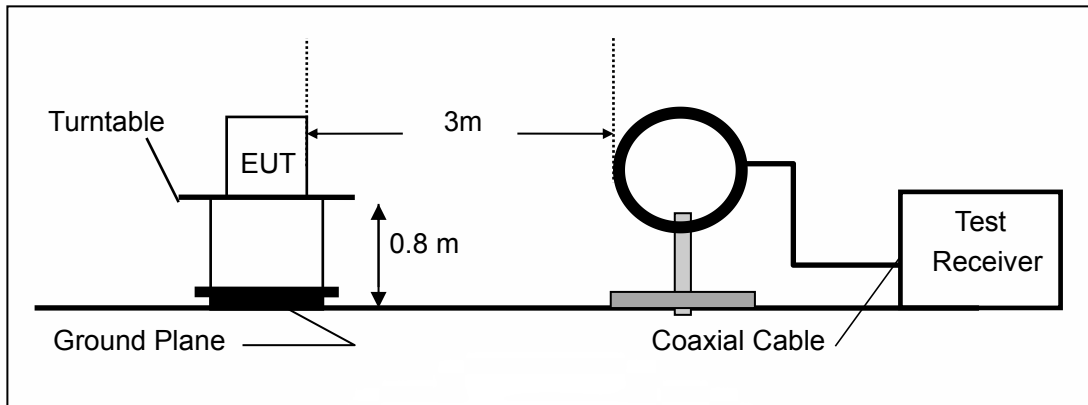

(b) Radiated Emission Test Set-Up, Frequency Below 1000MHz

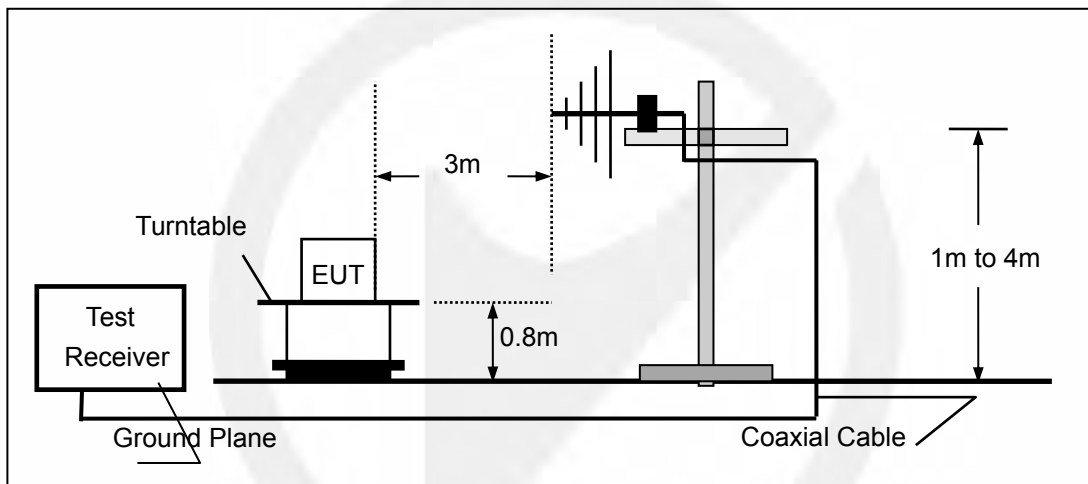

(c) Radiated Emission Test Set-Up, Frequency above 1000MHz

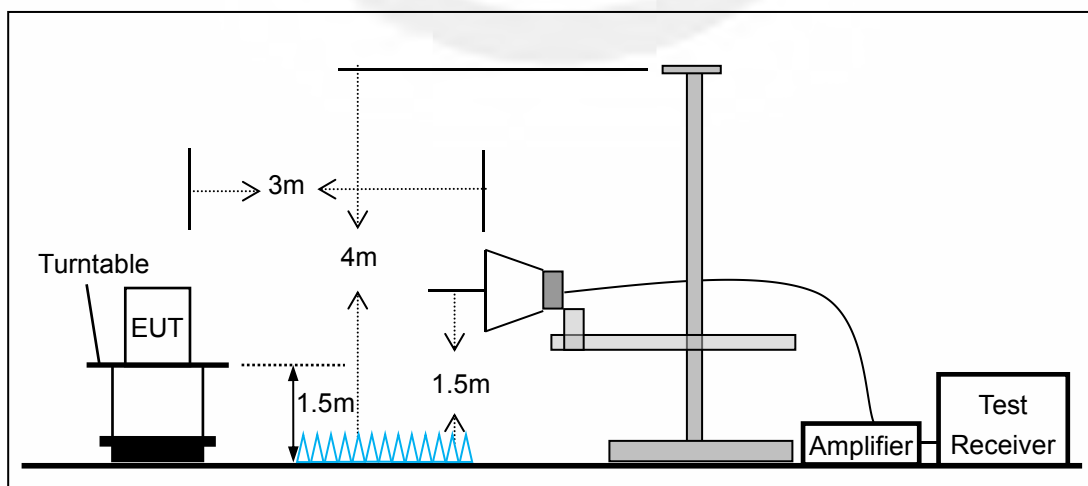

7.3 CONDUCTED EMISSION TEST SETUP

The mains cable of the EUT (maybe per AC/DC Adapter) must be connected to LISN. The LISN shall be placed 0.8 m from the boundary of EUT and bonded to a ground reference plane for LISN mounted on top of the ground reference plane. This distance is between the closest points of the LISN and the EUT. All other units of the EUT and associated equipment shall be at least 0.8m from the LISN.

Ground connections, where required for safety purposes, shall be connected to the reference ground point of the LISN and, where not otherwise provided or specified by the manufacturer, shall be of same length as the mains cable and run parallel to the mains connection at a separation distance of not more than 0.8 m.

According to the requirements in Section 13.1.4.1 of ANSI C63.10-2013 Conducted emissions from the EUT measured in the frequency range between 0.15 MHz and 30 MHz using CISPR Quasi-Peak and average detector mode.

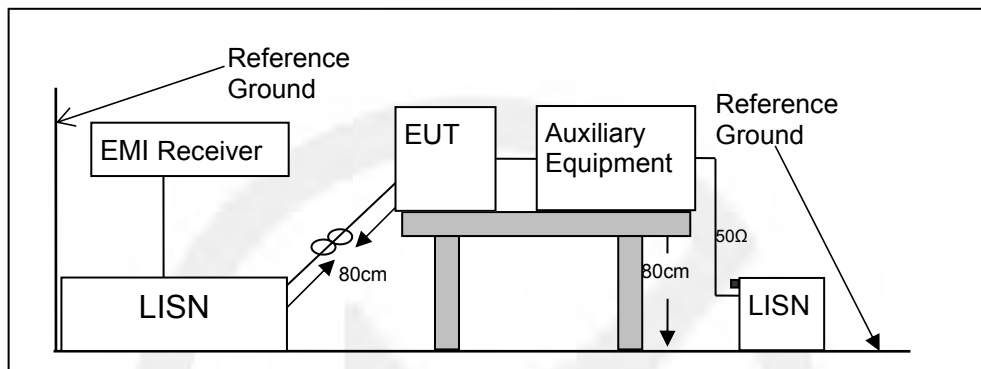

7.4 BLOCK DIAGRAM CONFIGURATION OF TEST SYSTEM

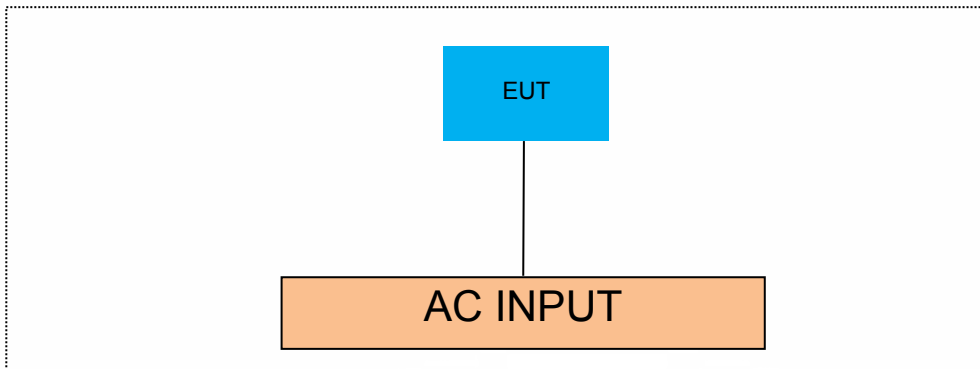

7.5 SUPPORT EQUIPMENT

| EUT Cable List and Details | | | |
|----------------------------|------------|---------------------|------------------------|
| Cable Description | Length (m) | Shielded/Unshielded | With / Without Ferrite |
| / | / | / | / |

| Auxiliary Cable List and Details | | | |
|----------------------------------|------------|---------------------|------------------------|
| Cable Description | Length (m) | Shielded/Unshielded | With / Without Ferrite |
| USB line | 0.6 | / | / |

| Auxiliary Equipment List and Details | | | |
|--------------------------------------|--------------|-------|------------------------|
| Description | Manufacturer | Model | Serial Number |
| Notebook | Lenovo | E46L | 11S168003748Z0LR06E0HG |
| Adaptor | Apple | / | / |
| / | / | / | / |

Notes:

1. All the equipment/cables were placed in the worst-case configuration to maximize the emission during the test.
2. Grounding was established in accordance with the manufacturer's requirements and conditions for the intended use.

8 TEST REQUIREMENTS

8.1 DTS 6DB BANDWIDTH

8.1.1 Applicable Standard

According to FCC Part15.247 (a)(2) and KDB 558074 D01 15.247 Meas Guidance v05r02

8.1.2 Conformance Limit

The minimum -6 dB bandwidth shall be at least 500 kHz.

8.1.3 Test Configuration

Test according to clause 6.1 radio frequency test setup

8.1.4 Test Procedure

The EUT was operating in WIFI mode and controlled its channel. Printed out the test result from the spectrum by hard copy function.

The RF output of EUT was connected to the spectrum analyzer by RF cable and attenuator. The path loss was compensated to the results for each measurement.

Set to the maximum power setting and enable the EUT transmit continuously

Set RBW = 100 kHz.

Set the video bandwidth (VBW) =300 kHz.

Set Span=2 times OBW

Set Detector = Peak.

Set Trace mode = max hold.

Set Sweep = auto couple.

Allow the trace to stabilize.

Measure the maximum width of the emission that is constrained by the frequencies associated with the two outermost amplitude points (upper and lower frequencies) that are attenuated by 6 dB relative to the maximum level measured in the fundamental emission.

Measure and record the results in the test report.

8.1.5 Test Results

| | |
|--------------------|-----------|
| Temperature: | 25°C |
| Relative Humidity: | 45% |
| ATM Pressure: | 1011 mbar |

Note: N/A

| TestMode | Antenna | Frequency[MHz] | DTS BW [MHz] | FL[MHz] | FH[MHz] | Limit[MHz] | Verdict |
|-----------|---------|----------------|--------------|----------|----------|------------|---------|
| 11B | Ant1 | 2412 | 13.040 | 2405.520 | 2418.560 | 0.5 | PASS |
| 11B | Ant1 | 2437 | 13.040 | 2430.480 | 2443.520 | 0.5 | PASS |
| 11B | Ant1 | 2462 | 13.080 | 2455.520 | 2468.600 | 0.5 | PASS |
| 11G | Ant1 | 2412 | 16.360 | 2403.880 | 2420.240 | 0.5 | PASS |
| 11G | Ant1 | 2437 | 16.320 | 2428.880 | 2445.200 | 0.5 | PASS |
| 11G | Ant1 | 2462 | 16.360 | 2453.880 | 2470.240 | 0.5 | PASS |
| 11N20SISO | Ant1 | 2412 | 17.520 | 2403.280 | 2420.800 | 0.5 | PASS |
| 11N20SISO | Ant1 | 2437 | 16.320 | 2428.880 | 2445.200 | 0.5 | PASS |
| 11N20SISO | Ant1 | 2462 | 17.360 | 2453.440 | 2470.800 | 0.5 | PASS |







11G-Ant1-2437



11G-Ant1-2462



11N20SISO-Ant1-2412



11N20SISO-Ant1-2437



8.2 DTS 99% BANDWIDTH

8.2.1 Applicable Standard

According to RSS-Gen 6.7 and KDB 558074 D01 DTS Meas Guidance v05r02

8.2.2 Test Configuration

Test according to clause 7.1 radio frequency test setup 1

8.2.3 Test Procedure

The EUT was operating in Bluetooth mode and controlled its channel. Printed out the test result from the spectrum by hard copy function.

The RF output of EUT was connected to the spectrum analyzer by RF cable and attenuator. The path loss was compensated to the results for each measurement.

Set to the maximum power setting and enable the EUT transmit continuously

Set RBW = 1%-5% OBW.

Set the video bandwidth (VBW) $\geq 3 \times \text{RBW}$.

Set Span=approximately 2 to 3 times the 20 dB bandwidth.

Set Detector = Peak.

Set Trace mode = max hold.

Set Sweep = auto couple.

Allow the trace to stabilize.

Use the 99 % power bandwidth function of the instrument

Measure the maximum width of the emission.

If this value varies with different modes of operation (e.g., data rate, modulation format, etc.), repeat this test for each variation.

Measure and record the results in the test report.

8.2.4 Test Results

| | |
|--------------------|-----------|
| Temperature: | 25°C |
| Relative Humidity: | 45% |
| ATM Pressure: | 1011 mbar |

Note: N/A

| TestMode | Antenna | Channel Frequency[MHz] | OCB [MHz] | FL[MHz] | FH[MHz] | Limit[MHz] | Verdict |
|-----------|---------|------------------------|-----------|-----------|-----------|------------|---------|
| 11B | Ant1 | 2412 | 16.696 | 2403.7111 | 2420.4071 | --- | --- |
| 11B | Ant1 | 2437 | 16.725 | 2428.6715 | 2445.3965 | --- | --- |
| 11B | Ant1 | 2462 | 16.675 | 2453.7285 | 2470.4035 | --- | --- |
| 11G | Ant1 | 2412 | 16.939 | 2403.5343 | 2420.4733 | --- | --- |
| 11G | Ant1 | 2437 | 16.939 | 2428.5989 | 2445.5379 | --- | --- |
| 11G | Ant1 | 2462 | 17.004 | 2453.5692 | 2470.5732 | --- | --- |
| 11N20SISO | Ant1 | 2412 | 17.740 | 2403.1950 | 2420.9350 | --- | --- |
| 11N20SISO | Ant1 | 2437 | 17.033 | 2428.5294 | 2445.5624 | --- | --- |
| 11N20SISO | Ant1 | 2462 | 17.748 | 2453.1895 | 2470.9375 | --- | --- |



11B-Ant1-2412



11B-Ant1-2437





11G-Ant1-2437



11G-Ant1-2462



11N20SISO-Ant1-2412



11N20SISO-Ant1-2437



8.3 MAXIMUM PEAK CONDUCTED OUTPUT POWER

8.3.1 Applicable Standard

According to FCC Part15.247 (b)(3) and KDB 558074 D01 15.247 Meas Guidance v05r02

8.3.2 Conformance Limit

The maximum conducted output power of the intentional radiator for systems using digital modulation in the 2400 - 2483.5 MHz bands shall not exceed: 1 Watt (30dBm).

8.3.3 Test Configuration

Test according to clause 6.1 radio frequency test setup

8.3.4 Test Procedure

- a) Set span to at least 1.5 times the OBW.
- b) Set RBW = 1-5% of the OBW, not to exceed 1 MHz.
- c) Set VBW $\geq 3 \times$ RBW.
- d) Number of points in sweep $\geq 2 \times$ span / RBW. (This gives bin-to-bin spacing \leq RBW/2, so that narrowband signals are not lost between frequency bins.)
- e) Sweep time = auto.
- f) Detector = RMS (i.e., power averaging), if available. Otherwise, use sample detector mode.
- g) If transmit duty cycle < 98 %, use a sweep trigger with the level set to enable triggering only on full power pulses. The transmitter shall operate at maximum power control level for the entire duration of every sweep. If the EUT transmits continuously (i.e., with no off intervals) or at duty cycle ≥ 98 %, and if each transmission is entirely at the maximum power control level, then the trigger shall be set to “free run” .
- h) Trace average at least 100 traces in power averaging (i.e., RMS) mode.
- i) Compute power by integrating the spectrum across the OBW of the signal using the instrument’s band power measurement function, with band limits set equal to the OBW band edges. If the instrument does not have a band power function, sum the spectrum levels (in power units) at intervals equal to the RBW extending across the entire OBW of the spectrum.

■ According to FCC Part 15.247(b)(4):

Conducted output power limit specified in paragraph (b) of this section is based on the use of antennas with directional gains that do not exceed 6 dBi. If transmitting antennas of directional gain greater than 6 dBi are used, the conducted output power from the intentional radiator shall be reduced below the stated values in paragraphs (b)(3) of this section, as appropriate, by the amount in dB that the directional gain of the antenna exceeds 6 dBi.

Note: If antenna Gain exceeds 6 dBi, then Output power Limit=30-(Gain- 6)

8.3.5 Test Results

| | |
|--------------------|-----------|
| Temperature: | 25 °C |
| Relative Humidity: | 45% |
| ATM Pressure: | 1011 mbar |

Note: N/A

| TestMode | Antenna | Frequency[MHz] | Set Power | Conducted Power[dBm] | Conducted Limit[dBm] | EIRP [dBm] | EIRP Limit[dBm] | Verdict |
|---------------|---------|----------------|-----------|----------------------|----------------------|------------|-----------------|---------|
| 11B | Ant1 | 2412 | 7 | 4.97 | ≤30.00 | 4.97 | ≤36.00 | PASS |
| 11B | Ant1 | 2437 | 7 | 4.57 | ≤30.00 | 4.57 | ≤36.00 | PASS |
| 11B | Ant1 | 2462 | 7 | 4.87 | ≤30.00 | 4.87 | ≤36.00 | PASS |
| 11G | Ant1 | 2412 | 7 | 5.50 | ≤30.00 | 5.50 | ≤36.00 | PASS |
| 11G | Ant1 | 2437 | 7 | 5.23 | ≤30.00 | 5.23 | ≤36.00 | PASS |
| 11G | Ant1 | 2462 | 7 | 5.43 | ≤30.00 | 5.43 | ≤36.00 | PASS |
| 11N20SIS O | Ant1 | 2412 | 7 | 5.41 | ≤30.00 | 5.41 | ≤36.00 | PASS |
| 11N20SIS O | Ant1 | 2437 | 7 | 5.24 | ≤30.00 | 5.24 | ≤36.00 | PASS |
| 11N20SIS O | Ant1 | 2462 | 7 | 5.37 | ≤30.00 | 5.37 | ≤36.00 | PASS |



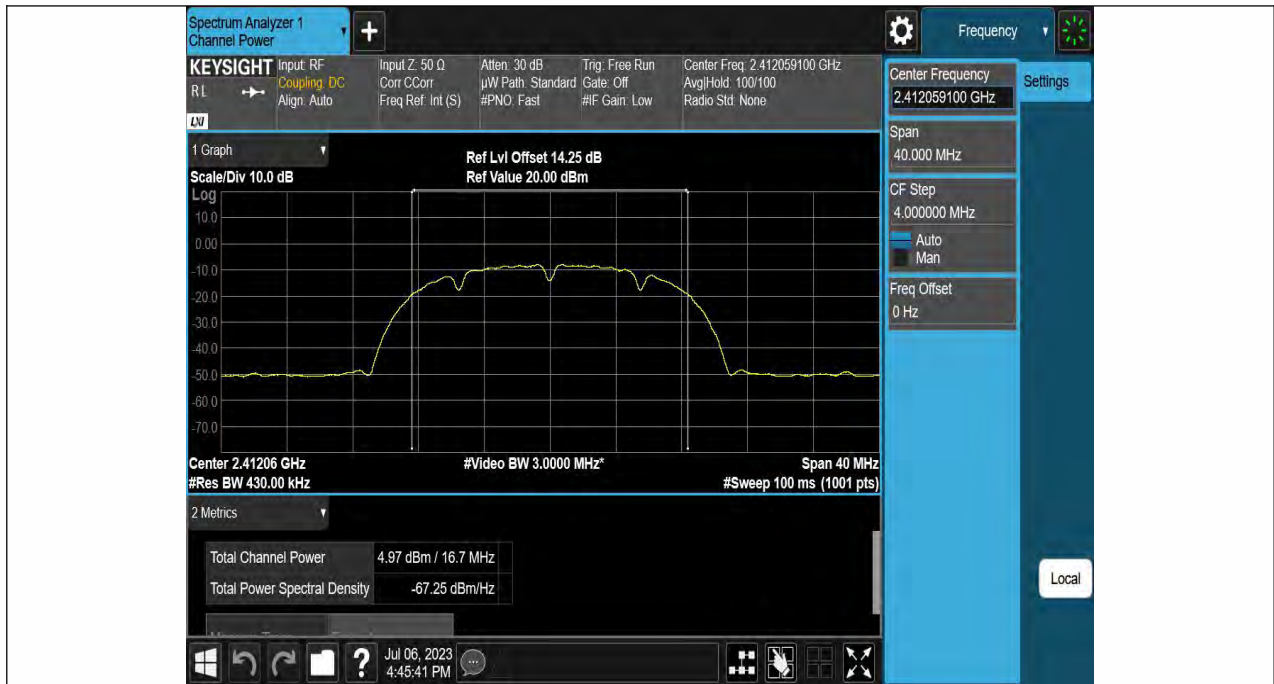

11B-Ant1-2412

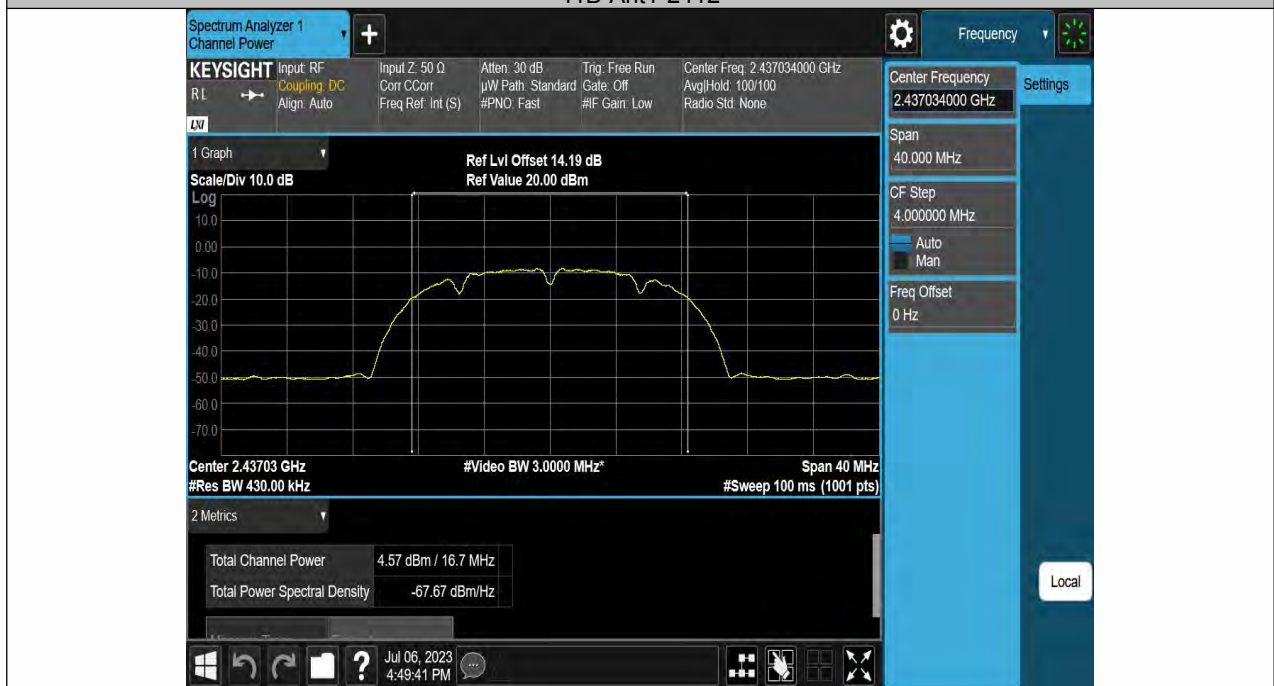

11B-Ant1-2437

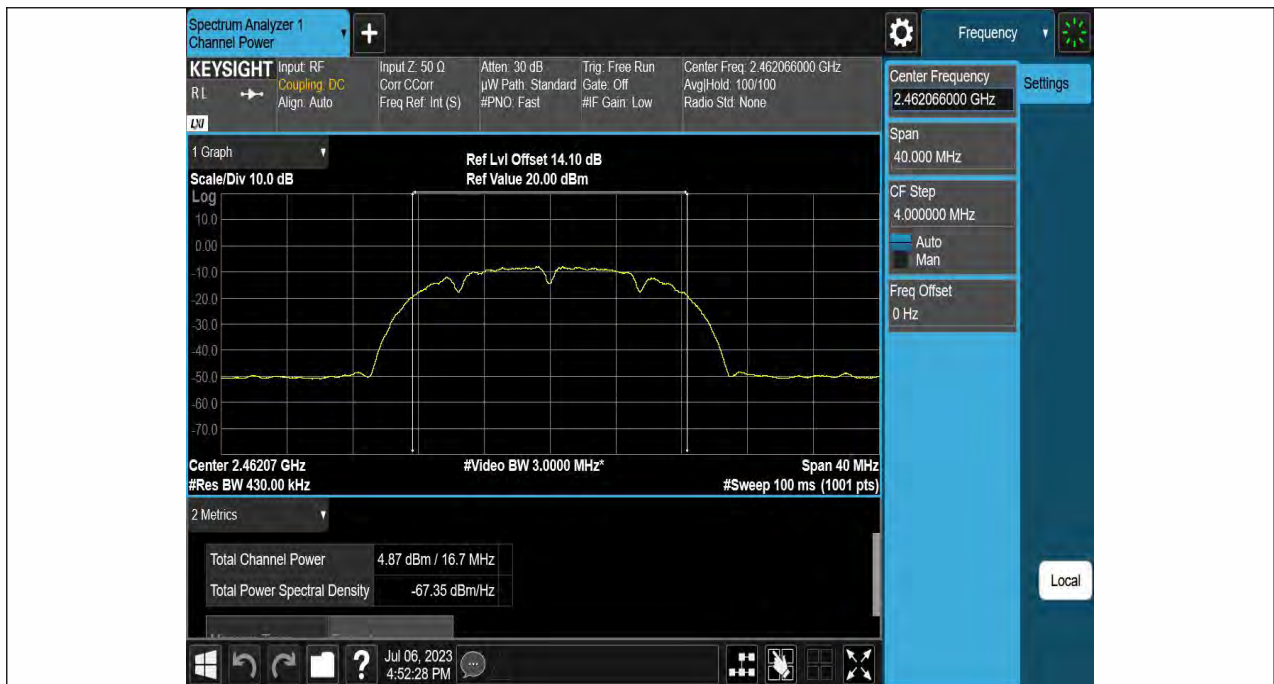

11B-Ant1-2462

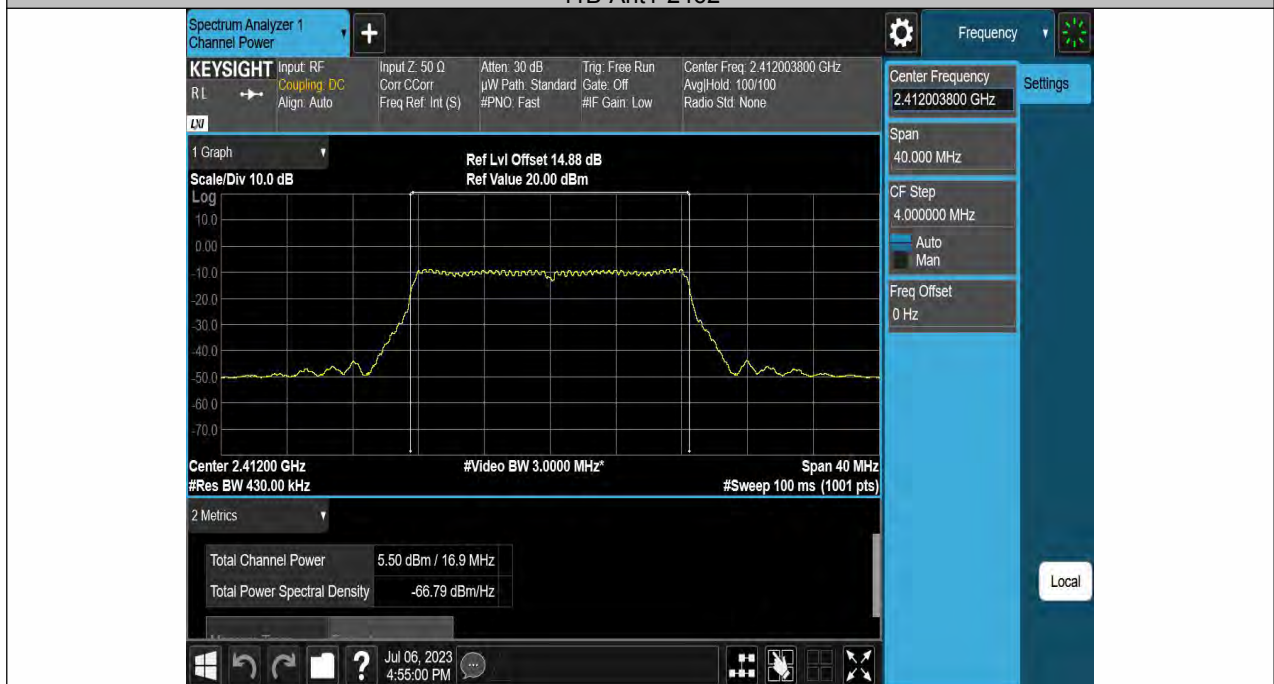

11G-Ant1-2412

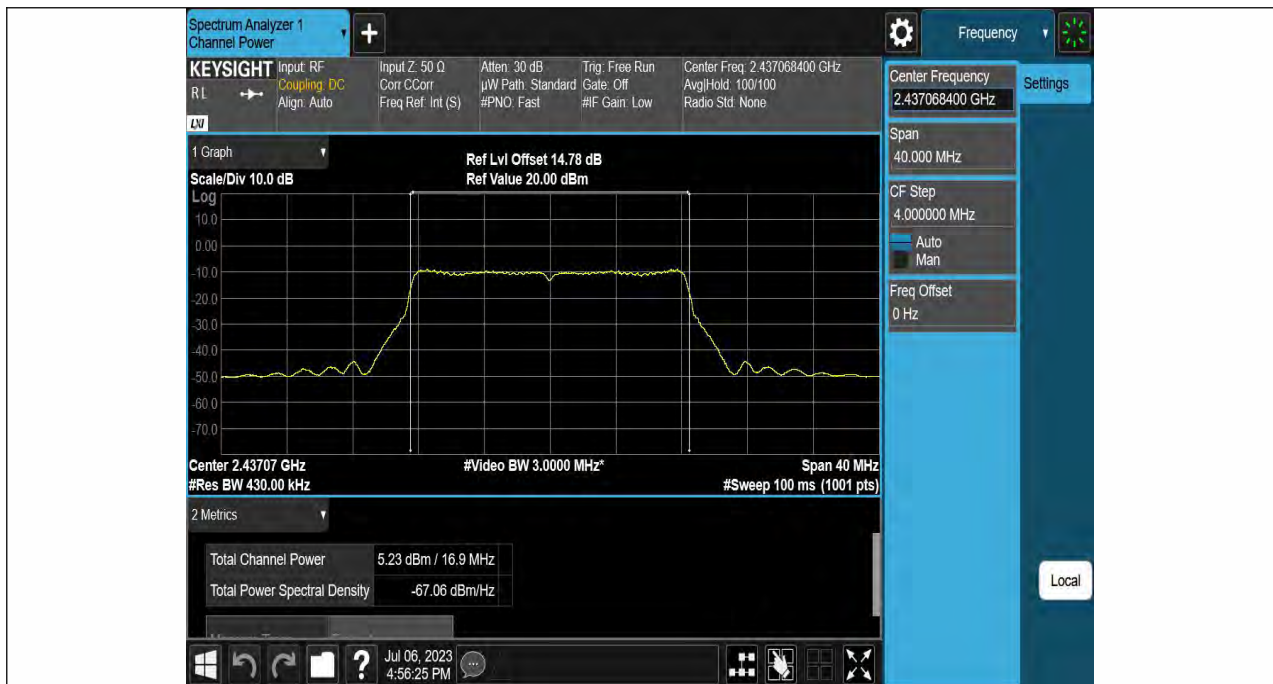

11G-Ant1-2437

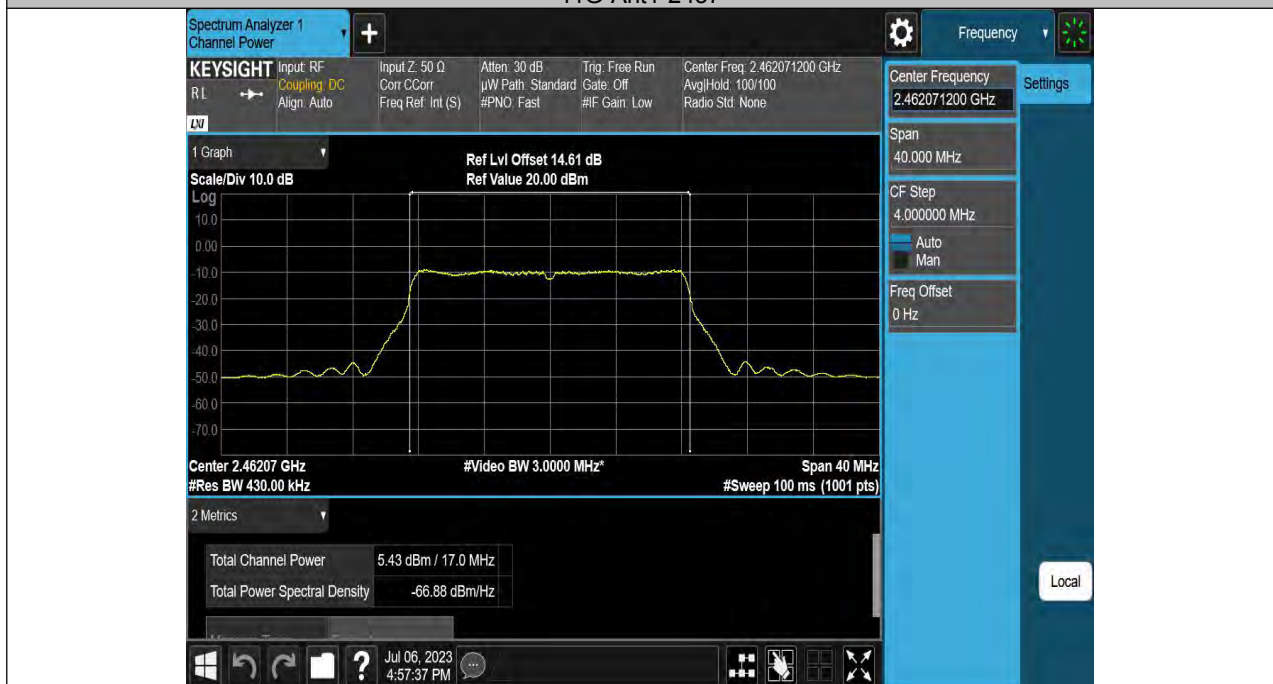

11G-Ant1-2462

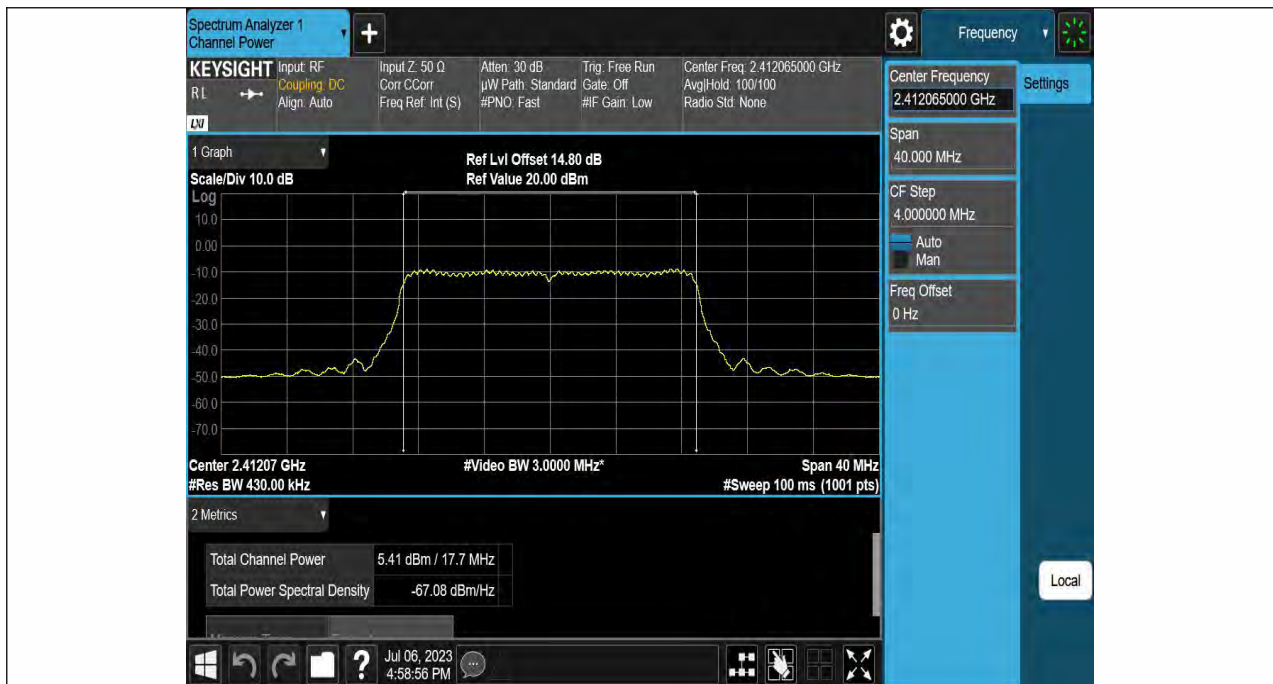

11N20SISO-Ant1-2412

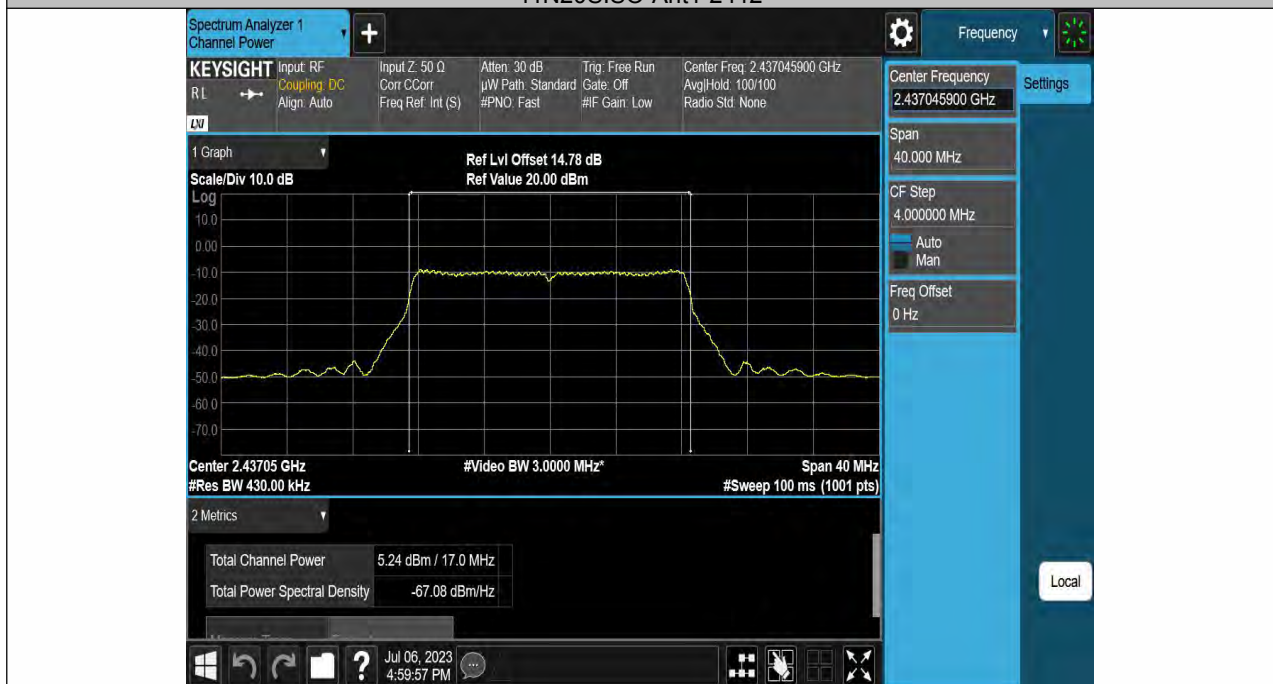

11N20SISO-Ant1-2437

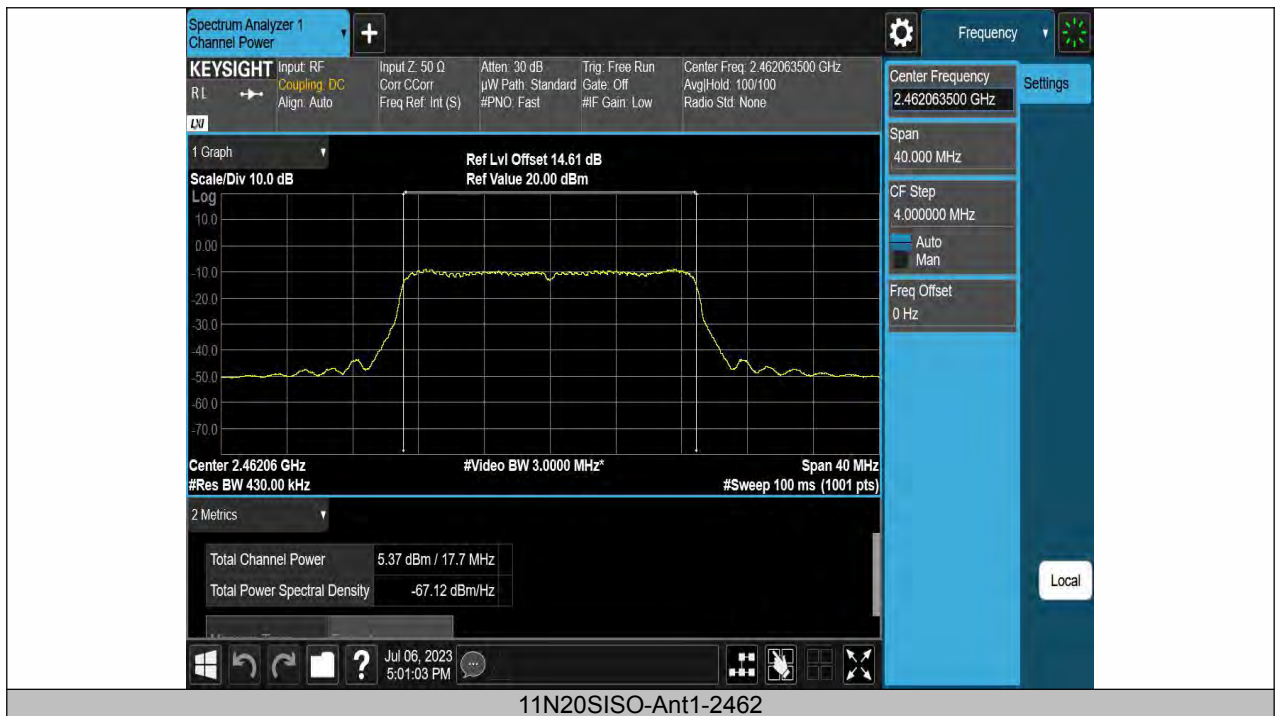

8.4 MAXIMUM POWER SPECTRAL DENSITY

8.4.1 Applicable Standard

According to FCC Part15.247(e) and KDB 558074 D01 15.247 Meas Guidance v05r02

8.4.2 Conformance Limit

The transmitter power spectral density conducted from the transmitter to the antenna shall not be greater than 8 dBm in any 3 kHz band during any time interval of continuous transmission. This power spectral density shall be determined in accordance with the provisions of section 5.4(d), (i.e. the power spectral density shall be determined using the same method as is used to determine the conducted output power).

8.4.3 Test Configuration

Test according to clause 6.1 radio frequency test setup

8.4.4 Test Procedure

This procedure shall be used if maximum peak conducted output power was used to demonstrate compliance

The transmitter output (antenna port) was connected to the spectrum analyzer

Set analyzer center frequency to DTS channel center frequency.

Set the span to 1.5 times the DTS bandwidth.

Set the RBW to: 3 kHz

Set the VBW to: 10 kHz.

Set Detector = RMS.

Set Sweep time = auto couple.

Set Trace mode = max hold.

Allow trace to fully stabilize.

Use the peak marker function to determine the maximum amplitude level within the RBW.

8.4.5 Test Results

| | |
|--------------------|-----------|
| Temperature: | 25 °C |
| Relative Humidity: | 45% |
| ATM Pressure: | 1011 mbar |

Note: N/A

| TestMode | Antenna | Frequency[MHz] | Result[dBm/3-100kHz] | Limit[dBm/3kHz] | Verdict |
|-----------|---------|----------------|----------------------|-----------------|---------|
| 11B | Ant1 | 2412 | -25.92 | ≤8.00 | PASS |
| 11B | Ant1 | 2437 | -26.27 | ≤8.00 | PASS |
| 11B | Ant1 | 2462 | -25.81 | ≤8.00 | PASS |
| 11G | Ant1 | 2412 | -25.83 | ≤8.00 | PASS |
| 11G | Ant1 | 2437 | -25.75 | ≤8.00 | PASS |
| 11G | Ant1 | 2462 | -26.06 | ≤8.00 | PASS |
| 11N20SISO | Ant1 | 2412 | -26.32 | ≤8.00 | PASS |
| 11N20SISO | Ant1 | 2437 | -26 | ≤8.00 | PASS |
| 11N20SISO | Ant1 | 2462 | -25.9 | ≤8.00 | PASS |



11B-Ant1-2412



11B-Ant1-2437



11B-Ant1-2462



11G-Ant1-2412



11G-Ant1-2437



11G-Ant1-2462

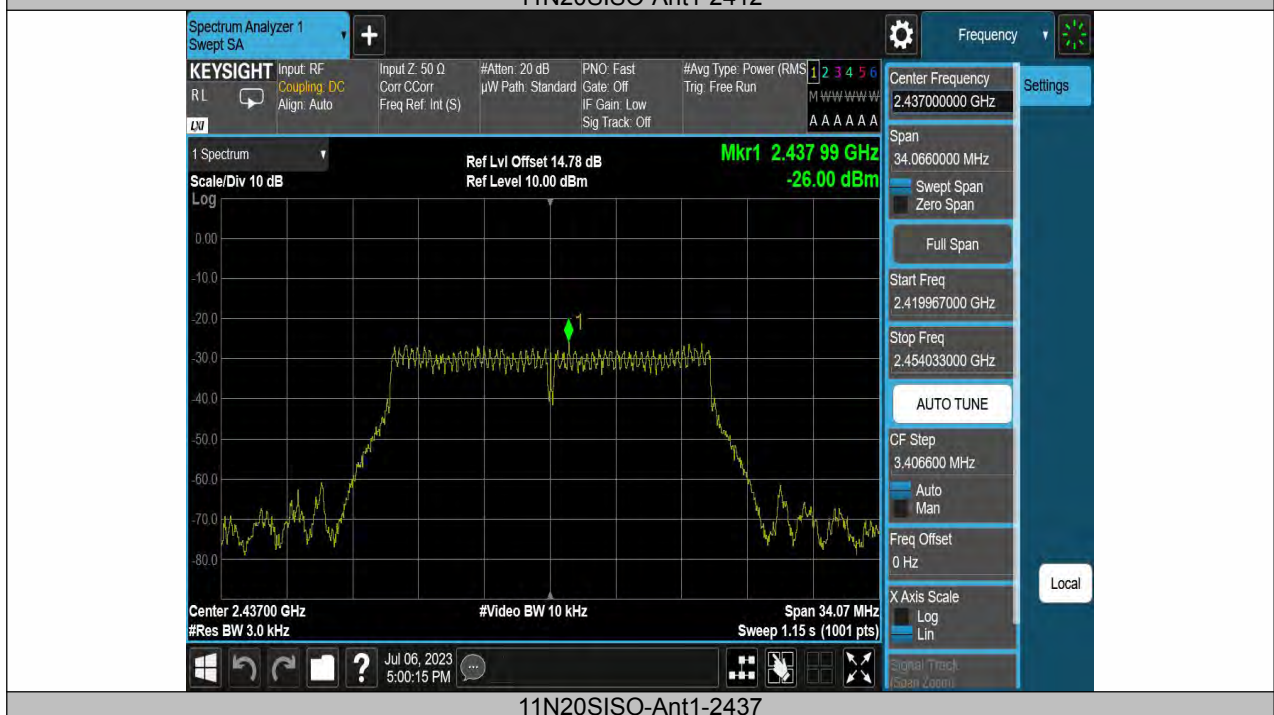



8.5 UNWANTED EMISSIONS IN NON-RESTRICTED FREQUENCY BANDS

8.5.1 Applicable Standard

According to FCC Part 15.247(d) and KDB 558074 D01 15.247 Meas Guidance v05r02

8.5.2 Conformance Limit

According to FCC Part 15.247(d):

In any 100 kHz bandwidth outside the frequency band in which the spread spectrum or digitally modulated device is operating, the RF power that is produced shall be at least 20 dB below that in the 100 kHz bandwidth within the band that contains the highest level of the desired power, based on either an RF conducted or a radiated measurement, provided that the transmitter demonstrates compliance with the peak conducted power limits. If the transmitter complies with the conducted power limits based on the use of root-mean-square averaging over a time interval, as permitted under section 5.4(d), the attenuation required shall be 30 dB instead of 20 dB. Attenuation below the general field strength limits specified in RSS-Gen is not required.

8.5.3 Test Configuration

Test according to clause 6.1 radio frequency test setup

8.5.4 Test Procedure

The transmitter output (antenna port) was connected to the spectrum analyzer

■ Reference level measurement

Establish a reference level by using the following procedure:

Set instrument center frequency to DTS channel center frequency.

Set the span to ≥ 1.5 times the DTS bandwidth.

Set the RBW = 100 kHz.

Set the VBW $\geq 3 \times$ RBW.

Set Detector = peak.

Set Sweep time = auto couple.

Set Trace mode = max hold.

Allow trace to fully stabilize.

Use the peak marker function to determine the maximum PSD level.

Note that the channel found to contain the maximum PSD level can be used to establish the reference level.

■ Band-edge measurement

Use the following spectrum analyzer settings:

Span = wide enough to capture the peak level of the emission operating on the channel closest to the band-edge, as well as any modulation products which fall outside of the authorized band of operation

Set RBW $\geq 1\%$ of the span=100kHz Set VBW $\geq 3 \times$ RBW

Set Sweep = auto Set Detector function = peak Set Trace = max hold

Allow the trace to stabilize. Set the marker on the emission at the bandedge, or on the highest modulation product outside of the band, if this level is greater than that at the bandedge. Enable the marker-delta function, then use the marker-to-peak function to move the marker to the peak of the in-band emission. The marker-delta value now displayed must comply with the limit specified in this Section.

■ Emission level measurement

Set the center frequency and span to encompass frequency range to be measured.

Set the RBW = 100 kHz.

Set the VBW = 300 kHz.

Set Detector = peak

Sweep time = auto couple.

Trace mode = max hold.

Allow trace to fully stabilize.

Use the peak marker function to determine the maximum amplitude level.

Ensure that the amplitude of all unwanted emissions outside of the authorized frequency band (excluding restricted frequency bands) are attenuated by at least the minimum requirements. Report the three highest emissions relative to the limit.

8.5.5 Test Results

| | |
|--------------------|-----------|
| Temperature: | 25 °C |
| Relative Humidity: | 45% |
| ATM Pressure: | 1011 mbar |

Note: N/A

All modes have been tested, and the worst result recorded was report as below:

Reference level measurement:

| TestMode | Antenna | Freq(MHz) | Max.Point[MHz] | Result[dBm] |
|----------|---------|-----------|----------------|-------------|
| 11B | Ant1 | 2412 | 2411.04 | -6.75 |
| 11B | Ant1 | 2437 | 2436.04 | -7.18 |
| 11B | Ant1 | 2462 | 2461.06 | -6.82 |





11B-Ant1-2437



11B-Ant1-2462

Band edge measurements:

| TestMode | Antenna | ChName | Frequency[MHz] | RefLevel[dBm] | Result[dBm] | Limit[dBm] | Verdict |
|----------|---------|--------|----------------|---------------|-------------|------------|---------|
| 11B | Ant1 | Low | 2412 | -6.75 | -45.69 | ≤-36.75 | PASS |
| 11B | Ant1 | High | 2462 | -6.82 | -47.63 | ≤-36.82 | PASS |

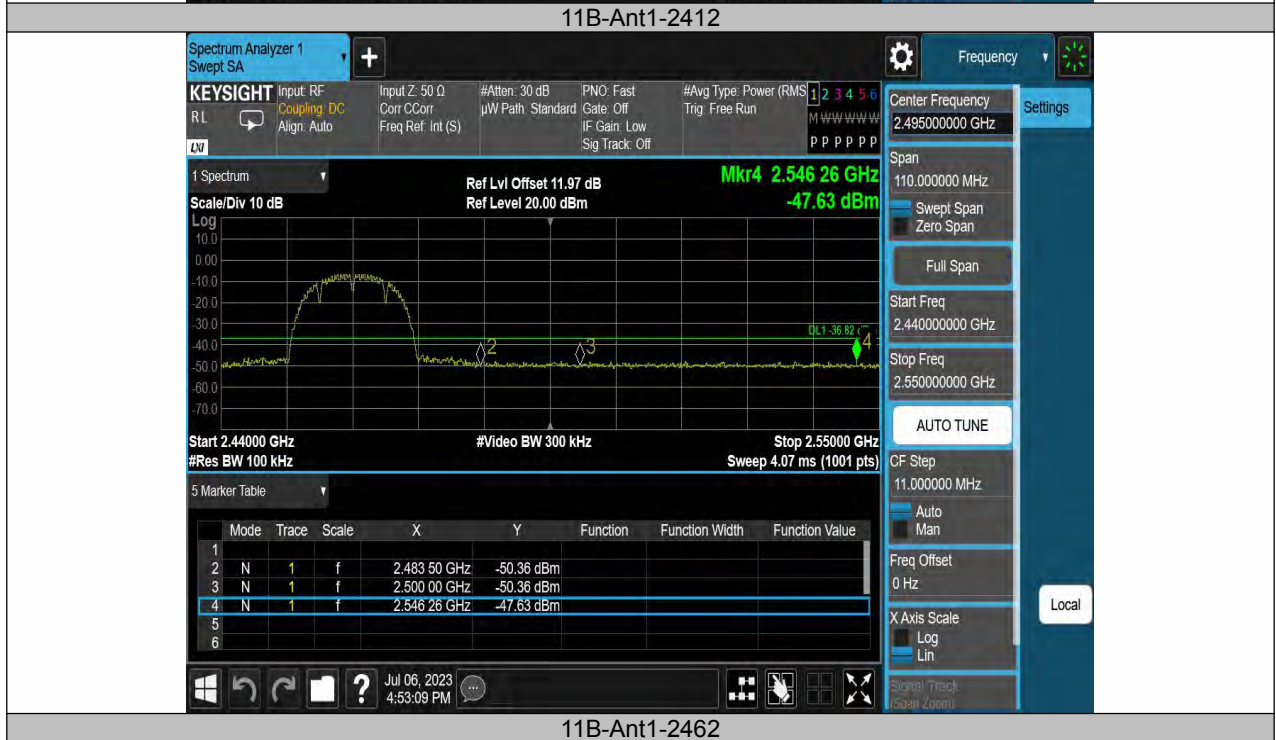
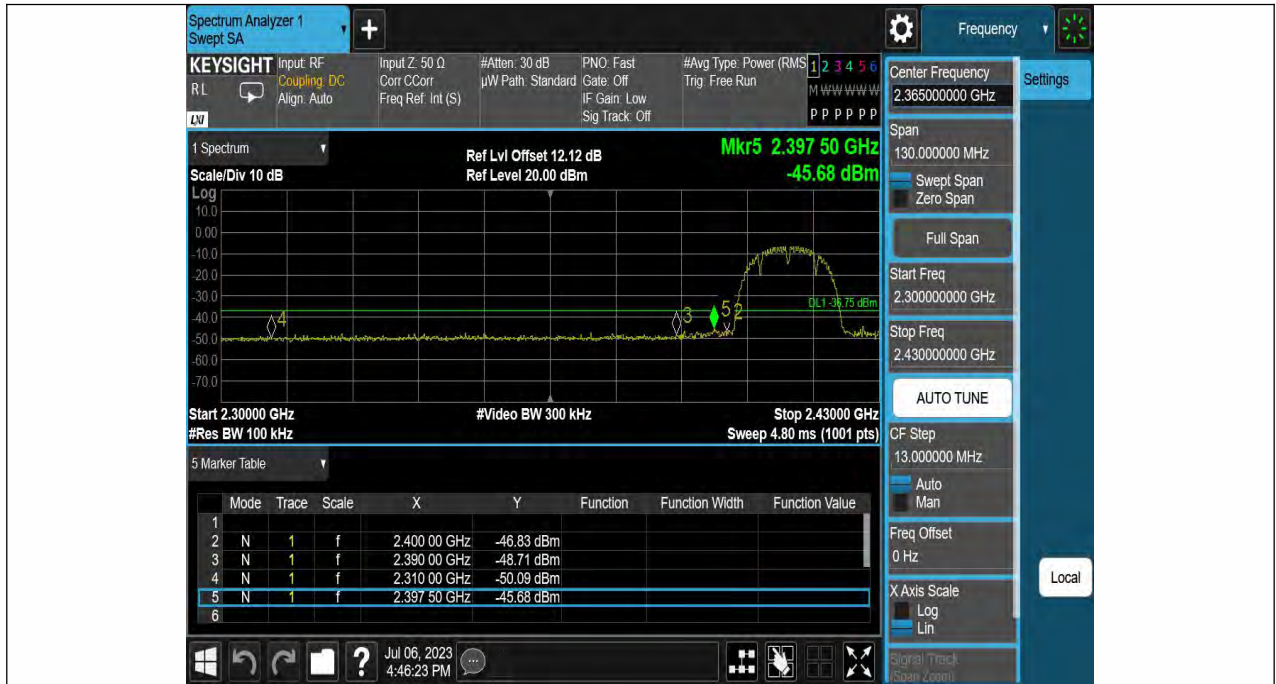

Conducted Spurious Emission:

| TestMode | Antenna | Frequency[MHz] | FreqRange [Mhz] | RefLevel [dBm] | Result [dBm] | Limit [dBm] | Verdict |
|----------|---------|----------------|-----------------|----------------|--------------|-------------|---------|
| 11B | Ant1 | 2412 | 30~1000 | -6.75 | -55.23 | ≤-36.75 | PASS |
| 11B | Ant1 | 2412 | 1000~26500 | -6.75 | -45.64 | ≤-36.75 | PASS |
| 11B | Ant1 | 2437 | 30~1000 | -7.18 | -54.01 | ≤-37.18 | PASS |
| 11B | Ant1 | 2437 | 1000~26500 | -7.18 | -46.65 | ≤-37.18 | PASS |
| 11B | Ant1 | 2462 | 30~1000 | -6.82 | -53.95 | ≤-36.82 | PASS |
| 11B | Ant1 | 2462 | 1000~26500 | -6.82 | -46.45 | ≤-36.82 | PASS |

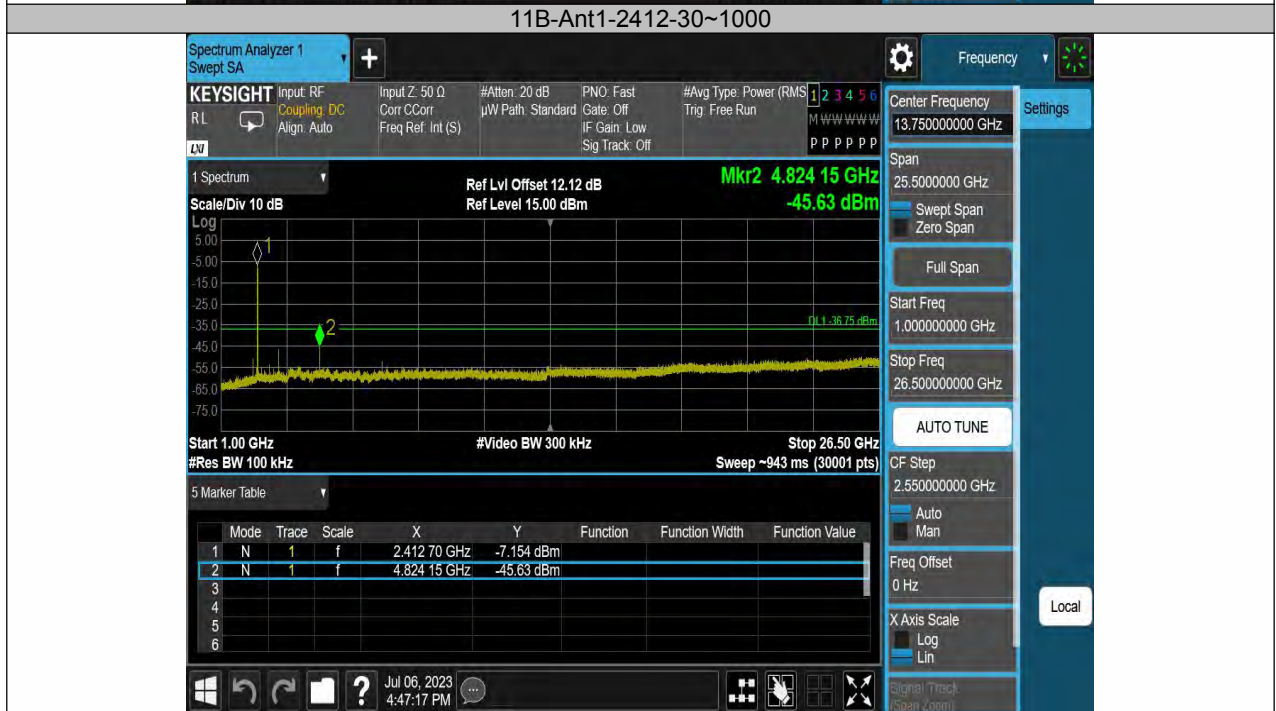





11B-Ant1-2462-30~1000



11B-Ant1-2462-1000~26500

8.6 RADIATED SPURIOUS EMISSION

8.6.1 Applicable Standard

According to FCC Part 15.247(d), 15.205, 15.209 and KDB 558074 D01 15.247 Meas Guidance v05r02

8.6.2 Conformance Limit

According to FCC Part 15.247(d): radiated emissions which fall in the restricted bands, as defined in §15.205(a), must also comply with the radiated emission limits specified in §15.209(a) (see §15.205(c)).

According to FCC Part 15.205, Restricted bands

| MHz | MHz | MHz | GHz |
|-------------------|---------------------|---------------|-------------|
| 0.090-0.110 | 16.42-16.423 | 399.9-410 | 4.5-5.15 |
| 10.495-0.505 | 16.69475-16.69525 | 608-614 | 5.35-5.46 |
| 2.1735-2.1905 | 16.80425-16.80475 | 960-1240 | 7.25-7.75 |
| 4.125-4.128 | 25.5-25.67 | 1300-1427 | 8.025-8.5 |
| 4.17725-4.17775 | 37.5-38.25 | 1435-1626.5 | 9.0-9.2 |
| 4.20725-4.20775 | 73-74.6 | 1645.5-1646.5 | 9.3-9.5 |
| 6.215-6.218 | 74.8-75.2 | 1660-1710 | 10.6-12.7 |
| 6.26775-6.26825 | 123-138 | 2200-2300 | 14.47-14.5 |
| 8.291-8.294 | 149.9-150.05 | 2310-2390 | 15.35-16.2 |
| 8.362-8.366 | 156.52475-156.52525 | 2483.5-2500 | 17.7-21.4 |
| 8.37625-8.38675 | 156.7-156.9 | 2690-2900 | 22.01-23.12 |
| 8.41425-8.41475 | 162.0125-167.17 | 3260-3267 | 23.6-24.0 |
| 12.29-12.293 | 167.72-173.2 | 3332-3339 | 31.2-31.8 |
| 12.51975-12.52025 | 240-285 | 3345.8-3358 | 36.43-36.5 |
| 12.57675-12.57725 | 322-335.4 | 3600-4400 | (2) |
| 13.36-13.41 | | | |

According to FCC Part 15.205 the level of any transmitter spurious emission in Restricted bands shall not exceed the level of the emission specified in the following table

| Restricted Frequency(MHz) | Field Strength ($\mu\text{V}/\text{m}$) | Field Strength ($\text{dB}\mu\text{V}/\text{m}$) | Measurement Distance |
|---------------------------|---|--|----------------------|
| 0.009-0.490 | 2400/F(KHz) | 20 log ($\mu\text{V}/\text{m}$) | 300 |
| 0.490-1.705 | 24000/F(KHz) | 20 log ($\mu\text{V}/\text{m}$) | 30 |
| 1.705-30 | 30 | 29.5 | 30 |
| 30-88 | 100 | 40 | 3 |
| 88-216 | 150 | 43.5 | 3 |
| 216-960 | 200 | 46 | 3 |
| Above 960 | 500 | 54 | 3 |

8.6.3 Test Configuration

Test according to clause 6.2 radio frequency test setup

8.6.4 Test Procedure

This test is required for any spurious emission that falls in a Restricted Band, as defined in Section 15.205. It must be performed with the highest gain of each type of antenna proposed for use with the EUT. Use the following spectrum analyzer settings:

For Above 1GHz:

The EUT was placed on a turn table which is 1.5m above ground plane.

Maximum procedure was performed on the highest emissions to ensure EUT compliance.

Span = wide enough to fully capture the emission being measured

RBW = 1 MHz

VBW \geq RBW

Sweep = auto

Detector function = peak

Trace = max hold

For Below 1GHz:

The EUT was placed on a turn table which is 0.8m above ground plane.
 Maximum procedure was performed on the highest emissions to ensure EUT compliance.
 Span = wide enough to fully capture the emission being measured
 RBW = 100 kHz for
 VBW ≥ RBW
 Sweep = auto
 Detector function = peak
 Trace = max hold

For Below 30MHz:
 The EUT was placed on a turn table which is 0.8m above ground plane.
 Maximum procedure was performed on the highest emissions to ensure EUT compliance.
 Span = wide enough to fully capture the emission being measured
 RBW = 9kHz
 VBW ≥ RBW
 Sweep = auto
 Detector function = peak
 Trace = max hold

For Below 150KHz:
 The EUT was placed on a turn table which is 0.8m above ground plane.
 Maximum procedure was performed on the highest emissions to ensure EUT compliance.
 Span = wide enough to fully capture the emission being measured
 RBW = 200Hz
 VBW ≥ RBW
 Sweep = auto
 Detector function = peak
 Trace = max hold

Follow the guidelines in ANSI C63.10 with respect to maximizing the emission by rotating the EUT, measuring the emission while the EUT is situated in three orthogonal planes (if appropriate), adjusting the measurement antenna height and polarization, etc. A pre-amp and a high pass filter are required for this test, in order to provide the measuring system with sufficient sensitivity. Allow the trace to stabilize. The peak reading of the emission, after being corrected by the antenna factor, cable loss, pre-amp gain, etc., is the peak field strength, which must comply with the limit. Submit this data.
 Now set the VBW to 10 Hz, while maintaining all of the other instrument settings. This peak level, once corrected, must comply with the limit. If the dwell time per channel of the hopping signal is less than 100 ms, then the reading obtained with the 10 Hz VBW may be further adjusted by a “duty cycle correction factor”, derived from $20\log(\text{dwell time}/100 \text{ ms})$, in an effort to demonstrate compliance with the limit. Submit this data.
 Repeat above procedures until all frequency measured was complete.

8.6.5 Test Results

| | |
|--------------------|-----------|
| Temperature: | 26° C |
| Relative Humidity: | 54% |
| ATM Pressure: | 1011 mbar |

■ Spurious Emission below 30MHz(9KHz to 30MHz)

| Freq. (MHz) | Ant.Pol. H/V | Emission Level(dBuV/m) | | Limit 3m(dBuV/m) | | Over(dB) | |
|-------------|--------------|------------------------|----|------------------|----|----------|----|
| | | PK | AV | PK | AV | PK | AV |
| -- | -- | -- | -- | -- | -- | -- | -- |

Note: the amplitude of spurious emission that is attenuated by more than 20dB below the permissible limit has no need to be reported.

Distance extrapolation factor = $40\log(\text{Specific distance}/ \text{test distance})$ (dB);

Limit line=Specific limits(dBuV) + distance extrapolation factor

■ Spurious Emission Above 1GHz(1GHz to 25GHz)

All the antenna(Antenna 1) and modes(802.11b/g/n) have been tested and the worst(Antenna 1 , 802.11b) result recorded was report as below:

Test mode: 802.11b Frequency: Channel 1: 2412MHz

| Freq. (MHz) | Ant.Pol. | Emission Level(dBuV/m) | | Limit 3m(dBuV/m) | | Over(dB) | |
|-------------|----------|------------------------|-------|------------------|----|----------|--------|
| | | H/V | PK | AV | PK | AV | PK |
| 7748.81 | V | 61.11 | 45.77 | 74 | 54 | -12.89 | -8.23 |
| 11447.13 | V | 60.91 | 45.64 | 74 | 54 | -13.09 | -8.36 |
| 14111.67 | V | 59.55 | 44.28 | 74 | 54 | -14.45 | -9.72 |
| 7786.98 | H | 59.78 | 44.57 | 74 | 54 | -14.22 | -9.43 |
| 9415.44 | H | 58.86 | 43.66 | 74 | 54 | -15.14 | -10.34 |
| 11978.56 | H | 59.13 | 43.91 | 74 | 54 | -14.87 | -10.09 |

Test mode: 802.11b Frequency: Channel 6: 2437MHz

| Freq. (MHz) | Ant.Pol. | Emission Level(dBuV/m) | | Limit 3m(dBuV/m) | | Over(dB) | |
|-------------|----------|------------------------|-------|------------------|----|----------|--------|
| | | H/V | PK | AV | PK | AV | PK |
| 7793.73 | V | 61.01 | 45.69 | 74 | 54 | -12.99 | -8.31 |
| 9404.56 | V | 58.39 | 43.13 | 74 | 54 | -15.61 | -10.87 |
| 12861.28 | V | 60.02 | 44.70 | 74 | 54 | -13.98 | -9.30 |
| 7780.23 | H | 60.51 | 45.22 | 74 | 54 | -13.49 | -8.78 |
| 11015.43 | H | 58.66 | 43.40 | 74 | 54 | -15.34 | -10.60 |
| 12846.42 | H | 60.26 | 45.01 | 74 | 54 | -13.74 | -8.99 |

Test mode: 802.11b Frequency: Channel 11: 2462MHz

| Freq. (MHz) | Ant.Pol. | Emission Level(dBuV/m) | | Limit 3m(dBuV/m) | | Over(dB) | |
|-------------|----------|------------------------|-------|------------------|----|----------|--------|
| | | H/V | PK | AV | PK | AV | PK |
| 7679.69 | V | 60.31 | 45.00 | 74 | 54 | -13.69 | -9.00 |
| 9855.39 | V | 58.61 | 43.20 | 74 | 54 | -15.39 | -10.80 |
| 12560.04 | V | 59.98 | 44.70 | 74 | 54 | -14.02 | -9.30 |
| 7766.75 | H | 60.09 | 44.81 | 74 | 54 | -13.91 | -9.19 |
| 9886.77 | H | 59.14 | 43.83 | 74 | 54 | 15.31 | -10.17 |
| 12469.61 | H | 58.91 | 43.62 | 74 | 54 | -15.09 | -10.38 |

- Note:**
- (1) All Readings are Peak Value (VBW=3MHz) and Average Value (VBW=10Hz).
 - (2) Emission Level= Reading Level+Correct Factor.
 - (3) Correct Factor= Ant_F + Cab_L - Preamp
 - (4) The reading of emissions are attenuated more than 20dB below the permissible limits or the field strength is too small to be measured.

■ Spurious Emission in Restricted Band 2310-2390MHz and 2483.5-2500MHz

All the antenna(Antenna 1) and modes(802.11b/g/n) have been tested and the worst(Antenna 1 , 802.11b) result recorded was report as below:

Test mode: 802.11b Frequency: Channel 1: 2412MHz

| Frequency (MHz) | Polarity | PK(dBuV/m) (VBW=3MHz) | Limit 3m (dBuV/m) | AV(dBuV/m) (VBW=10Hz) | Limit 3m (dBuV/m) |
|-----------------|----------|-----------------------|-------------------|-----------------------|-------------------|
| 2387.064 | H | 42.15 | 74.00 | 28.90 | 54.00 |
| 2374.960 | V | 43.29 | 74.00 | 29.66 | 54.00 |

Test mode: 802.11b Frequency: Channel 11: 2462MHz

| Frequency (MHz) | Polarity | PK(dBuV/m) (VBW=3MHz) | Limit 3m (dBuV/m) | AV(dBuV/m) (VBW=10Hz) | Limit 3m (dBuV/m) |
|-----------------|----------|-----------------------|-------------------|-----------------------|-------------------|
| 2489.125 | H | 45.25 | 74.00 | 32.68 | 54.00 |
| 2486.569 | V | 44.96 | 74.00 | 31.79 | 54.00 |

- Note:**
- (1) All Readings are Peak Value (VBW=3MHz) and Average Value (VBW=10Hz).
 - (2) Emission Level= Reading Level+Correct Factor.
 - (3) Correct Factor= Ant_F + Cab_L - Preamp
 - (4) The reading of emissions are attenuated more than 20dB below the permissible limits or the field strength is too small to be measured.

Test Model 802.11b Spurious Emission in Restricted Band 2310-2390MHz
 Channel 1: 2412MHz VBW=3MHz Polarity: H

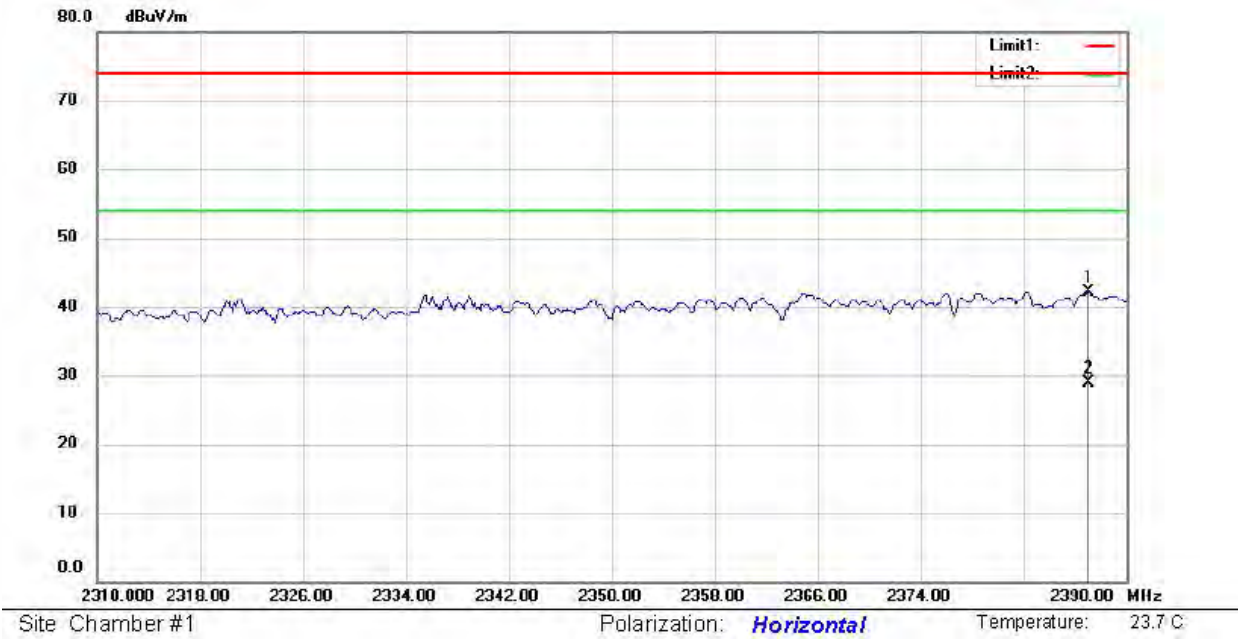

Test Model 802.11b Spurious Emission in Restricted Band 2310-2390MHz
 Channel 1: 2412MHz VBW=3MHz Polarity: V

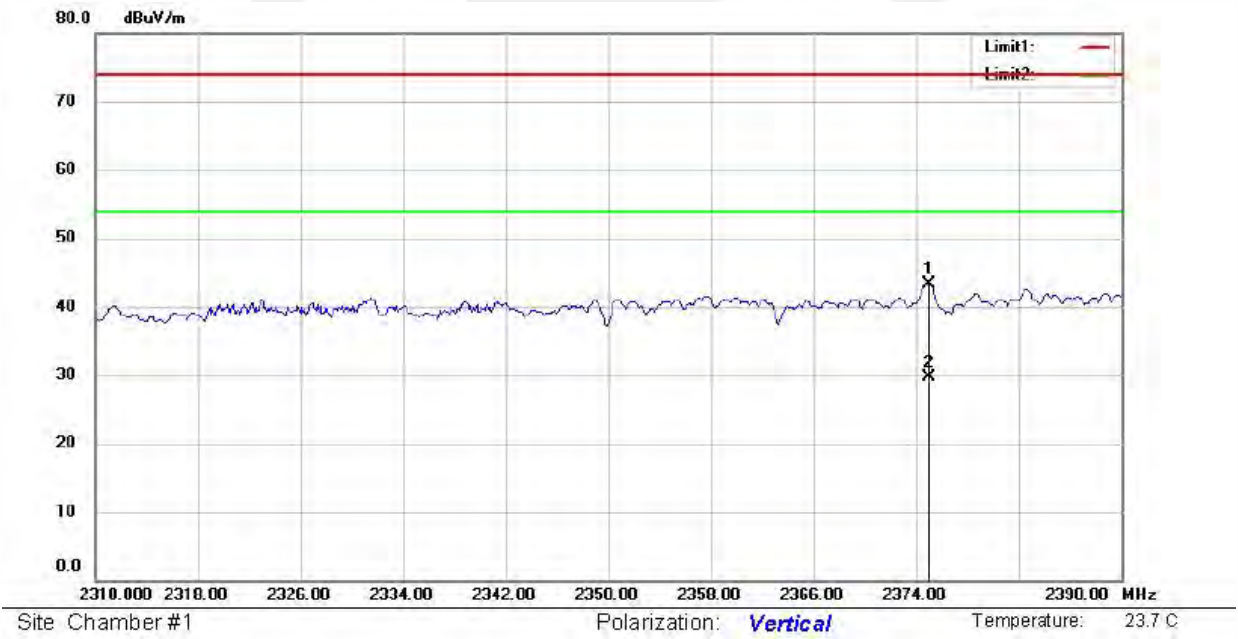

Test Model 802.11b Spurious Emission in Restricted Band 2483.5-2500MHz
 Channel 11: 2462MHz VBW=3MHz Polarity: H

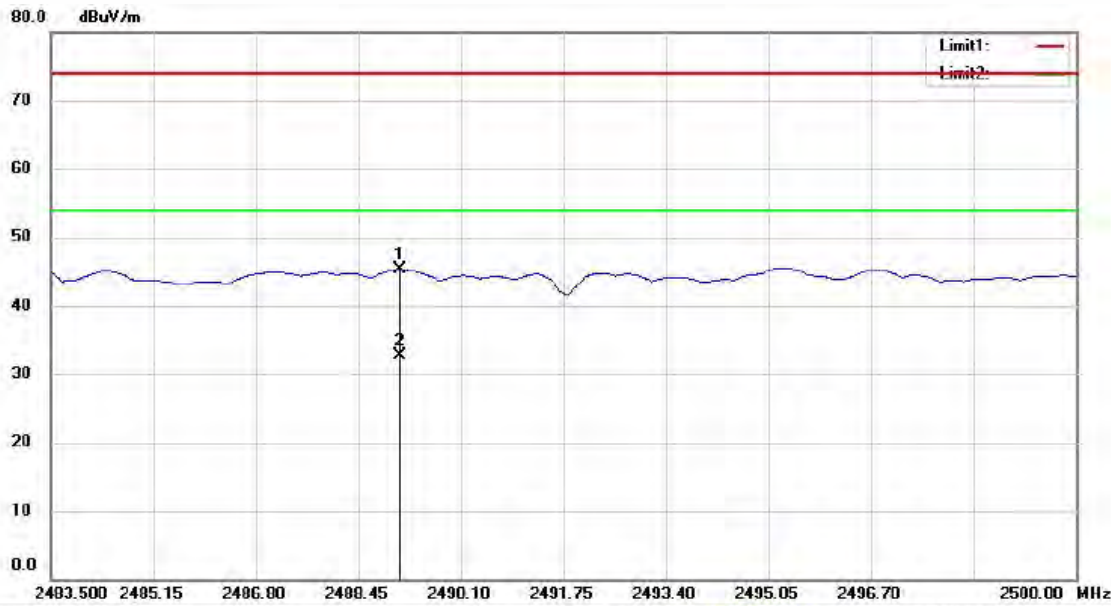

Site Chamber #1 Polarization: *Horizontal* Temperature: 23.7 C

Test Model 802.11b Spurious Emission in Restricted Band 2483.5-2500MHz
 Channel 11: 2462MHz VBW=3MHz Polarity: V

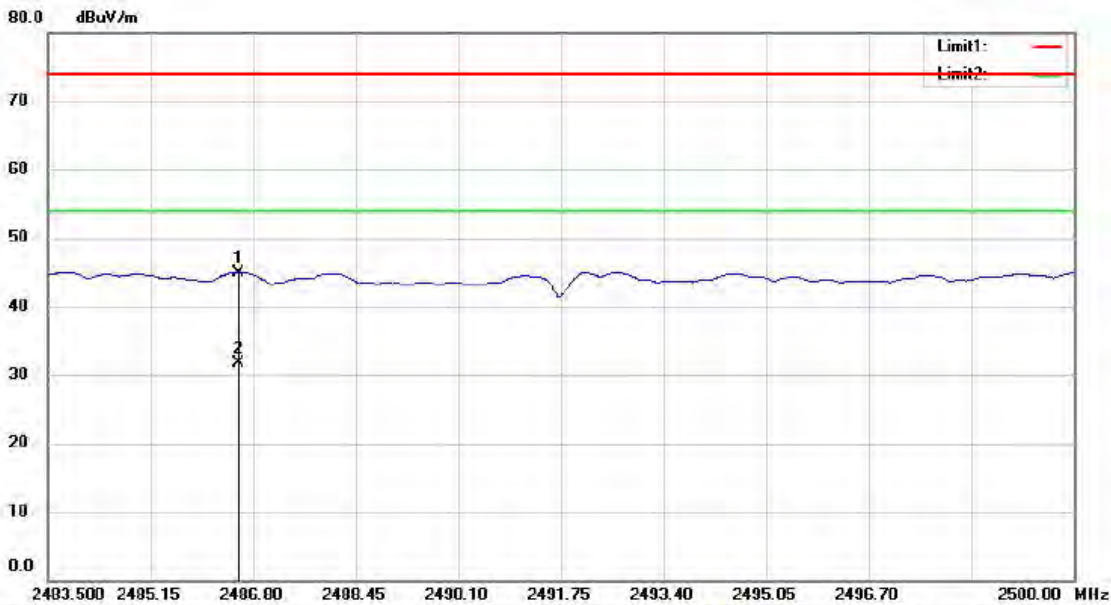

Site Chamber #1 Polarization: *Vertical* Temperature: 23.7 C

■ Spurious Emission below 1GHz (30MHz to 1GHz)

All the antenna(Antenna 1) and modes(802.11b/g/n) have been tested and the worst(Antenna 1, 802.11b) result recorded was report as below:

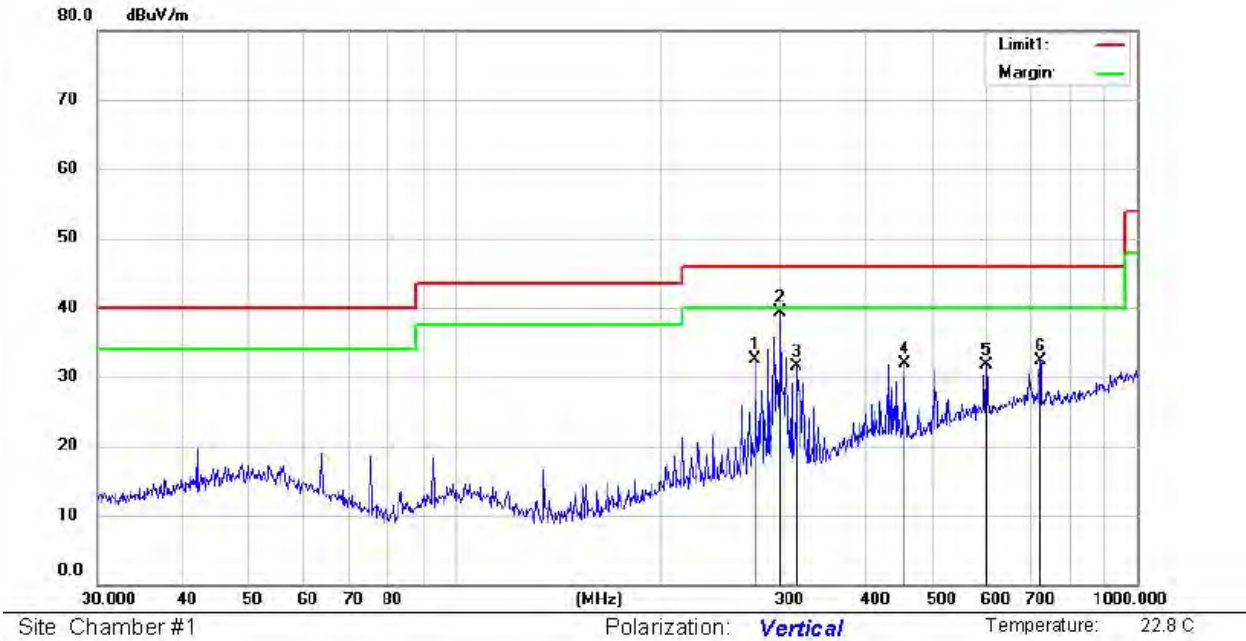

Mode:WIFI 2.4G
Note:

| No. | Mk. | Freq. MHz | Reading Level dBuV | Ant. Factor dB/m | Pre Amp Gain dB | Cable loss dB | Measure- ment dBuV/m | Limit dBuV/m | Over dB | Detector | HI cm | Degree deg. | Comment |
|-----|-----|--------------|--------------------------|------------------------|-----------------------|---------------------|----------------------------|-----------------|------------|----------|----------|----------------|---------|
| 1 | | 276.1235 | 46.78 | 13.47 | 29.96 | 2.15 | 32.44 | 46.00 | -13.56 | QP | | | |
| 2 | * | 300.3672 | 53.12 | 13.91 | 29.83 | 2.16 | 39.36 | 46.00 | -6.64 | QP | | | |
| 3 | | 317.7010 | 44.76 | 14.29 | 29.83 | 2.23 | 31.45 | 46.00 | -14.55 | QP | | | |
| 4 | | 455.9058 | 42.01 | 17.01 | 29.81 | 2.71 | 31.92 | 46.00 | -14.08 | QP | | | |
| 5 | | 601.4265 | 38.55 | 20.03 | 29.96 | 3.1 | 31.72 | 46.00 | -14.28 | QP | | | |
| 6 | | 721.7260 | 37.44 | 21.32 | 30.14 | 3.62 | 32.24 | 46.00 | -13.76 | QP | | | |

*:Maximum data x:Over limit !:over margin

Operator: Ccyf

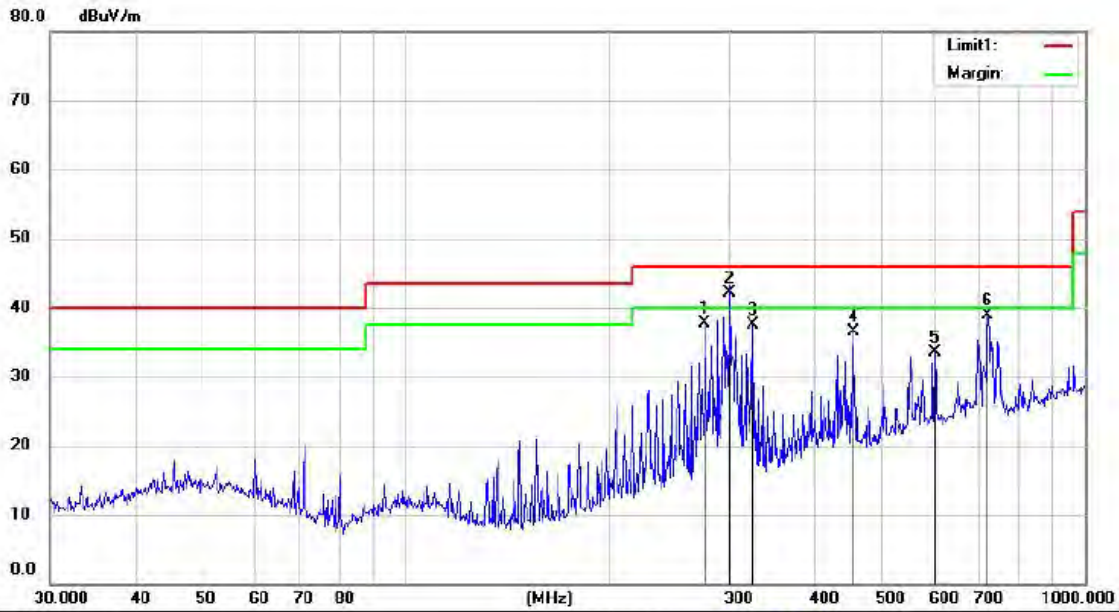

Site: Chamber #1 Polarization: **Horizontal** Temperature: 22.8 C

Mode: WIFI 2.4G

Note:

| No. | Mk. | Freq. MHz | Reading Level dBuV | Ant. Factor dB/m | Pre Amp Gain dB | Cable loss dB | Measure- ment dBuV/m | Limit dBuV/m | Over dB | HI Detector | Degree cm | Degree deg. | Comment |
|-----|-----|--------------|--------------------------|------------------------|-----------------------|---------------------|----------------------------|-----------------|------------|----------------|--------------|----------------|---------|
| 1 | | 276.1235 | 51.97 | 13.47 | 29.96 | 2.15 | 37.63 | 46.00 | -8.37 | QP | | | |
| 2 | * | 300.3672 | 55.96 | 13.91 | 29.83 | 2.16 | 42.20 | 46.00 | -3.80 | QP | | | |
| 3 | | 324.4560 | 50.64 | 14.44 | 29.83 | 2.26 | 37.51 | 46.00 | -8.49 | QP | | | |
| 4 | | 455.9058 | 46.68 | 17.01 | 29.81 | 2.71 | 36.59 | 46.00 | -9.41 | QP | | | |
| 5 | | 601.4265 | 40.34 | 20.03 | 29.96 | 3.1 | 33.51 | 46.00 | -12.49 | QP | | | |
| 6 | | 719.1995 | 44.10 | 21.38 | 30.13 | 3.6 | 38.95 | 46.00 | -7.05 | QP | | | |

*:Maximum data x:Over limit !:over margin

Operator: Ccyf

Remark:

1. Measurement (dBuV/m) = Antenna Factor(dB) -Amp Factor(dB) +Cable Loss(dB) + Reading(dBuV/m)
2. Over (dB) = Measurement (dBuV/m) - Limit (dBuV/m)

8.7 CONDUCTED EMISSION TEST

8.7.1 Applicable Standard

According to FCC Part 15.207(a)

8.7.2 Conformance Limit

| Frequency(MHz) | Conducted Emission Limit | |
|----------------|--------------------------|---------|
| | Quasi-peak | Average |
| 0.15-0.5 | 66-56 | 56-46 |
| 0.5-5.0 | 56 | 46 |
| 5.0-30.0 | 60 | 50 |

Note: 1. The lower limit shall apply at the transition frequencies
2. The limit decreases in line with the logarithm of the frequency in the range of 0.15 to 0.50MHz.

8.7.3 Test Configuration

Test according to clause 6.3 conducted emission test setup

8.7.4 Test Procedure

The EUT was placed on a table which is 0.8m above ground plane.
Maximum procedure was performed on the highest emissions to ensure EUT compliance.
Repeat above procedures until all frequency measured were complete.

8.7.5 Test Results

Pass

The AC120V &240V voltage have been tested, and the worst result recorded was report as below:

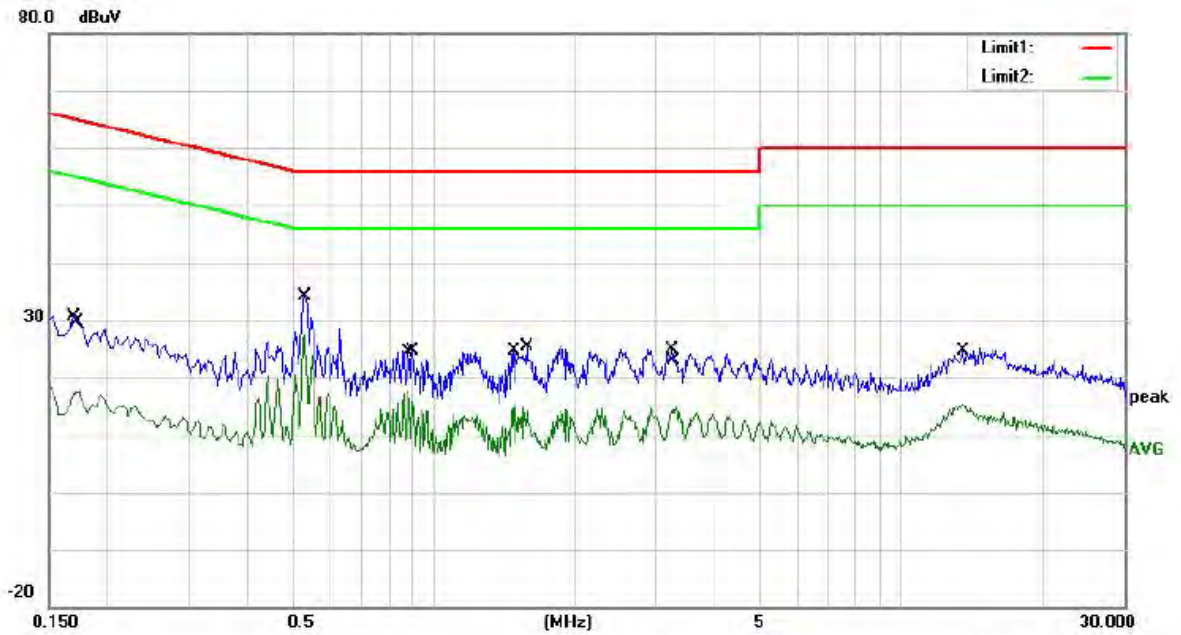

Site: site #1 Phase: L1 Temperature: 21.5

Mode: Charging

Note:

| No. | Mk. | Freq. MHz | Reading Level dBuV | Correct Factor dB | Measure- ment dBuV | Limit dBuV | Over dB | Detector | Comment |
|-----|-----|--------------|--------------------------|-------------------------|--------------------------|---------------|------------|----------|---------|
| 1 | | 0.1700 | 21.05 | 9.50 | 30.55 | 64.96 | -34.41 | QP | |
| 2 | | 0.1740 | 8.00 | 9.50 | 17.50 | 54.77 | -37.27 | AVG | |
| 3 | | 0.5300 | 24.41 | 9.63 | 34.04 | 56.00 | -21.96 | QP | |
| 4 | * | 0.5300 | 17.73 | 9.63 | 27.36 | 46.00 | -18.64 | AVG | |
| 5 | | 0.8820 | 8.24 | 9.50 | 17.74 | 46.00 | -28.26 | AVG | |
| 6 | | 0.9020 | 15.19 | 9.50 | 24.69 | 56.00 | -31.31 | QP | |
| 7 | | 1.4940 | 6.19 | 9.51 | 15.70 | 46.00 | -30.30 | AVG | |
| 8 | | 1.5820 | 15.85 | 9.52 | 25.37 | 56.00 | -30.63 | QP | |
| 9 | | 3.2340 | 15.25 | 9.53 | 24.78 | 56.00 | -31.22 | QP | |
| 10 | | 3.3020 | 5.25 | 9.52 | 14.77 | 46.00 | -31.23 | AVG | |
| 11 | | 13.5700 | 15.22 | 9.39 | 24.61 | 60.00 | -35.39 | QP | |
| 12 | | 13.5700 | 5.89 | 9.39 | 15.28 | 50.00 | -34.72 | AVG | |

*:Maximum data x:Over limit !:over margin Comment: Factor build in receiver. Operator: Lennard Lio

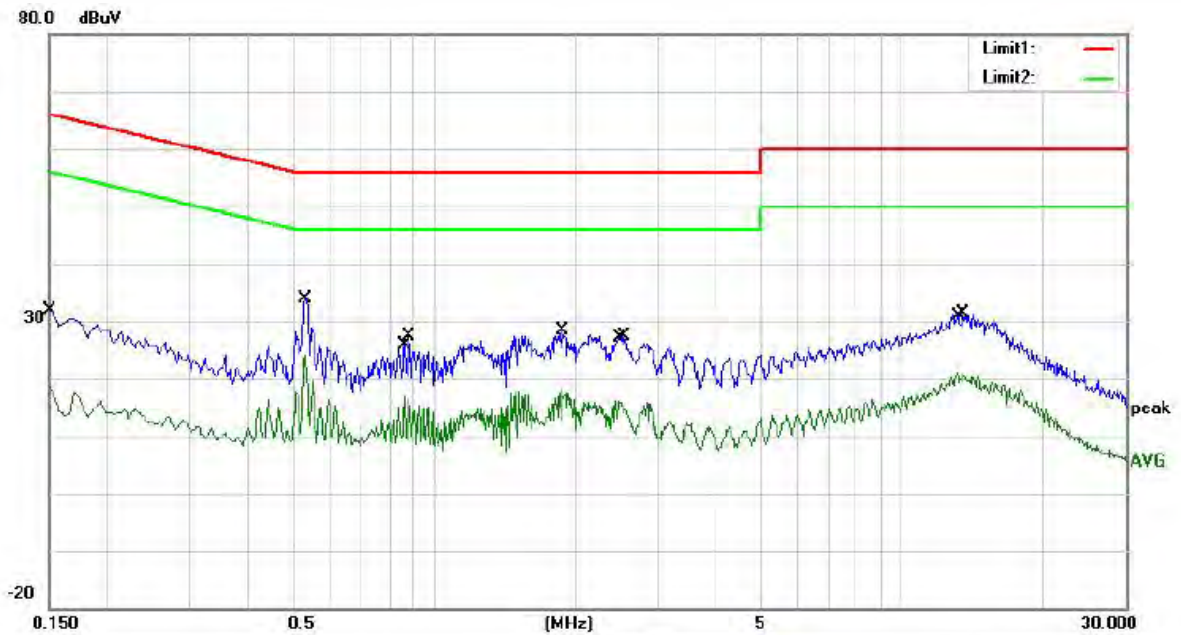

Site: site #1 Phase: N Temperature: 21.5

Mode: Charging

Note:

| No. | Mk. | Freq. MHz | Reading Level dBuV | Correct Factor dB | Measure- ment dBuV | Limit dBuV | Over dB | Detector | Comment |
|-----|-----|--------------|--------------------------|-------------------------|--------------------------|---------------|------------|----------|---------|
| 1 | | 0.1500 | 22.34 | 9.52 | 31.86 | 66.00 | -34.14 | QP | |
| 2 | | 0.1500 | 9.45 | 9.52 | 18.97 | 56.00 | -37.03 | AVG | |
| 3 | | 0.5300 | 24.16 | 9.63 | 33.79 | 56.00 | -22.21 | QP | |
| 4 | * | 0.5300 | 14.52 | 9.63 | 24.15 | 46.00 | -21.85 | AVG | |
| 5 | | 0.8620 | 7.40 | 9.51 | 16.91 | 46.00 | -29.09 | AVG | |
| 6 | | 0.8820 | 17.85 | 9.50 | 27.35 | 56.00 | -28.65 | QP | |
| 7 | | 1.8740 | 18.86 | 9.55 | 28.41 | 56.00 | -27.59 | QP | |
| 8 | | 1.8740 | 8.69 | 9.55 | 18.24 | 46.00 | -27.76 | AVG | |
| 9 | | 2.4860 | 6.47 | 9.55 | 16.02 | 46.00 | -29.98 | AVG | |
| 10 | | 2.5500 | 17.73 | 9.55 | 27.28 | 56.00 | -28.72 | QP | |
| 11 | | 13.0660 | 11.65 | 9.40 | 21.05 | 50.00 | -28.95 | AVG | |
| 12 | | 13.4900 | 22.02 | 9.39 | 31.41 | 60.00 | -28.59 | QP | |

*:Maximum data x:Over limit l:over margin Comment: Factor build in receiver. Operator: Lennard Lio

Remark:

1. Measurement (dBμV) = AMN Factor (dB) + Cable Loss (dB) + Reading (dBμV)

2. Over (dB) = Measurement (dBμV) - Limit (dBμV)

8.8 ANTENNA APPLICATION

8.8.1 Antenna Requirement

| Standard | Requirement |
|----------------------------|---|
| FCC CRF Part 15.203 | An intentional radiator shall be designed to ensure that no antenna other than that furnished by the responsible party shall be used with the device. The use of a permanently attached antenna or of an antenna that uses a unique coupling to the intentional radiator shall be considered sufficient to comply with the provisions of this section. The manufacturer may design the unit so that a broken antenna can be replaced by the user, but the use of a standard antenna jack or electrical connector is prohibited. |
| FCC 47 CFR Part 15.247 (b) | If transmitting antennas of directional gain greater than 6dBi are used, the power shall be reduced by the amount in dB that the directional gain of the antenna exceeds 6dBi. |

8.8.2 Result

PASS.

- Note:
- Antenna use a permanently attached antenna which is not replaceable.
 - Not using a standard antenna jack or electrical connector for antenna replacement
 - The antenna has to be professionally installed (please provide method of installation)

Please refer to the attached document Internal Photos to show the antenna connector.

Detail of factor for radiated emission

| Frequency(MHz) | Ant_F(dB) | Cab_L(dB) | Preamp(dB) | Correct Factor(dB) |
|----------------|-----------|-----------|------------|--------------------|
| 0.009 | 20.6 | 0.03 | \ | 20.63 |
| 0.15 | 20.7 | 0.1 | \ | 20.8 |
| 1 | 20.9 | 0.15 | \ | 21.05 |
| 10 | 20.1 | 0.28 | \ | 20.38 |
| 30 | 18.8 | 0.45 | \ | 19.25 |
| 30 | 11.7 | 0.62 | 27.9 | -15.58 |
| 100 | 12.5 | 1.02 | 27.8 | -14.28 |
| 300 | 12.9 | 1.91 | 27.5 | -12.69 |
| 600 | 19.2 | 2.92 | 27 | -4.88 |
| 800 | 21.1 | 3.54 | 26.6 | -1.96 |
| 1000 | 22.3 | 4.17 | 26.2 | 0.27 |
| 1000 | 25.6 | 1.76 | 41.4 | -14.04 |
| 3000 | 28.9 | 3.27 | 43.2 | -11.03 |
| 5000 | 31.1 | 4.2 | 44.6 | -9.3 |
| 8000 | 36.2 | 5.95 | 44.7 | -2.55 |
| 10000 | 38.4 | 6.3 | 43.9 | 0.8 |
| 12000 | 38.5 | 7.14 | 42.3 | 3.34 |
| 15000 | 40.2 | 8.15 | 41.4 | 6.95 |
| 18000 | 45.4 | 9.02 | 41.3 | 13.12 |
| 18000 | 37.9 | 1.81 | 47.9 | -8.19 |
| 21000 | 37.9 | 1.95 | 48.7 | -8.85 |
| 25000 | 39.3 | 2.01 | 42.8 | -1.49 |
| 28000 | 39.6 | 2.16 | 46.0 | -4.24 |
| 31000 | 41.2 | 2.24 | 44.5 | -1.06 |
| 34000 | 41.5 | 2.29 | 46.6 | -2.81 |
| 37000 | 43.8 | 2.30 | 46.4 | -0.3 |
| 40000 | 43.2 | 2.50 | 42.2 | 3.5 |

*** End of Report ***