

MCU

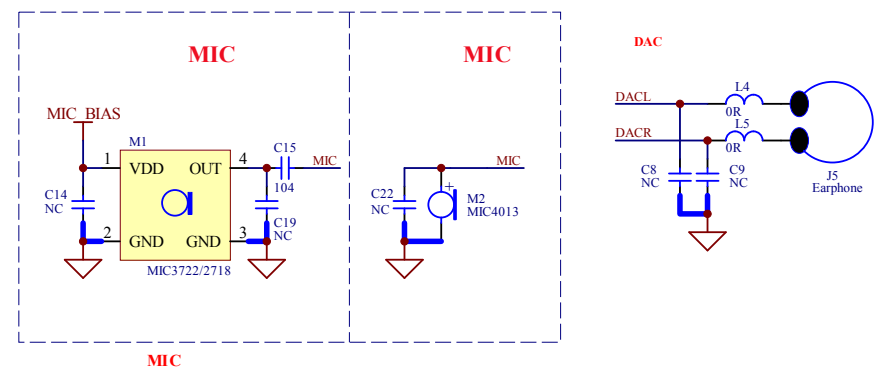

Mic, Earphone

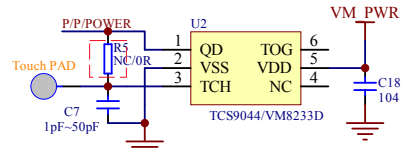
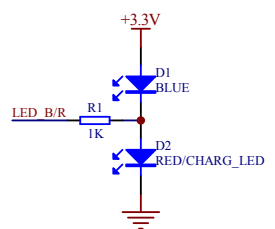

LED

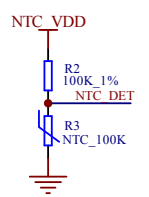

NTC

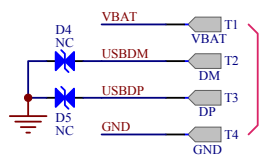

Test Point

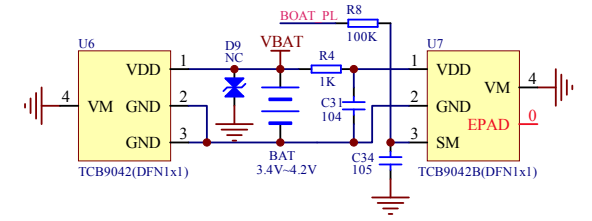
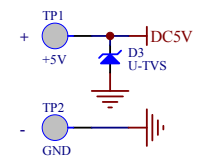

POWER