

FCC SAR

Measurement and Test Report

For

Xwireless LLC

11565 Old Georgetown Road, Rockville, MD, USA

FCC ID: 2ADLJHOTSPOT

FCC Rules:	FCC Part 2.1093 ANSI / IEEE C95.1 :2005 ANSI / IEEE C95.3 :2002 <u>IEEE 1528 :2013</u>
Product Description:	<u>mobile phone</u>
Tested Model:	<u>HotSpot</u>
Report No.:	<u>STR16128064H</u>
Tested Date:	<u>2017-01-09 to 2017-01-14</u>
Issued Date:	<u>2017-01-16</u>
Tested By:	<u>Lucy Wei / Engineer</u> <i>Lucy Wei</i>
Reviewed By:	<u>Silin Chen / EMC Manager</u> <i>Silin Chen</i>
Approved & Authorized By:	<u>Jandy So / PSQ Manager</u> <i>Jandy So</i>
Prepared By:	

Shenzhen SEM.Test Technology Co., Ltd.
1/F, Building A, Hongwei Industrial Park, Liuxian 2nd Road,
Bao'an District, Shenzhen, P.R.C. (518101)
Tel.: +86-755-33663308 Fax.: +86-755-33663309 Website: www.semtest.com.cn

Note: This test report is limited to the above client company and the product model only. It may not be duplicated without prior permitted by Shenzhen SEM. Test Technology Co., Ltd.

TABLE OF CONTENTS

1. General Information3

 1.1 Product Description for Equipment Under Test (EUT).....3

 1.2 Test Standards5

 1.3 Test Methodology.....5

 1.4 Test Facility5

2. Summary of Test Results6

3. Specific Absorption Rate (SAR).....7

 3.1 Introduction.....7

 3.2 SAR Definition7

4. SAR Measurement System.....8

 4.1 The Measurement System8

 4.2 Probe.....8

 4.3 Probe Calibration Process.....10

 4.4 Phantom11

 4.5 Device Holder.....11

 4.6 Test Equipment List.....12

5. Tissue Simulating Liquids.....13

 5.1 Composition of Tissue Simulating Liquid.....13

 5.2 Tissue Dielectric Parameters for Head and Body Phantoms.....14

 5.3 Tissue Calibration Result.....15

6. SAR Measurement Evaluation16

 6.1 Purpose of System Performance Check.....16

 6.2 System Setup.....16

 6.3 Validation Results.....17

7. EUT Testing Position18

 7.1 Define Two Imaginary Lines on The Handset.....18

 7.2 Cheek Position19

 7.3 Tilted Position.....19

 7.4 Body Position20

 7.5 EUT Antenna Position20

 7.6 EUT Testing Position.....21

8. SAR Measurement Procedures.....22

 8.1 Measurement Procedures22

 8.2 Spatial Peak SAR Evaluation22

 8.3 Area & Zoom Scan Procedures.....23

 8.4 Volume Scan Procedures.....23

 8.5 SAR Averaged Methods23

 8.6 Power Drift Monitoring.....23

9. SAR Test Result24

 9.1 Conducted RF Output Power24

 9.2 Test Results for Standalone SAR Test.....28

 9.3 Simultaneous Multi-band Transmission SAR Analysis33

10. Measurement Uncertainty39

 10.1 Uncertainty for EUT SAR Test.....39

 10.2 Uncertainty for System Performance Check.....40

Annex A. Plots of System Performance Check42

Annex B. Plots of SAR Measurement.....54

Annex C. EUT Photos83

Annex D. Test Setup Photos85

Annex E. Calibration Certificate.....90

1. General Information

1.1 Product Description for Equipment Under Test (EUT)

Client Information

Applicant: Xwireless LLC
 Address of applicant: 11565 Old Georgetown Road, Rockville, MD, USA

Manufacturer: Xwireless LLC
 Address of manufacturer: 11565 Old Georgetown Road, Rockville, MD, USA

General Description of EUT	
Product Name:	mobile phone
Brand Name:	/
Model No.:	HotSpot
Adding Model:	/
Rated Voltage:	DC 3.7V Li-ion Battery
Battery Capacity:	1000mAh
<i>Note: The test data is gathered from a production sample, provided by the manufacturer. For more information see the following datasheet</i>	

Technical Characteristics of EUT	
2G	
Support Networks:	GSM, GPRS, EDGE
Support Band:	GSM850/PCS1900
Uplink Frequency:	GSM/GPRS 850: 824~849MHz GSM/GPRS 1900: 1850~1910MHz
Downlink Frequency:	GSM/GPRS 850: 869~894MHz GSM/GPRS 1900: 1930~1990MHz
Max RF Output Power:	GSM850: 32.32dBm, GSM1900: 30.56dBm EDGE850: 28.58dBm, EDGE1900: 25.0dBm
Type of Modulation:	GMSK, 8PSK
Antenna Type:	FPC Antenna
Antenna Gain:	GSM850: 0.62dBi, GSM1900: 0.81dBi,
GPRS Class:	Class 12
3G	
Support Networks:	WCDMA, HSDPA, HSUPA
Support Band:	WCDMA Band II, WCDMA Band V
Uplink Frequency:	WCDMA Band II: 1850~1910MHz WCDMA Band V: 824~849MHz
Downlink Frequency:	WCDMA Band II: 1930~1990MHz WCDMA Band V: 869~894MHz

RF Output Power:	WCDMA850: 22.73dBm, WCDMA1900: 22.78dBm
Type of Modulation:	BPSK, QPSK, 16QAM
Antenna Type:	FPC Antenna
Antenna Gain:	WCDMA850: 0.62dBi, WCDMA1900: 0.81dBi
WIFI	
Support Standards:	802.11b, 802.11g, 802.11n
Frequency Range:	2412-2462MHz for 802.11b/g/n(HT20)
AV Output Power:	17.65dBm (Conducted)
Type of Modulation:	CCK, OFDM, QPSK, BPSK, 16QAM, 64QAM
Data Rate:	1-11Mbps, 6-54Mbps, up to 150Mbps
Quantity of Channels:	11 for 802.11b/g/n(HT20)
Channel Separation:	5MHz
Antenna Type:	FPC Antenna
Antenna Gain:	0.82dBi
Bluetooth	
Bluetooth Version:	V4.0
Frequency Range:	2402-2480MHz
AV Output Power:	3.622dBm (Conducted)
Data Rate:	1Mbps, 2Mbps, 3Mbps
Modulation:	GFSK, Pi/4 QDPSK, 8DPSK
Quantity of Channels:	79/40
Channel Separation:	1MHz/2MHz
Antenna Type:	FPC Antenna
Antenna Gain:	0.82dBi

1.2 Test Standards

The following report is prepared on behalf of the Xwireless LLC in accordance with FCC 47 CFR Part 2.1093, ANSI/IEEE C95.1-2005, IEEE 1528-2013, KDB 865664 D01 v01r04, KDB 865664 D02 v01r02, KDB 941225 D06 Hotspot mode v02r01, KDB 447498 D01 v06, KDB 648474 D04 v01r02 and KDB 941225 D01 v03.

The objective is to determine compliance with FCC Part 2.1093 of the Federal Communication Commissions rules.

Maintenance of compliance is the responsibility of the manufacturer. Any modification of the product, which result in lowering the emission, should be checked to ensure compliance has been maintained.

1.3 Test Methodology

All measurements contained in this report were conducted with KDB 865664 D01 v01r04 and KDB 865664 D02 v01r02. The public notice KDB 447498 D01 v06 for Mobile and Portable Devices RF Exposure Procedure also.

1.4 Test Facility

- **FCC – Registration No.: 934118**

Shenzhen SEM.Test Technology Co., Ltd. EMC Laboratory has been registered and fully described in a report filed with the (FCC) Federal Communications Commission. The acceptance letter from the FCC is maintained in our files and the Registration is 934118.

- **Industry Canada (IC) Registration No.: 11464A**

The 3m Semi-anechoic chamber of Shenzhen SEM.Test Technology Co., Ltd. has been registered by Certification and Engineering Bureau of Industry Canada for radio equipment testing with Registration No.: 11464A.

- **CNAS Registration No.: L4062**

Shenzhen SEM.Test Technology Co., Ltd. is a testing organization accredited by China National Accreditation Service for Conformity Assessment (CNAS) according to ISO/IEC 17025. The accreditation certificate number is L4062. All measurement facilities used to collect the measurement data are located at 1/F, Building A, Hongwei Industrial Park, Liuxian 2nd Road, Bao'an District, Shenzhen, P.R.C (518101)

2. Summary of Test Results

The maximum results of Specific Absorption Rate (SAR) have found during testing are as follows:

Frequency Band	Head SAR	Body-worn (10mm Gap)	SAR _{1g} Limit (W/kg)
	Maximum SAR _{1g} (W/kg)	Maximum SAR _{1g} (W/kg)	
GSM850	0.292	0.880	1.6
GSM1900	0.324	0.791	1.6
WCDMA Band V	0.236	0.692	1.6
WCDMA Band II	0.313	0.825	1.6
WLAN 2.4GHz	0.737	0.582	1.6

Frequency Band	Hotspot (10mm Gap)	SAR _{1g} Limit (W/kg)
	Maximum SAR _{1g} (W/kg)	
GSM850+WLAN	1.461	1.6
GSM1900+WLAN	1.373	1.6
WCDMA Band V+WLAN	1.273	1.6
WCDMA Band II+WLAN	1.407	1.6

The highest reported SAR values for head, body-worn accessory, hotspot and simultaneous transmission conditions are 0.737 W/kg, 0.880 W/kg, 1.461W/kg, and 1.461W/kg respectively

The device is in compliance with Specific Absorption Rate (SAR) for general population/uncontrolled exposure limits (1.6 W/kg) specified in FCC 47 CFR Part 2.1093 and ANSI/IEEE C95.1-2005, and had been tested in accordance with the measurement methods and procedure specified in IEEE 1528-2013 and KDB 865664 D01 v01r04 and KDB 865664 D02 v01r02

3. Specific Absorption Rate (SAR)

3.1 Introduction

SAR is related to the rate at which energy is absorbed per unit mass in an object exposed to a radio field. The SAR distribution in a biological body is complicated and is usually carried out by experimental techniques or numerical modeling. The standard recommends limits for two tiers of groups, occupational/controlled and general population/uncontrolled, based on a person's awareness and ability to exercise control over his or her exposure. In general, occupational/controlled exposure limits are higher than the limits for general population/uncontrolled.

3.2 SAR Definition

The SAR definition is the time derivative (rate) of the incremental energy (dW) absorbed by (dissipated in) an incremental mass (dm) contained in a volume element (dv) of a given density (ρ). The equation description is as below:

$$\text{SAR} = \frac{d}{dt} \left(\frac{dW}{dm} \right) = \frac{d}{dt} \left(\frac{dW}{\rho dv} \right)$$

SAR is expressed in units of Watts per kilogram (W/kg)

SAR measurement can be either related to the temperature elevation in tissue by

$$\text{SAR} = C \left(\frac{\delta T}{\delta t} \right)$$

Where: C is the specific heat capacity, δT is the temperature rise and δt is the exposure duration, or related to the electrical field in the tissue by

$$\text{SAR} = \frac{\sigma |E|^2}{\rho}$$

Where: σ is the conductivity of the tissue, ρ is the mass density of the tissue and E is the RMS electrical field strength.

However for evaluating SAR of low power transmitter, electrical field measurement is typically applied.

4. SAR Measurement System

4.1 The Measurement System

Comosar is a system that is able to determine the SAR distribution inside a phantom of human being according to different standards. The Comosar system consists of the following items:

- Main computer to control all the system
- 6 axis robot
- Data acquisition system
- Miniature E-field probe
- Phone holder
- Head simulating tissue

The following figure shows the system.



The EUT under test operating at the maximum power level is placed in the phone holder, under the phantom, which is filled with head simulating liquid. The E-Field probe measures the electric field inside the phantom. The OpenSAR software computes the results to give a SAR value in a 1g or 10g mass.

4.2 Probe

For the measurements the Specific Dosimetric E-Field Probe SSE5 SN 09/13 EP168 with following specifications is used

- Dynamic range: 0.01-100 W/kg
- Probe Length: 330 mm
- Length of Individual Dipoles: 4.5 mm
- Maximum external diameter: 8 mm
- Probe Tip External Diameter : 5 mm
- Distance between dipoles / probe extremity: 2.7mm

- Probe linearity: <0.25 dB
 - Axial Isotropy: <0.25 dB
 - Spherical Isotropy: <0.50 dB
 - Calibration range: 700 to 3000MHz for head & body simulating liquid.
- Angle between probe axis (evaluation axis) and surface normal line: less than 30°

Probe calibration is realized, in compliance with EN 62209-1 and IEEE 1528 STD, with CALISAR, Antenna proprietary calibration system. The calibration is performed with the EN 62209-1 annexe technique using reference guide at the five frequencies.

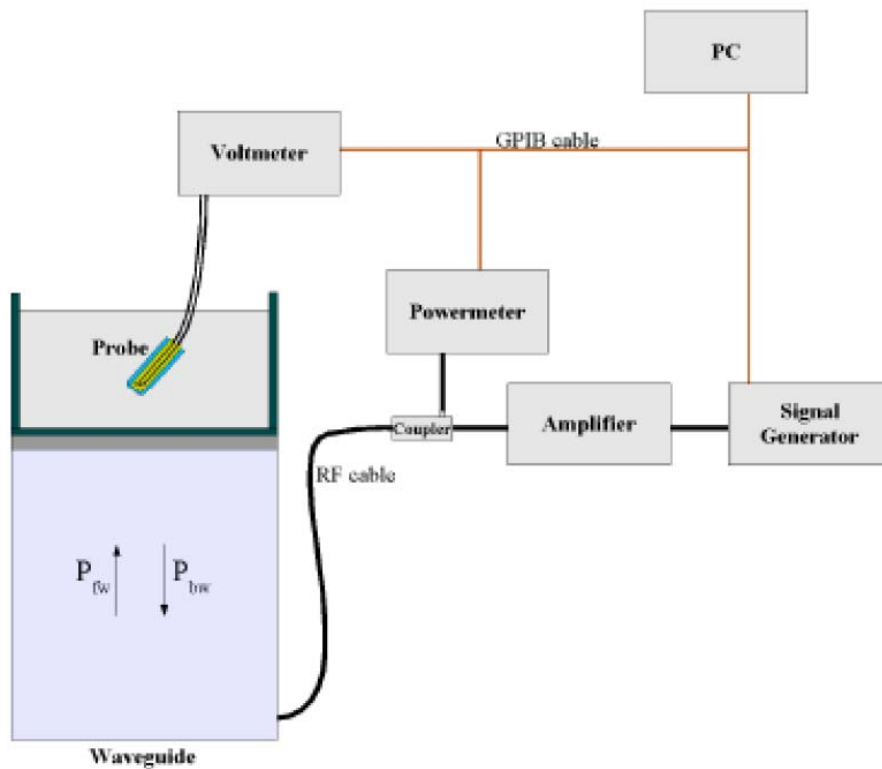

$$SAR = \frac{4(P_{fw} - P_{bw})}{ab\delta} \cos^2\left(\pi \frac{y}{a}\right) e^{-2z/\delta}$$

Where :

P_{fw} = Forward Power

P_{bw} = Backward Power

a and b = Waveguide dimensions

δ = Skin depth

Keithley configuration:

Rate = Medium; Filter = ON; RDGS = 10; Filter type = Moving Average; Range auto after each calibration, a SAR measurement is performed on a validation dipole and compared with a NPL calibrated probe, to verify it.

The calibration factors, CF(N), for the 3 sensors corresponding to dipole 1, dipole 2 and dipole 3 are:

$$CF(N)=SAR(N)/V_{lin}(N) \quad (N=1,2,3)$$

The linearised output voltage $V_{lin}(N)$ is obtained from the displayed output voltage $V(N)$ using

$$V_{lin}(N)=V(N)*(1+V(N)/DCP(N)) \quad (N=1,2,3)$$

where DCP is the diode compression point in mV.

4.3 Probe Calibration Process

Dosimetric Assessment Procedure

Each E-Probe/Probe Amplifier combination has unique calibration parameters. SATIMO Probe calibration procedure is conducted to determine the proper amplifier settings to enter in the probe parameters. The amplifier settings are determined for a given frequency by subjecting the probe to a known E-field density (1 mW/cm²) using an with CALISAR, Antenna proprietary calibration system.

Free Space Assessment Procedure

The free space E-field from amplified probe outputs is determined in a test chamber. This calibration can be performed in a TEM cell if the frequency is below 1 GHz and in a waveguide or other methodologies above 1 GHz for free space. For the free space calibration, the probe is placed in the volumetric center of the cavity and at the proper orientation with the field. The probe is rotated 360 degrees until the three channels show the maximum reading. The power density readings equates to 1mW/cm².

Temperature Assessment Procedure

E-field temperature correlation calibration is performed in a flat phantom filled with the appropriate simulated head tissue. The E-field in the medium correlates with the temperature rise in the dielectric medium. For temperature correlation calibration a RF transparent thermistor-based temperature probe is used in conjunction with the E-field probe.

Where:

$$SAR = C \frac{\Delta T}{\Delta t}$$

Δt = exposure time (30 seconds),

C = heat capacity of tissue (brain or muscle),

ΔT = temperature increase due to RF exposure.

SAR is proportional to $\Delta T / \Delta t$, the initial rate of tissue heating, before thermal diffusion takes place. The electric field in the simulated tissue can be used to estimate SAR by equating the thermally derived SAR to that with the E- field component.

$$\text{SAR} = \frac{|E|^2 \cdot \sigma}{\rho}$$

Where:

σ = simulated tissue conductivity,

ρ = Tissue density (1.25 g/cm³ for brain tissue)

4.4 Phantom

For the measurements the Specific Anthropomorphic Mannequin (SAM) defined by the IEEE SCC-34/SC2 group is used. The phantom is a polyurethane shell integrated in a wooden table. The thickness of the phantom amounts to 2mm +/- 0.2mm. It enables the dosimetric evaluation of left and right phone usage and includes an additional flat phantom part for the simplified performance check. The phantom set-up includes a cover, which prevents the evaporation of the liquid.

4.5 Device Holder

The positioning system allows obtaining cheek and tilting position with a very good accuracy. In compliance with CENELEC, the tilt angle uncertainty is lower than 1°.

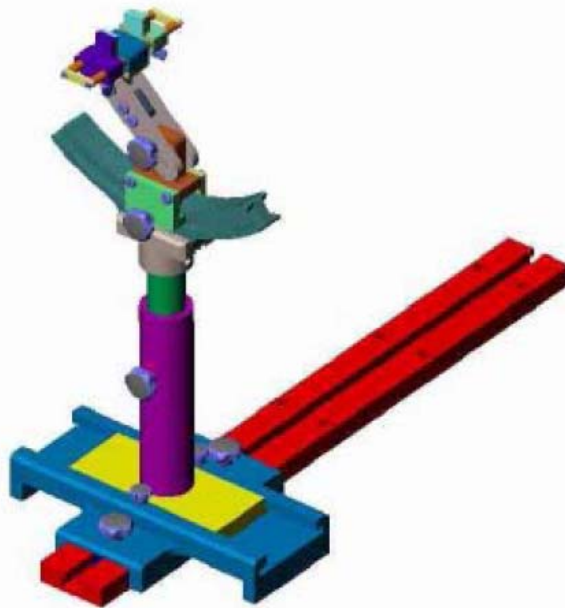

System Material	Permittivity	Loss Tangent
Delrin	3.7	0.005

4.6 Test Equipment List

Description	Manufacturer	Model	Serial Number	Cal. Date	Due. Date
E-Field Probe	SATIMO	SSE5	SN 09/13 EP168	2016-06-01	2017-05-31
835MHz Dipole	SATIMO	SID835	SN 47/12 DIP 0G835-204	2016-03-20	2017-03-19
1900MHz Dipole	SATIMO	SID1900	SN 47/12 DIP 1G900-207	2016-03-20	2017-03-19
2450MHz Dipole	SATIMO	SID2450	SN 13/15 DIP 2G450-364	2016-03-20	2017-03-19
Dielectric Probe Kit	SATIMO	SCLMP	SN 47/12 OCPG49	2016-03-20	2017-03-19
SAM Phantom	SATIMO	SAM	SN/ 47/12 SAM95	N/A	N/A
MULTIMETER	KEITHLEY	Keithley 2000	4006367	2016-06-04	2017-06-03
Signal Generator	Rohde & Schwarz	SMR20	100047	2016-06-04	2017-06-03
Universal Tester	Rohde & Schwarz	CMU200	112012	2016-06-04	2017-06-03
Network Analyzer	HP	8753C	2901A00831	2016-06-04	2017-06-03
Directional Couplers	Agilent	778D	20160	2016-06-04	2017-06-03

5. Tissue Simulating Liquids

5.1 Composition of Tissue Simulating Liquid

For the measurement of the field distribution inside the SAM phantom with SMTIMO, the phantom must be filled with around 25 liters of homogeneous body tissue simulating liquid. For head SAR testing, the liquid height from the ear reference point (ERP) of the phantom to the liquid top surface is larger than 15 cm. For body SAR testing, the liquid height from the center of the flat phantom to the liquid top surface is larger than 15 cm. Please see the following photos for the liquid height.



Liquid Height for Head SAR



Liquid Height for Body SAR

The Composition of Tissue Simulating Liquid

Frequency (MHz)	Water (%)	Salt (%)	Sugar (%)	HEC (%)	Preventol (%)	DGBE (%)
Head						
835	40.3	1.4	57.9	0.2	0.2	0
1900	55.2	0.3	0	0	0	44.5
2450	55.0	0.1	0	0	0	44.9
Body						
835	50.8	0.9	48.2	0	0.1	0.00
1900	70.2	0.4	0	0	0	29.4
2450	68.6	0.1	0	0	0	31.3

5.2 Tissue Dielectric Parameters for Head and Body Phantoms

The head tissue dielectric parameters recommended by the IEEE SCC-34/SC-2 in P1528 have been incorporated in the following table. These head parameters are derived from planar layer models simulating the highest expected SAR for the dielectric properties and tissue thickness variations in a human head. Other head and body tissue parameters that have not been specified in P1528 are derived from the tissue dielectric parameters computed from the 4-Cole-Cole equations described in Reference [12] and extrapolated according to the head parameters specified in P1528.

Target Frequency (MHz)	Head		Body	
	Conductivity (σ)	Permittivity (ϵ_r)	Conductivity (σ)	Permittivity (ϵ_r)
150	0.76	52.3	0.80	61.9
300	0.87	45.3	0.92	58.2
450	0.87	43.5	0.94	56.7
835	0.90	41.5	0.97	55.2
900	0.97	41.5	1.05	55.0
915	0.98	41.5	1.06	55.0
1450	1.20	40.5	1.30	54.0
1610	1.29	40.3	1.40	53.8
1800-2000	1.40	40.0	1.52	53.3
2450	1.80	39.2	1.95	52.7
3000	2.40	38.5	2.73	52.0
5800	5.27	35.3	6.00	48.2

5.3 Tissue Calibration Result

The dielectric parameters of the liquids were verified prior to the SAR evaluation using COMOSAR Dielectric Probe Kit and an Agilent Network Analyzer.

Calibration Result for Dielectric Parameters of Tissue Simulating Liquid

Head Tissue Simulating Liquid									
Freq. MHz.	Temp. (°C)	Conductivity			Permittivity			Limit (%)	Date
		Reading (σ)	Target (σ)	Delta (%)	Reading (ϵ_r)	Target (ϵ_r)	Delta (%)		
835	21.2	0.87	0.90	-3.33	41.11	41.50	-0.94	±5	2017-01-09
1900	21.3	1.38	1.40	-1.43	38.56	40.00	-3.60	±5	2017-01-09
2450	21.3	1.76	1.80	-2.22	38.6	39.2	-1.53	±5	2017-01-09

Body Tissue Simulating Liquid									
Freq. MHz.	Temp. (°C)	Conductivity			Permittivity			Limit (%)	Date
		Reading (σ)	Target (σ)	Delta (%)	Reading (ϵ_r)	Target (ϵ_r)	Delta (%)		
835	21.2	0.95	0.97	-2.06	54.85	55.20	-0.63	±5	2017-01-09
1900	21.3	1.50	1.52	-1.32	52.42	53.30	-1.65	±5	2017-01-09
2450	21.3	2.00	1.95	2.56	52.3	52.7	-0.76	±5	2017-01-09

6. SAR Measurement Evaluation

6.1 Purpose of System Performance Check

The system performance check verifies that the system operates within its specifications. System and operator errors can be detected and corrected. It is recommended that the system performance check be performed prior to any usage of the system in order to guarantee reproducible results. The system performance check uses normal SAR measurements in a simplified setup with a well characterized source. This setup was selected to give a high sensitivity to all parameters that might fail or vary over time. The system check does not intend to replace the calibration of the components, but indicates situations where the system uncertainty is exceeded due to drift or failure.

6.2 System Setup

In the simplified setup for system evaluation, the EUT is replaced by a calibrated dipole and the power source is replaced by a continuous wave which comes from a signal generator at frequency 835 MHz and 1900 MHz. The calibrated dipole must be placed beneath the flat phantom section of the SAM twin phantom with the correct distance holder. The distance holder should touch the phantom surface with a light pressure at the reference marking and be oriented parallel to the long side of the phantom.

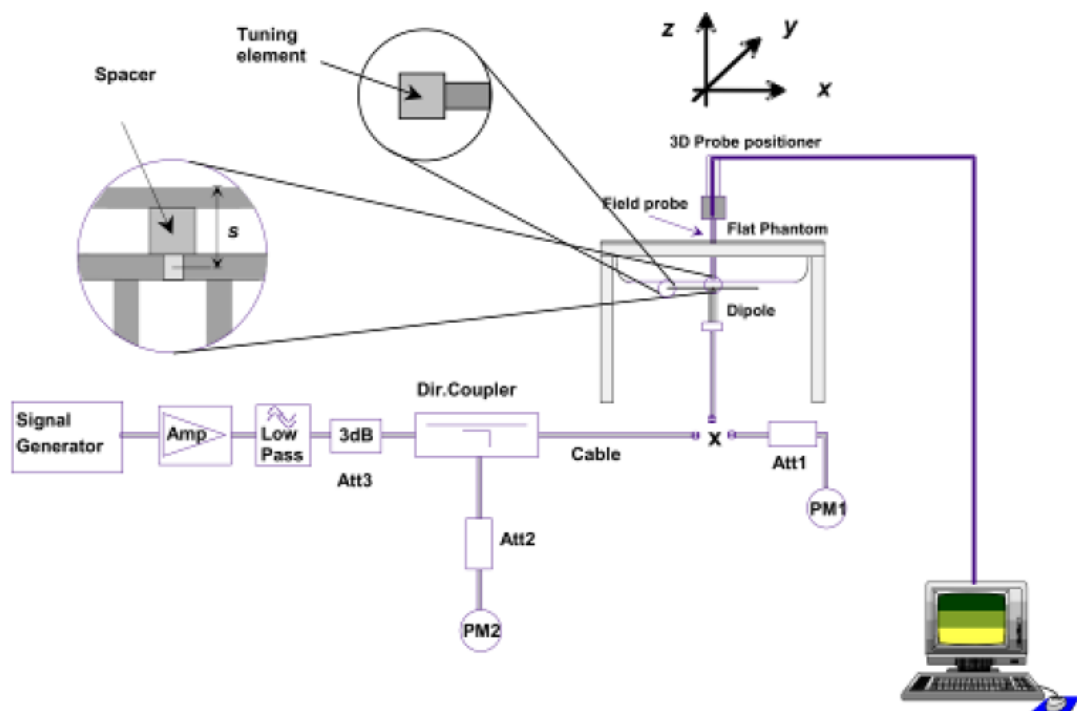

System Verification Setup Block Diagram



Setup Photo of Dipole Antenna

The output power on dipole port must be calibrated to 24 dBm (250 mW) before dipole is connected.

6.3 Validation Results

Comparing to the original SAR value provided by SATIMO, the validation data should be within its specification of 10 %. Table 6.1 shows the target SAR and measured SAR after normalized to 1W input power. The table below indicates the system performance check can meet the variation criterion.

Frequency	Targeted SAR _{1g}	Measured SAR _{1g}	Normalized SAR _{1g}	Tolerance
MHz	(W/kg)	(W/kg)	(W/kg)	(%)
Head				
835	9.67	2.39	9.56	-1.14
1900	39.58	9.91	39.64	0.15
2450	53.69	13.46	53.84	0.28
Body				
835	9.38	2.36	9.44	0.64
1900	39.10	9.80	39.2	0.26
2450	50.41	12.60	50.4	-0.02

Targeted and Measurement SAR

Please refer to Annex A for the plots of system performance check.

7. EUT Testing Position

7.1 Define Two Imaginary Lines on The Handset

- (a) The vertical centerline passes through two points on the front side of the handset - the midpoint of the width w_t of the handset at the level of the acoustic output, and the midpoint of the width w_b of the bottom of the handset.
- (b) The horizontal line is perpendicular to the vertical centerline and passes through the center of the acoustic output. The horizontal line is also tangential to the face of the handset at point A.
- (c) The two lines intersect at point A. Note that for many handsets, point A coincides with the center of the acoustic output; however, the acoustic output may be located elsewhere on the horizontal line. Also note that the vertical centerline is not necessarily parallel to the front face of the handset, especially for clamshell handsets, handsets with flip covers, and other irregularly shaped handsets.

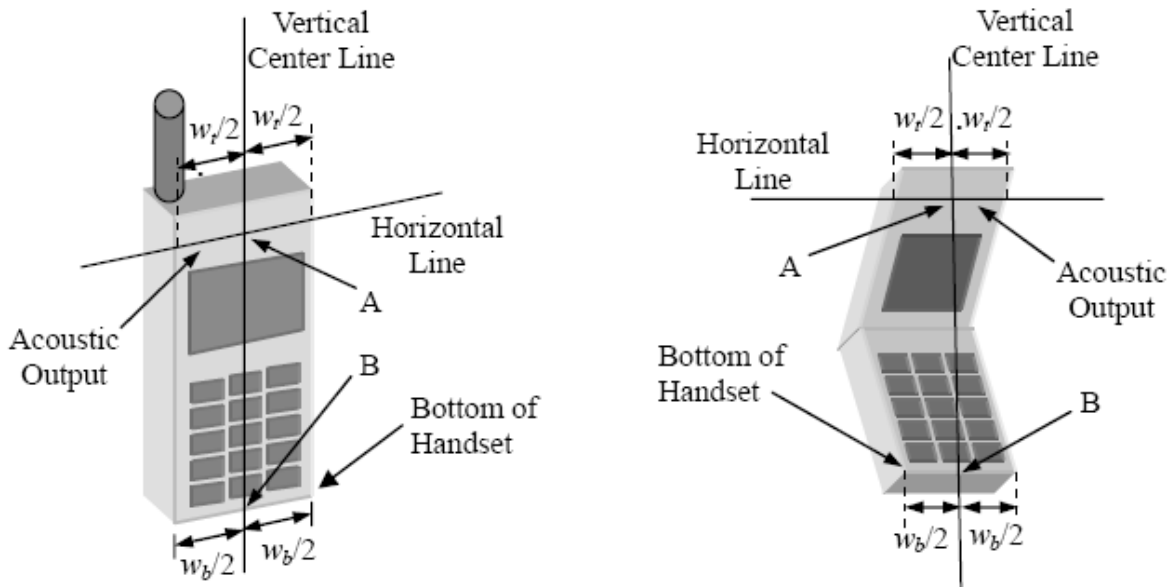

Illustration for Handset Vertical and Horizontal Reference Lines

7.2 Cheek Position

(a) To position the device with the vertical center line of the body of the device and the horizontal line crossing the center piece in a plane parallel to the sagittal plane of the phantom. While maintaining the device in this plane, align the vertical center line with the reference plane containing the three ear and mouth reference point (M: Mouth, RE: Right Ear, and LE: Left Ear) and align the center of the ear piece with the line RE-LE.

(b) To move the device towards the phantom with the ear piece aligned with the line LE-RE until the phone touched the ear. While maintaining the device in the reference plane and maintaining the phone contact with the ear, move the bottom of the phone until any point on the front side is in contact with the cheek of the phantom or until contact with the ear is lost (see Fig. 7.2).

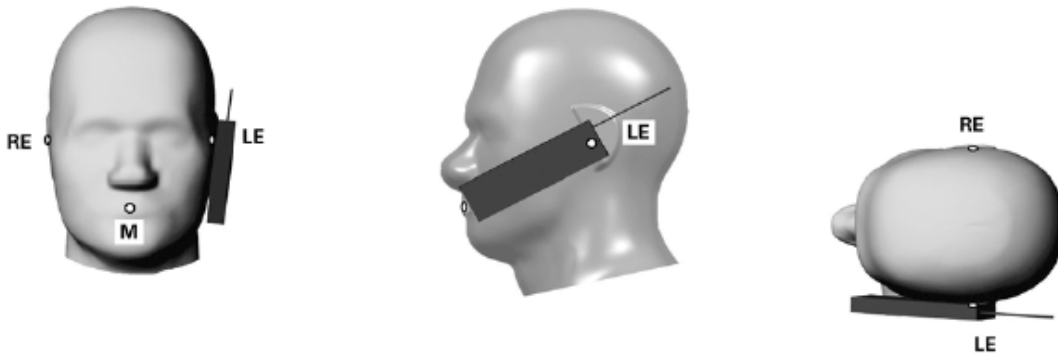

Illustration for Cheek Position

7.3 Tilted Position

(a) To position the device in the “cheek” position described above.

(b) While maintaining the device the reference plane described above and pivoting against the ear, moves it outward away from the mouth by an angle of 15 degrees or until contact with the ear is lost (see Fig. 7.3).

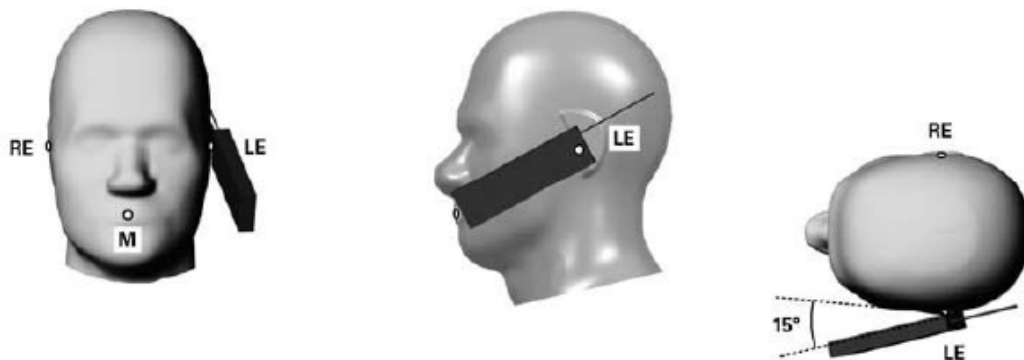

Illustration for Tilted Position

7.4 Body Position

- To position the device parallel to the phantom surface with either keypad up or down.
- To adjust the device parallel to the flat phantom.
- To adjust the distance between the device surface and the flat phantom to 10mm.

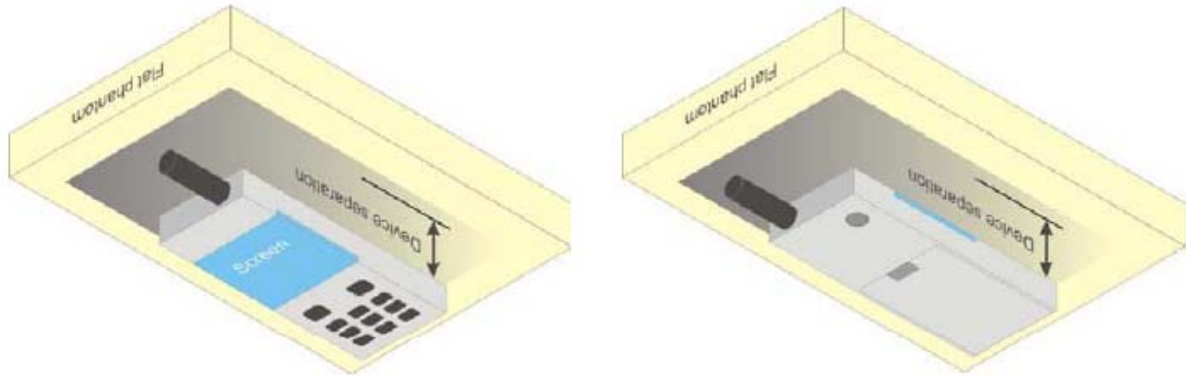
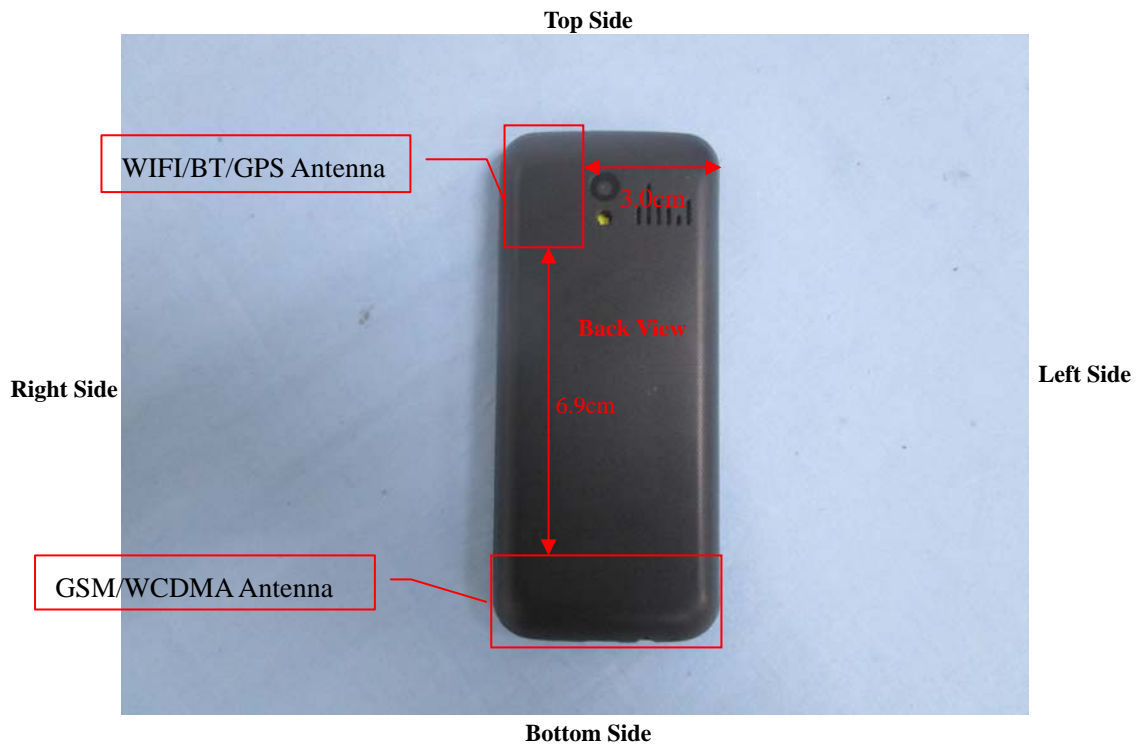

Illustration for Body Position

7.5 EUT Antenna Position



Block Diagram for EUT Antenna Position

7.6 EUT Testing Position

Head/Body-worn/Hotspot mode SAR assessments are required for this device. This EUT was tested in different positions for different SAR test modes, more information as below:

Head SAR tests				
Antennas	Right Cheek	Left Cheek	Right Tilted	Left Tilted
WWAN	Yes	Yes	Yes	Yes
WLAN	Yes	Yes	Yes	Yes

Body(data mode) SAR tests, Test distance: 10mm						
Antennas	Front	Back	Right Side	Left Side	Top Side	Bottom Side
WWAN	Yes	Yes	Yes	Yes	No	Yes
WLAN	Yes	Yes	Yes	No	Yes	No

Body-worn SAR tests, Test distance: 10mm		
Antennas	Front	Back
WWAN	Yes	Yes
WLAN	Yes	Yes

Remark:

1. Referring to KDB 941225 D06, when the overall device length and width are $\geq 9\text{cm} \times 5\text{cm}$, the test separation distances is 10 mm. SAR must be measured for all sides and surfaces with a transmitting antenna located within 25mm from that surface or edge.

Please refer to Annex D for the EUT test setup photos.

8. SAR Measurement Procedures

8.1 Measurement Procedures

The measurement procedures are as follows:

- (a) Use base station simulator (if applicable) or engineering software to transmit RF power continuously (continuous Tx) in the highest power channel.
- (b) Keep EUT to radiate maximum output power or 100% factor (if applicable)
- (c) Measure output power through RF cable and power meter.
- (d) Place the EUT in the positions as Annex E demonstrates.
- (e) Set scan area, grid size and other setting on the SATIMO software.
- (f) Measure SAR results for the highest power channel on each testing position.
- (g) Find out the largest SAR result on these testing positions of each band
- (h) Measure SAR results for other channels in worst SAR testing position if the SAR of highest power channel is larger than 0.8 W/kg

According to the test standard, the recommended procedure for assessing the peak spatial-average SAR value consists of the following steps:

- (a) Power reference measurement
- (b) Area scan
- (c) Zoom scan
- (d) Power drift measurement

8.2 Spatial Peak SAR Evaluation

The procedure for spatial peak SAR evaluation has been implemented according to the test standard. It can be conducted for 1g and 10g, as well as for user-specific masses. The SATIMO software includes all numerical procedures necessary to evaluate the spatial peak SAR value.

The base for the evaluation is a "cube" measurement. The measured volume must include the 1g and 10g cubes with the highest averaged SAR values. For that purpose, the center of the measured volume is aligned to the interpolated peak SAR value of a previously performed area scan.

The entire evaluation of the spatial peak values is performed within the post-processing engine. The system always gives the maximum values for the 1g and 10g cubes. The algorithm to find the cube with highest averaged SAR is divided into the following stages:

- (a) Extraction of the measured data (grid and values) from the Zoom Scan
- (b) Calculation of the SAR value at every measurement point based on all stored data
- (c) Generation of a high-resolution mesh within the measured volume
- (d) Interpolation of all measured values from the measurement grid to the high-resolution grid
- (e) Extrapolation of the entire 3D field distribution to the phantom surface over the distance from sensor to surface
- (f) Calculation of the averaged SAR within masses of 1g and 10g

8.3 Area & Zoom Scan Procedures

First Area Scan is used to locate the approximate location(s) of the local peak SAR value(s). The measurement grid within an Area Scan is defined by the grid extent, grid step size and grid offset. Next, in order to determine the EM field distribution in a three-dimensional spatial extension, Zoom Scan is required. The Zoom Scan measures 5x5x7 points with step size 8, 8 and 5 mm for 300 MHz to 3 GHz, and 8x8x8 points with step size 4, 4 and 2.5 mm for 3 GHz to 6 GHz. The Zoom Scan is performed around the highest E-field value to determine the averaged SAR-distribution over 10 g.

8.4 Volume Scan Procedures

The volume scan is used for assess overlapping SAR distributions for antennas transmitting in different frequency bands. It is equivalent to an oversized zoom scan used in standalone measurements. The measurement volume will be used to enclose all the simultaneous transmitting antennas. For antennas transmitting simultaneously in different frequency bands, the volume scan is measured separately in each frequency band. In order to sum correctly to compute the 1g aggregate SAR, the EUT remain in the same test position for all measurements and all volume scan use the same spatial resolution and grid spacing (step-size is 4, 4 and 2.5 mm). When all volume scan were completed, the software can combine and subsequently superpose these measurement data to calculating the multiband SAR.

8.5 SAR Averaged Methods

The local SAR inside the phantom is measured using small dipole sensing elements inside a probe body. The probe tip must not be in contact with the phantom surface in order to minimize measurements errors, but the highest local SAR will occur at the surface of the phantom.

An extrapolation is using to determinate this highest local SAR values. The extrapolation is based on a fourth-order least-square polynomial fit of measured data. The local SAR value is then extrapolated from the liquid surface with a 1mm step.

The measurements have to be performed over a limited time (due to the duration of the battery) so the step of measurement is high. It could vary between 5 and 8 mm. To obtain an accurate assessment of the maximum SAR averaged over 10g and 1 g requires a very fine resolution in the three dimensional scanned data array.

8.6 Power Drift Monitoring

All SAR testing is under the EUT install full charged battery and transmit maximum output power. In SATIMO measurement software, the power reference measurement and power drift measurement procedures are used for monitoring the power drift of EUT during SAR test. Both these procedures measure the field at a specified reference position before and after the SAR testing. The software will calculate the field difference in dB. If the power drift more than 5%, the SAR will be retested.

9. SAR Test Result

9.1 Conducted RF Output Power

GSM - Burst Average Power (dBm)						
Band	GSM850			PCS1900		
Channel	128	190	251	512	661	810
Frequency (MHz)	824.2	836.4	848.8	1850.2	1880	1909.8
GSM	32.32	32.1	32.15	30.28	30.47	30.56
GPRS (1 slot)	32.25	32.04	32.08	28.9	29.09	29.24
GPRS (2 slots)	31.08	30.72	30.79	28.75	29.02	29.22
GPRS (3 slots)	28.99	28.54	28.56	26.47	26.81	27.04
GPRS (4 slots)	27.75	27.54	27.41	25.45	25.83	26.16
EGPRS (1 slot)	28.58	28.43	28.31	24.27	24.83	25
EGPRS (2 slots)	27.55	27.43	27.28	23.18	23.72	23.87
EGPRS (3 slots)	25.51	25.37	25.19	21.15	21.51	21.68
EGPRS (4 slots)	24.29	24.16	24.01	19.61	20.09	20.15

GSM - Source-Based Time-Average Power (dBm)						
Band	GSM850			PCS1900		
Channel	128	190	251	512	661	810
Frequency (MHz)	824.2	836.4	848.8	1850.2	1880	1909.8
GSM	23.32	23.10	23.15	21.28	21.47	21.56
GPRS (1 slot)	23.25	23.04	23.08	19.90	20.09	20.24
GPRS (2 slots)	25.08	24.72	24.79	22.75	23.02	23.22
GPRS (3 slots)	24.74	24.29	24.31	22.22	22.56	22.79
GPRS (4 slots)	24.75	24.54	24.41	22.45	22.83	23.16
EGPRS (1 slot)	19.58	19.43	19.31	15.27	15.83	16.00
EGPRS (2 slots)	21.55	21.43	21.28	17.18	17.72	17.87
EGPRS (3 slots)	21.26	21.12	20.94	16.90	17.26	17.43
EGPRS (4 slots)	21.29	21.16	21.01	16.61	17.09	17.15

Note: The source-based time-averaged power is linearly scaled the maximum burst averaged power based on time slots. The calculated method are shown as below:

Source based time-average power = Burst averaged power - Duty cycle factor in dB

Remark:

1. For Head SAR testing, GSM and GPRS 2-slots should be evaluated, therefore the EUT was set in GSM and GPRS 2-slots for GSM850 and GSM1900 due to its highest source-based time-average power.
2. For Body SAR testing, GPRS should be evaluated, therefore the EUT was set in GPRS (2Tx slots) for GSM850 and GSM1900 due to its highest source-based time-average power.
3. Per KDB 447498 D01 v06, the maximum output power channel is used for SAR testing and for further SAR test reduction.
4. The DUT do not support DTM function.

WCDMA - Average Power (dBm)						
Band	WCDMA Band II			WCDMA Band V		
Channel	9262	9400	9538	4132	4183	4233
Frequency (MHz)	1852.4	1880.0	1907.6	826.4	836.6	846.6
RMC 12.2k	21.93	22.49	22.78	22.73	22.62	22.39
HSDPA Subtest-1	20.55	20.51	21.17	22.14	21.21	21.41
HSDPA Subtest-2	20.56	20.53	21.21	22.14	21.19	21.42
HSDPA Subtest-3	20.52	20.56	21.15	22.16	21.18	21.39
HSDPA Subtest-4	20.53	20.51	21.14	22.15	21.21	21.38
HSUPA Subtest-1	21.62	21.55	22.02	22.13	21.19	21.31
HSUPA Subtest-2	21.62	21.48	21.95	22.11	21.11	21.3
HSUPA Subtest-3	21.54	21.45	21.88	22.12	21.09	21.26
HSUPA Subtest-4	21.53	21.46	21.86	22.09	21.08	21.24
HSUPA Subtest-5	21.45	21.49	21.74	22.08	21.08	21.21

Remark:

1. For Head SAR, per KDB 941225 D01 v03, RMC 12.2kbps setting is used to evaluate SAR. If AMR 12.2kbps power is < 1/4 dB higher than RMC, SAR tests with AMR 12.2kbps can be excluded.
2. For Body SAR, per KDB 941225 D01 v03, RMC 12.2kbps setting is used to evaluate SAR. If HSDPA subset-1 output power is < 1/4 dB higher than RMC, and SAR with RMC 12.2kbps setting is $\leq 1.2\text{W/kg}$, HSDPA SAR evaluation can be excluded.

WLAN - Maximum Average Power				
Test Mode	Data Rate	Channel	Frequency (MHz)	Average Power (dBm)
802.11b	1Mbps	CH 01	2412	16.94
		CH 06	2437	17.48
		CH 11	2462	17.65
802.11g	54Mbps	CH 01	2412	16.82
		CH 06	2437	17.07
		CH 11	2462	17.04
802.11n (20MHz)	MCS7	CH 01	2412	17.39
		CH 06	2437	17.4
		CH 11	2462	17.15

Remark:

1. Per KDB 248227 D01 v02r02, choose the highest output power channel to test SAR and determine further SAR exclusion
2. Per KDB 248227 D01 v02r02, if 11g and 11n average output power is higher than 1/4 dB higher than 11b mode, SAR will be verified.
3. For each frequency band, testing at higher data rates and higher order modulations is not required when the maximum average output power for each of these configurations is less than 1/4 dB higher than those measured at the lowest data rate. For 802.11n mode, SAR test according to the highest power channel with correspondence data rates.

Bluetooth - Maximum Average Power		
Test Mode	Data Rate	Average Power(dBm)
GFSK	1Mbps	3.593
Pi/4 QDPSK	2Mbps	3.186
8DPSK	3Mbps	3.622

Bluetooth - Maximum Average Power				
Test Mode	Data Rate	Channel	Frequency (MHz)	Average Power (dBm)
BLE	1Mbps	CH 00	2402	-5.769
		CH 19	2440	-5.197
		CH 39	2480	-5.011

Remark:

Bluetooth maximum output power is 3.622dBm, and Tune-Up output power is 4.0dBm. Per KDB 447498 D01 v06, the 1-g and 10-g SAR test exclusion thresholds for 100 MHz to 6 GHz at test separation distances ≤ 50 mm are determined by:

$[(\text{max. power of channel, including tune-up tolerance, mW}) / (\text{min. test separation distance, mm})] \cdot [\sqrt{f(\text{GHz})}] \leq 3.0$ for 1-g SAR and ≤ 7.5 for 10-g extremity SAR,16 where

- f(GHz) is the RF channel transmit frequency in GHz
- Power and distance are rounded to the nearest mW and mm before calculation¹⁷
- The result is rounded to one decimal place for comparison

Tune-Up Power (dBm)	Max. Power (mW)	Distance (mm)	Frequency (GHz)	Result	Limit
4.0	2.51	5	2.480	0.79	3

The exclusion thresholds is $0.79 < 3$, therefore, the RF exposure evaluation is not required.

9.2 Test Results for Standalone SAR Test

Head SAR

GSM850 – Head SAR Test									
Plot No.	Mode	Test Position Head	Frequency		Output Power (dBm)	Rated Limit (dBm)	Scaling Factor	SAR1g (W/kg)	Scaled SAR1g (W/kg)
			CH.	MHz					
1.	GSM Voice	Right Cheek	128	824.2	32.32	32.5	1.0423	0.1537	0.1602
2.	GSM Voice	Right Tilted	128	824.2	32.32	32.5	1.0423	0.1028	0.1072
3.	GSM Voice	Left Cheek	128	824.2	32.32	32.5	1.0423	0.1715	0.1788
4.	GSM Voice	Left Tilted	128	824.2	32.32	32.5	1.0423	0.1283	0.1337

GSM1900 – Head SAR Test									
Plot No.	Mode	Test Position Head	Frequency		Output Power (dBm)	Rated Limit (dBm)	Scaling Factor	SAR1g (W/kg)	Scaled SAR1g (W/kg)
			CH.	M Hz					
5.	GSM	Right Cheek	810	1909.8	30.56	31.0	1.1066	0.0601	0.0665
6.	GSM	Right Tilted	810	1909.8	30.56	31.0	1.1066	0.0325	0.0360
7.	GSM	Left Cheek	810	1909.8	30.56	31.0	1.1066	0.1244	0.1377
8.	GSM	Left Tilted	810	1909.8	30.56	31.0	1.1066	0.0537	0.0594

GSM850 – Head SAR Test									
Plot No.	Mode	Test Position Head	Frequency		Output Power (dBm)	Rated Limit (dBm)	Scaling Factor	SAR1g (W/kg)	Scaled SAR1g (W/kg)
			CH.	MHz					
9.	GPRS_2TX	Right Cheek	128	824.2	31.08	31.5	1.1015	0.2551	0.2810
10.	GPRS_2TX	Right Tilted	128	824.2	31.08	31.5	1.1015	0.1526	0.1681
11.	GPRS_2TX	Left Cheek	128	824.2	31.08	31.5	1.1015	0.2648	0.2917
12.	GPRS_2TX	Left Tilted	128	824.2	31.08	31.5	1.1015	0.1629	0.1794

GSM1900 – Head SAR Test									
Plot No.	Mode	Test Position Head	Frequency		Output Power (dBm)	Rated Limit (dBm)	Scaling Factor	SAR1g (W/kg)	Scaled SAR1g (W/kg)
			CH.	M Hz					
13.	GPRS_2TX	Right Cheek	810	1909.8	29.22	29.5	1.0666	0.3030	0.3232
14.	GPRS_2TX	Right Tilted	810	1909.8	29.22	29.5	1.0666	0.1627	0.1735
15.	GPRS_2TX	Left Cheek	810	1909.8	29.22	29.5	1.0666	0.2852	0.3042
16.	GPRS_2TX	Left Tilted	810	1909.8	29.22	29.5	1.0666	0.1767	0.1885

WCDMA Band V – Head SAR Test									
Plot No.	Mode	Test Position Head	Frequency		Output Power (dBm)	Rated Limit (dBm)	Scaling Factor	SAR1g (W/kg)	Scaled SAR1g (W/kg)
			CH.	MHz					
17.	RMC	Right Cheek	4132	826.4	22.73	23.0	1.0641	0.2211	0.2353
18.	RMC	Right Tilted	4132	826.4	22.73	23.0	1.0641	0.1526	0.1624
19.	RMC	Left Cheek	4132	826.4	22.73	23.0	1.0641	0.2216	0.2358
20.	RMC	Left Tilted	4132	826.4	22.73	23.0	1.0641	0.1655	0.1761

WCDMA Band II – Head SAR Test									
Plot No.	Mode	Test Position Head	Frequency		Output Power (dBm)	Rated Limit (dBm)	Scaling Factor	SAR1g (W/kg)	Scaled SAR1g (W/kg)
			CH.	MHz					
21.	RMC	Right Cheek	9538	1907.6	22.78	23.0	1.0520	0.2583	0.2717
22.	RMC	Right Tilted	9538	1907.6	22.78	23.0	1.0520	0.1418	0.1492
23.	RMC	Left Cheek	9538	1907.6	22.78	23.0	1.0520	0.2969	0.3123
24.	RMC	Left Tilted	9538	1907.6	22.78	23.0	1.0520	0.1982	0.2085

WLAN 2.4GHz – Head SAR Test									
Plot No.	Mode	Test Position Head	Frequency		Output Power (dBm)	Rated Limit (dBm)	Scaling Factor	SAR1g (W/kg)	Scaled SAR1g (W/kg)
			CH.	MHz					
25.	802.11b	Right Cheek	11	2462	17.65	18.0	1.0839	0.5490	0.5951
26.	802.11b	Right Tilted	11	2462	17.65	18.0	1.0839	0.3213	0.3483
27.	802.11b	Left Cheek	11	2462	17.65	18.0	1.0839	0.6796	0.7366
28.	802.11b	Left Tilted	11	2462	17.65	18.0	1.0839	0.4137	0.4484

Remark: Per KDB447498 D01 v06, if the highest output channel SAR for each exposure position ≤ 0.8 W/kg other channels SAR tests are not necessary.

Body-worn SAR

GSM850 – Body SAR Test (Gap: 10mm)									
Plot No.	Mode	Test Position Body	Frequency		Output Power (dBm)	Rated Limit (dBm)	Scaling Factor	SAR1g (W/kg)	Scaled SAR1g (W/kg)
			CH.	MHz					
29.	GSM Voice	Back	128	824.2	32.32	32.5	1.0423	0.4559	0.4752
30.	GSM Voice	Front	128	824.2	32.32	32.5	1.0423	0.1310	0.1365

GSM1900 – Body SAR Test (Gap: 10mm)									
Plot No.	Mode	Test Position Body	Frequency		Output Power (dBm)	Rated Limit (dBm)	Scaling Factor	SAR1g (W/kg)	Scaled SAR1g (W/kg)
			CH.	MHz					
31.	GSM Voice	Back	810	1909.8	30.56	31.0	1.1066	0.7148	0.7910
32.	GSM Voice	Front	810	1909.8	30.56	31.0	1.1066	0.2523	0.2792

Body(data mode) SAR

GSM850 – Body SAR Test (Gap: 10mm)									
Plot No.	Mode	Test Position Body	Frequency		Output Power (dBm)	Rated Limit (dBm)	Scaling Factor	SAR1g (W/kg)	Scaled SAR1g (W/kg)
			CH.	MHz					
33.	GPRS_2TX	Back Side	128	824.2	31.08	31.5	1.1015	0.7984	0.8795
34.	GPRS_2TX	Front Side	128	824.2	31.08	31.5	1.1015	0.1866	0.2055
35.	GPRS_2TX	Bottom side	128	824.2	31.08	31.5	1.1015	0.0418	0.0460
36.	GPRS_2TX	Right side	128	824.2	31.08	31.5	1.1015	0.2273	0.2504
37.	GPRS_2TX	Left side	128	824.2	31.08	31.5	1.1015	0.2116	0.2331

GSM1900 – Body SAR Test (Gap: 10mm)									
Plot No.	Mode	Test Position Body	Frequency		Output Power (dBm)	Rated Limit (dBm)	Scaling Factor	SAR1g (W/kg)	Scaled SAR1g (W/kg)
			CH.	MHz					
38.	GPRS_2TX	Back Side	810	1909.8	29.22	29.5	1.0666	0.4079	0.4351
39.	GPRS_2TX	Front Side	810	1909.8	29.22	29.5	1.0666	0.3345	0.3568
40.	GPRS_2TX	Bottom side	810	1909.8	29.22	29.5	1.0666	0.3801	0.4054
41.	GPRS_2TX	Right side	810	1909.8	29.22	29.5	1.0666	0.1339	0.1428
42.	GPRS_2TX	Left side	810	1909.8	29.22	29.5	1.0666	0.1621	0.1729

WCDMA Band V – Body SAR Test (Gap: 10mm)									
Plot No.	Mode	Test Position Body	Frequency		Output Power (dBm)	Rated Limit (dBm)	Scaling Factor	SAR1g (W/kg)	Scaled SAR1g (W/kg)
			CH.	MHz					
43.	RMC 12.2k	Back Side	4132	826.4	22.73	23.0	1.0641	0.6496	0.6913
44.	RMC 12.2k	Front Side	4132	826.4	22.73	23.0	1.0641	0.1919	0.2042
45.	RMC 12.2k	Bottom side	4132	826.4	22.73	23.0	1.0641	0.0425	0.0452
46.	RMC 12.2k	Right side	4132	826.4	22.73	23.0	1.0641	0.2442	0.2599
47.	RMC 12.2k	Left side	4132	826.4	22.73	23.0	1.0641	0.1438	0.1530

WCDMA Band II – Body SAR Test (Gap: 10mm)									
Plot No.	Mode	Test Position Body	Frequency		Output Power (dBm)	Rated Limit (dBm)	Scaling Factor	SAR1g (W/kg)	Scaled SAR1g (W/kg)
			CH.	MHz					
48.	RMC 12.2k	Back Side	9538	1907.6	22.78	23.0	1.0520	0.7841	0.8248
49.	RMC 12.2k	Front Side	9538	1907.6	22.78	23.0	1.0520	0.2642	0.2779
50.	RMC 12.2k	Bottom side	9538	1907.6	22.78	23.0	1.0520	0.2986	0.3141
51.	RMC 12.2k	Right side	9538	1907.6	22.78	23.0	1.0520	0.2155	0.2267
52.	RMC 12.2k	Left side	9538	1907.6	22.78	23.0	1.0520	0.1781	0.1874

WLAN 2.4GHz –Body SAR Test									
Plot No.	Mode	Test Position Body	Frequency		Output Power (dBm)	Rated Limit (dBm)	Scaling Factor	SAR1g (W/kg)	Scaled SAR1g (W/kg)
			CH.	MHz					
53.	802.11b	Back Side	11	2462	17.65	18.0	1.0839	0.5366	0.5816
54.	802.11b	Front Side	11	2462	17.65	18.0	1.0839	0.2435	0.2639
55.	802.11b	Right side	11	2462	17.65	18.0	1.0839	0.3038	0.3293
56.	802.11b	Top Side	11	2462	17.65	18.0	1.0839	0.3663	0.3970

Remark: Per KDB447498 D01 v06, if the highest output channel SAR for each exposure position ≤ 0.8 W/kg other channels SAR tests are not necessary.

9.3 Simultaneous Multi-band Transmission SAR Analysis

List of Mode for Simultaneous Multi-band Transmission

No.	Configurations	Head SAR	Body-worn SAR	Hotspot SAR
1	GSM(Voice) + WLAN(Data)	Yes	Yes	-
2	GPRS/EDGE (Data) + WLAN(Data)	-	-	Yes
3	WCDMA (Voice)+ WLAN(Data)	Yes	Yes	-
4	HSDPA(Data) + WLAN(Data)	-	-	Yes
5	HSUPA(Data) + WLAN(Data)	-	-	Yes
6	GSM(Voice) + Bluetooth(Data)	Yes	Yes	-
7	GPRS/EDGE (Data) + Bluetooth(Data)	-	-	Yes
8	WCDMA(Voice) + Bluetooth(Data)	Yes	Yes	-
9	HSDPA(Data)+ Bluetooth(Data)	-	-	Yes
10	HSUPA(Data) + Bluetooth(Data)	-	-	Yes

Remark:

- GSM and WCDMA share the same antenna, and cannot transmit simultaneously.
- WLAN and Bluetooth share the same antenna, and cannot transmit simultaneously.
- According to the KDB 447498 D01 v06, when standalone SAR test exclusion applies to an antenna that transmits simultaneously with other antennas, the standalone SAR must be estimated according to following to determine simultaneous transmission SAR test exclusion:
 $(\text{max. power of channel, including tune-up tolerance, mW}) / (\text{min. test separation distance, mm}) \cdot [\sqrt{f(\text{GHz})} / x] \text{ W/kg}$ for test separation distances $\leq 50 \text{ mm}$;
 where $x = 7.5$ for 1-g SAR, and $x = 18.75$ for 10-g SAR.
 For simultaneous transmission analysis, Bluetooth SAR is estimated per KDB 447498 D01 v06 as below:

Bluetooth:

Tune-Up Power (dBm)	Max. Power (mW)	Distance (mm)	Frequency (GHz)	X	SAR(1g) 5mm	SAR(1g) 10mm
4.0	2.51	5/10	2.480	7.5	0.1054	0.0527

- The maximum SAR summation is calculated based on the same configuration and test position.

Head SAR
GSM and WLAN

Position	WWAN		WLAN	Summed SAR (W/kg)
	Band	Scaled SAR (W/kg)	Scaled SAR (W/kg)	
Right Cheek	GSM850 Voice	0.2810	0.5951	0.8761
Right Tilted	GSM850 Voice	0.1681	0.3483	0.5164
Left Cheek	GSM850 Voice	0.2917	0.7366	1.0283
Left Tilted	GSM850 Voice	0.1794	0.4484	0.6278
Right Cheek	GSM1900 Voice	0.3232	0.5951	0.9183
Right Tilted	GSM1900 Voice	0.1735	0.3483	0.5218
Left Cheek	GSM1900 Voice	0.3042	0.7366	1.0408
Left Tilted	GSM1900 Voice	0.1885	0.4484	0.6369

WCDMA and WLAN

Position	WWAN		WLAN	Summed SAR (W/kg)
	Band	Scaled SAR (W/kg)	Scaled SAR (W/kg)	
Right Cheek	WCDMA Band V	0.2353	0.5951	0.8304
Right Tilted	WCDMA Band V	0.1624	0.3483	0.5107
Left Cheek	WCDMA Band V	0.2358	0.7366	0.9724
Left Tilted	WCDMA Band V	0.1761	0.4484	0.6245
Right Cheek	WCDMA Band II	0.2717	0.5951	0.8668
Right Tilted	WCDMA Band II	0.1492	0.3483	0.4975
Left Cheek	WCDMA Band II	0.3123	0.7366	1.0489
Left Tilted	WCDMA Band II	0.2085	0.4484	0.6569

GSM and Bluetooth

Position	WWAN		Bluetooth	Summed SAR (W/kg)
	Band	Scaled SAR (W/kg)	Scaled SAR (W/kg)	
Right Cheek	GSM850	0.2810	0.1054	0.3864
Right Tilted	GSM850	0.1681	0.1054	0.2735
Left Cheek	GSM850	0.2917	0.1054	0.3971
Left Tilted	GSM850	0.1794	0.1054	0.2848
Right Cheek	GSM1900	0.3232	0.1054	0.4286
Right Tilted	GSM1900	0.1735	0.1054	0.2789
Left Cheek	GSM1900	0.3042	0.1054	0.4096
Left Tilted	GSM1900	0.1885	0.1054	0.2939

WCDMA and Bluetooth

Position	WWAN		Bluetooth	Summed SAR (W/kg)
	Band	Scaled SAR (W/kg)	Scaled SAR (W/kg)	
Right Cheek	WCDMA Band V	0.2353	0.1054	0.3407
Right Tilted	WCDMA Band V	0.1624	0.1054	0.2678
Left Cheek	WCDMA Band V	0.2358	0.1054	0.3412
Left Tilted	WCDMA Band V	0.1761	0.1054	0.2815
Right Cheek	WCDMA Band II	0.2717	0.1054	0.3771
Right Tilted	WCDMA Band II	0.1492	0.1054	0.2546
Left Cheek	WCDMA Band II	0.3123	0.1054	0.4177
Left Tilted	WCDMA Band II	0.2085	0.1054	0.3139

Body-worn SAR
GSM and WLAN

Position	WWAN		WLAN	Summed SAR (W/kg)
	Band	Scaled SAR (W/kg)	Scaled SAR (W/kg)	
Back	GSM850 Voice	0.4752	0.5816	1.0568
Front	GSM850 Voice	0.1365	0.2639	0.4004
Back	GSM1900 Voice	0.7910	0.5816	1.3726
Front	GSM1900 Voice	0.2792	0.2639	0.5431

GSM and Bluetooth

Position	WWAN		Bluetooth	Summed SAR (W/kg)
	Band	Scaled SAR (W/kg)	Scaled SAR (W/kg)	
Back	GSM850 Voice	0.4752	0.0527	0.5279
Front	GSM850 Voice	0.1365	0.0527	0.1892
Back	GSM1900 Voice	0.7910	0.0527	0.8437
Front	GSM1900 Voice	0.2792	0.0527	0.3319

Hotspot SAR
GPRS and WLAN

	WWAN			WLAN	Hotspot SAR (W/kg)
Position	Band	Mode	Scaled SAR (W/kg)	Scaled SAR (W/kg)	
Back	GPRS850	GPRS_2TX	0.8795	0.5816	1.4611
Front	GPRS850	GPRS_2TX	0.2055	0.2639	0.4694
Top side	GPRS850	GPRS_2TX	--	0.3970	0.3970
Bottom side	GPRS850	GPRS_2TX	0.0460	--	0.0460
Right side	GPRS850	GPRS_2TX	0.2504	0.3293	0.5797
Left side	GPRS850	GPRS_2TX	0.2331	--	0.2331
Back	GPRS1900	GPRS_2TX	0.4351	0.5816	1.0167
Front	GPRS1900	GPRS_2TX	0.3568	0.2639	0.6207
Top side	GPRS1900	GPRS_2TX	--	0.3970	0.3970
Bottom side	GPRS1900	GPRS_2TX	0.4054	--	0.4054
Right side	GPRS1900	GPRS_2TX	0.1428	0.3293	0.4721
Left side	GPRS1900	GPRS_2TX	0.1729	--	0.1729

WCDMA and WLAN

	WWAN			WLAN	Hotspot SAR (W/kg)
Position	Band	Mode	Scaled SAR (W/kg)	Scaled SAR (W/kg)	
Back	WCDMA Band V	RMC 12.2K	0.6913	0.5816	1.2729
Front	WCDMA Band V	RMC 12.2K	0.2042	0.2639	0.4681
Top side	WCDMA Band V	RMC 12.2K	--	0.3970	0.3970
Bottom side	WCDMA Band V	RMC 12.2K	0.0452	--	0.0452
Right side	WCDMA Band V	RMC 12.2K	0.2599	0.3293	0.5892
Left side	WCDMA Band V	RMC 12.2K	0.1530	--	0.1530
Back	WCDMA Band II	RMC 12.2K	0.8248	0.5816	1.4064
Front	WCDMA Band II	RMC 12.2K	0.2779	0.2639	0.5418
Top side	WCDMA Band II	RMC 12.2K	--	0.3970	0.3970
Bottom side	WCDMA Band II	RMC 12.2K	0.3141	--	0.3141
Right side	WCDMA Band II	RMC 12.2K	0.2267	0.3293	0.556
Left side	WCDMA Band II	RMC 12.2K	0.1874	--	0.1874

GPRS and Bluetooth

Position	WWAN		Bluetooth	Hotspot SAR (W/kg)
	Band	Scaled SAR (W/kg)	Scaled SAR (W/kg)	
Back	GPRS850	0.8795	0.0527	0.9322
Front	GPRS850	0.2055	0.0527	0.2582
Top side	GPRS850	--	0.0527	0.0527
Bottom side	GPRS850	0.0460	--	0.0460
Right side	GPRS850	0.2504	0.0527	0.3031
Left side	GPRS850	0.2331	--	0.2331
Back	GPRS1900	0.4351	0.0527	0.4878
Front	GPRS1900	0.3568	0.0527	0.4095
Top side	GPRS1900	--	0.0527	0.0527
Bottom side	GPRS1900	0.4054	--	0.4054
Right side	GPRS1900	0.1428	0.0527	0.1955
Left side	GPRS1900	0.1729	--	0.1729

WCDMA and Bluetooth

Position	WWAN		Bluetooth	Hotspot SAR (W/kg)
	Band	Scaled SAR (W/kg)	Scaled SAR (W/kg)	
Back	WCDMA Band V	0.6913	0.0527	0.7440
Front	WCDMA Band V	0.2042	0.0527	0.2569
Top side	WCDMA Band V	--	0.0527	0.0527
Bottom side	WCDMA Band V	0.0452	--	0.0452
Right side	WCDMA Band V	0.2599	0.0527	0.3126
Left side	WCDMA Band V	0.1530	--	0.1530
Back	WCDMA Band II	0.8248	0.0527	0.8775
Front	WCDMA Band II	0.2779	0.0527	0.3306
Top side	WCDMA Band II	--	0.0527	0.0527
Bottom side	WCDMA Band II	0.3141	--	0.3141
Right side	WCDMA Band II	0.2267	0.0527	0.2794
Left side	WCDMA Band II	0.1874	--	0.1874

10. Measurement Uncertainty

10.1 Uncertainty for EUT SAR Test

a	b	c	d	e= f(d,k)	f	g	h= c*f/e	i= c*g/e	k
Uncertainty Component	Sec.	Tol (+- %)	Prob. Dist.	Div.	Ci (1g)	Ci (10g)	1g Ui (+- %)	10g Ui (+- %)	Vi
Measurement System									
Probe calibration	E.2.1	7.0	N	1	1	1	7.00	7.00	∞
Axial Isotropy	E.2.2	2.5	R	$\sqrt{3}$	$(1_{Cp})^{1/2}$	$(1_{Cp})^{1/2}$	1.02	1.02	∞
Hemispherical Isotropy	E.2.2	4.0	R	$\sqrt{3}$	$(Cp)^{1/2}$	$(Cp)^{1/2}$	1.63	1.63	∞
Boundary effect	E.2.3	1.0	R	$\sqrt{3}$	1	1	0.58	0.58	∞
Linearity	E.2.4	5.0	R	$\sqrt{3}$	1	1	2.89	2.89	∞
System detection limits	E.2.5	1.0	R	$\sqrt{3}$	1	1	0.58	0.58	∞
Readout Electronics	E.2.6	0.02	N	1	1	1	0.02	0.02	∞
Reponse Time	E.2.7	3.0	R	$\sqrt{3}$	1	1	1.73	1.73	∞
Integration Time	E.2.8	2.0	R	$\sqrt{3}$	1	1	1.15	1.15	∞
RF ambient Conditions – Noise	E.6.1	3.0	R	$\sqrt{3}$	1	1	1.73	1.73	∞
RF ambient Conditions - Reflections	E.6.1	3.0	R	$\sqrt{3}$	1	1	1.73	1.73	∞
Probe positioner Mechanical Tolerance	E.6.2	2.0	R	$\sqrt{3}$	1	1	1.15	1.15	∞
Probe positioning with respect to Phantom Shell	E.6.3	0.05	R	$\sqrt{3}$	1	1	0.03	0.03	∞
Extrapolation, interpolation and integration Algorithms for Max. SAR Evaluation	E.5	5.0	R	$\sqrt{3}$	1	1	2.89	2.89	∞
Test Sample Related									
Test sample positioning	E.4.2	0.03	N	1	1	1	0.03	0.03	N-1
Device Holder Uncertainty	E.4.1	5.00	N	1	1	1	5.00	5.00	
Output power Variation - SAR drift measurement	E.2.9	12.02	R	$\sqrt{3}$	1	1	6.94	6.94	∞
SAR scaling	E6.5	0.0	R	$\sqrt{3}$	1	1	0.0	0.0	∞
Phantom and Tissue Parameters									
Phantom Uncertainty (Shape and thickness tolerances)	E.3.1	0.05	R	$\sqrt{3}$	1	1	0.03	0.03	∞
Uncertainty in SAR correction for deviations in permittivity and conductivity	E3.2	1.9	R	$\sqrt{3}$	1	0.84	1.10	0.90	∞
Liquid conductivity - deviation	E.3.2	5.00	R	$\sqrt{3}$	0.64	0.43	1.85	1.24	∞

from target value										
Liquid conductivity measurement uncertainty	E.3.3	5.00	N	1	0.64	0.43	3.20	2.15	∞	
Liquid permittivity - deviation from target value	E.3.2	0.37	R	$\sqrt{3}$	0.6	0.49	0.13	0.10	∞	
Liquid permittivity measurement uncertainty	E.3.3	10.00	N	1	0.6	0.49	6.00	4.90	∞	
Combined Standard Uncertainty			RSS				12.98	12.53		
Expanded Uncertainty (95% Confidence interval)			K=2				25.32	24.43		

10.2 Uncertainty for System Performance Check

a	b	c	d	e= f(d,k)	f	g	h= c*f/e	i= c*g/e	k
Uncertainty Component	Sec.	Tol (+- %)	Prob. Dist.	Div.	Ci (1g)	Ci (10g)	1g Ui (+- %)	10g Ui (+- %)	Vi
Measurement System									
Probe calibration	E.2.1	7.0	N	1	1	1	7.00	7.00	∞
Axial Isotropy	E.2.2	2.5	R	$\sqrt{3}$	$(1_{Cp})^{1/2}$	$(1_{Cp})^{1/2}$	1.02	1.02	∞
Hemispherical Isotropy	E.2.2	4.0	R	$\sqrt{3}$	$(Cp)^{1/2}$	$(Cp)^{1/2}$	1.63	1.63	∞
Boundary effect	E.2.3	1.0	R	$\sqrt{3}$	1	1	0.58	0.58	∞
Linearity	E.2.4	5.0	R	$\sqrt{3}$	1	1	2.89	2.89	∞
System detection limits	E.2.5	1.0	R	$\sqrt{3}$	1	1	0.58	0.58	∞
Modulation response	E.2.5	0	R	$\sqrt{3}$	0	0	0.0	0.0	∞
Readout Electronics	E.2.6	0.02	N	1	1	1	0.02	0.02	∞
Reponse Time	E.2.7	3.0	R	$\sqrt{3}$	1	1	1.73	1.73	∞
Integration Time	E.2.8	2.0	R	$\sqrt{3}$	1	1	1.15	1.15	∞
RF ambient Conditions – Noise	E.6.1	3.0	R	$\sqrt{3}$	1	1	1.73	1.73	∞
RF ambient Conditions - Reflections	E.6.1	3.0	R	$\sqrt{3}$	1	1	1.73	1.73	∞
Probe positioner Mechanical Tolerance	E.6.2	2.0	R	$\sqrt{3}$	1	1	1.15	1.15	∞
Probe positioning with respect to Phantom Shell	E.6.3	0.05	R	$\sqrt{3}$	1	1	0.03	0.03	∞
Extrapolation, interpolation and integration Algorithms for Max.	E.5.2	5.0	R	$\sqrt{3}$	1	1	2.89	2.89	∞

SAR Evaluation									
Dipole									
Dipole axis to liquid Distance	8,E.4.2	1.00	N	$\sqrt{3}$	1	1	0.58	0.58	N-1
Input power and SAR drift measurement	8,6.6.2	12.02	R	$\sqrt{3}$	1	1	6.94	6.94	∞
Deviation of experimental dipole from numerical dipole	E.6.4	5.5	R	$\sqrt{3}$	1	1	3.20	3.20	∞
Phantom and Tissue Parameters									
Phantom Uncertainty (Shape and thickness tolerances)	E.3.1	0.05	R	$\sqrt{3}$	1	1	0.03	0.03	∞
Uncertainty in SAR correction for deviations in permittivity and conductivity	E3.2	2.0	R	$\sqrt{3}$	1	0.84	1.10	1.10	∞
Liquid conductivity - deviation from target value	E.3.2	5.00	R	$\sqrt{3}$	0.64	0.43	1.85	1.24	
Liquid conductivity - measurement uncertainty	E.3.3	5.00	N	1	0.64	0.43	3.20	2.15	
Liquid permittivity - deviation from target value	E.3.2	0.37	R	$\sqrt{3}$	0.6	0.49	0.13	0.10	
Liquid permittivity - measurement uncertainty	E.3.3	10.00	N	1	0.6	0.49	6.00	4.90	M
Combined Standard Uncertainty			RSS				12.00	11.50	
Expanded Uncertainty (95% Confidence interval)			K=2				23.39	22.43	

Annex A. Plots of System Performance Check

MEASUREMENT 1

For Head Liquid

Type: Validation measurement (Fast, 75.00 %)

Date of measurement: 01/09/2017

Measurement duration: 7 minutes 21 seconds

E-field Probe: SSE5 - SN 09/13 EP168; ConvF: 6.93; Calibrated: 06/01/2016

A. Experimental conditions

Area Scan	dx=8mm dy=8mm
Phantom	Validation plane
Device Position	Dipole
Band	CW835
Signal	Duty Cycle 1:1

B. SAR Measurement Results

Frequency (MHz)	835.000000
Relative Permittivity (real part)	41.110245
Conductivity (S/m)	0.871245
Power Variation (%)	1.814580
Ambient Temperature	21.1
Liquid Temperature	21.3

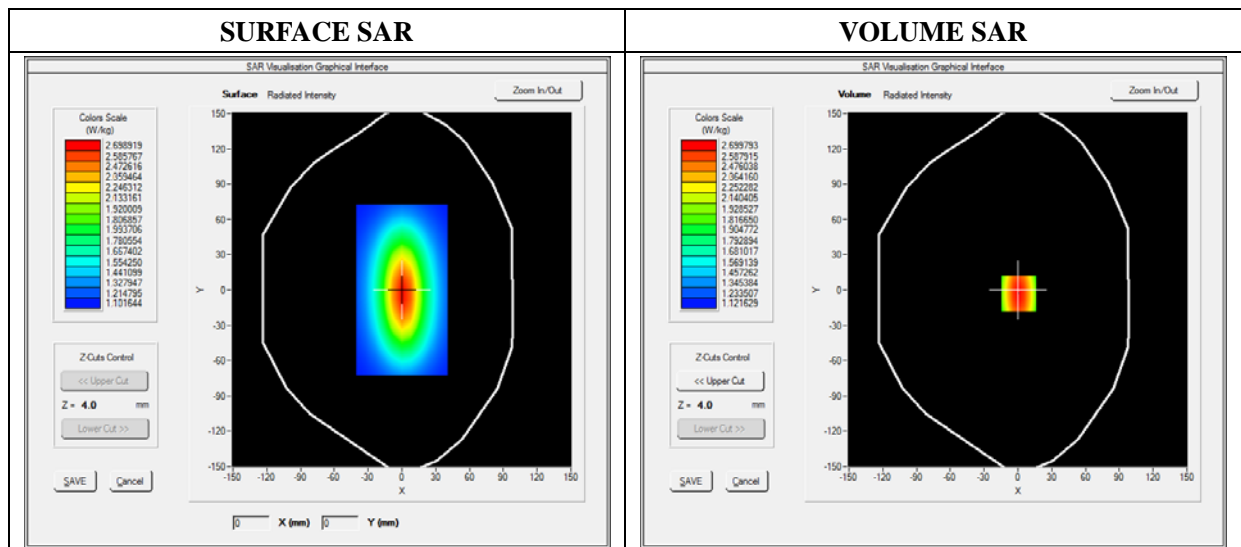

Maximum location: X=0.00, Y=0.00

SAR 10g (W/Kg)	1.129489
SAR 1g (W/Kg)	2.391250

Z Axis Scan

Z (mm)	0.00	4.00	9.00	14.00	19.00	24.00	29.00
SAR (W/Kg)	0.0000	2.4900	1.8942	1.4811	1.3541	1.1123	1.0539

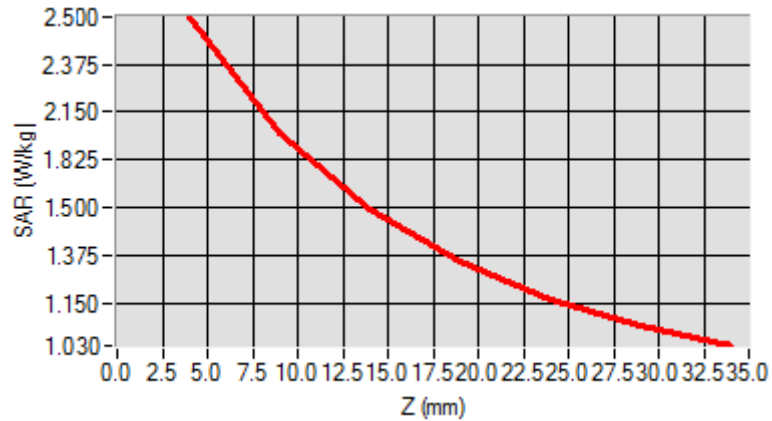

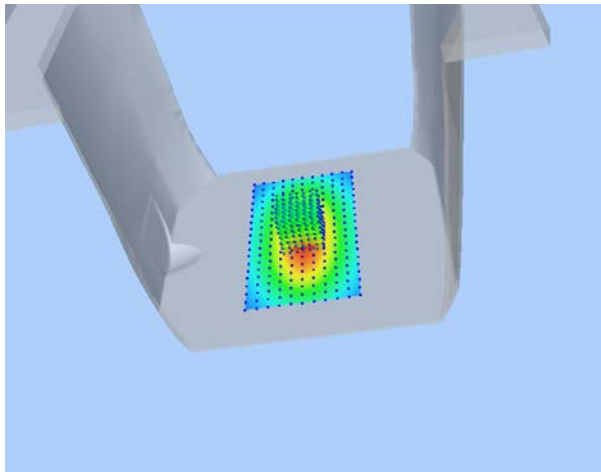
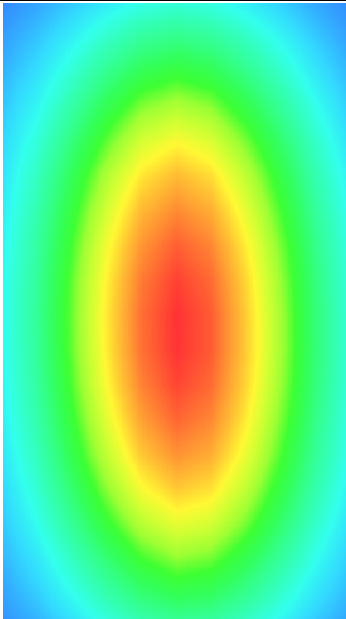
3D screen shot	Hot spot position
	

MEASUREMENT 2

For Head Liquid

Type: Validation measurement (Fast, 75.00 %)

Date of measurement: 01/09/2017

Measurement duration: 12 minutes 21 seconds

E-field Probe: SSE5 - SN 09/13 EP168; ConvF: 6.35; Calibrated: 06/01/2016

A. Experimental conditions

Area Scan	dx=8mm dy=8mm
Phantom	Validation plane
Device Position	Dipole
Band	CW1900
Signal	Duty Cycle 1:1

B. SAR Measurement Results

Frequency (MHz)	1900.000000
Relative Permittivity (real part)	38.560124
Conductivity (S/m)	1.380369
Power Variation (%)	1.022540
Ambient Temperature	21.1
Liquid Temperature	21.3

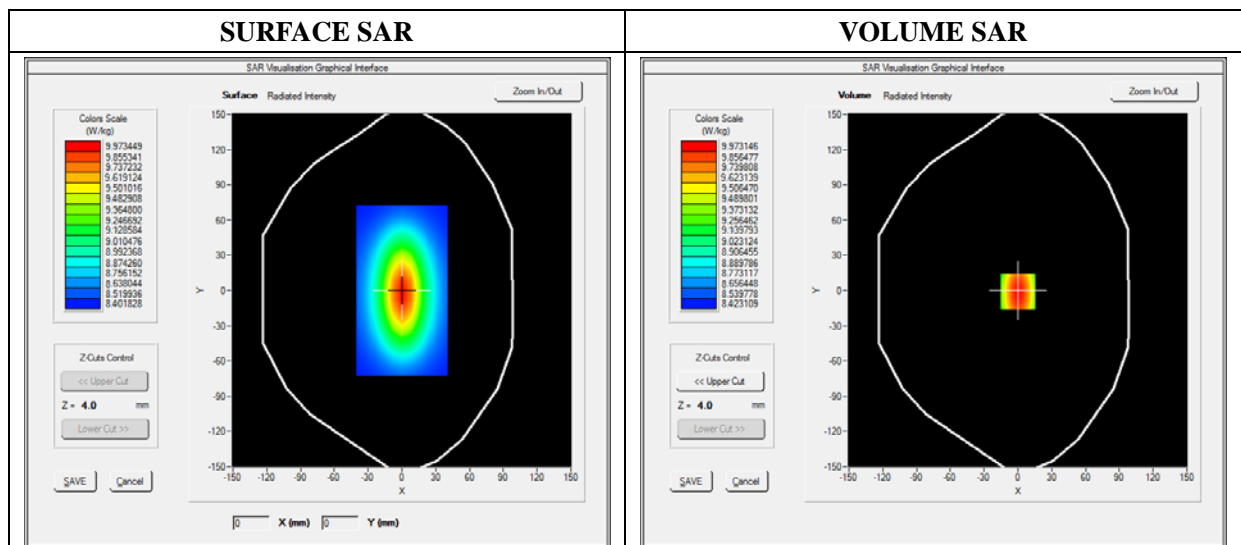

Maximum location: X=0.00, Y=0.00

SAR 10g (W/Kg)	7.174526
SAR 1g (W/Kg)	9.913214

Z Axis Scan

Z (mm)	0.00	4.00	9.00	14.00	19.00	24.00	29.00
SAR (W/Kg)	0.0000	10.2354	6.8400	5.0121	4.1189	3.0522	2.8424

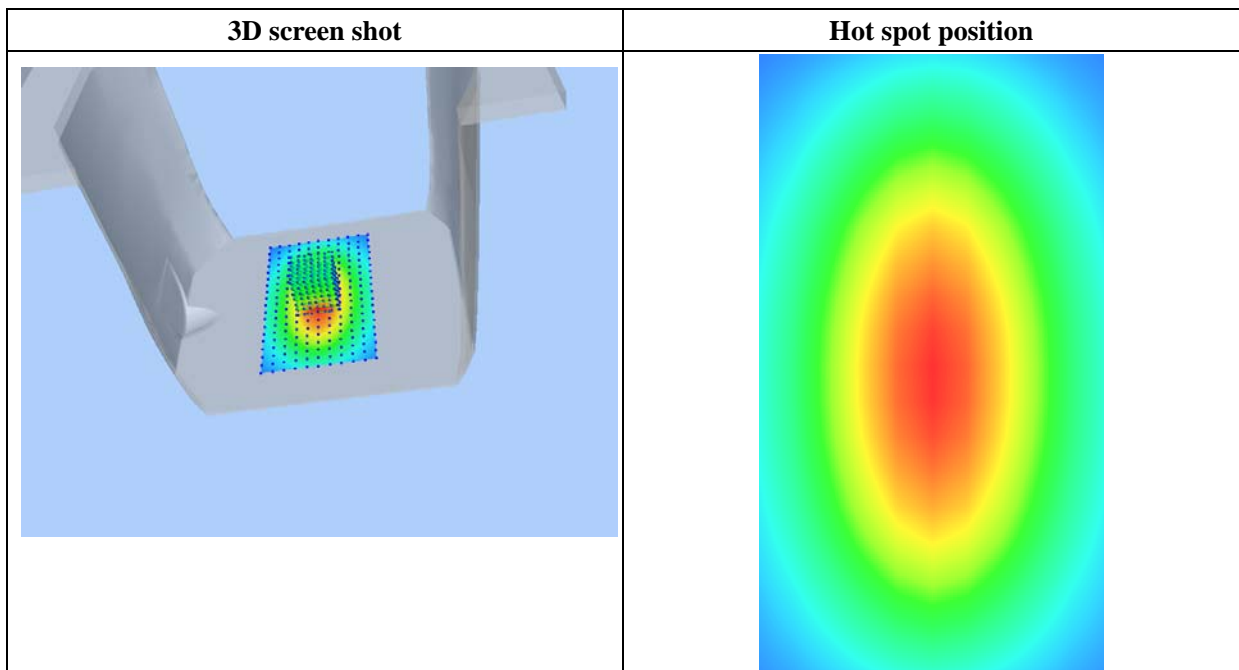
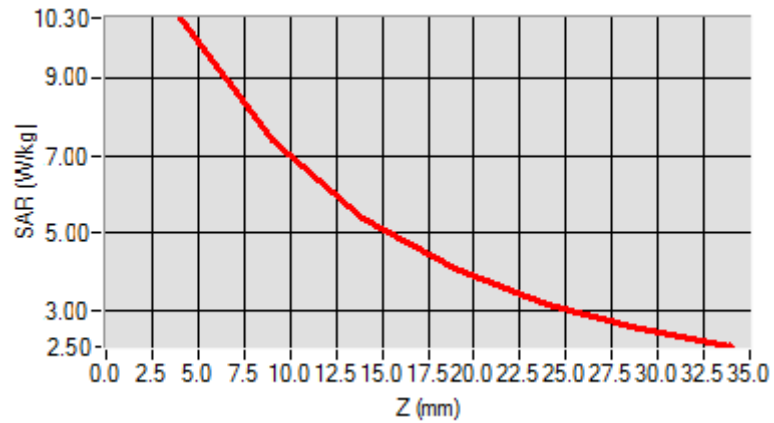

MEASUREMENT 3

For Head Liquid

Type: Validation measurement (Fast, 75.00 %)

Date of measurement: 01/09/2017

Measurement duration: 12 minutes 21 seconds

E-field Probe: SSE5 - SN 09/13 EP168; ConvF: 5.64; Calibrated: 06/01/2016

A. Experimental conditions

Area Scan	dx=8mm dy=8mm
Phantom	Validation plane
Device Position	Dipole
Band	CW2450
Signal	CW (Crest factor: 1.0)

B. SAR Measurement Results

Frequency (MHz)	2450.000000
Relative Permittivity (real part)	38.611212
Conductivity (S/m)	1.761202
Power Variation (%)	1.144120
Ambient Temperature	21.1
Liquid Temperature	21.2

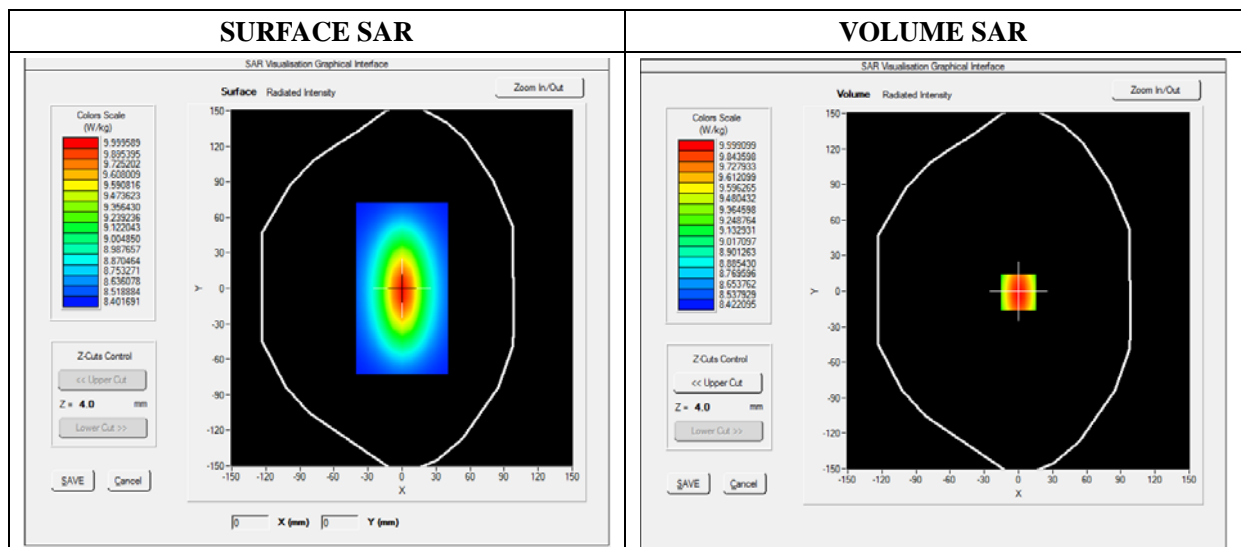

Maximum location: X=0.00, Y=0.00

SAR 10g (W/Kg)	6.352122
SAR 1g (W/Kg)	13.462010

Z Axis Scan

Z (mm)	0.00	4.00	9.00	14.00	19.00	24.00	29.00
SAR (W/Kg)	0.0000	12.1355	10.3301	8.4512	6.4365	5.6123	3.5621

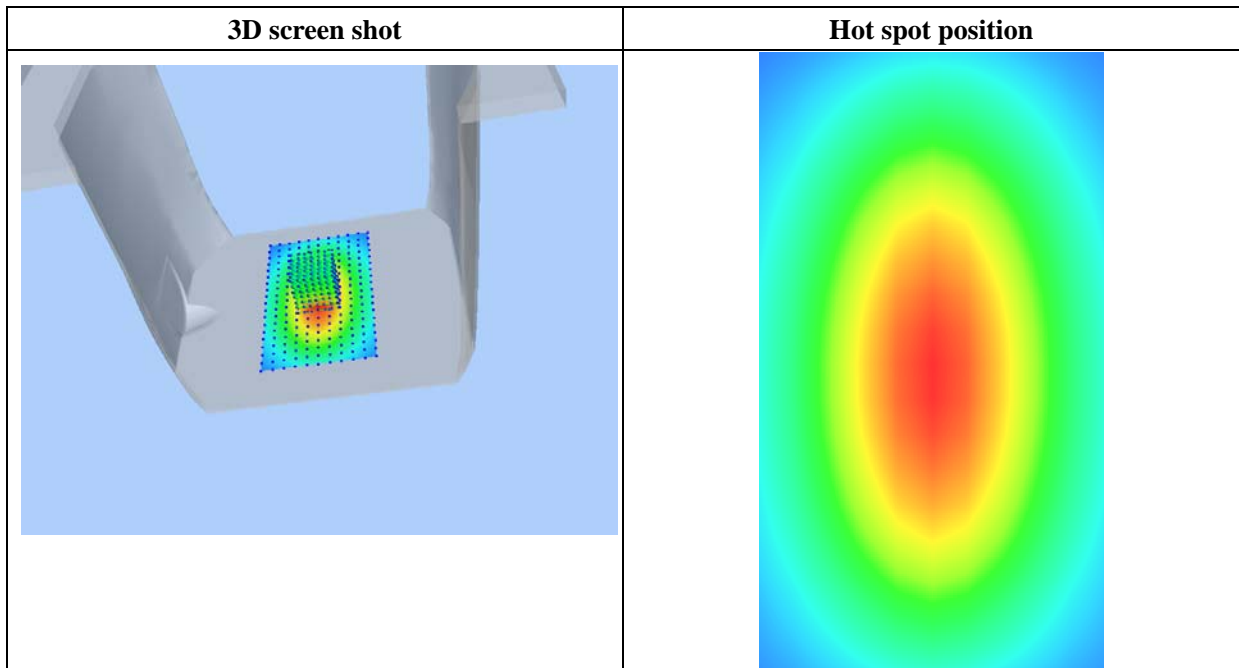
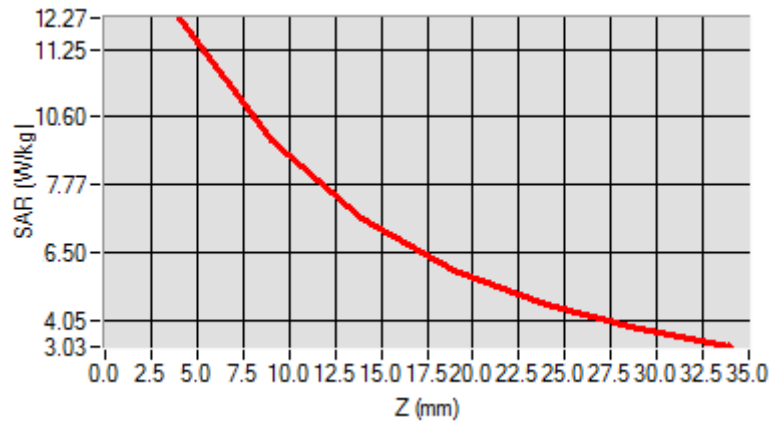

MEASUREMENT 4

For Body Liquid

Type: Validation measurement (Fast, 75.00 %)

Date of measurement: 01/09/2017

Measurement duration: 12 minutes 21 seconds

E-field Probe: SSE5 - SN 09/13 EP168; ConvF: 7.13; Calibrated: 06/01/2016

A. Experimental conditions

Area Scan	dx=8mm dy=8mm
Phantom	Validation plane
Device Position	Dipole
Band	CW835
Signal	Duty Cycle 1:1

B. SAR Measurement Results

Frequency (MHz)	835.000000
Relative Permittivity (real part)	54.851214
Conductivity (S/m)	0.951454
Power Variation (%)	0.901472
Ambient Temperature	21.1
Liquid Temperature	21.3

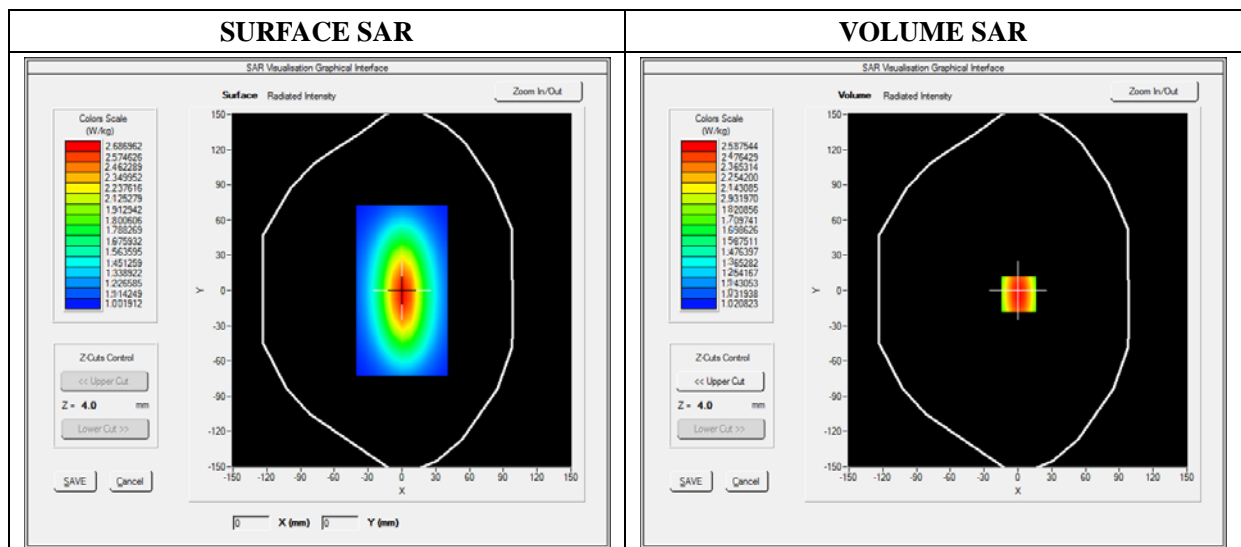

Maximum location: X=0.00, Y=0.00

SAR 10g (W/Kg)	1.028956
SAR 1g (W/Kg)	2.364211

Z Axis Scan

Z (mm)	0.00	4.00	9.00	14.00	19.00	24.00	29.00
SAR (W/Kg)	0.0000	2.5789	1.1300	0.8795	0.5940	0.5011	0.5100

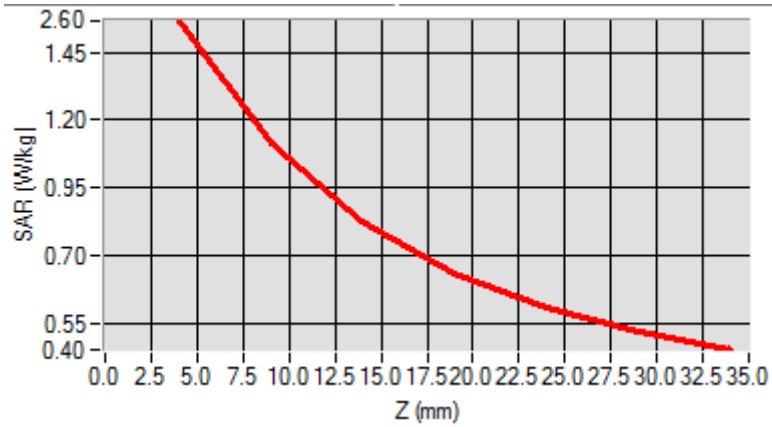

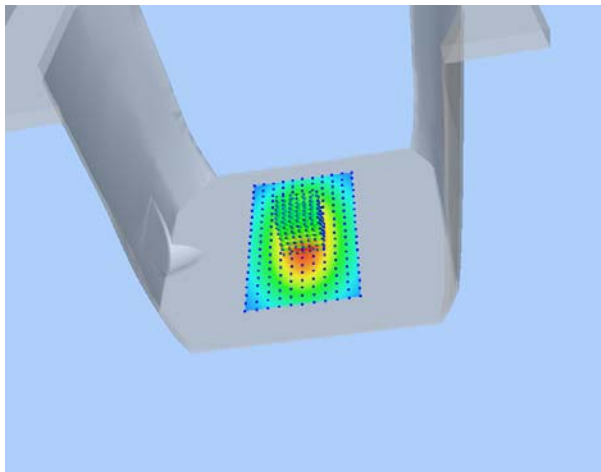
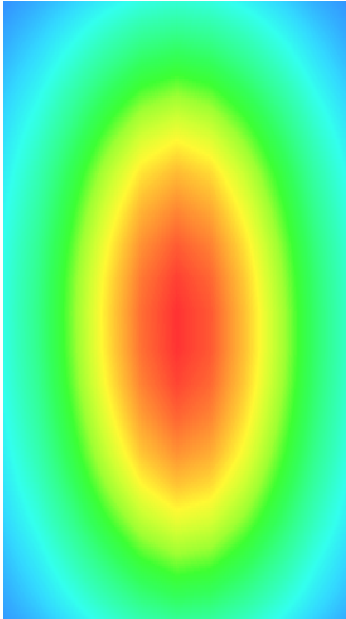
3D screen shot	Hot spot position
	

MEASUREMENT 5

For Body Liquid

Type: Validation measurement (Fast, 75.00 %)

Date of measurement: 01/09/2017

Measurement duration: 12 minutes 21 seconds

E-field Probe: SSE5 - SN 09/13 EP168; ConvF: 6.55; Calibrated: 06/01/2016

A. Experimental conditions

Area Scan	dx=8mm dy=8mm
Phantom	Validation plane
Device Position	Dipole
Band	CW1900
Signal	Duty Cycle 1:1

B. SAR Measurement Results

Frequency (MHz)	1900.000000
Relative Permittivity (real part)	52.420415
Conductivity (S/m)	1.501966
Power Variation (%)	0.541872
Ambient Temperature	21.1
Liquid Temperature	21.3

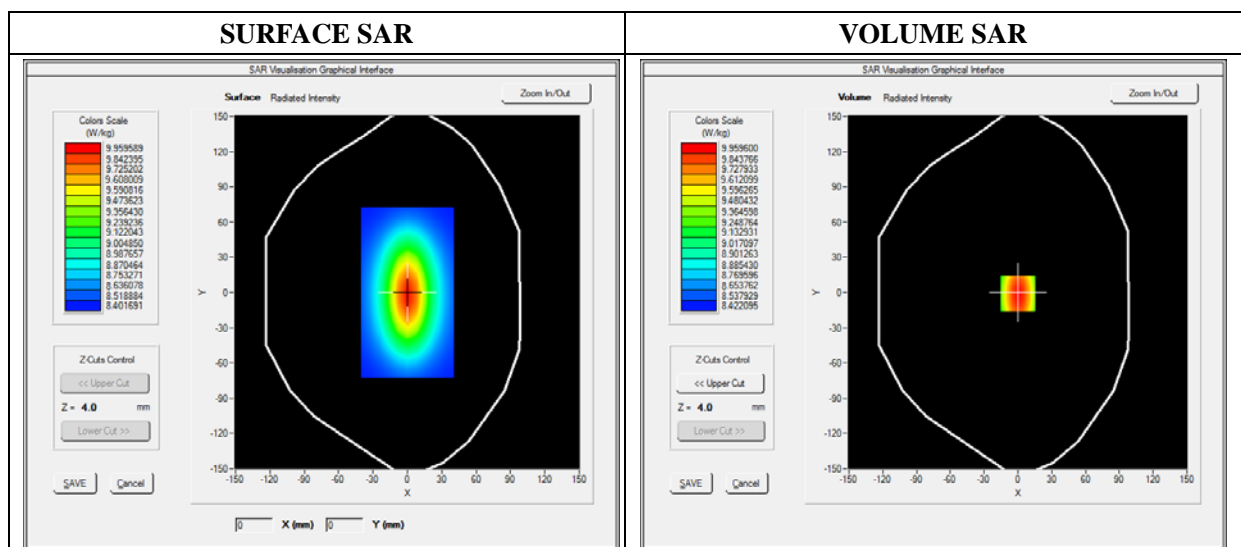

Maximum location: X=0.00, Y=0.00

SAR 10g (W/Kg)	5.134651
SAR 1g (W/Kg)	9.801550

Z Axis Scan

Z (mm)	0.00	4.00	9.00	14.00	19.00	24.00	29.00
SAR (W/Kg)	0.0000	10.2031	6.43001	4.9011	4.5325	3.1201	2.5024

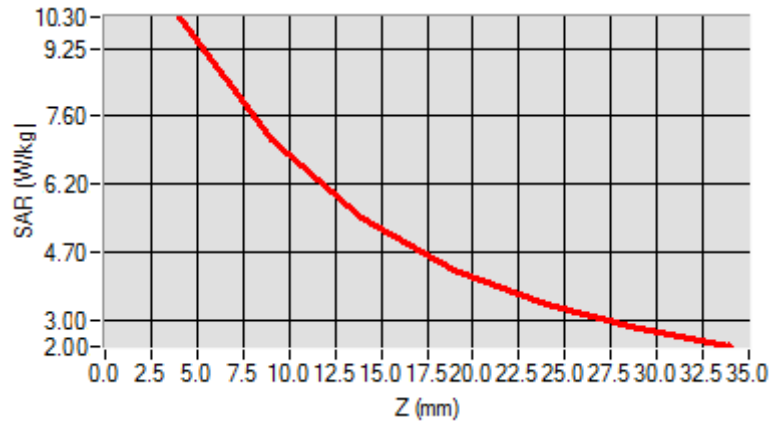

3D screen shot

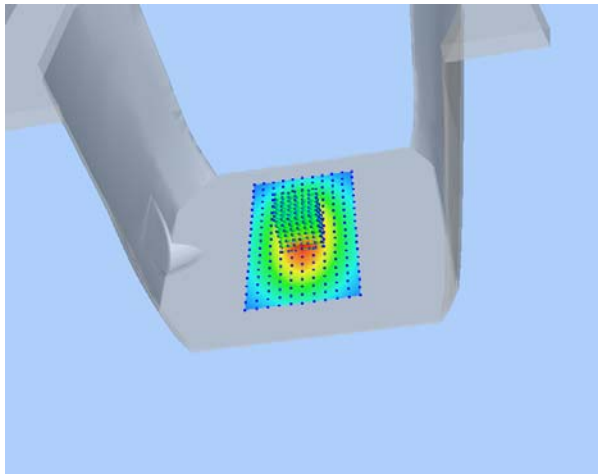

Hot spot position

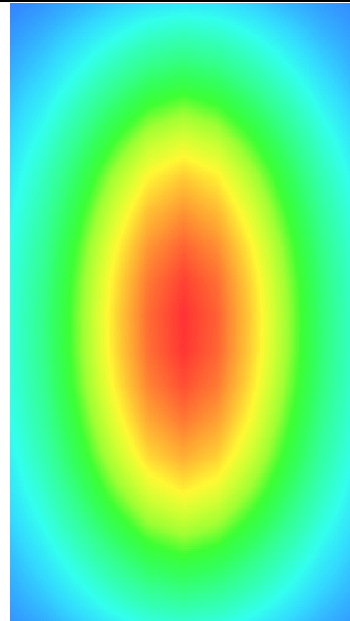

MEASUREMENT 6

For Body Liquid

Type: Validation measurement (Fast, 75.00 %)

Date of measurement: 01/09/2017

Measurement duration: 12 minutes 21 seconds

E-field Probe: SSE5 - SN 09/13 EP168; ConvF: 5.80; Calibrated: 06/01/2016

A. Experimental conditions

Area Scan	dx=8mm dy=8mm
Phantom	Validation plane
Device Position	Dipole
Band	CW2450
Signal	CW (Crest factor: 1.0)

B. SAR Measurement Results

Frequency (MHz)	2450.000000
Relative Permittivity (real part)	52.315622
Conductivity (S/m)	2.001255
Power Variation (%)	0.542660
Ambient Temperature	21.1
Liquid Temperature	21.2

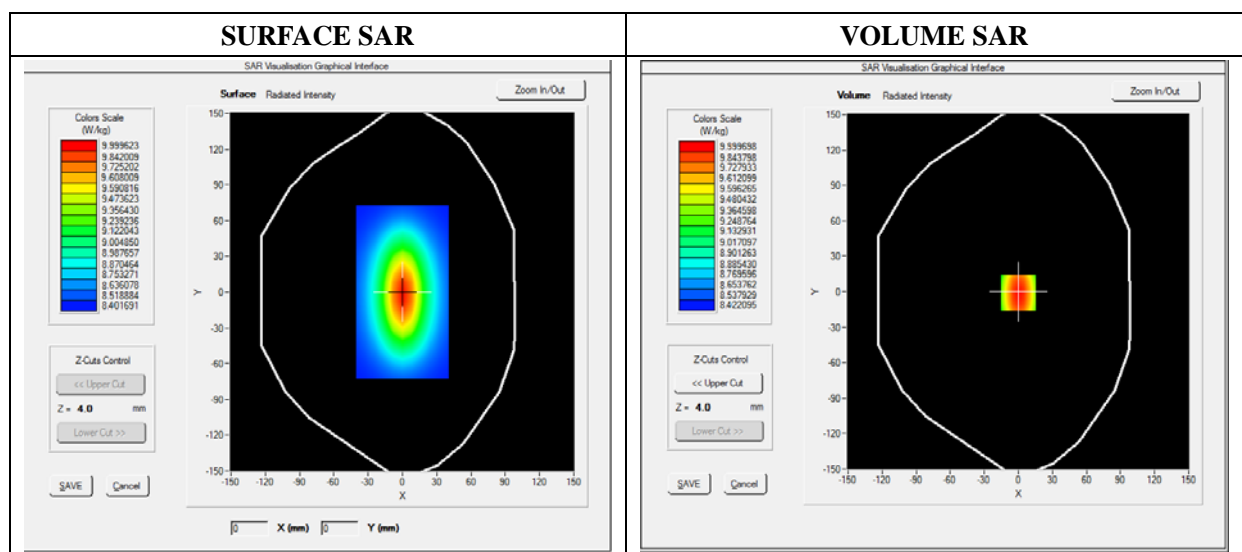

Maximum location: X=0.00, Y=0.00

SAR 10g (W/Kg)	6.351512
SAR 1g (W/Kg)	12.600533

Z Axis Scan

Z (mm)	0.00	4.00	9.00	14.00	19.00	24.00	29.00
SAR (W/Kg)	0.0000	12.1631	10.01221	9.2566	8.5623	6.3469	4.5626

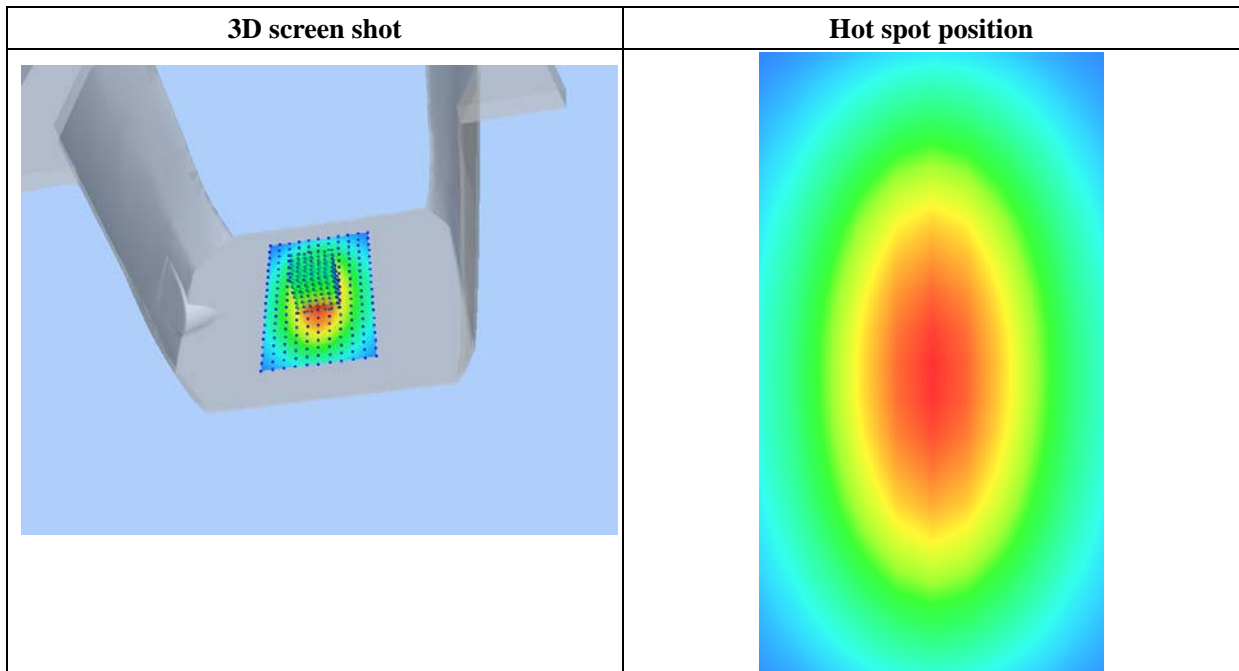
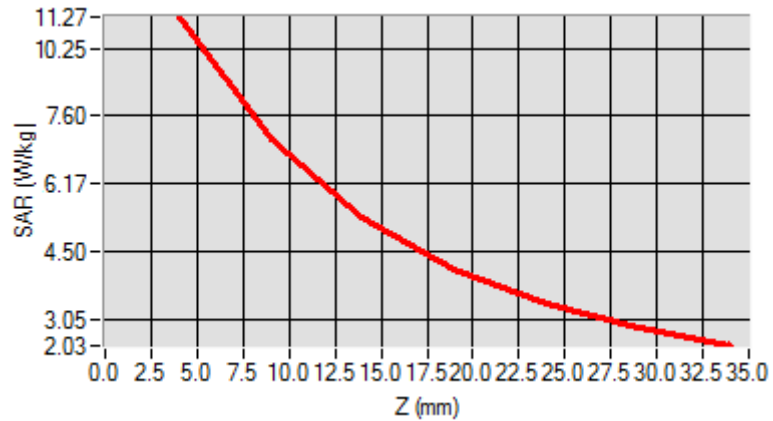

Annex B. Plots of SAR Measurement

<u>TYPE</u>	<u>BAND</u>	<u>PARAMETERS</u>
Phone	GSM850	<u>Measurement 3</u> : Left Head with Cheek device position on Low Channel in GSM mode
Phone	GSM1900	<u>Measurement 7</u> : Left Head with Cheek device position on High Channel in GSM mode
Phone	GPRS850_2TX	<u>Measurement 11</u> : Left Head with Cheek device position on Low Channel in GPRS mode
Phone	GPRS1900_2TX	<u>Measurement 13</u> : Right Head with Cheek device position on High Channel in GPRS mode
Phone	WCDMA850_RMC	<u>Measurement 19</u> : Left Head with Cheek device position on Low Channel in WCDMA mode
Phone	WCDMA1900_RMC	<u>Measurement 23</u> : Left Head with Cheek device position on High Channel in WCDMA mode
Phone	WiFi_802.11b	<u>Measurement 27</u> : Left Head with Cheek device position on High Channel in 802.11b mode
Phone	GSM850	<u>Measurement 29</u> : Flat Plane with Back(Body-worn) device position on Low Channel in GSM mode
Phone	GSM1900	<u>Measurement 31</u> : Flat Plane with Back(Body-worn) device position on High Channel in GSM mode
Phone	GPRS850_2TX	<u>Measurement 33</u> : Flat Plane with Back device position on Low Channel in GPRS mode
Phone	GPRS1900_2TX	<u>Measurement 38</u> : Flat Plane with Back device position on High Channel in GPRS mode
Phone	WCDMA850_RMC	<u>Measurement 43</u> : Flat Plane with Back device position on Low Channel in WCDMA mode
Phone	WCDMA1900_RMC	<u>Measurement 48</u> : Flat Plane with Back device position on High Channel in WCDMA mode
Phone	WiFi_802.11b	<u>Measurement 53</u> : Flat Plane with Back side device position on High Channel in 802.11b mode
<p><i>Remark: SAR plot is showed the highest measured SAR in each exposure configuration, wireless mode and frequency band combination.</i></p>		

MEASUREMENT 3

Type: Phone measurement (Complete)

Date of measurement: 01/09/2017

Measurement duration: 11 minutes 48 seconds

E-field Probe: SSE5 - SN 09/13 EP168; ConvF: 6.93; Calibrated: 06/01/2016

A. Experimental conditions

Area Scan	sam_direct_droit2_surf8mm.txt
Phantom	Left head
Device Position	Cheek
Band	GSM850
Channels	Low
Signal	TDMA (Crest factor: 8.0)

B. SAR Measurement Results

Frequency (MHz)	824.200000
Relative Permittivity (real part)	41.110245
Conductivity (S/m)	0.871245
Power Variation (%)	1.956700
Ambient Temperature	21.1
Liquid Temperature	21.3

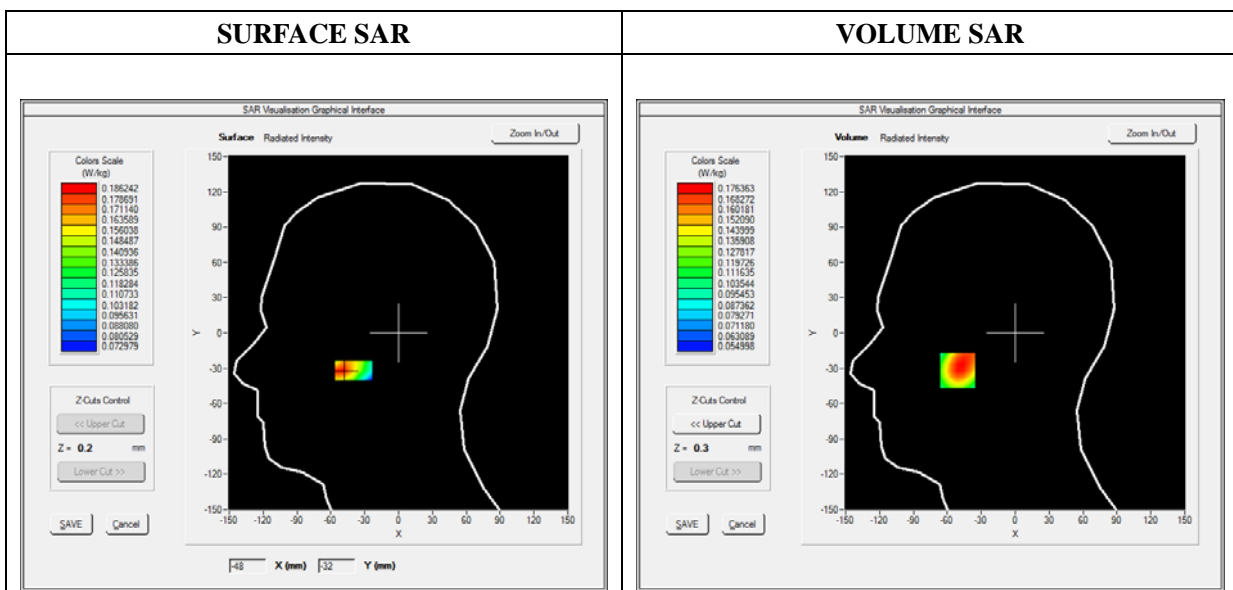



Maximum location: X=-51.00, Y=-32.00

SAR 10g (W/Kg)	0.130822
SAR 1g (W/Kg)	0.171540

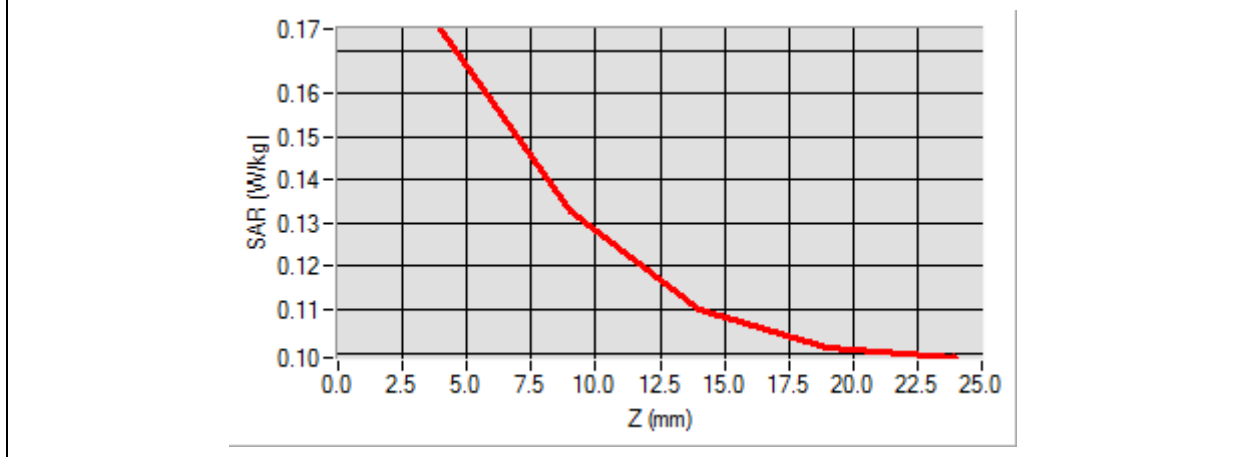
Z (mm)	0.00	4.00	9.00	14.00	19.00
SAR (W/Kg)	0.0000	0.1749	0.1326	0.1101	0.1014

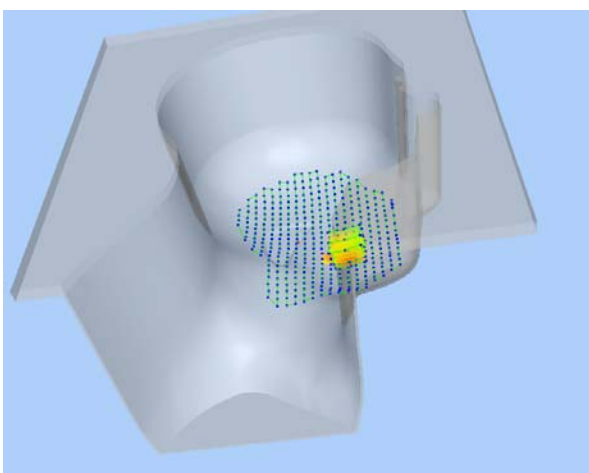

3D screen shot	Hot spot position
	

MEASUREMENT 7

Type: Phone measurement (Complete)

Date of measurement: 01/09/2017

Measurement duration: 12 minutes 3 seconds

E-field Probe: SSE5 - SN 09/13 EP168; ConvF: 6.35; Calibrated: 06/01/2016

A. Experimental conditions

Area Scan	sam_direct_droit2_surf8mm.txt
Phantom	Left head
Device Position	Cheek
Band	GSM1900
Channels	High
Signal	TDMA (Crest factor: 8.0)

B. SAR Measurement Results

Frequency (MHz)	1909.800000
Relative Permittivity (real part)	38.560124
Conductivity (S/m)	1.380369
Power Variation (%)	1.869568
Ambient Temperature	21.1
Liquid Temperature	21.3

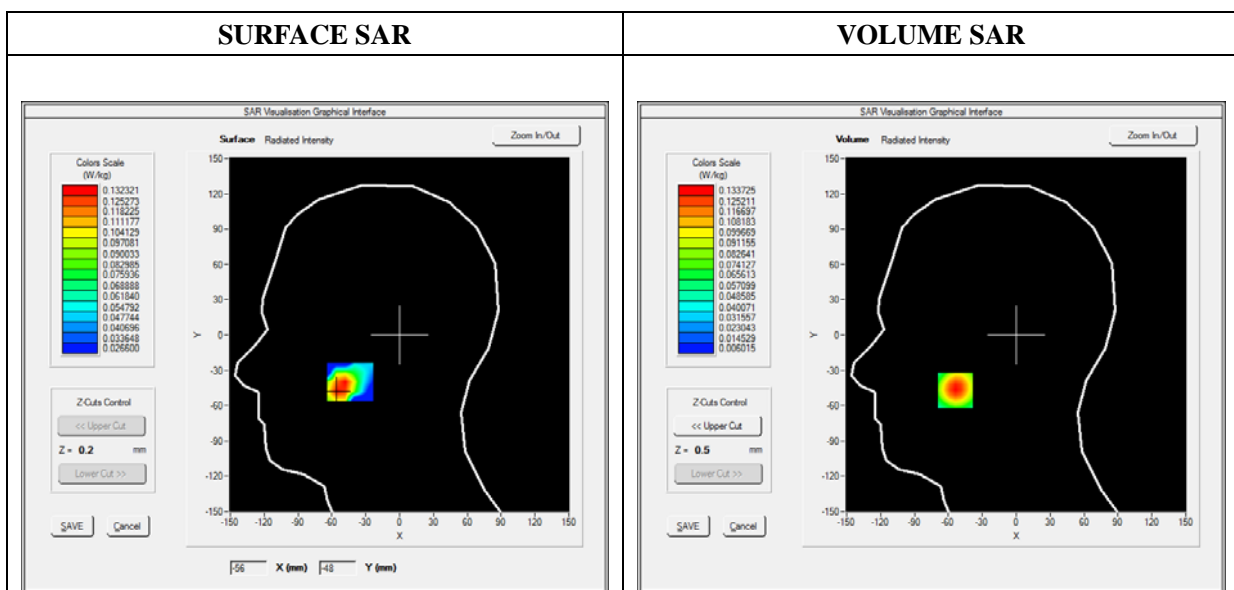

Maximum location: X=-54.00, Y=-47.00

SAR 10g (W/Kg)	0.071738
SAR 1g (W/Kg)	0.124383

Z (mm)	0.00	4.00	9.00	14.00	19.00
SAR (W/Kg)	0.0000	0.1337	0.0823	0.0513	0.0330

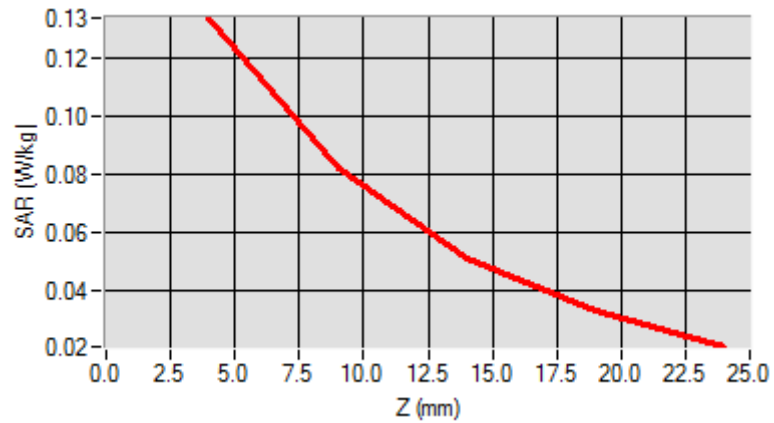

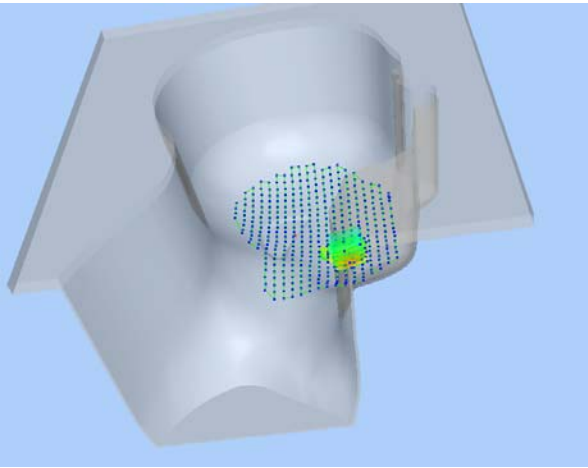
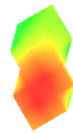
3D screen shot	Hot spot position
	

MEASUREMENT 11

Type: Phone measurement (Complete)

Date of measurement: 01/09/2017

Measurement duration: 11 minutes 48 seconds

E-field Probe: SSE5 - SN 09/13 EP168; ConvF: 6.93; Calibrated: 06/01/2016

A. Experimental conditions

Area Scan	sam_direct_droit2_surf8mm.txt
Phantom	Left head
Device Position	Cheek
Band	GPRS850_2TX
Channels	Low
Signal	Duty Cycle: 1:4

B. SAR Measurement Results

Frequency (MHz)	824.200000
Relative Permittivity (real part)	41.110245
Conductivity (S/m)	0.871245
Power Variation (%)	1.903833
Ambient Temperature	21.1
Liquid Temperature	21.3

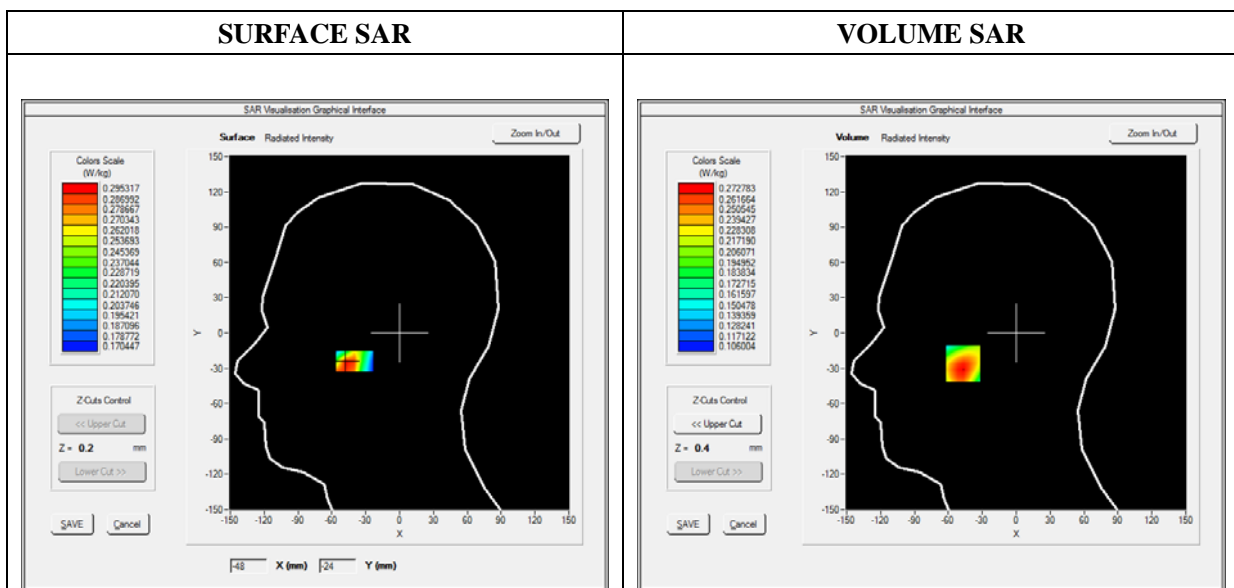



Maximum location: X=-47.00, Y=-26.00

SAR 10g (W/Kg)	0.217094
SAR 1g (W/Kg)	0.264785

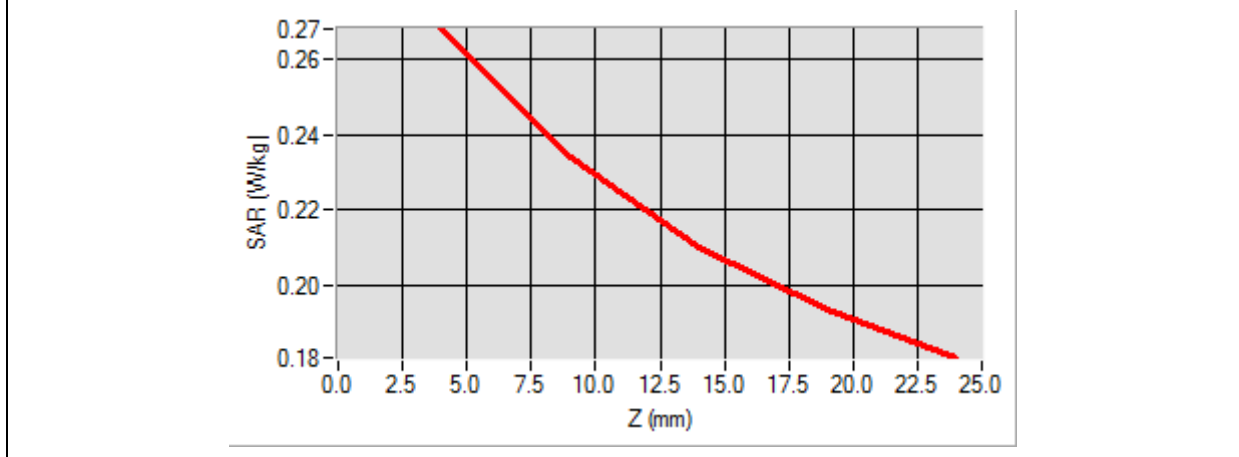
Z (mm)	0.00	4.00	9.00	14.00	19.00
SAR (W/Kg)	0.0000	0.2681	0.2342	0.2101	0.1934

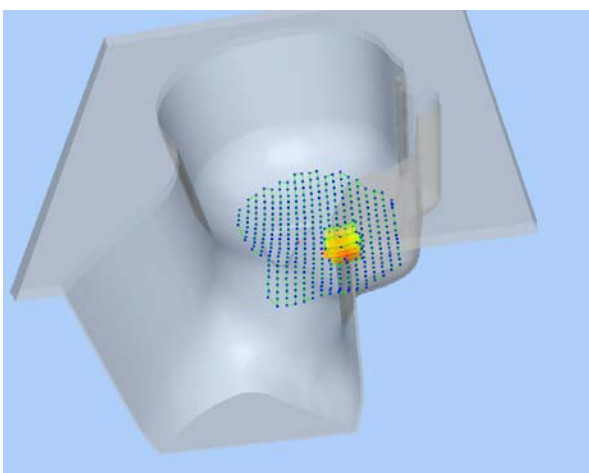

3D screen shot	Hot spot position
	

MEASUREMENT 13

Type: Phone measurement (Complete)

Date of measurement: 01/09/2017

Measurement duration: 12 minutes 3 seconds

E-field Probe: SSE5 - SN 09/13 EP168; ConvF: 6.35; Calibrated: 06/01/2016

A. Experimental conditions

Area Scan	sam_direct_droit2_surf8mm.txt
Phantom	Right head
Device Position	Cheek
Band	GPRS1900_2TX
Channels	High
Signal	Duty Cycle: 1:4

B. SAR Measurement Results

Frequency (MHz)	1909.800000
Relative Permittivity (real part)	38.560124
Conductivity (S/m)	1.380369
Power Variation (%)	1.536272
Ambient Temperature	21.1
Liquid Temperature	21.3

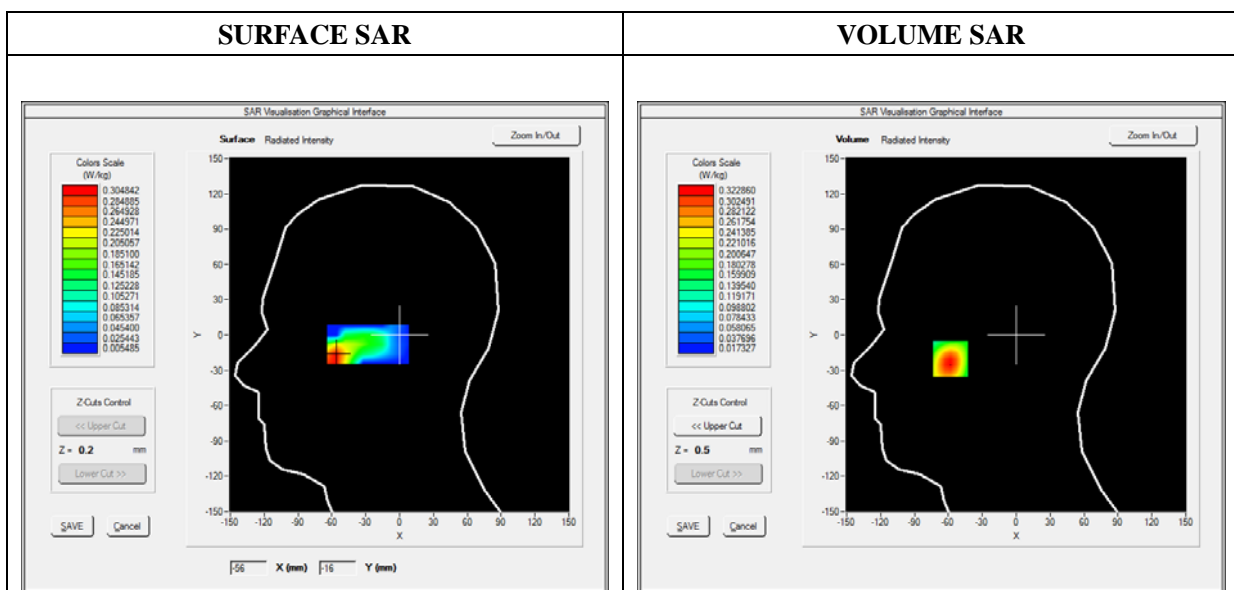

Maximum location: X=-58.00, Y=-20.00

SAR 10g (W/Kg)	0.174249
SAR 1g (W/Kg)	0.302969

Z (mm)	0.00	4.00	9.00	14.00	19.00
SAR (W/Kg)	0.0000	0.3198	0.1836	0.1093	0.0708

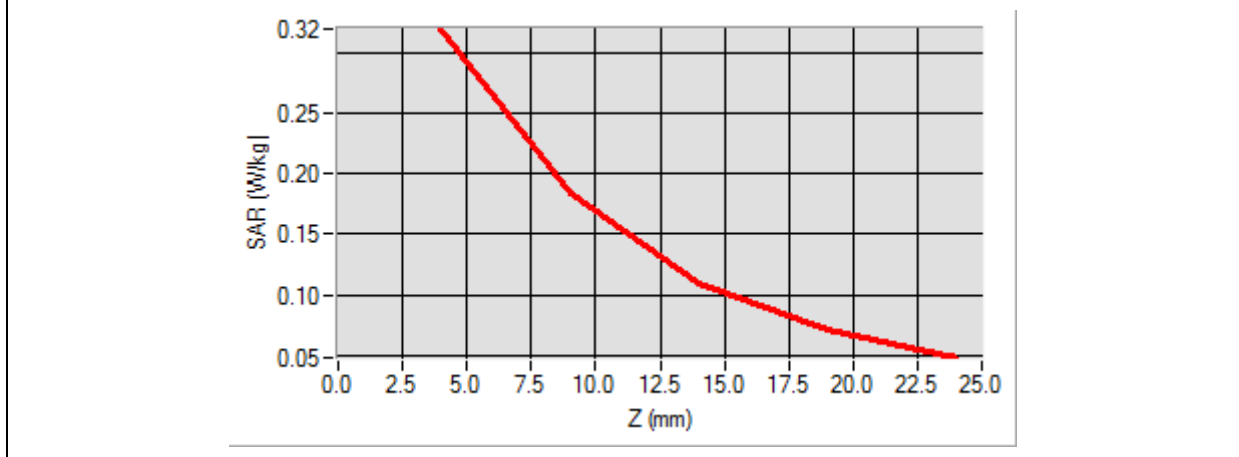

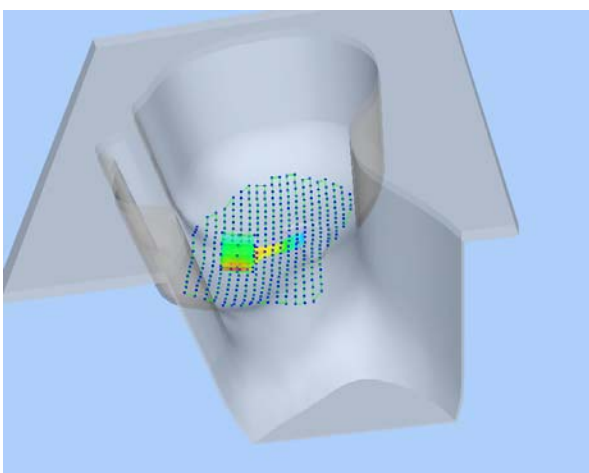
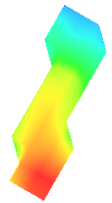
3D screen shot	Hot spot position
	

MEASUREMENT 19

Type: Phone measurement (Complete)

Date of measurement: 01/09/2017

Measurement duration: 12 minutes 3 seconds

E-field Probe: SSE5 - SN 09/13 EP168; ConvF: 6.93; Calibrated: 06/01/2016

A. Experimental conditions

Area Scan	sam_direct_droit2_surf8mm.txt
Phantom	Left head
Device Position	Cheek
Band	WCDMA850_RMC
Channels	Low
Signal	Duty Cycle 1:1

B. SAR Measurement Results

Frequency (MHz)	826.400000
Relative Permittivity (real part)	41.110245
Conductivity (S/m)	0.871245
Power Variation (%)	1.753989
Ambient Temperature	21.1
Liquid Temperature	21.3

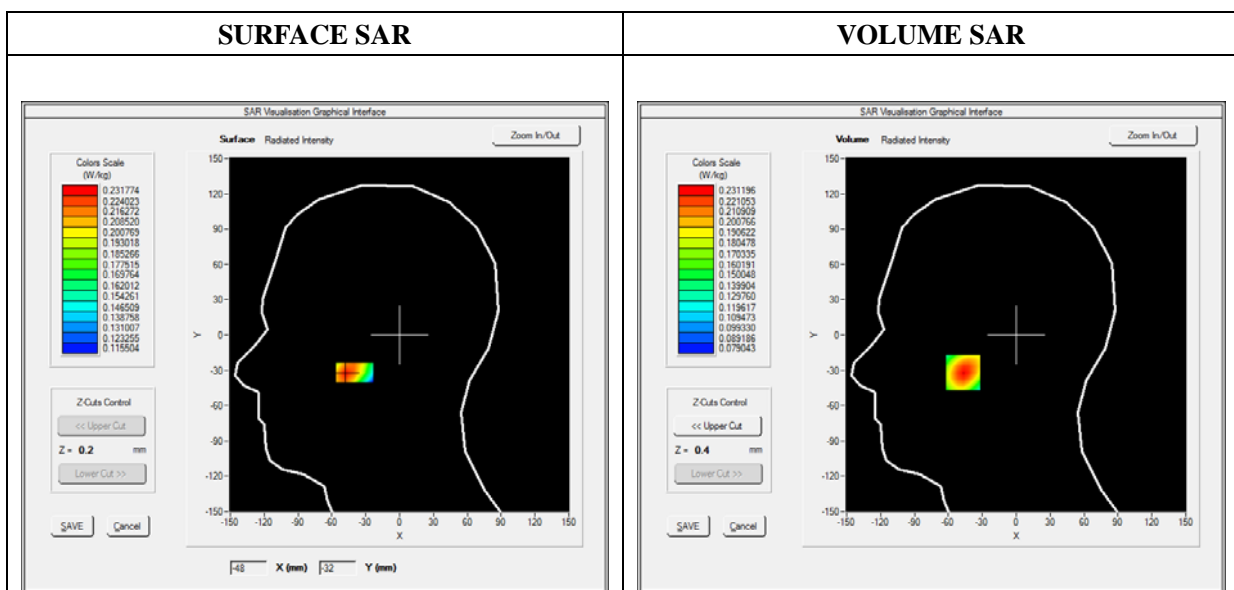



Maximum location: X=-47.00, Y=-32.00

SAR 10g (W/Kg)	0.175754
SAR 1g (W/Kg)	0.221613

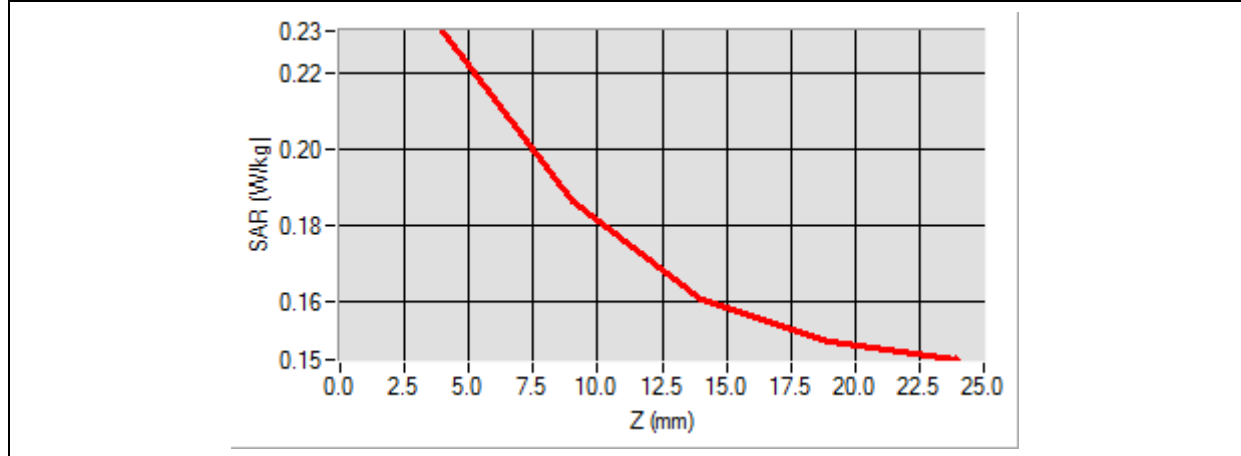
Z (mm)	0.00	4.00	9.00	14.00	19.00
SAR (W/Kg)	0.0000	0.2312	0.1863	0.1610	0.1498

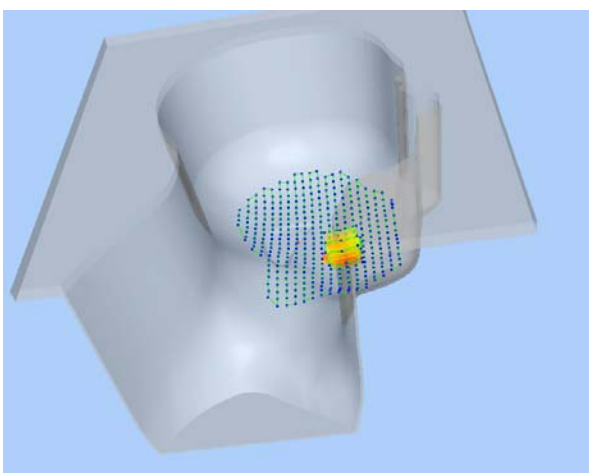

3D screen shot	Hot spot position
	

MEASUREMENT 23

Type: Phone measurement (Complete)

Date of measurement: 01/09/2017

Measurement duration: 12 minutes 3 seconds

E-field Probe: SSE5 - SN 09/13 EP168; ConvF: 6.35; Calibrated: 06/01/2016

A. Experimental conditions

Area Scan	sam_direct_droit2_surf8mm.txt
Phantom	Left head
Device Position	Cheek
Band	WCDMA1900_RMC
Channels	High
Signal	Duty Cycle 1:1

B. SAR Measurement Results

Frequency (MHz)	1907.600000
Relative Permittivity (real part)	38.560124
Conductivity (S/m)	1.380369
Power Variation (%)	1.546537
Ambient Temperature	21.1
Liquid Temperature	21.3

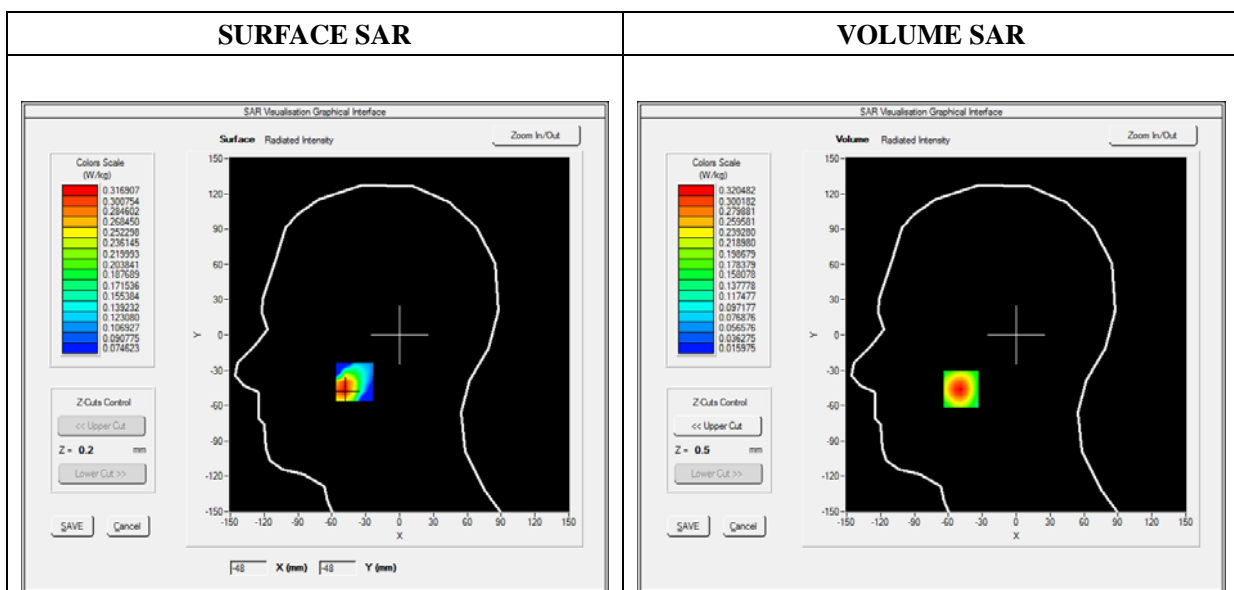

Maximum location: X=-49.00, Y=-46.00

SAR 10g (W/Kg)	0.170987
SAR 1g (W/Kg)	0.296854

Z (mm)	0.00	4.00	9.00	14.00	19.00
SAR (W/Kg)	0.0000	0.3205	0.1979	0.1222	0.0765

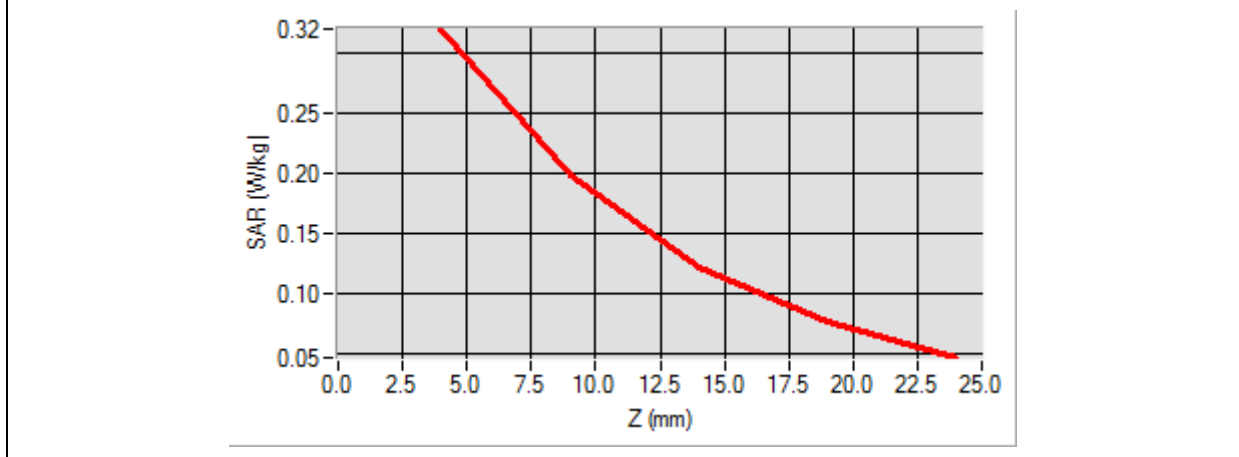

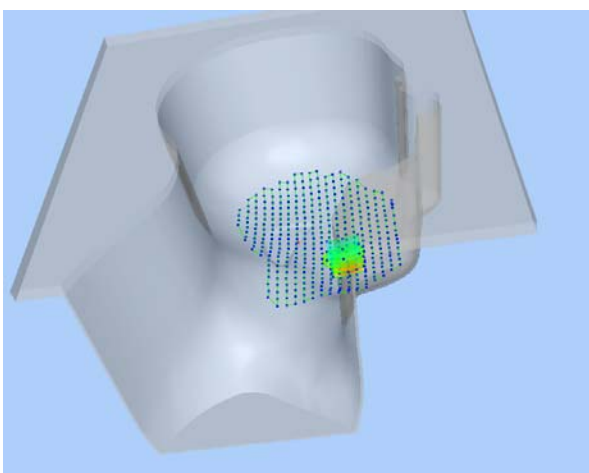
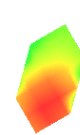
3D screen shot	Hot spot position
	

MEASUREMENT 27

Type: Phone measurement (Complete)

Date of measurement: 01/09/2017

Measurement duration: 12 minutes 3 seconds

E-field Probe: SSE5 - SN 09/13 EP168; ConvF: 5.64; Calibrated: 06/01/2016

A. Experimental conditions

Area Scan	sam_direct_droit2_surf8mm.txt
Phantom	Left head
Device Position	Cheek
Band	WiFi_802.11b
Channels	High
Signal	Duty Cycle: 1:1

B. SAR Measurement Results

Frequency (MHz)	2462.000000
Relative Permittivity (real part)	38.611212
Conductivity (S/m)	1.761202
Power Variation (%)	1.867589
Ambient Temperature	21.1
Liquid Temperature	21.2

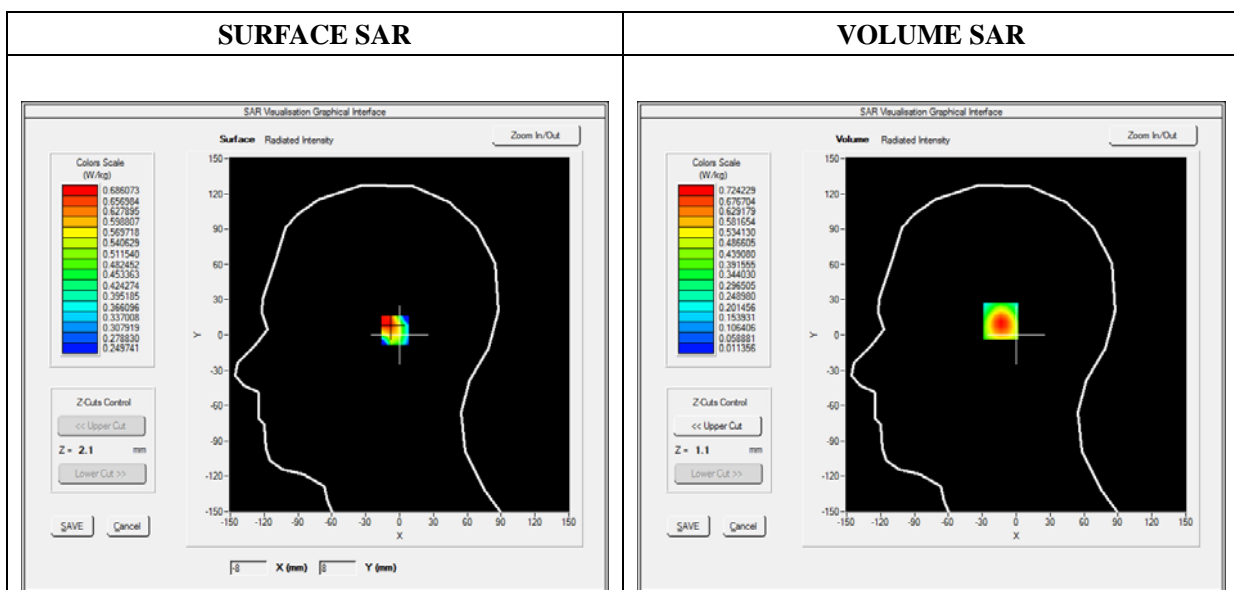



Maximum location: X=-12.00, Y=12.00

SAR 10g (W/Kg)	0.326256
SAR 1g (W/Kg)	0.679588

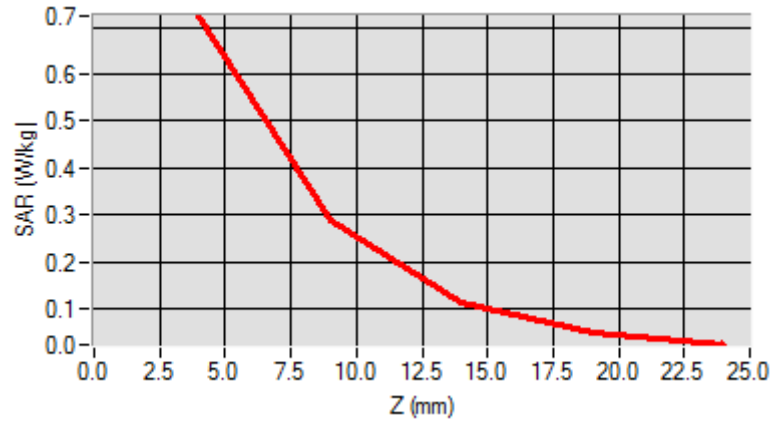
Z (mm)	0.00	4.00	9.00	14.00	19.00
SAR (W/Kg)	0.0000	0.7242	0.2898	0.1108	0.0481

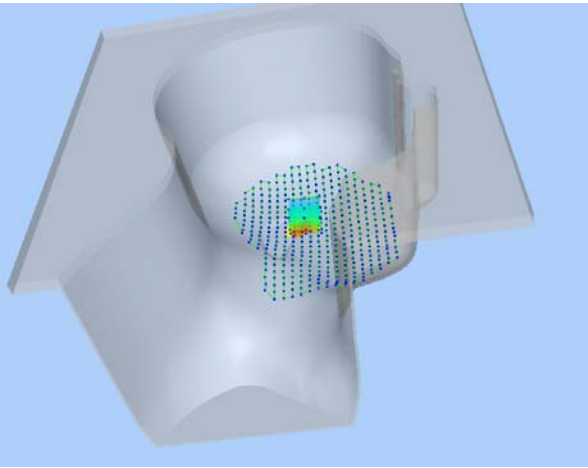

3D screen shot	Hot spot position
	

MEASUREMENT 29

Type: Phone measurement (Complete)

Date of measurement: 01/09/2017

Measurement duration: 12 minutes 3 seconds

E-field Probe: SSE5 - SN 09/13 EP168; ConvF: 7.13; Calibrated: 06/01/2016

A. Experimental conditions

Area Scan	sam_direct_droit2_surf8mm.txt
Phantom	Flat Plane
Device Position	Back(Body-worn)
Band	GSM850
Channels	Low
Signal	TDMA (Crest factor: 8.0)

B. SAR Measurement Results

Frequency (MHz)	824.200000
Relative Permittivity (real part)	54.851214
Conductivity (S/m)	0.951454
Power Variation (%)	0.785060
Ambient Temperature	21.1
Liquid Temperature	21.3

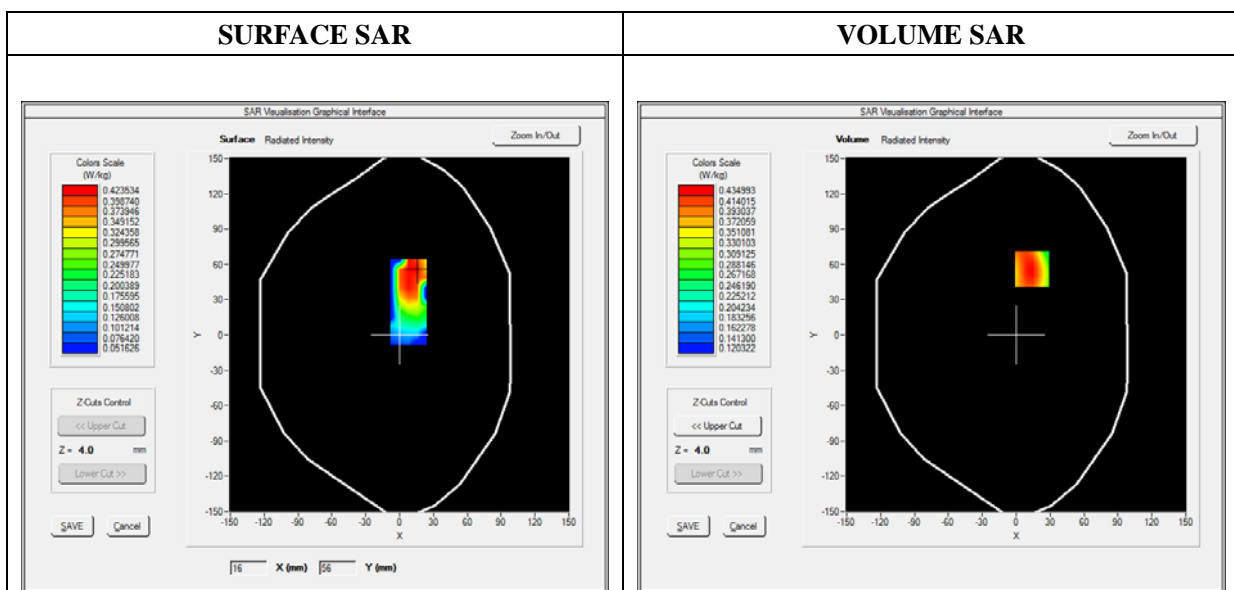

Maximum location: X=14.00, Y=56.00

SAR 10g (W/Kg)	0.361591
SAR 1g (W/Kg)	0.455905

Z (mm)	0.00	4.00	9.00	14.00	19.00
SAR (W/Kg)	0.0000	0.4350	0.3491	0.2912	0.2535

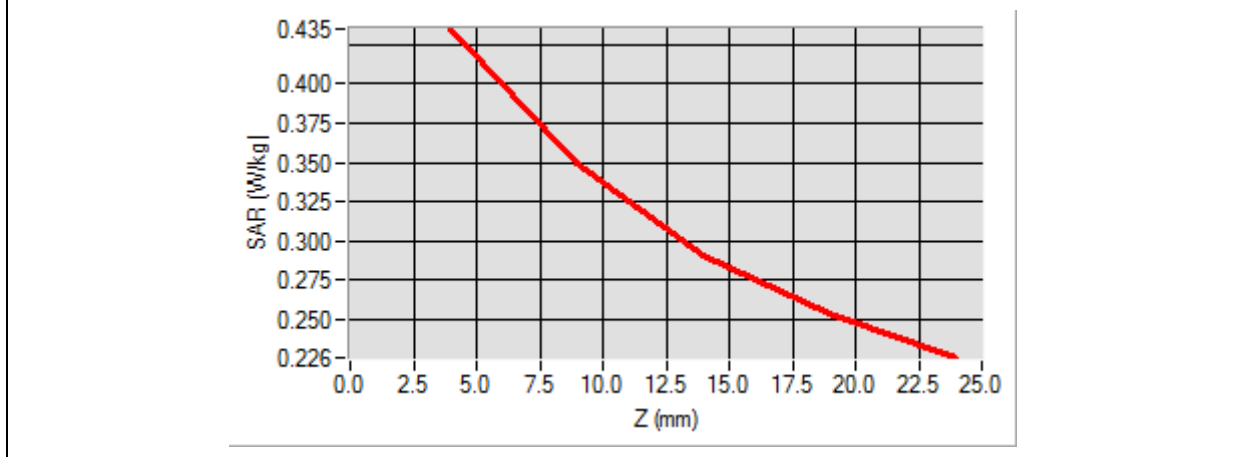

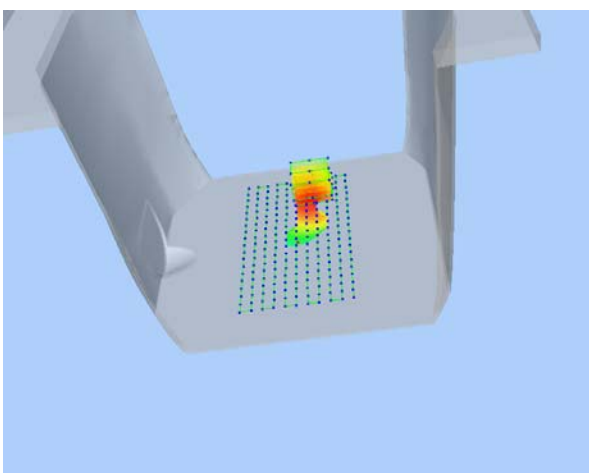
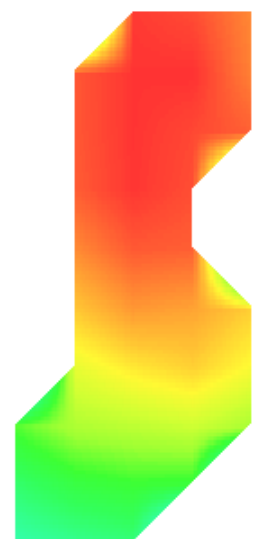
3D screen shot	Hot spot position
	

MEASUREMENT 31

Type: Phone measurement (Complete)

Date of measurement: 01/09/2017

Measurement duration: 12 minutes 3 seconds

E-field Probe: SSE5 - SN 09/13 EP168; ConvF: 6.55; Calibrated: 06/01/2016

A. Experimental conditions

Area Scan	sam_direct_droit2_surf8mm.txt
Phantom	Flat Plane
Device Position	Back(Body-worn)
Band	GSM1900
Channels	High
Signal	TDMA (Crest factor: 8.0)

B. SAR Measurement Results

Frequency (MHz)	1909.800000
Relative Permittivity (real part)	52.420415
Conductivity (S/m)	1.501966
Power Variation (%)	0.568946
Ambient Temperature	21.1
Liquid Temperature	21.3

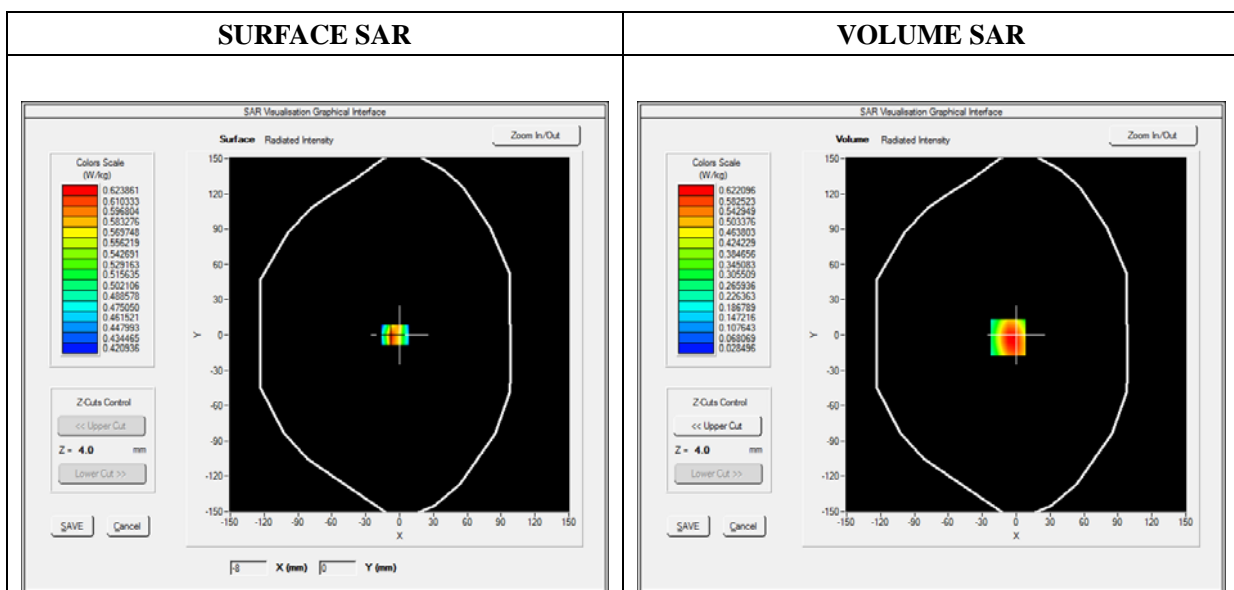



Maximum location: X=-7.00, Y=-2.00

SAR 10g (W/Kg)	0.397645
SAR 1g (W/Kg)	0.714800

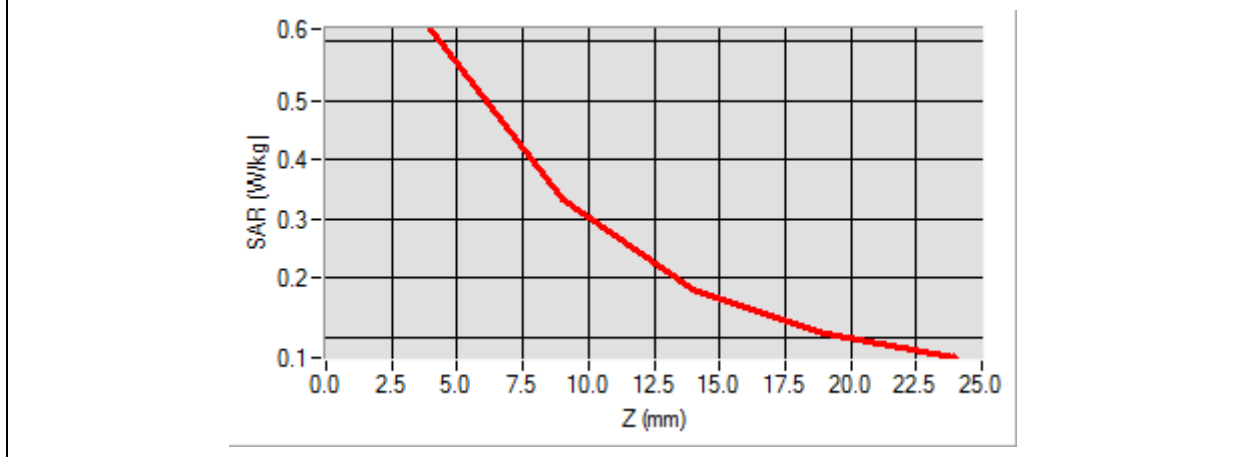
Z (mm)	0.00	4.00	9.00	14.00	19.00
SAR (W/Kg)	0.0000	0.6211	0.3315	0.1808	0.1072

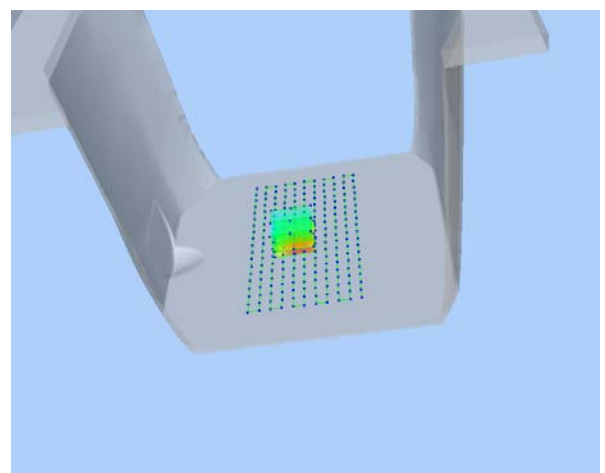

3D screen shot	Hot spot position
	

MEASUREMENT 33

Type: Phone measurement (Complete)

Date of measurement: 01/09/2017

Measurement duration: 12 minutes 3 seconds

E-field Probe: SSE5 - SN 09/13 EP168; ConvF: 7.13; Calibrated: 06/01/2016

A. Experimental conditions

Area Scan	sam_direct_droit2_surf8mm.txt
Phantom	Flat plane
Device Position	Back
Band	GPRS850_2TX
Channels	Low
Signal	Duty Cycle: 1:4

B. SAR Measurement Results

Frequency (MHz)	824.200000
Relative Permittivity (real part)	54.851214
Conductivity (S/m)	0.951454
Power Variation (%)	0.562472
Ambient Temperature	21.1
Liquid Temperature	21.3

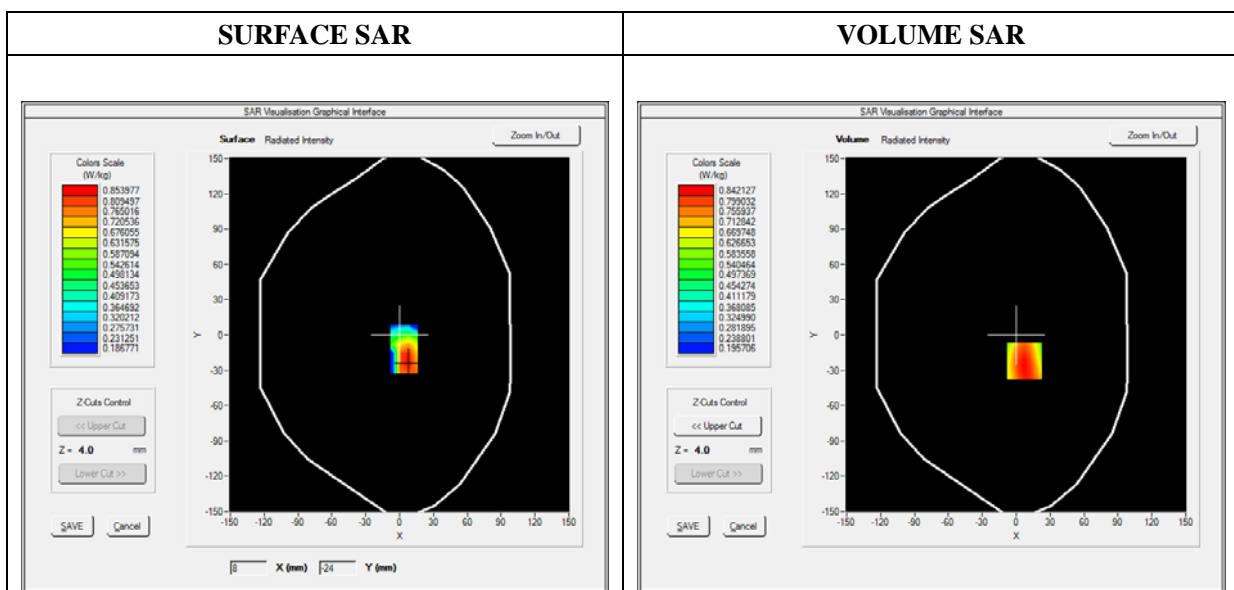

Maximum location: X=7.00, Y=-22.00

SAR 10g (W/Kg)	0.635078
SAR 1g (W/Kg)	0.798418

Z (mm)	0.00	4.00	9.00	14.00	19.00
SAR (W/Kg)	0.0000	0.8395	0.6814	0.5548	0.4528

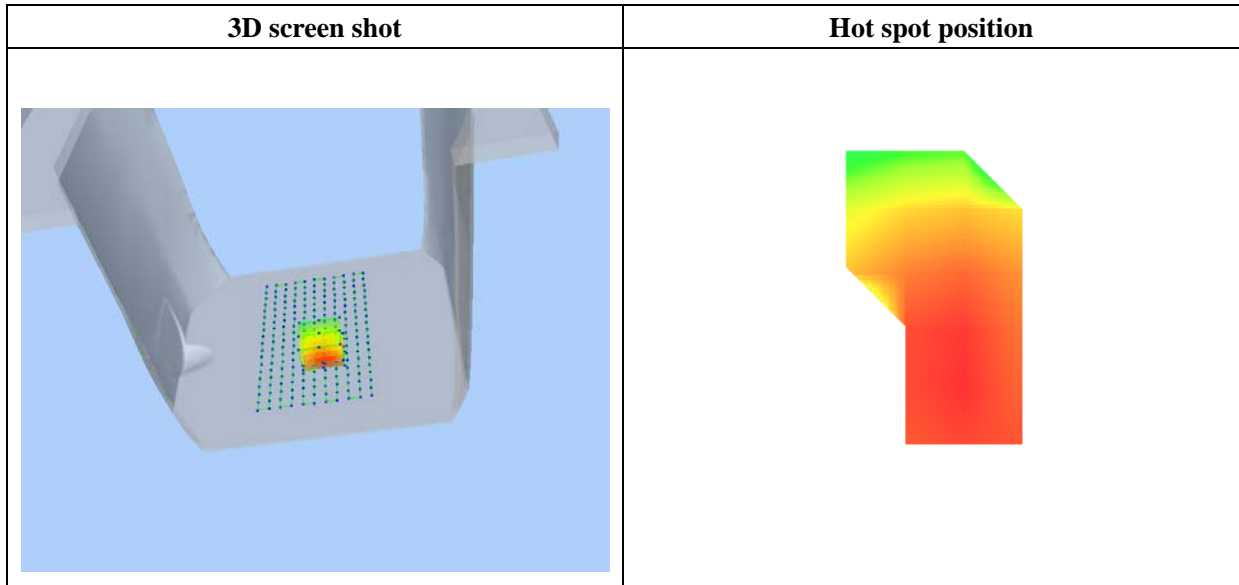
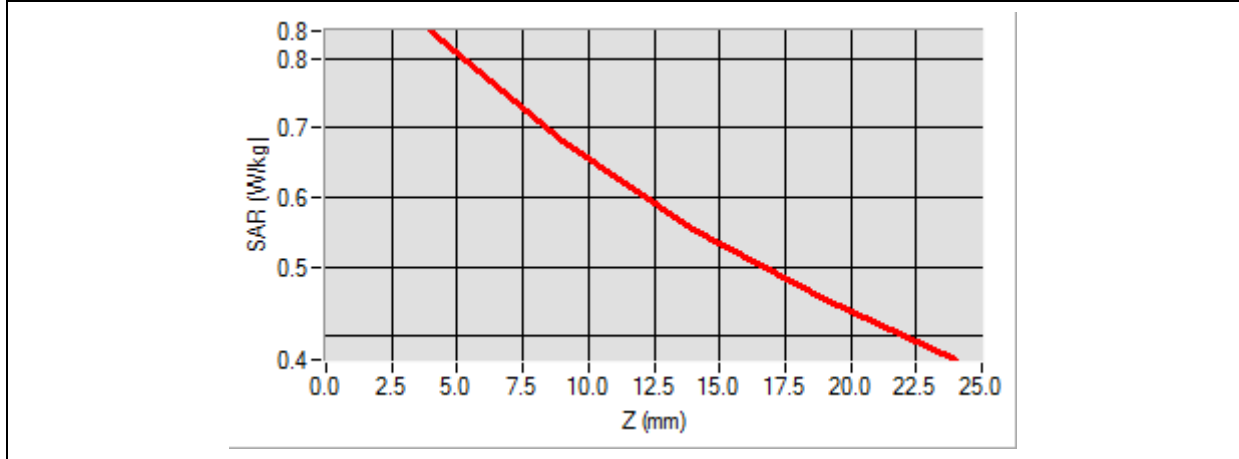

MEASUREMENT 38

Type: Phone measurement (Complete)

Date of measurement: 01/09/2017

Measurement duration: 12 minutes 3 seconds

E-field Probe: SSE5 - SN 09/13 EP168; ConvF: 6.55; Calibrated: 06/01/2016

A. Experimental conditions

Area Scan	sam_direct_droit2_surf8mm.txt
Phantom	Flat plane
Device Position	Back side
Band	GPRS1900_2TX
Channels	High
Signal	Duty Cycle: 1:4

B. SAR Measurement Results

Frequency (MHz)	1909.800000
Relative Permittivity (real part)	52.420415
Conductivity (S/m)	1.501966
Power Variation (%)	0.986340
Ambient Temperature	21.1
Liquid Temperature	21.3

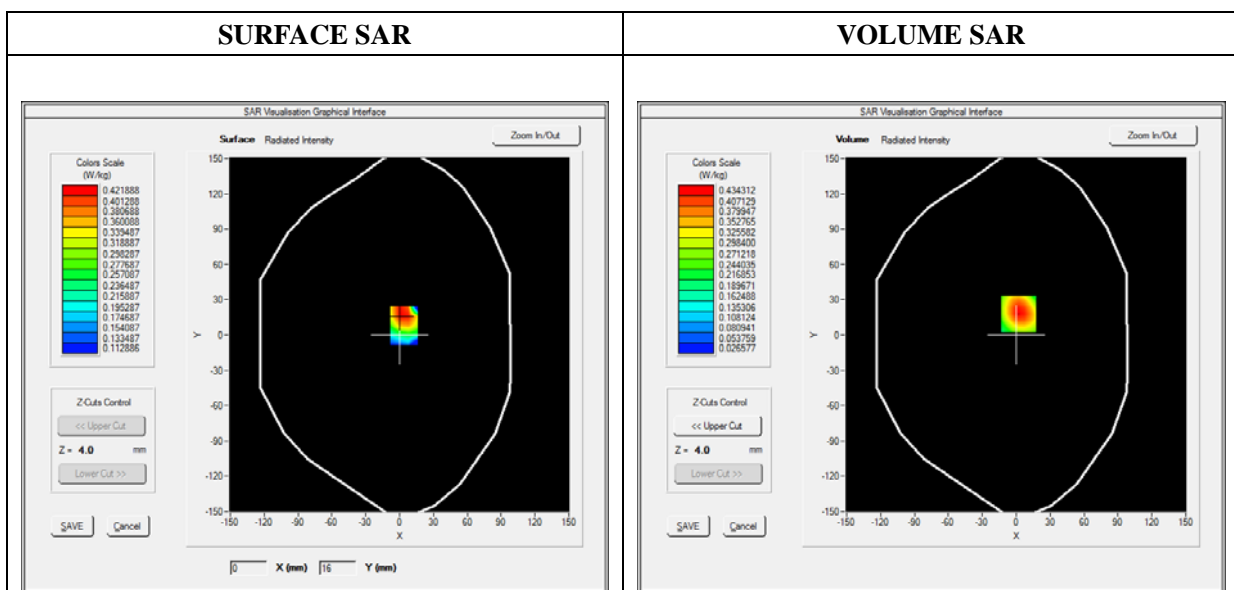

Maximum location: X=2.00, Y=18.00

SAR 10g (W/Kg)	0.240123
SAR 1g (W/Kg)	0.407925

Z (mm)	0.00	4.00	9.00	14.00	19.00
SAR (W/Kg)	0.0000	0.4343	0.2643	0.1614	0.1006

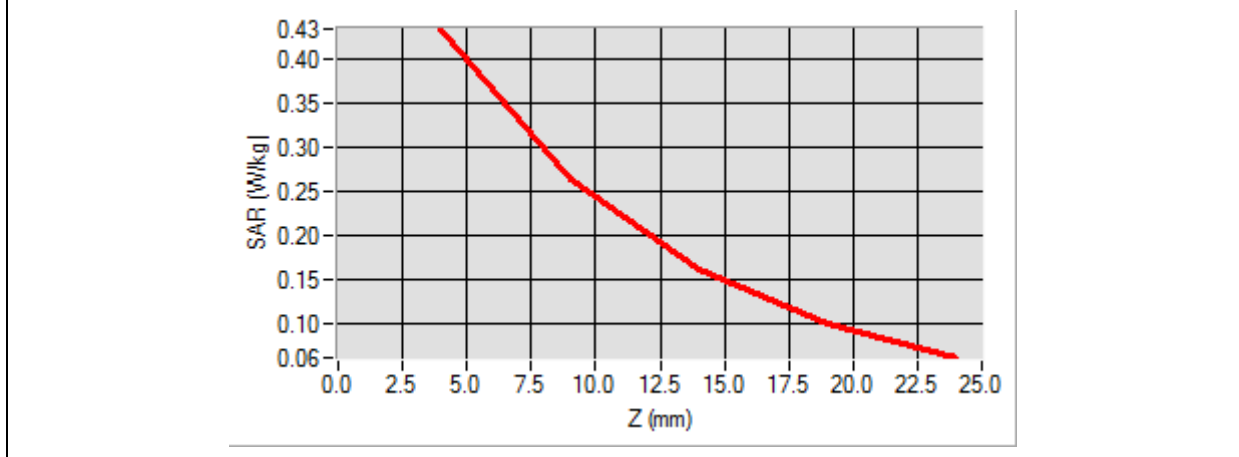

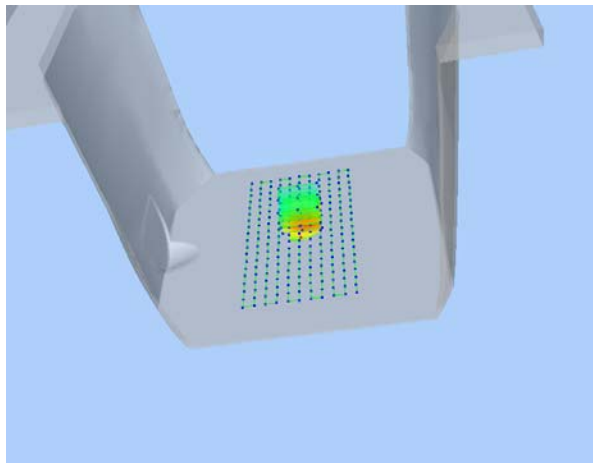
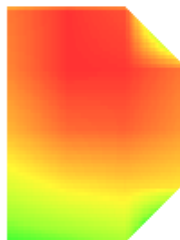
<p>3D screen shot</p>	<p>Hot spot position</p>
	

MEASUREMENT 43

Type: Phone measurement (Complete)

Date of measurement: 01/09/2017

Measurement duration: 12 minutes 3 seconds

E-field Probe: SSE5 - SN 09/13 EP168; ConvF: 7.13; Calibrated: 06/01/2016

A. Experimental conditions

Area Scan	sam_direct_droit2_surf8mm.txt
Phantom	Flat Plane
Device Position	Back
Band	WCDMA850_RMC
Channels	Low
Signal	Duty Cycle 1:1

B. SAR Measurement Results

Frequency (MHz)	826.400000
Relative Permittivity (real part)	54.851214
Conductivity (S/m)	0.951454
Power Variation (%)	0.986458
Ambient Temperature	21.1
Liquid Temperature	21.3

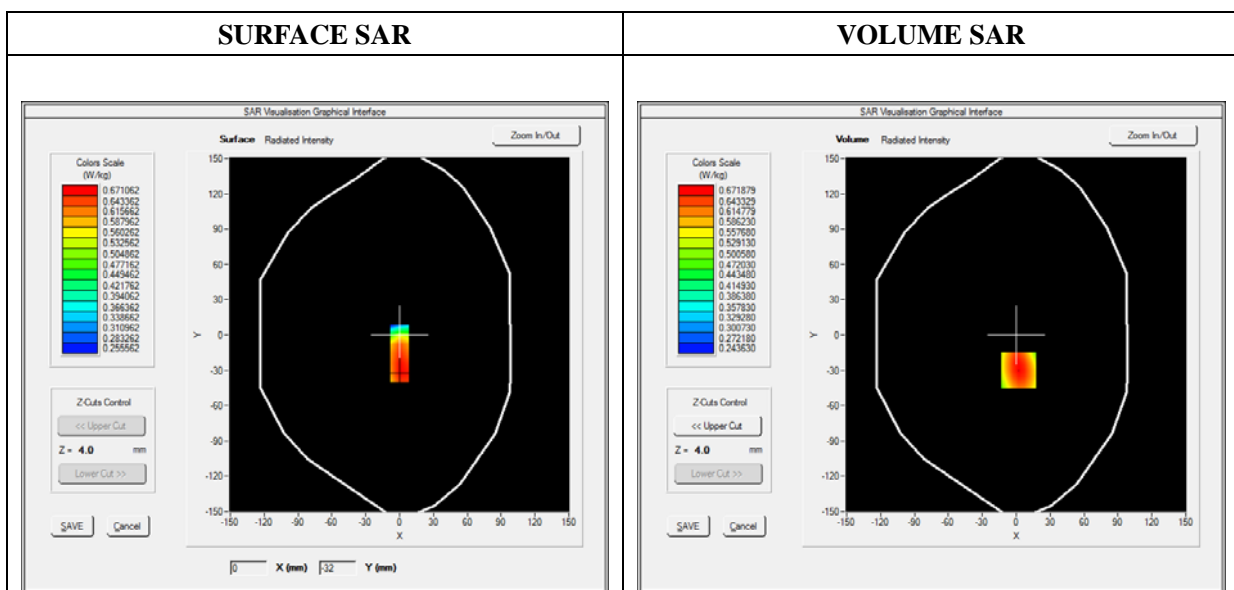



Maximum location: X=2.00, Y=-30.00

SAR 10g (W/Kg)	0.515464
SAR 1g (W/Kg)	0.649605

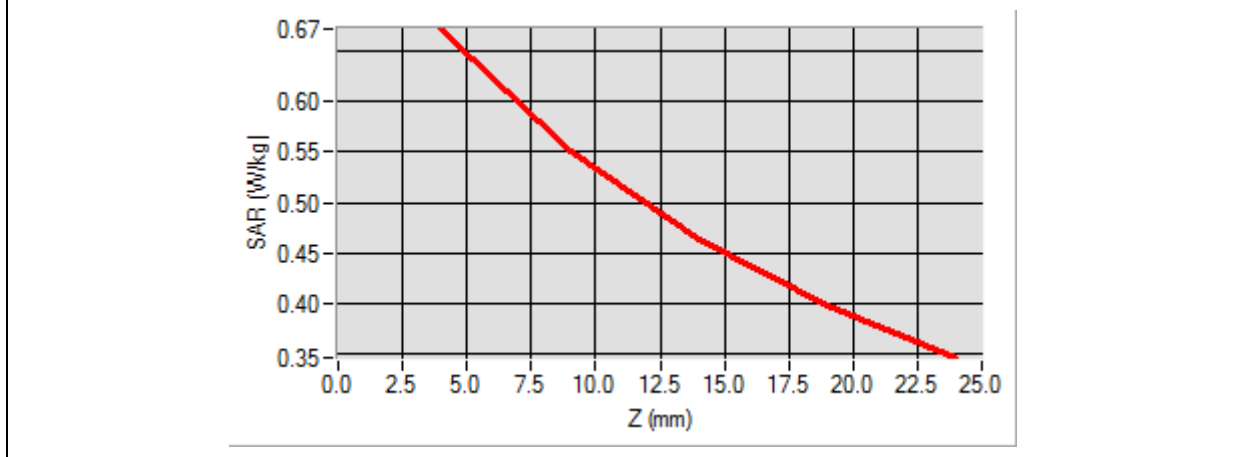
Z (mm)	0.00	4.00	9.00	14.00	19.00
SAR (W/Kg)	0.0000	0.6719	0.5513	0.4631	0.3988

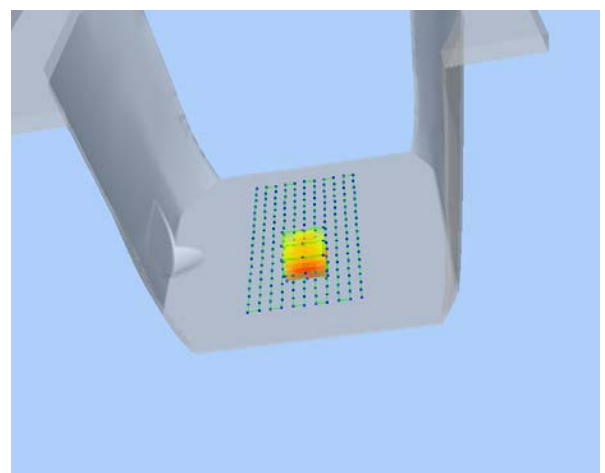

3D screen shot	Hot spot position
	

MEASUREMENT 48

Type: Phone measurement (Complete)

Date of measurement: 01/09/2017

Measurement duration: 12 minutes 3 seconds

E-field Probe: SSE5 - SN 09/13 EP168; ConvF: 6.55; Calibrated: 06/01/2016

A. Experimental conditions

Area Scan	sam_direct_droit2_surf8mm.txt
Phantom	Flat Plane
Device Position	Back
Band	WCDMA1900_RMC
Channels	High
Signal	Duty Cycle 1:1

B. SAR Measurement Results

Frequency (MHz)	1907.600000
Relative Permittivity (real part)	52.420415
Conductivity (S/m)	1.501966
Power Variation (%)	0.687492
Ambient Temperature	21.1
Liquid Temperature	21.3

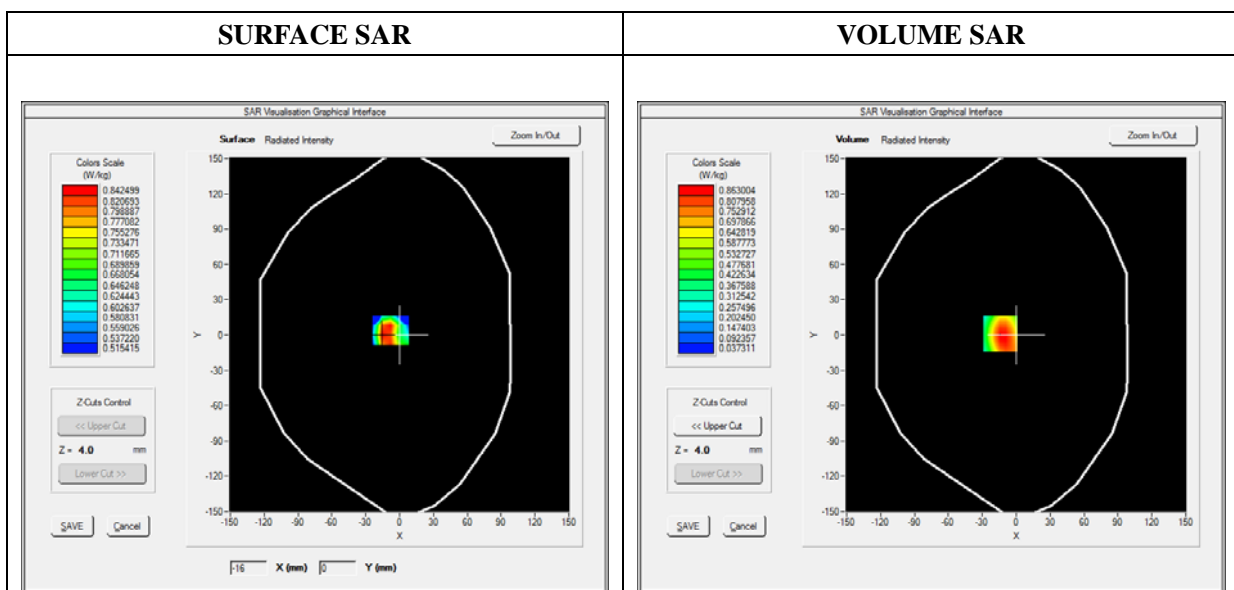

Maximum location: X=-14.00, Y=1.00

SAR 10g (W/Kg)	0.460404
SAR 1g (W/Kg)	0.784101

Z (mm)	0.00	4.00	9.00	14.00	19.00
SAR (W/Kg)	0.0000	0.8630	0.4700	0.2589	0.1514

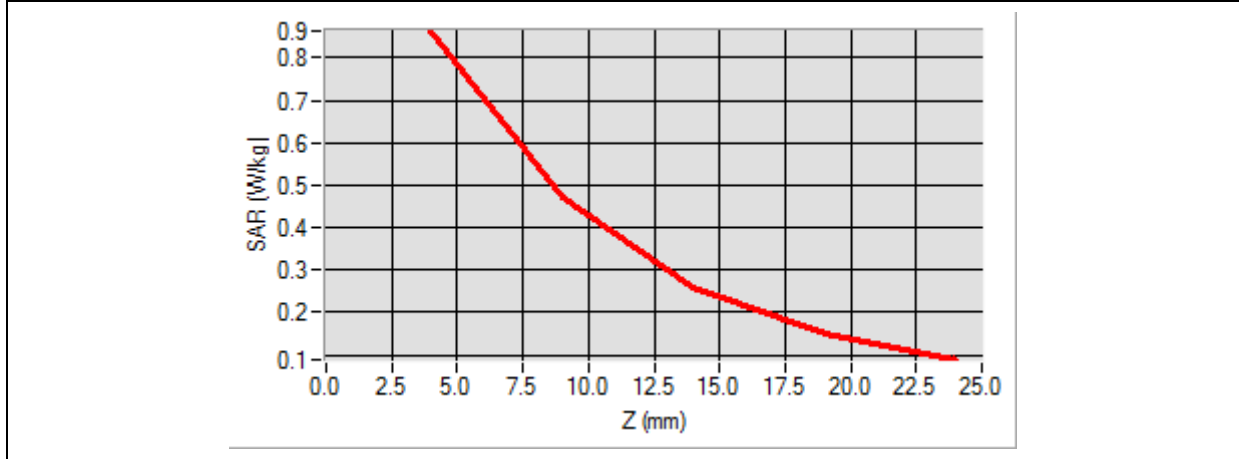

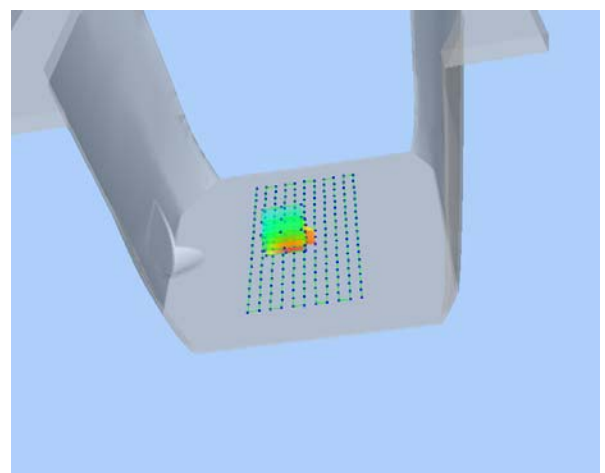
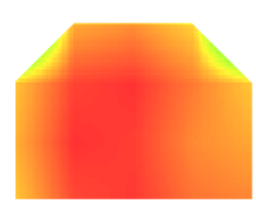
3D screen shot	Hot spot position
	

MEASUREMENT 53

Type: Phone measurement (Complete)

Date of measurement: 01/09/2017

Measurement duration: 12 minutes 3 seconds

E-field Probe: SSE5 - SN 09/13 EP168; ConvF: 5.80; Calibrated: 06/01/2016

A. Experimental conditions

Area Scan	sam_direct_droit2_surf8mm.txt
Phantom	Flat Plane
Device Position	Back
Band	WiFi_802.11b
Channels	High
Signal	Duty Cycle: 1:1

B. SAR Measurement Results

Frequency (MHz)	2462.000000
Relative Permittivity (real part)	52.315622
Conductivity (S/m)	2.001255
Power Variation (%)	0.968546
Ambient Temperature	21.1
Liquid Temperature	21.2

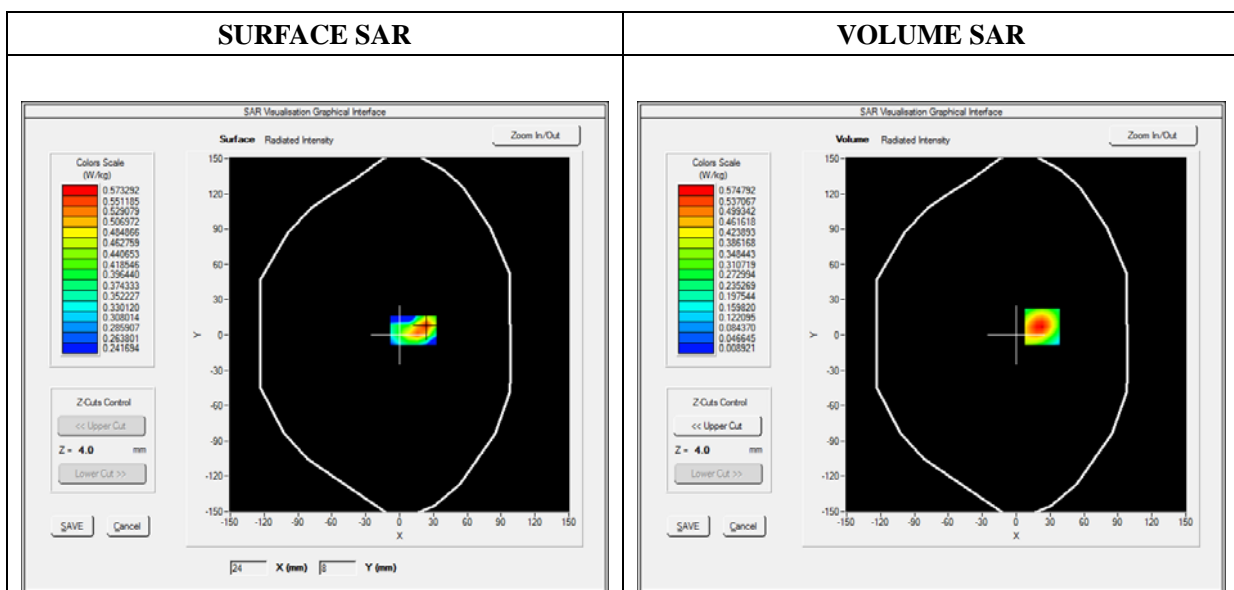

Maximum location: X=23.00, Y=7.00

SAR 10g (W/Kg)	0.264805
SAR 1g (W/Kg)	0.536595

Z (mm)	0.00	4.00	9.00	14.00	19.00
SAR (W/Kg)	0.0000	0.5748	0.2676	0.1213	0.0580

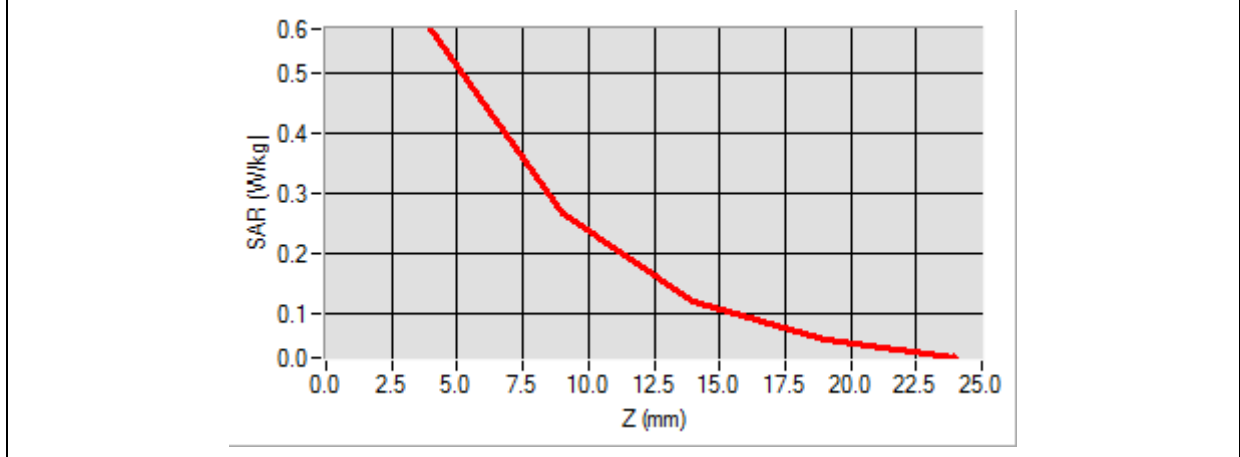

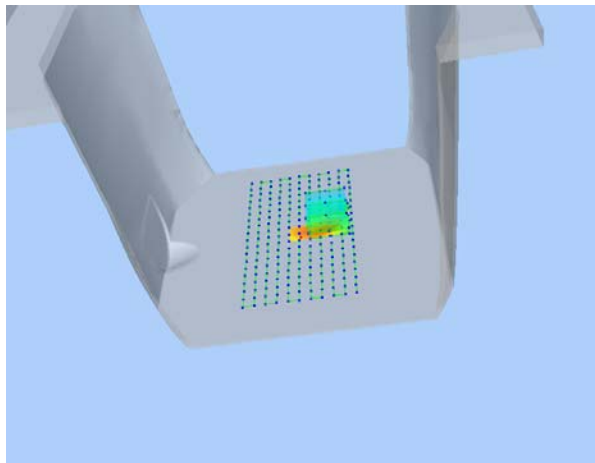
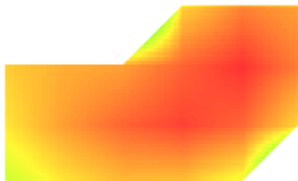
3D screen shot	Hot spot position
	

Annex C. EUT Photos

EUT View Front



EUT View Back



Antenna View



Annex D. Test Setup Photos

Head Exposure Conditions

Cheek

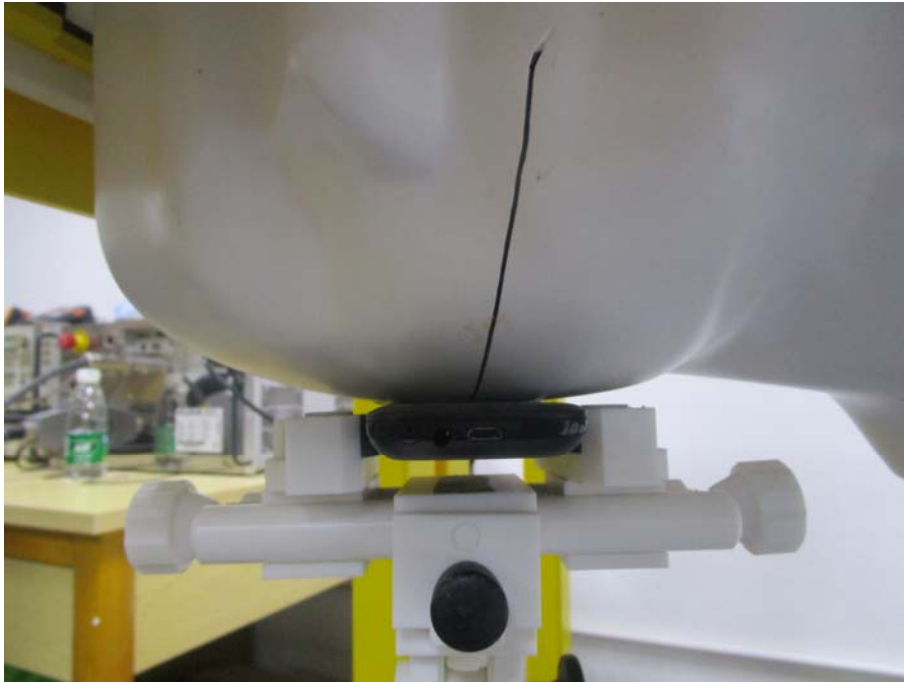

Tilt

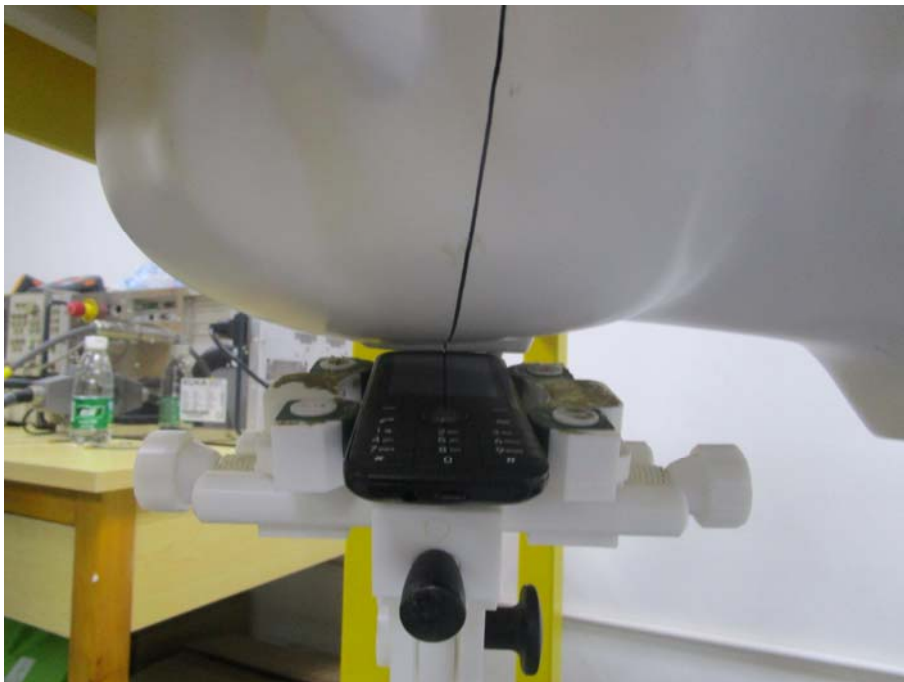

Check

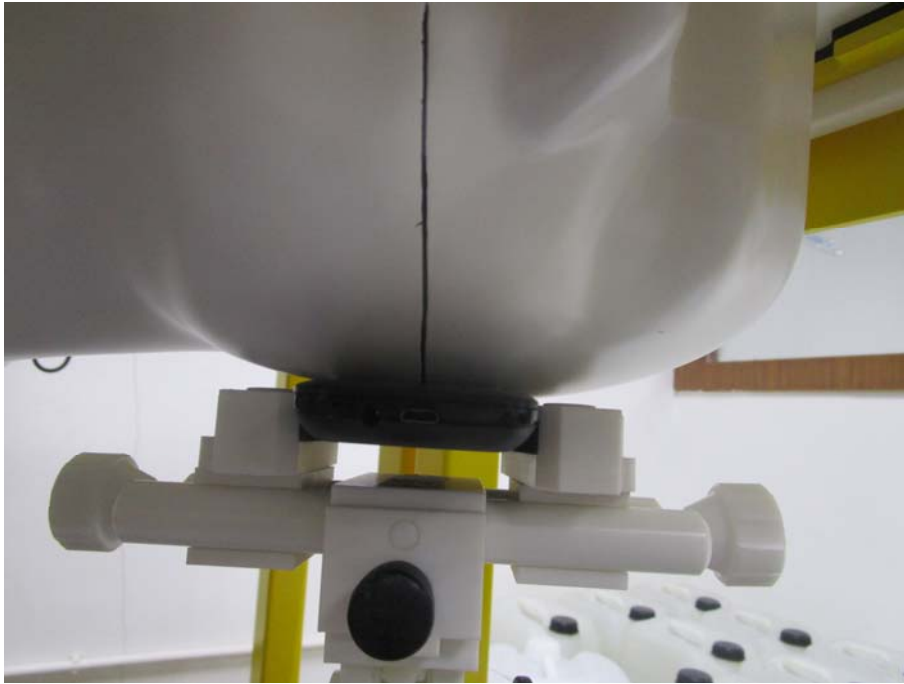

Tilt



Body-worn & Hotspot mode Exposure Conditions

Body Front



Body Back



Hotspot Exposure Conditions

Body Right



Body Left



Body Top



Body Bottom



Annex E. Calibration Certificate

Please refer to the Exhibit for the Calibration Certificate

******* END OF REPORT *******