

Antenna Test Report

Manufacture:

Product Name : M6510-4G

Antenna Type:FPC antenna

Test Date:2024/04/08

Tested by: Dai Hao

Approved by:Yu Jianwei

1. General Description

Manufacturer	Tianyutong Electronic Technology Co., Ltd
Address	
Test Location	211 Tairan Industrial and Trade Park, Futian District, Shenzhen City, Guangdong Province
Product Name	M6510-4G
Antenna Type	FPC antenna
test Items	GAIN;Efficiency;Radiation Pattern
Test Frequency	706-2690MHz

2. Test Configuration

Test Environment

Temperature (°C)	25.5
Humidity (%RH)	60
Atmospheric Pressure(kpa)	101.5

Test Equipment

Test Instrument	R&S ZNB8
-----------------	----------

5.1 2D方向图

GSM850 128 TRP E2

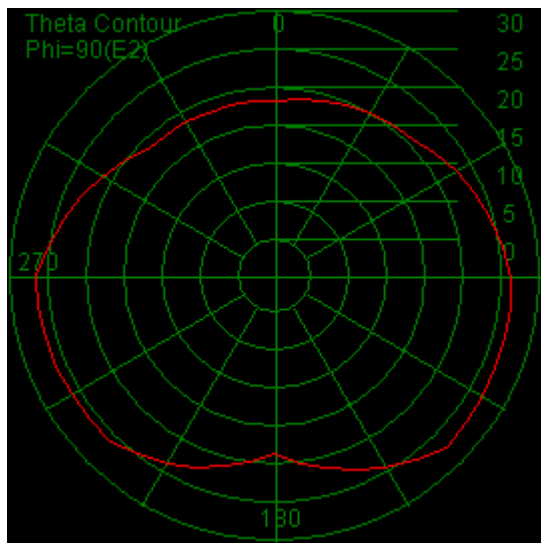

GSM850 192 TRP E2

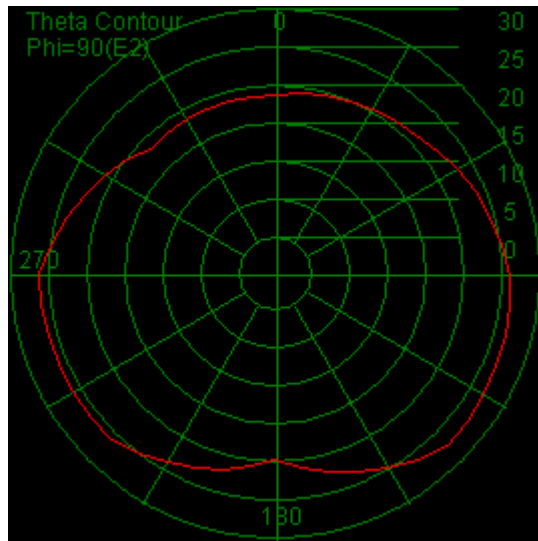

GSM850 251 TRP E2

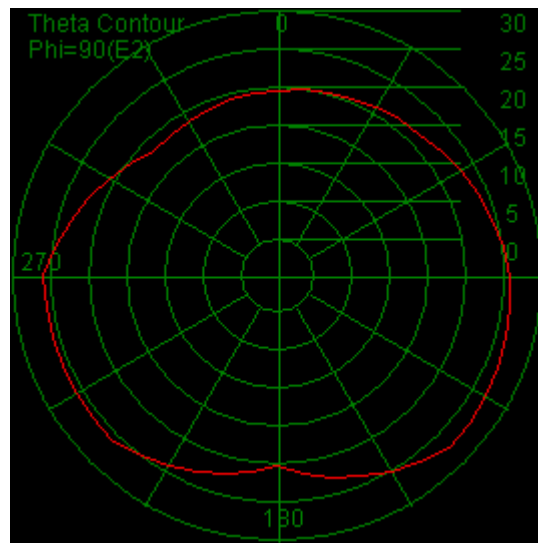

GSM850 251 TIS E2

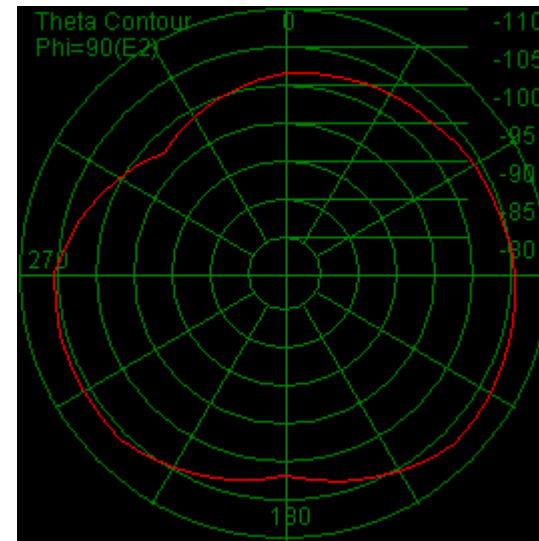

EGSM 1 TRP E2

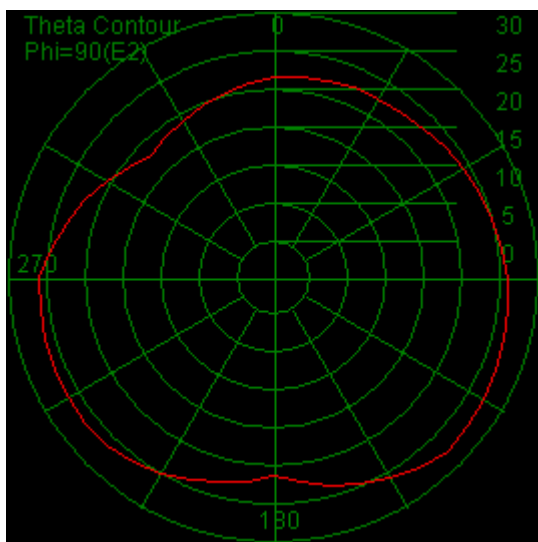

EGSM 62 TRP E2

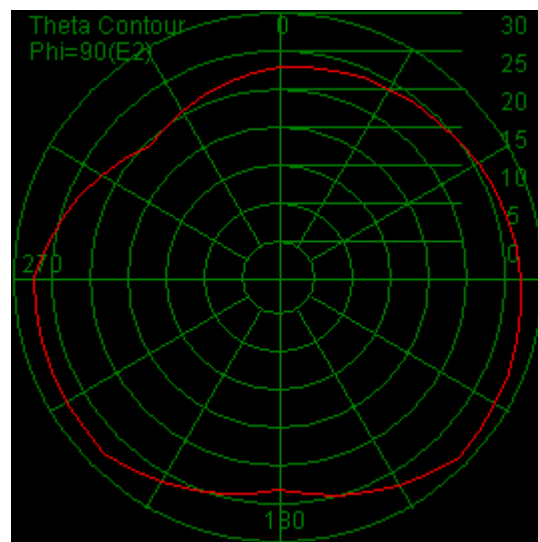

EGSM 124 TRP E2

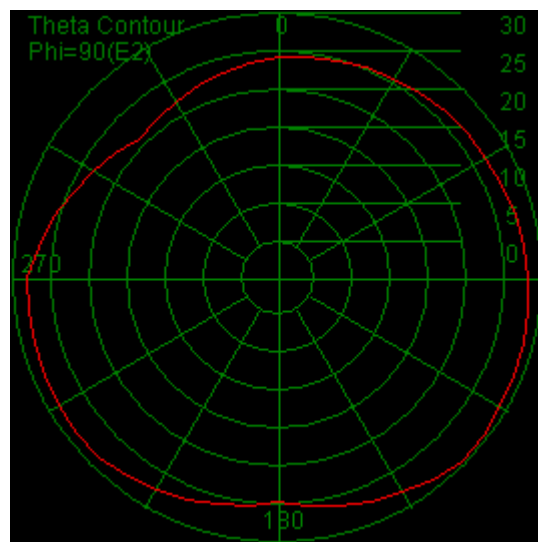

EGSM 124 TIS E2

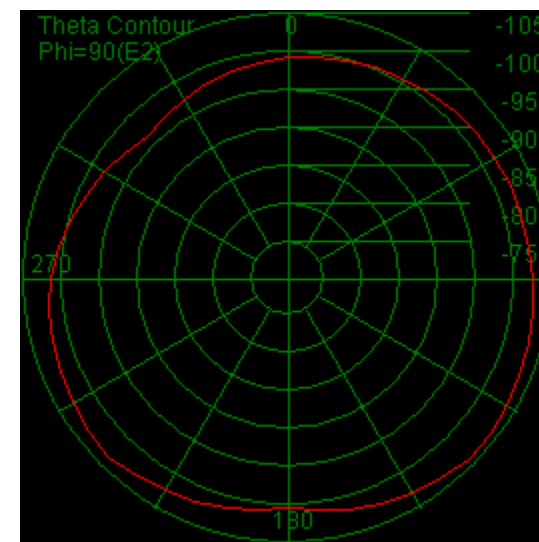

DCS 512 TRP E2

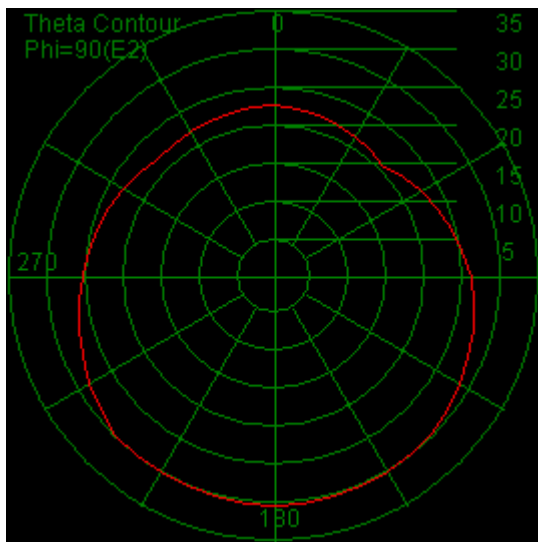

DCS 698 TRP E2

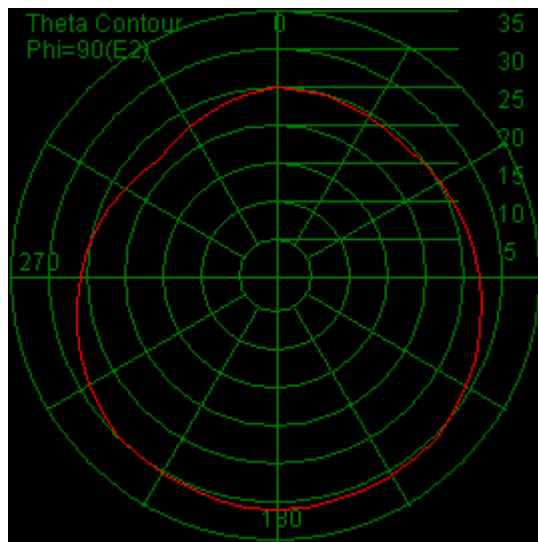

DCS 885 TRP E2

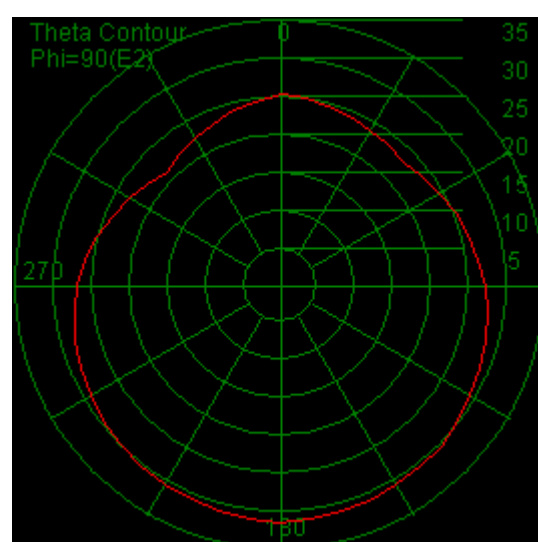

DCS 885 TIS E2

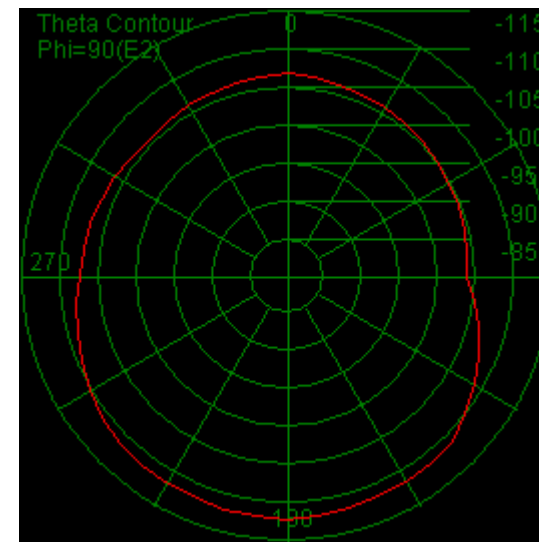

PCS 512 TRP E2

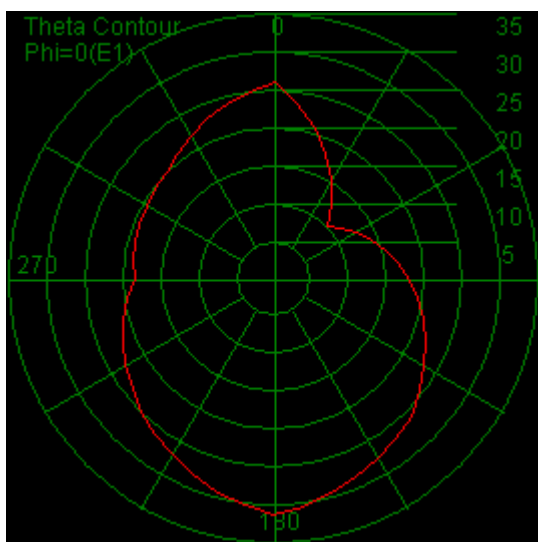

PCS 661 TRP E2

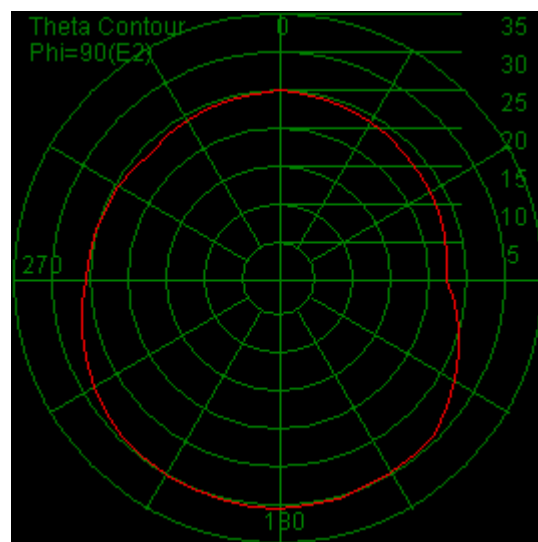

PCS 810 TRP E2

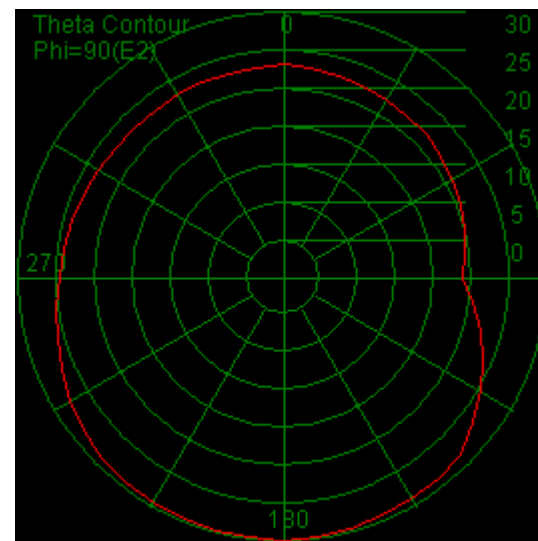

PCS 810 TIS E2

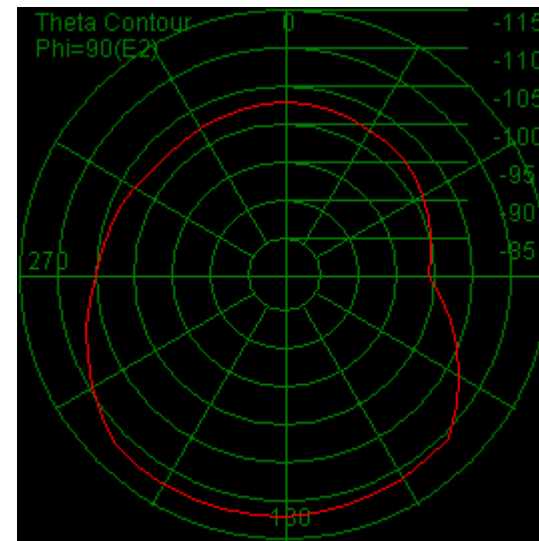

WCDMA B2 9262 TRP E2

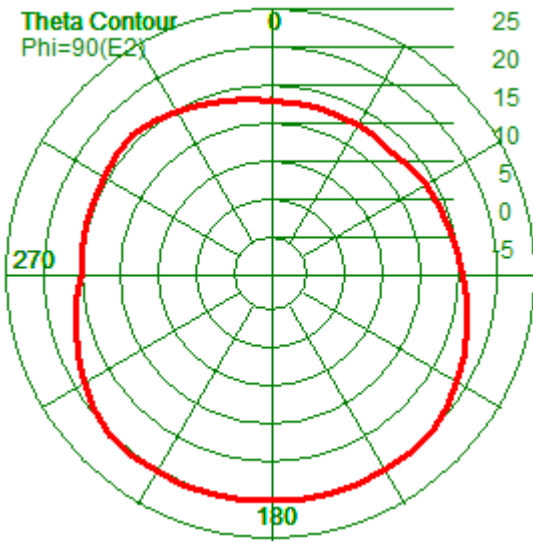

WCDMA B2 9400 TRP E2

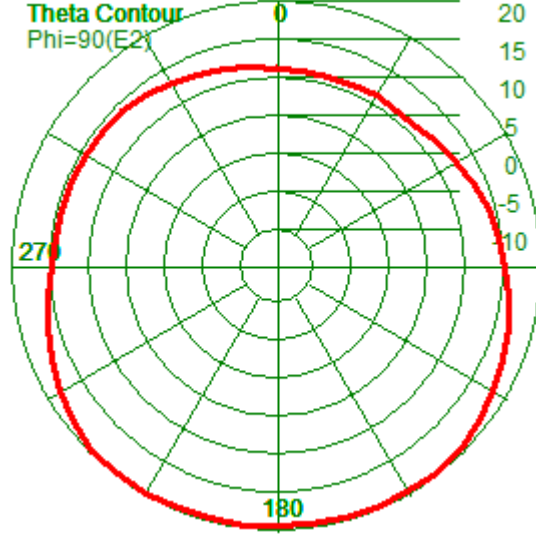

WCDMA B2 9538 TRP E2

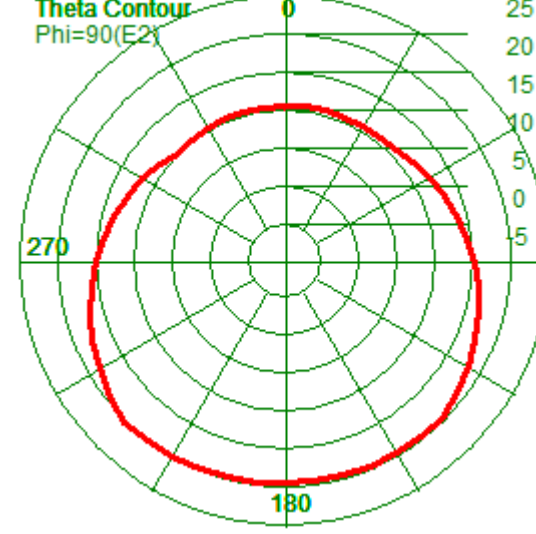

WCDMA B2 9938 TIS E2

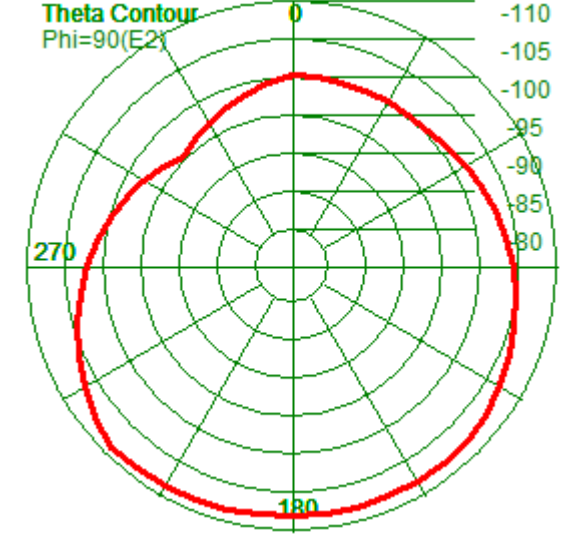

WCDMA B4 1312 TRP E2

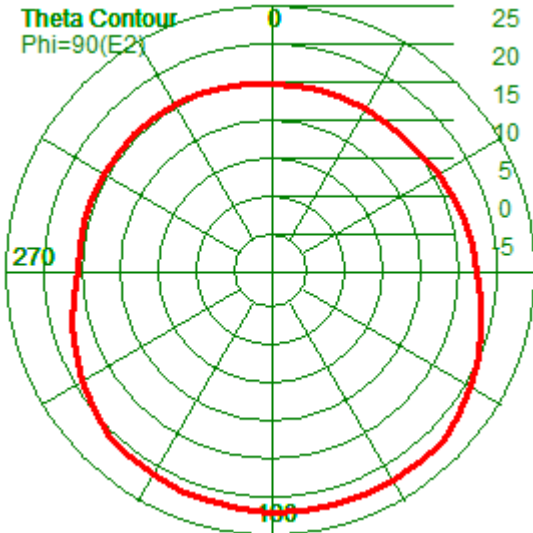

WCDMA B4 1413 TRP E2

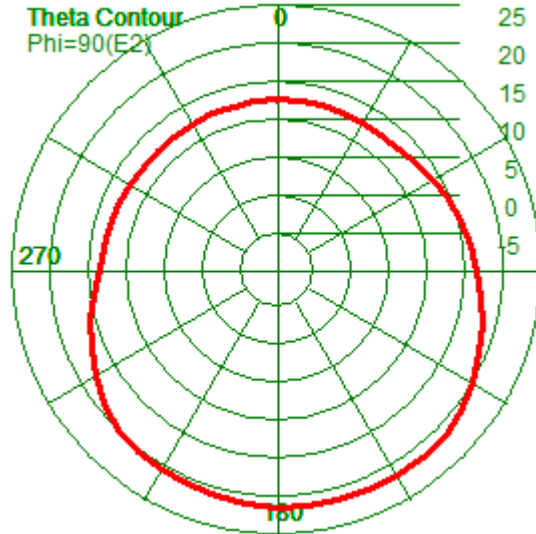

WCDMA B4 1513 TRP E2

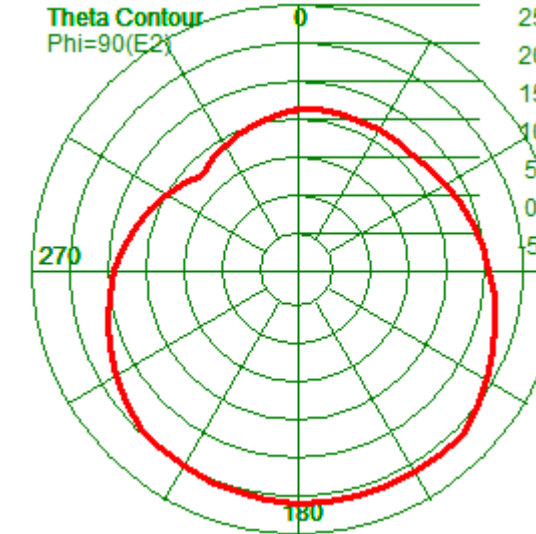

WCDMA B4 1738 TIS E2

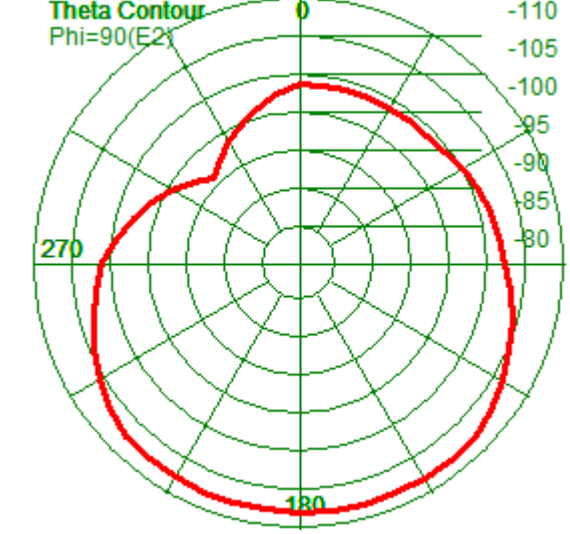

WCDMA B5 4132 TRP E2

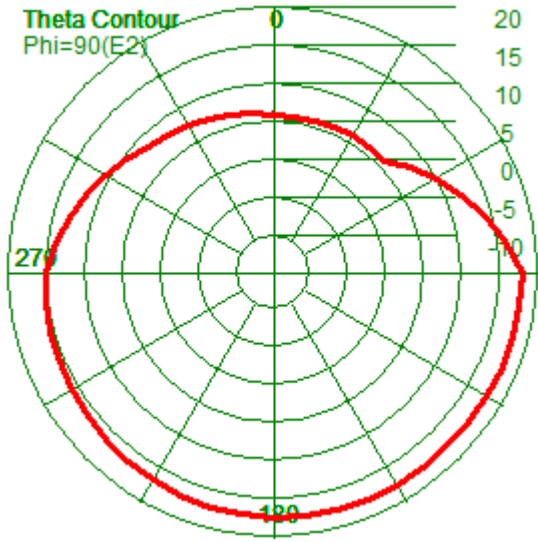

WCDMA B5 4183 TRP E2

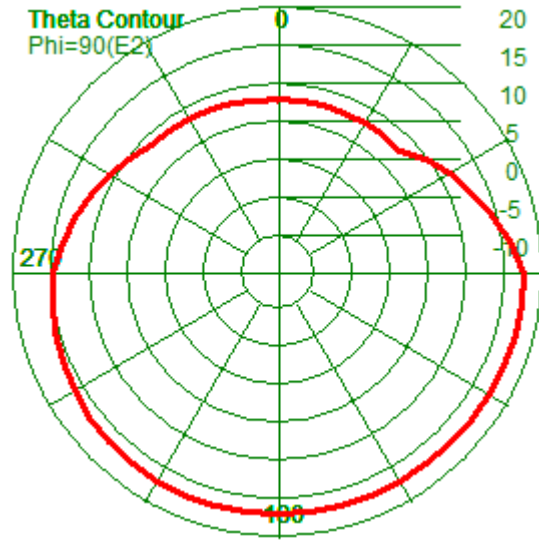

WCDMA B5 4233 TRP E2

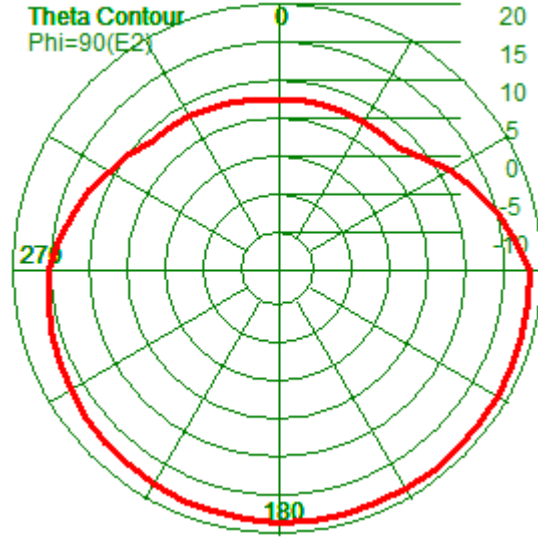

WCDMA B5 4458 TIS E2

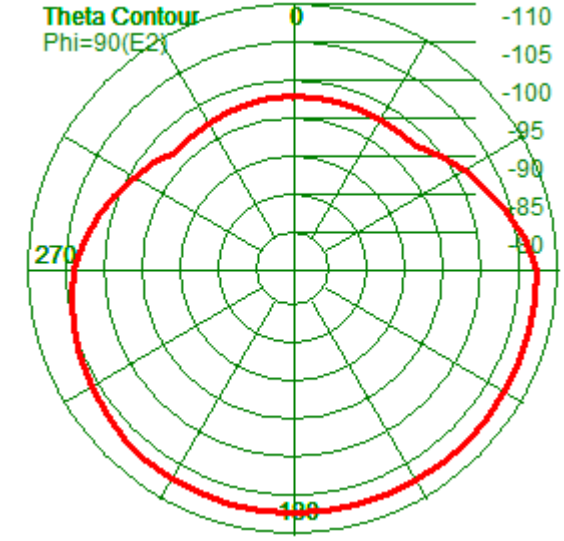

LTE B2 18650 TRP E2

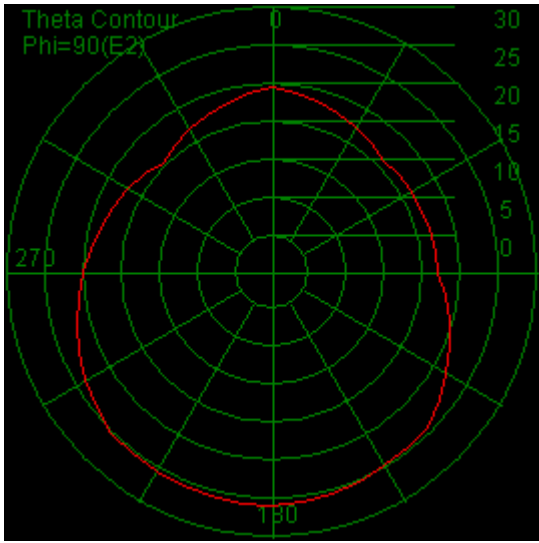

LTE B2 18900 TRP E2

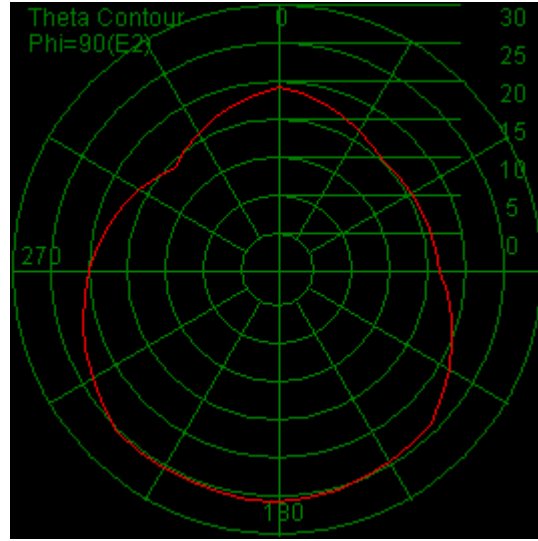

LTE B2 19150 TRP E2

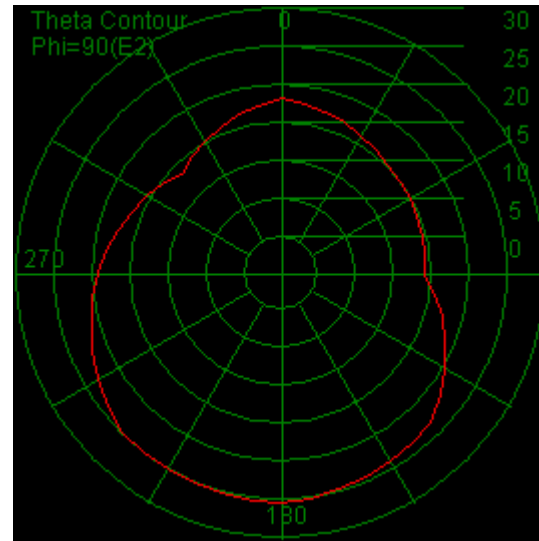

LTE B2 1150 TIS E2

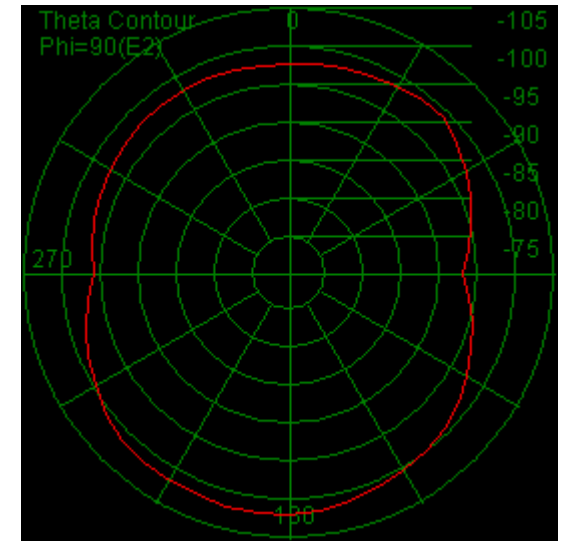

LTE B4 20000 TRP E2

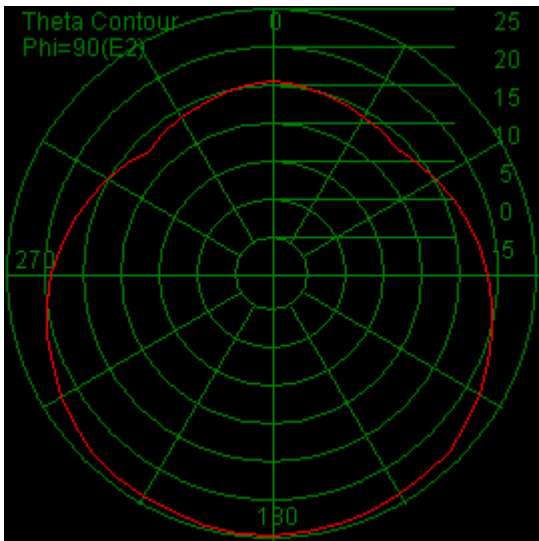

LTE B4 20175 TRP E2

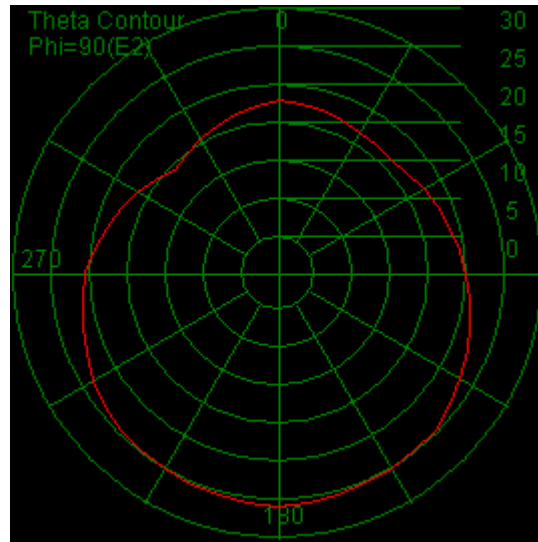

LTE B4 20350 TRP E2

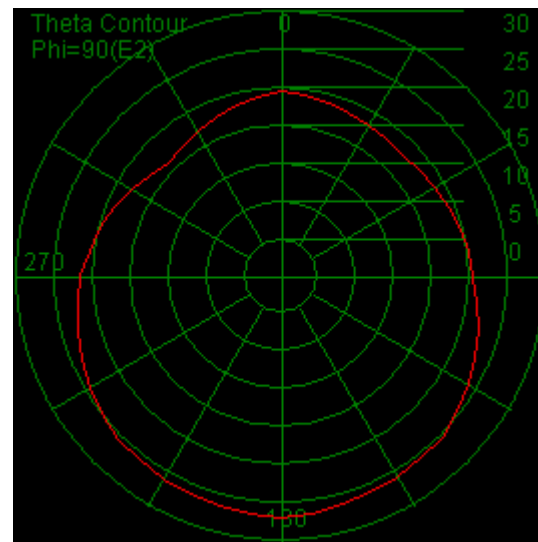

LTE B4 2350 TIS E2

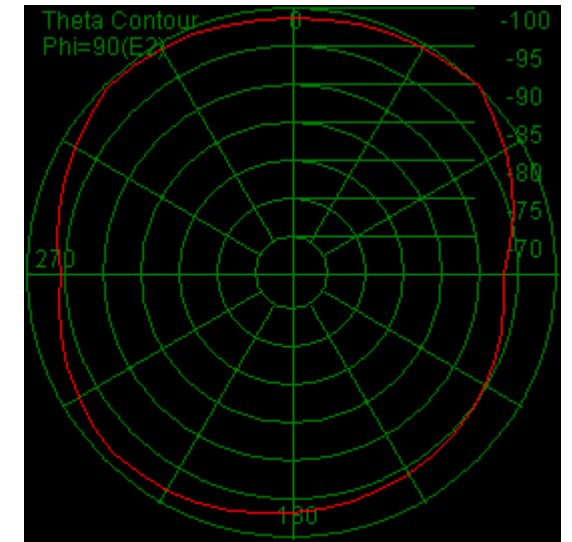

LTE B5 20450 TRP E2

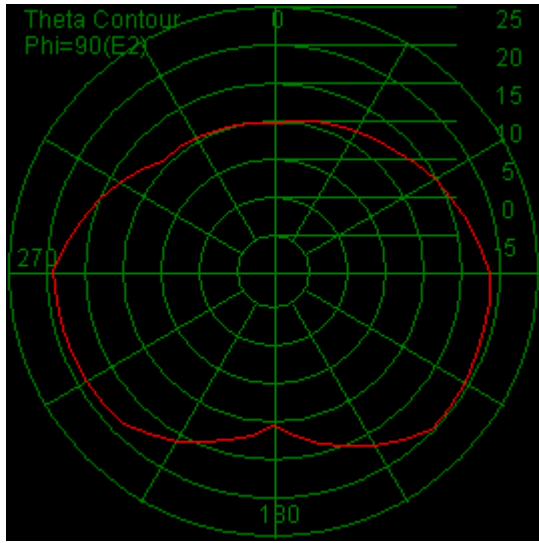

LTE B5 20525 TRP E2

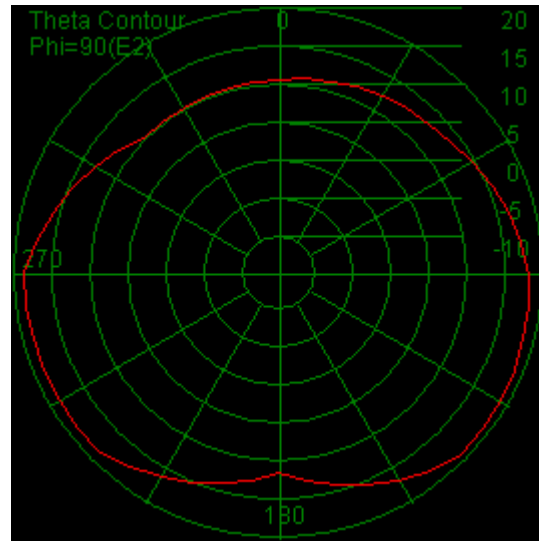

LTE B5 20600 TRP E2

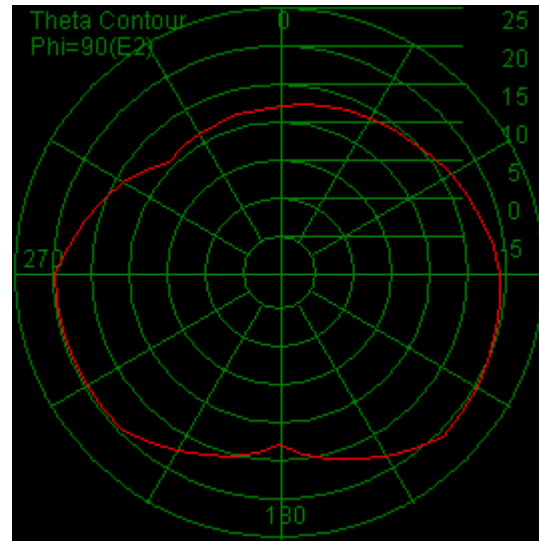

LTE B5 2600 TIS E2

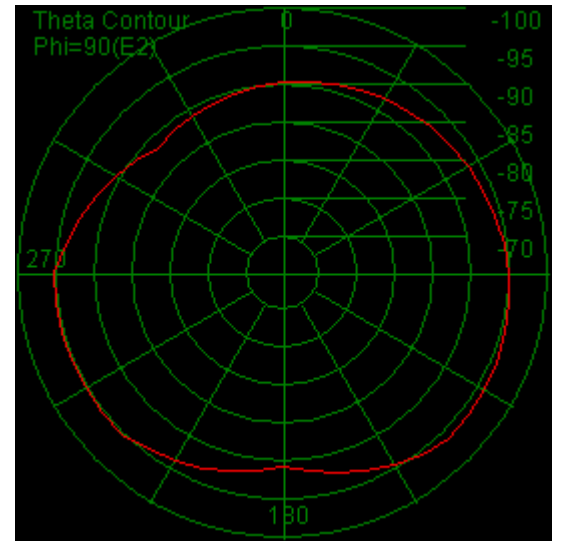

LTE B12 23035 TRP E2

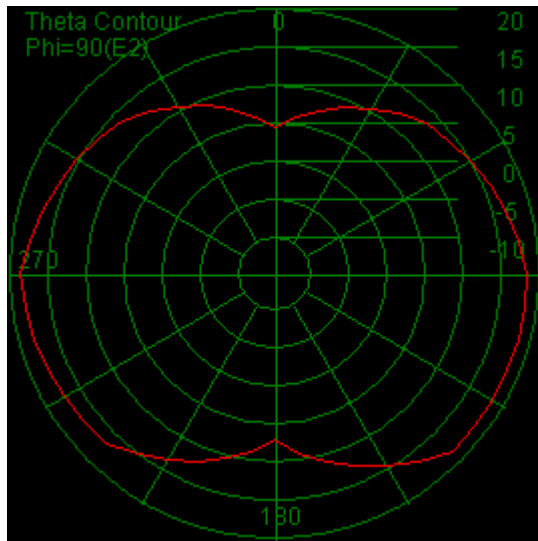

LTE B12 23095 TRP E2

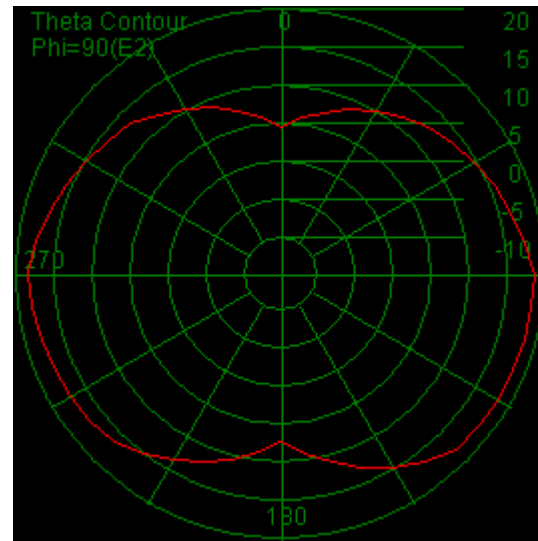

LTE B12 23155 TRP E2

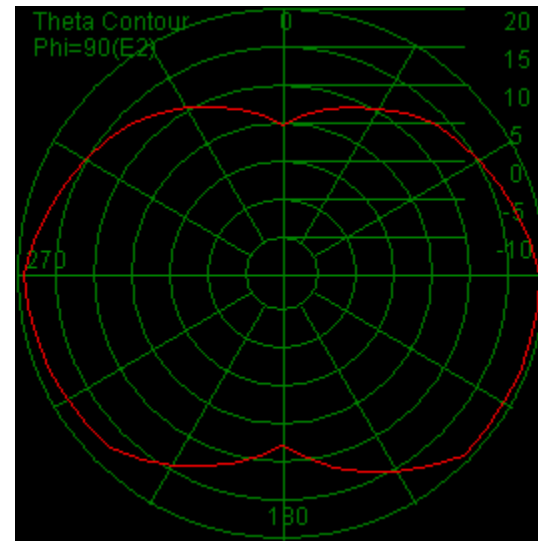

LTE B12 5155 TRP E2

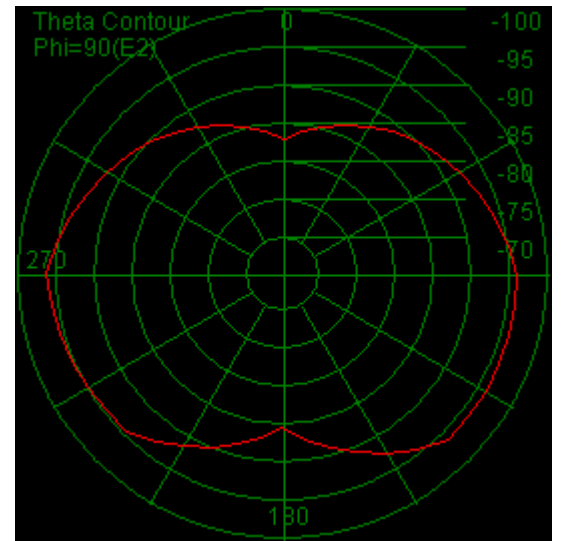

LTE B13 23230 TRP E2

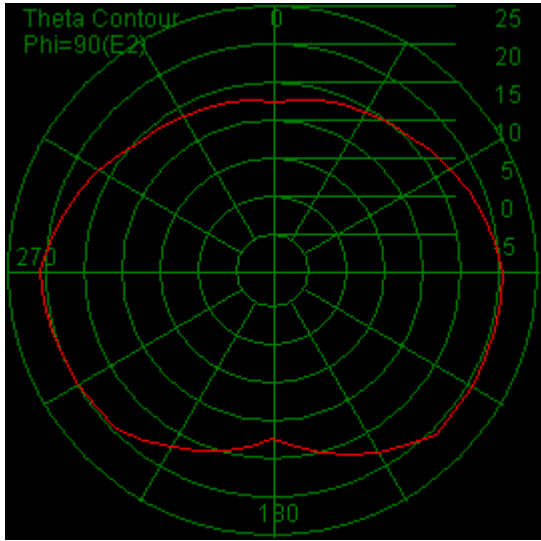

LTE B13 23230 TRP E2

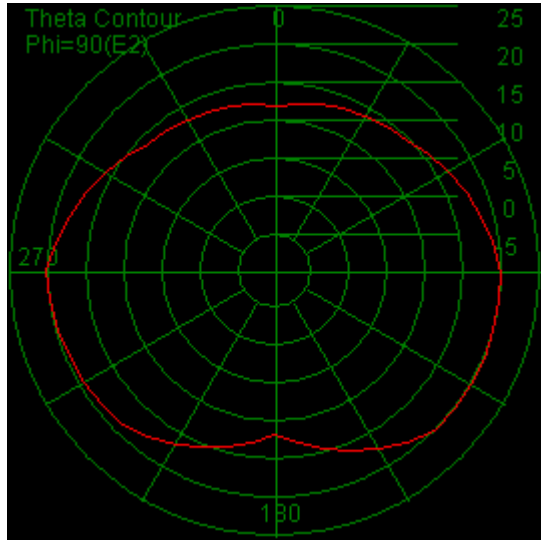

LTE B13 23230 TRP E2

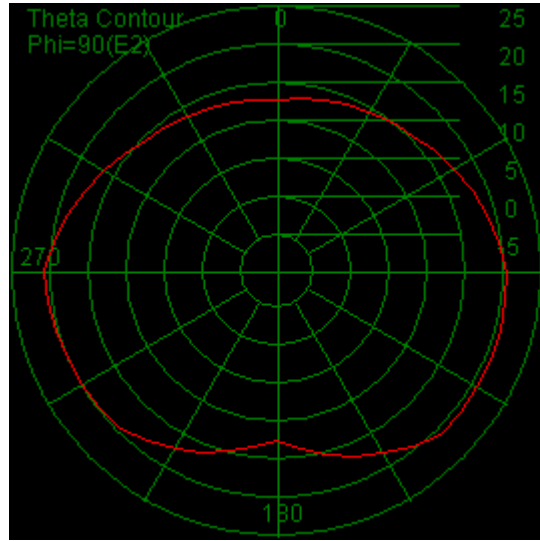

LTE B13 5230 TIS E2

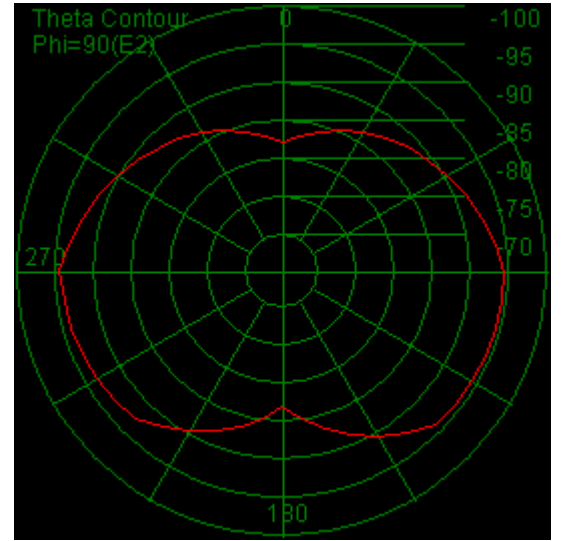

LTE B17 23780 TRP E2

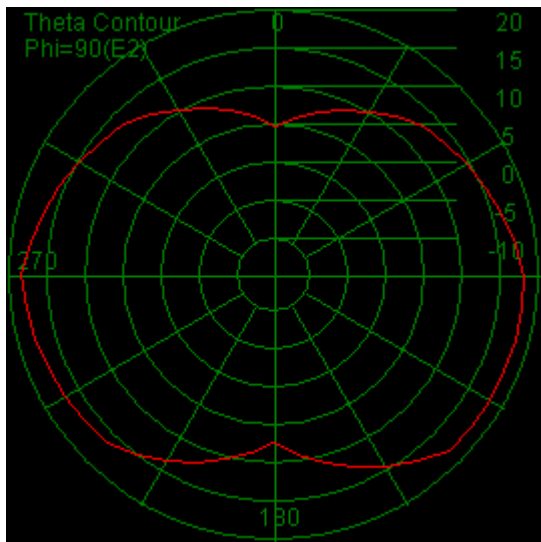

LTE B17 23790 TRP E2

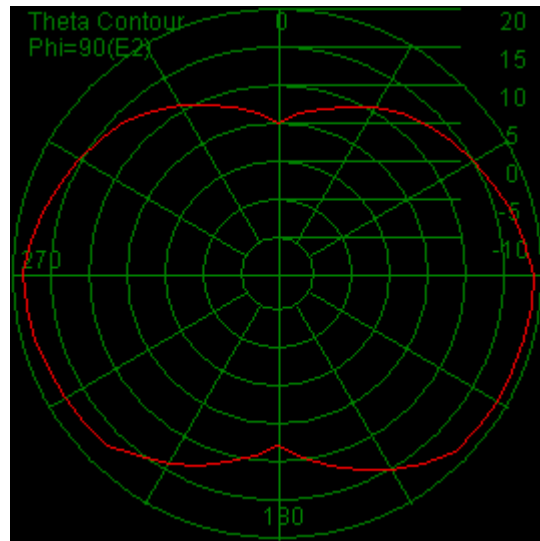

LTE B17 23800 TRP E2

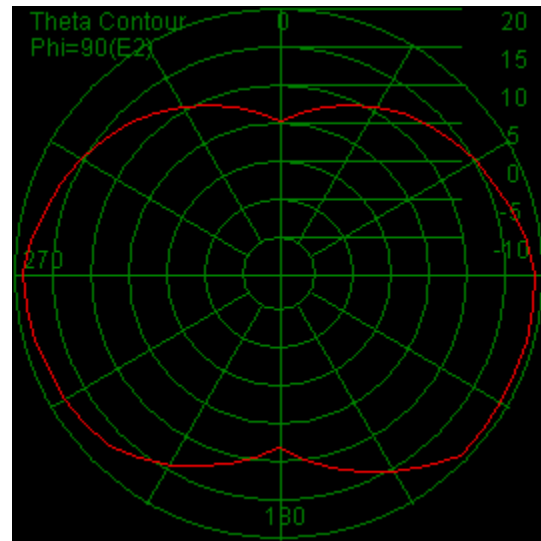

LTE B17 5800 TRP E2

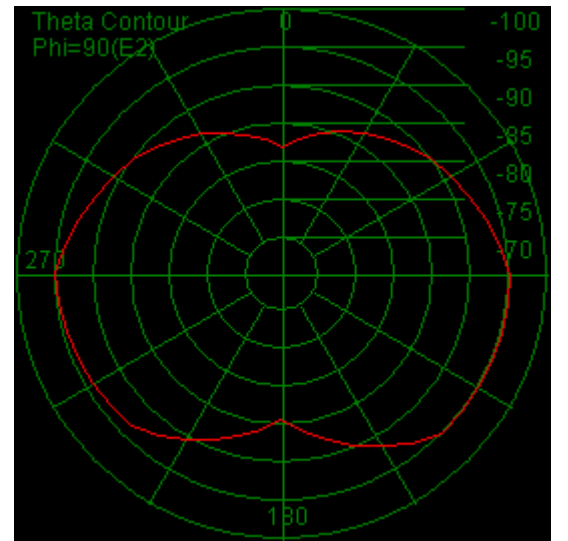

LTE B25 5800 TRP E2

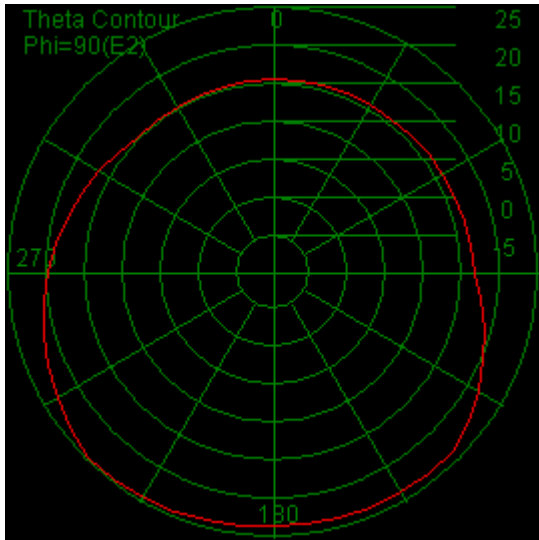

LTE B25 26365 TRP E2

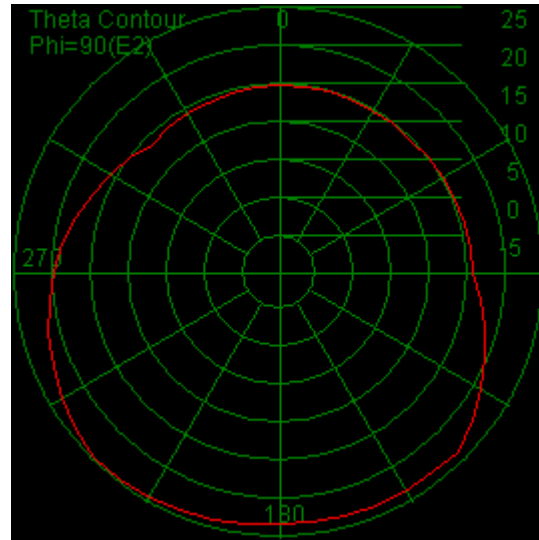

LTE B25 26665 TRP E2

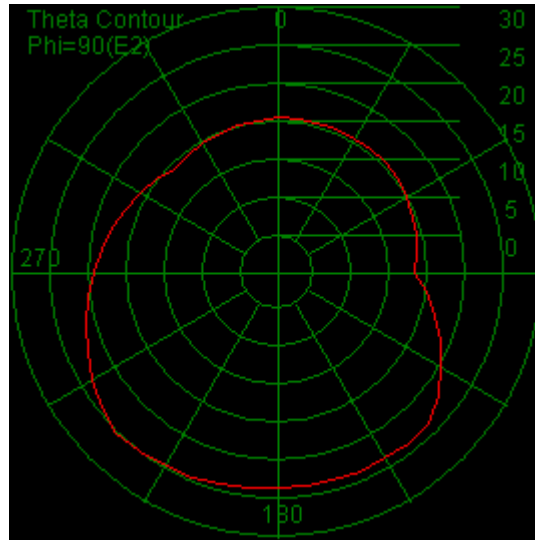

LTE B25 8665 TIS E2

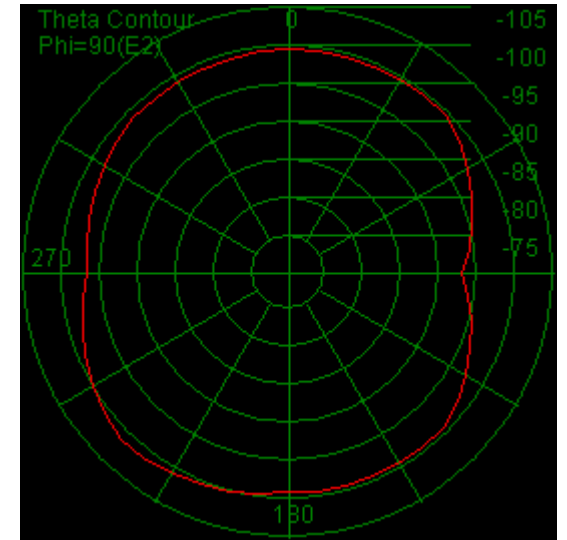

LTE B26 26715 TRP E2

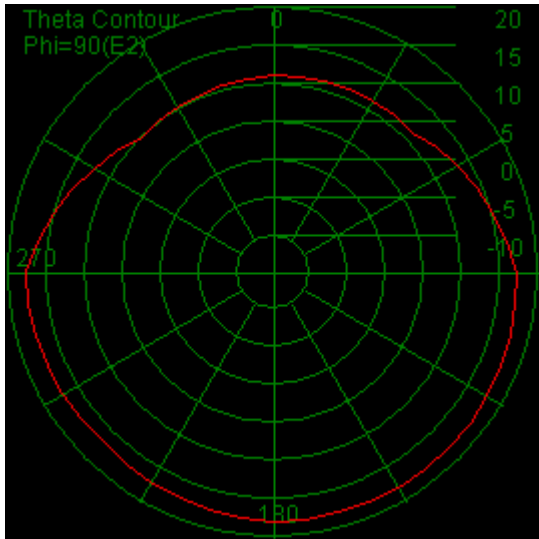

LTE B26 26865 TRP E2

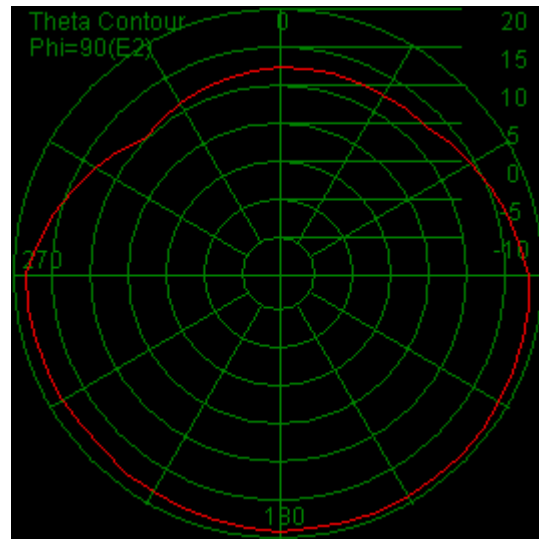

LTE B26 27015 TRP E2

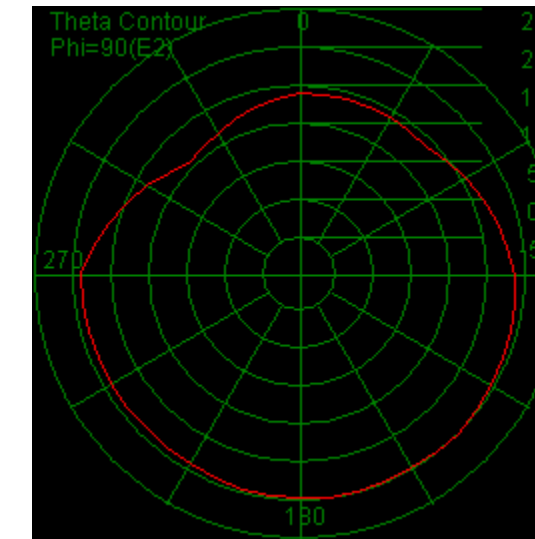

LTE B26 9015 TRP E2

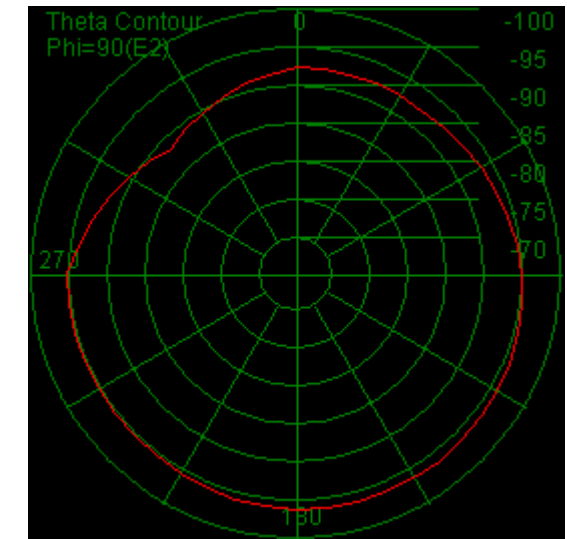

LTE B66 132022 TRP E2

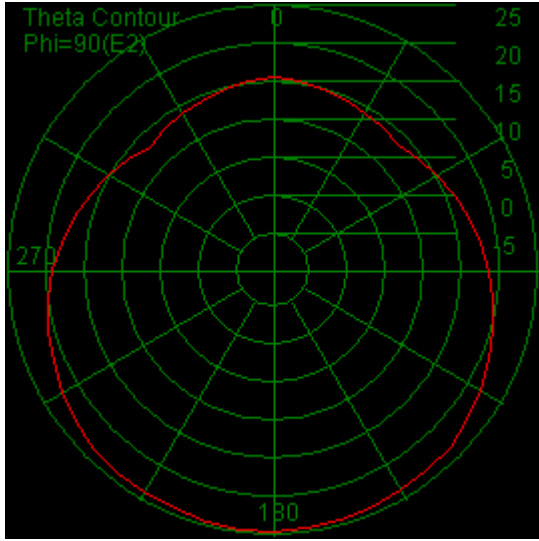

LTE B66 132322 TRP E2

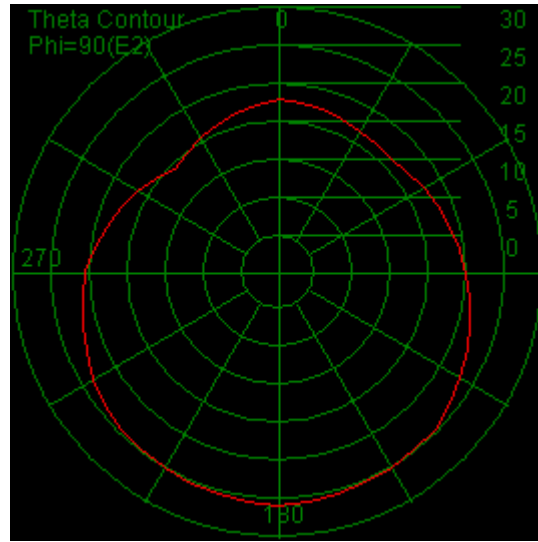

LTE B66 132622 TRP E2

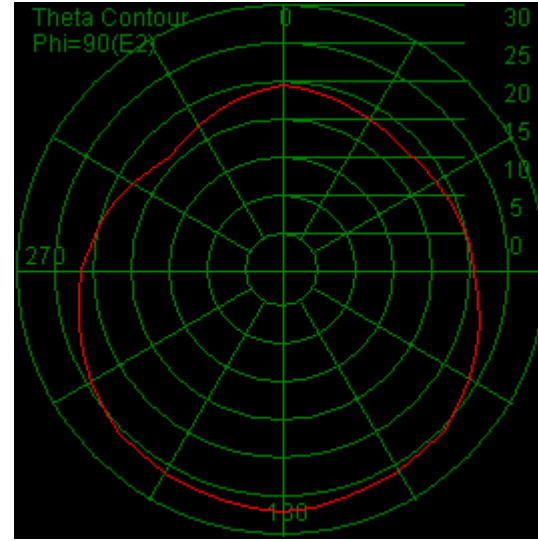

LTE B66 67086 TIS E2

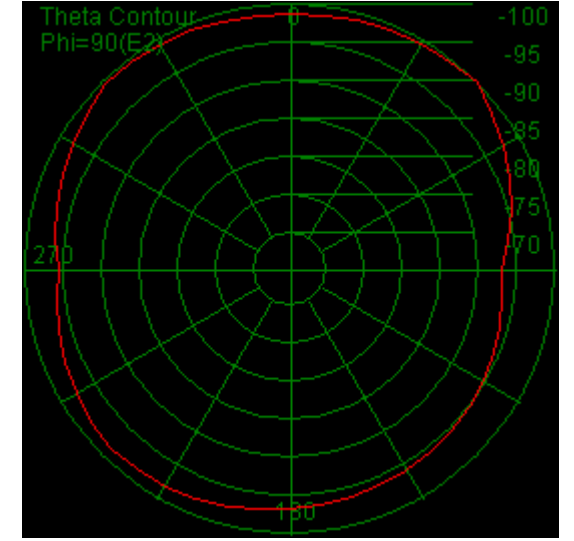

LTE B71 133172 TRP E2

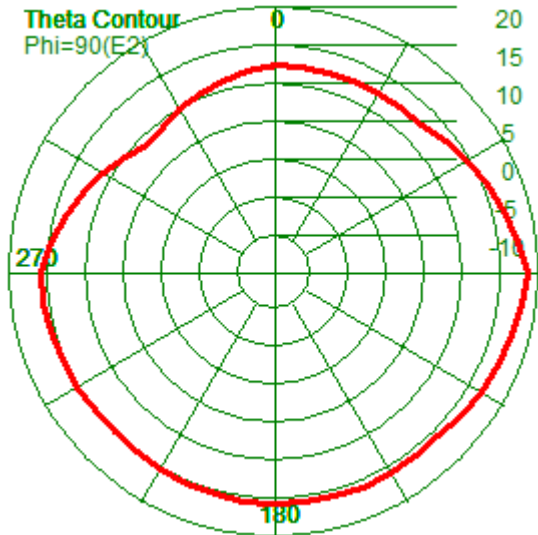

LTE B71 133297 TRP

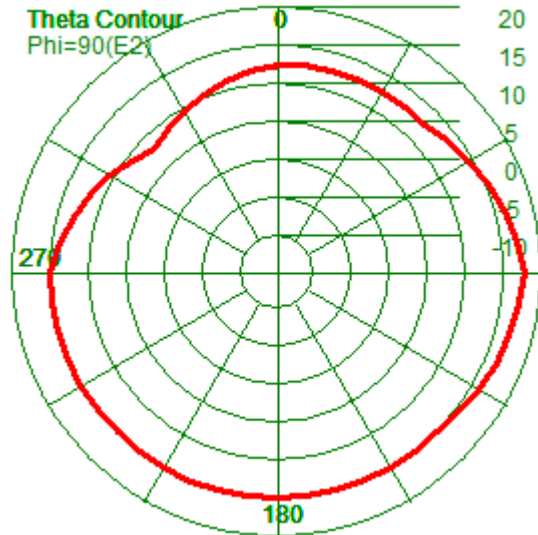

LTE B71 133422 TRP E2

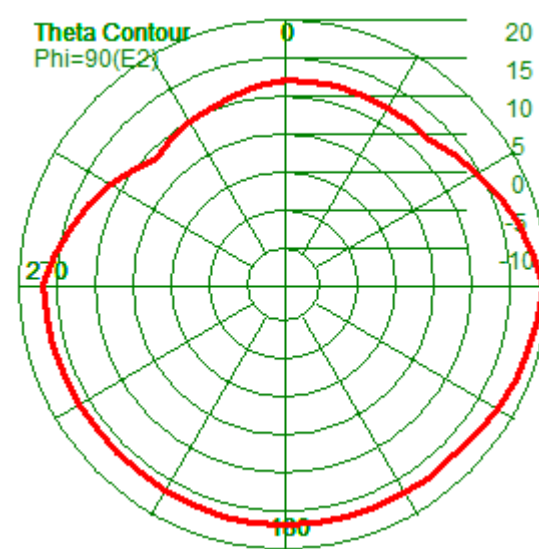

LTE B71 68836 TRP E2

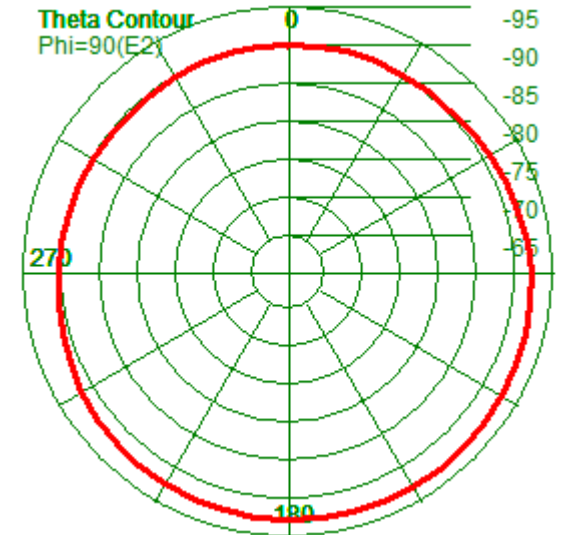

LTE B41 40340 TRP E2

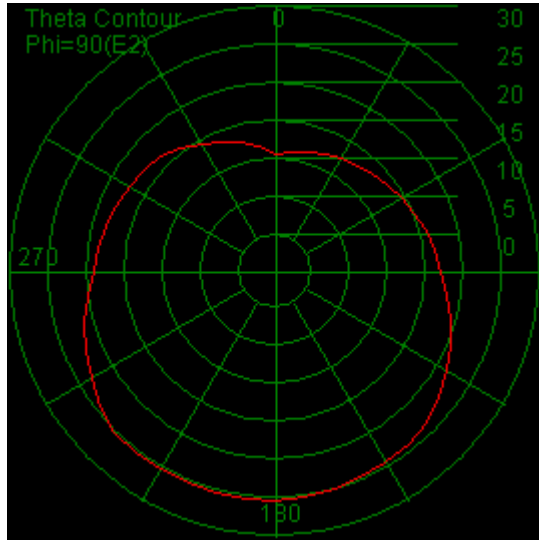

LTE B41 40620 TRP E2

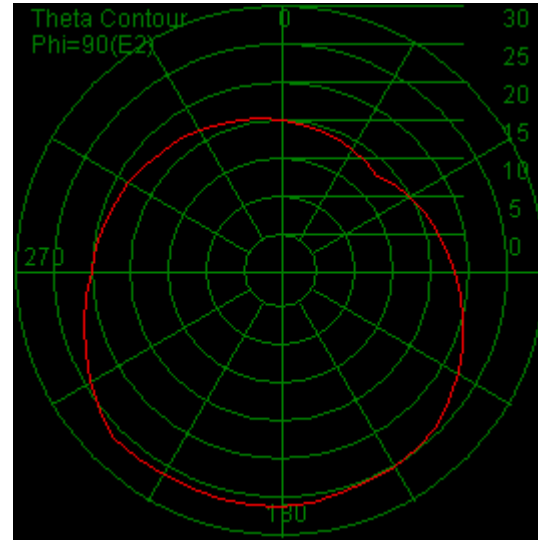

LTE B41 41140 TRP E2

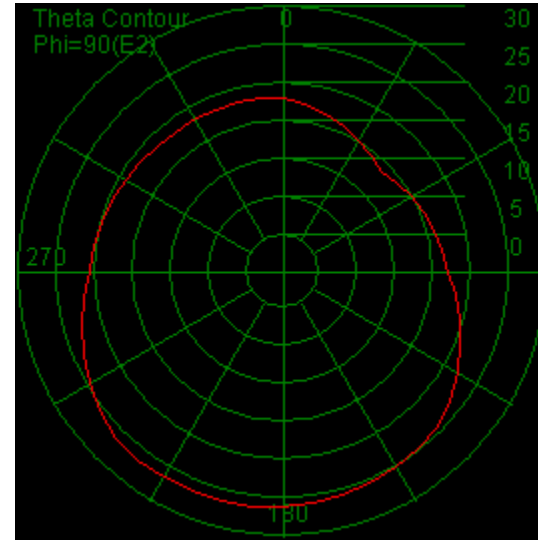

LTE B41 41140 TIS E2

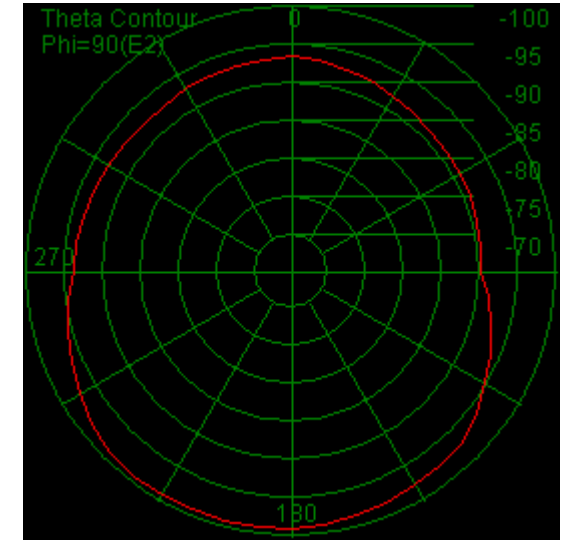

6.1 3D方向图

GSM850 128 TRP E2

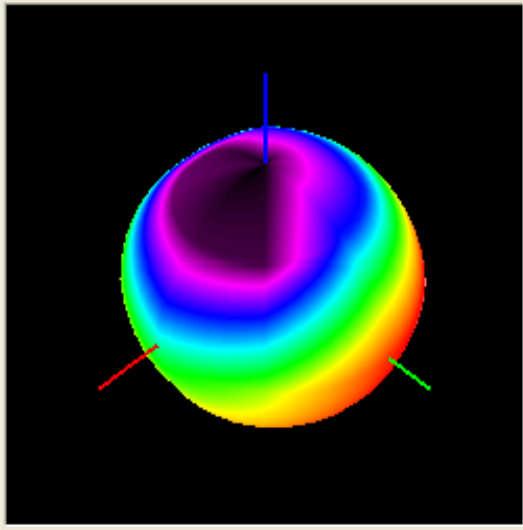

GSM850 192 TRP E2

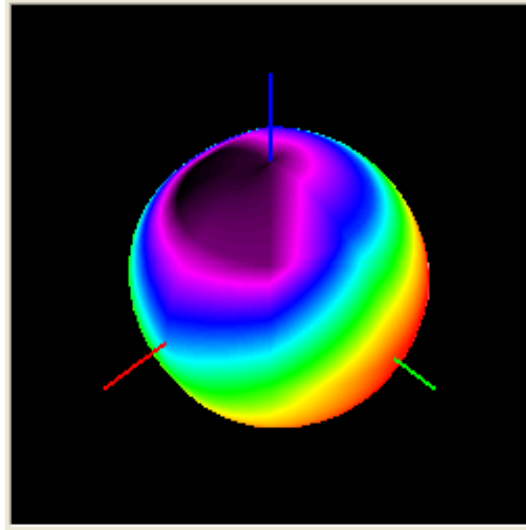

GSM850 251 TRP E2

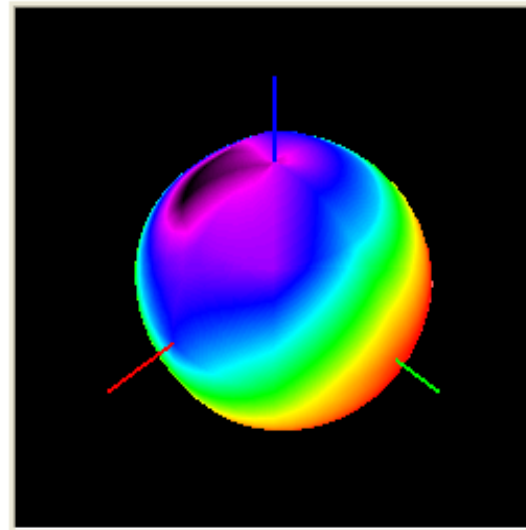

GSM850 251 TIS E2

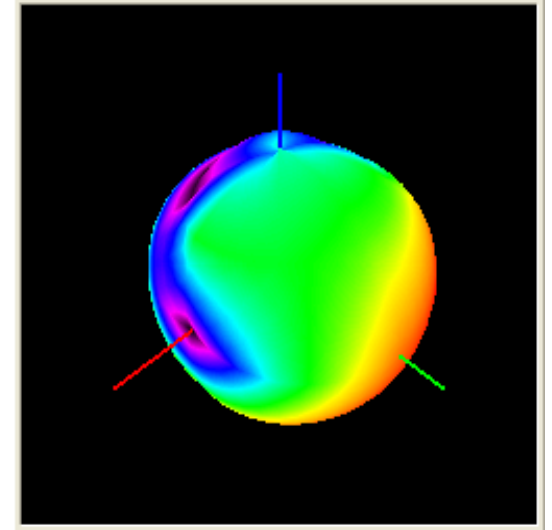

EGSM 1 TRP E2

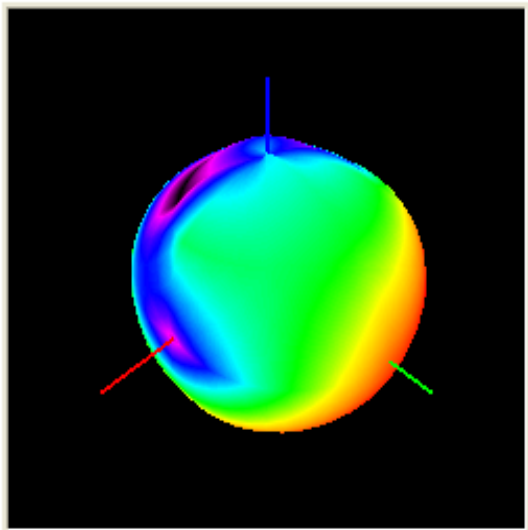

EGSM 62 TRP E2

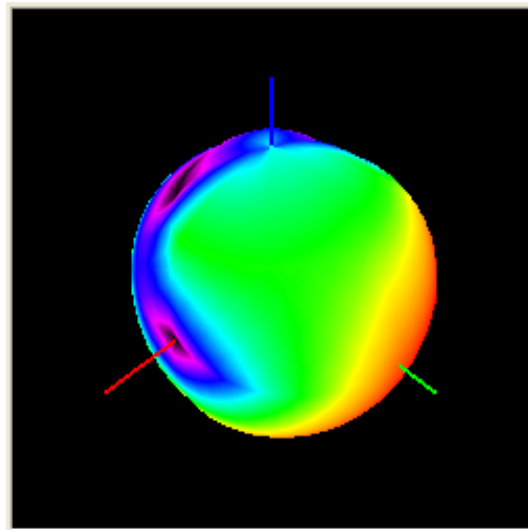

EGSM 124 TRP E2

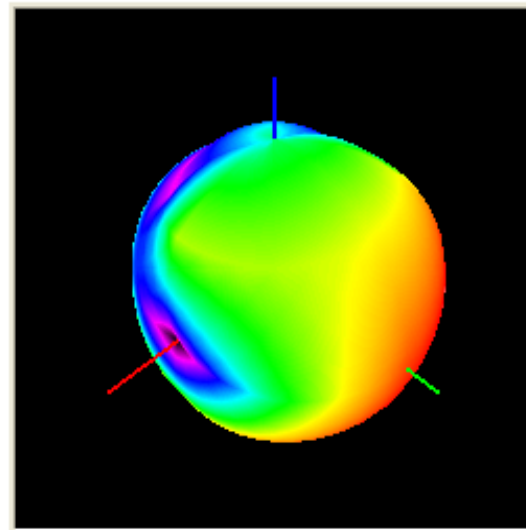

EGSM 124 TIS E2

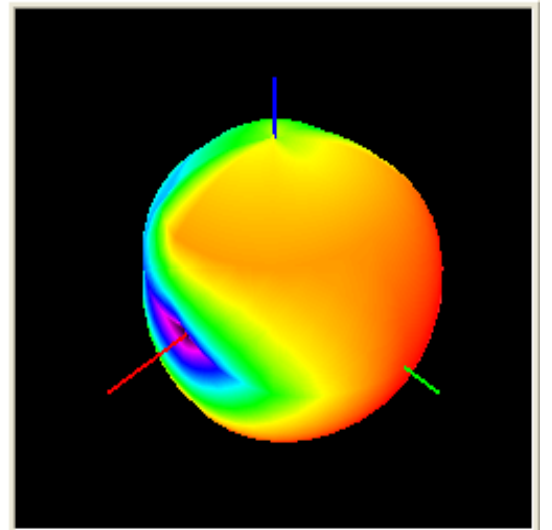

DCS 512 TRP E2

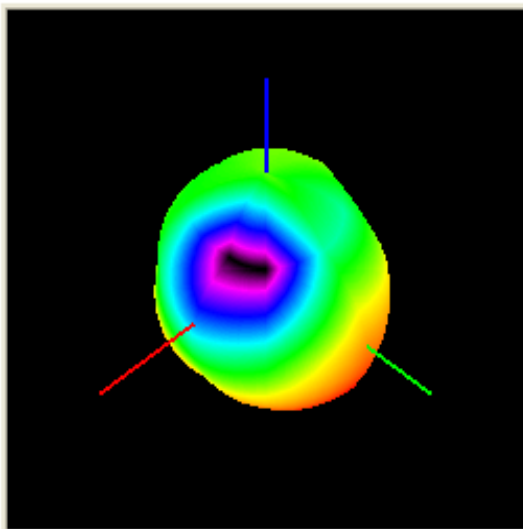

DCS 698 TRP E2

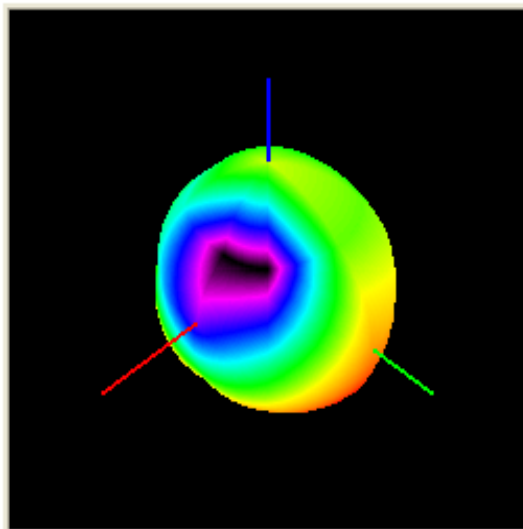

DCS 885 TRP E2

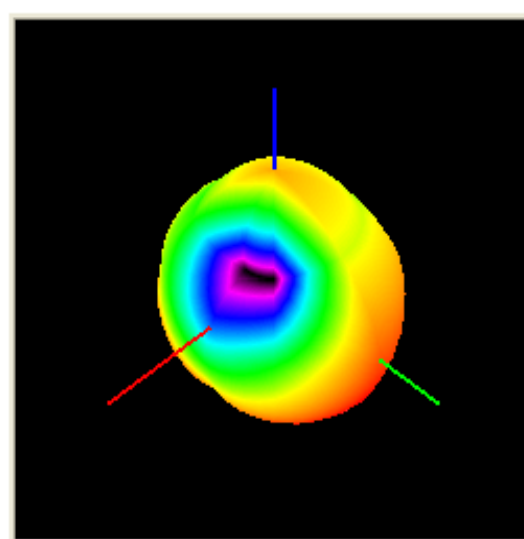

DCS 885 TIS E2

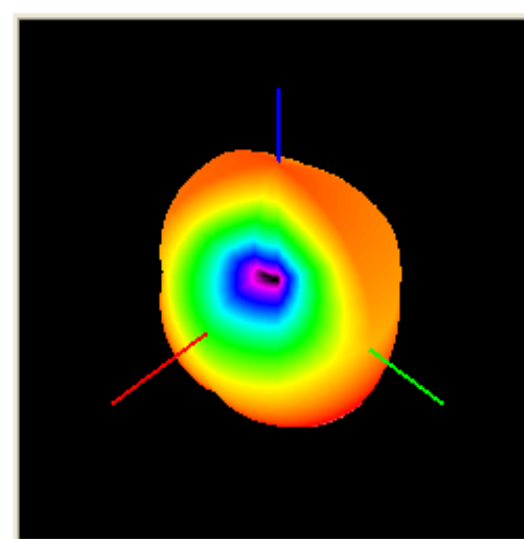

PCS 512 TRP E2

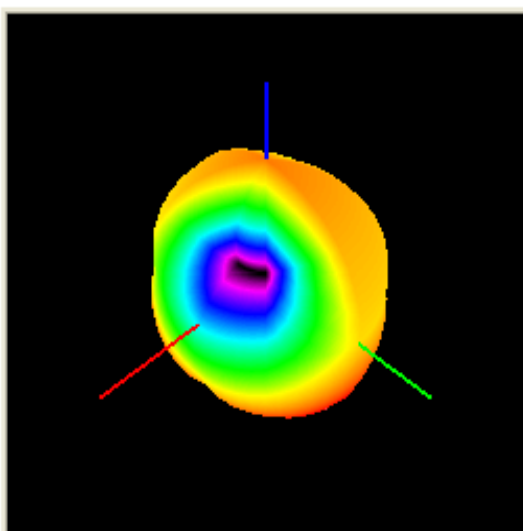

PCS 661 TRP E2

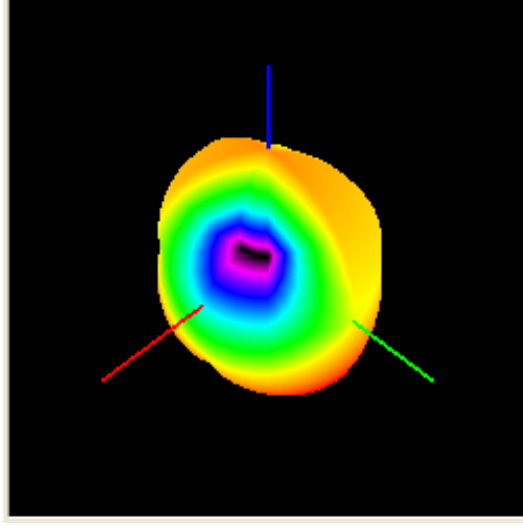

PCS 810 TRP E2

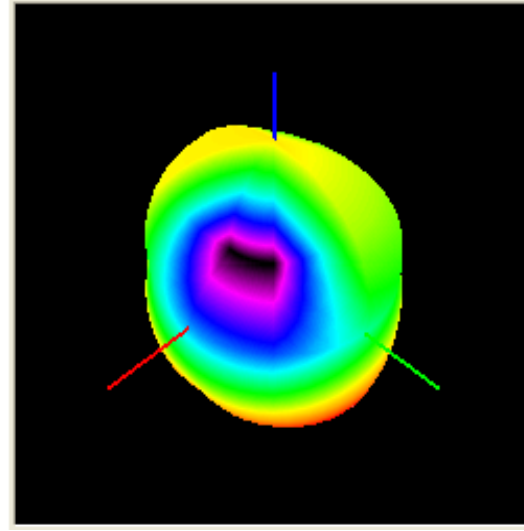

PCS 810 TIS E2

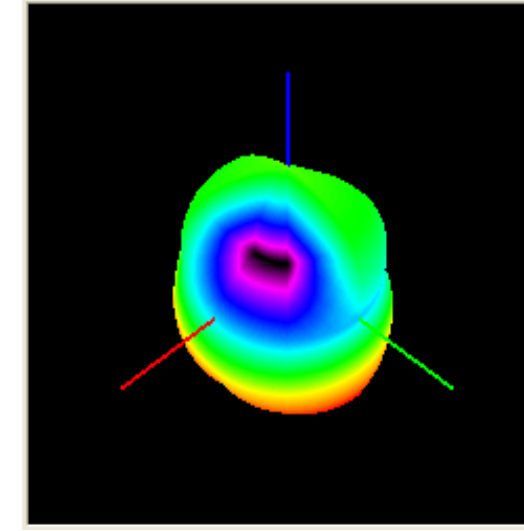

WCDMA B2 9262 TRP E2

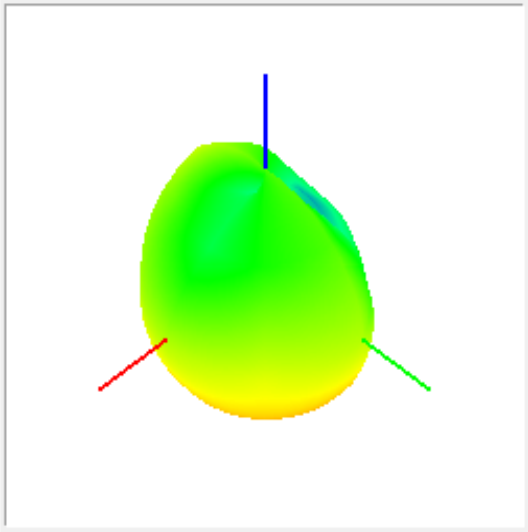

WCDMA B2 9400 TRP E2

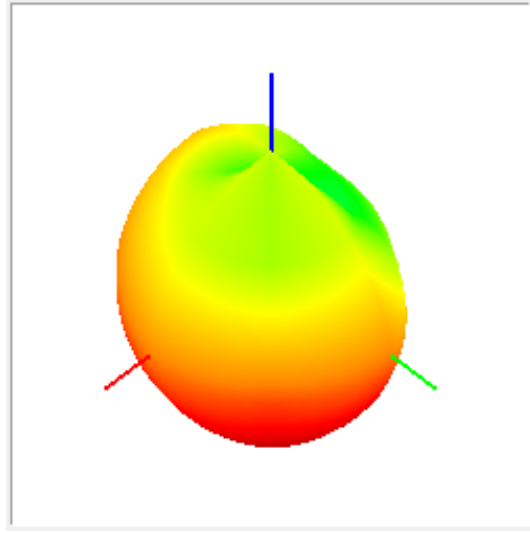

WCDMA B2 9538 TRP E2

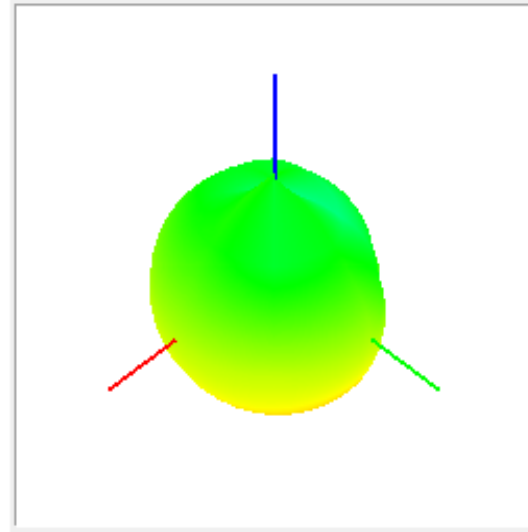

WCDMA B2 9938 TIS E2

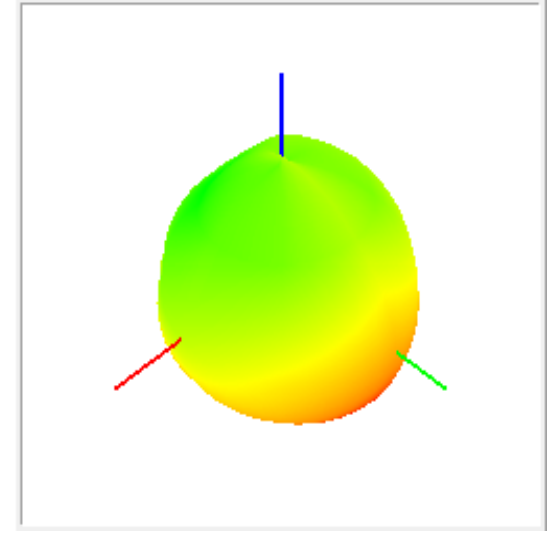

WCDMA B4 1312 TRP E2

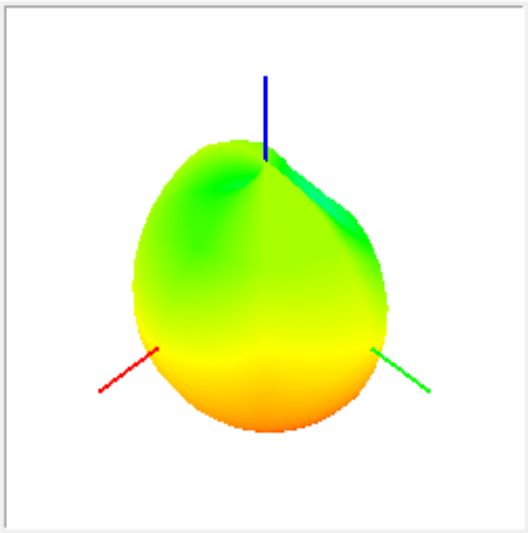

WCDMA B4 1413 TRP E2

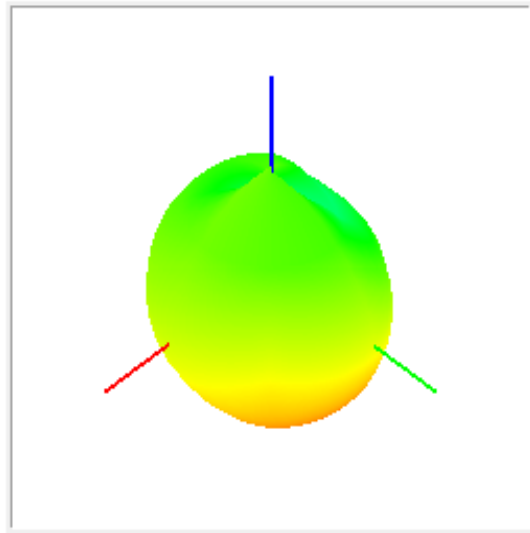

WCDMA B4 1513 TRP E2

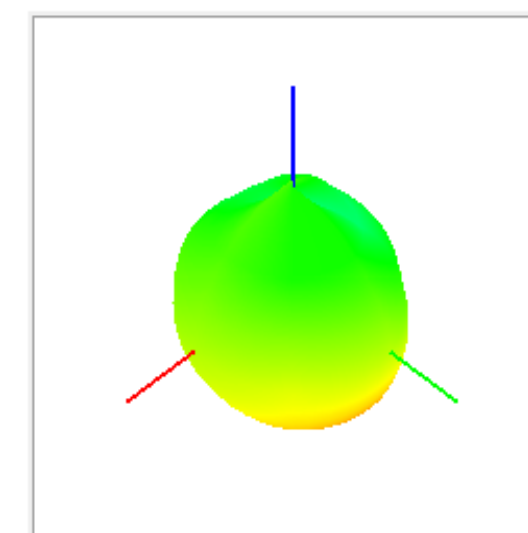

WCDMA B4 1738 TIS E2

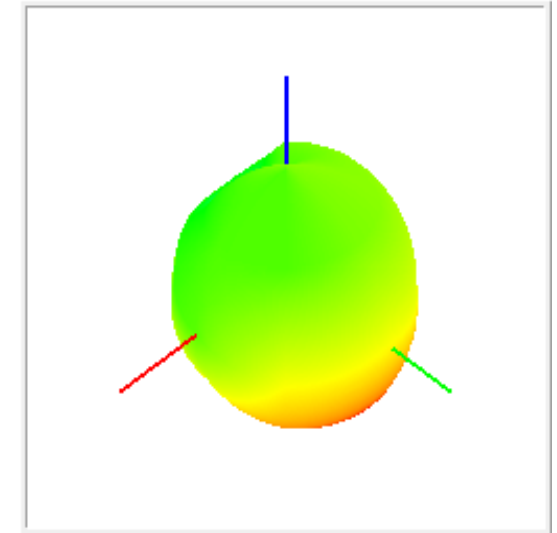

WCDMA B5 4132 TRP E2

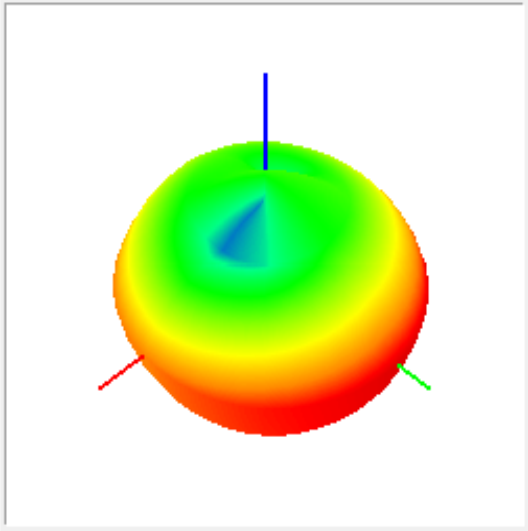

WCDMA B5 4183 TRP E2

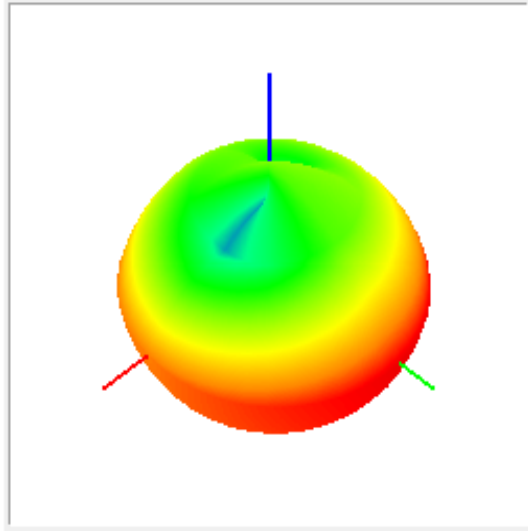

WCDMA B5 4233 TRP E2

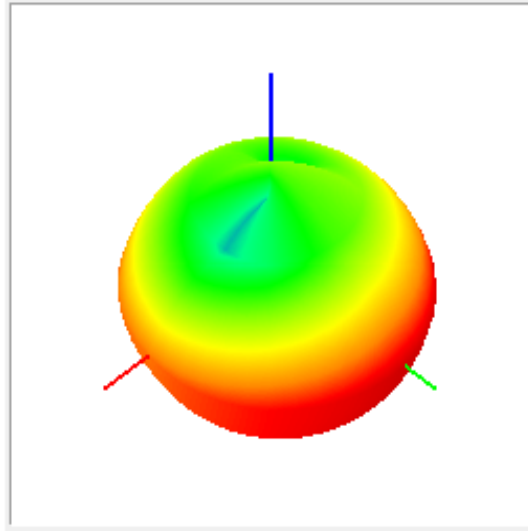

WCDMA B5 4458 TIS E2

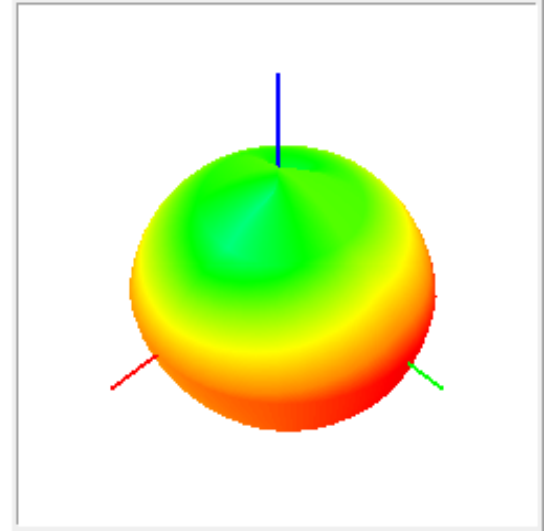

LTE B2 18650 TRP E2

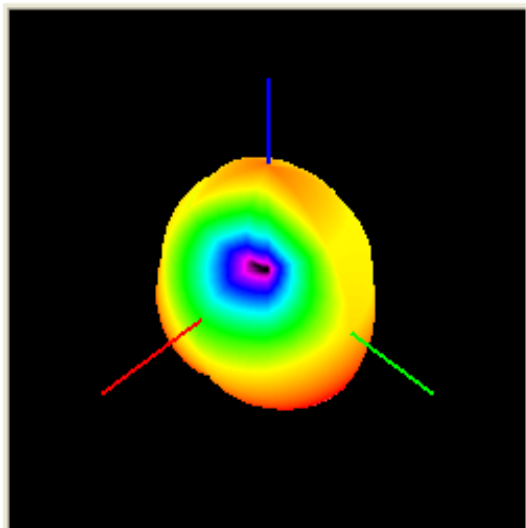

LTE B2 18900 TRP E2

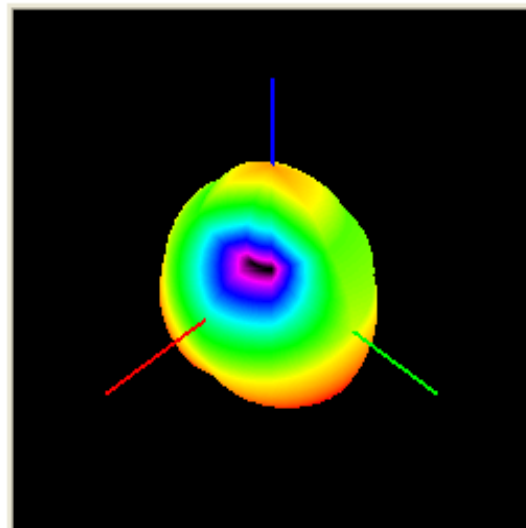

LTE B2 19150 TRP E2

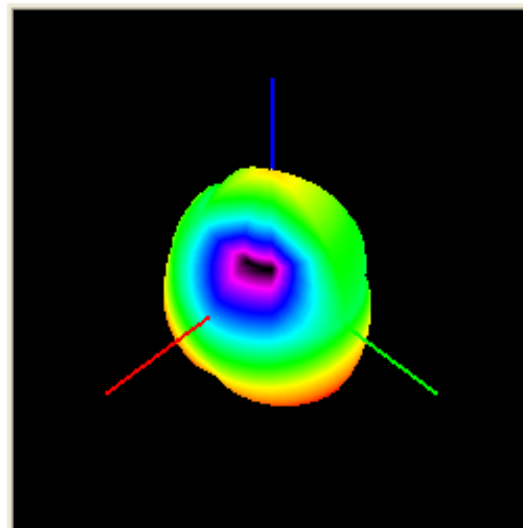

LTE B2 1150 TIS E2

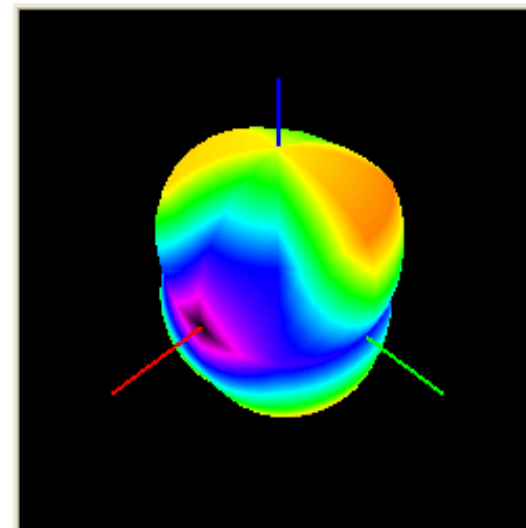

LTE B4 20000 TRP E2

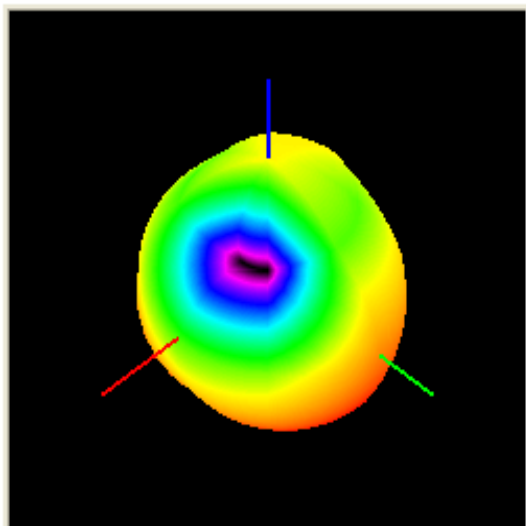

LTE B4 20175 TRP E2

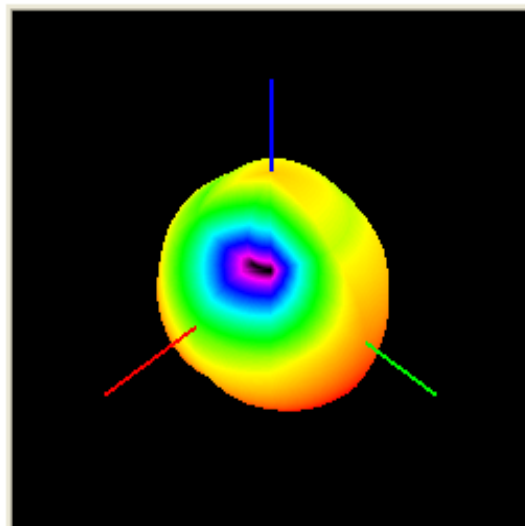

LTE B4 20350 TRP E2

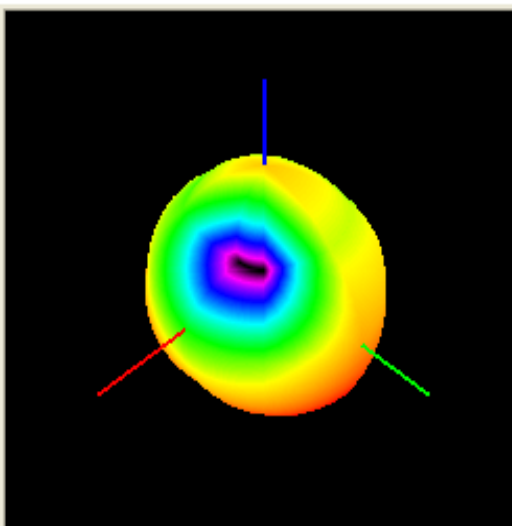

LTE B4 2350 TIS E2

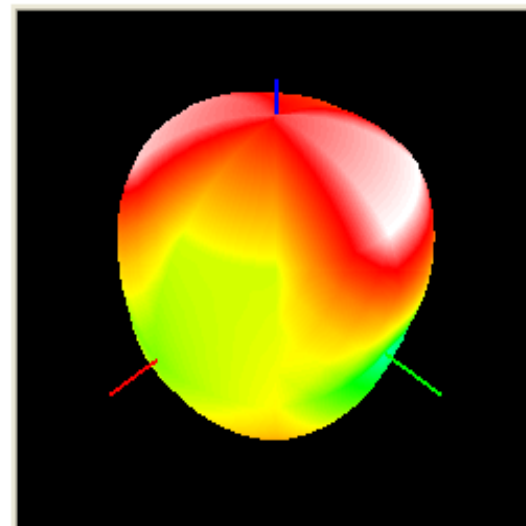

LTE B5 20450 TRP E2

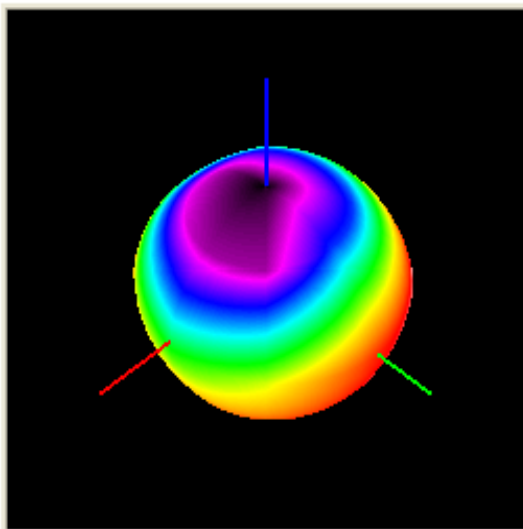

LTE B5 20525 TRP E2

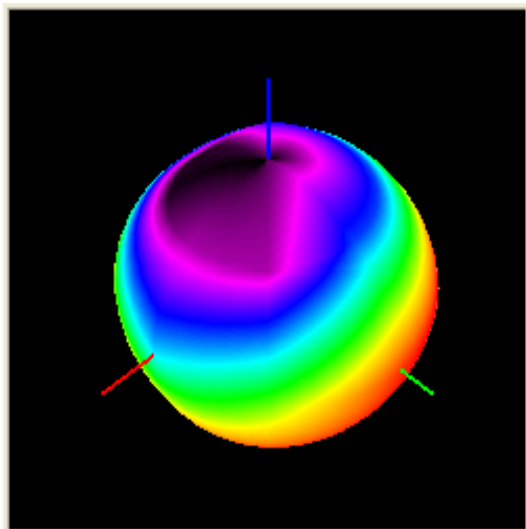

LTE B5 20600 TRP E2

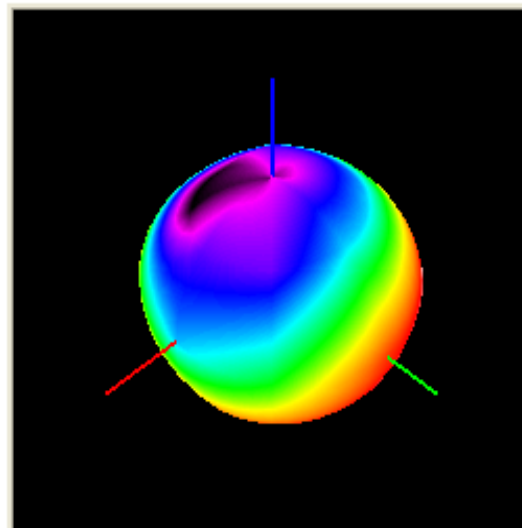

LTE B5 2600 TIS E2

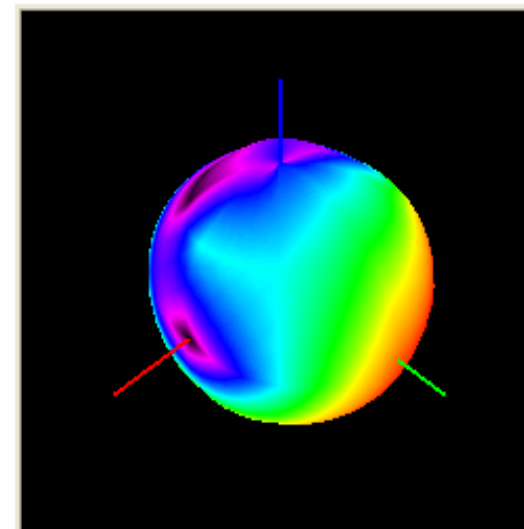

LTE B12 23035 TRP E2

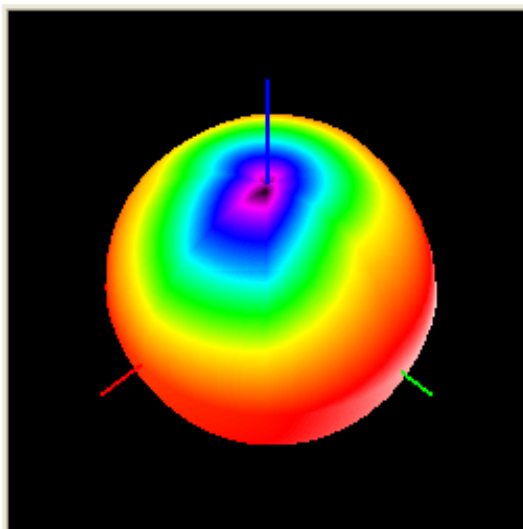

LTE B12 23095 TRP E2

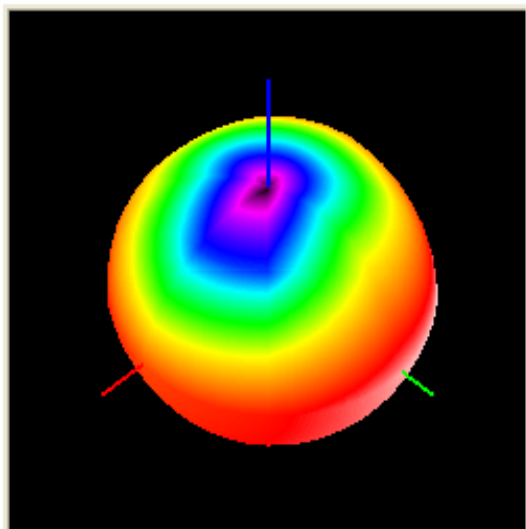

LTE B12 23155 TRP E2

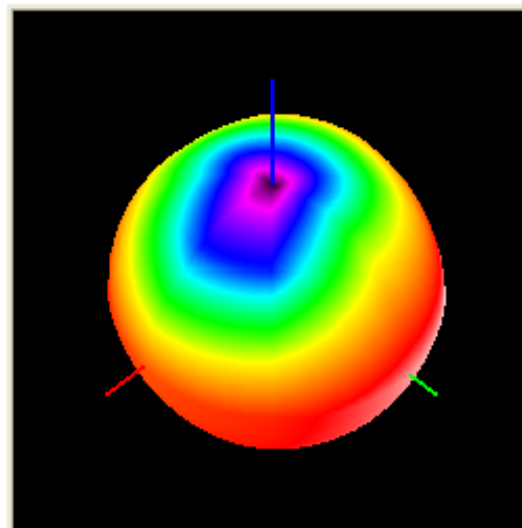

LTE B12 5155 TRP E2

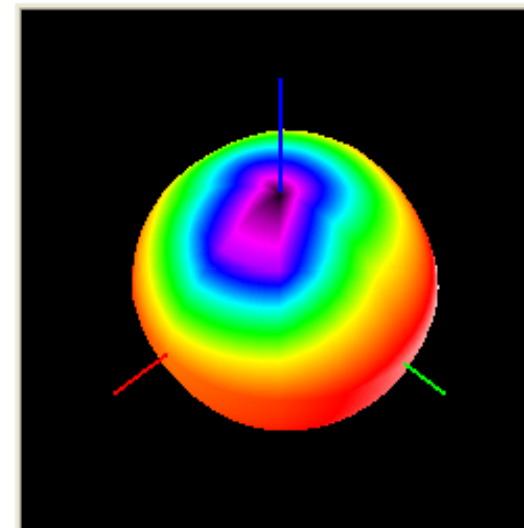

LTE B13 23230 TRP E2

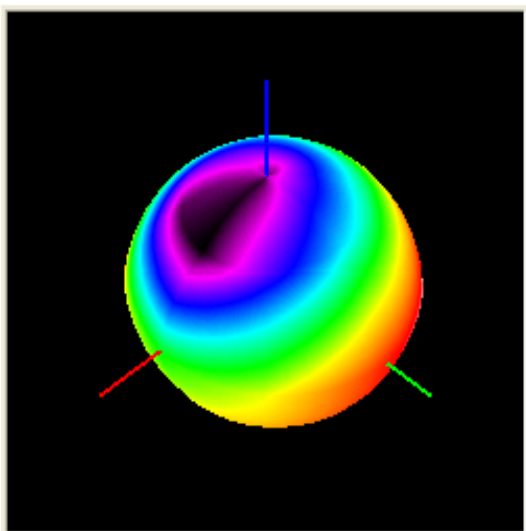

LTE B13 23230 TRP E2

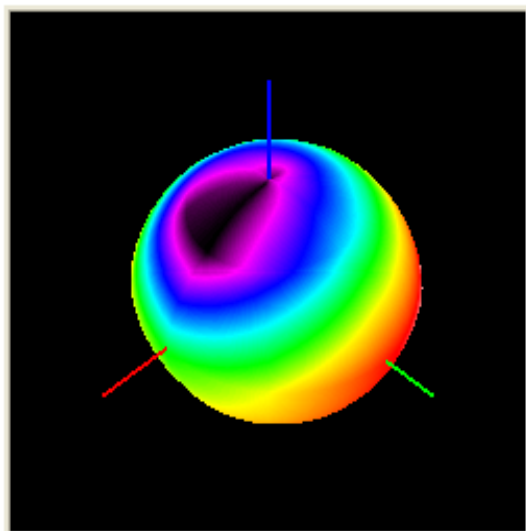

LTE B13 23230 TRP E2

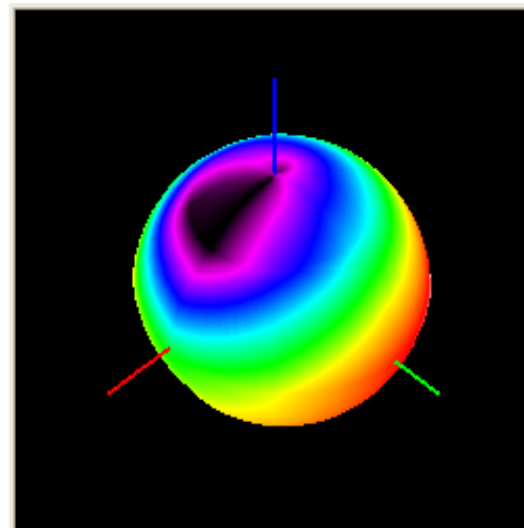

LTE B13 5230 TIS E2

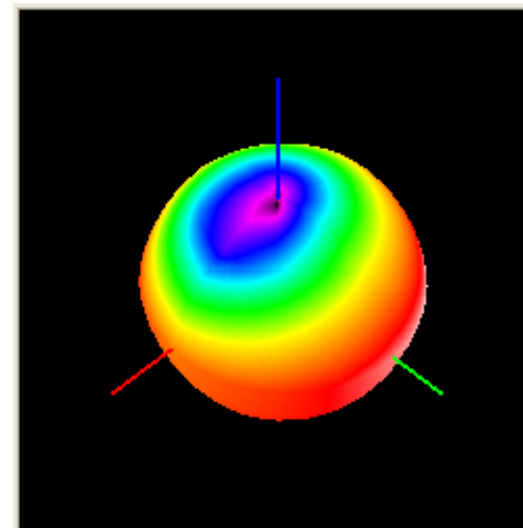

LTE B17 23780 TRP E2

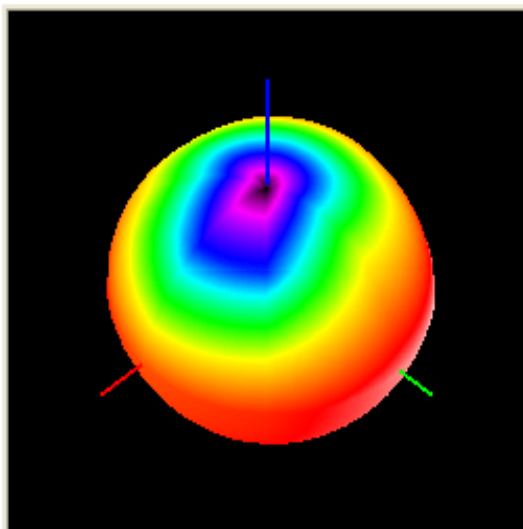

LTE B17 23790 TRP E2

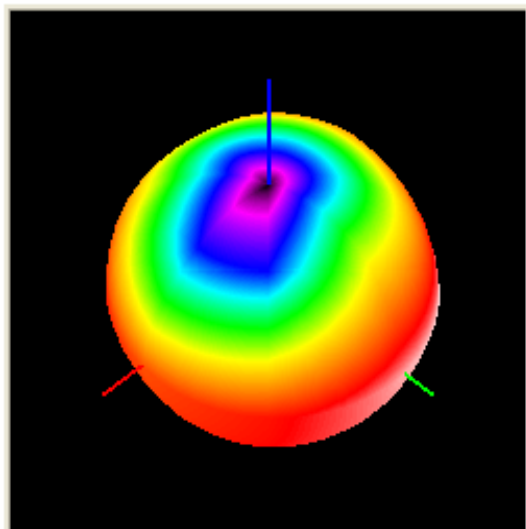

LTE B17 23800 TRP E2

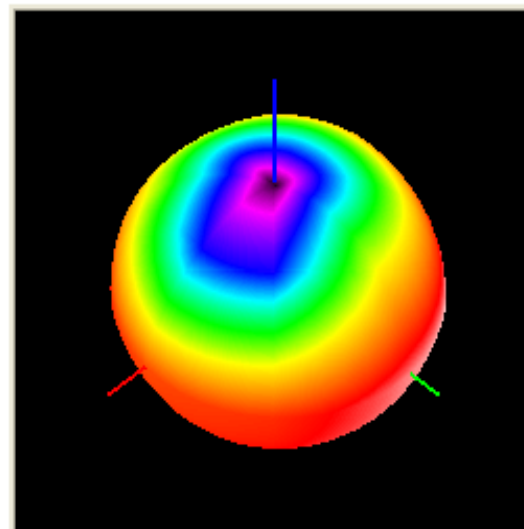

LTE B17 5800 TRP E2

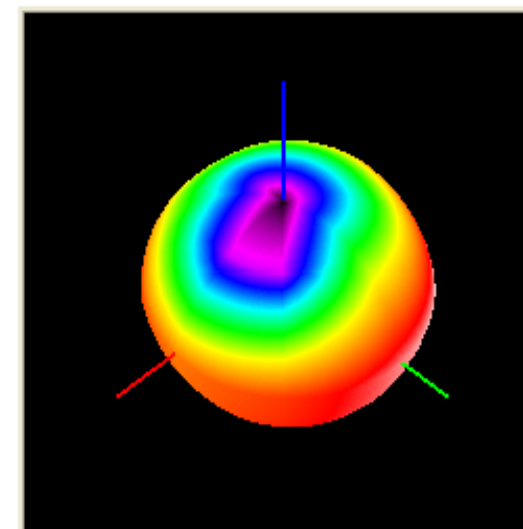

LTE B25 5800 TRP E2

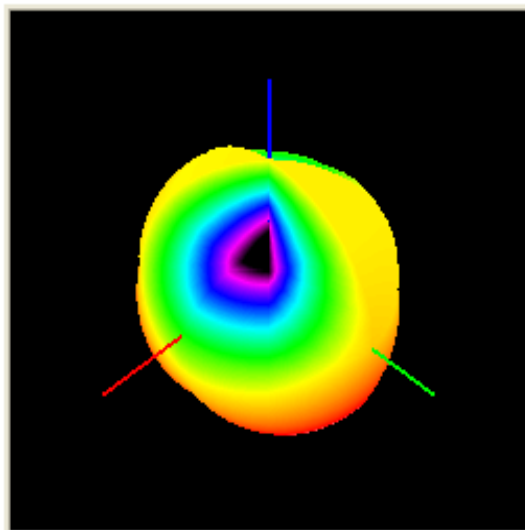

LTE B25 26365 TRP E2

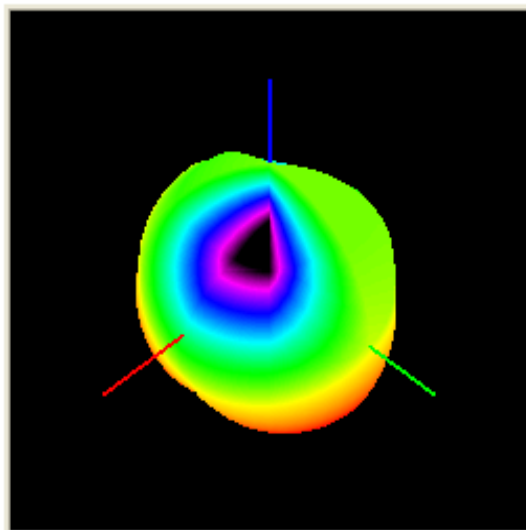

LTE B25 26665 TRP E2

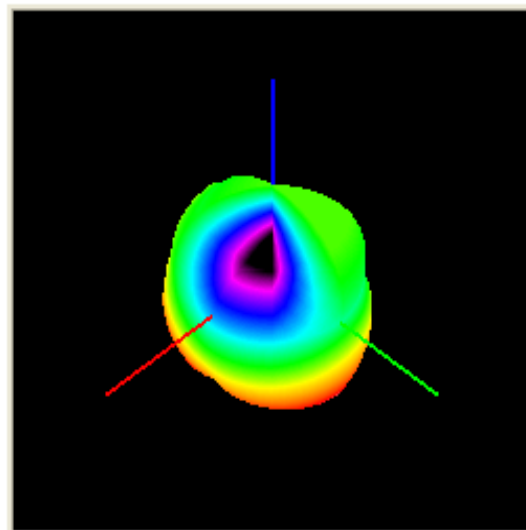

LTE B25 8665 TIS E2

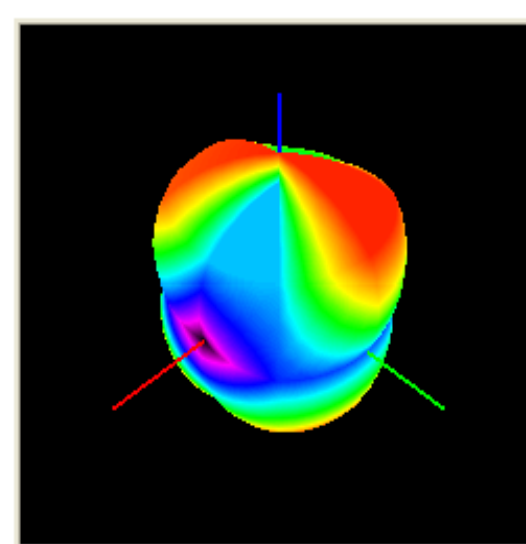

LTE B26 26715 TRP E2

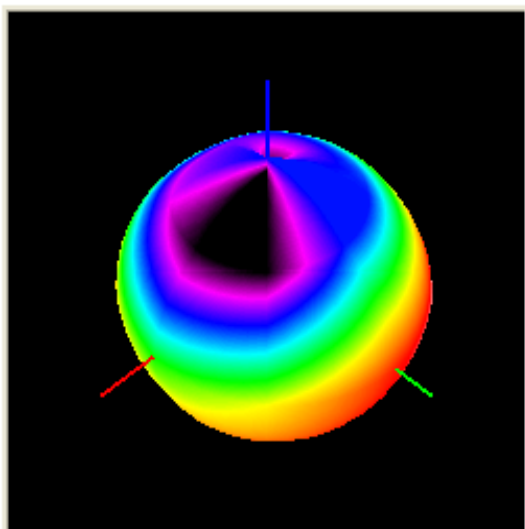

LTE B26 26865 TRP E2

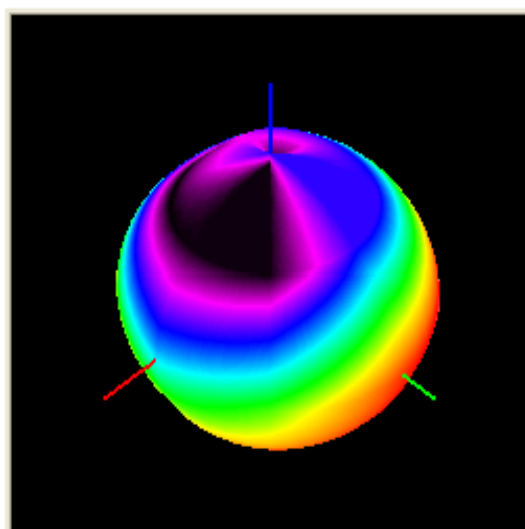

LTE B26 27015 TRP E2

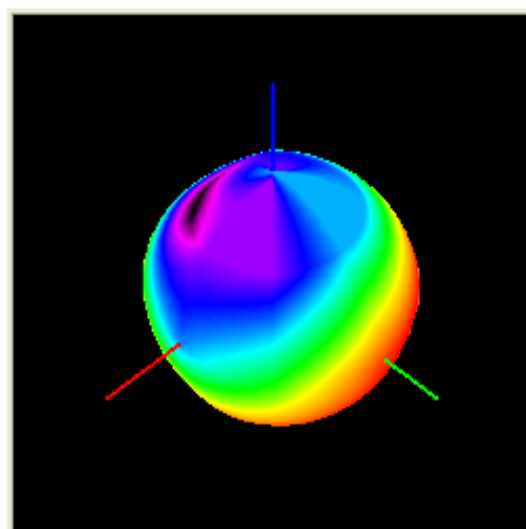

LTE B26 9015 TRP E2

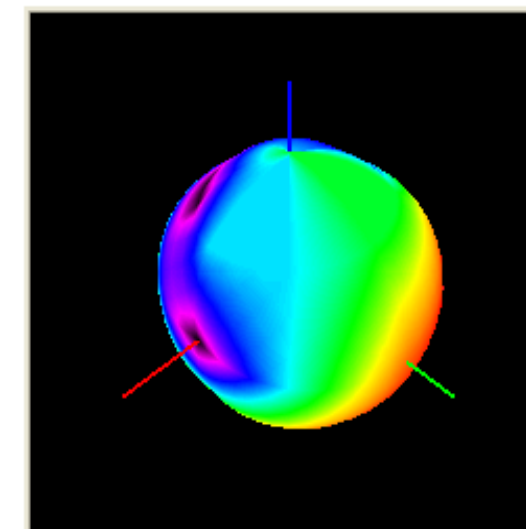

LTE B66 132022 TRP E2

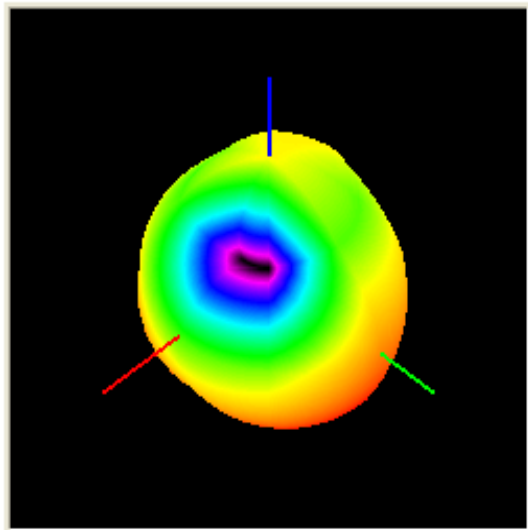

LTE B66 132322 TRP E2

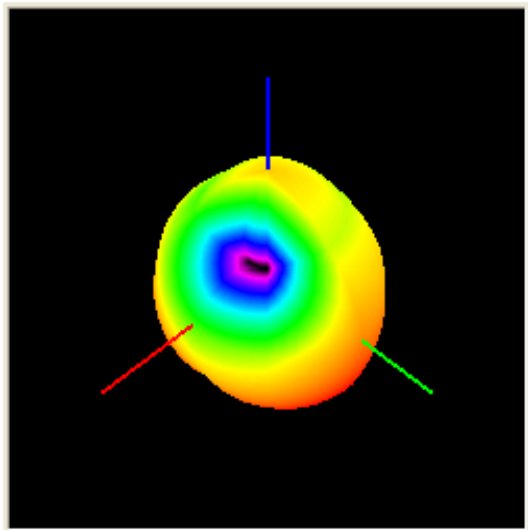

LTE B66 132622 TRP E2

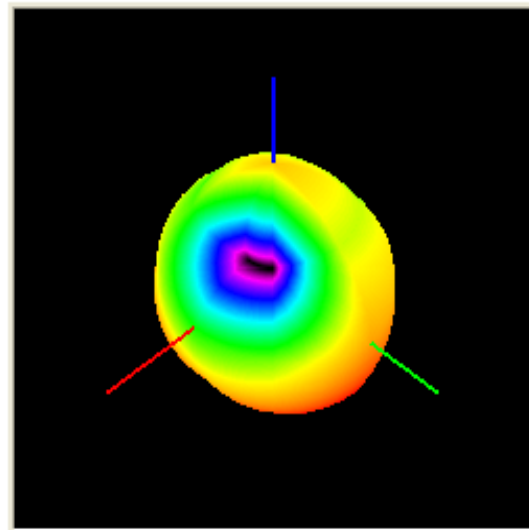

LTE B66 67086 TIS E2

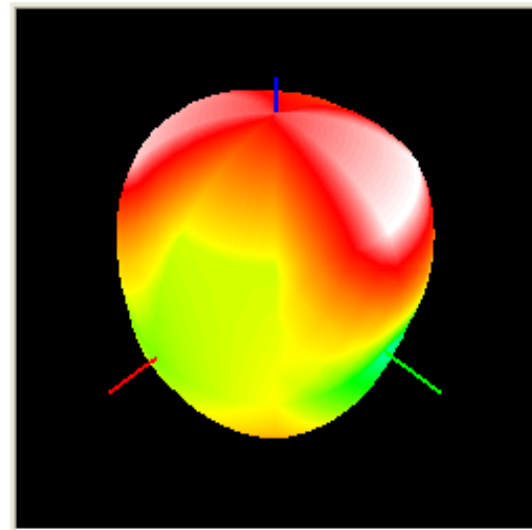

LTE B71 133172 TRP E2

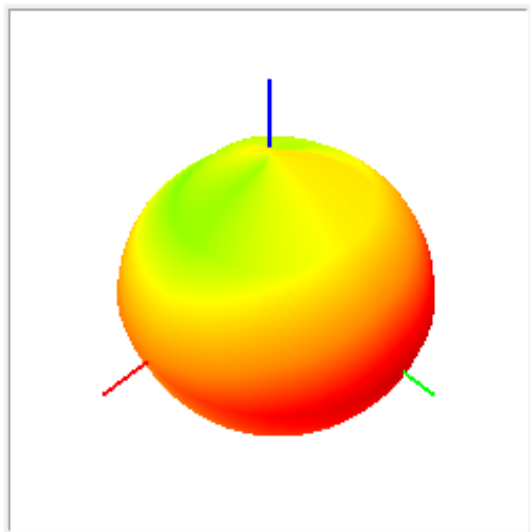

LTE B71 133297 TRP E2

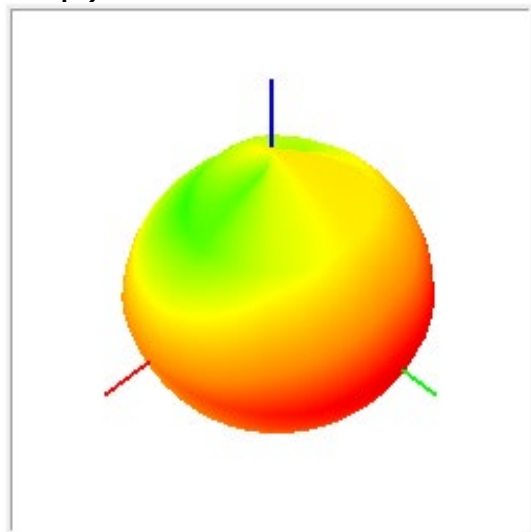

LTE B71 133422 TRP E2

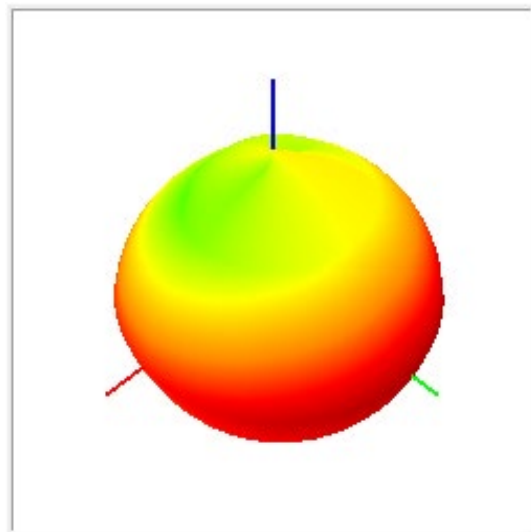

LTE B71 68836 TRP E2

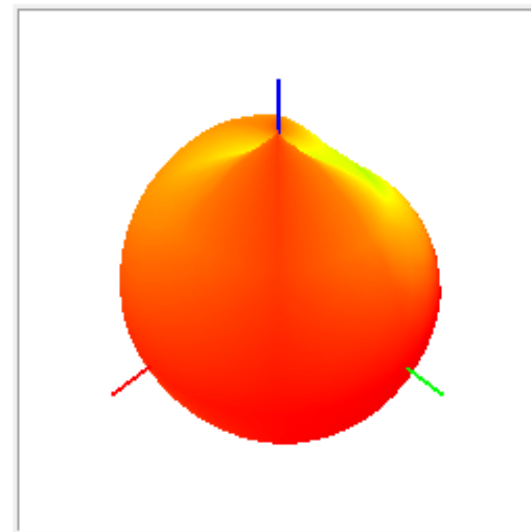

LTE B41 40340 TRP E2

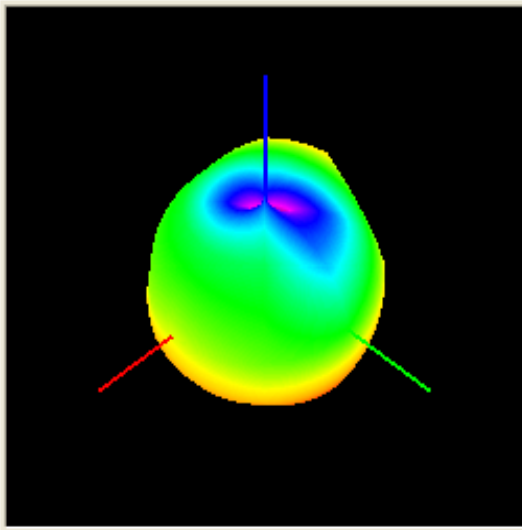

LTE B41 40620 TRP E2

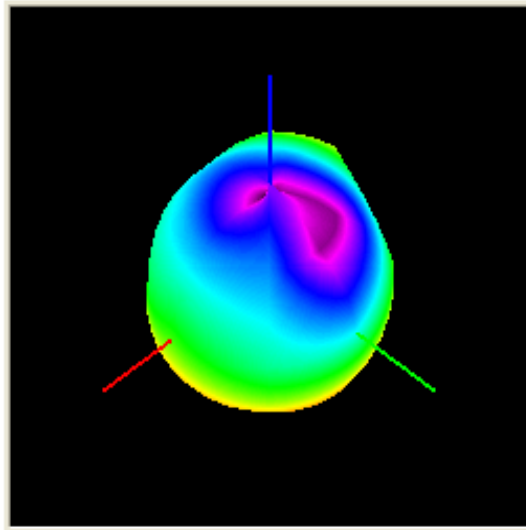

LTE B41 41140 TRP E2

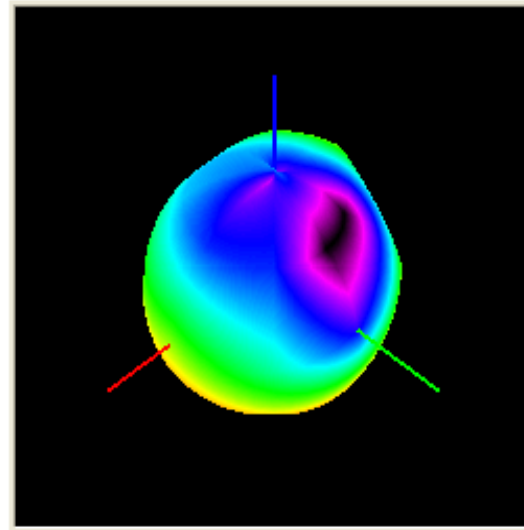

LTE B41 41140 TIS E2

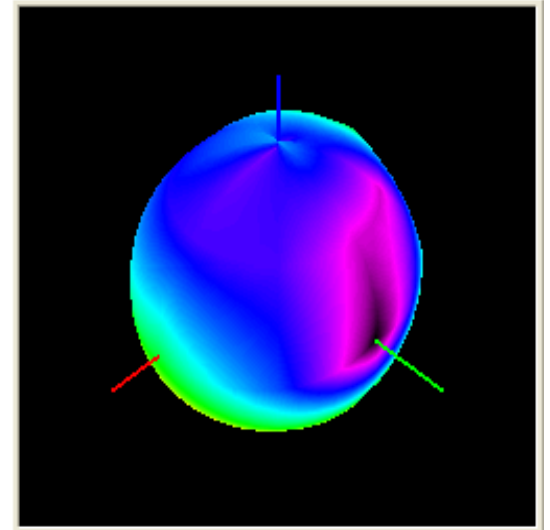

7.1 主天线增益

2G	850	900	1800	1900	
AVG Gain(dbi)	-1.56	-1.32	-0.85	-1.2	
3G	B2	B4	B5		
AVG Gain(dbi)	-1.2	-0.85	-1.56		
4G	B2	B4	B5	B12	B13
AVG Gain(dbi)	-1.2	-0.85	-1.56	-1.85	-1.78
	B25	B26	B66	B71	B41
	-1.56	-1.56	-0.85	-2.15	0.62

7.2 2.4G WIFI/BT天线增益

FEITUKEJI											
Frequency ID	1	2	3	4	5	6	7	8	9	10	11
Frequency (MHz)	2400.0	2410.0	2420.0	2430.0	2440.0	2450.0	2460.0	2470.0	2480.0	2490.0	2500.0
Point Values											
Ant. Port Input Pwr. (dBm)	0.00	0.00	0.00	0.00	0.00	0.00	0.00	0.00	0.00	0.00	0.00
Tot. Rad. Pwr. (dBm)	-6.92	-6.66	-6.70	-6.36	-6.14	-5.94	-5.88	-5.93	-5.94	-6.24	-6.32
Peak EIRP (dBm)	0.21	0.50	0.40	0.78	1.07	1.45	1.67	1.79	1.82	1.61	1.51
Directivity (dBi)	7.14	7.16	7.10	7.14	7.22	7.39	7.55	7.73	7.76	7.85	7.83
Efficiency (dB)	-6.92	-6.66	-6.70	-6.36	-6.14	-5.94	-5.88	-5.93	-5.94	-6.24	-6.32
Efficiency (%)	20.30	21.60	21.40	23.10	24.30	25.50	25.80	25.50	25.50	23.80	23.30
Gain (dBi)	0.21	0.50	0.40	0.78	1.07	1.45	1.67	1.79	1.82	1.61	1.51
NHPRP $\pm\pi/4$ (dBm)	-9.25	-8.98	-9.11	-8.78	-8.55	-8.21	-8.09	-8.12	-8.22	-8.58	-8.83
NHPRP $\pm\pi/6$ (dBm)	-11.07	-10.82	-10.97	-10.66	-10.46	-10.15	-10.06	-10.12	-10.25	-10.64	-10.93
NHPRP $\pm\pi/8$ (dBm)	-12.02	-11.77	-11.94	-11.65	-11.47	-11.18	-11.11	-11.20	-11.38	-11.82	-12.17
Upper Hem. PRP (dBm)	-11.98	-11.74	-11.80	-11.47	-11.25	-11.06	-11.06	-11.18	-11.23	-11.58	-11.68
Lower Hem. PRP (dBm)	-8.55	-8.27	-8.30	-7.96	-7.75	-7.53	-7.45	-7.47	-7.46	-7.75	-7.82
Upper Hem. PRP (%)	6.33	6.69	6.60	7.13	7.50	7.83	7.84	7.62	7.53	6.95	6.79
Lower Hem. PRP (%)	13.98	14.90	14.79	15.98	16.80	17.66	17.97	17.89	17.94	16.81	16.54

7.2 5G WIFI天线增益

FEITUKEJI															
Frequency ID	1	2	3	4	5	6	7	8	9	10	11	12	13	14	15
Frequency (MHz)	5150.0	5200.0	5250.0	5300.0	5350.0	5400.0	5450.0	5500.0	5550.0	5600.0	5650.0	5700.0	5750.0	5800.0	5850.0
Point Values															
Ant. Port Input Pwr. (dBm)	0.00	0.00	0.00	0.00	0.00	0.00	0.00	0.00	0.00	0.00	0.00	0.00	0.00	0.00	0.00
Tot. Rad. Pwr. (dBm)	-6.09	-6.59	-6.83	-6.17	-6.82	-6.29	-6.38	-6.16	-5.87	-7.20	-7.15	-7.35	-7.43	-6.61	-6.99
Peak EIRP (dBm)	-1.82	-1.82	-1.73	-0.74	-1.07	-0.49	-0.65	-0.50	0.04	-1.31	-1.48	-1.93	-2.00	-1.14	-1.51
Directivity (dBi)	4.27	4.77	5.10	5.44	5.75	5.81	5.73	5.66	5.91	5.90	5.67	5.43	5.42	5.46	5.48
Efficiency (dB)	-6.09	-6.59	-6.83	-6.17	-6.82	-6.29	-6.38	-6.16	-5.87	-7.20	-7.15	-7.35	-7.43	-6.61	-6.99
Efficiency (%)	24.60	21.90	20.80	24.10	20.80	23.50	23.00	24.20	25.90	19.00	19.30	18.40	18.10	21.80	20.00
Gain (dBi)	-1.82	-1.82	-1.73	-0.74	-1.07	-0.49	-0.65	-0.50	0.04	-1.31	-1.48	-1.93	-2.00	-1.14	-1.51
NHPRP $\pm\pi/4$ (dBm)	-8.02	-8.53	-8.53	-7.89	-8.61	-8.19	-8.26	-8.07	-7.71	-9.11	-9.37	-9.87	-10.08	-9.33	-9.71
NHPRP $\pm\pi/6$ (dBm)	-9.58	-10.09	-10.09	-9.45	-10.18	-9.76	-9.84	-9.66	-9.34	-10.79	-11.06	-11.58	-11.83	-11.13	-11.56
NHPRP $\pm\pi/8$ (dBm)	-10.74	-11.24	-11.19	-10.53	-11.26	-10.84	-10.95	-10.76	-10.45	-11.92	-12.19	-12.70	-12.96	-12.29	-12.74
Upper Hem. PRP (dBm)	-7.90	-8.27	-8.49	-7.78	-8.31	-7.71	-7.76	-7.53	-7.20	-8.50	-8.44	-8.66	-8.72	-7.88	-8.27
Lower Hem. PRP (dBm)	-10.77	-11.52	-11.80	-11.28	-12.18	-11.84	-12.03	-11.83	-11.66	-13.09	-13.06	-13.22	-13.32	-12.57	-12.92
Upper Hem. PRP (%)	16.20	14.90	14.16	16.68	14.74	16.93	16.75	17.66	19.04	14.13	14.31	13.63	13.42	16.31	14.88
Lower Hem. PRP (%)	8.38	7.05	6.60	7.45	6.05	6.55	6.27	6.56	6.83	4.91	4.94	4.76	4.66	5.54	5.11

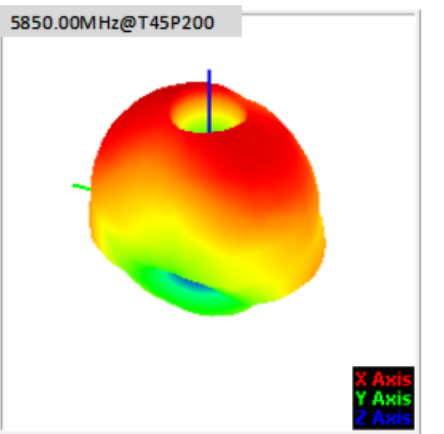
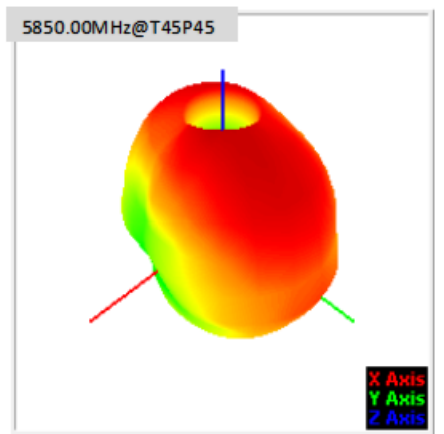
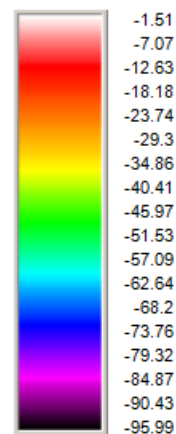
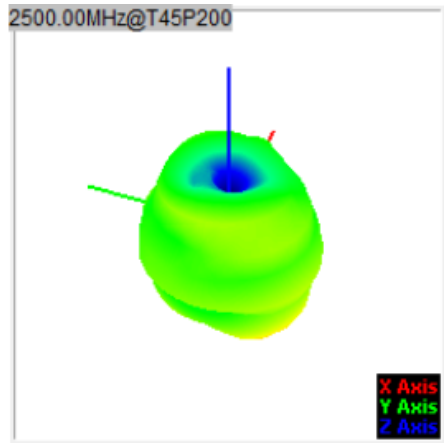
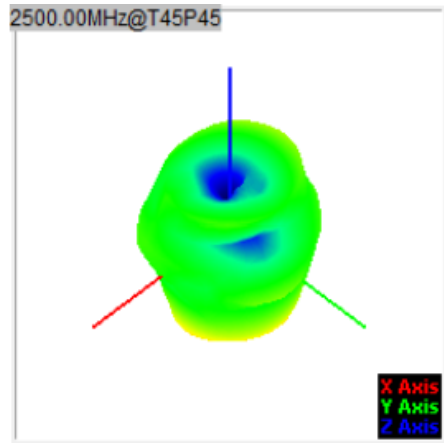
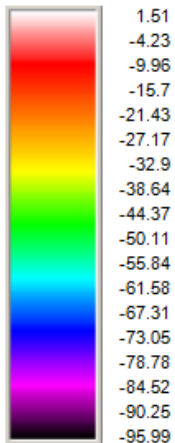
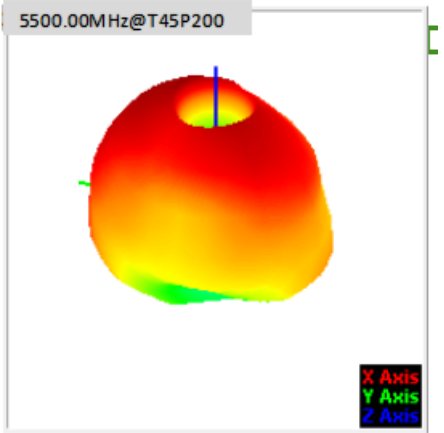
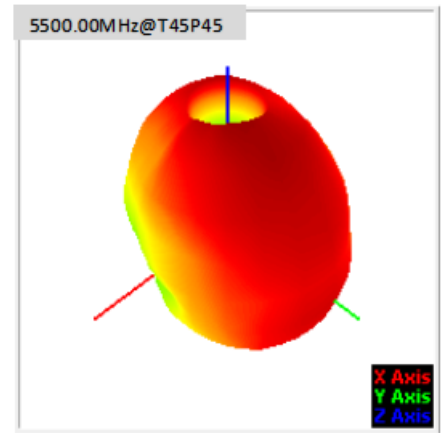
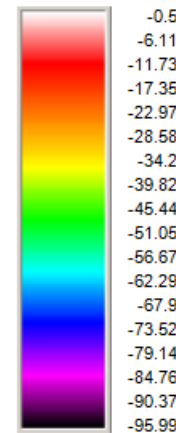
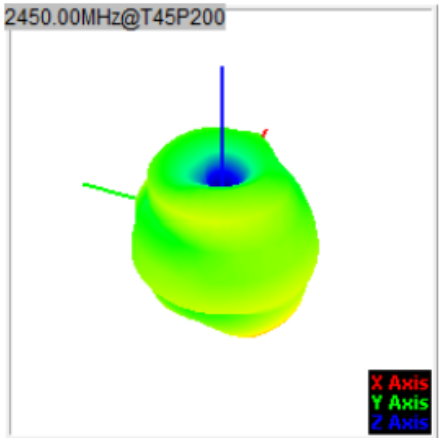
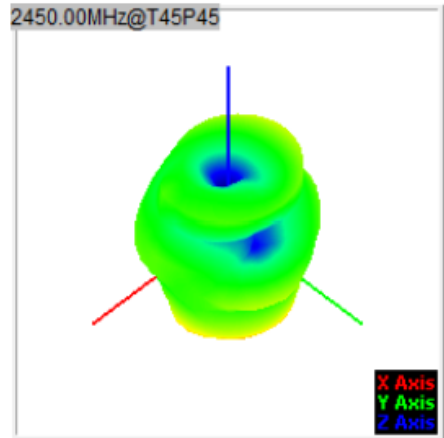
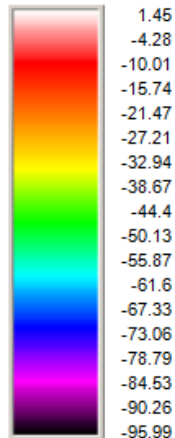
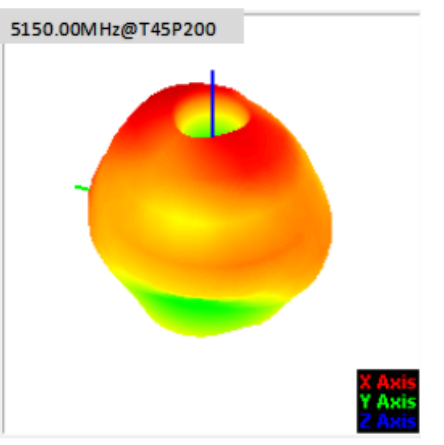
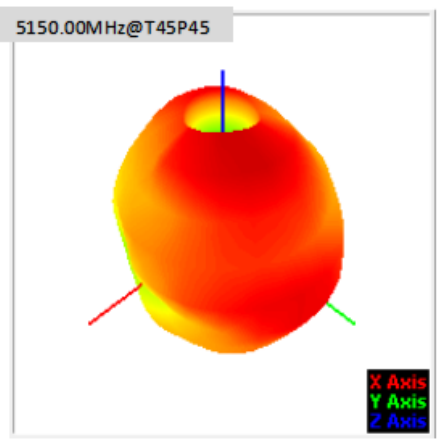
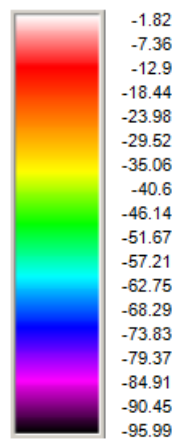
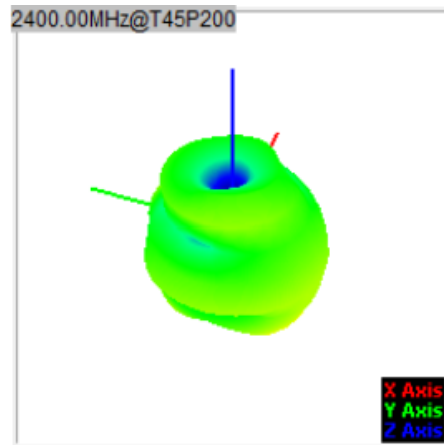
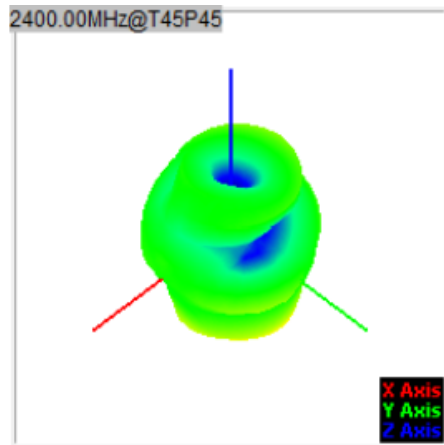
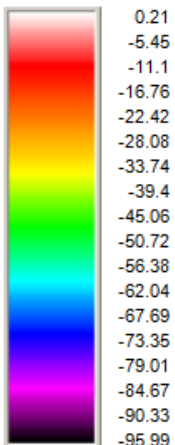

8.1 天线结构图

