



FCC TEST REPORT FOR

Xwireless LLC

Smartphone

Test Model: J24

Prepared for : Xwireless LLC
Address : 11565 Old Georgetown Road Rockville, MD 20852 USA

Prepared by : Shenzhen LCS Compliance Testing Laboratory Ltd.
Address : 101, 201 Bldg A & 301 Bldg C, Juji Industrial Park
Yabianxueziwei, Shajing Street, Baoan District, Shenzhen,
518000, China

Tel : (+86)755-82591330
Fax : (+86)755-82591332
Web : www.LCS-cert.com
Mail : webmaster@LCS-cert.com

Date of receipt of test sample : April 15, 2024
Number of tested samples : 2
Sample No. : A240417030-1, A240417030-2
Serial number : Prototype
Date of Test : April 15, 2024 ~ May 11, 2024
Date of Report : May 11, 2024





FCC PART 22/24/27 TEST REPORT
FCC Part 22H / Part 24E /Part 27

Report Reference No.: LCSEA04014383EF
FCC ID.: 2ADLJ-J24
Date of Issue.: May 11, 2024

Testing Laboratory Name.: Shenzhen LCS Compliance Testing Laboratory Ltd.
Address.: 101, 201 Bldg A & 301 Bldg C, Juji Industrial Park Yabianxueziwei, Shajing Street, Baoan District, Shenzhen, 518000, China

Applicant's name.: Xwireless LLC
Address.: 11565 Old Georgetown Road Rockville, MD 20852 USA

Test specification.:
Standard.: FCC Part 22H: Cellular Radiotelephone Service
FCC Part 24E: Broadband PCS
FCC Part 27: MISCELLANEOUS WIRELESS COMMUNICATIONS SERVICES
Test Report Form No.: LCSEMC-1.0
TRF Originator.: Shenzhen LCS Compliance Testing Laboratory Ltd.
Master TRF.: Dated 2011-03

Shenzhen LCS Compliance Testing Laboratory Ltd. All rights reserved.
This publication may be reproduced in whole or in part for non-commercial purposes as long as the Shenzhen LCS Compliance Testing Laboratory Ltd. is acknowledged as copyright owner and source of the material.

Test item description.: Smartphone
Trade Mark.: Vortex
Test Model.: J24
Ratings.: Please Refer to Page 7
Frequency.: UMTS Band II/IV/V
Result.: PASS

Compiled by:

Martin Lee (handwritten signature)

Martin Lee/ Administrator

Supervised by:

Cary Luo (handwritten signature)

Cary Luo/ Technique principal

Approved by:

Gavin Liang (handwritten signature)

Gavin Liang/ Manager





TEST REPORT

Test Report No. :	LCSA04014383EF	May 11, 2024
		Date of issue

EUT.....	: Smartphone
Test Model.....	: J24
Applicant.....	: Xwireless LLC
Address.....	: 11565 Old Georgetown Road Rockville, MD 20852 USA
Telephone.....	: /
Fax.....	: /
Manufacturer.....	: Xwireless LLC
Address.....	: 11565 Old Georgetown Road Rockville, MD 20852 USA
Telephone.....	: /
Fax.....	: /
Factory.....	: BOPEL MOBILE TECHNOLOGY CO., LIMITED
Address.....	: RM 1601 CHOW TAI FOOK CTR, NO.580A-F NATHAN ROAD, MONG KOK, KL
Telephone.....	: /
Fax.....	: /

Test Result:	PASS
---------------------	-------------

The test report merely corresponds to the test sample.
 It is not permitted to copy extracts of these test result without the written permission of the test laboratory.





Revision History

Report Version	Issue Date	Revision Content	Revised By
000	May 11, 2024	Initial Issue	---





Contents

- 1 TEST STANDARDS 6**
- 2 SUMMARY 7**
 - 2.1 Product Description 7
 - 2.2 Equipment under Test 9
 - 2.3 Short description of the Equipment under Test (EUT) 9
 - 2.4 Support equipment List 9
 - 2.5 External I/O Port 9
 - 2.6 Normal Accessory setting 10
 - 2.7 Test Sample 10
 - 2.8 EUT configuration 10
 - 2.9 Related Submittal(s) / Grant (s) 10
 - 2.10 Modifications 10
 - 2.11 General Test Conditions/Configurations 10
- 3 TEST ENVIRONMENT 11**
 - 3.1 Address of the test laboratory 11
 - 3.2 Test Facility 11
 - 3.3 Environmental conditions 11
 - 3.4 Test Description 12
 - 3.5 Equipments Used during the Test 14
 - 3.6 Measurement uncertainty 15
- 4 TEST CONDITIONS AND RESULTS 16**
 - 4.1 Output Power 16
 - 4.2 Radiated Spurious Emssion 20
 - 4.3 Occupied Bandwidth and Emission Bandwith 24
 - 4.4 Band Edge Compliance 27
 - 4.5 Spurious Emssion on Antenna Port 29
 - 4.6 Frequency Stability Test 35
 - 4.7 Peak-to-Average Ratio (PAR) 38
- 5 TEST SETUP PHOTOS OF THE EUT 41**
- 6 EXTERNAL PHOTOS OF THE EUT 41**
- 7 INTERNAL PHOTOS OF THE EUT 41**





1 TEST STANDARDS

The tests were performed according to following standards:

[FCC Part 22H](#): Cellular Radiotelephone Service.

[FCC Part 24E](#): Broadband PCS.

[FCC Part 27](#): MISCELLANEOUS WIRELESS COMMUNICATIONS SERVICES

[TIA-603-E March 2016](#): Land Mobile FM or PM Communications Equipment Measurement and Performance Standards.

[47 CFR FCC Part 15 Subpart B](#): Unintentional Radiators.

[FCC Part 2](#): Frequency Allocations And Radio Treaty Matters; General Rules And Regulations.

[ANSI C63.4:2014](#): Methods of Measurement of Radio-Noise Emissions from Low-Voltage Electrical and Electronic Equipment in the Range of 9 kHz to 40 GHz.

[FCC KDB971168 D01](#): Power Meas License Digital Systems v03r01.

[ANSI C63.26-2015](#): Compliance Testing of Transmitters Used in Licensed Radio Services.



Shenzhen LCS Compliance Testing Laboratory Ltd.

Add: 101, 201 Bldg A & 301 Bldg C, Juji Industrial Park Yabianxueziwei, Shajing Street, Baoan District, Shenzhen, 518000, China

Tel: +(86) 0755-82591330 | E-mail: webmaster@lcs-cert.com | Web: www.lcs-cert.com

Scan code to check authenticity



2 SUMMARY

2.1 Product Description

The **Xwireless LLC**'s Model: J24 or the "EUT" as referred to in this report; more general information as follows, for more details, refer to the user's manual of the EUT.

EUT : Smartphone

Test Model : J24

Ratings : Input: DC 5.0V, 1.0A
 Adapter1 Model: WS-D01605010050
 For AC Adapter Input: 100-240V~, 50/60Hz, 0.30A
 Adapter Output: 5.0V=1.0A, 5W
 Adapter2 Model: YD1.0AY-006
 For AC Adapter Input: 100-240V~, 50/60Hz, 0.3A
 Adapter Output: 5.0V=1.0A, 5W
 Adapter3 Model: 05100A1
 For AC Adapter Input: 100-240V~, 50/60Hz, 0.3A
 Adapter Output: 5.0V=1.0A, 5W
 DC 3.8V by Rechargeable Li-ion Battery, 3000mAh

Hardware Version : J555B_63_32EMB_D3EFV1.0

Software Version : V01

Bluetooth

Frequency Range : 2402MHz~2480MHz

Channel Number : 79 channels for Bluetooth V4.2 (DSS)

40 channels for Bluetooth V4.2 (DTS)

Channel Spacing : 1MHz for Bluetooth V4.2 (DSS)

2MHz for Bluetooth V4.2 (DTS)

Modulation Type : GFSK, $\pi/4$ -DQPSK for Bluetooth V4.2 (DSS)

GFSK for Bluetooth V4.2 (DTS)

Bluetooth Version : V4.2

Antenna Description : PIFA Antenna, 1.67dBi (max.)

WIFI(2.4G Band)

Frequency Range : 2412MHz~2462MHz

Channel Spacing : 5MHz

Channel Number : 11 Channels for 20MHz bandwidth (2412~2462MHz)

Modulation Type : IEEE 802.11b: DSSS (CCK, DQPSK, DBPSK)

IEEE 802.11g: OFDM (64QAM, 16QAM, QPSK, BPSK)

IEEE 802.11n: OFDM (64QAM, 16QAM, QPSK, BPSK)

Antenna Description : PIFA Antenna, 1.67dBi (max.)

2G

Support Band : GSM 900 (EU-Band) DCS 1800 (EU-Band)

GSM 850 (U.S.-Band) PCS 1900 (U.S.-Band)

Release Version : R99

GPRS Class : Class 12

EGPRS Class : Class 12

Type Of Modulation : GMSK for GSM/GPRS; GMSK/8PSK for EGPRS



Shenzhen LCS Compliance Testing Laboratory Ltd.

Add: 101, 201 Bldg A & 301 Bldg C, Juji Industrial Park Yabianxueziwei, Shajing Street, Baoan District, Shenzhen, 518000, China

Tel: +(86) 0755-82591330 | E-mail: webmaster@lcs-cert.com | Web: www.lcs-cert.com

Scan code to check authenticity



Antenna Description : PIFA Antenna
0.2dBi (max.) For GSM 850
0.9dBi (max.) For PCS 1900

3G :

Support Band : WCDMA Band II (U.S.-Band)
 WCDMA Band IV (U.S.-Band)
 WCDMA Band V (U.S.-Band)

Release Version : R8

Type Of Modulation : QPSK,16QAM

Antenna Description : PIFA Antenna
0.9dBi (max.) For WCDMA Band II
0.8dBi (max.) For WCDMA Band IV
0.2dBi (max.) For WCDMA Band V

LTE :

Support Band : E-UTRA Band 2(U.S.-Band)
 E-UTRA Band 4(U.S.-Band)
 E-UTRA Band 5(U.S.-Band)
 E-UTRA Band 12(U.S.-Band)
 E-UTRA Band 13(U.S.-Band)
 E-UTRA Band 25(U.S.-Band)
 E-UTRA Band 26(U.S.-Band)
 E-UTRA Band 41(U.S.-Band)
 E-UTRA Band 66(U.S.-Band)
 E-UTRA Band 71(U.S.-Band)

LTE Release Version : R12

Type Of Modulation : QPSK/16QAM

Antenna Description : PIFA Antenna
0.9dBi (max.) For E-UTRA Band 2
0.8dBi (max.) For E-UTRA Band 4
0.8dBi (max.) For E-UTRA Band 5
-0.1dBi (max.) For E-UTRA Band 12
-0.1dBi (max.) For E-UTRA Band 13
0.9dBi (max.) For E-UTRA Band 25
0.3dBi (max.) For E-UTRA Band 26
0.9dBi (max.) For E-UTRA Band 41
0.8dBi (max.) For E-UTRA Band 66
-0.3dBi (max.) For E-UTRA Band 71

Power Class : Class 3

Extreme temp. Tolerance : -30°C to +50°C

Extreme vol. Limits : 3.4VDC to 4.35VDC (nominal: 3.8VDC)



Shenzhen LCS Compliance Testing Laboratory Ltd.

Add: 101, 201 Bldg A & 301 Bldg C, Juji Industrial Park Yabianxueziwei, Shajing Street, Baoan District, Shenzhen, 518000, China

Tel: +(86) 0755-82591330 | E-mail: webmaster@lcs-cert.com | Web: www.lcs-cert.com

Scan code to check authenticity



2.2 Equipment under Test

Power supply system utilised

Power supply voltage	:	<input checked="" type="radio"/> 120V / 60 Hz	<input type="radio"/> 115V / 60Hz
		<input type="radio"/> 12 V DC	<input type="radio"/> 24 V DC
		<input type="radio"/> Other (specified in blank below) 5V DC	

Test frequency list

Test Mode	TX/RX	RF Channel		
		Low(L)	Middle (M)	High (H)
WCDMA Band V	TX	Channel 4132	Channel 4182	Channel 4233
		826.4 MHz	836.4 MHz	846.6 MHz
	RX	Channel 4357	Channel 4407	Channel 4458
		871.4 MHz	881.4 MHz	891.6 MHz
Test Mode	TX/RX	RF Channel		
		Low(L)	Middle (M)	High (H)
WCDMA Band II	TX	Channel 9262	Channel 9400	Channel 9538
		1852.4 MHz	1880.0 MHz	1907.6 MHz
	RX	Channel 9662	Channel 9800	Channel 9938
		1932.4 MHz	1960.0 MHz	1987.6 MHz
Test Mode	TX/RX	RF Channel		
		Low(L)	Middle (M)	High (H)
WCDMA Band IV	TX	Channel1312	Channel1413	Channel1513
		1712.4MHz	1732.6MHz	1752.6MHz
	RX	Channel1537	Channel1638	Channel1738
		2112.4MHz	2132.6MHz	2152.6MHz

2.3 Short description of the Equipment under Test (EUT)

2.3.1 General Description

Smartphone is subscriber equipment in the BT/BLE/2.4GWIFI/GSM/WCDMA/LTE system. GSM/GPRS/EGPRS frequency band is Band II/V. The HSPA/UMTS frequency band is Band II/ IV/V. LTE frequency band is band 2/4/5/12/13/25/26/41/66/71. The HSPA/UMTS frequency band II and Band IV and Band V test data included in this report. The Smartphone implements such functions as RF signal receiving/transmitting, GSM/GPRS/EGPRS HSPA/UMTS/LTE protocol processing, video MMS service and etc. Externally it provides SIM card interface.

2.4 Support equipment List

Manufacturer	Description	Model	Serial Number	Certificate
Huizhou Wanzhisheng New Energy Technology Co., Lid	Adapter Power	WS-D01605010050	---	FCC
Bazhong Youdian Technology Co.,Ltd	Adapter Power	YD1.0AY-006	---	FCC
Shenzhen Jiekaixun Technology Co.,Ltd	Adapter Power	05100A1	---	FCC

2.5 External I/O Port

I/O Port Description	Quantity	Cable
Type-C USB Port	1	USB Cable: 1.0m, unshielded
Earphone jack	1	N/A



Shenzhen LCS Compliance Testing Laboratory Ltd.

Add: 101, 201 Bldg A & 301 Bldg C, Juji Industrial Park Yabianxueziwei, Shajing Street, Baoan District, Shenzhen, 518000, China

Tel: +(86) 0755-82591330 | E-mail: webmaster@lcs-cert.com | Web: www.lcs-cert.com

Scan code to check authenticity



2.6 Normal Accessory setting

N/A

2.7 Test Sample

The application provides 2 samples to meet requirement;

Sample Number	Description
Sample 1(A240417030-1)	Engineer sample – continuous transmit
Sample 2(A240417030-2)	Normal sample – Intermittent transmit

2.8 EUT configuration

The following peripheral devices and interface cables were connected during the measurement:

- - supplied by the manufacturer
- - supplied by the lab

○ Power Cable	Length (m) :	/
	Shield :	/
	Detachable :	/
○ Multimeter	Manufacturer :	/
	Model No. :	/

2.9 Related Submittal(s) / Grant (s)

This submittal(s) (test report) is intended for **FCC ID: 2ADLJ-J24** filing to comply with FCC Part 22H, Part 24E, Part 27 Rules.

2.10 Modifications

No modifications were implemented to meet testing criteria.

2.11 General Test Conditions/Configurations

2.11.1 Test Modes

NOTE: The test mode(s) are selected according to relevant radio technology specifications.

Test Mode	Test Modes Description
UMTS/TM1	WCDMA system, QPSK, 16QAM modulation
UMTS/TM2	HSDPA system, QPSK, 16QAM modulation
UMTS/TM3	HSUPA system, QPSK, 16QAM modulation

Note: As WCDMA, HSDPA and HSUPA with the same emission designator, test result recorded in this report at the worst case UMTS/TM1 only after exploratory scan.

2.11.2 Test Environment

Environment Parameter	Selected Values During Tests	
Relative Humidity	Ambient	
Temperature	TN	Ambient
Voltage	VL	DC 3.4V
	VN	DC 3.8V
	VH	DC 4.35V

NOTE: VL=lower extreme test voltage VN=nominal voltage
VH=upper extreme test voltage TN=normal temperature



Shenzhen LCS Compliance Testing Laboratory Ltd.

Add: 101, 201 Bldg A & 301 Bldg C, Juji Industrial Park Yabianxueziwei, Shajing Street, Baoan District, Shenzhen, 518000, China

Tel: +(86) 0755-82591330 | E-mail: webmaster@lcs-cert.com | Web: www.lcs-cert.com

Scan code to check authenticity



3 TEST ENVIRONMENT

3.1 Address of the test laboratory

Shenzhen LCS Compliance Testing Laboratory Ltd

101, 201 Bldg A & 301 Bldg C, Juji Industrial Park Yabianxueziwei, Shajing Street, Baoan District, Shenzhen, 518000, China

The sites are constructed in conformance with the requirements of ANSI C63.4 (2014) and CISPR Publication 22.

3.2 Test Facility

The test facility is recognized, certified, or accredited by the following organizations:

NVLAP Accreditation Code is 600167-0.

FCC Designation Number is CN5024.

CAB identifier is CN0071.

CNAS Registration Number is L4595.

Test Firm Registration Number: 254912

3.3 Environmental conditions

During the measurement the environmental conditions were within the listed ranges:

Temperature:	15-35 ° C
Humidity:	30-60 %
Atmospheric pressure:	950-1050mbar

(1)expressed at approximately the 95% confidence level using a coverage factor of k=1.96.





3.4 Test Description

3.4.1 Cellular Band (824-849MHz paired with 869-894MHz) (Band V)

Test Item	FCC Rule No.	Requirements	Verdict
Effective(Isotropic) Radiated Output Power	§2.1046, §22.913	FCC: ERP ≤ 7W.	Pass
Modulation Characteristics	§2.1047	Digital modulation	N/A
Bandwidth	§2.1049	OBW: No limit. EBW: No limit.	Pass
Band Edges Compliance	§2.1051, §22.917	≤-13dBm/1%*EBW, in 1MHz bands immediately outside and adjacent to The frequency block.	Pass
Spurious Emission at Antenna Terminals	§2.1051, §22.917	≤ -13dBm/100kHz, from 9kHz to 10 th harmonics but outside authorized operating frequency ranges.	Pass
Field Strength of Spurious Radiation	§2.1053, §22.917	≤ -13dBm/100kHz.	Pass
Frequency Stability	§2.1055, §22.355	≤ ±2.5ppm.	Pass
Peak-Average Ratio	§24.232	≤13dB	Pass

NOTE 1: For the verdict, the "N/A" denotes "not applicable", the "N/T" de notes "not tested".

3.4.2 PCS Band (1850-1910MHz paired with 1930-1990MHz) (Band II)

Test Item	FCC Rule No.	Requirements	Verdict
Effective(Isotropic) Radiated Output Power	§2.1046, §24.232	EIRP ≤ 2W	Pass
Peak-Average Ratio	§2.1046, §24.232	≤13dB	Pass
Modulation Characteristics	§2.1047	Digital modulation	N/A
Bandwidth	§2.1049	OBW: No limit. EBW: No limit.	Pass
Band Edges Compliance	§2.1051, §24.238	≤ -13dBm/1%*EBW, In 1MHz bands immediately outside and adjacent to The frequency block.	Pass
Spurious Emission at Antenna Terminals	§2.1051, §24.238	≤-13dBm/1MHz, from 9kHz to10 th harmonics but outside authorized operating frequency ranges.	Pass
Field Strength of Spurious Radiation	§2.1053, §24.238	≤ -13dBm/1MHz.	Pass
Frequency Stability	§2.1055, §24.235	≤ ±2.5ppm.	Pass

NOTE 1: For the verdict, the "N/A" denotes "not applicable", the "N/T" de notes "not tested".



Shenzhen LCS Compliance Testing Laboratory Ltd.

Add: 101, 201 Bldg A & 301 Bldg C, Juji Industrial Park Yabianxueziwei, Shajing Street, Baoan District, Shenzhen, 518000, China

Tel: +(86) 0755-82591330 | E-mail: webmaster@lcs-cert.com | Web: www.lcs-cert.com

Scan code to check authenticity

**3.4.3 AWS Band (1710-1755MHz paired with 2110-2155MHz) (Band IV)**

Test Item	FCC RuleNo.	Requirements	Verdict
Effective(Isotropic) Radiated Power Output Data	§2.1046, §27.50(d)	EIRP ≤ 1W;	Pass
Peak-Average Ratio	§2.1046, §27.50(d)	Limit≤13dB	Pass
Modulation Characteristics	§2.1047	Digitalmodulation	N/A
Bandwidth	§2.1049	OBW: Nolimit. EBW: Nolimit.	Pass
BandEdges Compliance	§2.1051, §27.53(h)	≤ -13dBm/1%*EBW,in1 MHz bands immediately outside and adjacent to the frequency block.	Pass
Spurious Emission at Antenna Terminals	§2.1051, §27.53(h)	≤ -13dBm/1MHz, from 9kHz to10th harmonics but outside authorized operating frequency ranges.	Pass
Frequency Stability	§2.1055, §27.54	Within authorized bands of operation/frequency block.	Pass
Radiated spurious emission	§2.1053, §27.53(h)	≤ -13dBm/1MHz.	Pass

NOTE 1: For the verdict, the "N/A" denotes "not applicable", the "N/T" de notes "not tested"





3.5 Equipments Used during the Test

Item	Equipment	Manufacturer	Model No.	Serial No.	Cal Date	Due Date
1	Power Meter	R&S	NRVS	100444	2023-06-09	2024-06-08
2	Power Sensor	R&S	NRV-Z81	100458	2023-06-09	2024-06-08
3	Power Sensor	R&S	NRV-Z32	10057	2023-06-09	2024-06-08
4	LTE Test Software	Tonscend	JS1120-1	N/A	N/A	N/A
5	RF Control Unit	Tonscend	JS0806-1	158060009	2023-10-18	2024-10-17
6	MXA Signal Analyzer	Agilent	N9020A	MY51250905	2023-10-18	2024-10-17
7	WIDEBAND RADIO COMMUNICATION TESTER	R&S	CMW 500	103818	2023-06-09	2024-06-08
8	DC Power Supply	Agilent	E3642A	N/A	2023-10-18	2024-10-17
9	EMI Test Software	AUDIX	E3	/	N/A	N/A
10	3m Semi Anechoic Chamber	SIDT FRANKONIA	SAC-3M	03CH03-HY	2023-06-09	2024-06-08
11	Positioning Controller	Max-Full	MF7802BS	MF780208586	N/A	N/A
12	Active Loop Antenna	SCHWARZBECK	FMZB 1519B	00005	2021-08-29	2024-08-28
13	By-log Antenna	SCHWARZBECK	VULB9163	9163-470	2021-09-12	2024-09-11
14	By-log Antenna	SCHWARZBECK	VULB9163	9163-471	2021-09-12	2024-09-11
15	Horn Antenna	SCHWARZBECK	BBHA 9120D	9120D-1925	2021-09-05	2024-09-04
16	Horn Antenna	SCHWARZBECK	BBHA 9120D	9120D-1926	2021-09-05	2024-09-04
17	Broadband Horn Antenna	SCHWARZBECK	BBHA 9170	791	2021-08-29	2024-08-28
18	Broadband Horn Antenna	SCHWARZBECK	BBHA 9170	792	2021-08-29	2024-08-28
19	Broadband Preamplifier	SCHWARZBECK	BBV9719	9719-025	2021-08-29	2024-08-28
20	EMI Test Receiver	R&S	ESR 7	101181	2023-08-15	2024-08-14
21	RS SPECTRUM ANALYZER	R&S	FSP40	100503	2023-07-17	2024-07-16
22	Low-frequency amplifier	SchwarzZBECK	BBV9745	00253	2023-10-18	2024-10-17
23	High-frequency amplifier	JS Denki Pte	PA0118-43	JSPA21009	2023-10-18	2024-10-17
24	6dB Attenuator	/	100W/6dB	1172040	2023-06-09	2024-06-08
26	3dB Attenuator	/	2N-3dB	/	2023-10-18	2024-10-17
27	Temperature & Humidity Chamber	GUANGZHOU GOGNWEN	GDS-100	70932	2023-10-05	2024-10-04
28	EMI Test Software	Farad	EZ	/	N/A	N/A
29	RADIO COMMUNICATION TESTER	R&S	CMU 200	105988	2023-06-09	2024-06-08
30	Antenna Mast	Max-Full	MFA-515BSN	1308572	N/A	N/A



Shenzhen LCS Compliance Testing Laboratory Ltd.

Add: 101, 201 Bldg A & 301 Bldg C, Juji Industrial Park Yabianxueziwei, Shajing Street, Baoan District, Shenzhen, 518000, China

Tel: +(86) 0755-82591330 | E-mail: webmaster@lcs-cert.com | Web: www.lcs-cert.com

Scan code to check authenticity



3.6 Measurement uncertainty

The data and results referenced in this document are true and accurate. The reader is cautioned that there may be errors within the calibration limits of the equipment and facilities. The measurement uncertainty was calculated for all measurements listed in this test report acc. to ETSI TR 100 028 " Electromagnetic compatibility and Radio spectrum Matters (ERM); Uncertainties in the measurement of mobile radio equipment characteristics" and is documented in the Shenzhen LCS Compliance Testing Laboratory Ltd. quality system acc. to DIN EN ISO/IEC 17025. Furthermore, component and process variability of devices similar to that tested may result in additional deviation. The manufacturer has the sole responsibility of continued compliance of the device.

Hereafter the best measurement capability for Shenzhen LCS Compliance Testing Laboratory Ltd. is reported:

Test	Range	Measurement Uncertainty	Notes
Radiated Emission	30~1000MHz	3.10 dB	(1)
Radiated Emission	1~18GHz	3.80 dB	(1)
Radiated Emission	18-40GHz	3.90 dB	(1)
Conducted Disturbance	0.15~30MHz	1.63 dB	(1)
Conducted Power	9KHz~18GHz	0.61 dB	(1)
Spurious RF Conducted Emission	9KHz~40GHz	1.22 dB	(1)
Band Edge Compliance of RF Emission	9KHz~40GHz	1.22 dB	(1)
Occupied Bandwidth	9KHz~40GHz	-	(1)

(1) This uncertainty represents an expanded uncertainty expressed at approximately the 95% confidence level using a coverage factor of $k=1.96$.



Shenzhen LCS Compliance Testing Laboratory Ltd.

Add: 101, 201 Bldg A & 301 Bldg C, Juji Industrial Park Yabianxueziwei, Shajing Street, Baoan District, Shenzhen, 518000, China

Tel: +(86) 0755-82591330 | E-mail: webmaster@lcs-cert.com | Web: www.lcs-cert.com

Scan code to check authenticity



4 TEST CONDITIONS AND RESULTS

4.1 Output Power

TEST APPLICABLE

During the process of testing, the EUT was controlled via R&S WIDEBAND RADIO COMMUNICATION TESTER (CMW 500) to ensure max power transmission and proper modulation. This result contains output power and EIRP measurements for the EUT. In all cases, output power is within the specified limits.

4.1.1. Conducted Output Power

TEST CONFIGURATION

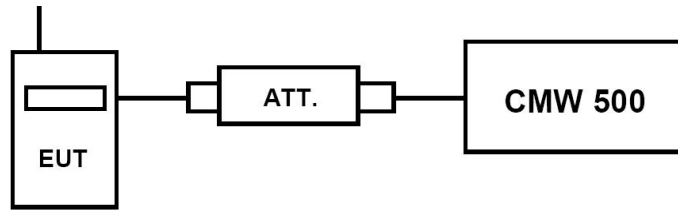

TEST PROCEDURE

Conducted Power Measurement:

- a) Place the EUT on a bench and set it in transmitting mode.
- b) Connect a low loss RF cable from the antenna port to a CMW 500 by an Att.
- c) EUT Communicate with CMW 500 then selects a channel for testing.
- d) Add a correction factor to the display CMW 500, and then test.

TEST RESULTS

Item	band	WCDMA Band II result (dBm)			WCDMA Band IV result (dBm)			WCDMA Band V result (dBm)		
		Channel/Frequency(MHz)			Channel/Frequency(MHz)			Channel/Frequency(MHz)		
		9262/1852.4	9400/1880	9538/1907.6	1312/1712.4	1413/1732.6	1513/1752.6	4132/826.4	4182/836.4	4233/846.6
RMC	12.2kbps RMC	23.43	23.50	23.24	23.08	23.14	23.11	22.74	22.79	22.62
HSDPA	Sub -Test 1	22.79	22.84	22.48	22.59	22.60	22.50	22.47	22.86	22.64
	Sub -Test 2	22.66	22.68	22.45	22.62	22.71	22.55	22.72	22.81	22.67
	Sub -Test 3	22.54	22.53	22.38	22.74	22.65	22.55	22.53	22.77	22.46
	Sub -Test 4	22.37	22.50	22.66	22.49	22.69	22.57	22.59	22.62	22.74
HSUPA	Sub -Test 1	22.59	22.50	22.53	22.47	22.58	22.40	22.61	22.62	22.38
	Sub -Test 2	22.55	22.57	22.53	22.46	22.64	22.55	22.39	22.69	22.53
	Sub -Test 3	22.45	22.56	22.47	22.67	22.66	22.63	22.32	22.70	22.46
	Sub -Test 4	22.32	22.34	22.51	22.46	22.51	22.51	21.59	21.56	21.47
	Sub -Test 5	21.53	21.72	21.51	21.36	21.50	21.37	21.73	20.95	21.79



4.1.1 Radiated Output Power

TEST DESCRIPTION

This is the test for the maximum radiated power from the EUT.

Rule Part 24.232(c) specifies, "Mobile/portable stations are limited to 2 watts e.i.r.p. Peak power" and 24.232(e) specifies that "Peak transmit power must be measured over any interval of continuous transmission using instrumentation calibrated in terms of an rms-equivalent voltage."

Rule Part 22.913(a) specifies "The ERP of mobile transmitters and auxiliary test transmitters must not exceed 7 Watts."

Per Part 27.50(d) (4) specifies, Fixed, mobile, and portable (hand-held) stations operating in the 1710-1755MHz band are limited to 1W EIRP. Fixed stations operating in this band are limited to a maximum antenna height of 10 meters above ground. Mobile and portable stations operating in this band must employ a means for limiting power to the minimum necessary for successful communications.

TEST CONFIGURATION

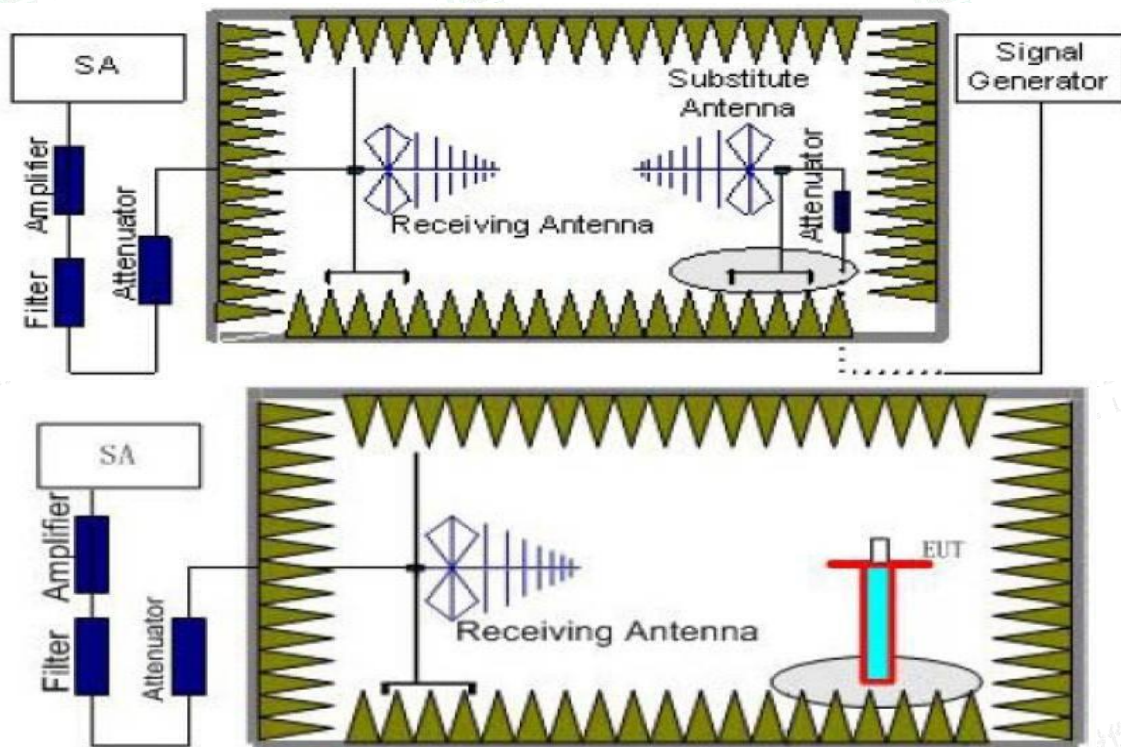

TEST PROCEDURE

1. EUT was placed on a 1.50 meter high non-conductive stand at a 3 meter test distance from the receive antenna. A receiving antenna was placed on the antenna mast 3 meters from the EUT for emission measurements. The height of receiving antenna is 1.50m. Detected emissions were maximized at each frequency by rotating the EUT through 360° and adjusting the receiving antenna polarization. The radiated emission measurements of all transmit frequencies in three channels (High, Middle, Low) were measured with peak detector.
2. A log-periodic antenna or double-ridged waveguide horn antenna shall be substituted in place of the EUT. The log-periodic antenna will be driven by a signal generator and the level will be adjusted till the same power value on the spectrum analyzer or receiver. The level of the spurious emissions can be calculated through the level of the signal generator, cable loss, the gain of the substitution antenna and the reading of the spectrum analyzer or receiver.
3. The EUT is then put into continuously transmitting mode at its maximum power level during the test. Set Test Receiver or Spectrum RBW=10MHz, VBW=10MHz, And the maximum value of the receiver should be recorded as (P_r).





4. The EUT shall be replaced by a substitution antenna. In the chamber, an substitution antenna for the frequency band of interest is placed at the reference point of the chamber. An RF Signal source for the frequency band of interest is connected to the substitution antenna with a cable that has been constructed to not interfere with the radiation pattern of the antenna. A power (P_{Mea}) is applied to the input of the substitution antenna, and adjust the level of the signal generator output until the value of the receiver reach the previously recorded (P_r). The power of signal source (P_{Mea}) is recorded. The test should be performed by rotating the test item and adjusting the receiving antenna polarization.
5. A amplifier should be connected to the Signal Source output port. And the cable should be connect between the Amplifier and the Substitution Antenna. The cable loss (P_{cl}), the Substitution Antenna Gain (G_a) and the Amplifier Gain (P_{Ag}) should be recorded after test.
The measurement results are obtained as described below:
 $Power(EIRP) = P_{Mea} + P_{Ag} - P_{cl} + G_a$
6. This value is EIRP since the measurement is calibrated using an antenna of known gain (2.15 dBi) and known input power.
7. ERP can be calculated from EIRP by subtracting the gain of the dipole, $ERP = EIRP - 2.15dBi$.

TEST LIMIT

According to 22.913(a)(5), 24.232(c), §27.50(d) the ERP(EIRP) should be not exceeding following table limits:

	Burst Average EIRP
UMTS Band II	FCC: $\leq 33.01dBm$ (2W)
	Burst Average ERP
UMTS Band V	FCC: $\leq 38.45dBm$ (7W)
	Burst Average EIRP
UMTS Band IV	FCC: $\leq 30.00dBm$ (1W)



**TEST RESULTS****Remark:**

1. We were tested all Configuration refer 3GPP TS134 121.
2. $EIRP = P_{Mea}(dBm) - P_{cl}(dB) + P_{Ag}(dB) + G_a(dBi)$
3. $ERP = EIRP - 2.15dBi$ as EIRP by subtracting the gain of the dipole.
4. $Margin = Emission Level - Limit$
5. We tested the worst-case records for H and V directions, and only the worst-case records for V direction were recorded in the report.

UMTS/TM1/UMTS Band II

Frequency (MHz)	P _{Mea} (dBm)	P _{cl} (dB)	G _a Antenna Gain (dB)	P _{Ag} (dB)	Burst Average EIRP (dBm)	Limit (dBm)	Margin (dB)	Polarization
1852.4	-17.01	4.03	8.38	35.51	22.85	33.01	-10.16	V
1880.0	-16.27	4.08	8.33	35.56	23.54	33.01	-9.47	V
1907.6	-17.15	4.14	8.26	35.63	22.60	33.01	-10.41	V

UMTS/TM1/UMTS Band V

Frequency (MHz)	P _{Mea} (dBm)	P _{cl} (dB)	G _a Antenna Gain (dB)	Correction (dB)	P _{Ag} (dB)	Burst Average ERP (dBm)	Limit (dBm)	Margin (dB)	Polarization
826.4	-13.73	3.45	8.45	2.15	33.79	22.91	38.45	-15.54	V
836.4	-13.62	3.49	8.45	2.15	33.85	23.04	38.45	-15.41	V
846.6	-13.45	3.55	8.36	2.15	33.88	23.09	38.45	-15.36	V

UMTS/TM1/UMTS Band IV

Frequency (MHz)	P _{Mea} (dBm)	P _{cl} (dB)	G _a Antenna Gain (dB)	P _{Ag} (dB)	Burst Average EIRP (dBm)	Limit (dBm)	Margin (dB)	Polarization
1712.4	-17.62	3.93	9.05	34.96	22.46	30.00	-7.54	V
1732.6	-16.85	3.93	8.89	35.01	23.12	30.00	-6.88	V
1752.6	-17.41	3.94	8.76	35.08	22.49	30.00	-7.51	V



Shenzhen LCS Compliance Testing Laboratory Ltd.

Add: 101, 201 Bldg A & 301 Bldg C, Juji Industrial Park Yabianxueziwei, Shajing Street, Baoan District, Shenzhen, 518000, China

Tel: +(86) 0755-82591330 | E-mail: webmaster@lcs-cert.com | Web: www.lcs-cert.com

Scan code to check authenticity

4.2 Radiated Spurious Emission

TEST APPLICABLE

According to the TIA-603-E:2016 and FCC Part 2.1033 test method, The Receiver or Spectrum was scanned from lowest frequency frequency generated within the equipment to the 10th harmonic of the highest frequency generated within the equipment, which is the transmitted carrier that can be as high as 1910 MHz. The resolution bandwidth is set as outlined in Part 24.238, Part 22.917, Part 27.53 The spectrum is scanned with the mobile station transmitting at carrier frequencies that pertain to low, mid and high channels of WCDMA Band II , WCDMA Band V and WCDMA Band IV.

TEST CONFIGURATION

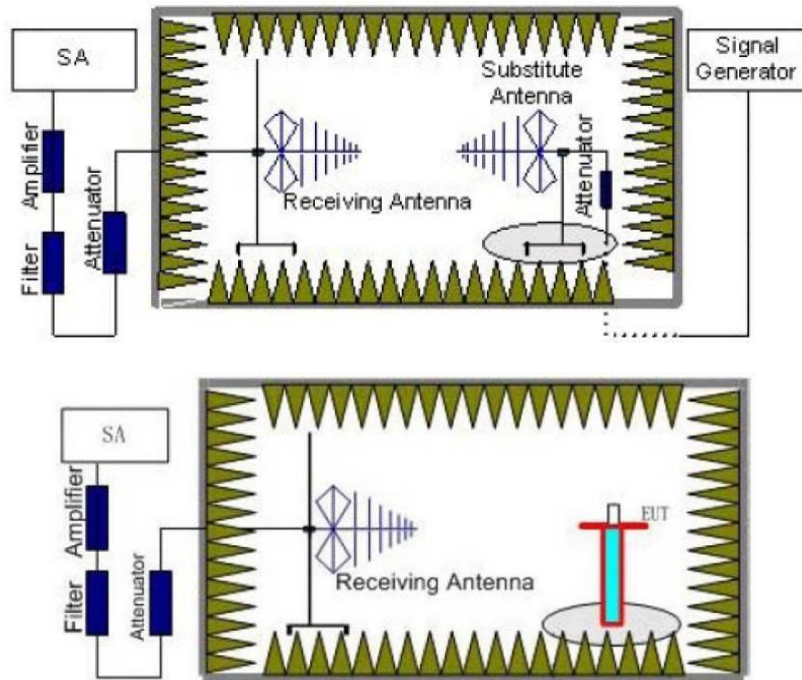

TEST PROCEDURE

1. EUT was placed on a 1.50 meter high non-conductive stand at a 3 meter test distance from the receive antenna. A receiving antenna was placed on the antenna mast 3 meters from the EUT for emission measurements. The height of receiving antenna is 1.50 m. Detected emissions were maximized at each frequency by rotating the EUT through 360° and adjusting the receiving antenna polarization. The radiated emission measurements of all transmit frequencies in three channels (High, Middle, Low) were measured with peak detector.
2. A log-periodic antenna or double-ridged waveguide horn antenna shall be substituted in place of the EUT. The log-periodic antenna will be driven by a signal generator and the level will be adjusted till the same power value on the spectrum analyzer or receiver. The level of the spurious emissions can be calculated through the level of the signal generator, cable loss, the gain of the substitution antenna and the reading of the spectrum analyzer or receiver.
3. The EUT is then put into continuously transmitting mode at its maximum power level during the test. Set Test Receiver or Spectrum RBW=1MHz, VBW=3MHz, And the maximum value of the receiver should be recorded as (P_r).
4. The EUT shall be replaced by a substitution antenna. In the chamber, an substitution antenna for the frequency band of interest is placed at the reference point of the chamber. An RF Signal source for the frequency band of interest is connected to the substitution antenna with a cable that has been constructed to not interfere with the radiation pattern of the antenna. A power (P_{Mea}) is applied to the input of the substitution antenna, and adjust the level of the signal generator output until the value of the receiver reach the previously recorded (P_r). The power of signal source (P_{Mea}) is recorded. The test should be performed by rotating the test item and adjusting the receiving antenna polarization.





5. A amplifier should be connected to the Signal Source output port. And the cable should be connect between the Amplifier and the Substitution Antenna. The cable loss (P_{cl}), the Substitution Antenna Gain (G_a) and the Amplifier Gain (P_{Ag}) should be recorded after test.

The measurement results are obtained as described below:

$$\text{Power(EIRP)} = P_{\text{Mea}} + P_{\text{Ag}} - P_{\text{cl}} + G_a$$

6. This value is EIRP since the measurement is calibrated using an antenna of known gain (2.15 dBi) and known input power.
7. ERP can be calculated from EIRP by subtracting the gain of the dipole, $\text{ERP} = \text{EIRP} - 2.15\text{dBi}$.
8. In order to make sure test results more clearly, we set frequency range and sweep time for difference frequency range as follows table:

Working Frequency	Subrange (GHz)	RBW	VBW	Sweep time (s)
UMTS/TM1/ WCDMA Band V	0.00009~0.15	1KHz	3KHz	30
	0.00015~0.03	10KHz	30KHz	10
	0.03~1	100KHz	300KHz	10
	1~2	1 MHz	3 MHz	2
	2~5	1 MHz	3 MHz	3
	5~8	1 MHz	3 MHz	3
	8~10	1 MHz	3 MHz	3
UMTS/TM1/ WCDMA Band II	0.00009~0.15	1KHz	3KHz	30
	0.00015~0.03	10KHz	30KHz	10
	0.03~1	100KHz	300KHz	10
	1~2	1 MHz	3 MHz	2
	2~5	1 MHz	3 MHz	3
	5~8	1 MHz	3 MHz	3
	8~11	1 MHz	3 MHz	3
	11~14	1 MHz	3 MHz	3
	14~18	1 MHz	3 MHz	3
UMTS/TM1/ WCDMA Band IV	0.00009~0.15	1KHz	3KHz	30
	0.00015~0.03	10KHz	30KHz	10
	0.03~1	100KHz	300KHz	10
	1~2	1 MHz	3 MHz	2
	2~5	1 MHz	3 MHz	3
	5~8	1 MHz	3 MHz	3
	8~11	1 MHz	3 MHz	3
	11~14	1 MHz	3 MHz	3
	14~18	1 MHz	3 MHz	3

TEST LIMITS

According to 24.238, 22.917, 27.53, specify that the power of any emission outside of the authorized operating frequency ranges must be attenuated below the transmitting power (P) by a factor of at least $43 + 10 \log(P)$ dB. The specification that emissions shall be attenuated below the transmitter power (P) by at least $43 + 10 \log(P)$ dB, translates in the relevant power range (1 to 0.001 W) to -13 dBm. At 1 W the specified minimum attenuation becomes 43 dB and relative to a 30 dBm (1 W) carrier becomes a limit of -13 dBm. At 0.001 W (0 dBm) the minimum attenuation is 13 dB, which again yields a limit of -13 dBm. In this way a translation of the specification from relative to absolute terms is carried out.



Shenzhen LCS Compliance Testing Laboratory Ltd.

Add: 101, 201 Bldg A & 301 Bldg C, Juji Industrial Park Yabianxueziwei, Shajing Street, Baoan District, Shenzhen, 518000, China

Tel: +(86) 0755-82591330 | E-mail: webmaster@lcs-cert.com | Web: www.lcs-cert.com

Scan code to check authenticity



Frequency	Channel	Frequency Range	Verdict
UMTS/TM1/ WCDMA Band V	Low	9KHz - 10GHz	PASS
	Middle	9KHz - 10GHz	PASS
	High	9KHz - 10GHz	PASS
UMTS/TM1/ WCDMA Band II	Low	9KHz - 20GHz	PASS
	Middle	9KHz - 20GHz	PASS
	High	9KHz - 20GHz	PASS
UMTS/TM1/ WCDMA Band IV	Low	9KHz - 18GHz	PASS
	Middle	9KHz - 18GHz	PASS
	High	9KHz - 18GHz	PASS

TEST RESULTS

Remark:

1. We were tested all Configuration refer 3GPP TS134 121.
2. $EIRP = P_{Mea}(dBm) - P_{cl}(dB) + P_{Ag}(dB) + G_a(dBi)$
3. $ERP = EIRP - 2.15dBi$ as EIRP by subtracting the gain of the dipole.
4. $Margin = EIRP - Limit$

Note: All adapters and all the modes have been tested and recorded worst mode in the report.

UMTS/TM1/ WCDMA Band II _ Low Channel

Frequency (MHz)	P _{Mea} (dBm)	P _{cl} (dB)	Diatance	G _a Antenna Gain(dB)	Peak EIRP (dBm)	Limit (dBm)	Margin (dB)	Polarization
3704.8	-40.00	5.26	3.00	9.88	-35.38	-13.00	-22.38	H
5557.2	-45.50	6.11	3.00	11.36	-40.25	-13.00	-27.25	H
3704.8	-44.65	5.26	3.00	9.88	-40.03	-13.00	-27.03	V
5557.2	-48.64	6.11	3.00	11.36	-43.39	-13.00	-30.39	V

UMTS/TM1/ WCDMA Band II _ Middle Channel

Frequency (MHz)	P _{Mea} (dBm)	P _{cl} (dB)	Diatance	G _a Antenna Gain(dB)	Peak EIRP (dBm)	Limit (dBm)	Margin (dB)	Polarization
3760.0	-37.88	5.32	3.00	10.03	-33.17	-13.00	-20.17	H
5640.0	-43.86	6.19	3.00	11.41	-38.64	-13.00	-25.64	H
3760.0	-43.82	5.32	3.00	10.03	-39.11	-13.00	-26.11	V
5640.0	-47.96	6.19	3.00	11.41	-42.74	-13.00	-29.74	V

UMTS/TM1/ WCDMA Band II _ High Channel

Frequency (MHz)	P _{Mea} (dBm)	P _{cl} (dB)	Diatance	G _a Antenna Gain(dB)	Peak EIRP (dBm)	Limit (dBm)	Margin (dB)	Polarization
3815.2	-43.42	5.36	3.00	9.62	-39.16	-13.00	-26.16	H
5722.8	-51.24	6.24	3.00	11.46	-46.02	-13.00	-33.02	H
3815.2	-46.61	5.36	3.00	9.62	-42.35	-13.00	-29.35	V
5722.8	-53.62	6.24	3.00	11.46	-48.40	-13.00	-35.40	V

UMTS/TM1/ WCDMA Band V _ Low Channel

Frequency (MHz)	P _{Mea} (dBm)	P _{cl} (dB)	Diatance	G _a Antenna Gain(dB)	Peak EIRP (dBm)	Limit (dBm)	Margin (dB)	Polarization
1652.8	-48.23	3.86	3.00	8.56	-43.53	-13.00	-30.53	H
2479.2	-48.92	4.29	3.00	6.98	-46.23	-13.00	-33.23	H
1652.8	-43.95	3.86	3.00	8.56	-39.25	-13.00	-26.25	V
2479.2	-44.76	4.29	3.00	6.98	-42.07	-13.00	-29.07	V



Shenzhen LCS Compliance Testing Laboratory Ltd.

Add: 101, 201 Bldg A & 301 Bldg C, Juji Industrial Park Yabianxueziwei, Shajing Street, Baoan District, Shenzhen, 518000, China

Tel: +(86) 0755-82591330 | E-mail: webmaster@lcs-cert.com | Web: www.lcs-cert.com

Scan code to check authenticity



UMTS/TM1/ WCDMA Band V _ Middle Channel

Frequency (MHz)	P _{Mea} (dBm)	P _{cl} (dB)	Diatance	G _a Antenna Gain(dB)	Peak EIRP (dBm)	Limit (dBm)	Margin (dB)	Polarization
1672.8	-49.68	3.9	3.00	8.58	-45.00	-13.00	-32.00	H
2509.2	-50.82	4.32	3.00	6.8	-48.34	-13.00	-35.34	H
1672.8	-44.86	3.9	3.00	8.58	-40.18	-13.00	-27.18	V
2509.2	-45.57	4.32	3.00	6.8	-43.09	-13.00	-30.09	V

UMTS/TM1/ WCDMA Band V _ High Channel

Frequency (MHz)	P _{Mea} (dBm)	P _{cl} (dB)	Diatance	G _a Antenna Gain(dB)	Peak EIRP (dBm)	Limit (dBm)	Margin (dB)	Polarization
1693.2	-51.70	3.91	3.00	9.06	-46.55	-13.00	-33.55	H
2539.8	-54.60	4.32	3.00	6.65	-52.27	-13.00	-39.27	H
1693.2	-49.25	3.91	3.00	9.06	-44.10	-13.00	-31.10	V
2539.8	-51.45	4.32	3.00	6.65	-49.12	-13.00	-36.12	V

UMTS/TM1/ WCDMA Band IV _ Low Channel

Frequency (MHz)	P _{Mea} (dBm)	P _{cl} (dB)	Diatance	G _a Antenna Gain(dB)	Peak EIRP (dBm)	Limit (dBm)	Margin (dB)	Polarization
3424.8	-46.04	4.62	3.00	9.81	-40.85	-13.00	-27.85	H
5137.2	-49.73	5.94	3.00	10.86	-44.81	-13.00	-31.81	H
3424.8	-49.04	4.62	3.00	9.81	-43.85	-13.00	-30.85	V
5137.2	-53.23	5.94	3.00	10.86	-48.31	-13.00	-35.31	V

UMTS/TM1/ WCDMA Band IV _ Middle Channel

Frequency (MHz)	P _{Mea} (dBm)	P _{cl} (dB)	Diatance	G _a Antenna Gain(dB)	Peak EIRP (dBm)	Limit (dBm)	Margin (dB)	Polarization
3465.2	-41.28	4.63	3.00	9.84	-36.07	-13.00	-23.07	H
5197.8	-46.35	5.94	3.00	10.86	-41.43	-13.00	-28.43	H
3465.2	-44.01	4.63	3.00	9.84	-38.80	-13.00	-25.80	V
5197.8	-49.50	5.94	3.00	10.86	-44.58	-13.00	-31.58	V

UMTS/TM1/ WCDMA Band IV _ High Channel

Frequency (MHz)	P _{Mea} (dBm)	P _{cl} (dB)	Diatance	G _a Antenna Gain(dB)	Peak EIRP (dBm)	Limit (dBm)	Margin (dB)	Polarization
3505.2	-47.82	4.65	3.00	9.9	-42.57	-13.00	-29.57	H
5257.8	-51.47	5.95	3.00	10.91	-46.51	-13.00	-33.51	H
3505.2	-50.92	4.65	3.00	9.9	-45.67	-13.00	-32.67	V
5257.8	-53.66	5.95	3.00	10.91	-48.70	-13.00	-35.70	V



Shenzhen LCS Compliance Testing Laboratory Ltd.

Add: 101, 201 Bldg A & 301 Bldg C, Juji Industrial Park Yabianxueziwei, Shajing Street, Baoan District, Shenzhen, 518000, China

Tel: +(86) 0755-82591330 | E-mail: webmaster@lcs-cert.com | Web: www.lcs-cert.com

Scan code to check authenticity



4.3 Occupied Bandwidth and Emission Bandwidth

TEST APPLICABLE

Similar to conducted emissions; occupied bandwidth measurements are only provided for selected frequencies in order to reduce the amount of submitted data. The table below lists the measured 99% Bandwidth and -26dBc Bandwidth.

TEST CONFIGURATION

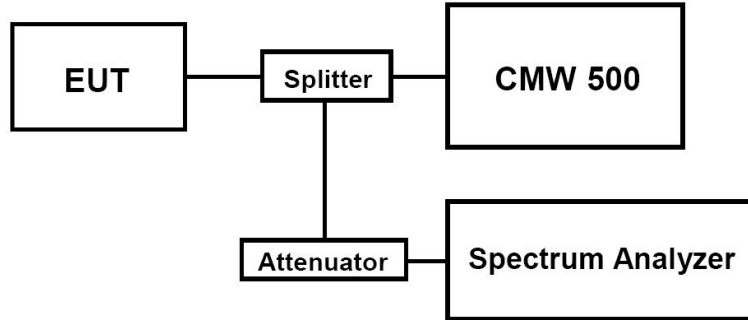

TEST PROCEDURE

1. The EUT was set up for the max output power with pseudo random data modulation;
2. The Occupied bandwidth and Emission Bandwidth were measured with Agilent Spectrum Analyzer N9020A (peak);
3. Set RBW=100KHz,VBW=300KHz,Span=10MHz,SWT=Auto;
4. Set SPA Max hold and View, Set 99% Occupied Bandwidth/ Set -26dBc Occupied Bandwidth
5. These measurements were done at 3 frequencies for WCDMA band II/IV/V. (low, middle and high of operational frequency range).

TEST RESULTS

Test Mode	Channel	Frequency (MHz)	Occupied Bandwidth (99% BW) (MHz)	Emission Bandwidth (-26 dBc BW) (MHz)	Verdict
UMTS/TM1/ WCDMA Band II	9262	1852.4	4.1644	4.707	PASS
	9400	1880.0	4.1679	4.706	PASS
	9538	1907.6	4.1681	4.701	PASS
UMTS/TM1/ WCDMA Band V	4132	826.4	4.1672	4.719	PASS
	4182	836.4	4.1649	4.724	PASS
	4233	846.6	4.1635	4.716	PASS
UMTS/TM1/ WCDMA Band IV	1312	1712.4	4.1706	4.696	PASS
	1413	1732.6	4.1674	4.690	PASS
	1513	1752.6	4.1581	4.725	PASS

Remark:

1. Test results including cable loss;
2. Please refer to following plots;





Occupied Bandwidth and Emission Bandwidth

UMTS/TM1/ WCDMA Band II

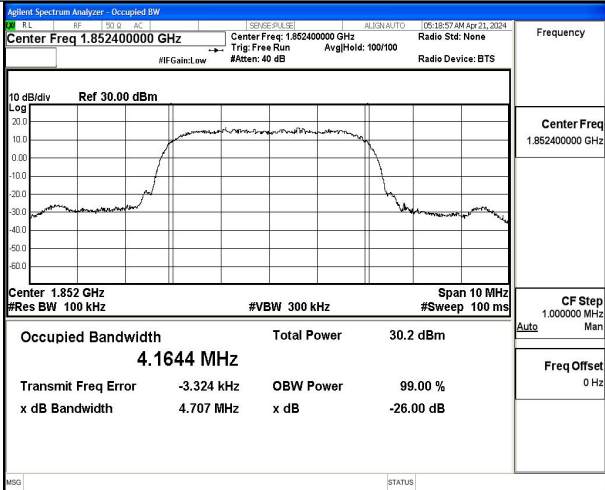

UMTS/TM1/ WCDMA Band V

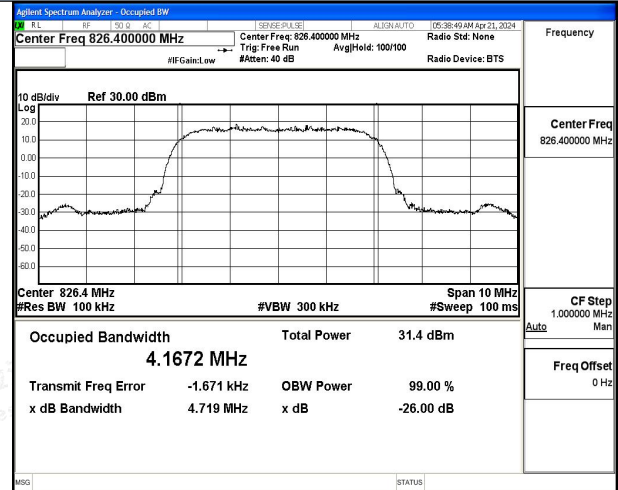

Channel 9262 / 1852.4 MHz

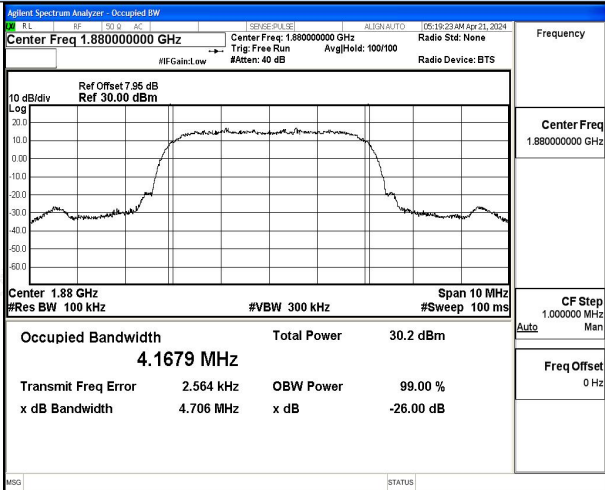

Channel 4132 / 826.4 MHz

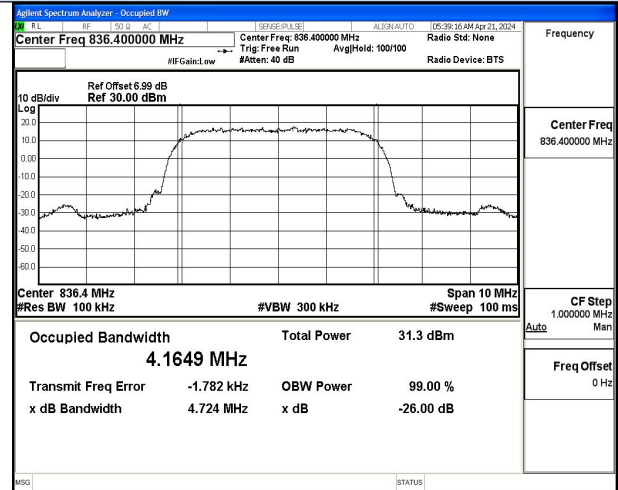

Channel 9400 / 1880.0 MHz

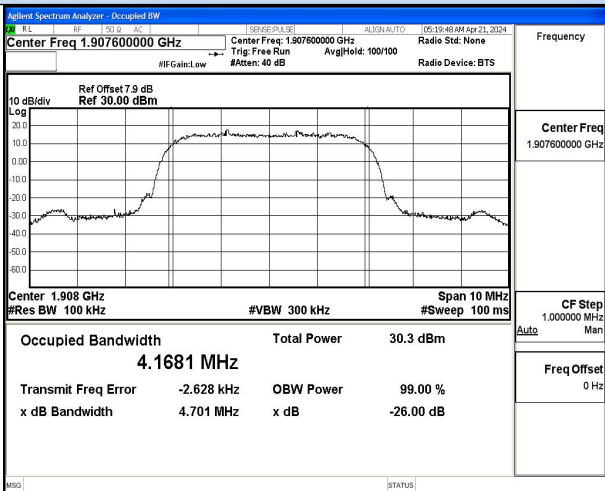

Channel 4182 / 836.4 MHz

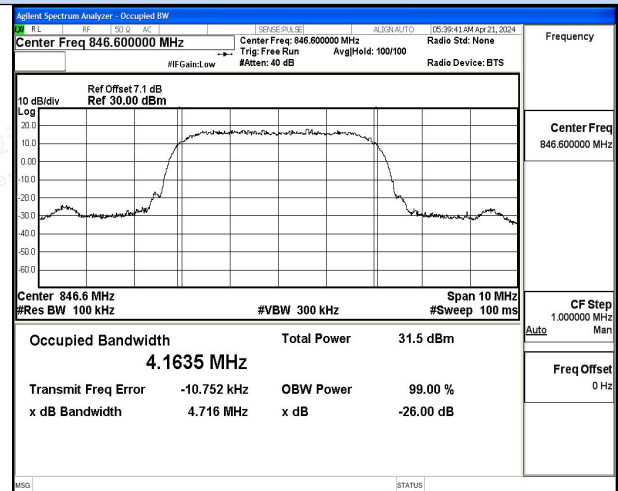

Channel 9538 / 1907.6 MHz

Channel 4233 / 846.6 MHz



Shenzhen LCS Compliance Testing Laboratory Ltd.

Add: 101, 201 Bldg A & 301 Bldg C, Juji Industrial Park Yabianxueziwei, Shajing Street, Baoan District, Shenzhen, 518000, China

Tel: +(86) 0755-82591330 | E-mail: webmaster@lcs-cert.com | Web: www.lcs-cert.com

Scan code to check authenticity



Occupied Bandwidth and Emission Bandwidth

UMTS/TM1/ WCDMA Band IV

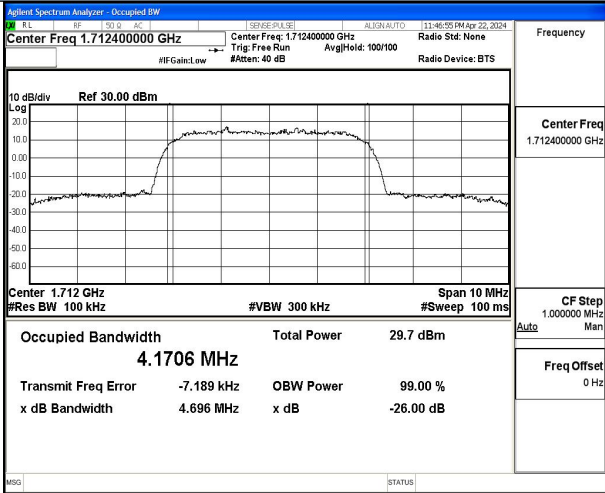

Channel 1312 / 1712.4 MHz

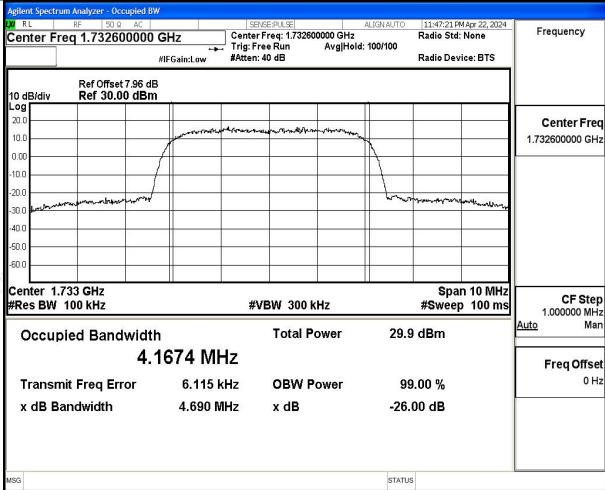

Channel 1413 / 1732.6 MHz

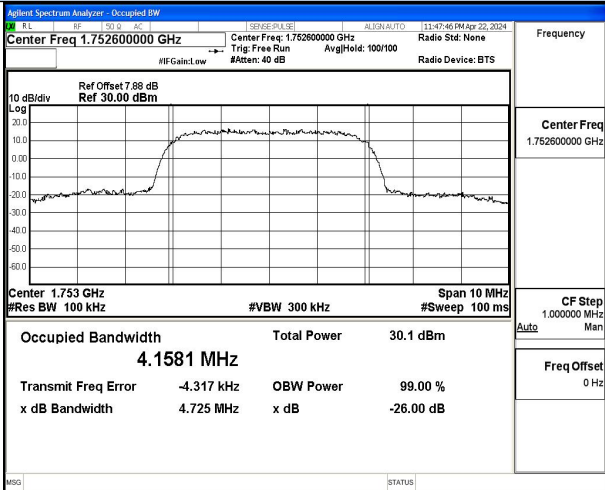

Channel 1513 / 1752.6 MHz



Shenzhen LCS Compliance Testing Laboratory Ltd.

Add: 101, 201 Bldg A & 301 Bldg C, Juji Industrial Park Yabianxueziwei, Shajing Street, Baoan District, Shenzhen, 518000, China

Tel: +(86) 0755-82591330 | E-mail: webmaster@lcs-cert.com | Web: www.lcs-cert.com

Scan code to check authenticity



4.4 Band Edge Compliance

TEST APPLICABLE

During the process of testing, the EUT was controlled via R&S WIDEBAND RADIO COMMUNICATION TESTER (CMW 500) to ensure max power transmission and proper modulation.

TEST CONFIGURATION

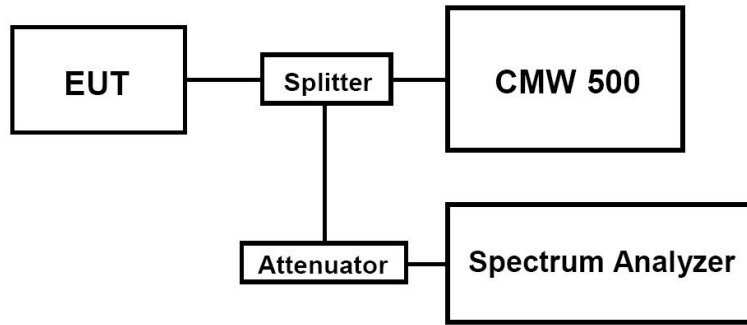

TEST PROCEDURE

1. The EUT was set up for the max output power with pseudo random data modulation;
 2. The power was measured with Spectrum Analyzer N9020A;
 3. Set RBW=100KHz,VBW=300KHz,Span=2MHz,SWT=Auto,Dector: RMS;
- These measurements were done at 2 frequencies for WCDMA band II/IV/V. (low and high of operational frequency range).

TEST RESULTS

UMTS/TM1/WCDMA Band II					
Test Mode	Channel	Frequency (MHz)	Band Edge Compliance (dBm)	Limits (dBm)	Verdict
UMTS/TM1/WCDMA Band II	9262	1852.4	<-13dBm	-13dBm	PASS
	9538	1907.6	<-13dBm	-13dBm	
UMTS/TM1/WCDMA Band V					
Test Mode	Channel	Frequency (MHz)	Band Edge Compliance (dBm)	Limits (dBm)	Verdict
UMTS/TM1/WCDMA Band V	4132	826.4	<-13dBm	-13dBm	PASS
	4233	846.6	<-13dBm	-13dBm	
UMTS/TM1/WCDMA Band IV					
Test Mode	Channel	Frequency (MHz)	Band Edge Compliance (dBm)	Limits (dBm)	Verdict
UMTS/TM1/WCDMA Band IV	1312	1712.4	<-13dBm	-13dBm	PASS
	1513	1752.6	<-13dBm	-13dBm	

Remark:

1. Test results including cable loss;
2. Please refer to following plots;





Band-edge Compliance

UMTS/TM1/WCDMA Band II

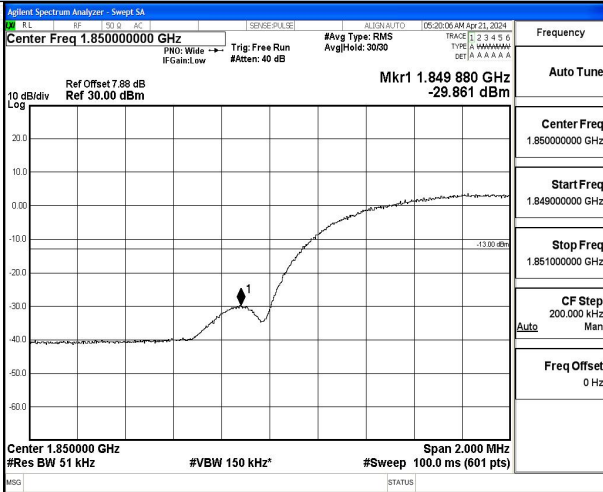

UMTS/TM1/WCDMA Band V

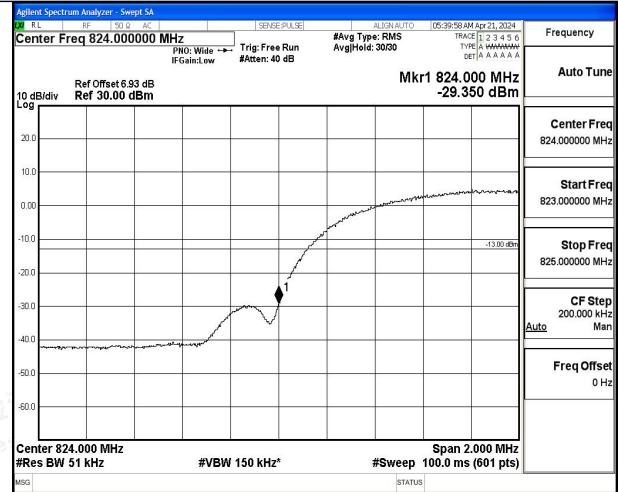

Channel 9262 / 1852.4 MHz

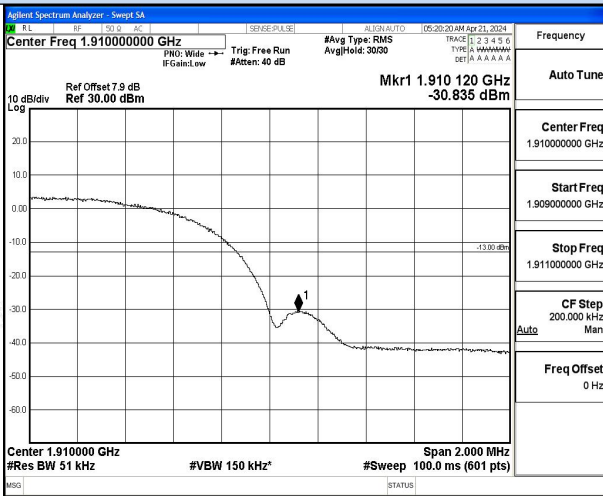

Channel 4132 / 826.4 MHz

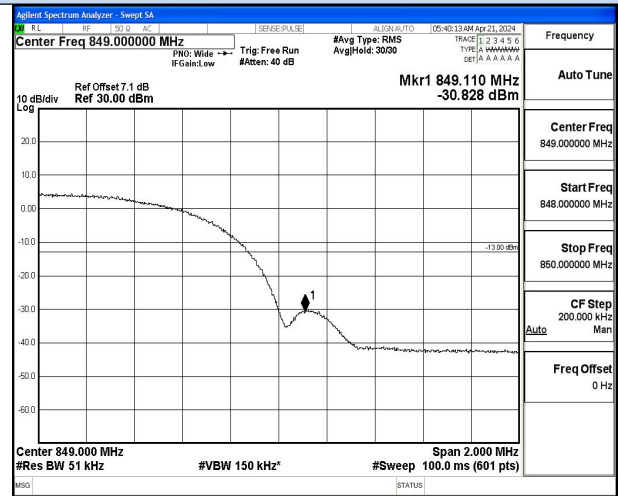

Channel 9538 / 1907.6 MHz UMTS/TM1/WCDMA Band IV

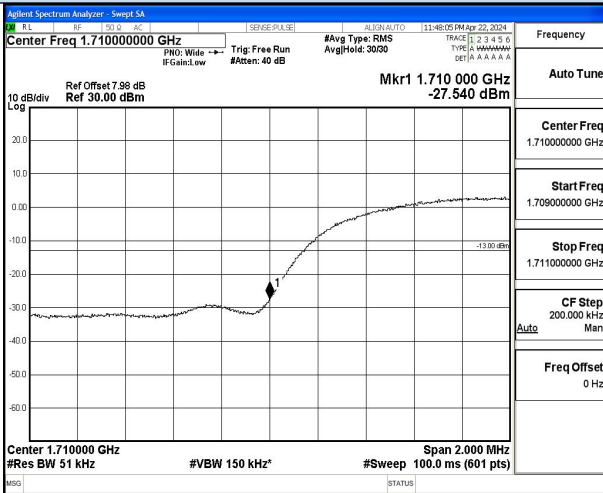

Channel 4233 / 846.6 MHz UMTS/TM1/WCDMA Band IV

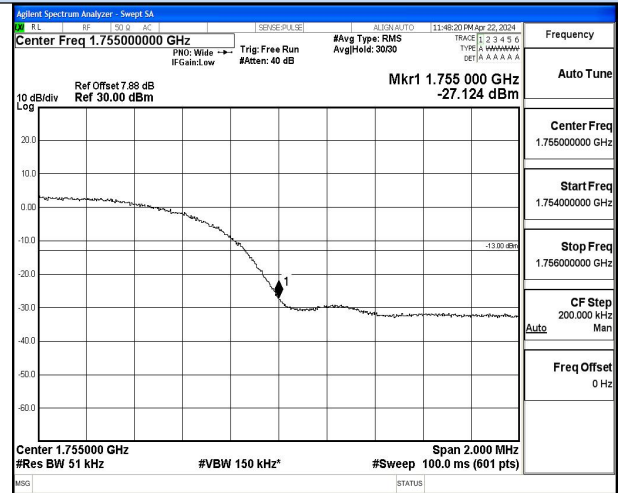

Channel 1312 / 1712.4 MHz

Channel 1513 / 1752.6 MHz



Shenzhen LCS Compliance Testing Laboratory Ltd.

Add: 101, 201 Bldg A & 301 Bldg C, Juji Industrial Park Yabianxueziwei, Shajing Street, Baoan District, Shenzhen, 518000, China

Tel: +(86) 0755-82591330 | E-mail: webmaster@lcs-cert.com | Web: www.lcs-cert.com

Scan code to check authenticity



4.5 Spurious Emission on Antenna Port

TEST APPLICABLE

The following steps outline the procedure used to measure the conducted emissions from the EUT.

1. Determine frequency range for measurements: From CFR 2.1057 the spectrum should be investigated from the lowest radio frequency generated in the equipment up to at least the 10th harmonic of the carrier frequency. For the equipment of WCDMA band II, this equates to a frequency range of 9 KHz to 19GHz, data taken from 30 MHz to 19 GHz. For WCDMA Band V, this equates to a frequency range of 9 KHz to 9 GHz, data taken from 30 MHz to 9 GHz. For WCDMA Band IV, this equates to a frequency range of 9 KHz to 18 GHz, data taken from 30 MHz to 18GHz.
2. The sweep time is set automatically by instrument itself. That should be the optimal sweep time for the span and the RBW. If the sweep time is too short, that is sweep is too fast, the sweep result is not accurate; if the sweep time is too long, that is sweep is too low, some frequency components may be lost. The instrument will give an optimal sweep time according the selected span and RBW.
3. The procedure to get the conducted spurious emission is as follows:
The trace mode is set to MaxHold to get the highest signal at each frequency;
Wait 25 seconds;
Get the result.
4. Determine EUT transmit frequencies: below outlines the band edge frequencies pertinent to conducted emissions testing.

TEST CONFIGURATION

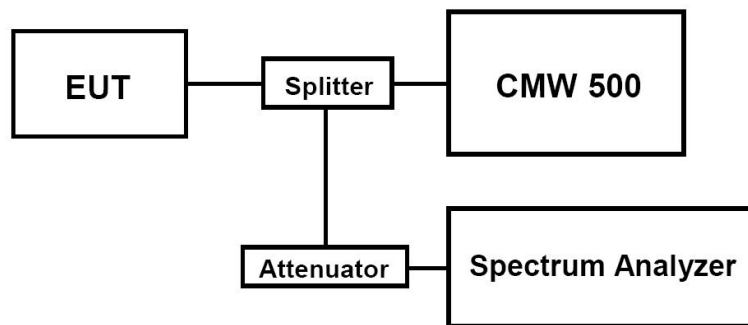

TEST PROCEDURE

1. The EUT was set up for the max output power with pseudo random data modulation;
2. The power was measured with Spectrum Analyzer N9020A;
3. These measurements were done at 3 frequencies for WCDMA band II/IV/V. (low, middle and high of operational frequency range).

TEST LIMIT

Part 24.238, Part 22.917, Part 27.53, specify that the power of any emission outside of the authorized operating frequency ranges must be attenuated below the transmitting power (P) by a factor of at least $43 + 10 \log(P)$ dB. The specification that emissions shall be attenuated below the transmitter power (P) by at least $43 + 10 \log(P)$ dB, translates in the relevant power range (1 to 0.001 W) to -13 dBm. At 1 W the specified minimum attenuation becomes 43 dB and relative to a 30 dBm (1 W) carrier becomes a limit of -13 dBm. At 0.001 W (0 dBm) the minimum attenuation is 13 dB, which again yields a limit of -13 dBm. In this way a translation of the specification from relative to absolute terms is carried out.





TEST RESULTS

Test Mode	Channel	Frequency (MHz)	Spurious RF Conducted Emission (dBm)	Limits (dBm)	Verdict
UMTS/TM1/WCDMA Band II	9262	1852.4	<-13dBm	-13dBm	PASS
	9400	1880.0	<-13dBm	-13dBm	
	9538	1907.6	<-13dBm	-13dBm	
UMTS/TM1/WCDMA Band V	4132	826.4	<-13dBm	-13dBm	PASS
	4182	836.4	<-13dBm	-13dBm	
	4233	846.6	<-13dBm	-13dBm	
UMTS/TM1/WCDMA Band IV	1312	1712.4	<-13dBm	-13dBm	PASS
	1413	1732.6	<-13dBm	-13dBm	
	1513	1752.6	<-13dBm	-13dBm	

Remark:

1. Test results including cable loss;
2. Please refer to following plots;
3. Not reorded test plots from 9 KHz to 30 MHz as emission levels 20dB lower than emission limit;

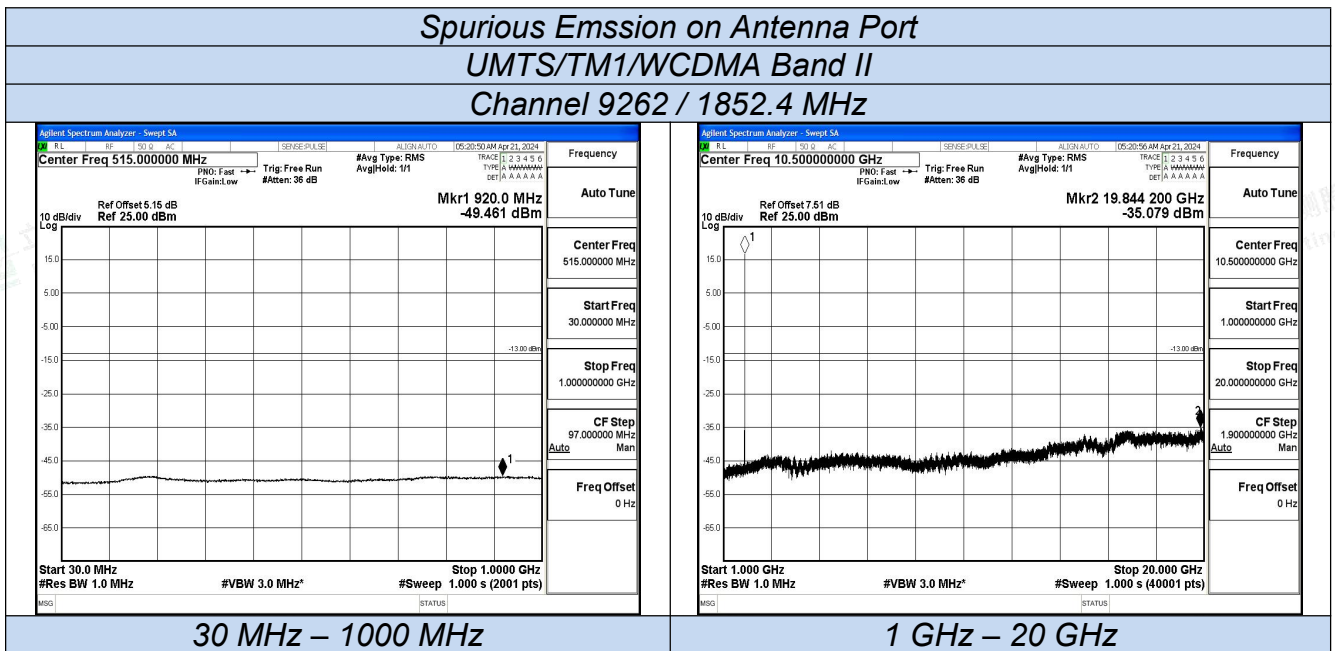



Spurious Emission on Antenna Port UMTS/TM1/WCDMA Band II Channel 9400 / 1880 MHz

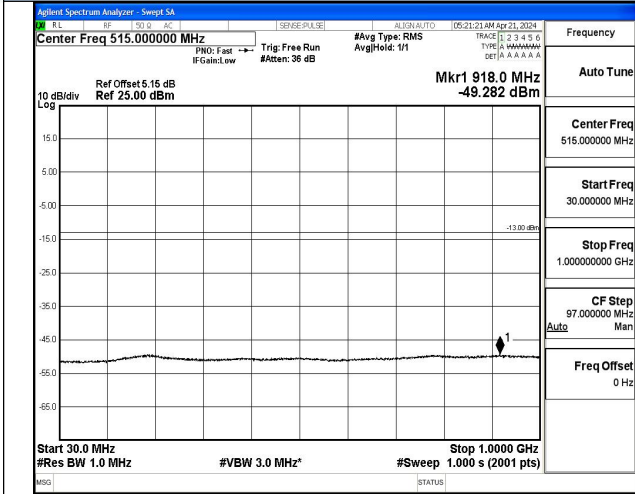

30 MHz – 1000 MHz

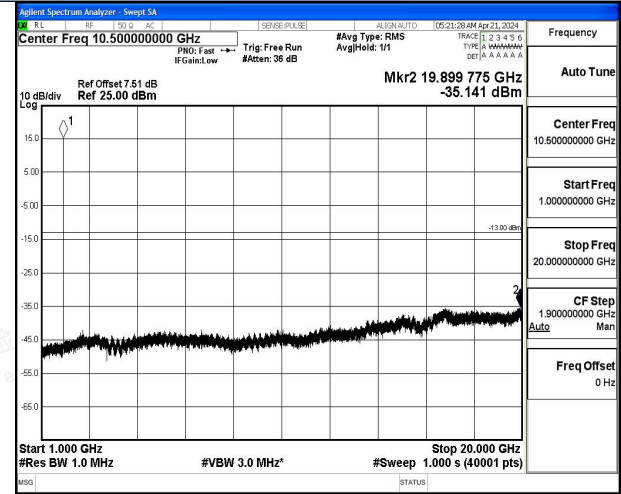

1 GHz – 20 GHz

Spurious Emission on Antenna Port UMTS/TM1/WCDMA Band II Channel 9538 / 1907.6 MHz

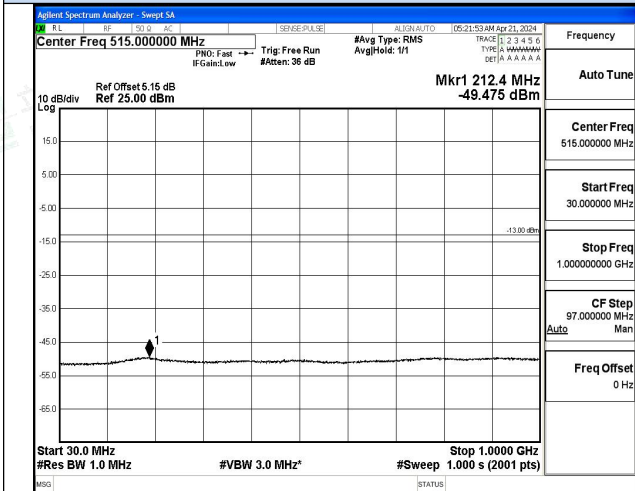

30 MHz – 1000 MHz

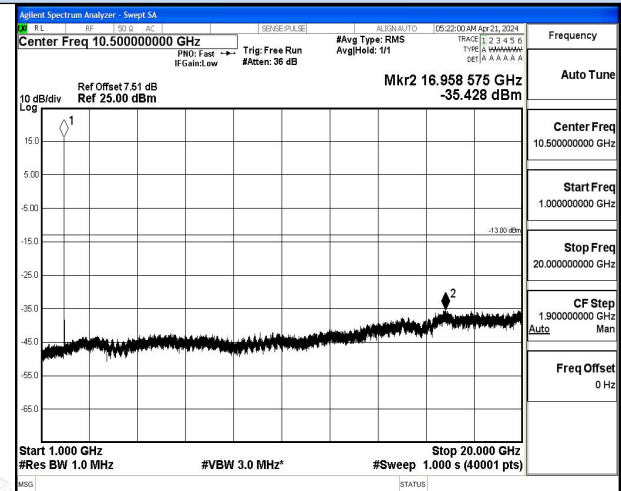

1 GHz – 20 GHz



Shenzhen LCS Compliance Testing Laboratory Ltd.

Add: 101, 201 Bldg A & 301 Bldg C, Juji Industrial Park Yabianxueziwei, Shajing Street, Baoan District, Shenzhen, 518000, China

Tel: +(86) 0755-82591330 | E-mail: webmaster@lcs-cert.com | Web: www.lcs-cert.com

Scan code to check authenticity





Spurious Emission on Antenna Port UMTS/TM1/WCDMA Band V

Channel 4132 / 826.4 MHz

Channel 4182 / 836.4 MHz

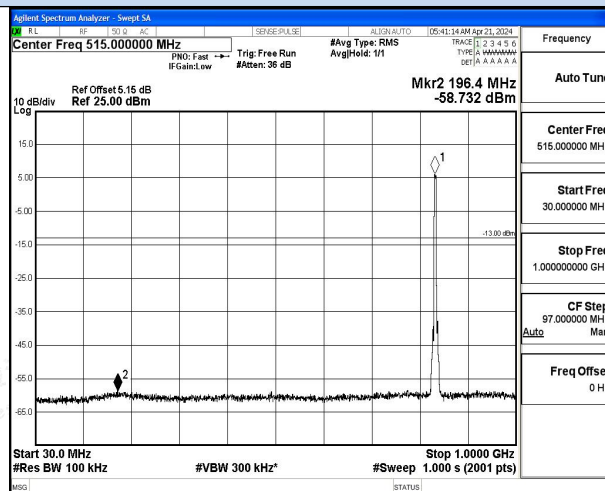
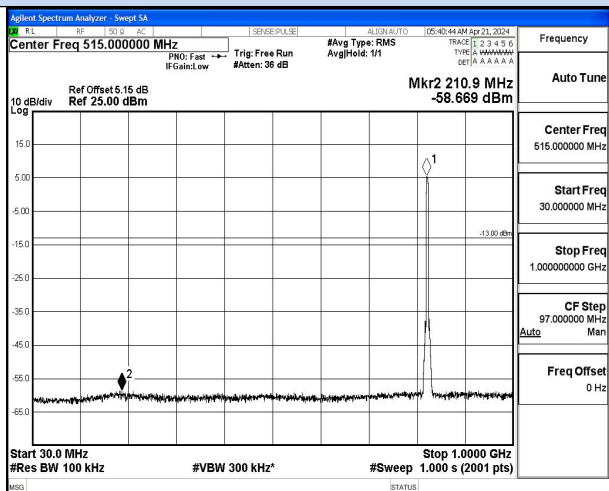

30 MHz – 1000 MHz

30 MHz – 1000 MHz

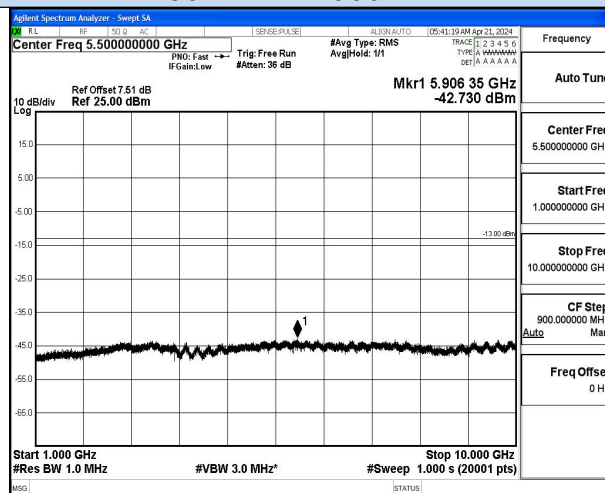
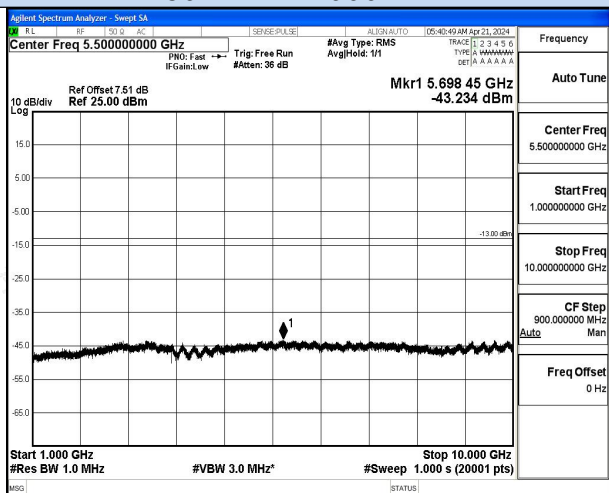

1 GHz – 10 GHz

1 GHz – 10 GHz





Spurious Emission on Antenna Port

UMTS/TM1/WCDMA Band V

Channel 4233 / 846.6 MHz

Channel 4233 / 846.6 MHz

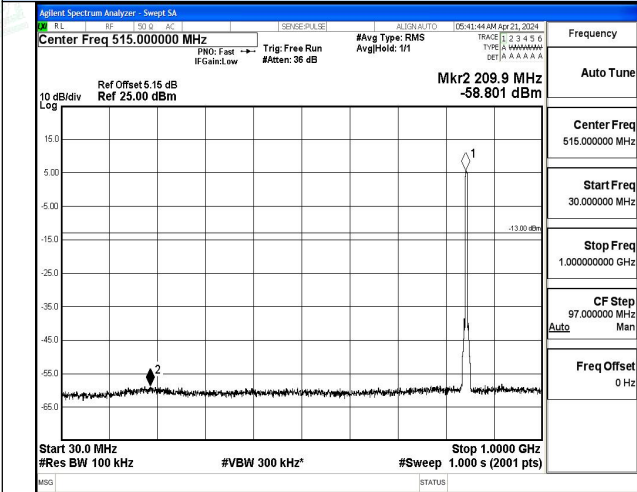

30 MHz – 1000 MHz

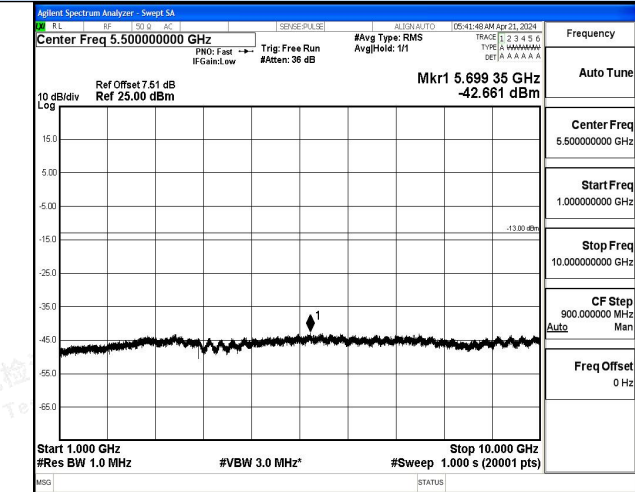

1 GHz – 10 GHz

Spurious Emission on Antenna Port

UMTS/TM1/WCDMA Band IV

Channel 1312 / 1712.4 MHz

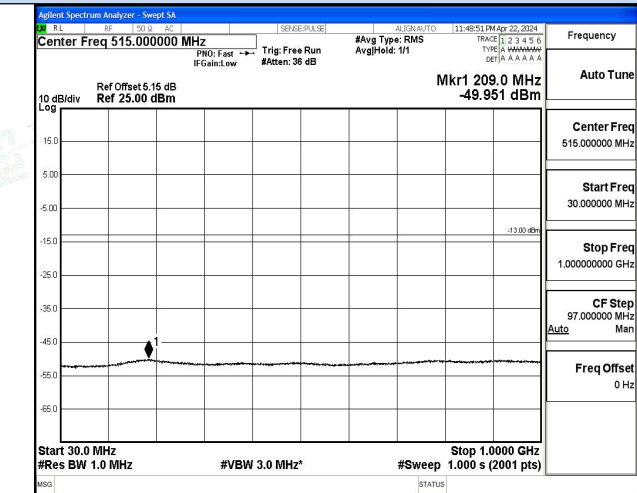

30 MHz – 1000 MHz

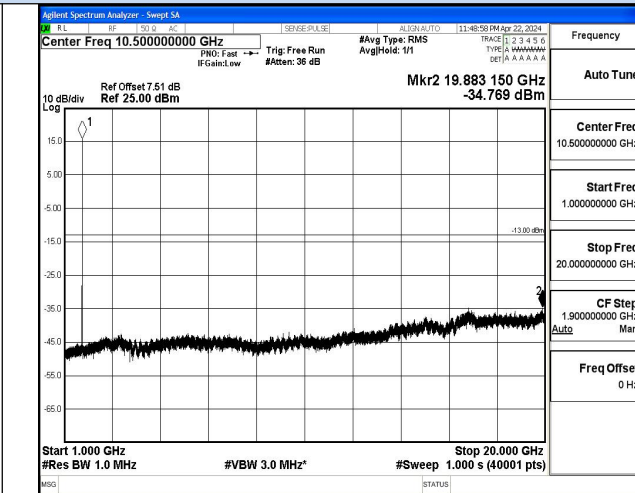

1 GHz – 20 GHz



Shenzhen LCS Compliance Testing Laboratory Ltd.

Add: 101, 201 Bldg A & 301 Bldg C, Juji Industrial Park Yabianxueziwei, Shajing Street, Baoan District, Shenzhen, 518000, China

Tel: +(86) 0755-82591330 | E-mail: webmaster@lcs-cert.com | Web: www.lcs-cert.com

Scan code to check authenticity



Spurious Emission on Antenna Port UMTS/TM1/WCDMA Band IV Channel 1413 / 1732.6 MHz

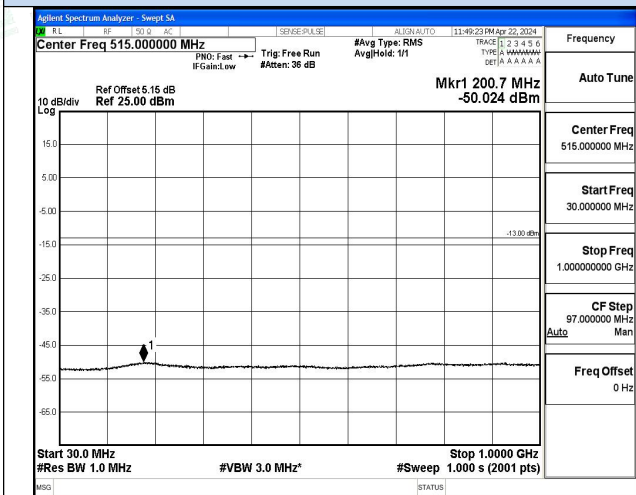

30 MHz – 1000 MHz

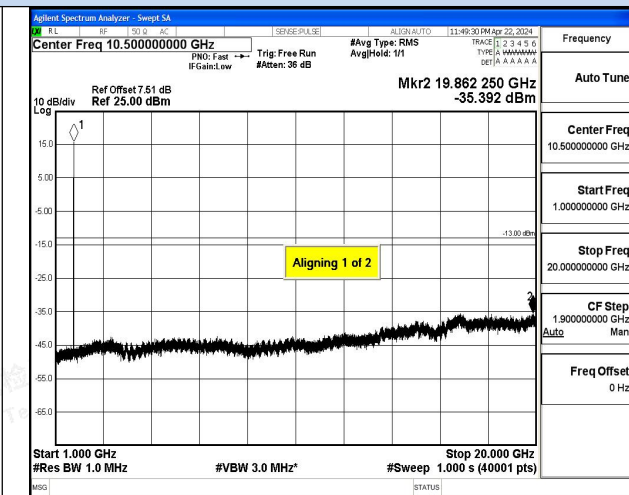

1 GHz – 20 GHz

Spurious Emission on Antenna Port UMTS/TM1/WCDMA Band IV Channel 1513 / 1752.6 MHz

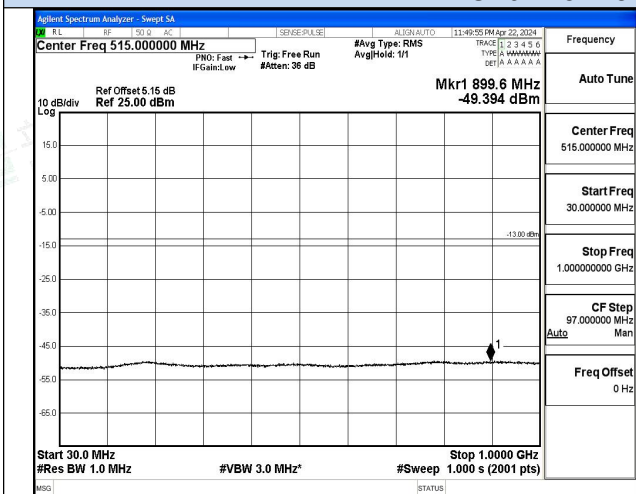

30 MHz – 1000 MHz

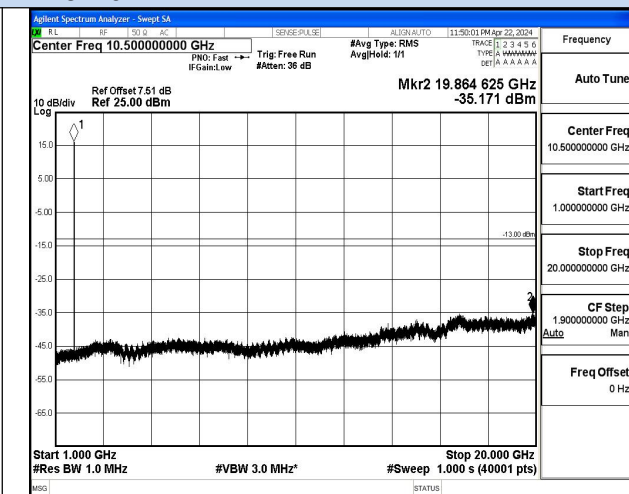

1 GHz – 20 GHz



Shenzhen LCS Compliance Testing Laboratory Ltd.

Add: 101, 201 Bldg A & 301 Bldg C, Juji Industrial Park Yabianxueziwei, Shajing Street, Baoan District, Shenzhen, 518000, China

Tel: +(86) 0755-82591330 | E-mail: webmaster@lcs-cert.com | Web: www.lcs-cert.com

Scan code to check authenticity





4.6 Frequency Stability Test

TEST APPLICABLE

1. According to FCC Part 2 Section 2.1055 (a)(1), the frequency stability shall be measured with variation of ambient temperature from -30°C to $+50^{\circ}\text{C}$ centigrade.
2. According to FCC Part 2 Section 2.1055 (e)(2), for battery powered equipment, the frequency stability shall be measured with reducing primary supply voltage to the battery operating end point, which is specified by the manufacture.
3. Vary primary supply voltage from 85 to 115 percent of the nominal value for other than hand carried voltage equipment and the end voltage point was 3.3V.

TEST PROCEDURE

In order to measure the carrier frequency under the condition of AFC lock, it is necessary to make measurements with the EUT in a "call mode". This is accomplished with the use of R&S WIDEBAND RADIO COMMUNICATION TESTER (CMW 500).

1. Measure the carrier frequency at room temperature;
2. Subject the EUT to overnight soak at -30°C ;
3. With the EUT, powered via nominal voltage, connected to the CMW 500 and in a simulated call on middle channel of WCDMA band II/IV/V, measure the carrier frequency. These measurements should be made within 2 minutes of Powering up the EUT, to prevent significant self-warming;
4. Repeat the above measurements at 10°C increments from -30°C to $+50^{\circ}\text{C}$. Allow at least 0.5 hours at each temperature, unpowered, before making measurements;
5. Remeasure carrier frequency at room temperature with nominal voltage. Vary supply voltage from minimum voltage to maximum voltage, in 0.1Volt increments remeasuring carrier frequency at each voltage. Pause at nominal voltage for 0.5 hours unpowered, to allow any self-heating to stabilize, before continuing;
6. Subject the EUT to overnight soak at $+50^{\circ}\text{C}$;
7. With the EUT, powered via nominal voltage, connected to the CMW 500 and in a simulated call on the centre channel, measure the carrier frequency. These measurements should be made within 2 minutes of Powering up the EUT, to prevent significant self-warming;
8. Repeat the above measurements at 10°C increments from $+50^{\circ}\text{C}$ to -30°C . Allow at least 0.5 hours at each temperature, unpowered, before making measurements;
9. At all temperature levels hold the temperature to $\pm 0.5^{\circ}\text{C}$ during the measurement procedure;

TEST CONFIGURATION

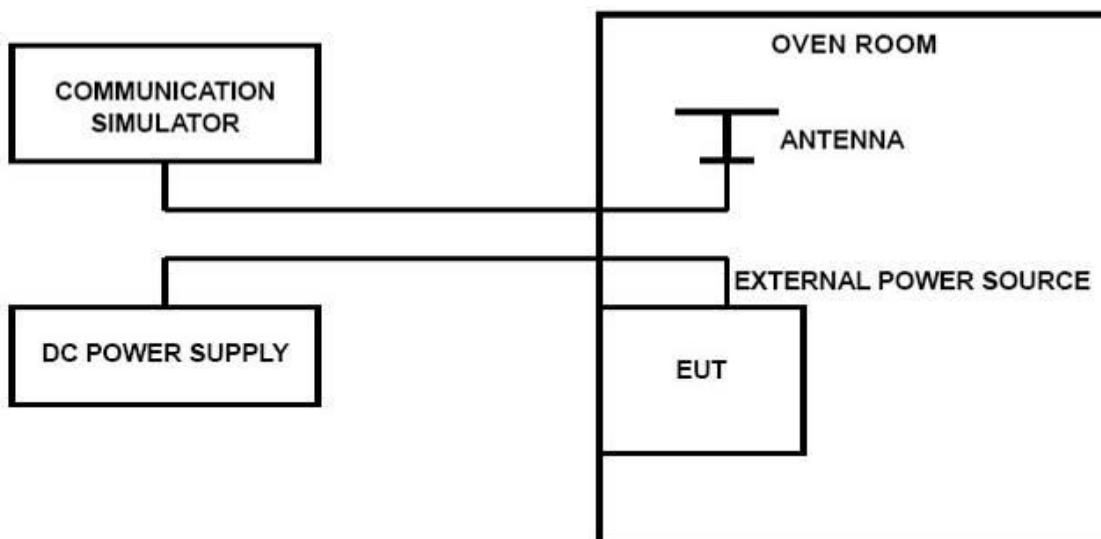

**TEST LIMITS****For Hand carried battery powered equipment**

According to the JTC standard the frequency stability of the carrier shall be accurate to within 0.1 ppm of the received frequency from the base station. This accuracy is sufficient to meet Sec. 24.235, Frequency Stability. The frequency stability shall be sufficient to ensure that the fundamental emission stays within the authorized frequency block. As this transceiver is considered "Hand carried, battery powered equipment" Section 2.1055(d)(2) applies. This requires that the lower voltage for frequency stability testing be specified by the manufacturer. This transceiver is specified to operate with an input voltage of between 3.40VDC and 4.30VDC, with a nominal voltage of 3.80DC. Operation above or below these voltage limits is prohibited by transceiver software in order to prevent improper operation as well as to protect components from overstress. These voltages represent a tolerance of -10 % and +12.5 %. For the purposes of measuring frequency stability these voltage limits are to be used.

For equipment powered by primary supply voltage

According to the JTC standard the frequency stability of the carrier shall be accurate to within 0.1 ppm of the received frequency from the base station. This accuracy is sufficient to meet Sec. 24.235, Frequency Stability. The frequency stability shall be sufficient to ensure that the fundamental emission stays within the authorized frequency block. For this EUT section 2.1055(d)(1) applies. This requires varying primary supply voltage from 85 to 115 percent of the nominal value for other than hand carried battery equipment.

TEST RESULTS

UMTS/TM1/WCDMA Band II					
DC Power	Temperature (°C)	Frequency error(Hz)	Frequency error(ppm)	Limit (ppm)	Verdict
VL	25	19	0.010	2.50	PASS
VN	25	-1	-0.001	2.50	PASS
VH	25	-18	-0.010	2.50	PASS
VN	-30	13	0.007	2.50	PASS
VN	-20	-19	-0.010	2.50	PASS
VN	-10	18	0.010	2.50	PASS
VN	0	-6	-0.003	2.50	PASS
VN	10	10	0.005	2.50	PASS
VN	20	7	0.004	2.50	PASS
VN	30	17	0.009	2.50	PASS
VN	40	-9	-0.005	2.50	PASS
VN	50	-11	-0.006	2.50	PASS

UMTS/TM1/WCDMA Band V					
DC Power	Temperature (°C)	Frequency error(Hz)	Frequency error(ppm)	Limit (ppm)	Verdict
VL	25	16	0.019	2.50	PASS
VN	25	18	0.022	2.50	PASS
VH	25	-10	-0.012	2.50	PASS
VN	-30	-6	-0.007	2.50	PASS
VN	-20	8	0.010	2.50	PASS
VN	-10	14	0.017	2.50	PASS
VN	0	1	0.001	2.50	PASS
VN	10	17	0.021	2.50	PASS
VN	20	-10	-0.012	2.50	PASS
VN	30	-7	-0.008	2.50	PASS
VN	40	-8	-0.010	2.50	PASS
VN	50	-6	-0.007	2.50	PASS



Shenzhen LCS Compliance Testing Laboratory Ltd.

Add: 101, 201 Bldg A & 301 Bldg C, Juji Industrial Park Yabianxueziwei, Shajing Street, Baoan District, Shenzhen, 518000, China

Tel: +(86) 0755-82591330 | E-mail: webmaster@lcs-cert.com | Web: www.lcs-cert.com

Scan code to check authenticity



UMTS/TM1/WCDMA Band IV					
DC Power	Temperature (°C)	Frequency error(Hz)	Frequency error(ppm)	Limit (ppm)	Verdict
VL	25	20	0.011	±2.50	PASS
VN	25	-15	-0.009	±2.50	PASS
VH	25	-14	-0.008	±2.50	PASS
VN	-30	15	0.009	±2.50	PASS
VN	-20	8	0.005	±2.50	PASS
VN	-10	-19	-0.011	±2.50	PASS
VN	0	-8	-0.005	±2.50	PASS
VN	10	7	0.004	±2.50	PASS
VN	20	6	0.003	±2.50	PASS
VN	30	9	0.005	±2.50	PASS
VN	40	-7	-0.004	±2.50	PASS
VN	50	-11	-0.006	±2.50	PASS





4.7 Peak-to-Average Ratio (PAR)

LIMIT

The Peak-to-Average Ratio (PAR) of the transmission may not exceed 13 dB.

TEST CONFIGURATION

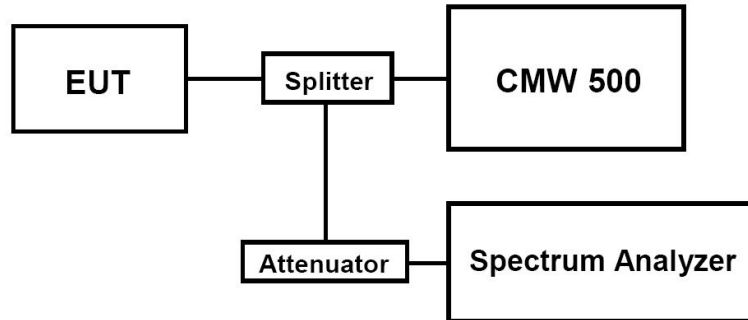

TEST PROCEDURE

1. Refer to instrument's analyzer instruction manual for details on how to use the power statistics/CCDF function;
2. Set resolution/measurement bandwidth \geq signal's occupied bandwidth;
3. Set the number of counts to a value that stabilizes the measured CCDF curve;
4. Set the measurement interval as follows:
 - 1). for continuous transmissions, set to 1 ms,
 - 2). for burst transmissions, employ an external trigger that is synchronized with the EUT burst timing sequence, or use the internal burst trigger with a trigger level that allows the burst to stabilize and set the measurement interval to a time that is less than or equal to the burst duration.
5. Record the maximum PAPR level associated with a probability of 0.1%.

TEST RESULTS

Test Mode	Channel	Frequency (MHz)	PAPR Value (dB)	Limits (dB)	Verdict
UMTS/TM1/ WCDMA Band II	9262	1852.4	2.96	13.0	PASS
	9400	1880.0	3.03	13.0	PASS
	9538	1907.6	2.99	13.0	PASS
UMTS/TM1/ WCDMA Band V	4132	826.4	2.94	13.0	PASS
	4182	836.4	2.94	13.0	PASS
	4233	846.6	2.97	13.0	PASS
UMTS/TM1/ WCDMA Band IV	1312	1712.4	2.63	13.0	PASS
	1413	1732.6	2.85	13.0	PASS
	1513	1752.6	2.66	13.0	PASS

Remark:

1. Test results including cable loss;
2. Please refer to following plots;



Shenzhen LCS Compliance Testing Laboratory Ltd.

Add: 101, 201 Bldg A & 301 Bldg C, Juji Industrial Park Yabianxueziwei, Shajing Street, Baoan District, Shenzhen, 518000, China

Tel: +(86) 0755-82591330 | E-mail: webmaster@lcs-cert.com | Web: www.lcs-cert.com

Scan code to check authenticity



Peak-to-Average Ratio (PAR)

UMTS/TM1/ WCDMA Band II

UMTS/TM1/ WCDMA Band V

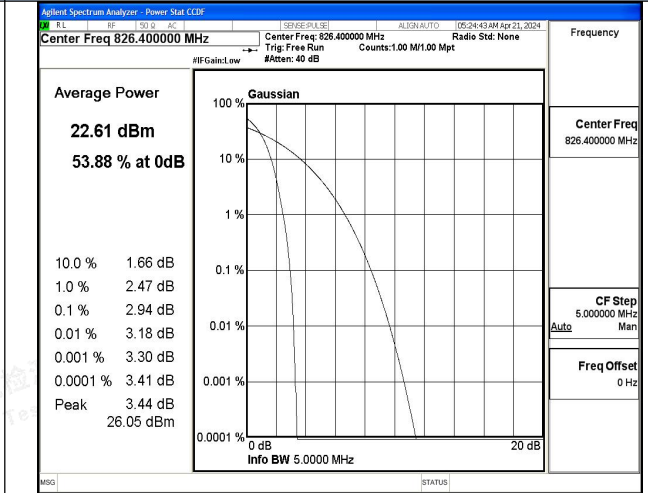
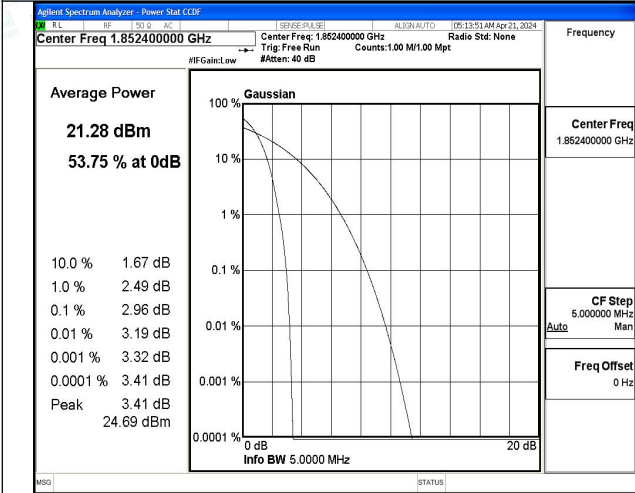

Channel 9262 / 1852.4 MHz

Channel 4132/ 826.4 MHz

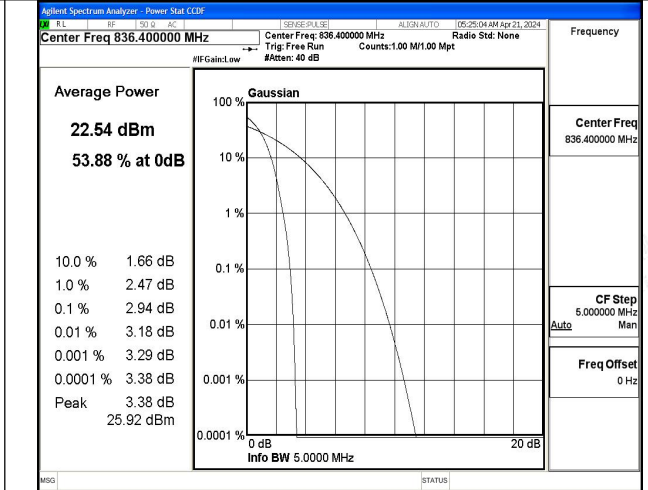
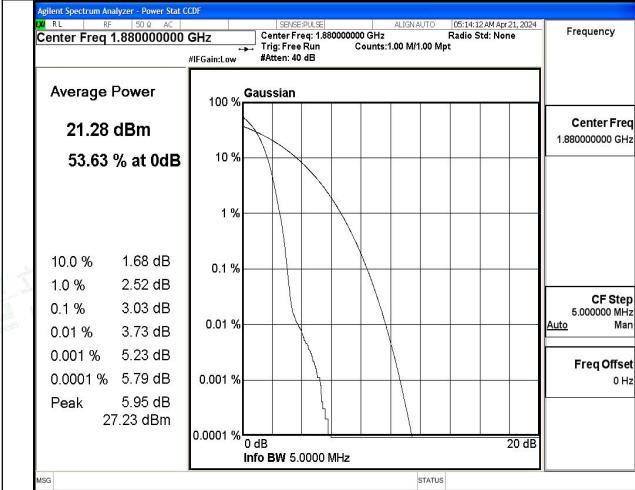

Channel 9400 / 1880.0 MHz

Channel 4182/ 836.4 MHz

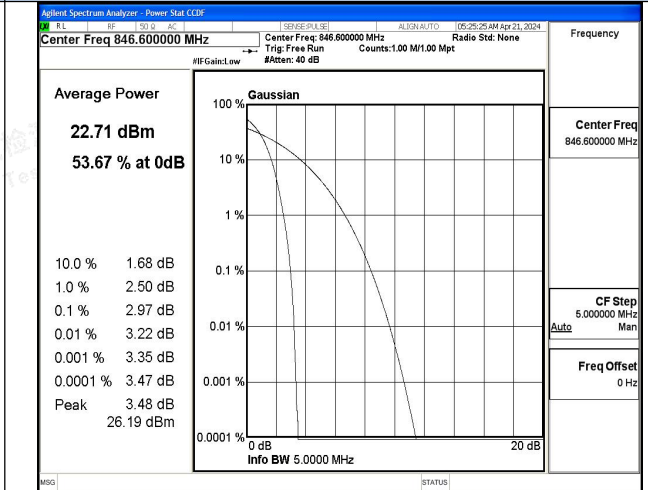
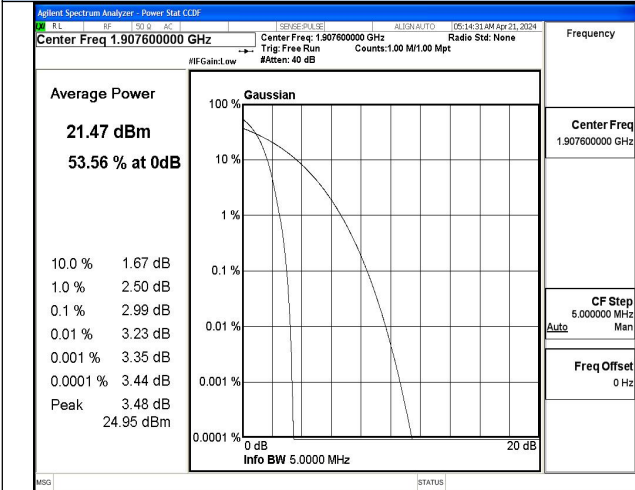

Channel 9538 / 1907.6 MHz

Channel 4233/ 846.6 MHz



Shenzhen LCS Compliance Testing Laboratory Ltd.

Add: 101, 201 Bldg A & 301 Bldg C, Juji Industrial Park Yabianxueziwei, Shajing Street, Baoan District, Shenzhen, 518000, China

Tel: +(86) 0755-82591330 | E-mail: webmaster@lcs-cert.com | Web: www.lcs-cert.com

Scan code to check authenticity



Peak-to-Average Ratio (PAR)

UMTS/TM1/ WCDMA Band IV

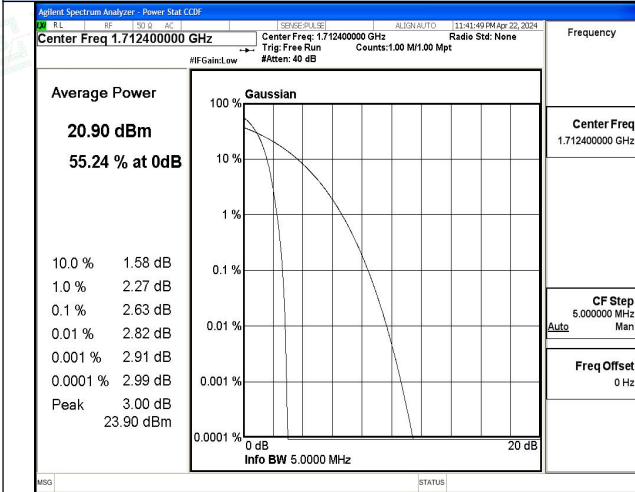

Channel 1312 / 1712.4 MHz

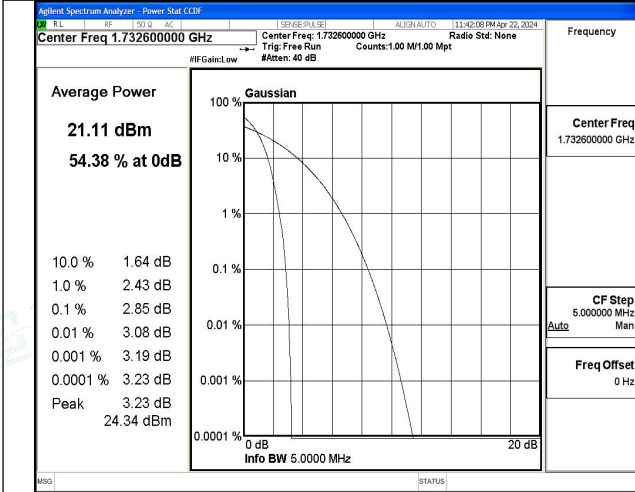

Channel 1413 / 1732.6 MHz

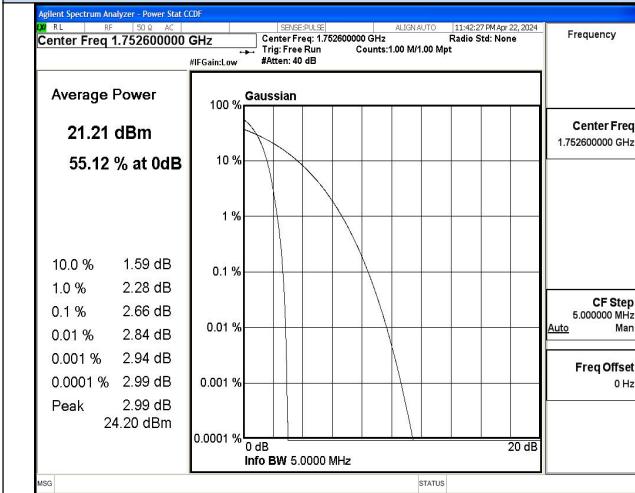

Channel 1513 / 1752.6 MHz





5 Test Setup Photos of the EUT

Please refer to separated files for Test Setup Photos of the EUT.

6 External Photos of the EUT

Please refer to separated files for External Photos of the EUT.

7 Internal Photos of the EUT

Please refer to separated files for Internal Photos of the EUT.

-----THE END OF TEST REPORT-----

