

---

# SAR Test Report

---

Report No.: AGC14246231202FH01

**FCC ID** : 2ADLJ-HD68

**APPLICATION PURPOSE** : Original Equipment

**PRODUCT DESIGNATION** : Smartphone

**BRAND NAME** : VORTEX

**MODEL NAME** : VORTEX HD68

**APPLICANT** : Xwireless LLC.

**DATE OF ISSUE** : Jan. 17, 2024

**STANDARD(S)** : IEEE Std. 1528:2013  
FCC 47 CFR Part 2§2.1093  
IEEE Std C95.1™-2005

**REPORT VERSION** : V1.0

Attestation of Global Compliance (Shenzhen) Co., Ltd.



Any report having not been signed by authorized approver, or having been altered without authorization, or having not been stamped by the "Dedicated Testing/Inspection Stamp" is deemed to be invalid. Copying or excerpting portion of, or altering the content of the report is not permitted without the written authorization of AGC. The test results presented in the report apply only to the tested sample. Any objections to report issued by AGC should be submitted to AGC within 15days after the issuance of the test report. Further enquiry of validity or verification of the test report should be addressed to AGC by [agc01@agccert.com](mailto:agc01@agccert.com).

Attestation of Global Compliance(Shenzhen)Co., Ltd  
Attestation of Global Compliance(Shenzhen)Std & Tech Co., Ltd  
Tel: +86-755 2523 4088 E-mail: [agc@agccert.com](mailto:agc@agccert.com) Web: <http://www.agccert.com/>



### Report Revise Record

Report Version	Revise Time	Issued Date	Valid Version	Notes
V1.0	/	Jan. 17, 2024	Valid	Initial Release

Any report having not been signed by authorized approver, or having been altered without authorization, or having not been stamped by the "Dedicated Testing/Inspection Stamp" is deemed to be invalid. Copying or excerpting portion of, or altering the content of the report is not permitted without the written authorization of AGC. The test results presented in the report apply only to the tested sample. Any objections to report issued by AGC should be submitted to AGC within 15days after the issuance of the test report. Further enquiry of validity or verification of the test report should be addressed to AGC by [agc01@agccert.com](mailto:agc01@agccert.com).

Attestation of Global Compliance(Shenzhen)Co., Ltd  
Attestation of Global Compliance(Shenzhen)Std & Tech Co., Ltd  
Tel: +86-755 2523 4088 E-mail: [agc@agccert.com](mailto:agc@agccert.com) Web: <http://www.agccert.com/>

Test Report	
Applicant Name	Xwireless LLC.
Applicant Address	11565 Old Georgetown Road, Rockville, MD, USA
Manufacturer Name	Xwireless LLC.
Manufacturer Address	11565 Old Georgetown Road, Rockville, MD, USA
Factory Name	Ebot Digital Technology Co., Limited
Factory Address	A403, Comprehensive R&D Building, Suojia Science and Technology Park, Hangkong Road, Xixiang, Bao 'an District, Shenzhen, Guangdong
Product Designation	Smartphone
Brand Name	VORTEX
Model Name	VORTEX HD68
EUT Voltage	DC3.85V by battery
Applicable Standard	IEEE Std. 1528:2013 FCC 47 CFR Part 2§2.1093 IEEE Std C95.1™-2005
Date of receipt of test item	Dec. 28, 2023
Test Date	Jan. 03, 2024 to Jan. 08, 2024
Report Template	AGCRT-US-4G/SAR (2021-04-20)

Note: The results of testing in this report apply to the product/system which was tested only.

  
 Prepared By \_\_\_\_\_  
 Jack Gui(Project Engineer) Jan. 17, 2024

  
 Reviewed By \_\_\_\_\_  
 Calvin Liu (Reviewer) Jan. 17, 2024

  
 Approved By \_\_\_\_\_  
 Max Zhang (Authorized Officer) Jan. 17, 2024

Any report having not been signed by authorized approver, or having been altered without authorization, or having not been stamped by the "Dedicated Testing/Inspection Stamp" is deemed to be invalid. Copying or excerpting portion of, or altering the content of the report is not permitted without the written authorization of AGC. The test results presented in the report apply only to the tested sample. Any objections to report issued by AGC should be submitted to AGC within 15days after the issuance of the test report. Further enquiry of validity or verification of the test report should be addressed to AGC by agc01@agccert.com.

## TABLE OF CONTENTS

<b>1. SUMMARY OF MAXIMUM SAR VALUE .....</b>	<b>5</b>
<b>2. GENERAL INFORMATION .....</b>	<b>6</b>
2.1. EUT DESCRIPTION .....	6
<b>3. SAR MEASUREMENT SYSTEM .....</b>	<b>8</b>
3.1. THE SATIMO SYSTEM USED FOR PERFORMING COMPLIANCE TESTS CONSISTS OF FOLLOWING ITEMS .....	8
3.2. COMOSAR E-FIELD PROBE .....	9
3.3. ROBOT .....	9
3.4. VIDEO POSITIONING SYSTEM .....	10
3.5. DEVICE HOLDER .....	10
3.6. SAM TWIN PHANTOM .....	11
<b>4. SAR MEASUREMENT PROCEDURE .....</b>	<b>12</b>
4.1. SPECIFIC ABSORPTION RATE (SAR) .....	12
4.2. SAR MEASUREMENT PROCEDURE .....	13
4.3. RF EXPOSURE CONDITIONS .....	15
<b>5. TISSUE SIMULATING LIQUID .....</b>	<b>16</b>
5.1. THE COMPOSITION OF THE TISSUE SIMULATING LIQUID .....	16
5.2. TISSUE DIELECTRIC PARAMETERS FOR HEAD AND BODY PHANTOMS .....	17
5.3. TISSUE CALIBRATION RESULT .....	18
<b>6. SAR SYSTEM CHECK PROCEDURE .....</b>	<b>20</b>
6.1. SAR SYSTEM CHECK PROCEDURES .....	20
6.2. SAR SYSTEM CHECK .....	21
<b>7. EUT TEST POSITION .....</b>	<b>23</b>
7.1. DEFINE TWO IMAGINARY LINES ON THE HANDSET .....	23
7.2. CHEEK POSITION .....	24
7.3. TILT POSITION .....	24
7.4. BODY WORN POSITION .....	25
<b>8. SAR EXPOSURE LIMITS .....</b>	<b>26</b>
<b>9. TEST FACILITY .....</b>	<b>27</b>
<b>10. TEST EQUIPMENT LIST .....</b>	<b>28</b>
<b>11. MEASUREMENT UNCERTAINTY .....</b>	<b>29</b>
<b>12. CONDUCTED POWER MEASUREMENT .....</b>	<b>32</b>
<b>13. TEST RESULTS .....</b>	<b>73</b>
13.1. SAR TEST RESULTS SUMMARY .....	73
<b>APPENDIX A. SAR SYSTEM CHECK DATA .....</b>	<b>130</b>
<b>APPENDIX B. SAR MEASUREMENT DATA .....</b>	<b>142</b>
<b>APPENDIX C. TEST SETUP PHOTOGRAPHS .....</b>	<b>224</b>
<b>APPENDIX D. CALIBRATION DATA .....</b>	<b>231</b>

Any report having not been signed by authorized approver, or having been altered without authorization, or having not been stamped by the “Dedicated Testing/Inspection Stamp” is deemed to be invalid. Copying or excerpting portion of, or altering the content of the report is not permitted without the written authorization of AGC. The test results presented in the report apply only to the tested sample. Any objections to report issued by AGC should be submitted to AGC within 15days after the issuance of the test report. Further enquiry of validity or verification of the test report should be addressed to AGC by agc01@agccert.com.

## 1. SUMMARY OF MAXIMUM SAR VALUE

The maximum results of Specific Absorption Rate (SAR) found during testing for EUT are as follows:

Frequency Band	Highest Reported 1g-SAR(W/kg)			SAR Test Limit (W/kg)
	Head	Body-worn(with 10mm separation)	Hotspot(with 10mm separation)	
GSM 850	0.336	0.619	0.619	1.6
PCS 1900	0.034	0.379	0.379	
UMTS Band II	0.100	0.775	0.775	
UMTS Band IV	0.037	0.917	0.917	
UMTS Band V	0.262	0.327	0.327	
LTE Band 2	0.105	0.978	0.978	
LTE Band 4	0.049	1.196	1.196	
LTE Band 5	0.358	0.530	0.530	
LTE Band 12	0.361	0.450	0.450	
LTE Band 13	0.153	0.208	0.208	
LTE Band 17	0.377	0.466	0.466	
LTE Band 25	0.079	0.771	0.771	
LTE Band 26a	0.403	0.556	0.556	
LTE Band 26b	0.405	0.442	0.442	
LTE Band 41	0.033	0.245	0.245	
LTE Band 66	0.039	0.710	0.710	
LTE Band 71	0.334	0.445	0.445	
WIFI 2.4G	0.041	0.125	0.125	
Simultaneous Reported SAR	1.323			
SAR Test Result	PASS			

This device is compliance with Specific Absorption Rate (SAR) for general population/uncontrolled exposure limits (1.6W/kg) specified in IEEE Std. 1528:2013; FCC 47CFR § 2.1093; IEEE/ANSI C95.1:2005 and the following specific FCC Test Procedures:

- KDB 447498 D01 General RF Exposure Guidance v06
- KDB 648474 D04 Handset SAR v01r03
- KDB 865664 D01 SAR Measurement 100MHz to 6GHz v01r04
- KDB 941225 D01 3G SAR Procedures v03r01
- KDB 941225 D06 Hotspot Mode v02r01
- KDB 248227 D01 802 11 Wi-Fi SAR v02r02
- KDB 941225 D05 SAR for LTE Devices v02r05

Any report having not been signed by authorized approver, or having been altered without authorization, or having not been stamped by the "Dedicated Testing/Inspection Stamp" is deemed to be invalid. Copying or excerpting portion of, or altering the content of the report is not permitted without the written authorization of AGC. The test results presented in the report apply only to the tested sample. Any objections to report issued by AGC should be submitted to AGC within 15days after the issuance of the test report. Further enquiry of validity or verification of the test report should be addressed to AGC by agc01@agccert.com.

## 2. GENERAL INFORMATION

### 2.1. EUT Description

General Information	
Product Designation	Smartphone
Test Model	VORTEX HD68
Sample ID	231206025
Hardware Version	S81D_V2.0X
Software Version	V1.0
Device Category	Portable
RF Exposure Environment	Uncontrolled
Antenna Type	Internal
GSM and GPRS & EGPRS	
Support Band	<input checked="" type="checkbox"/> GSM 850 <input checked="" type="checkbox"/> PCS 1900 <input type="checkbox"/> GSM 900 <input type="checkbox"/> DCS 1800
GPRS & EGPRS Type	Class B
GPRS & EGPRS Class	Class 12(1Tx+4Rx, 2Tx+3Rx, 3Tx+2Rx, 4Tx+1Rx)
TX Frequency Range	GSM 850 : 820-850MHz; PCS 1900: 1850-1910MHz;
RX Frequency Range	GSM 850 : 869~894MHz; PCS 1900: 1930~1990MHz
Release Version	R99
Type of modulation	GMSK for GSM/GPRS; GMSK & 8-PSK for EGPRS
Antenna Gain	GSM850: -2.6dBi; PCS1900: 0.16dBi
Max. Average Power	GSM850: 34.04dBm; PCS1900: 31.08dBm
WCDMA	
Support Band	<input checked="" type="checkbox"/> UMTS FDD Band II <input checked="" type="checkbox"/> UMTS FDD Band V <input checked="" type="checkbox"/> UMTS FDD Band IV <input type="checkbox"/> UMTS FDD Band I <input type="checkbox"/> UMTS FDD Band III <input type="checkbox"/> UMTS FDD Band VIII
HS Type	HSPA(HSUPA/HSDPA)
TX Frequency Range	FDD Band II: 1850-1910MHz; FDD Band V: 824-849MHz FDD Band IV: 1710-1770MHz
RX Frequency Range	FDD Band II: 1930-1990MHz; FDD Band V: 869-894MHz FDD Band IV: 2110-2170MHz
Release Version	Release 6 and later
Type of modulation	HSDPA:QPSK/16QAM; HSUPA:BPSK; WCDMA:QPSK
Antenna Gain	Band II: 0.16dBi; Band IV: 0.39dBi; Band V: -2.6dBi
Max. Average Power	Band II: 23.92dBm; Band IV: 23.92 dBm; Band V: 24.60dBm
Bluetooth	
Bluetooth Version	V5.3
Operation Frequency	2402~2480MHz
Type of modulation	<input checked="" type="checkbox"/> GFSK <input checked="" type="checkbox"/> II/4-DQPSK <input checked="" type="checkbox"/> 8-DPSK
Peak Power	3.32dBm
Antenna Gain	-0.18dBi
2.4GHz WIFI	
WIFI Specification	<input type="checkbox"/> 802.11a <input checked="" type="checkbox"/> 802.11b <input checked="" type="checkbox"/> 802.11g <input checked="" type="checkbox"/> 802.11n(20) <input checked="" type="checkbox"/> 802.11n(40)
Operation Frequency	2412~2462MHz
Avg. Burst Power	11b: 16.52dBm, 11g: 14.03dBm, 11n(20): 11.88dBm, 11n(40): 12.64dBm
Antenna Gain	-0.18dBi

Any report having not been signed by authorized approver, or having been altered without authorization, or having not been stamped by the "Dedicated Testing/Inspection Stamp" is deemed to be invalid. Copying or excerpting portion of, or altering the content of the report is not permitted without the written authorization of AGC. The test results presented in the report apply only to the tested sample. Any objections to report issued by AGC should be submitted to AGC within 15days after the issuance of the test report. Further enquiry of validity or verification of the test report should be addressed to AGC by agc01@agccert.com.

EUT Description( Continue)

<b>LTE</b>	
Support Band	<input checked="" type="checkbox"/> FDD Band 2 <input checked="" type="checkbox"/> FDD Band 4 <input checked="" type="checkbox"/> FDD Band 5 <input checked="" type="checkbox"/> FDD Band 12 <input checked="" type="checkbox"/> FDD Band 13 <input checked="" type="checkbox"/> FDD Band 17 <input checked="" type="checkbox"/> FDD Band 25 <input checked="" type="checkbox"/> FDD Band 26 <input checked="" type="checkbox"/> TDD Band 41 <input checked="" type="checkbox"/> FDD Band 66 <input checked="" type="checkbox"/> FDD Band 71
TX Frequency Range	Band 2:1850-1910MHz; Band 4:1710-1755MHz;Band 5:824-849MHz; Band 12:699-716MHz; Band 13: 777-787MHz; Band 17: 704-716MHz; Band 25: 1850-1915MHz; Band 26: 814-849MHz; Band 41:2496-2690MHz; Band 66:1700-1780MHz; Band 71:663-698MHz
RX Frequency Range	Band 2:1930-1990MHz; Band 4:2110-2155MHz; Band 5:869-894MHz; Band 12: 729-746 MHz; Band 13: 746-756MHz; Band 17: 734-746 MHz; Band 25: 1930-1995MHz; Band 26: 859-894MHz; Band 41:2496-2690MHz; Band 66:2110-2200MHz; Band 71:617-652MHz
Type of modulation	QPSK, 16QAM
Antenna Gain	Band 2: 0.16dBi; Band 4: 0.39dBi; Band 5: -2.6dBi; Band 12: -2.98dBi; Band 13: -2.83dBi; Band 17: -2.98dBi; Band 25: 0.58dBi; Band 26a: -2.6dBi; Band 26b: -2.6dBi;Band 41: -0.39dBi; Band 66: 0.39dBi; Band 71: -3.25dBi;
Max. Average Power	Band 2: 25.26dBm; Band 4: 25.36dBm; Band 5: 25.28dBm; Band 12: 24.30dBm; Band 13: 24.55dBm; Band 17: 24.22dBm; Band 25: 24.27dBm; Band 26a: 25.25dBm; Band 26b: 25.71dBm; Band 41: 24.40dBm; Band 66: 25.28dBm; Band 71: 24.15dBm;
<b>5 GHz WIFI</b>	
WIFI Specification	<input checked="" type="checkbox"/> 802.11a <input checked="" type="checkbox"/> 802.11n20 <input checked="" type="checkbox"/> 802.11n40 <input checked="" type="checkbox"/> 802.11ac20 <input checked="" type="checkbox"/> 802.11ac40 <input checked="" type="checkbox"/> 802.11ac80
Operation Frequency	U-NII-2A: 5260MHz~5320MHz; U-NII-2C: 5470MHz~5725MHz;
Max. conducted Power	U-NII-2A: -0.78dBm; U-NII-2C: 5.71dBm;
Antenna Gain	-0.18dBi
<b>Accessories</b>	
Battery	Brand name: N/A Model No. : VORTEX HD68 Voltage and Capacitance: 3.85 V & 4000mAh
Earphone	Brand name: N/A Model No. : N/A

- Note:1.CMU200 can measure the average power and Peak power at the same time  
2.The sample used for testing is end product.  
3. The test sample has no any deviation to the test method of standard mentioned in page 1.

Product	Type
	<input checked="" type="checkbox"/> Production unit <input type="checkbox"/> Identical Prototype

Any report having not been signed by authorized approver, or having been altered without authorization, or having not been stamped by the “Dedicated Testing/Inspection Stamp” is deemed to be invalid. Copying or excerpting portion of, or altering the content of the report is not permitted without the written authorization of AGC. The test results presented in the report apply only to the tested sample. Any objections to report issued by AGC should be submitted to AGC within 15days after the issuance of the test report. Further enquiry of validity or verification of the test report should be addressed to AGC by agc01@agccert.com.

### 3. SAR MEASUREMENT SYSTEM

#### 3.1. The SATIMO system used for performing compliance tests consists of following items

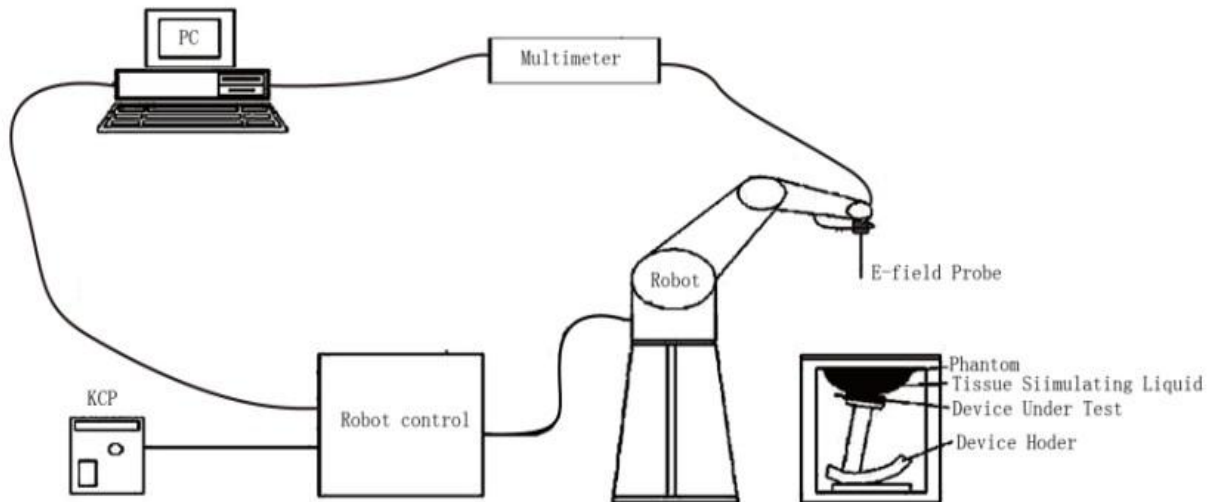

The COMOSAR system for performing compliance tests consists of the following items:

- The PC. It controls most of the bench devices and stores measurement data. A computer running WinXP and the Opensar software.
- The E-Field probe. The probe is a 3-axis system made of 3 distinct dipoles. Each dipole returns a voltage in function of the ambient electric field.
- The Keithley multimeter measures each probe dipole voltages.
- The SAM phantom simulates a human head. The measurement of the electric field is made inside the phantom.
- The liquids simulate the dielectric properties of the human head tissues.
- The network emulator controls the mobile phone under test.
- The validation dipoles are used to measure a reference SAR. They are used to periodically check the bench to make sure that there is no drift of the system characteristics over time.
- The phantom, the device holder and other accessories according to the targeted measurement.

Any report having not been signed by authorized approver, or having been altered without authorization, or having not been stamped by the “Dedicated Testing/Inspection Stamp” is deemed to be invalid. Copying or excerpting portion of, or altering the content of the report is not permitted without the written authorization of AGC. The test results presented in the report apply only to the tested sample. Any objections to report issued by AGC should be submitted to AGC within 15days after the issuance of the test report. Further enquiry of validity or verification of the test report should be addressed to AGC by agc01@agccert.com.



### 3.2. COMOSAR E-Field Probe

The SAR measurement is conducted with the dosimetric probe manufactured by SATIMO. The probe is specially designed and calibrated for use in liquid with high permittivity. The dosimetric probe has special calibration in liquid at different frequency. SATIMO conducts the probe calibration in compliance with international and national standards (e.g. IEEE 1528 and relevant KDB files.) The calibration data are in Appendix D.

#### Isotropic E-Field Probe Specification

<b>Model</b>	SSE2	
<b>Manufacture</b>	MVG	
<b>Identification No.</b>	2023-EPGO-414	
<b>Frequency</b>	0.15GHz-7.5GHz Linearity:±0.09dB(0.15GHz-7.5GHz)	
<b>Dynamic Range</b>	0.01W/kg-100W/kg Linearity:±0.09dB	
<b>Dimensions</b>	Overall length:330mm Length of individual dipoles:24.5mm Maximum external diameter:8mm Probe Tip external diameter:2.55mm Distance between dipoles/ probe extremity:12.7mm	
<b>Application</b>	High precision dosimetric measurements in any exposure scenario (e.g., very strong gradient fields). Only probe which enables compliance testing for frequencies up to 6 GHz with precision of better 30%.	

### 3.3. Robot

The COMOSAR system uses the KUKA robot from SATIMO SA (France).For the 6-axis controller COMOSAR system, the KUKA robot controller version from SATIMO is used.

The XL robot series have many features that are important for our application:

- High precision (repeatability 0.02 mm)
- High reliability (industrial design)
- Jerk-free straight movements
- Low ELF interference (the closed metallic construction shields against motor control fields)
- 6-axis controller



Any report having not been signed by authorized approver, or having been altered without authorization, or having not been stamped by the “Dedicated Testing/Inspection Stamp” is deemed to be invalid. Copying or excerpting portion of, or altering the content of the report is not permitted without the written authorization of AGC. The test results presented in the report apply only to the tested sample. Any objections to report issued by AGC should be submitted to AGC within 15days after the issuance of the test report. Further enquiry of validity or verification of the test report should be addressed to AGC by agc01@agccert.com.

### 3.4. Video Positioning System

The video positioning system is used in OpenSAR to check the probe. Which is composed of a camera, LED, mirror and mechanical parts. The camera is piloted by the main computer with firewire link. During the process, the actual position of the probe tip with respect to the robot arm is measured, as well as the probe length and the horizontal probe offset. The software then corrects all movements, such that the robot coordinates are valid for the probe tip. The repeatability of this process is better than 0.1 mm. If a position has been taught with an aligned probe, the same position will be reached with another aligned probe within 0.1 mm, even if the other probe has different dimensions. During probe rotations, the probe tip will keep its actual position.

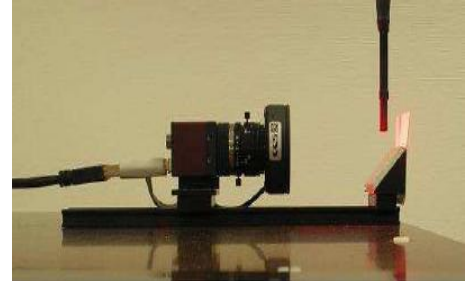

### 3.5. Device Holder

The COMOSAR device holder is designed to cope with different positions given in the standard. It has two scales for the device rotation (with respect to the body axis) and the device inclination (with respect to the line between the ear reference points). The rotation center for both scales is the ear reference point (EPR). Thus the device needs no repositioning when changing the angles. The COMOSAR device holder has been made out of low-loss POM material having the following dielectric parameters: relative permittivity  $\epsilon_r = 3$  and loss tangent  $\delta = 0.02$ . The amount of dielectric material has been reduced in the closest vicinity of the device, since measurements have suggested that the influence of the clamp on the test results could thus be lowered.

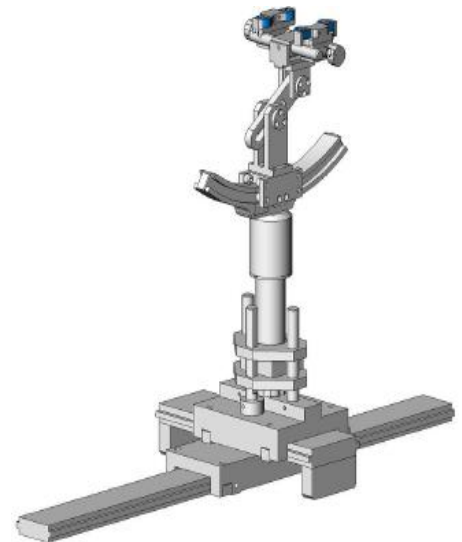

### 3.6. SAM Twin Phantom

The SAM twin phantom is a fiberglass shell phantom with 2mm shell thickness (except the ear region where shell thickness increases to 6mm). It has three measurement areas:

- Left head
- Right head
- Flat phantom



The bottom plate contains three pair of bolts for locking the device holder. The device holder positions are adjusted to the standard measurement positions in the three sections. A white cover is provided to tap the phantom during off-periods to prevent water evaporation and changes in the liquid parameters. On the phantom top, three reference markers are provided to identify the phantom position with respect to the robot.

Any report having not been signed by authorized approver, or having been altered without authorization, or having not been stamped by the “Dedicated Testing/Inspection Stamp” is deemed to be invalid. Copying or excerpting portion of, or altering the content of the report is not permitted without the written authorization of AGC. The test results presented in the report apply only to the tested sample. Any objections to report issued by AGC should be submitted to AGC within 15days after the issuance of the test report. Further enquiry of validity or verification of the test report should be addressed to AGC by [agc01@agccert.com](mailto:agc01@agccert.com).

## 4. SAR MEASUREMENT PROCEDURE

### 4.1. Specific Absorption Rate (SAR)

SAR is related to the rate at which energy is absorbed per unit mass in object exposed to a radio field. The SAR distribution in a biological body is complicated and is usually carried out by experimental techniques or numerical modeling. The standard recommends limits for two tiers of groups, occupational/controlled and occupational/uncontrolled, based on a person's awareness and ability to exercise control over his or her exposure. In general, occupational/controlled exposure limits are higher than the limits for general population/uncontrolled.

The SAR definition is the time derivative (rate) of the incremental energy (dW) absorbed by (dissipated in) an incremental mass (dm) contained in a volume element(dv) of given mass density (ρ). The equation description is as below:

$$SAR = \frac{d}{dt} \left( \frac{dW}{dm} \right) = \frac{d}{dt} \left( \frac{dW}{\rho dV} \right)$$

SAR is expressed in units of Watts per kilogram (W/kg)

SAR can be obtained using either of the following equations:

$$SAR = \frac{\sigma E^2}{\rho}$$

$$SAR = c_h \left. \frac{dT}{dt} \right|_{t=0}$$

Where

SAR	is the specific absorption rate in watts per kilogram;
E	is the r.m.s. value of the electric field strength in the tissue in volts per meter;
σ	is the conductivity of the tissue in siemens per metre;
ρ	is the density of the tissue in kilograms per cubic metre;
c <sub>h</sub>	is the heat capacity of the tissue in joules per kilogram and Kelvin;

$\left. \frac{dT}{dt} \right|_{t=0}$  is the initial time derivative of temperature in the tissue in kelvins per second

## 4.2. SAR Measurement Procedure

### Step 1: Power Reference Measurement

The Power Reference Measurement and Power Drift Measurement are for monitoring the power drift of the device under test in the batch process. The minimum distance of probe sensors to surface is 2.7mm This distance cannot be smaller than the distance os sensor calibration points to probe tip as `defined in the probe properties,

### Step 2: Area Scan

The Area Scan is used as a fast scan in two dimensions to find the area of high field values, before doing a fine measurement around the hot spot. The sophisticated interpolation routines implemented in SATIMO software can find the maximum locations even in relatively coarse grids. When an Area Scan has measured all reachable points, it computes the field maximal found in the scanned area, within a range of the global maximum. The range (in db) is specified in the standards for compliance testing. For example, a 2db range is required in IEEE Standard 1528 standards, whereby 3db is a requirement when compliance is assessed in accordance with the ARIB standard (Japan) If one Zoom Scan follows the Area Scan, then only the absolute maximum will be taken as reference. For cases where multiple maximum are detected, the number of Zoom Scan has to be increased accordingly.

Area Scan Parameters extracted from KDB 865664 D01 SAR Measurement 100MHz to 6GHz

	≤ 3 GHz	> 3 GHz
Maximum distance from closest measurement point (geometric center of probe sensors) to phantom surface	5 ± 1 mm	$\frac{1}{2} \cdot \delta \cdot \ln(2) \pm 0.5$ mm
Maximum probe angle from probe axis to phantom surface normal at the measurement location	30° ± 1°	20° ± 1°
Maximum area scan spatial resolution: $\Delta x_{Area}$ , $\Delta y_{Area}$	≤ 2 GHz: ≤ 15 mm 2 – 3 GHz: ≤ 12 mm	3 – 4 GHz: ≤ 12 mm 4 – 6 GHz: ≤ 10 mm
	When the x or y dimension of the test device, in the measurement plane orientation, is smaller than the above, the measurement resolution must be ≤ the corresponding x or y dimension of the test device with at least one measurement point on the test device.	

### Step 3: Zoom Scan

Zoom Scan are used to assess the peak spatial SAR value within a cubic average volume containing 1g abd 10g of simulated tissue. The Zoom Scan measures points(refer to table below) within a cube whose base faces are centered on the maxima found in a preceding area scan job within the same procedure. When the measurement is done, the Zoom Scan evaluates the averaged SAR for 1g and 10g and displays these values next to the job's label.

Any report having not been signed by authorized approver, or having been altered without authorization, or having not been stamped by the “Dedicated Testing/Inspection Stamp” is deemed to be invalid. Copying or excerpting portion of, or altering the content of the report is not permitted without the written authorization of AGC. The test results presented in the report apply only to the tested sample. Any objections to report issued by AGC should be submitted to AGC within 15days after the issuance of the test report. Further enquiry of validity or verification of the test report should be addressed to AGC by agc01@agccert.com.

Zoom Scan Parameters extracted from KDB865664 d01 SAR Measurement 100MHz to 6GHz

Maximum zoom scan spatial resolution: $\Delta x_{Zoom}$ , $\Delta y_{Zoom}$		$\leq 2$ GHz: $\leq 8$ mm 2 – 3 GHz: $\leq 5$ mm*	3 – 4 GHz: $\leq 5$ mm* 4 – 6 GHz: $\leq 4$ mm*
Maximum zoom scan spatial resolution, normal to phantom surface	uniform grid: $\Delta z_{Zoom}(n)$	$\leq 5$ mm	3 – 4 GHz: $\leq 4$ mm 4 – 5 GHz: $\leq 3$ mm 5 – 6 GHz: $\leq 2$ mm
	graded grid	$\Delta z_{Zoom}(1)$ : between 1 <sup>st</sup> two points closest to phantom surface	$\leq 4$ mm
		$\Delta z_{Zoom}(n>1)$ : between subsequent points	$\leq 1.5 \cdot \Delta z_{Zoom}(n-1)$
Minimum zoom scan volume	x, y, z	$\geq 30$ mm	3 – 4 GHz: $\geq 28$ mm 4 – 5 GHz: $\geq 25$ mm 5 – 6 GHz: $\geq 22$ mm
<p>Note: <math>\delta</math> is the penetration depth of a plane-wave at normal incidence to the tissue medium; see draft standard IEEE P1528-2011 for details.</p> <p>* When zoom scan is required and the <i>reported</i> SAR from the <i>area scan based 1-g SAR estimation</i> procedures of KDB 447498 is <math>\leq 1.4</math> W/kg, <math>\leq 8</math> mm, <math>\leq 7</math> mm and <math>\leq 5</math> mm zoom scan resolution may be applied, respectively, for 2 GHz to 3 GHz, 3 GHz to 4 GHz and 4 GHz to 6 GHz.</p>			

Step 4: Power Drift Measurement

The Power Drift Measurement measures the field at the same location as the most recent power reference measurement within the same procedure, and with the same settings. The Power Drift Measurement gives the field difference in dB from the reading conducted within the same settings. This allows a user to monitor the power drift of the device under test within a batch process. The measurement procedure is the same as Step 1.

Any report having not been signed by authorized approver, or having been altered without authorization, or having not been stamped by the “Dedicated Testing/Inspection Stamp” is deemed to be invalid. Copying or excerpting portion of, or altering the content of the report is not permitted without the written authorization of AGC. The test results presented in the report apply only to the tested sample. Any objections to report issued by AGC should be submitted to AGC within 15days after the issuance of the test report. Further enquiry of validity or verification of the test report should be addressed to AGC by agc01@agccert.com.

### 4.3. RF Exposure Conditions

Test Configuration and setting:

The EUT is a model of GSM Portable Mobile Station (MS). It supports GSM/GPRS/EGPRS, WCDMA/HSPA, LTE, BT, WIFI, and support hot spot mode.

For WWAN SAR testing, the device was controlled by using a base station emulator. Communication between the device and the emulator were established by air link. The distance between the EUT and the antenna is larger than 50cm, and the output power radiated from the emulator antenna is at least 30db smaller than the output power of EUT.

For WLAN testing, the EUT is configured with the WLAN continuous TX tool through engineering command.

#### Antenna Location: (the back view)

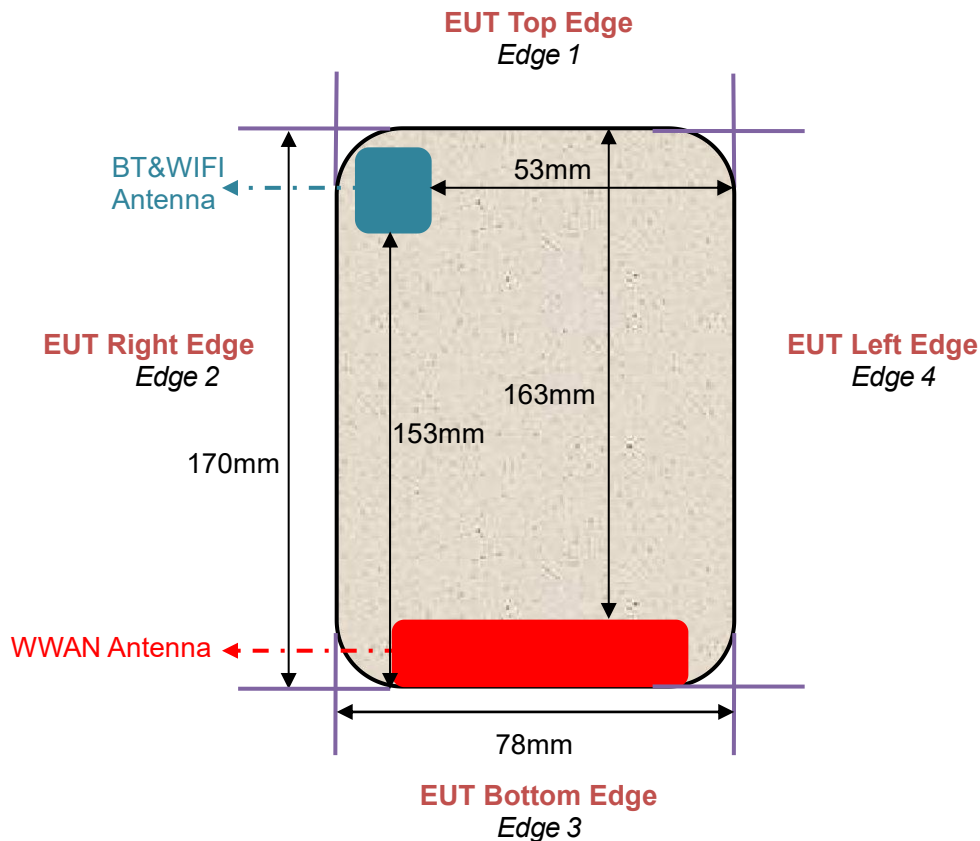

Any report having not been signed by authorized approver, or having been altered without authorization, or having not been stamped by the "Dedicated Testing/Inspection Stamp" is deemed to be invalid. Copying or excerpting portion of, or altering the content of the report is not permitted without the written authorization of AGC. The test results presented in the report apply only to the tested sample. Any objections to report issued by AGC should be submitted to AGC within 15days after the issuance of the test report. Further enquiry of validity or verification of the test report should be addressed to AGC by agc01@agccert.com.

## 5. TISSUE SIMULATING LIQUID

For SAR measurement of the field distribution inside the phantom, the phantom must be filled with homogeneous tissue simulating liquid to a depth of at least 15cm. For head SAR testing the liquid height from the ear reference point (ERP) of the phantom to the liquid top surface is larger than 15cm For body SAR testing, the liquid height from the center of the flat phantom to the liquid top surface is larger than 15cm. The nominal dielectric values of the tissue simulating liquids in the phantom and the tolerance of 10% are listed in 6.2

### 5.1. The composition of the tissue simulating liquid

Frequency (MHz) \ Ingredient (% Weight)	Water	NaCl	Polysorbate 20	DGBE	1,2-Propanediol	Triton X-100	Diethylen glycol monohex ylether
750 Head	35	2	0.0	0.0	63	0.0	0.0
835 Head	50.36	1.25	48.39	0.0	0.0	0.0	0.0
1750 Head	52.64	0.36	0.0	47	0.0	0.0	0.0
1900 Head	54.9	0.18	0.0	44.92	0.0	0.0	0.0
2450 Head	71.88	0.16	0.0	7.99	0.0	19.97	0.0
2600 Head	55.242	0.306	0	44.452	0	0	0.0

Any report having not been signed by authorized approver, or having been altered without authorization, or having not been stamped by the "Dedicated Testing/Inspection Stamp" is deemed to be invalid. Copying or excerpting portion of, or altering the content of the report is not permitted without the written authorization of AGC. The test results presented in the report apply only to the tested sample. Any objections to report issued by AGC should be submitted to AGC within 15days after the issuance of the test report. Further enquiry of validity or verification of the test report should be addressed to AGC by agc01@agccert.com.



## 5.2. Tissue Dielectric Parameters for Head and Body Phantoms

The head and body tissue dielectric parameters recommended by the IEEE Std. 1528 have been incorporated in the following table.

Target Frequency (MHz)	head		body	
	$\epsilon_r$	$\sigma$ (S/m)	$\epsilon_r$	$\sigma$ (S/m)
300	45.3	0.87	45.3	0.87
450	43.5	0.87	43.5	0.87
<b>750</b>	<b>41.9</b>	<b>0.89</b>	<b>41.9</b>	<b>0.89</b>
<b>835</b>	<b>41.5</b>	<b>0.90</b>	<b>41.5</b>	<b>0.90</b>
900	41.5	0.97	41.5	0.97
915	41.5	1.01	41.5	1.01
1450	40.5	1.20	40.5	1.20
1610	40.3	1.29	40.3	1.29
<b>1750</b>	<b>40.1</b>	<b>1.37</b>	<b>40.1</b>	<b>1.37</b>
<b>1800 – 2000</b>	<b>40.0</b>	<b>1.40</b>	<b>40.0</b>	<b>1.40</b>
2300	39.5	1.67	39.5	1.67
<b>2450</b>	<b>39.2</b>	<b>1.80</b>	<b>39.2</b>	<b>1.80</b>
<b>2600</b>	<b>39.0</b>	<b>1.96</b>	<b>39.0</b>	<b>1.96</b>
3000	38.5	2.40	38.5	2.40
5200	36.0	4.66	36.0	4.66
5300	35.9	4.76	35.9	4.76
5600	35.5	5.07	35.5	5.07
5800	35.3	5.27	35.3	5.27

( $\epsilon_r$  = relative permittivity,  $\sigma$  = conductivity and  $\rho = 1000 \text{ kg/m}^3$ )

Any report having not been signed by authorized approver, or having been altered without authorization, or having not been stamped by the “Dedicated Testing/Inspection Stamp” is deemed to be invalid. Copying or excerpting portion of, or altering the content of the report is not permitted without the written authorization of AGC. The test results presented in the report apply only to the tested sample. Any objections to report issued by AGC should be submitted to AGC within 15days after the issuance of the test report. Further enquiry of validity or verification of the test report should be addressed to AGC by [agc01@agccert.com](mailto:agc01@agccert.com).

### 5.3. Tissue Calibration Result

The dielectric parameters of the liquids were verified prior to the SAR evaluation using SATIMO Dielectric Probe Kit and R&S Network Analyzer ZVL6.

Tissue Stimulant Measurement for 750MHz					
	Fr. (MHz)	Dielectric Parameters ( $\pm 10\%$ )		Tissue Temp [°C]	Test time
		$\epsilon_r$ 41.9 (37.71-46.09)	$\delta$ [s/m] 0.89(0.801-0.979)		
Head	683	45.79	0.82	21.3	Jan. 04, 2024
	707.5	44.36	0.85		
	710	43.22	0.88		
	750	42.57	0.90		
	782	41.63	0.91		

Tissue Stimulant Measurement for 835MHz					
	Fr. (MHz)	Dielectric Parameters ( $\pm 10\%$ )		Tissue Temp [°C]	Test time
		$\epsilon_r$ 41.5 (37.35-45.65)	$\delta$ [s/m] 0.90(0.81-0.99)		
Head	819	43.26	0.89	20.8	Jan. 03, 2024
	835	41.50	0.91		
	836.4	40.67	0.94		
	836.5	40.67	0.94		
	836.6	40.67	0.94		

Tissue Stimulant Measurement for 1750MHz					
	Fr. (MHz)	Dielectric Parameters ( $\pm 10\%$ )		Tissue Temp [°C]	Test time
		$\epsilon_r$ 40.1 (36.09-44.11)	$\delta$ [s/m]1.37(1.233-1.507)		
Head	1712.4	43.12	1.24	20.6	Jan. 07, 2024
	1720	42.69	1.26		
	1732.4	41.39	1.28		
	1732.5	41.39	1.28		
	1745	40.17	1.30		
	1750	39.71	1.32		
	1752.6	38.67	1.34		

Tissue Stimulant Measurement for 1900MHz					
	Fr. (MHz)	Dielectric Parameters ( $\pm 10\%$ )		Tissue Temp [°C]	Test time
		$\epsilon_r$ 40.00(36.00-44.00)	$\delta$ [s/m]1.40(1.26-1.54)		
Head	1860	41.33	1.29	20.4	Jan. 08, 2024
	1880	40.69	1.31		
	1882.5	40.13	1.34		
	1900	39.34	1.36		

Any report having not been signed by authorized approver, or having been altered without authorization, or having not been stamped by the "Dedicated Testing/Inspection Stamp" is deemed to be invalid. Copying or excerpting portion of, or altering the content of the report is not permitted without the written authorization of AGC. The test results presented in the report apply only to the tested sample. Any objections to report issued by AGC should be submitted to AGC within 15days after the issuance of the test report. Further enquiry of validity or verification of the test report should be addressed to AGC by agc01@agccert.com.

Tissue Stimulant Measurement for 2450MHz					
Head	Fr. (MHz)	Dielectric Parameters ( $\pm 10\%$ )		Tissue Temp [°C]	Test time
		$\epsilon_r 39.2(35.28-43.12)$	$\delta[s/m] 1.80(1.62-1.98)$		
	2437	40.66	1.80	20.8	Jan. 06, 2024
2450	39.43	1.82			

Tissue Stimulant Measurement for 2600MHz					
Head	Fr. (MHz)	Dielectric Parameters ( $\pm 10\%$ )		Tissue Temp [°C]	Test time
		$\epsilon_r 39(35.1-42.9)$	$\delta[s/m] 1.96(1.764-2.156)$		
	2593	39.66	1.96	21.2	Jan. 05, 2024
2600	38.18	1.99			

Any report having not been signed by authorized approver, or having been altered without authorization, or having not been stamped by the "Dedicated Testing/Inspection Stamp" is deemed to be invalid. Copying or excerpting portion of, or altering the content of the report is not permitted without the written authorization of AGC. The test results presented in the report apply only to the tested sample. Any objections to report issued by AGC should be submitted to AGC within 15days after the issuance of the test report. Further enquiry of validity or verification of the test report should be addressed to AGC by agc01@agccert.com.

## 6. SAR SYSTEM CHECK PROCEDURE

### 6.1. SAR System Check Procedures

SAR system check is required to confirm measurement accuracy, according to the tissue dielectric media, probe calibration points and other system operating parameters required for measuring the SAR of a test device. The system verification must be performed for each frequency band and within the valid range of each probe calibration point required for testing the device. The same SAR probe(s) and tissue-equivalent media combinations used with each specific SAR system for system verification must be used for device testing. When multiple probe calibration points are required to cover substantially large transmission bands, independent system verifications are required for each probe calibration point. A system verification must be performed before each series of SAR measurements using the same probe calibration point and tissue-equivalent medium. Additional system verification should be considered according to the conditions of the tissue-equivalent medium and measured tissue dielectric parameters, typically every three to four days when the liquid parameters are remeasured or sooner when marginal liquid parameters are used at the beginning of a series of measurements.

Each SATIMO system is equipped with one or more system check kits. These units, together with the predefined measurement procedures within the SATIMO software, enable the user to conduct the system check and system validation. System kit includes a dipole, and dipole device holder.

The system check verifies that the system operates within its specifications. It's performed daily or before every SAR measurement. The system check uses normal SAR measurement in the flat section of the phantom with a matched dipole at a specified distance. The system check setup is shown as below.

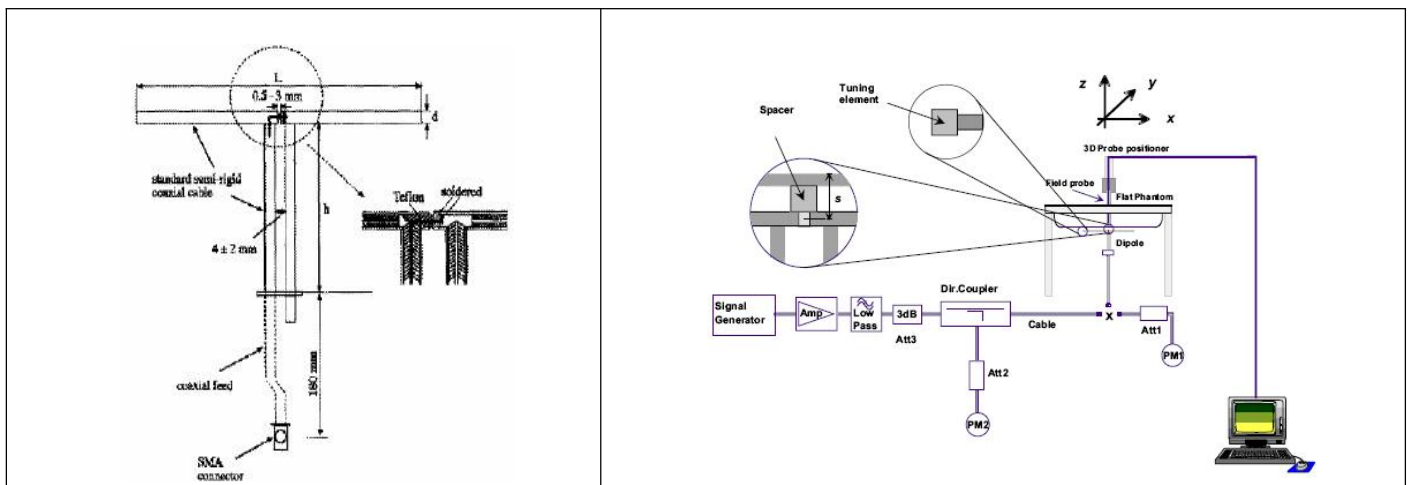

Any report having not been signed by authorized approver, or having been altered without authorization, or having not been stamped by the "Dedicated Testing/Inspection Stamp" is deemed to be invalid. Copying or excerpting portion of, or altering the content of the report is not permitted without the written authorization of AGC. The test results presented in the report apply only to the tested sample. Any objections to report issued by AGC should be submitted to AGC within 15 days after the issuance of the test report. Further enquiry of validity or verification of the test report should be addressed to AGC by [agc01@agccert.com](mailto:agc01@agccert.com).

## 6.2. SAR System Check

### 6.2.1. Dipoles

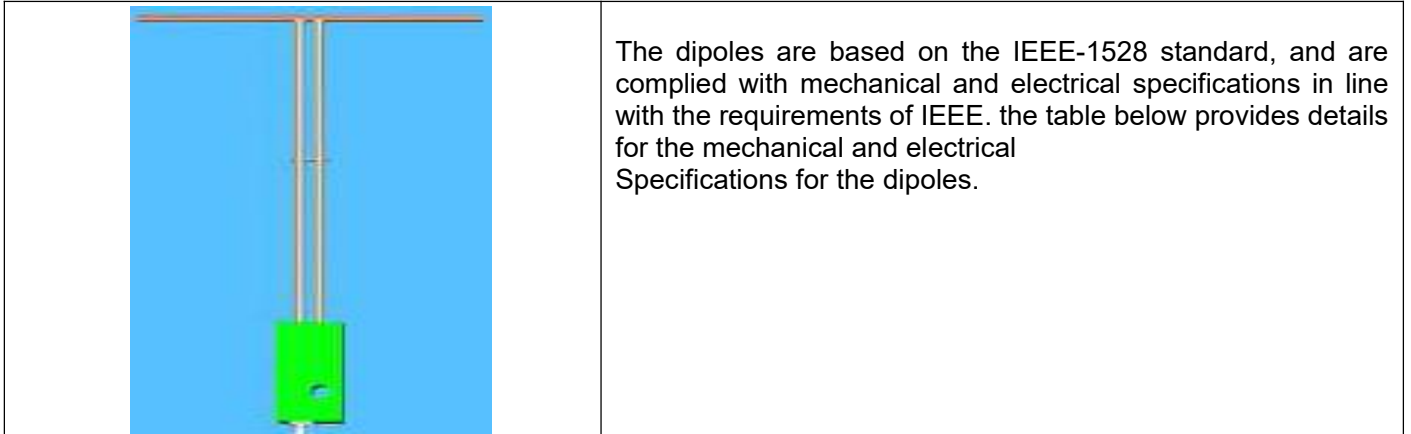

Frequency	L (mm)	h (mm)	d (mm)
750MHz	176	100	6.35
835MHz	161.0	89.8	3.6
1800MHz	71.6	41.7	3.6
1900MHz	68	39.5	3.6
2450MHz	51.5	30.4	3.6
2600MHz	48.5	28.8	3.6

Any report having not been signed by authorized approver, or having been altered without authorization, or having not been stamped by the "Dedicated Testing/Inspection Stamp" is deemed to be invalid. Copying or excerpting portion of, or altering the content of the report is not permitted without the written authorization of AGC. The test results presented in the report apply only to the tested sample. Any objections to report issued by AGC should be submitted to AGC within 15days after the issuance of the test report. Further enquiry of validity or verification of the test report should be addressed to AGC by [agc01@agccert.com](mailto:agc01@agccert.com).

### 6.2.2. System Check Result

System Performance Check at 750MHz&835MHz &1800MHz &1900MHz &2450MHz&2600MHz for Head								
Validation Kit: SN 22/16 DIP 0G750-417& SN 15/16 DIP 0G835-399& SN 46/11 DIP 1G800-186& SN 29/15 DIP 1G900-389& SN 29/15 DIP 2G450-393& SN 22/16 DIP 2G600-407								
Frequency [MHz]	Target Value(W/kg)		Reference Result ( $\pm 10\%$ )		Tested Value(W/kg)		Tissue Temp. [°C]	Test time
	1g	10g	1g	10g	1g	10g		
750	8.33	5.44	7.497-9.163	4.896-5.984	8.76	5.61	21.3	Jan. 04, 2024
835	9.67	6.14	8.703-10.637	5.526-6.754	9.62	6.18	20.8	Jan. 03, 2024
1800	37.76	19.60	33.984-41.536	17.640-21.560	40.63	20.47	20.6	Jan. 07, 2024
1900	41.26	20.86	37.134-45.386	18.774-22.946	39.45	20.39	20.4	Jan. 08, 2024
2450	54.32	24.25	48.888-59.752	21.825-26.675	52.54	23.72	20.8	Jan. 06, 2024
2600	54.94	23.77	49.446-60.434	21.393-26.147	54.23	24.31	21.2	Jan. 05, 2024

**Note:**

(1) We use a CW signal of 18dBm for system check, and then all SAR value are normalized to 1W forward power. The result must be within  $\pm 10\%$  of target value.

Any report having not been signed by authorized approver, or having been altered without authorization, or having not been stamped by the “Dedicated Testing/Inspection Stamp” is deemed to be invalid. Copying or excerpting portion of, or altering the content of the report is not permitted without the written authorization of AGC. The test results presented in the report apply only to the tested sample. Any objections to report issued by AGC should be submitted to AGC within 15days after the issuance of the test report. Further enquiry of validity or verification of the test report should be addressed to AGC by agc01@agccert.com.

## 7. EUT TEST POSITION

This EUT was tested in **Right Cheek, Right Tilted, Left Cheek, Left Tilted, Body back, Body front and 4 edges.**

### 7.1. Define Two Imaginary Lines on the Handset

- (1) The vertical centerline passes through two points on the front side of the handset: the midpoint of the width  $w_t$  of the handset at the level of the acoustic output, and the midpoint of the width  $w_b$  of the handset.
- (2) The horizontal line is perpendicular to the vertical centerline and passes through the center of the acoustic output. The horizontal line is also tangential to the face of the handset at point A.
- (3) The two lines intersect at point A. Note that for many handsets, point A coincides with the center of the acoustic output; however, the acoustic output may be located elsewhere on the horizontal line. Also note that the vertical centerline is not necessarily to the front face of the handset, especially for clamshell handsets, handsets with flip covers, and other irregularly shaped handsets.

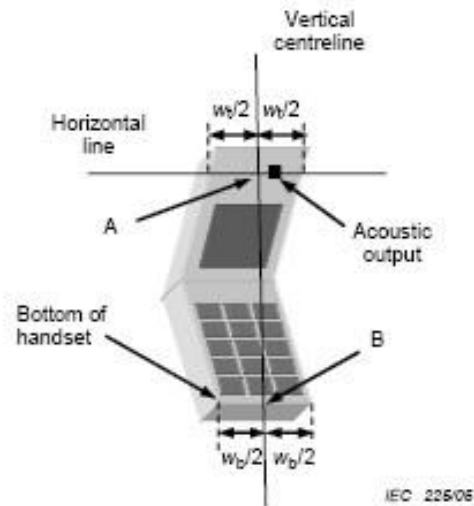
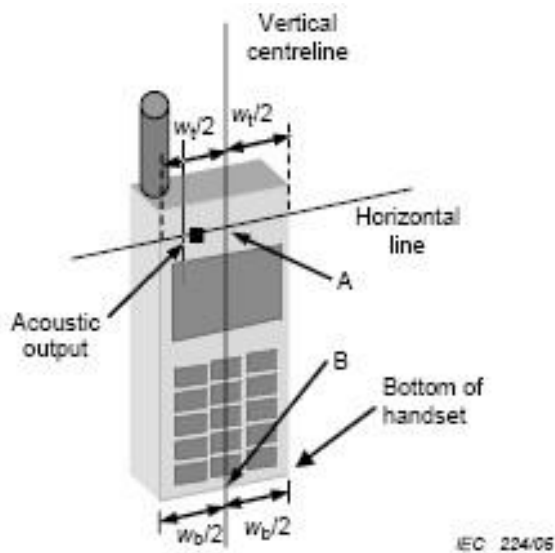

Any report having not been signed by authorized approver, or having been altered without authorization, or having not been stamped by the "Dedicated Testing/Inspection Stamp" is deemed to be invalid. Copying or excerpting portion of, or altering the content of the report is not permitted without the written authorization of AGC. The test results presented in the report apply only to the tested sample. Any objections to report issued by AGC should be submitted to AGC within 15 days after the issuance of the test report. Further enquiry of validity or verification of the test report should be addressed to AGC by [agc01@agccert.com](mailto:agc01@agccert.com).

## 7.2. Cheek Position

- (1) To position the device with the vertical center line of the body of the device and the horizontal line crossing the center piece in a plane parallel to the sagittal plane of the phantom. While maintaining the device in this plane, align the vertical center line with the reference plane containing the ear and mouth reference point (M: Mouth, RE: Right Ear, and LE: Left Ear) and align the center of the ear piece with the line RE-LE.
- (2) To move the device towards the phantom with the ear piece aligned with the the line LE-RE until the phone touched the ear. While maintaining the device in the reference plane and maintaining the phone contact with ear, move the bottom of the phone until any point on the front side is in contact with the cheek of the phantom or until contact with the ear is lost



## 7.3. Tilt Position

- (1) To position the device in the “cheek” position described above.
- (2) While maintaining the device in the reference plane described above and pivoting against the ear, moves it outward away from the mouth by an angle of 15 degrees or until with the ear is lost.



Any report having not been signed by authorized approver, or having been altered without authorization, or having not been stamped by the “Dedicated Testing/Inspection Stamp” is deemed to be invalid. Copying or excerpting portion of, or altering the content of the report is not permitted without the written authorization of AGC. The test results presented in the report apply only to the tested sample. Any objections to report issued by AGC should be submitted to AGC within 15days after the issuance of the test report. Further enquiry of validity or verification of the test report should be addressed to AGC by agc01@agccert.com.



#### 7.4. Body Worn Position

- (1) To position the EUT parallel to the phantom surface.
- (2) To adjust the EUT parallel to the flat phantom.
- (3) To adjust the distance between the EUT surface and the flat phantom to **10mm**.

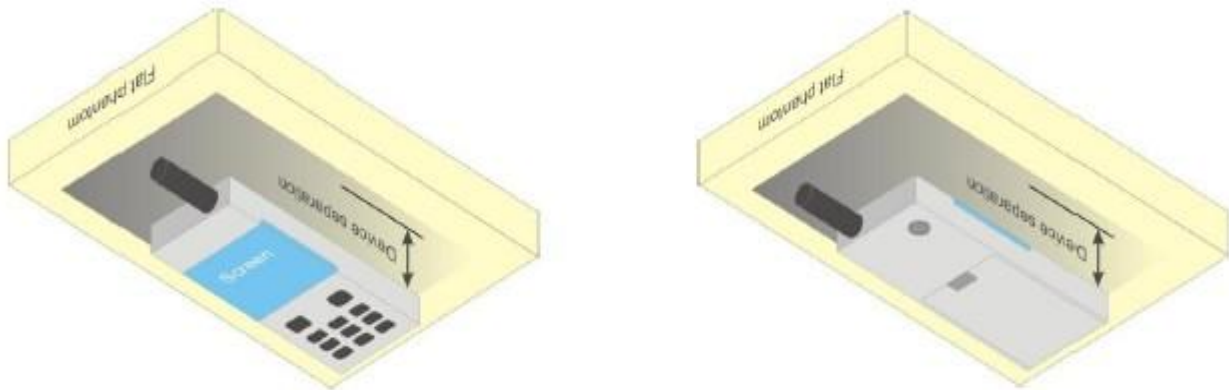

Any report having not been signed by authorized approver, or having been altered without authorization, or having not been stamped by the “Dedicated Testing/Inspection Stamp” is deemed to be invalid. Copying or excerpting portion of, or altering the content of the report is not permitted without the written authorization of AGC. The test results presented in the report apply only to the tested sample. Any objections to report issued by AGC should be submitted to AGC within 15days after the issuance of the test report. Further enquiry of validity or verification of the test report should be addressed to AGC by [agc01@agccert.com](mailto:agc01@agccert.com).

## 8. SAR EXPOSURE LIMITS

### Limits for General Population/Uncontrolled Exposure (W/kg)

Type Exposure	Uncontrolled Environment Limit (W/kg)
Spatial Peak SAR (1g cube tissue for brain or body)	1.60
Spatial Average SAR (Whole body)	0.08
Spatial Peak SAR (Limbs)	4.0

Any report having not been signed by authorized approver, or having been altered without authorization, or having not been stamped by the "Dedicated Testing/Inspection Stamp" is deemed to be invalid. Copying or excerpting portion of, or altering the content of the report is not permitted without the written authorization of AGC. The test results presented in the report apply only to the tested sample. Any objections to report issued by AGC should be submitted to AGC within 15days after the issuance of the test report. Further enquiry of validity or verification of the test report should be addressed to AGC by [agc01@agccert.com](mailto:agc01@agccert.com).

## 9. TEST FACILITY

<b>Test Site</b>	Attestation of Global Compliance (Shenzhen) Co., Ltd
<b>Location</b>	1-2/F, Building 19, Junfeng Industrial Park, Chongqing Road, Heping Community, Fuhai Street, Bao'an District, Shenzhen, Guangdong, China
<b>Designation Number</b>	CN1259
<b>FCC Test Firm Registration Number</b>	975832
<b>A2LA Cert. No.</b>	5054.02
<b>Description</b>	Attestation of Global Compliance(Shenzhen) Co., Ltd is accredited by A2LA

Any report having not been signed by authorized approver, or having been altered without authorization, or having not been stamped by the "Dedicated Testing/Inspection Stamp" is deemed to be invalid. Copying or excerpting portion of, or altering the content of the report is not permitted without the written authorization of AGC. The test results presented in the report apply only to the tested sample. Any objections to report issued by AGC should be submitted to AGC within 15days after the issuance of the test report. Further enquiry of validity or verification of the test report should be addressed to AGC by [agc01@agccert.com](mailto:agc01@agccert.com).

Attestation of Global Compliance(Shenzhen)Co., Ltd  
Attestation of Global Compliance(Shenzhen)Std & Tech Co., Ltd  
Tel: +86-755 2523 4088 E-mail: [agc@agccert.com](mailto:agc@agccert.com) Web: <http://www.agccert.com/>

## 10. TEST EQUIPMENT LIST

Equipment description	Manufacturer/ Model	Identification No.	Software version	Current calibration date	Next calibration date
SAR Probe	MVG	2023-EPGO-414	N/A	May 31, 2023	May 30, 2024
Phantom	SATIMO	SN_4511_SAM90	N/A	Validated. No cal required.	Validated. No cal required.
Liquid	SATIMO	N/A	N/A	Validated. No cal required.	Validated. No cal required.
Comm Tester	Agilent-8960	GB46310822	A.13.07	Jun. 03, 2023	Jun. 02, 2024
Comm Tester	R&S- CMW500	121209	V3.7.40	Jun. 01, 2023	May 31, 2024
Multimeter	Keithley 2000	1350784	N/A	Jun. 02, 2023	Jun. 01, 2024
SAR Software	SATIMO-OpenSAR	N/A	OpenSAR V4_02_32	N/A	N/A
Dipole	SATIMO SID750	SN 22/16 DIP 0G750-417	N/A-	Apr. 28,2022	Apr. 27,2025
Dipole	SATIMO SID835	SN 15/16 DIP 0G835-399	N/A	Apr. 28,2022	Apr. 27,2025
Dipole	SATIMO SID1800	SN 46/11 DIP 1G800-186	N/A	Apr. 28,2022	Apr. 27,2025
Dipole	SATIMO SID1900	SN 29/15 DIP 1G900-389	N/A	Apr. 28,2022	Apr. 27,2025
Dipole	SATIMO SID2450	SN 29/15 DIP 2G450-393	N/A	Apr. 28,2022	Apr. 27,2025
Dipole	SATIMO SID2600	SN 22/16 DIP 2G600-407	N/A	Apr. 28,2022	Apr. 27, 2025
Signal Generator	Agilent-E4438C	US41461365	V5.03	Jun. 01, 2023	May 31, 2024
Vector Analyzer	Agilent / E4440A	MY44303916	N/A	Jun. 01, 2023	May 31, 2024
Network Analyzer	Rhode & Schwarz ZVL6	SN101443	3.2	Sep. 21, 2023	Sep. 20, 2024
Attenuator	Warison /WATT-6SR1211	S/N:WRJ34AYM2F1	N/A	June 07, 2023	June 06, 2024
Attenuator	Mini-circuits / VAT-10+	31405	N/A	June 07, 2023	June 06, 2024
Amplifier	AS0104-55_55	1004793	N/A	N/A	N/A
Directional Couple	Werlatone/ C5571-10	SN99463	N/A	Mar. 10, 2022	Mar. 09, 2024
Directional Couple	Werlatone/ C6026-10	SN99482	N/A	Mar. 10, 2022	Mar. 09, 2024
Power Sensor	NRP-Z21	1137.6000.02	N/A	Sep. 05, 2023	Sep. 04, 2024
Power Sensor	NRP-Z23	100323	N/A	Feb. 15, 2023	Feb. 14, 2024
Power Viewer	R&S	V2.3.1.0	N/A	N/A	N/A
Calibration standard parts for network sub - port	R&S/ ZV-Z132	N/A	V2.3.1.0	Nov. 11, 2023	Nov. 10, 2024

Note: Per KDB 865664 Dipole SAR Validation, AGC Lab has adopted 3 years calibration intervals. On annual basis, every measurement dipole has been evaluated and is in compliance with the following criteria:

1. There is no physical damage on the dipole;
2. System validation with specific dipole is within 10% of calibrated value;
3. Return-loss is within 20% of calibrated measurement;
4. Impedance is within 5Ω of calibrated measurement.

Any report having not been signed by authorized approver, or having been altered without authorization, or having not been stamped by the "Dedicated Testing/Inspection Stamp" is deemed to be invalid. Copying or excerpting portion of, or altering the content of the report is not permitted without the written authorization of AGC. The test results presented in the report apply only to the tested sample. Any objections to report issued by AGC should be submitted to AGC within 15days after the issuance of the test report. Further enquiry of validity or verification of the test report should be addressed to AGC by agc01@agccert.com.

## 11. MEASUREMENT UNCERTAINTY

SATIMO Uncertainty- 2023-EPGO-414 Measurement uncertainty for DUT averaged over 1 gram / 10 gram.									
Uncertainty Component	Sec.	Tol (+-%)	Prob. Dist.	Div.	Ci (1g)	Ci (10g)	1g Ui (+-%)	10g Ui (+-%)	vi
<b>Measurement System</b>									
Probe calibration	E.2.1	7.000	N	1	1	1	7.000	7.000	∞
Axial Isotropy	E.2.2	1.695	R	1.732	0.707	0.707	0.692	0.692	∞
Hemispherical Isotropy	E.2.2	1.695	R	1.732	0.707	0.707	0.692	0.692	∞
Boundary effect	E.2.3	1.000	R	1.732	1	1	0.577	0.577	∞
Linearity	E.2.4	2.250	R	1.732	1	1	1.299	1.299	∞
System detection limits	E.2.4	1.000	R	1.732	1	1	0.577	0.577	∞
Modulation response	E.2.5	3.000	R	1.732	1	1	1.732	1.732	∞
Readout Electronics	E.2.6	0.021	N	1	1	1	0.021	0.021	∞
Response Time	E.2.7	0.000	R	1.732	1	1	0.000	0.000	∞
Integration Time	E.2.8	1.400	R	1.732	1	1	0.808	0.808	∞
RF ambient conditions-Noise	E.6.1	3.000	R	1.732	1	1	1.732	1.732	∞
RF ambient conditions-reflections	E.6.1	3.000	R	1.732	1	1	1.732	1.732	∞
Probe positioner mechanical tolerance	E.6.2	1.400	R	1.732	1	1	0.808	0.808	∞
Probe positioning with respect to phantom shell	E.6.3	1.400	R	1.732	1	1	0.808	0.808	∞
Extrapolation, interpolation, and integrations algorithms for max. SAR evaluation	E.5	2.300	R	1.732	1	1	1.328	1.328	∞
<b>Test sample Related</b>									
Test sample positioning	E.4.2	2.6	N	1	1	1	2.60	2.60	∞
Device holder uncertainty	E.4.1	3	N	1	1	1	3.00	3.00	∞
Output power variation—SAR drift measurement	E.2.9	5	R	1.732	1	1	2.89	2.89	∞
SAR scaling	E.6.5	5	R	1.732	1	1	2.89	2.89	∞
<b>Phantom and tissue parameters</b>									
Phantom shell uncertainty—shape, thickness, and permittivity	E.3.1	4	R	1.732	1	1	2.309	2.309	∞
Uncertainty in SAR correction for deviations in permittivity and conductivity	E.3.2	1.9	N	1	1	0.84	1.900	1.596	∞
Liquid conductivity measurement	E.3.3	4	N	1	0.78	0.71	3.120	2.840	M
Liquid permittivity measurement	E.3.3	5	N	1	0.23	0.26	1.150	1.300	M
Liquid conductivity—temperature uncertainty	E.3.4	2.5	R	1.732	0.78	0.71	1.126	1.025	∞
Liquid permittivity—temperature uncertainty	E.3.4	2.5	R	1.732	0.23	0.26	0.332	0.375	∞
Combined Standard Uncertainty			RSS				10.616	10.432	
Expanded Uncertainty (95% Confidence interval)			K=2				21.232	20.865	

Any report having not been signed by authorized approver, or having been altered without authorization, or having not been stamped by the “Dedicated Testing/Inspection Stamp” is deemed to be invalid. Copying or excerpting portion of, or altering the content of the report is not permitted without the written authorization of AGC. The test results presented in the report apply only to the tested sample. Any objections to report issued by AGC should be submitted to AGC within 15days after the issuance of the test report. Further enquiry of validity or verification of the test report should be addressed to AGC by agc01@agccert.com.

SATIMO Uncertainty- 2023-EPGO-414									
System Validation uncertainty for DUT averaged over 1 gram / 10 gram.									
Uncertainty Component	Sec.	Tol (+-%)	Prob. Dist.	Div.	Ci (1g)	Ci (10g)	1g Ui (+-%)	10g Ui (+-%)	vi
<b>Measurement System</b>									
Probe calibration	E.2.1	7.000	N	1	1	1	7.000	7.000	∞
Axial Isotropy	E.2.2	1.695	R	1.732	1.000	1.000	0.979	0.979	∞
Hemispherical Isotropy	E.2.2	1.695	R	1.732	0.000	0.000	0.000	0.000	∞
Boundary effect	E.2.3	1.000	R	1.732	1.000	1.000	0.577	0.577	∞
Linearity	E.2.4	2.250	R	1.732	1.000	1.000	1.299	1.299	∞
System detection limits	E.2.4	1.000	R	1.732	1.000	1.000	0.577	0.577	∞
Modulation response	E.2.5	3.000	R	1.732	0.000	0.000	0.000	0.000	∞
Readout Electronics	E.2.6	0.021	N	1.000	1.000	1.000	0.021	0.021	∞
Response Time	E.2.7	0.000	R	1.732	0.000	0.000	0.000	0.000	∞
Integration Time	E.2.8	1.400	R	1.732	0.000	0.000	0.000	0.000	∞
RF ambient conditions-Noise	E.6.1	3.000	R	1.732	1.000	1.000	1.732	1.732	∞
RF ambient conditions-reflections	E.6.1	3.000	R	1.732	1.000	1.000	1.732	1.732	∞
Probe positioner mechanical tolerance	E.6.2	1.400	R	1.732	1.000	1.000	0.808	0.808	∞
Probe positioning with respect to phantom shell	E.6.3	1.400	R	1.732	1.000	1.000	0.808	0.808	∞
Extrapolation, interpolation, and integrations algorithms for max. SAR evaluation	E.5	2.300	R	1.732	1.000	1.000	1.328	1.328	∞
<b>System validation source</b>									
Deviation of experimental dipole from numerical dipole	E.6.4	5	N	1	1	1	5	5	∞
Input power and SAR drift measurement	8,6.6.4	5	R	1.732	1	1	2.887	2.887	∞
Dipole axis to liquid distance	8,E.6.6	2	R	1.732	1	1	1.155	1.155	∞
<b>Phantom and set-up</b>									
Phantom shell uncertainty—shape, thickness, and permittivity	E.3.1	4	R	1.732	1	1	2.309	2.309	∞
Uncertainty in SAR correction for deviations in permittivity and conductivity	E.3.2	1.9	N	1	1	0.84	1.9	1.596	∞
Liquid conductivity (temperature uncertainty)	E.3.3	4	N	1	0.78	0.71	3.12	2.84	∞
Liquid conductivity (measured)	E.3.3	5	N	1	0.23	0.26	1.15	1.3	M
Liquid permittivity (temperature uncertainty)	E.3.4	2.5	R	1.732	0.78	0.71	1.126	1.025	∞
Liquid permittivity (measured)	E.3.4	2.5	R	1.732	0.23	0.26	0.332	0.375	M
Combined Standard Uncertainty			RSS				10.572	10.387	
Expanded Uncertainty (95% Confidence interval)			K=2				21.143	20.775	

Any report having not been signed by authorized approver, or having been altered without authorization, or having not been stamped by the “Dedicated Testing/Inspection Stamp” is deemed to be invalid. Copying or excerpting portion of, or altering the content of the report is not permitted without the written authorization of AGC. The test results presented in the report apply only to the tested sample. Any objections to report issued by AGC should be submitted to AGC within 15days after the issuance of the test report. Further enquiry of validity or verification of the test report should be addressed to AGC by agc01@agccert.com.

SATIMO Uncertainty- 2023-EPGO-414									
System Check uncertainty for DUT averaged over 1 gram / 10 gram.									
Uncertainty Component	Sec.	Tol (+-%)	Prob. Dist.	Div.	Ci (1g)	Ci (10g)	1g Ui (+-%)	10g Ui (+-%)	vi
<b>Measurement System</b>									
Probe calibration drift	E.2.1.3	0.5	N	1	1	1	0.5	0.5	∞
Axial Isotropy	E.2.2	1.695	R	$\sqrt{3}$	0	0	0	0	∞
Hemispherical Isotropy	E.2.2	1.695	R	$\sqrt{3}$	0	0	0	0	∞
Boundary effect	E.2.3	1.000	R	$\sqrt{3}$	0	0	0	0	∞
Linearity	E.2.4	2.250	R	$\sqrt{3}$	0	0	0	0	∞
System detection limits	E.2.4	1	R	$\sqrt{3}$	0	0	0	0	∞
Modulation response	E.2.5	3	R	$\sqrt{3}$	0	0	0	0	∞
Readout Electronics	E.2.6	0.021	N	$\sqrt{3}$	0	0	0	0	∞
Response Time	E.2.7	0	R	$\sqrt{3}$	0	0	0	0	∞
Integration Time	E.2.8	1.4	R	$\sqrt{3}$	0	0	0	0	∞
RF ambient conditions-Noise	E.6.1	3	R	$\sqrt{3}$	0	0	0	0	∞
RF ambient conditions-reflections	E.6.1	3	R	$\sqrt{3}$	0	0	0	0	∞
Probe positioner mechanical tolerance	E.6.2	1.4	R	$\sqrt{3}$	1	1	0.81	0.81	∞
Probe positioning with respect to phantom shell	E.6.3	1.4	R	$\sqrt{3}$	1	1	0.81	0.81	∞
Extrapolation, interpolation, and integrations algorithms for max. SAR evaluation	E.5	2.3	R	$\sqrt{3}$	0	0	0	0.00	∞
<b>System check source (dipole)</b>									
Deviation of experimental dipoles	E.6.4	2	N	1	1	1	2	2	∞
Input power and SAR drift measurement	8,6.6.4	5	R	$\sqrt{3}$	1	1	2.89	2.89	∞
Dipole axis to liquid distance	8,E.6.6	2	R	$\sqrt{3}$	1	1	1.15	1.15	∞
<b>Phantom and tissue parameters</b>									
Phantom shell uncertainty—shape, thickness, and permittivity	E.3.1	4	R	$\sqrt{3}$	1	1	2.31	2.31	∞
Uncertainty in SAR correction for deviations in permittivity and conductivity	E.3.2	1.9	N	1.000	1	0.84	1.90	1.60	∞
Liquid conductivity measurement	E.3.3	4	N	1.000	0.78	0.71	3.12	2.84	∞
Liquid permittivity measurement	E.3.3	5	N	1.000	0.23	0.26	1.15	1.30	M
Liquid conductivity—temperature uncertainty	E.3.4	2.5	R	$\sqrt{3}$	0.78	0.71	1.13	1.02	∞
Liquid permittivity—temperature uncertainty	E.3.4	2.5	R	$\sqrt{3}$	0.23	0.26	0.33	0.38	M
Combined Standard Uncertainty			RSS				5.562	5.203	
Expanded Uncertainty (95% Confidence interval)			K=2				11.124	10.406	

Any report having not been signed by authorized approver, or having been altered without authorization, or having not been stamped by the “Dedicated Testing/Inspection Stamp” is deemed to be invalid. Copying or excerpting portion of, or altering the content of the report is not permitted without the written authorization of AGC. The test results presented in the report apply only to the tested sample. Any objections to report issued by AGC should be submitted to AGC within 15days after the issuance of the test report. Further enquiry of validity or verification of the test report should be addressed to AGC by agc01@agccert.com.

## 12. CONDUCTED POWER MEASUREMENT GSM BAND

Mode	Frequency(MHz)	Avg. Burst Power(dBm)	Duty cycle Factor(dBm)	Frame Power(dBm)
Maximum Power <1>				
GSM 850	824.2	33.78	-9	24.78
	836.6	<b>34.04</b>	-9	25.04
	848.8	33.81	-9	24.81
GPRS 850 (1 Slot)	824.2	33.80	-9	24.80
	836.6	34.04	-9	25.04
	848.8	33.80	-9	24.80
GPRS 850 (2 Slot)	824.2	31.79	-6	25.79
	836.6	32.16	-6	<b>26.16</b>
	848.8	31.87	-6	25.87
GPRS 850 (3 Slot)	824.2	29.85	-4.26	25.59
	836.6	30.27	-4.26	26.01
	848.8	29.95	-4.26	25.69
GPRS 850 (4 Slot)	824.2	27.91	-3	24.91
	836.6	28.32	-3	25.32
	848.8	28.00	-3	25.00
EGPRS 850 (1 Slot)	824.2	26.85	-9	17.85
	836.6	27.07	-9	18.07
	848.8	26.9	-9	17.90
EGPRS 850 (2 Slot)	824.2	25.46	-6	19.46
	836.6	25.64	-6	19.64
	848.8	25.53	-6	19.53
EGPRS 850 (3 Slot)	824.2	23.01	-4.26	18.75
	836.6	24.16	-4.26	19.90
	848.8	23.25	-4.26	18.99
EGPRS 850 (4 Slot)	824.2	20.57	-3	17.57
	836.6	21.34	-3	18.34
	848.8	20.88	-3	17.88

Any report having not been signed by authorized approver, or having been altered without authorization, or having not been stamped by the "Dedicated Testing/Inspection Stamp" is deemed to be invalid. Copying or excerpting portion of, or altering the content of the report is not permitted without the written authorization of AGC. The test results presented in the report apply only to the tested sample. Any objections to report issued by AGC should be submitted to AGC within 15days after the issuance of the test report. Further enquiry of validity or verification of the test report should be addressed to AGC by agc01@agccert.com.



**GSM BAND CONTINUE**

Mode	Frequency(MHz)	Avg. Burst Power(dBm)	Duty cycle Factor(dBm)	Frame Power(dBm)
Maximum Power <1>				
PCS1900	1850.2	30.88	-9	21.88
	1880	<b>31.08</b>	-9	22.08
	1909.8	30.97	-9	21.97
GPRS1900 (1 Slot)	1850.2	30.86	-9	21.86
	1880	31.05	-9	22.05
	1909.8	30.94	-9	21.94
GPRS1900 (2 Slot)	1850.2	28.71	-6	22.71
	1880	28.85	-6	22.85
	1909.8	28.78	-6	22.78
GPRS1900 (3 Slot)	1850.2	27.14	-4.26	22.88
	1880	27.29	-4.26	<b>23.03</b>
	1909.8	27.15	-4.26	22.89
GPRS1900 (4 Slot)	1850.2	25.16	-3	22.16
	1880	25.24	-3	22.24
	1909.8	25.10	-3	22.10
EGPRS1900 (1 Slot)	1850.2	27.31	-9	18.31
	1880	27.18	-9	18.18
	1909.8	27.08	-9	18.08
EGPRS1900 (2 Slot)	1850.2	25.90	-6	19.90
	1880	25.43	-6	19.43
	1909.8	25.18	-6	19.18
EGPRS1900 (3 Slot)	1850.2	23.66	-4.26	19.40
	1880	23.50	-4.26	19.24
	1909.8	22.98	-4.26	18.72
EGPRS1900 (4 Slot)	1850.2	21.58	-3	18.58
	1880	21.75	-3	18.75
	1909.8	20.63	-3	17.63

Note 1:

The Frame Power (Source-based time-averaged Power) is scaled the maximum burst average power based on time slots. The calculated methods are show as following:

Frame Power = Max burst power (1 Up Slot) – 9 dB

Frame Power = Max burst power (2 Up Slot) – 6 dB

Frame Power = Max burst power (3 Up Slot) – 4.26 dB

Frame Power = Max burst power (4 Up Slot) – 3 dB

Note 2:

SAR is not required for GPRS (1 Slot) Mode because its output power is less than of Voice Mode

**UMTS BAND  
HSDPA Setup Configuration:**

- The EUT was connected to Base Station Agilent-8960 referred to the Setup Configuration.
- The RF path losses were compensated into the measurements.
- A call was established between EUT and Based Station with following setting:
  - (1) Set Gain Factors( $\beta_c$  and  $\beta_d$ ) parameters set according to each
  - (2) Set RMC 12.2Kbps+HSDPA mode.
  - (3) Set Cell Power=-86dBm
  - (4) Set HS-DSCH Configuration Type to FRC (H-set 1, QPSK)
  - (5) Select HSDPA Uplink Parameters
  - (6) Set Delta ACK, Delta NACK and Delta CQI=8
  - (7) Set Ack - Nack Repetition Factor to 3
  - (8) Set CQI Feedback Cycle (k) to 4ms
  - (9) Set CQI Repetition Factor to 2
  - (10) Power Ctrl Mode=All Up bits
- The transmitted maximum output power was recorded.

Table C.10.2.4:  $\beta$  values for transmitter characteristics tests with HS-DPCCH

Sub-test	$\beta_c$ (Note5)	$\beta_d$	$\beta_d$ (SF)	$\beta_c/\beta_d$	$\beta_{HS}$ (Note1, Note 2)	CM (dB) (Note 3)	MPR (dB) (Note 3)
1	2/15	15/15	64	2/15	4/15	0.0	0.0
2	12/15(Note 4)	15/15(Note 4)	64	12/15(Note 4)	24/15	1.0	0.0
3	15/15	8/15	64	15/8	30/15	1.5	0.5
4	15/15	4/15	64	15/4	30/15	1.5	0.5

Note 1:  $\Delta ACK, \Delta NACK$  and  $\Delta CQI = 30/15$  with  $\beta_{hs} = 30/15 * \beta_c$ .

Note 2: For the HS-DPCCH power mask requirement test in clause 5.2C, 5.7A, and the Error Vector Magnitude (EVM) with HS-DPCCH test in clause 5.13.1A, and HSDPA EVM with phase discontinuity in clause 5.13.1AA,  $\Delta ACK$  and  $\Delta NACK = 30/15$  with  $\beta_{hs} = 30/15 * \beta_c$ , and  $\Delta CQI = 24/15$  with  $\beta_{hs} = 24/15 * \beta_c$ .

Note 3: CM = 1 for  $\beta_c/\beta_d = 12/15, \beta_c/\beta_d = 15/8, \beta_c/\beta_d = 15/4$ . For all other combinations of DPDCH, DPCCH and HS-DPCCH the MPR is based on the relative CM difference. This is applicable for only UEs that support HSDPA in release 6 and later releases.

Note 4: For subtest 2 the  $c/d$  ratio of 12/15 for the TFC during the measurement period (TF1, TF0) is achieved by setting the signalled gain factors for the reference TFC (TF1, TF1) to  $c = 11/15$  and  $d = 15/15$ .

Any report having not been signed by authorized approver, or having been altered without authorization, or having not been stamped by the "Dedicated Testing/Inspection Stamp" is deemed to be invalid. Copying or excerpting portion of, or altering the content of the report is not permitted without the written authorization of AGC. The test results presented in the report apply only to the tested sample. Any objections to report issued by AGC should be submitted to AGC within 15days after the issuance of the test report. Further enquiry of validity or verification of the test report should be addressed to AGC by agc01@agccert.com.

**HSUPA Setup Configuration:**

- The EUT was connected to Base Station Agilent-8960 referred to the Setup Configuration.
- The RF path losses were compensated into the measurements.
- A call was established between EUT and Base Station with following setting \* :
  - (1) Call Configs = 5.2B, 5.9B, 5.10B, and 5.13.2B with QPSK
  - (2) Set the Gain Factors ( $\beta_c$  and  $\beta_d$ ) and parameters (AG Index) were set according to each specific sub-test in the following table, C11.1.3, quoted from the TS 34.121
  - (3) Set Cell Power = -86 dBm
  - (4) Set Channel Type = 12.2k + HSPA
  - (5) Set UE Target Power
  - (6) Power Ctrl Mode= Alternating bits
  - (7) Set and observe the E-TFCI
  - (8) Confirm that E-TFCI is equal to the target E-TFCI of 75 for sub-test 1, and other subtest's E-TFCI
- The transmitted maximum output power was recorded.

Table C.11.1.3:  $\beta$  values for transmitter characteristics tests with HS-DPCCH and E-DCH

Sub-test	$\beta_c$	$\beta_d$	$\beta_d$ (SF)	$\beta_c/\beta_d$	$\beta_{HS}$ (Note 1)	$\beta_{ec}$	$\beta_{ed}$ (Note 4) (Note 5)	$\beta_{ed}$ (SF)	$\beta_{ed}$ (Codes)	CM (dB) (Note 2)	MPR (dB) (Note 2) (Note 6)	AG Index (Note 5)	E-TF CI
1	11/15 (Note 3)	15/15 (Note 3)	64	11/15 (Note 3)	22/15	209/225	1309/225	4	1	1.0	0.0	20	75
2	6/15	15/15	64	6/15	12/15	12/15	94/75	4	1	3.0	2.0	12	67
3	15/15	9/15	64	15/9	30/15	30/15	$\beta_{ed1}$ : 47/15 $\beta_{ed2}$ : 47/15	4	2	2.0	1.0	15	92
4	2/15	15/15	64	2/15	4/15	2/15	56/75	4	1	3.0	2.0	17	71
5	15/15	0	-	-	5/15	5/15	47/15	4	1	1.0	0.0	12	67

Note 1: For sub-test 1 to 4,  $\Delta ACK$ ,  $\Delta NACK$  and  $\Delta CQI = 30/15$  with  $\beta_{hs} = 30/15 * \beta_c$ . For sub-test 5,  $\Delta ACK$ ,  $\Delta NACK$  and  $\Delta CQI = 5/15$  with  $\beta_{hs} = 5/15 * \beta_c$ .

Note 2: CM = 1 for  $\beta_c/\beta_d = 12/15$ ,  $hs/c = 24/15$ . For all other combinations of DPDCH, DPCCH, HS-DPCCH, E-DPDCH and E-DPCCH the MPR is based on the relative CM difference.

Note 3: For subtest 1 the  $c/d$  ratio of 11/15 for the TFC during the measurement period (TF1, TF0) is achieved by setting the signalled gain factors for the reference TFC (TF1, TF1) to  $c = 10/15$  and  $d = 15/15$ .

Note 4: In case of testing by UE using E-DPDCH Physical Layer category 1, Sub-test 3 is omitted according to TS25.306 Table 5.1g.

Note 5:  $\beta_{ed}$  cannot be set directly; it is set by Absolute Grant Value.

Note 6: For subtests 2, 3 and 4, UE may perform E-DPDCH power scaling at max power which could results in slightly smaller MPR values.

**UMTS BAND II**

Mode	Frequency (MHz)	Avg. Burst Power (dBm)
WCDMA 1900 RMC	1852.4	23.80
	1880	23.83
	1907.6	<b>23.92</b>
HSDPA Subtest 1	1852.4	23.63
	1880	23.58
	1907.6	23.47
HSDPA Subtest 2	1852.4	23.31
	1880	23.23
	1907.6	23.33
HSDPA Subtest 3	1852.4	22.94
	1880	23.06
	1907.6	22.70
HSDPA Subtest 4	1852.4	22.68
	1880	22.86
	1907.6	22.82
HSUPA Subtest 1	1852.4	23.53
	1880	23.40
	1907.6	23.39
HSUPA Subtest 2	1852.4	23.54
	1880	23.54
	1907.6	23.48
HSUPA Subtest 3	1852.4	23.09
	1880	23.22
	1907.6	22.91
HSUPA Subtest 4	1852.4	23.47
	1880	23.51
	1907.6	23.46
HSUPA Subtest 5	1852.4	23.04
	1880	23.48
	1907.6	23.26

Any report having not been signed by authorized approver, or having been altered without authorization, or having not been stamped by the "Dedicated Testing/Inspection Stamp" is deemed to be invalid. Copying or excerpting portion of, or altering the content of the report is not permitted without the written authorization of AGC. The test results presented in the report apply only to the tested sample. Any objections to report issued by AGC should be submitted to AGC within 15days after the issuance of the test report. Further enquiry of validity or verification of the test report should be addressed to AGC by agc01@agccert.com.

**UMTS BAND IV**

Mode	Frequency (MHz)	Avg. Burst Power (dBm)
WCDMA 1700 RMC	1712.4	23.66
	1732.4	<b>23.92</b>
	1752.6	23.78
HSDPA Subtest 1	1712.4	23.65
	1732.4	23.65
	1752.6	23.67
HSDPA Subtest 2	1712.4	23.38
	1732.4	23.25
	1752.6	23.37
HSDPA Subtest 3	1712.4	23.08
	1732.4	23.13
	1752.6	23.16
HSDPA Subtest 4	1712.4	22.93
	1732.4	22.93
	1752.6	22.99
HSUPA Subtest 1	1712.4	23.46
	1732.4	23.48
	1752.6	23.42
HSUPA Subtest 2	1712.4	23.55
	1732.4	23.55
	1752.6	23.64
HSUPA Subtest 3	1712.4	23.17
	1732.4	23.11
	1752.6	23.32
HSUPA Subtest 4	1712.4	23.48
	1732.4	23.60
	1752.6	23.65
HSUPA Subtest 5	1712.4	23.30
	1732.4	23.30
	1752.6	23.53

Any report having not been signed by authorized approver, or having been altered without authorization, or having not been stamped by the "Dedicated Testing/Inspection Stamp" is deemed to be invalid. Copying or excerpting portion of, or altering the content of the report is not permitted without the written authorization of AGC. The test results presented in the report apply only to the tested sample. Any objections to report issued by AGC should be submitted to AGC within 15days after the issuance of the test report. Further enquiry of validity or verification of the test report should be addressed to AGC by agc01@agccert.com.

**UMTS BAND V**

Mode	Frequency (MHz)	Avg. Burst Power (dBm)
WCDMA 850 RMC	826.4	23.81
	836.4	23.90
	846.6	24.21
HSDPA Subtest 1	826.4	24.36
	836.4	24.45
	846.6	24.52
HSDPA Subtest 2	826.4	24.34
	836.4	24.21
	846.6	24.35
HSDPA Subtest 3	826.4	23.77
	836.4	23.95
	846.6	23.97
HSDPA Subtest 4	826.4	23.42
	836.4	23.78
	846.6	23.69
HSUPA Subtest 1	826.4	<b>24.60</b>
	836.4	24.22
	846.6	24.30
HSUPA Subtest 2	826.4	24.39
	836.4	24.43
	846.6	24.47
HSUPA Subtest 3	826.4	24.43
	836.4	23.64
	846.6	24.24
HSUPA Subtest 4	826.4	24.40
	836.4	24.46
	846.6	24.48
HSUPA Subtest 5	826.4	24.35
	836.4	24.18
	846.6	24.43

Any report having not been signed by authorized approver, or having been altered without authorization, or having not been stamped by the "Dedicated Testing/Inspection Stamp" is deemed to be invalid. Copying or excerpting portion of, or altering the content of the report is not permitted without the written authorization of AGC. The test results presented in the report apply only to the tested sample. Any objections to report issued by AGC should be submitted to AGC within 15days after the issuance of the test report. Further enquiry of validity or verification of the test report should be addressed to AGC by agc01@agccert.com.

According to 3GPP 25.101 sub-clause 6.2.2 , the maximum output power is allowed to be reduced by following the table.

Table 6.1aA: UE maximum output power with HS-DPCCH and E-DCH

UE Transmit Channel Configuration	CM(db)	MPR(db)
For all combinations of ,DPDCH,DPCCH HS-DPDCH,E-DPDCH and E-DPCCH	$0 \leq CM \leq 3.5$	$MAX(CM-1,0)$
Note: CM=1 for $\beta_c/\beta_d=12/15$ , $\beta_{hs}/\beta_c=24/15$ .For all other combinations of DPDCH, DPCCH, HS-DPCCH, E-DPDCH and E-DPCCH the MPR is based on the relative CM difference.		

The device supports MPR to solve linearity issues (ACLR or SEM) due to the higher peak-to average ratios (PAR) of the HSUPA signal. This prevents saturating the full range of the TX DAC inside of device and provides a reduced power output to the RF transceiver chip according to the Cubic Metric (a function of the combinations of DPDCH, DPCCH, HS-DPCCH, E-DPDCH and E-DPCCH).

When E-DPDCH channels are present the beta gains on those channels are reduced firsts to try to get the power under the allowed limit. If the beta gains are lowered as far as possible, then a hard limiting is applied at the maximum allowed level.

The SW currently recalculates the cubic metric every time the beta gains on the E-DPDCH are reduced. The cubic metric will likely get lower each time this is done .However, there is no reported reduction of maximum output power in the HSUPA mode since the device also provides a compensation for the power back-off by increasing the gain of TX\_AGc in the transceiver (PA) device.

The end effect is that the DUT output power is identical to the case where there is no MPR in the device.

**LTE Band**

**LTE (TDD) Considerations**

For Time-Division Duplex (TDD) systems, SAR must be tested using a fixed periodic duty factor according to the highest transmission duty factor implemented for the device and supported by the defined 3GPP LTE TDD configurations.

SAR was tested with the highest transmission duty factor (63.33%) using Uplink-downlink configuration 0 and Special subframe configuration 7.

LTE TDD Band 41 supports 3GPP TS 36.211 section 4.2 for Type 2 Frame Structure and Table 4.2-2 for uplink-downlink configurations and Table 4.2-1 for Special subframe configurations.

**Table 4.2-1: Configuration of special subframe (lengths of DwPTS/GP/UpPTS)**

Special subframe configuration	Normal cyclic prefix in downlink			Extended cyclic prefix in downlink		
	DwPTS	UpPTS		DwPTS	UpPTS	
		Normal cyclic prefix in uplink	Extended cyclic prefix in uplink		Normal cyclic prefix in uplink	Extended cyclic prefix in uplink
0	$6592 \cdot T_s$	$2192 \cdot T_s$	$2560 \cdot T_s$	$7680 \cdot T_s$	$2192 \cdot T_s$	$2560 \cdot T_s$
1	$19760 \cdot T_s$			$20480 \cdot T_s$		
2	$21952 \cdot T_s$			$23040 \cdot T_s$		
3	$24144 \cdot T_s$			$25600 \cdot T_s$		
4	$26336 \cdot T_s$	$4384 \cdot T_s$	$5120 \cdot T_s$	$7680 \cdot T_s$	$4384 \cdot T_s$	$5120 \cdot T_s$
5	$6592 \cdot T_s$			$20480 \cdot T_s$		
6	$19760 \cdot T_s$			$23040 \cdot T_s$		
7	$21952 \cdot T_s$			$12800 \cdot T_s$		
8	$24144 \cdot T_s$			-	-	-
9	$13168 \cdot T_s$			-	-	-

**Table 4.2-2: Uplink-downlink configurations**

Uplink-downlink configuration	Downlink-to-Uplink Switch-point periodicity	Subframe number									
		0	1	2	3	4	5	6	7	8	9
0	5 ms	D	S	U	U	U	D	S	U	U	U
1	5 ms	D	S	U	U	D	D	S	U	U	D
2	5 ms	D	S	U	D	D	D	S	U	D	D
3	10 ms	D	S	U	U	U	D	D	D	D	D
4	10 ms	D	S	U	U	D	D	D	D	D	D
5	10 ms	D	S	U	D	D	D	D	D	D	D
6	5 ms	D	S	U	U	U	D	S	U	U	D

Any report having not been signed by authorized approver, or having been altered without authorization, or having not been stamped by the “Dedicated Testing/Inspection Stamp” is deemed to be invalid. Copying or excerpting portion of, or altering the content of the report is not permitted without the written authorization of AGC. The test results presented in the report apply only to the tested sample. Any objections to report issued by AGC should be submitted to AGC within 15days after the issuance of the test report. Further enquiry of validity or verification of the test report should be addressed to AGC by agc01@agccert.com.



### Calculated Duty Cycle

Uplink-Downlink Configuration	Downlink-to-Uplink Switch-point Periodicity	Subframe Number										Calculated Duty Cycle(%)
		0	1	2	3	4	5	6	7	8	9	
0	5ms	D	S	U	U	U	D	S	U	U	U	63.33
1	5ms	D	S	U	U	D	D	S	U	U	D	43.33
2	5ms	D	S	U	D	D	D	S	U	D	D	23.33
3	10ms	D	S	U	U	U	D	D	D	D	D	31.67
4	10ms	D	S	U	U	D	D	D	D	D	D	21.67
5	10ms	D	S	U	D	D	D	D	D	D	D	11.67
6	5ms	D	S	U	U	U	D	S	U	U	D	53.33

**Note:** Calculated Duty Cycle = Extended cyclic prefix in uplink x (Ts) x # of S + # of U

Example for Calculated Duty Cycle for Uplink-Downlink Configuration 0:

Calculated Duty Cycle =  $5120 \times [1/(15000 \times 2048)] \times 2 + 6 \text{ ms} = 63.33\%$

where

$T_s = 1/(15000 \times 2048)$  seconds

**LTE Band**

Conducted Power of LTE Band 2(dBm)									
Bandwidth	Modulation	RB size	RB offset	Target MPR	Channel	Channel	Channel		
					18607	18900	19193		
1.4MHz	QPSK	1	0	0	24.82	25.06	24.85		
			3	0	24.97	25.02	24.86		
			5	0	24.95	25.02	24.89		
		3	0	0	24.92	24.74	24.87		
			2	0	24.83	24.79	24.89		
			3	0	24.85	24.84	24.93		
		6	0	1	23.94	23.90	23.80		
		16QAM	1	0	1	24.12	24.09	23.96	
				3	1	24.17	24.05	23.98	
	5			1	24.03	24.14	23.96		
	3		0	1	24.28	23.96	23.89		
			2	1	24.27	23.89	23.90		
			3	1	24.24	23.96	23.94		
	6		0	2	23.08	22.86	23.12		
	Bandwidth		Modulation	RB size	RB offset	Target MPR	Channel	Channel	Channel
							18615	18900	19185
	3MHz	QPSK	1	0	0	24.86	24.70	24.89	
				7	0	24.88	24.72	24.97	
14				0	24.84	24.73	24.97		
8			0	1	23.88	23.84	23.89		
			4	1	23.81	23.86	23.86		
			7	1	23.81	23.82	23.92		
15			0	1	23.94	23.85	23.93		
16QAM			1	0	1	25.00	23.89	23.82	
				7	1	24.96	23.90	23.86	
		14		1	24.97	23.82	24.14		
		8	0	2	22.93	22.94	22.96		
			4	2	22.97	22.93	22.94		
			7	2	22.88	22.93	22.96		
		15	0	2	23.09	22.86	22.97		

Any report having not been signed by authorized approver, or having been altered without authorization, or having not been stamped by the "Dedicated Testing/Inspection Stamp" is deemed to be invalid. Copying or excerpting portion of, or altering the content of the report is not permitted without the written authorization of AGC. The test results presented in the report apply only to the tested sample. Any objections to report issued by AGC should be submitted to AGC within 15days after the issuance of the test report. Further enquiry of validity or verification of the test report should be addressed to AGC by agc01@agccert.com.

Conducted Power of LTE Band 2(dBm)								
Bandwidth	Modulation	RB size	RB offset	Target MPR	Channel	Channel	Channel	
					18625	18900	19175	
5MHz	QPSK	1	0	0	24.81	24.95	24.68	
			13	0	24.84	24.84	24.65	
			24	0	24.91	24.94	24.71	
		12	0	1	23.88	23.77	23.91	
			6	1	23.91	23.85	23.83	
			13	1	24.00	23.87	23.89	
		25	0	1	23.86	23.73	23.91	
		16QAM	1	0	1	23.86	23.89	24.50
				13	1	23.89	24.01	24.43
	24			1	24.04	23.89	24.47	
	12		0	2	22.93	22.72	22.86	
			6	2	22.83	22.68	22.89	
			13	2	22.94	22.70	22.93	
	25	0	2	23.05	22.95	23.12		
	Bandwidth	Modulation	RB size	RB offset	Target MPR	Channel	Channel	Channel
					18650	18900	19150	
10MHz	QPSK	1	0	0	24.84	24.83	24.90	
			25	0	24.92	24.70	24.92	
			49	0	25.11	24.80	25.00	
		25	0	1	23.85	23.73	23.84	
			13	1	23.90	23.76	23.88	
			25	1	24.02	23.79	23.89	
		50	0	1	24.05	23.81	23.86	
		16QAM	1	0	1	24.86	24.57	24.13
				25	1	25.00	24.56	23.85
	49			1	25.14	24.54	23.91	
	25		0	2	22.87	22.89	22.93	
			13	2	22.94	22.90	22.93	
			25	2	23.04	22.92	22.98	
	50		0	2	23.01	22.95	22.94	

Any report having not been signed by authorized approver, or having been altered without authorization, or having not been stamped by the "Dedicated Testing/Inspection Stamp" is deemed to be invalid. Copying or excerpting portion of, or altering the content of the report is not permitted without the written authorization of AGC. The test results presented in the report apply only to the tested sample. Any objections to report issued by AGC should be submitted to AGC within 15days after the issuance of the test report. Further enquiry of validity or verification of the test report should be addressed to AGC by agc01@agccert.com.

Conducted Power of LTE Band 2(dBm)								
Bandwidth	Modulation	RB size	RB offset	Target MPR	Channel	Channel	Channel	
					18675	18900	19125	
15MHz	QPSK	1	0	0	24.82	24.89	24.84	
			38	0	24.95	24.74	24.74	
			74	0	25.02	24.82	24.84	
		36	0	1	23.89	23.77	23.79	
			18	1	24.03	23.81	23.91	
			39	1	24.14	23.88	23.87	
		75	0	1	23.93	23.76	23.85	
		16QAM	1	0	1	24.94	24.64	24.73
				38	1	25.07	24.53	24.72
	74			1	25.21	24.53	24.74	
	36		0	2	23.03	23.00	22.84	
			18	2	23.10	23.01	22.83	
			39	2	23.21	23.01	22.88	
	75	0	2	22.99	22.85	22.93		
	Bandwidth	Modulation	RB size	RB offset	Target MPR	Channel	Channel	Channel
					18700	18900	19100	
20MHz	QPSK	1	0	0	24.89	<b>25.26</b>	24.87	
			50	0	25.11	25.03	24.94	
			99	0	25.18	25.18	24.97	
		50	0	1	24.03	23.95	23.95	
			25	1	24.16	23.74	23.94	
			50	1	24.09	23.96	23.87	
		100	0	1	24.03	23.83	23.86	
		16QAM	1	0	1	23.59	23.67	24.20
				50	1	23.85	23.47	24.21
	99			1	23.84	23.59	24.25	
	50		0	2	23.11	22.92	23.01	
			25	2	23.17	22.91	23.04	
			50	2	23.26	22.90	23.01	
	100	0	2	23.08	22.98	22.98		

Any report having not been signed by authorized approver, or having been altered without authorization, or having not been stamped by the "Dedicated Testing/Inspection Stamp" is deemed to be invalid. Copying or excerpting portion of, or altering the content of the report is not permitted without the written authorization of AGC. The test results presented in the report apply only to the tested sample. Any objections to report issued by AGC should be submitted to AGC within 15days after the issuance of the test report. Further enquiry of validity or verification of the test report should be addressed to AGC by agc01@agccert.com.

Conducted Power of LTE Band 4(dBm)								
Bandwidth	Modulation	RB size	RB offset	Target MPR	Channel	Channel	Channel	
					19957	20175	20393	
1.4MHz	QPSK	1	0	0	24.49	24.70	24.72	
			3	0	24.51	24.75	24.68	
			5	0	24.47	24.73	24.72	
		3	0	0	24.31	24.78	24.54	
			2	0	24.37	24.69	24.60	
			3	0	24.31	24.78	24.54	
		6	0	1	23.34	23.67	23.48	
		16QAM	1	0	1	25.00	24.32	23.76
				3	1	24.94	24.32	23.68
	5			1	25.00	24.33	23.77	
	3		0	1	23.66	23.70	23.51	
			2	1	23.70	23.81	23.47	
			3	1	23.67	23.81	23.53	
	6	0	2	22.68	22.70	22.70		
	Bandwidth	Modulation	RB size	RB offset	Target MPR	Channel	Channel	Channel
19965						20175	20385	
3MHz	QPSK	1	0	0	24.39	24.68	24.69	
			7	0	24.35	24.75	24.68	
			14	0	24.36	24.75	24.72	
		8	0	1	23.41	23.61	23.58	
			4	1	23.33	23.63	23.63	
			7	1	23.32	23.71	23.48	
		15	0	1	23.37	23.75	23.61	
		16QAM	1	0	1	25.16	24.32	23.79
				7	1	25.09	24.29	23.80
	14			1	25.13	24.34	23.69	
	8		0	2	22.41	22.85	22.81	
			4	2	22.40	22.90	22.85	
			7	2	22.31	22.91	22.72	
	15		0	2	22.50	22.74	22.66	

Any report having not been signed by authorized approver, or having been altered without authorization, or having not been stamped by the "Dedicated Testing/Inspection Stamp" is deemed to be invalid. Copying or excerpting portion of, or altering the content of the report is not permitted without the written authorization of AGC. The test results presented in the report apply only to the tested sample. Any objections to report issued by AGC should be submitted to AGC within 15days after the issuance of the test report. Further enquiry of validity or verification of the test report should be addressed to AGC by agc01@agccert.com.

Conducted Power of LTE Band 4(dBm)								
Bandwidth	Modulation	RB size	RB offset	Target MPR	Channel	Channel	Channel	
					19975	20175	20375	
5MHz	QPSK	1	0	0	24.31	24.77	24.35	
			13	0	24.25	24.84	24.35	
			24	0	24.25	24.94	24.29	
		12	0	1	23.42	23.70	23.47	
			6	1	23.35	23.80	23.62	
			13	1	23.43	23.81	23.52	
		25	0	1	23.37	23.72	23.65	
		16QAM	1	0	1	24.07	24.26	24.64
				13	1	24.07	24.34	24.66
	24			1	23.98	24.44	24.66	
	12		0	2	22.38	22.60	22.62	
			6	2	22.40	22.60	22.69	
			13	2	22.33	22.65	22.67	
	25	0	2	22.58	22.84	22.79		
	Bandwidth	Modulation	RB size	RB offset	Target MPR	Channel	Channel	Channel
20000						20175	20350	
10MHz	QPSK	1	0	0	24.31	24.38	24.81	
			25	0	24.21	24.56	24.83	
			49	0	24.29	24.76	24.62	
		25	0	1	23.28	23.68	23.82	
			13	1	23.35	23.75	23.81	
			25	1	23.41	23.80	23.65	
		50	0	1	23.36	23.68	23.65	
		16QAM	1	0	1	25.09	24.71	25.04
				25	1	25.06	24.81	25.22
	49			1	24.98	25.08	25.05	
	25		0	2	22.46	22.73	22.81	
			13	2	22.49	22.87	22.91	
			25	2	22.52	22.93	22.79	
	50		0	2	22.54	22.88	22.80	

Any report having not been signed by authorized approver, or having been altered without authorization, or having not been stamped by the "Dedicated Testing/Inspection Stamp" is deemed to be invalid. Copying or excerpting portion of, or altering the content of the report is not permitted without the written authorization of AGC. The test results presented in the report apply only to the tested sample. Any objections to report issued by AGC should be submitted to AGC within 15days after the issuance of the test report. Further enquiry of validity or verification of the test report should be addressed to AGC by agc01@agccert.com.

Conducted Power of LTE Band 4(dBm)								
Bandwidth	Modulation	RB size	RB offset	Target MPR	Channel	Channel	Channel	
					20025	20175	20325	
15MHz	QPSK	1	0	0	24.29	24.34	24.98	
			38	0	24.26	24.68	24.79	
			74	0	24.35	24.83	24.65	
		36	0	1	23.36	23.56	23.80	
			18	1	23.34	23.77	23.85	
			39	1	23.37	23.83	23.63	
		75	0	1	23.41	23.68	23.71	
		16QAM	1	0	1	25.08	24.54	<b>25.36</b>
				38	1	25.00	24.84	25.31
	74			1	25.06	25.05	25.22	
	36		0	2	22.55	22.79	22.81	
			18	2	22.50	22.83	22.78	
			39	2	22.60	22.99	22.64	
	75	0	2	22.45	22.75	22.90		
	Bandwidth	Modulation	RB size	RB offset	Target MPR	Channel	Channel	Channel
					20050	20175	20300	
20MHz	QPSK	1	0	0	24.38	24.56	24.86	
			50	0	24.43	24.94	24.82	
			99	0	24.79	25.12	24.65	
		50	0	1	23.33	23.53	23.85	
			25	1	23.30	23.66	23.82	
			50	1	23.43	23.87	23.80	
		100	0	1	23.36	23.73	23.81	
		16QAM	1	0	1	23.96	24.05	24.77
				50	1	23.93	24.30	24.85
	99			1	24.31	24.54	24.71	
	50		0	2	22.54	22.65	22.98	
			25	2	22.58	22.83	22.90	
			50	2	22.60	22.98	23.00	
	100	0	2	22.51	22.80	22.81		

Any report having not been signed by authorized approver, or having been altered without authorization, or having not been stamped by the "Dedicated Testing/Inspection Stamp" is deemed to be invalid. Copying or excerpting portion of, or altering the content of the report is not permitted without the written authorization of AGC. The test results presented in the report apply only to the tested sample. Any objections to report issued by AGC should be submitted to AGC within 15days after the issuance of the test report. Further enquiry of validity or verification of the test report should be addressed to AGC by agc01@agccert.com.

Conducted Power of LTE Band 5(dBm)								
Bandwidth	Modulation	RB size	RB offset	Target MPR	Channel	Channel	Channel	
					20407	20525	20643	
1.4MHz	QPSK	1	0	0	24.51	24.56	24.85	
			3	0	24.53	24.53	24.95	
			5	0	24.44	24.57	24.90	
		3	0	0	24.35	24.42	24.94	
			2	0	24.43	24.46	24.84	
			3	0	24.37	24.45	24.82	
	6	0	1	23.50	23.54	24.26		
	16QAM	1	0	1	25.07	24.00	24.33	
			3	1	24.96	23.99	24.76	
			5	1	24.98	24.01	24.90	
		3	0	1	23.71	23.46	23.69	
			2	1	23.81	23.46	24.14	
			3	1	23.58	23.51	24.05	
		6	0	2	23.04	22.75	23.24	
		Bandwidth	Modulation	RB size	RB offset	Target MPR	Channel	Channel
20415							20525	20635
3MHz	QPSK	1	0	0	24.40	24.56	24.98	
			7	0	24.32	24.51	24.98	
			14	0	24.36	24.60	24.97	
		8	0	1	23.31	23.50	23.78	
			4	1	23.36	23.53	23.74	
			7	1	23.36	23.48	24.21	
	15	0	1	23.33	23.50	23.90		
	16QAM	1	0	1	24.84	23.93	24.35	
			7	1	24.72	23.99	24.31	
			14	1	24.86	23.96	24.80	
		8	0	2	22.83	22.50	22.87	
			4	2	22.76	22.53	22.85	
			7	2	22.32	22.60	23.23	
		15	0	2	22.89	22.46	22.84	

Any report having not been signed by authorized approver, or having been altered without authorization, or having not been stamped by the "Dedicated Testing/Inspection Stamp" is deemed to be invalid. Copying or excerpting portion of, or altering the content of the report is not permitted without the written authorization of AGC. The test results presented in the report apply only to the tested sample. Any objections to report issued by AGC should be submitted to AGC within 15days after the issuance of the test report. Further enquiry of validity or verification of the test report should be addressed to AGC by agc01@agccert.com.



Conducted Power of LTE Band 5(dBm)								
Bandwidth	Modulation	RB size	RB offset	Target MPR	Channel	Channel	Channel	
					20425	20525	20625	
5MHz	QPSK	1	0	0	24.33	24.41	24.67	
			13	0	24.33	24.38	24.63	
			24	0	24.35	24.49	24.66	
		12	0	1	23.32	23.45	23.74	
			6	1	23.46	23.49	23.80	
			13	1	23.39	23.53	23.85	
		25	0	1	23.33	23.43	23.79	
		16QAM	1	0	1	24.08	23.96	24.68
				13	1	24.13	23.98	24.90
	24			1	24.04	23.99	<b>25.28</b>	
	12		0	2	22.83	22.26	22.70	
			6	2	22.28	22.35	22.67	
			13	2	22.23	22.32	22.74	
	25	0	2	22.51	22.45	22.73		
	Bandwidth	Modulation	RB size	RB offset	Target MPR	Channel	Channel	Channel
					20450	20525	20600	
10MHz	QPSK	1	0	0	24.32	24.31	24.44	
			25	0	24.20	24.37	24.68	
			49	0	24.29	24.59	24.76	
		25	0	1	23.27	23.52	23.95	
			13	1	23.43	23.48	23.68	
			25	1	23.30	23.48	23.71	
		50	0	1	23.39	23.45	23.68	
		16QAM	1	0	1	24.85	24.45	24.30
				25	1	24.91	24.56	24.43
	49			1	24.99	25.21	25.08	
	25		0	2	22.28	22.45	23.03	
			13	2	22.19	22.44	23.19	
			25	2	22.64	22.99	22.80	
	50		0	2	22.36	22.61	23.11	

Any report having not been signed by authorized approver, or having been altered without authorization, or having not been stamped by the "Dedicated Testing/Inspection Stamp" is deemed to be invalid. Copying or excerpting portion of, or altering the content of the report is not permitted without the written authorization of AGC. The test results presented in the report apply only to the tested sample. Any objections to report issued by AGC should be submitted to AGC within 15days after the issuance of the test report. Further enquiry of validity or verification of the test report should be addressed to AGC by agc01@agccert.com.

Conducted Power of LTE Band 12(dBm)								
Bandwidth	Modulation	RB size	RB offset	Target MPR	Channel	Channel	Channel	
					23017	23095	23173	
1.4MHz	QPSK	1	0	0	24.08	23.89	24.10	
			3	0	24.14	24.00	23.87	
			5	0	24.24	24.12	24.00	
		3	0	0	24.11	23.87	23.99	
			2	0	24.15	23.96	23.93	
			3	0	24.09	23.91	23.96	
	6	0	1	23.09	22.85	23.38		
	16QAM	1	0	1	<b>24.30</b>	23.44	22.94	
			3	1	24.23	23.40	23.34	
			5	1	24.29	23.56	23.39	
		3	0	1	23.37	22.93	22.96	
			2	1	23.37	22.85	23.37	
			3	1	23.30	22.83	23.74	
		6	0	2	22.11	21.87	22.59	
Bandwidth		Modulation	RB size	RB offset	Target MPR	Channel	Channel	Channel
						23025	23095	23165
3MHz	QPSK	1	0	0	24.08	23.84	24.03	
			7	0	24.06	24.06	24.03	
			14	0	24.05	24.05	23.90	
		8	0	1	23.07	23.48	23.00	
			4	1	23.07	23.04	22.93	
			7	1	22.80	22.87	23.46	
	15	0	1	23.10	22.97	22.94		
	16QAM	1	0	1	24.07	23.42	22.82	
			7	1	24.07	22.84	22.79	
			14	1	23.85	22.87	23.42	
		8	0	2	21.86	22.40	21.88	
			4	2	21.72	21.87	21.92	
			7	2	22.27	21.79	22.47	
		15	0	2	22.09	21.74	22.01	

Any report having not been signed by authorized approver, or having been altered without authorization, or having not been stamped by the "Dedicated Testing/Inspection Stamp" is deemed to be invalid. Copying or excerpting portion of, or altering the content of the report is not permitted without the written authorization of AGC. The test results presented in the report apply only to the tested sample. Any objections to report issued by AGC should be submitted to AGC within 15days after the issuance of the test report. Further enquiry of validity or verification of the test report should be addressed to AGC by agc01@agccert.com.

Conducted Power of LTE Band 12(dBm)								
Bandwidth	Modulation	RB size	RB offset	Target MPR	Channel	Channel	Channel	
					23035	23095	23155	
5MHz	QPSK	1	0	0	23.97	23.81	23.67	
			13	0	23.97	23.89	23.77	
			24	0	23.91	23.85	23.64	
		12	0	1	23.05	23.36	22.68	
			6	1	22.75	22.93	23.04	
			13	1	22.84	22.86	22.98	
		25	0	1	22.85	22.85	22.95	
		16QAM	1	0	1	23.26	23.52	23.34
				13	1	23.02	22.93	23.49
	24			1	23.13	22.95	23.93	
	12		0	2	22.04	22.23	21.75	
			6	2	22.39	21.78	21.81	
			13	2	22.37	21.76	21.88	
	25	0	2	22.62	21.98	21.99		
	Bandwidth	Modulation	RB size	RB offset	Target MPR	Channel	Channel	Channel
23060						23095	23130	
10MHz	QPSK	1	0	0	24.06	23.99	23.74	
			25	0	24.04	23.98	23.72	
			49	0	24.02	24.00	23.98	
		25	0	1	22.78	23.49	22.88	
			13	1	23.12	22.86	22.83	
			25	1	23.55	22.81	22.95	
		50	0	1	22.89	22.97	22.76	
		16QAM	1	0	1	23.93	23.48	23.86
				25	1	23.60	23.49	23.35
	49			1	23.76	23.53	23.83	
	25		0	2	22.49	22.43	21.91	
			13	2	22.47	21.96	21.78	
			25	2	22.49	21.83	22.01	
	50		0	2	22.58	21.98	21.64	

Any report having not been signed by authorized approver, or having been altered without authorization, or having not been stamped by the "Dedicated Testing/Inspection Stamp" is deemed to be invalid. Copying or excerpting portion of, or altering the content of the report is not permitted without the written authorization of AGC. The test results presented in the report apply only to the tested sample. Any objections to report issued by AGC should be submitted to AGC within 15days after the issuance of the test report. Further enquiry of validity or verification of the test report should be addressed to AGC by agc01@agccert.com.

Conducted Power of LTE Band 13(dBm)								
Bandwidth	Modulation	RB size	RB offset	Target MPR	Channel	Channel	Channel	
					23205	23230	23255	
5MHz	QPSK	1	0	0	24.10	24.50	24.11	
			13	0	<b>24.55</b>	24.12	24.00	
			24	0	24.16	24.08	24.03	
		12	0	1	23.14	23.55	23.12	
			6	1	23.58	23.08	23.09	
			13	1	23.64	23.18	23.16	
		25	1	23.62	23.22	23.13		
		16QAM	1	0	1	22.82	23.51	23.28
				13	1	23.26	23.09	23.32
	24			1	22.85	23.07	23.32	
	12		0	2	22.47	22.50	22.05	
			6	2	22.51	22.06	22.03	
			13	2	22.45	22.08	22.42	
	25	2	22.65	22.22	22.13			
	Bandwidth	Modulation	RB size	RB offset	Target MPR	Channel		
					23230			
10MHz	QPSK	1	0	0	24.21			
			25	0	24.14			
			49	0	24.22			
		25	0	1	23.54			
			13	1	23.02			
			25	1	23.13			
		50	1	23.14				
		16QAM	1	0	1	24.27		
				25	1	24.16		
	49			1	24.11			
	25		0	2	22.63			
			13	2	22.11			
			25	2	22.13			
	50	2	22.22					

Any report having not been signed by authorized approver, or having been altered without authorization, or having not been stamped by the "Dedicated Testing/Inspection Stamp" is deemed to be invalid. Copying or excerpting portion of, or altering the content of the report is not permitted without the written authorization of AGC. The test results presented in the report apply only to the tested sample. Any objections to report issued by AGC should be submitted to AGC within 15days after the issuance of the test report. Further enquiry of validity or verification of the test report should be addressed to AGC by agc01@agccert.com.

Conducted Power of LTE Band 17(dBm)							
Bandwidth	Modulation	RB size	RB offset	Target MPR	Channel	Channel	Channel
					23755	23790	23825
5MHz	QPSK	1	0	0	23.97	23.79	23.71
			13	0	23.79	23.74	23.84
			24	0	23.93	23.72	23.83
		12	0	1	23.40	22.90	22.84
			6	1	23.53	22.90	22.96
			13	1	22.92	22.83	23.06
	25	1	23.53	22.78	23.01		
	16QAM	1	0	1	22.59	23.48	23.01
			13	1	23.11	23.34	23.03
			24	1	22.97	23.34	23.53
		12	0	2	22.34	21.81	21.79
			6	2	22.27	21.71	21.89
			13	2	21.85	21.84	21.79
		25	2	22.45	21.91	22.01	
Bandwidth		Modulation	RB size	RB offset	Target MPR	Channel	Channel
	23780					23790	23800
10MHz	QPSK	1	0	0	24.00	23.90	23.76
			25	0	23.93	23.98	23.90
			49	0	23.95	24.05	24.05
		25	0	1	23.37	22.86	23.00
			13	1	22.87	22.89	22.95
			25	1	22.82	22.85	23.05
	50	1	22.88	22.83	22.95		
	16QAM	1	0	1	23.62	<b>24.22</b>	23.94
			25	1	23.78	23.55	23.40
			49	1	23.91	23.70	23.81
		25	0	2	22.35	22.04	22.07
			13	2	21.94	21.88	21.98
			25	2	22.02	21.88	22.08
		50	2	21.96	21.83	21.80	

Any report having not been signed by authorized approver, or having been altered without authorization, or having not been stamped by the "Dedicated Testing/Inspection Stamp" is deemed to be invalid. Copying or excerpting portion of, or altering the content of the report is not permitted without the written authorization of AGC. The test results presented in the report apply only to the tested sample. Any objections to report issued by AGC should be submitted to AGC within 15days after the issuance of the test report. Further enquiry of validity or verification of the test report should be addressed to AGC by agc01@agccert.com.

Conducted Power of LTE Band 25(dBm)								
Bandwidth	Modulation	RB size	RB offset	Target MPR	Channel	Channel	Channel	
					26047	26365	26683	
1.4MHz	QPSK	1	0	0	23.98	23.71	23.98	
			2	0	24.09	23.79	23.93	
			5	0	24.01	23.75	23.94	
		3	0	0	23.90	23.92	23.91	
			1	0	23.94	23.92	23.91	
			3	0	23.87	23.96	23.92	
	6	0	1	22.85	22.90	22.84		
	16QAM	1	0	1	23.85	22.82	22.92	
			2	1	23.88	23.03	22.89	
			5	1	23.88	22.95	22.92	
		3	0	1	23.08	22.93	22.92	
			1	1	23.10	22.89	22.87	
			3	1	23.08	22.89	22.88	
		6	0	2	22.27	21.89	21.99	
		Bandwidth	Modulation	RB size	RB offset	Target MPR	Channel	Channel
26055							26365	26675
3MHz	QPSK	1	0	0	23.83	23.71	23.92	
			8	0	23.86	23.76	23.98	
			14	0	23.90	23.76	23.95	
		8	0	1	22.92	22.81	22.99	
			4	1	22.97	22.83	22.90	
			7	1	22.96	22.79	22.90	
	15	0	1	22.82	22.91	23.03		
	16QAM	1	0	1	23.93	22.88	23.21	
			8	1	23.95	22.99	23.20	
			14	1	24.01	22.97	23.10	
		8	0	2	22.21	22.29	22.03	
			4	2	22.16	21.98	21.96	
			7	2	21.90	21.99	21.88	
		15	0	2	22.40	21.91	22.00	

Any report having not been signed by authorized approver, or having been altered without authorization, or having not been stamped by the "Dedicated Testing/Inspection Stamp" is deemed to be invalid. Copying or excerpting portion of, or altering the content of the report is not permitted without the written authorization of AGC. The test results presented in the report apply only to the tested sample. Any objections to report issued by AGC should be submitted to AGC within 15days after the issuance of the test report. Further enquiry of validity or verification of the test report should be addressed to AGC by agc01@agccert.com.

Conducted Power of LTE Band 25(dBm)								
Bandwidth	Modulation	RB size	RB offset	Target MPR	Channel	Channel	Channel	
					26065	26365	26665	
5MHz	QPSK	1	0	0	23.82	23.83	23.92	
			12	0	23.88	23.86	23.90	
			24	0	23.98	23.91	23.84	
		12	0	1	22.84	22.85	22.97	
			6	1	22.97	22.83	22.86	
			13	1	22.97	22.88	22.96	
		25	0	1	23.01	22.86	22.91	
		16QAM	1	0	1	23.06	22.49	22.88
				12	1	23.11	22.52	22.86
	24			1	23.20	22.61	22.87	
	12		0	2	22.23	22.07	22.25	
			6	2	21.89	21.77	21.96	
			13	2	21.85	21.78	21.94	
	25	0	2	21.96	21.98	21.95		
	Bandwidth	Modulation	RB size	RB offset	Target MPR	Channel	Channel	Channel
					26090	26365	26640	
10MHz	QPSK	1	0	0	23.86	23.99	23.95	
			24	0	24.00	23.93	23.94	
			49	0	24.12	24.00	23.99	
		25	0	1	22.93	22.87	22.87	
			12	1	22.99	22.89	22.93	
			25	1	23.09	22.85	22.93	
		50	0	1	22.93	22.95	22.92	
		16QAM	1	0	1	23.98	22.93	22.85
				24	1	24.04	22.95	22.93
	49			1	24.20	22.98	22.87	
	25		0	2	21.97	22.23	22.30	
			12	2	22.03	21.97	21.94	
			25	2	22.17	21.98	21.99	
	50		0	2	22.08	22.06	22.03	

Any report having not been signed by authorized approver, or having been altered without authorization, or having not been stamped by the "Dedicated Testing/Inspection Stamp" is deemed to be invalid. Copying or excerpting portion of, or altering the content of the report is not permitted without the written authorization of AGC. The test results presented in the report apply only to the tested sample. Any objections to report issued by AGC should be submitted to AGC within 15days after the issuance of the test report. Further enquiry of validity or verification of the test report should be addressed to AGC by agc01@agccert.com.

Conducted Power of LTE Band 25(dBm)							
Bandwidth	Modulation	RB size	RB offset	Target MPR	Channel	Channel	Channel
					26115	26365	26615
15MHz	QPSK	1	0	0	23.89	24.00	23.91
			38	0	24.05	23.98	23.93
			74	0	24.11	23.97	23.91
		38	0	1	22.84	22.94	22.81
			18	1	23.09	22.82	22.87
			37	1	23.16	22.97	22.84
	75	0	1	23.14	22.85	22.79	
	16QAM	1	0	1	23.97	23.00	23.46
			38	1	24.19	22.91	23.48
			74	1	<b>24.27</b>	22.99	23.55
		38	0	2	21.98	22.05	22.28
			18	2	22.08	22.12	22.27
			37	2	22.40	22.18	22.26
	75	0	2	22.20	21.90	22.35	
Bandwidth	Modulation	RB size	RB offset	Target MPR	Channel	Channel	Channel
					26140	26365	26590
20MHz	QPSK	1	0	0	23.92	24.06	24.11
			49	0	24.17	24.06	24.10
			99	0	24.17	24.16	24.11
		50	0	1	23.04	22.97	22.92
			25	1	23.19	22.80	22.95
			49	1	23.14	22.94	23.02
	100	0	1	23.12	22.95	22.94	
	16QAM	1	0	1	22.58	22.59	22.92
			49	1	22.80	22.50	22.87
			99	1	22.86	22.67	22.91
		50	0	2	22.13	21.98	22.31
			25	2	22.19	22.01	22.32
			49	2	22.26	22.15	22.04
	100	0	2	22.16	22.04	22.36	

Any report having not been signed by authorized approver, or having been altered without authorization, or having not been stamped by the "Dedicated Testing/Inspection Stamp" is deemed to be invalid. Copying or excerpting portion of, or altering the content of the report is not permitted without the written authorization of AGC. The test results presented in the report apply only to the tested sample. Any objections to report issued by AGC should be submitted to AGC within 15days after the issuance of the test report. Further enquiry of validity or verification of the test report should be addressed to AGC by agc01@agccert.com.



Conducted Power of LTE Band 26A(dBm)								
Bandwidth	Modulation	RB size	RB offset	Target MPR	Channel	Channel	Channel	
					26797	26915	27033	
1.4MHz	QPSK	1	0	0	24.67	24.63	24.97	
			2	0	24.67	24.58	24.95	
			5	0	24.65	24.65	24.96	
		3	0	0	24.02	23.92	24.40	
			1	0	24.08	23.98	24.33	
			3	0	24.04	23.93	24.34	
		6	0	1	23.08	23.00	23.37	
		16QAM	1	0	1	24.94	24.05	24.45
				2	1	24.93	23.94	24.41
	5			1	24.96	24.11	24.47	
	3		0	1	23.14	23.01	23.28	
			1	1	23.22	22.92	23.26	
			3	1	23.19	23.01	23.30	
	6	0	2	22.60	22.66	22.43		
	Bandwidth	Modulation	RB size	RB offset	Target MPR	Channel	Channel	Channel
26805						26915	27025	
3MHz	QPSK	1	0	0	24.52	24.66	24.92	
			8	0	24.47	24.59	24.95	
			14	0	24.41	24.71	25.00	
		8	0	1	23.10	22.94	23.44	
			4	1	23.02	22.96	23.40	
			7	1	23.01	23.04	23.38	
		15	0	1	22.98	22.94	23.51	
		16QAM	1	0	1	25.15	24.04	24.39
				8	1	24.98	23.96	24.35
	14			1	25.02	24.03	24.49	
	8		0	2	22.35	22.09	22.36	
			4	2	22.29	22.40	22.33	
			7	2	22.34	22.51	22.32	
	15		0	2	22.62	22.43	22.38	

Any report having not been signed by authorized approver, or having been altered without authorization, or having not been stamped by the "Dedicated Testing/Inspection Stamp" is deemed to be invalid. Copying or excerpting portion of, or altering the content of the report is not permitted without the written authorization of AGC. The test results presented in the report apply only to the tested sample. Any objections to report issued by AGC should be submitted to AGC within 15days after the issuance of the test report. Further enquiry of validity or verification of the test report should be addressed to AGC by agc01@agccert.com.

Conducted Power of LTE Band 26A(dBm)								
Bandwidth	Modulation	RB size	RB offset	Target MPR	Channel	Channel	Channel	
					26815	26915	27015	
5MHz	QPSK	1	0	0	24.47	24.43	24.76	
			12	0	24.37	24.41	24.79	
			24	0	24.36	24.54	24.80	
		12	0	1	23.01	23.02	23.31	
			6	1	22.96	22.99	23.39	
			13	1	22.90	23.05	23.49	
	25	0	1	22.97	22.99	23.32		
	16QAM	1	0	1	24.20	24.10	24.19	
			12	1	24.10	24.02	24.32	
			24	1	24.10	24.17	24.32	
		12	0	2	22.41	21.77	22.24	
			6	2	22.39	22.24	22.27	
			13	2	22.46	22.32	22.37	
		25	0	2	22.68	22.45	22.32	
Bandwidth		Modulation	RB size	RB offset	Target MPR	Channel	Channel	Channel
	26840					26915	26990	
10MHz	QPSK	1	0	0	24.45	24.35	24.50	
			24	0	24.20	24.47	24.73	
			49	0	24.33	24.63	24.90	
		25	0	1	23.47	23.43	23.79	
			12	1	23.61	23.44	23.87	
			25	1	23.53	23.52	23.89	
		50	0	1	23.52	23.49	23.86	
		16QAM	1	0	1	24.91	24.64	24.44
				24	1	25.04	24.70	24.53
	49			1	24.89	24.93	24.70	
	25		0	2	22.93	22.45	23.29	
			12	2	22.59	22.95	23.29	
			25	2	22.56	22.68	22.88	
	50		0	2	22.69	23.00	23.23	

Any report having not been signed by authorized approver, or having been altered without authorization, or having not been stamped by the "Dedicated Testing/Inspection Stamp" is deemed to be invalid. Copying or excerpting portion of, or altering the content of the report is not permitted without the written authorization of AGC. The test results presented in the report apply only to the tested sample. Any objections to report issued by AGC should be submitted to AGC within 15days after the issuance of the test report. Further enquiry of validity or verification of the test report should be addressed to AGC by agc01@agccert.com.

Conducted Power of LTE Band 26A(dBm)								
Bandwidth	Modulation	RB size	RB offset	Target MPR	Channel	Channel	Channel	
					26865	26915	26965	
15MHz	QPSK	1	0	0	24.38	24.29	24.38	
			38	0	24.40	24.47	24.61	
			74	0	24.51	24.77	24.90	
		38	0	1	23.60	23.43	23.68	
			18	1	23.49	23.50	23.71	
			37	1	23.52	23.64	23.80	
		75	0	1	23.51	23.52	23.63	
		16QAM	1	0	1	24.96	23.85	24.80
				38	1	24.97	23.98	24.97
	74			1	25.01	24.21	<b>25.25</b>	
	38		0	2	22.60	22.51	22.49	
			18	2	22.44	23.07	23.17	
			37	2	22.55	23.33	22.78	
	75	0	2	22.57	23.00	23.23		

Any report having not been signed by authorized approver, or having been altered without authorization, or having not been stamped by the "Dedicated Testing/Inspection Stamp" is deemed to be invalid. Copying or excerpting portion of, or altering the content of the report is not permitted without the written authorization of AGC. The test results presented in the report apply only to the tested sample. Any objections to report issued by AGC should be submitted to AGC within 15days after the issuance of the test report. Further enquiry of validity or verification of the test report should be addressed to AGC by agc01@agccert.com.

Conducted Power of LTE Band 26B(dBm)							
Bandwidth	Modulation	RB size	RB offset	Target MPR	Channel	Channel	Channel
					26697	26740	26783
1.4MHz	QPSK	1	0	0	24.94	24.79	24.51
			2	0	25.01	24.79	24.48
			5	0	24.90	24.74	24.49
		3	0	0	24.44	24.26	24.10
			1	0	24.36	24.16	23.99
			3	0	24.36	24.19	23.92
	6	0	1	23.66	23.18	22.99	
	16QAM	1	0	1	25.70	24.17	24.01
			2	1	25.69	24.05	24.01
			5	1	<b>25.71</b>	24.06	24.07
		3	0	1	23.98	23.14	22.95
			1	1	23.89	23.08	22.87
			3	1	23.94	23.04	23.01
	6	0	2	22.63	22.79	22.15	
	Bandwidth	Modulation	RB size	RB offset	Target MPR	Channel	Channel
26705						26740	26775
3MHz	QPSK	1	0	0	24.92	24.88	24.70
			8	0	24.81	24.77	24.48
			14	0	24.89	24.74	24.55
		8	0	1	23.50	23.23	23.14
			4	1	23.47	23.18	23.13
			7	1	23.32	23.17	23.04
	15	0	1	23.44	23.19	23.11	
	16QAM	1	0	1	25.48	24.28	24.12
			8	1	25.47	24.06	24.03
			14	1	25.42	24.05	23.98
		8	0	2	22.38	22.74	22.09
			4	2	22.36	22.68	22.03
			7	2	22.16	22.56	22.11
	15	0	2	22.62	22.61	22.19	

Any report having not been signed by authorized approver, or having been altered without authorization, or having not been stamped by the "Dedicated Testing/Inspection Stamp" is deemed to be invalid. Copying or excerpting portion of, or altering the content of the report is not permitted without the written authorization of AGC. The test results presented in the report apply only to the tested sample. Any objections to report issued by AGC should be submitted to AGC within 15days after the issuance of the test report. Further enquiry of validity or verification of the test report should be addressed to AGC by agc01@agccert.com.

Conducted Power of LTE Band 26B(dBm)								
Bandwidth	Modulation	RB size	RB offset	Target MPR	Channel	Channel	Channel	
					26715	26740	26765	
5MHz	QPSK	1	0	0	24.89	24.81	24.50	
			12	0	24.84	24.65	24.47	
			24	0	24.70	24.56	24.33	
		12	0	1	23.51	23.34	23.28	
			6	1	23.30	23.15	23.26	
			13	1	23.30	23.14	23.02	
		25	0	1	23.31	23.19	23.10	
		16QAM	1	0	1	24.72	24.42	24.81
				12	1	24.59	24.15	24.75
	24			1	24.49	24.29	24.60	
	12		0	2	22.33	22.12	22.06	
			6	2	22.21	22.53	22.06	
			13	2	22.06	22.04	21.98	
	25	0	2	22.33	22.71	22.25		
	Bandwidth	Modulation	RB size	RB offset	Target MPR	Channel		
10MHz	QPSK	1	0	0	24.91			
			24	0	24.66			
			49	0	24.59			
		25	0	1	23.74			
			12	1	23.65			
			25	1	23.64			
		50	0	1	23.68			
		16QAM	1	0	1	25.33		
				24	1	25.06		
	49			1	24.93			
	25		0	2	22.74			
			12	2	23.15			
			25	2	22.70			
	50	0	2	23.13				
	Bandwidth	Modulation	RB size	RB offset	Target MPR	Channel		
					26740			

Any report having not been signed by authorized approver, or having been altered without authorization, or having not been stamped by the "Dedicated Testing/Inspection Stamp" is deemed to be invalid. Copying or excerpting portion of, or altering the content of the report is not permitted without the written authorization of AGC. The test results presented in the report apply only to the tested sample. Any objections to report issued by AGC should be submitted to AGC within 15days after the issuance of the test report. Further enquiry of validity or verification of the test report should be addressed to AGC by agc01@agccert.com.

Conducted Power of LTE Band 41(dBm)							
Bandwidth	Modulation	RB size	RB offset	Target MPR	Channel	Channel	Channel
					39675	40620	41565
5MHz	QPSK	1	0	0	23.89	23.50	23.65
			12	0	24.00	23.35	23.72
			24	0	23.97	23.33	23.78
		12	0	1	23.97	23.68	23.49
			6	1	24.01	23.65	23.60
			13	1	23.96	23.48	23.65
	25	0	1	23.91	23.53	23.60	
	16QAM	1	0	1	23.24	23.60	22.78
			12	1	23.19	23.47	22.81
			24	1	23.26	23.49	22.96
		12	0	2	22.86	22.70	22.54
			6	2	22.89	22.61	22.66
			13	2	22.93	22.66	22.66
	25	0	2	23.09	22.82	22.96	
Bandwidth	Modulation	RB size	RB offset	Target MPR	Channel	Channel	Channel
					39700	40620	41540
10MHz	QPSK	1	0	0	23.73	23.62	23.40
			24	0	23.76	23.58	23.41
			49	0	23.80	23.43	23.48
		25	0	1	23.78	23.46	23.45
			12	1	23.89	23.44	23.47
			25	1	23.93	23.38	23.60
	50	0	1	23.78	23.34	23.52	
	16QAM	1	0	1	24.25	22.27	23.29
			24	1	24.25	22.18	23.46
			49	1	24.38	22.13	23.51
		25	0	2	23.17	22.53	22.55
			12	2	23.14	22.53	22.58
			25	2	23.19	22.47	22.60
	50	0	2	22.86	22.60	22.62	

Any report having not been signed by authorized approver, or having been altered without authorization, or having not been stamped by the "Dedicated Testing/Inspection Stamp" is deemed to be invalid. Copying or excerpting portion of, or altering the content of the report is not permitted without the written authorization of AGC. The test results presented in the report apply only to the tested sample. Any objections to report issued by AGC should be submitted to AGC within 15days after the issuance of the test report. Further enquiry of validity or verification of the test report should be addressed to AGC by agc01@agccert.com.

Conducted Power of LTE Band 41(dBm)							
Bandwidth	Modulation	RB size	RB offset	Target MPR	Channel	Channel	Channel
					39725	40620	41515
15MHz	QPSK	1	0	0	23.64	23.52	23.26
			37	0	23.84	23.55	23.33
			74	0	23.84	23.48	23.34
		37	0	1	23.75	23.47	23.49
			19	1	23.85	23.41	23.37
			38	1	23.82	23.40	23.41
	75	0	1	23.77	23.49	23.44	
	16QAM	1	0	1	24.19	22.19	23.08
			37	1	24.17	22.25	23.11
			74	1	<b>24.40</b>	22.12	23.26
		37	0	2	23.00	22.75	22.42
			19	2	22.98	22.70	22.47
			38	2	22.92	22.67	22.50
	75	0	2	23.00	22.70	22.71	
Bandwidth	Modulation	RB size	RB offset	Target MPR	Channel	Channel	Channel
					39750	40620	41490
20MHz	QPSK	1	0	0	23.90	23.77	23.78
			49	0	24.05	23.61	23.80
			99	0	24.09	23.53	23.77
		50	0	1	23.98	23.73	23.57
			25	1	24.00	23.53	23.51
			50	1	24.08	23.57	23.63
	100	0	1	24.01	23.55	23.64	
	16QAM	1	0	1	23.12	22.92	22.92
			49	1	23.22	22.72	22.35
			99	1	23.27	22.84	22.83
		50	0	2	23.25	22.77	22.86
			25	2	23.14	22.60	22.81
			50	2	23.34	22.61	22.91
	100	0	2	23.08	22.76	22.79	

Any report having not been signed by authorized approver, or having been altered without authorization, or having not been stamped by the "Dedicated Testing/Inspection Stamp" is deemed to be invalid. Copying or excerpting portion of, or altering the content of the report is not permitted without the written authorization of AGC. The test results presented in the report apply only to the tested sample. Any objections to report issued by AGC should be submitted to AGC within 15days after the issuance of the test report. Further enquiry of validity or verification of the test report should be addressed to AGC by agc01@agccert.com.

Conducted Power of LTE Band 66(dBm)								
Bandwidth	Modulation	RB size	RB offset	Target MPR	Channel	Channel	Channel	
					131979	132322	132665	
1.4MHz	QPSK	1	0	0	24.50	24.73	24.97	
			2	0	24.50	24.76	25.04	
			5	0	24.52	24.78	25.06	
		3	0	0	24.39	24.82	25.00	
			1	0	24.41	24.75	24.94	
			3	0	24.34	24.80	25.00	
	6	0	1	23.38	23.90	24.02		
	16QAM	1	0	1	24.53	23.92	24.25	
			2	1	24.45	23.91	24.34	
			5	1	24.45	23.94	24.34	
		3	0	1	23.58	23.62	24.52	
			1	1	23.57	23.53	24.39	
			3	1	23.60	23.64	24.35	
		6	0	2	22.54	23.09	23.20	
		Bandwidth	Modulation	RB size	RB offset	Target MPR	Channel	Channel
131987							132322	132657
3MHz	QPSK	1	0	0	24.32	24.65	25.04	
			8	0	24.31	24.69	25.07	
			14	0	24.29	24.67	25.04	
		8	0	1	23.28	23.90	24.06	
			4	1	23.30	23.92	23.99	
			7	1	23.33	23.85	23.97	
	15	0	1	23.35	23.89	23.97		
	16QAM	1	0	1	24.48	24.35	24.36	
			8	1	24.50	24.44	24.38	
			14	1	24.53	24.26	24.31	
		8	0	2	22.35	23.15	23.10	
			4	2	22.32	23.17	23.03	
			7	2	22.33	23.15	23.09	
		15	0	2	22.56	23.04	23.07	

Any report having not been signed by authorized approver, or having been altered without authorization, or having not been stamped by the "Dedicated Testing/Inspection Stamp" is deemed to be invalid. Copying or excerpting portion of, or altering the content of the report is not permitted without the written authorization of AGC. The test results presented in the report apply only to the tested sample. Any objections to report issued by AGC should be submitted to AGC within 15days after the issuance of the test report. Further enquiry of validity or verification of the test report should be addressed to AGC by agc01@agccert.com.



Conducted Power of LTE Band 66(dBm)								
Bandwidth	Modulation	RB size	RB offset	Target MPR	Channel	Channel	Channel	
					131997	132322	132647	
5MHz	QPSK	1	0	0	24.23	24.79	24.96	
			12	0	24.26	24.88	24.99	
			24	0	24.29	24.80	25.04	
		12	0	1	23.37	23.80	24.04	
			6	1	23.31	23.89	24.09	
			13	1	23.37	23.70	24.08	
		25	0	1	23.32	23.90	24.07	
		16QAM	1	0	1	23.59	23.45	23.94
				12	1	23.56	23.98	24.02
	24			1	23.52	23.82	23.99	
	12		0	2	22.32	22.61	23.00	
			6	2	22.37	22.78	23.02	
			13	2	22.31	22.58	23.04	
	25	0	2	22.46	23.01	23.25		
	Bandwidth	Modulation	RB size	RB offset	Target MPR	Channel	Channel	Channel
132022						132322	132622	
10MHz	QPSK	1	0	0	24.41	24.88	24.92	
			24	0	24.35	24.94	25.04	
			49	0	24.34	24.83	25.11	
		25	0	1	23.27	23.73	23.88	
			12	1	23.31	23.81	24.03	
			25	1	23.36	23.66	24.03	
		50	0	1	23.34	24.00	23.94	
		16QAM	1	0	1	24.58	23.79	23.82
				24	1	24.56	23.88	23.96
	49			1	24.56	23.71	24.05	
	25		0	2	22.34	22.88	22.97	
			12	2	22.33	23.04	23.04	
			25	2	22.34	22.86	23.11	
	50		0	2	22.34	23.07	23.03	

Any report having not been signed by authorized approver, or having been altered without authorization, or having not been stamped by the "Dedicated Testing/Inspection Stamp" is deemed to be invalid. Copying or excerpting portion of, or altering the content of the report is not permitted without the written authorization of AGC. The test results presented in the report apply only to the tested sample. Any objections to report issued by AGC should be submitted to AGC within 15days after the issuance of the test report. Further enquiry of validity or verification of the test report should be addressed to AGC by agc01@agccert.com.

Conducted Power of LTE Band 66(dBm)								
Bandwidth	Modulation	RB size	RB offset	Target MPR	Channel	Channel	Channel	
					132047	132322	132597	
15MHz	QPSK	1	0	0	24.42	24.86	24.69	
			38	0	24.34	24.96	24.89	
			74	0	24.41	24.79	25.08	
		38	0	1	23.33	23.82	23.74	
			18	1	23.36	23.98	23.88	
			37	1	23.30	23.68	24.04	
		75	1	23.41	23.92	23.89		
		16QAM	1	0	1	24.61	23.77	24.50
				38	1	24.56	23.84	24.79
	74			1	24.55	23.62	24.96	
	38		0	2	22.40	23.03	22.77	
			18	2	22.35	23.15	22.97	
			37	2	22.44	22.92	23.03	
	75	2	22.42	22.98	23.04			
	Bandwidth	Modulation	RB size	RB offset	Target MPR	Channel	Channel	Channel
					132072	132322	132572	
20MHz	QPSK	1	0	0	24.43	25.08	24.55	
			49	0	24.34	<b>25.28</b>	24.79	
			99	0	24.79	24.98	25.09	
		50	0	1	23.29	23.73	23.59	
			25	1	23.38	23.97	23.85	
			50	1	23.51	23.66	23.93	
		100	1	23.44	23.83	23.78		
		16QAM	1	0	1	23.46	23.30	23.86
				49	1	23.42	23.38	24.14
	99			1	23.80	23.16	24.36	
	50		0	2	22.50	22.87	22.73	
			25	2	22.52	23.01	22.98	
			50	2	22.71	22.74	23.10	
	100	2	22.50	22.93	22.89			

Any report having not been signed by authorized approver, or having been altered without authorization, or having not been stamped by the "Dedicated Testing/Inspection Stamp" is deemed to be invalid. Copying or excerpting portion of, or altering the content of the report is not permitted without the written authorization of AGC. The test results presented in the report apply only to the tested sample. Any objections to report issued by AGC should be submitted to AGC within 15days after the issuance of the test report. Further enquiry of validity or verification of the test report should be addressed to AGC by agc01@agccert.com.

Conducted Power of LTE Band 71(dBm)								
Bandwidth	Modulation	RB size	RB offset	Target MPR	Channel	Channel	Channel	
					133147	133297	133447	
5MHz	QPSK	1	0	0	23.20	22.95	22.79	
			12	0	23.53	22.90	22.65	
			24	0	23.02	23.28	22.65	
		12	0	1	22.31	22.49	21.90	
			6	1	22.69	22.48	21.75	
			13	1	22.73	22.32	21.63	
	25	0	1	22.77	22.52	21.69		
	16QAM	1	0	1	22.41	22.48	22.47	
			12	1	22.82	22.79	22.44	
			24	1	22.78	22.75	22.41	
		12	0	2	21.05	21.40	21.16	
			6	2	21.60	21.37	20.65	
			13	2	21.58	21.24	20.62	
		25	0	2	21.74	21.37	20.86	
Bandwidth		Modulation	RB size	RB offset	Target MPR	Channel	Channel	Channel
						133172	133297	133422
10MHz	QPSK	1	0	0	23.37	23.15	23.08	
			24	0	23.15	23.22	22.90	
			49	0	23.31	23.10	22.79	
		25	0	1	22.66	22.17	22.15	
			12	1	22.58	22.42	22.14	
			25	1	22.57	22.40	21.75	
	50	0	1	22.77	22.43	21.90		
	16QAM	1	0	1	23.77	22.88	22.34	
			24	1	<b>24.15</b>	22.88	22.21	
			49	1	23.72	22.52	22.18	
		25	0	2	21.55	21.50	20.95	
			12	2	21.55	21.48	21.27	
			25	2	21.38	21.41	20.73	
		50	0	2	21.60	21.52	21.24	

Any report having not been signed by authorized approver, or having been altered without authorization, or having not been stamped by the "Dedicated Testing/Inspection Stamp" is deemed to be invalid. Copying or excerpting portion of, or altering the content of the report is not permitted without the written authorization of AGC. The test results presented in the report apply only to the tested sample. Any objections to report issued by AGC should be submitted to AGC within 15days after the issuance of the test report. Further enquiry of validity or verification of the test report should be addressed to AGC by agc01@agccert.com.

Conducted Power of LTE Band 71(dBm)								
Bandwidth	Modulation	RB size	RB offset	Target MPR	Channel	Channel	Channel	
					133197	133297	133397	
15MHz	QPSK	1	0	0	23.13	23.01	22.97	
			38	0	22.99	23.07	22.82	
			74	0	23.05	23.05	22.80	
		38	0	1	22.76	22.12	22.19	
			18	1	22.44	22.52	22.21	
			37	1	22.29	22.07	22.12	
		75	0	1	22.46	22.51	22.16	
		16QAM	1	0	1	23.78	22.62	22.93
				38	1	23.92	23.01	22.88
	74			1	23.41	22.50	22.78	
	38		0	2	21.70	21.63	21.00	
			18	2	21.51	21.63	20.99	
			37	2	21.62	21.46	21.30	
	75	0	2	21.49	21.39	21.06		
	Bandwidth	Modulation	RB size	RB offset	Target MPR	Channel	Channel	Channel
133222						133322	133372	
20MHz	QPSK	1	0	0	23.11	23.32	22.96	
			49	0	22.99	23.22	23.05	
			99	0	23.31	23.22	22.75	
		50	0	1	22.71	22.54	21.95	
			25	1	22.26	22.48	22.10	
			50	1	22.20	22.15	22.15	
		100	0	1	22.25	22.52	22.12	
		16QAM	1	0	1	22.52	22.71	22.69
				49	1	22.27	22.99	22.59
	99			1	22.68	22.65	22.22	
	50		0	2	21.75	21.46	21.32	
			25	2	21.45	21.48	20.99	
			50	2	21.69	21.51	21.31	
	100		0	2	21.34	21.53	20.99	

Any report having not been signed by authorized approver, or having been altered without authorization, or having not been stamped by the "Dedicated Testing/Inspection Stamp" is deemed to be invalid. Copying or excerpting portion of, or altering the content of the report is not permitted without the written authorization of AGC. The test results presented in the report apply only to the tested sample. Any objections to report issued by AGC should be submitted to AGC within 15days after the issuance of the test report. Further enquiry of validity or verification of the test report should be addressed to AGC by agc01@agccert.com.

The following tests were conducted according to the test requirements outlined in section 6.2 of the 3GPP TS36.101 specification.

UE Power Class: 3 (23 +/- 2dBm). The allowed Maximum Power Reduction (MPR) for the maximum output power due to higher order modulation and transmit bandwidth configuration (resource blocks) is specified in Table 6.2.3.3-1 of the 3GPP TS36.101.

**Table 6.2.3.3-1 Maximum Power Reduction (MPR) for Power class3**

Modulation	Maximum Power Reduction (MPR) for Power[RB]						MPR(dB)
	1.4MHz	3MHz	5MHz	10MHz	15MHz	20MHz	
QPSK	>5	>4	>8	>12	>16	>18	≤1
16QAM	≤5	≤4	≤8	≤12	≤16	≤18	≤1
16QAM	>5	>4	>8	>12	>16	>18	≤2

The allowed A-MPR values specified below in Table 6.2.4.3-1 of 3GPP TS36.101 are in addition to the allowed MPR requirements. All the measurements below were performed with A-MPR disabled, by using Network Signaling Value of "NS\_01".3

Any report having not been signed by authorized approver, or having been altered without authorization, or having not been stamped by the "Dedicated Testing/Inspection Stamp" is deemed to be invalid. Copying or excerpting portion of, or altering the content of the report is not permitted without the written authorization of AGC. The test results presented in the report apply only to the tested sample. Any objections to report issued by AGC should be submitted to AGC within 15days after the issuance of the test report. Further enquiry of validity or verification of the test report should be addressed to AGC by agc01@agccert.com.

**Table 6.2.4.3-1: Additional Maximum Power Reduction (A-MPR) / Spectrum Emission requirements**

Network Signaling value	Requirements (sub-clause)	E-UTRA Band	Channel bandwidth (MHz)	Resources Blocks ( $N_{RB}$ )	A-MPR (dB)
NS_01	6.6.2.1.1	Table 5.2-1	1.4,3,5,10,15,20	Table 5.4.2-1	N/A
NS_03	6.6.2.2.3.1	2,4,10, 23, 25,35,36	3	>5	$\leq 1$
			5	>6	$\leq 1$
			10	>6	$\leq 1$
			15	>8	$\leq 1$
			20	>10	$\leq 1$
NS_04	6.6.2.2.3.2	41	5	>6	$\leq 1$
			10, 15, 20	Table 6.2.4.3-4	
NS_05	6.6.3.3.3.1	1	10,15,20	$\geq 50$	$\leq 1$
NS_06	6.6.2.2.3.3	12, 13, 14, 17	1.4, 3, 5, 10	Table 5.4.2-1	N/A
NS_07	6.6.2.2.3.3 6.6.3.3.3.2	13	10	Table 6.2.4.3-2	Table 6.2.4.3-2
NS_08	6.6.3.3.3.3	19	10, 15	> 44	$\leq 3$
NS_09	6.6.3.3.3.4	21	10, 15	> 40	$\leq 1$
				> 55	$\leq 2$
NS_10		20	15, 20	Table 6.2.4.3-3	Table 6.2.4.3-3
NS_11	6.6.2.2.1 6.6.3.3.13	231	1.4, 3, 5, 10,15,20	Table 6.2.4.3-5	Table 6.2.4.3-5
NS_12	6.6.3.3.5	26	1.4, 3, 5	Table 6.2.4.3-6	Table 6.2.4.3-6
NS_13	6.6.3.3.6	26	5	Table 6.2.4.3-7	Table 6.2.4.3-7
NS_14	6.6.3.3.7	26	10, 15	Table 6.2.4.3-8	Table 6.2.4.3-8
NS_15	6.6.3.3.8	26	1.4, 3, 5, 10, 15	Table 6.2.4.3-9 Table 6.2.4.3-10	Table 6.2.4.3-9, Table 6.2.4.3-10
NS_16	6.6.3.3.9	27	3, 5, 10	Table 6.2.4.3-11, Table 6.2.4.3-12, Table 6.2.4.3-13	
NS_17	6.6.3.3.10 6.6.3.3.11	28 28	5, 10	Table 5.4.2-1	N/A
			5	$\geq 2$	$\leq 1$
NS_18			10, 15, 20	$\geq 1$	$\leq 4$
NS_19			10, 15, 20	Table 6.2.4.3-15	Table 6.2.4.3-15
NS_20			5, 10, 15, 20	Table 6.2.4.3-14	Table 6.2.4.3-14
...					
NS_20	-	-	-	-	-

Any report having not been signed by authorized approver, or having been altered without authorization, or having not been stamped by the "Dedicated Testing/Inspection Stamp" is deemed to be invalid. Copying or excerpting portion of, or altering the content of the report is not permitted without the written authorization of AGC. The test results presented in the report apply only to the tested sample. Any objections to report issued by AGC should be submitted to AGC within 15days after the issuance of the test report. Further enquiry of validity or verification of the test report should be addressed to AGC by agc01@agccert.com.

**WIFI**

Mode	Data Rate (Mbps)	Channel	Frequency(MHz)	Avg. Burst Power(dBm)
802.11b	1	01	2412	<b>16.52</b>
		06	2437	15.11
		11	2462	14.65
802.11g	6	01	2412	14.03
		06	2437	13.60
		11	2462	12.75
802.11n(20)	6.5	01	2412	11.88
		06	2437	11.63
		11	2462	10.21
802.11n(40)	13.5	03	2422	11.70
		06	2437	12.64
		09	2452	8.46

**Bluetooth\_V5.3(BR/EDR)**

Modulation	Channel	Frequency(MHz)	Peak Power (dBm)
GFSK	0	2402	2.93
	39	2441	1.56
	78	2480	2.10
π /4-DQPSK	0	2402	3.12
	39	2441	1.72
	78	2480	2.42
8-DPSK	0	2402	<b>3.32</b>
	39	2441	1.75
	78	2480	2.52

**Bluetooth\_V5.3(BLE)**

Modulation	Channel	Frequency(MHz)	Peak Power (dBm)
GFSK_1M	0	2402	<b>-1.48</b>
	19	2440	-2.72
	39	2480	-2.95

Note 1:

**BR/EDR:** Calculation Value =[(max. power of channel, mW)/(min. test separation distance, mm)] ·[√f(GHz)].= 2.148/5\*√2.402=0.666 ≤ 3.0

**BLE\_GFSK\_1M:** Calculation Value =[(max. power of channel, mW)/(min. test separation distance, mm)] ·[√f(GHz)].=0.711/5\*√2.402=0.220 ≤ 3.0

According to KDB447498 D01 V06, threshold at which no SAR required is ≤3.0 for 1-g SAR, separation distance is 5mm, and the SAR evaluation for BT is not required.

Any report having not been signed by authorized approver, or having been altered without authorization, or having not been stamped by the “Dedicated Testing/Inspection Stamp” is deemed to be invalid. Copying or excerpting portion of, or altering the content of the report is not permitted without the written authorization of AGC. The test results presented in the report apply only to the tested sample. Any objections to report issued by AGC should be submitted to AGC within 15days after the issuance of the test report. Further enquiry of validity or verification of the test report should be addressed to AGC by agc01@agccert.com.

**5GHz WIFI**

Mode	channel	Frequency	Power(dBm)
			Data Rate(bps)
802.11a	52	5260	-0.78
	60	5300	-0.88
	64	5320	-0.83
	100	5500	3.91
	116	5580	5.58
	140	5700	5.71
802.11n (20)	52	5260	-3.96
	60	5300	-4.04
	64	5320	-3.90
	100	5500	1.19
	116	5580	3.23
	140	5700	3.63
802.11n (40)	54	5270	-4.28
	62	5310	-4.43
	102	5510	0.74
	110	5550	1.40
	134	5670	2.85
802.11ac (20)	52	5260	-3.86
	60	5300	-3.89
	64	5320	-3.85
	100	5500	1.31
	116	5580	3.29
	140	5700	3.76
802.11ac (40)	54	5270	-4.21
	62	5310	-4.30
	102	5510	0.73
	110	5550	1.48
	134	5670	3.02
802.11ac (80)	58	5290	-5.32
	106	5530	0.67
	122	5610	2.20

Note 1:

**5.3GWIFI:** Calculation Value  $=[(\text{max. power of channel, mW})/(\text{min. test separation distance, mm})] \cdot [\sqrt{f}(\text{GHz})]. = 0.836/5 \cdot \sqrt{5.260} = 0.383 \leq 3.0$

**5.6GWIFI:** Calculation Value  $=[(\text{max. power of channel, mW})/(\text{min. test separation distance, mm})] \cdot [\sqrt{f}(\text{GHz})]. = 3.724/5 \cdot \sqrt{5.700} = 1.778 \leq 3.0$

According to KDB447498 D01 V06, threshold at which no SAR required is  $\leq 3.0$  for 1-g SAR, separation distance is 5mm, and the SAR evaluation for 5GHz WIFI is not required.

Any report having not been signed by authorized approver, or having been altered without authorization, or having not been stamped by the "Dedicated Testing/Inspection Stamp" is deemed to be invalid. Copying or excerpting portion of, or altering the content of the report is not permitted without the written authorization of AGC. The test results presented in the report apply only to the tested sample. Any objections to report issued by AGC should be submitted to AGC within 15days after the issuance of the test report. Further enquiry of validity or verification of the test report should be addressed to AGC by agc01@agccert.com.



## 13. TEST RESULTS

### 13.1. SAR Test Results Summary

#### 13.1.1. Test position and configuration

Head SAR was performed with the device configured in the positions according to IEEE 1528-2013, Body-worn and 4 Edges SAR was performed with the device 10mm from the phantom.

#### 13.1.2. Operation Mode

1. Per KDB 447498 D01 v06 ,for each exposure position, if the highest 1-g SAR is  $\leq 0.8$  W/kg, testing for low and high channel is optional.
2. Per KDB 865664 D01 v01r04,for each frequency band, if the measured SAR is  $\geq 0.8$ W/kg, testing for repeated SAR measurement is required , that the highest measured SAR is only to be tested. When the SAR results are near the limit, the following procedures are required for each device to verify these types of SAR measurement related variation concerns by repeating the highest measured SAR configuration in each frequency band.
  - (1) When the original highest measured SAR is  $\geq 0.8$ W/kg, repeat that measurement once.
  - (2) Perform a second repeated measurement only if the ratio of largest to smallest SAR for the original and first repeated measurements is  $>1.20$  or when the original or repeated measurement is  $\geq 1.45$  W/kg.
  - (3) Perform a third repeated measurement only if the original, first and second repeated measurement is  $\geq 1.5$  W/kg and ratio of largest to smallest SAR for the original, first and second measurement is  $\geq 1.20$ .
3. Body-worn exposure conditions are intended to voice call operations, therefore GSM voice call mode is selected to be test.
4. Per KDB 648474 D04 v01r03,when the reported SAR for a body-worn accessory measured without a headset connected to the handset is  $\leq 1.2$ W/kg, SAR testing with a headset connected is not required.
5. Per KDB 248227 D01v02r02,for 2.4GHz 802.11g/n SAR testing is not required when the highest reported SAR for DSSS is adjusted by the ratio of OFDM to DSSS specified maximum output power and the adjusted SAR is  $\leq 1.2$ W/kg.
6. Per KDB 248227 D01 v02r02 Chapter 5.3.4, SAR measurement requirements for the remaining 802.11 transmission mode configurations that have not been tested in the initial test configuration are determined separately for each standalone and aggregated frequency band, in each exposure condition, according to the maximum output power specified for production units. The initial test position procedure is applied to next to the ear, UMPC mini-tablet and hotspot mode configurations. When the same maximum output power is specified for multiple transmission modes, the procedures in 5.3.2 are applied to determine the test configuration. Additional power measurements may be required to determine if SAR measurements are required for subsequent highest output power channels in a subsequent test configuration. The subsequent test configuration and SAR measurement procedures are described in the following.
  - (1) When SAR test exclusion provisions of KDB Publication 447498 D01 are applicable and SAR measurement is not required for the initial test configuration, SAR is also not required for the next highest maximum output power transmission mode subsequent test configuration(s) in that frequency band or aggregated band and exposure configuration.
  - (2) When the highest reported SAR for the initial test configuration (when applicable, include subsequent highest output channels), according to the initial test position or fixed exposure position requirements, is adjusted by the ratio of the subsequent test configuration to initial test configuration specified maximum output power and the adjusted SAR is  $\leq 1.2$  W/kg, SAR is not required for that subsequent test configuration.

Any report having not been signed by authorized approver, or having been altered without authorization, or having not been stamped by the "Dedicated Testing/Inspection Stamp" is deemed to be invalid. Copying or excerpting portion of, or altering the content of the report is not permitted without the written authorization of AGC. The test results presented in the report apply only to the tested sample. Any objections to report issued by AGC should be submitted to AGC within 15days after the issuance of the test report. Further enquiry of validity or verification of the test report should be addressed to AGC by [agc01@agccert.com](mailto:agc01@agccert.com).

7. Per KDB 941225 D06 V02r01, When the same wireless mode transmission configurations for voice and data are required for SAR measurements, the more conservative configuration with a smaller separation distance should be tested for the overlapping SAR configurations.
8. Maximum Scaling SAR in order to calculate the Maximum SAR values to test under the standard Peak Power, Calculation method is as follows:  
Maximum Scaling SAR = tested SAR (Max.) × [maximum turn-up power (mw)/ maximum measurement output power(mw) ]
9. Proximity sensor, just for avoiding the wrong operation in the phone screen when call, and has no influence on output power or SAR result
10. Per KDB 941225 D05v02r05, start with the largest channel bandwidth and measure SAR for QPSK with 1RB allocation using the RB offset and required test channel combination with highest maximum output power for RB offsets at the upper edge, middle and lower edge of each required test channel.
11. Per KDB 941125 D05v02r05, 50% RB allocation for QPSK SAR testing follows 1RB QPSK allocation procedure.
12. Per KDB 941125 D05v02r05. For QPSK with 100% RB allocation. SAR is not required when the highest maximum output power for 100% RB allocation is less than the highest maximum output power in 50% and 1RB allocation and the highest reported SAR is >1.45 W/kg, the remaining required test channels must also be tested.
13. Per KDB 941125 D05v02r05. 16QAM output power for each RB allocation configuration is not 1/2 dB higher than the same configuration in QPSK and the reported SAR for the QPSK configuration is ≤1.45W/kg, Per KDB 941225 D05v02r05, 16QAM SAR testing is not required.
14. Per KDB 941125 D05v02r05. Smaller bandwidth output power for each RB allocation configuration is >not 1/2 dB higher than the same configuration in the largest supported bandwidth, and the reported SAR for the largest supported bandwidth is ≤1.45W/kg. Per KDB 941125 D05v02r05, smaller bandwidth SAR testing is not required.

Any report having not been signed by authorized approver, or having been altered without authorization, or having not been stamped by the "Dedicated Testing/Inspection Stamp" is deemed to be invalid. Copying or excerpting portion of, or altering the content of the report is not permitted without the written authorization of AGC. The test results presented in the report apply only to the tested sample. Any objections to report issued by AGC should be submitted to AGC within 15days after the issuance of the test report. Further enquiry of validity or verification of the test report should be addressed to AGC by [agc01@agccert.com](mailto:agc01@agccert.com).

### 13.1.3. Test Result

SAR MEASUREMENT									
Depth of Liquid (cm):>15					Relative Humidity (%): 51.2				
Product: Smartphone									
Test Mode: GSM850 with GMSK modulation									
Position	Mode	Ch.	Fr. (MHz)	Power Drift (<math>\pm 5\%</math>)	SAR (1g) (W/kg)	Max. Tune-up Power (dBm)	Meas. output Power (dBm)	Scaled SAR (W/kg)	Limit (W/kg)
<b>SIM 1 Card</b>									
Left Cheek	voice	190	836.6	-0.09	0.294	34.50	34.04	0.327	1.6
Left Tilt	voice	190	836.6	0.29	0.172	34.50	34.04	0.191	1.6
Right Cheek	voice	190	836.6	-0.29	<b>0.302</b>	34.50	34.04	<b>0.336</b>	1.6
Right Tilt	voice	190	836.6	0.28	0.195	34.50	34.04	0.217	1.6
Body back	voice	190	836.6	-0.06	<b>0.462</b>	34.50	34.04	<b>0.514</b>	1.6
Body front	voice	190	836.6	0.04	0.286	34.50	34.04	0.318	1.6
Body back	GPRS-2 slot	190	836.6	-0.01	<b>0.572</b>	32.50	32.16	<b>0.619</b>	1.6
Body front	GPRS-2 slot	190	836.6	0.02	0.315	32.50	32.16	0.341	1.6
Edge 1 (Top)	GPRS-2 slot	190	836.6	-0.21	0.143	32.50	32.16	0.155	1.6
Edge 2(Right)	GPRS-2 slot	190	836.6	-0.19	0.157	32.50	32.16	0.170	1.6
Edge 3(Bottom)	GPRS-2 slot	190	836.6	0.35	0.257	32.50	32.16	0.278	1.6
Edge 4(Left)	GPRS-2 slot	190	836.6	0.24	0.116	32.50	32.16	0.125	1.6

Note:

- When the 1-g Reported SAR is  $\leq 0.8$  W/kg, testing for low and high channel is optional. Refer to KDB 447498.
- The test separation for body back, body front and 4 Edges is 10mm of all above table.

Any report having not been signed by authorized approver, or having been altered without authorization, or having not been stamped by the "Dedicated Testing/Inspection Stamp" is deemed to be invalid. Copying or excerpting portion of, or altering the content of the report is not permitted without the written authorization of AGC. The test results presented in the report apply only to the tested sample. Any objections to report issued by AGC should be submitted to AGC within 15days after the issuance of the test report. Further enquiry of validity or verification of the test report should be addressed to AGC by agc01@agccert.com.

SAR MEASUREMENT									
Depth of Liquid (cm):>15					Relative Humidity (%): 56.9				
Product: Smartphone									
Test Mode: PCS1900 with GMSK modulation									
Position	Mode	Ch.	Fr. (MHz)	Power Drift (<±5%)	SAR (1g) (W/kg)	Max. Tune-up Power (dBm)	Meas. output Power (dBm)	Scaled SAR (W/kg)	Limit (W/kg)
<b>SIM 1 Card</b>									
Left Cheek	voice	661	1880.0	-0.22	0.024	31.50	31.08	0.026	1.6
Left Tilt	voice	661	1880.0	-0.15	0.019	31.50	31.08	0.021	1.6
Right Cheek	voice	661	1880.0	0.27	<b>0.031</b>	31.50	31.08	<b>0.034</b>	1.6
Right Tilt	voice	661	1880.0	-0.47	0.021	31.50	31.08	0.023	1.6
Body back	voice	661	1880.0	-0.45	<b>0.331</b>	31.50	31.08	<b>0.365</b>	1.6
Body front	voice	661	1880.0	0.44	0.159	31.50	31.08	0.175	1.6
Body back	GPRS-3 slot	661	1880	-0.33	<b>0.361</b>	27.50	27.29	<b>0.379</b>	1.6
Body front	GPRS-3 slot	661	1880.0	0.34	0.247	27.50	27.29	0.259	1.6
Edge 1 (Top)	GPRS-3 slot	661	1880.0	0.44	0.106	27.50	27.29	0.111	1.6
Edge 2(Right)	GPRS-3 slot	661	1880.0	-0.43	0.145	27.50	27.29	0.152	1.6
Edge 3(Bottom)	GPRS-3 slot	661	1880.0	-0.00	0.273	27.50	27.29	0.287	1.6
Edge 4(Left)	GPRS-3 slot	661	1880.0	0.49	0.151	27.50	27.29	0.158	1.6

Note:

- When the 1-g Reported SAR is ≤ 0.8 W/kg, testing for low and high channel is optional. Refer to KDB 447498.
- The test separation for body back, body front and 4 Edges is 10mm of all above table.

Any report having not been signed by authorized approver, or having been altered without authorization, or having not been stamped by the “Dedicated Testing/Inspection Stamp” is deemed to be invalid. Copying or excerpting portion of, or altering the content of the report is not permitted without the written authorization of AGC. The test results presented in the report apply only to the tested sample. Any objections to report issued by AGC should be submitted to AGC within 15days after the issuance of the test report. Further enquiry of validity or verification of the test report should be addressed to AGC by agc01@agccert.com.

SAR MEASUREMENT									
Depth of Liquid (cm):>15					Relative Humidity (%): 56.9				
Product: Smartphone									
Test Mode: WCDMA Band II with QPSK modulation									
Position	Mode	Ch.	Fr. (MHz)	Power Drift (<math>\pm 5\%</math>)	SAR (1g) (W/kg)	Max. Tune-up Power (dBm)	Meas. output Power (dBm)	Scaled SAR (W/kg)	Limit (W/kg)
Left Cheek	RMC 12.2kbps	9400	1880	-0.09	0.071	24.00	23.83	0.074	1.6
Left Tilt	RMC 12.2kbps	9400	1880	-0.24	0.065	24.00	23.83	0.068	1.6
Right Cheek	RMC 12.2kbps	9400	1880	0.20	<b>0.096</b>	24.00	23.83	<b>0.100</b>	1.6
Right Tilt	RMC 12.2kbps	9400	1880	-0.02	0.062	24.00	23.83	0.064	1.6
Body back	RMC 12.2kbps	9400	1880	-0.26	<b>0.745</b>	24.00	23.83	<b>0.775</b>	1.6
Body front	RMC 12.2kbps	9400	1880	0.14	0.426	24.00	23.83	0.443	1.6
Edge 1 (Top)	RMC 12.2kbps	9400	1880	-0.19	0.151	24.00	23.83	0.157	1.6
Edge 2(Right)	RMC 12.2kbps	9400	1880	0.29	0.217	24.00	23.83	0.226	1.6
Edge 3(Bottom)	RMC 12.2kbps	9400	1880	-0.16	0.309	24.00	23.83	0.321	1.6
Edge 4(Left)	RMC 12.2kbps	9400	1880	0.02	0.261	24.00	23.83	0.271	1.6

Note:

- When the 1-g Reported SAR is  $\leq 0.8$  W/kg, testing for low and high channel is optional. Refer to KDB 447498.
- The test separation for body back, body front and 4 Edges is 10mm of all above table.

Any report having not been signed by authorized approver, or having been altered without authorization, or having not been stamped by the "Dedicated Testing/Inspection Stamp" is deemed to be invalid. Copying or excerpting portion of, or altering the content of the report is not permitted without the written authorization of AGC. The test results presented in the report apply only to the tested sample. Any objections to report issued by AGC should be submitted to AGC within 15days after the issuance of the test report. Further enquiry of validity or verification of the test report should be addressed to AGC by agc01@agccert.com.

SAR MEASUREMENT									
Depth of Liquid (cm):>15					Relative Humidity (%): 51.9				
Product: Smartphone									
Test Mode: WCDMA Band IV with QPSK modulation									
Position	Mode	Ch.	Fr. (MHz)	Power Drift (<math>\pm 5\%</math>)	SAR (1g) (W/kg)	Max. Tune-up Power (dBm)	Meas. output Power (dBm)	Scaled SAR (W/kg)	Limit (W/kg)
Left Cheek	RMC 12.2kbps	8662	1732.4	-0.11	0.029	24.00	23.92	0.030	1.6
Left Tilt	RMC 12.2kbps	8662	1732.4	0.26	0.022	24.00	23.92	0.022	1.6
Right Cheek	RMC 12.2kbps	8662	1732.4	-0.44	<b>0.036</b>	24.00	23.92	<b>0.037</b>	1.6
Right Tilt	RMC 12.2kbps	8662	1732.4	-0.29	0.025	24.00	23.92	0.025	1.6
Body back	RMC 12.2kbps	8562	1712.4	0.30	0.842	24.00	23.66	0.911	1.6
Body back	RMC 12.2kbps	8662	1732.4	-0.29	<b>0.900</b>	24.00	23.92	<b>0.917</b>	1.6
Body back	RMC 12.2kbps	8763	1752.6	-0.36	0.863	24.00	23.78	0.908	1.6
Body front	RMC 12.2kbps	8662	1732.4	0.08	0.423	24.00	23.92	0.431	1.6
Edge 1 (Top)	RMC 12.2kbps	8662	1732.4	-0.22	0.202	24.00	23.92	0.206	1.6
Edge 2(Right)	RMC 12.2kbps	8662	1732.4	0.41	0.326	24.00	23.92	0.332	1.6
Edge 3(Bottom)	RMC 12.2kbps	8662	1732.4	-0.46	0.468	24.00	23.92	0.477	1.6
Edge 4(Left)	RMC 12.2kbps	8662	1732.4	0.11	0.307	24.00	23.92	0.313	1.6

Note:

- When the 1-g Reported SAR is  $\leq 0.8$  W/kg, testing for low and high channel is optional. Refer to KDB 447498.
- The test separation for body back, body front and 4 Edges is 10mm of all above table.

Any report having not been signed by authorized approver, or having been altered without authorization, or having not been stamped by the "Dedicated Testing/Inspection Stamp" is deemed to be invalid. Copying or excerpting portion of, or altering the content of the report is not permitted without the written authorization of AGC. The test results presented in the report apply only to the tested sample. Any objections to report issued by AGC should be submitted to AGC within 15days after the issuance of the test report. Further enquiry of validity or verification of the test report should be addressed to AGC by agc01@agccert.com.

SAR MEASUREMENT									
Depth of Liquid (cm):>15					Relative Humidity (%): 51.2				
Product: Smartphone									
Test Mode: WCDMA Band V with QPSK modulation									
Position	Mode	Ch.	Fr. (MHz)	Power Drift (<math>\pm 5\%</math>)	SAR (1g) (W/kg)	Max. Tune-up Power (dBm)	Meas. output Power (dBm)	Scaled SAR (W/kg)	Limit (W/kg)
Left Cheek	RMC 12.2kbps	4183	836.4	-0.06	0.242	24.00	23.90	0.248	1.6
Left Tilt	RMC 12.2kbps	4183	836.4	0.21	0.102	24.00	23.90	0.104	1.6
Right Cheek	RMC 12.2kbps	4183	836.4	-0.20	<b>0.256</b>	24.00	23.90	<b>0.262</b>	1.6
Right Tilt	RMC 12.2kbps	4183	836.4	-0.47	0.118	24.00	23.90	0.121	1.6
Body back	RMC 12.2kbps	4183	836.4	0.44	<b>0.320</b>	24.00	23.90	<b>0.327</b>	1.6
Body front	RMC 12.2kbps	4183	836.4	-0.14	0.146	24.00	23.90	0.149	1.6
Edge 1 (Top)	RMC 12.2kbps	4183	836.4	0.45	0.085	24.00	23.90	0.087	1.6
Edge 2(Right)	RMC 12.2kbps	4183	836.4	-0.20	0.126	24.00	23.90	0.129	1.6
Edge 3(Bottom)	RMC 12.2kbps	4183	836.4	0.07	0.177	24.00	23.90	0.181	1.6
Edge 4(Left)	RMC 12.2kbps	4183	836.4	0.42	0.109	24.00	23.90	0.112	1.6

Note:

- When the 1-g Reported SAR is  $\leq 0.8$  W/kg, testing for low and high channel is optional. Refer to KDB 447498.
- The test separation for body back, body front and 4 Edges is 10mm of all above table.

Any report having not been signed by authorized approver, or having been altered without authorization, or having not been stamped by the "Dedicated Testing/Inspection Stamp" is deemed to be invalid. Copying or excerpting portion of, or altering the content of the report is not permitted without the written authorization of AGC. The test results presented in the report apply only to the tested sample. Any objections to report issued by AGC should be submitted to AGC within 15days after the issuance of the test report. Further enquiry of validity or verification of the test report should be addressed to AGC by agc01@agccert.com.

SAR MEASUREMENT												
Depth of Liquid (cm):>15						Relative Humidity (%): 56.9						
Product: Smartphone												
Test Mode: LTE Band 2												
BM MHz	MOD	Position	Test Mode		Ch.	Freq. (MHz)	Power Drift (<math>\pm 5\%</math>)	SAR (1g) (W/kg)	Max. Tune up Power (dBm)	Meas. output Power (dBm)	Scaled SAR (W/kg)	Limit (W/kg)
			UL RB Allocation	UL RB START								
20	QPSK	Left Cheek	1	0	18900	1880	-0.02	0.101	25.30	25.26	0.102	1.6
		Left Tilt	1	0	18900	1880	0.28	0.088	25.30	25.26	0.089	1.6
		Right Cheek	1	0	18900	1880	-0.25	<b>0.104</b>	25.30	25.26	<b>0.105</b>	1.6
		Right Tilt	1	0	18900	1880	0.18	0.091	25.30	25.26	0.092	1.6
		Body back	1	0	18700	1860	-0.11	0.862	25.30	24.89	0.947	1.6
		Body back	1	0	18900	1880	-0.01	<b>0.969</b>	25.30	25.26	<b>0.978</b>	1.6
		Body back	1	0	19100	1900	0.28	0.873	25.30	24.87	0.964	1.6
		Body front	1	0	18900	1880	-0.00	0.624	25.30	25.26	0.630	1.6
		Edge 1 (Top)	1	0	18900	1880	0.06	0.132	25.30	25.26	0.133	1.6
		Edge 2(Right)	1	0	18900	1880	-0.46	0.261	25.30	25.26	0.263	1.6
		Edge 3(Bottom)	1	0	18900	1880	0.09	0.369	25.30	25.26	0.372	1.6
		Edge 4(Left)	1	0	18900	1880	0.28	0.255	25.30	25.26	0.257	1.6

Note:

- When the 1-g Reported SAR is  $\leq 0.8$  W/kg, testing for low and high channel is optional. Refer to KDB 447498.
- The test separation for body back, body front and 4 Edges is 10mm of all above table.

Any report having not been signed by authorized approver, or having been altered without authorization, or having not been stamped by the "Dedicated Testing/Inspection Stamp" is deemed to be invalid. Copying or excerpting portion of, or altering the content of the report is not permitted without the written authorization of AGC. The test results presented in the report apply only to the tested sample. Any objections to report issued by AGC should be submitted to AGC within 15days after the issuance of the test report. Further enquiry of validity or verification of the test report should be addressed to AGC by agc01@agccert.com.



SAR MEASUREMENT												
Depth of Liquid (cm):>15						Relative Humidity (%): 51.9						
Product: Smartphone												
Test Mode: LTE Band 4												
BM MHz	MOD	Position	Test Mode		Ch.	Freq. (MHz)	Power Drift (<±5%)	SAR (1g) (W/kg)	Max. Tuneup Power (dBm)	Meas. output Power (dBm)	Scaled SAR (W/kg)	Limit (W/kg)
			UL RB Allocation	UL RB START								
20	QPSK	Left Cheek	1	0	20175	1732.5	-0.25	0.041	25.40	24.56	0.045	1.6
		Left Tilt	1	0	20175	1732.5	0.03	0.012	25.40	24.56	0.013	1.6
		Right Cheek	1	0	20175	1732.5	-0.07	<b>0.044</b>	25.40	24.56	<b>0.049</b>	1.6
		Right Tilt	1	0	20175	1732.5	-0.06	0.025	25.40	24.56	0.028	1.6
		Body back	1	0	20050	1720	0.36	0.932	25.40	24.38	1.179	1.6
		Body back	1	0	20175	1732.5	-0.45	<b>0.986</b>	25.40	24.56	<b>1.196</b>	1.6
		Body back	1	0	20300	1745	0.35	0.967	25.40	24.86	1.095	1.6
		Body front	1	0	20175	1732.5	-0.09	0.706	25.40	24.56	0.781	1.6
		Edge 1 (Top)	1	0	20175	1732.5	0.14	0.257	25.40	24.56	0.284	1.6
		Edge 2(Right)	1	0	20175	1732.5	-0.48	0.359	25.40	24.56	0.397	1.6
		Edge 3(Bottom)	1	0	20175	1732.5	0.44	0.486	25.40	24.56	0.538	1.6
		Edge 4(Left)	1	0	20175	1732.5	0.36	0.317	25.40	24.56	0.351	1.6

Note:

- When the 1-g Reported SAR is ≤ 0.8 W/kg, testing for low and high channel is optional. Refer to KDB 447498.
- The test separation for body back, body front and 4 Edges is 10mm of all above table.

Any report having not been signed by authorized approver, or having been altered without authorization, or having not been stamped by the “Dedicated Testing/Inspection Stamp” is deemed to be invalid. Copying or excerpting portion of, or altering the content of the report is not permitted without the written authorization of AGC. The test results presented in the report apply only to the tested sample. Any objections to report issued by AGC should be submitted to AGC within 15days after the issuance of the test report. Further enquiry of validity or verification of the test report should be addressed to AGC by agc01@agccert.com.

SAR MEASUREMENT												
Depth of Liquid (cm):>15						Relative Humidity (%): 51.2						
Product: Smartphone												
Test Mode: LTE Band 5												
BM MHz	MOD	Position	Test Mode		Ch.	Freq. (MHz)	Power Drift (<±5%)	SAR (1g) (W/kg)	Max. Tuneup Power (dBm)	Meas. output Power (dBm)	Scaled SAR (W/kg)	Limit (W/kg)
			UL RB Allocation	UL RB START								
10	QPSK	Left Cheek	1	0	20525	836.5	-0.25	0.262	25.30	24.31	0.329	1.6
		Left Tilt	1	0	20525	836.5	0.27	0.143	25.30	24.31	0.180	1.6
		Right Cheek	1	0	20525	836.5	-0.30	<b>0.285</b>	25.30	24.31	<b>0.358</b>	1.6
		Right Tilt	1	0	20525	836.5	-0.05	0.159	25.30	24.31	0.200	1.6
		Body back	1	0	20525	836.5	0.11	<b>0.422</b>	25.30	24.31	<b>0.530</b>	1.6
		Body front	1	0	20525	836.5	0.03	0.210	25.30	24.31	0.264	1.6
		Edge 1 (Top)	1	0	20525	836.5	-0.21	0.106	25.30	24.31	0.133	1.6
		Edge 2(Right)	1	0	20525	836.5	0.50	0.112	25.30	24.31	0.141	1.6
		Edge 3(Bottom)	1	0	20525	836.5	-0.03	0.238	25.30	24.31	0.299	1.6
		Edge 4(Left)	1	0	20525	836.5	0.29	0.162	25.30	24.31	0.203	1.6

Note:

- When the 1-g Reported SAR is ≤ 0.8 W/kg, testing for low and high channel is optional. Refer to KDB 447498.
- The test separation for body back, body front and 4 Edges is 10mm of all above table.

Any report having not been signed by authorized approver, or having been altered without authorization, or having not been stamped by the “Dedicated Testing/Inspection Stamp” is deemed to be invalid. Copying or excerpting portion of, or altering the content of the report is not permitted without the written authorization of AGC. The test results presented in the report apply only to the tested sample. Any objections to report issued by AGC should be submitted to AGC within 15days after the issuance of the test report. Further enquiry of validity or verification of the test report should be addressed to AGC by agc01@agccert.com.

SAR MEASUREMENT												
Depth of Liquid (cm):>15						Relative Humidity (%): 56.7						
Product: Smartphone												
Test Mode: LTE Band 12												
BM MHz	MOD	Position	Test Mode		Ch.	Freq. (MHz)	Power Drift (<math>\pm 5\%</math>)	SAR (1g) (W/kg)	Max. Tuneup Power (dBm)	Meas. output Power (dBm)	Scaled SAR (W/kg)	Limit (W/kg)
			UL RB Allocation	UL RB START								
10	QPSK	Left Cheek	1	0	23095	707.5	-0.07	0.321	24.30	23.99	0.345	1.6
		Left Tilt	1	0	23095	707.5	0.39	0.134	24.30	23.99	0.144	1.6
		Right Cheek	1	0	23095	707.5	-0.08	<b>0.336</b>	24.30	23.99	<b>0.361</b>	1.6
		Right Tilt	1	0	23095	707.5	0.39	0.147	24.30	23.99	0.158	1.6
		Body back	1	0	23095	707.5	-0.25	<b>0.419</b>	24.30	23.99	<b>0.450</b>	1.6
		Body front	1	0	23095	707.5	-0.27	0.206	24.30	23.99	0.221	1.6
		Edge 1 (Top)	1	0	23095	707.5	0.25	0.113	24.30	23.99	0.121	1.6
		Edge 2(Right)	1	0	23095	707.5	-0.45	0.169	24.30	23.99	0.182	1.6
		Edge 3(Bottom)	1	0	23095	707.5	-0.07	0.252	24.30	23.99	0.271	1.6
		Edge 4(Left)	1	0	23095	707.5	0.37	0.173	24.30	23.99	0.186	1.6

Note:

- When the 1-g Reported SAR is  $\leq 0.8$  W/kg, testing for low and high channel is optional. Refer to KDB 447498.
- The test separation for body back, body front and 4 Edges is 10mm of all above table.

Any report having not been signed by authorized approver, or having been altered without authorization, or having not been stamped by the "Dedicated Testing/Inspection Stamp" is deemed to be invalid. Copying or excerpting portion of, or altering the content of the report is not permitted without the written authorization of AGC. The test results presented in the report apply only to the tested sample. Any objections to report issued by AGC should be submitted to AGC within 15days after the issuance of the test report. Further enquiry of validity or verification of the test report should be addressed to AGC by agc01@agccert.com.

SAR MEASUREMENT												
Depth of Liquid (cm):>15						Relative Humidity (%): 56.7						
Product: Smartphone												
Test Mode: LTE Band 13												
BM MHz	MOD	Position	Test Mode		Ch.	Freq. (MHz)	Power Drift (<±5%)	SAR (1g) (W/kg)	Max. Tuneup Power (dBm)	Meas. output Power (dBm)	Scaled SAR (W/kg)	Limit (W/kg)
			UL RB Allocation	UL RB START								
10	QPSK	Left Cheek	1	0	23230	782	-0.11	0.126	24.60	24.21	0.138	1.6
		Left Tilt	1	0	23230	782	0.24	0.085	24.60	24.21	0.093	1.6
		Right Cheek	1	0	23230	782	-0.48	<b>0.140</b>	24.60	24.21	<b>0.153</b>	1.6
		Right Tilt	1	0	23230	782	-0.37	0.097	24.60	24.21	0.106	1.6
		Body back	1	0	23230	782	0.19	<b>0.190</b>	24.60	24.21	<b>0.208</b>	1.6
		Body front	1	0	23230	782	0.15	0.144	24.60	24.21	0.158	1.6
		Edge 1 (Top)	1	0	23230	782	0.01	0.062	24.60	24.21	0.068	1.6
		Edge 2(Right)	1	0	23230	782	0.01	0.106	24.60	24.21	0.116	1.6
		Edge 3(Bottom)	1	0	23230	782	-0.07	0.140	24.60	24.21	0.153	1.6
		Edge 4(Left)	1	0	23230	782	-0.33	0.101	24.60	24.21	0.110	1.6

Note:

- When the 1-g Reported SAR is ≤ 0.8 W/kg, testing for low and high channel is optional. Refer to KDB 447498.
- The test separation for body back, body front and 4 Edges is 10mm of all above table.

Any report having not been signed by authorized approver, or having been altered without authorization, or having not been stamped by the “Dedicated Testing/Inspection Stamp” is deemed to be invalid. Copying or excerpting portion of, or altering the content of the report is not permitted without the written authorization of AGC. The test results presented in the report apply only to the tested sample. Any objections to report issued by AGC should be submitted to AGC within 15days after the issuance of the test report. Further enquiry of validity or verification of the test report should be addressed to AGC by agc01@agccert.com.

SAR MEASUREMENT												
Depth of Liquid (cm):>15						Relative Humidity (%): 56.7						
Product: Smartphone												
Test Mode: LTE Band 17												
BM MHz	MOD	Position	Test Mode		Ch.	Freq. (MHz)	Power Drift (<math>\pm 5\%</math>)	SAR (1g) (W/kg)	Max. Tuneup Power (dBm)	Meas. output Power (dBm)	Scaled SAR (W/kg)	Limit (W/kg)
			UL RB Allocation	UL RB START								
10	QPSK	Left Cheek	1	0	23790	710	-0.16	0.316	24.30	23.90	0.346	1.6
		Left Tilt	1	0	23790	710	0.33	0.151	24.30	23.90	0.166	1.6
		Right Cheek	1	0	23790	710	-0.45	<b>0.344</b>	24.30	23.90	<b>0.377</b>	1.6
		Right Tilt	1	0	23790	710	-0.42	0.183	24.30	23.90	0.201	1.6
		Body back	1	0	23790	710	0.08	<b>0.425</b>	24.30	23.90	<b>0.466</b>	1.6
		Body front	1	0	23790	710	-0.11	0.196	24.30	23.90	0.215	1.6
		Edge 1 (Top)	1	0	23790	710	0.06	0.049	24.30	23.90	0.054	1.6
		Edge 2(Right)	1	0	23790	710	-0.17	0.073	24.30	23.90	0.080	1.6
		Edge 3(Bottom)	1	0	23790	710	0.38	0.155	24.30	23.90	0.170	1.6
		Edge 4(Left)	1	0	23790	710	-0.43	0.092	24.30	23.90	0.101	1.6

Note:

- When the 1-g Reported SAR is  $\leq 0.8$  W/kg, testing for low and high channel is optional. Refer to KDB 447498.
- The test separation for body back, body front and 4 Edges is 10mm of all above table.

Any report having not been signed by authorized approver, or having been altered without authorization, or having not been stamped by the "Dedicated Testing/Inspection Stamp" is deemed to be invalid. Copying or excerpting portion of, or altering the content of the report is not permitted without the written authorization of AGC. The test results presented in the report apply only to the tested sample. Any objections to report issued by AGC should be submitted to AGC within 15days after the issuance of the test report. Further enquiry of validity or verification of the test report should be addressed to AGC by agc01@agccert.com.

SAR MEASUREMENT												
Depth of Liquid (cm):>15						Relative Humidity (%): 56.9						
Product: Smartphone												
Test Mode: LTE Band 25												
BM MHz	MOD	Position	Test Mode		Ch.	Freq. (MHz)	Power Drift (<±5%)	SAR (1g) (W/kg)	Max. Tuneup Power (dBm)	Meas. output Power (dBm)	Scaled SAR (W/kg)	Limit (W/kg)
			UL RB Allocation	UL RB START								
20	QPSK	Left Cheek	1	0	26365	1882.5	-0.22	0.059	24.30	24.06	0.062	1.6
		Left Tilt	1	0	26365	1882.5	0.18	0.017	24.30	24.06	0.018	1.6
		Right Cheek	1	0	26365	1882.5	-0.08	<b>0.075</b>	24.30	24.06	<b>0.079</b>	1.6
		Right Tilt	1	0	26365	1882.5	0.10	0.024	24.30	24.06	0.025	1.6
		Body back	1	0	26365	1882.5	-0.07	<b>0.730</b>	24.30	24.06	<b>0.771</b>	1.6
		Body front	1	0	26365	1882.5	-0.12	0.426	24.30	24.06	0.450	1.6
		Edge 1 (Top)	1	0	26365	1882.5	0.11	0.126	24.30	24.06	0.133	1.6
		Edge 2(Right)	1	0	26365	1882.5	-0.01	0.172	24.30	24.06	0.182	1.6
		Edge 3(Bottom)	1	0	26365	1882.5	-0.05	0.241	24.30	24.06	0.255	1.6
		Edge 4(Left)	1	0	26365	1882.5	0.15	0.181	24.30	24.06	0.191	1.6

Note:

- When the 1-g Reported SAR is ≤ 0.8 W/kg, testing for low and high channel is optional. Refer to KDB 447498.
- The test separation for body back, body front and 4 Edges is 10mm of all above table.

Any report having not been signed by authorized approver, or having been altered without authorization, or having not been stamped by the “Dedicated Testing/Inspection Stamp” is deemed to be invalid. Copying or excerpting portion of, or altering the content of the report is not permitted without the written authorization of AGC. The test results presented in the report apply only to the tested sample. Any objections to report issued by AGC should be submitted to AGC within 15days after the issuance of the test report. Further enquiry of validity or verification of the test report should be addressed to AGC by agc01@agccert.com.

SAR MEASUREMENT												
Depth of Liquid (cm):>15						Relative Humidity (%): 51.2						
Product: LTE smartphone												
Test Mode: LTE Band 26A												
BM MHz	MOD	Position	Test Mode		Ch.	Freq. (MHz)	Power Drift (<±5%)	SAR (1g) (W/kg)	Max. Tuneup Power (dBm)	Meas. output Power (dBm)	Scaled SAR (W/Kg)	Limit (W/kg)
			UL RB Allocation	UL RB START								
15	QPSK	Left Cheek	1	0	26915	836.5	-0.46	0.295	25.30	24.29	0.372	1.6
		Left Tilt	1	0	26915	836.5	0.15	0.141	25.30	24.29	0.178	1.6
		Right Cheek	1	0	26915	836.5	-0.07	<b>0.319</b>	25.30	24.29	<b>0.403</b>	1.6
		Right Tilt	1	0	26915	836.5	-0.49	0.162	25.30	24.29	0.204	1.6
		Body back	1	0	26915	836.5	0.06	<b>0.441</b>	25.30	24.29	<b>0.556</b>	1.6
		Body front	1	0	26915	836.5	-0.19	0.218	25.30	24.29	0.275	1.6
		Edge 1 (Top)	1	0	26915	836.5	-0.10	0.105	25.30	24.29	0.132	1.6
		Edge 2(Right)	1	0	26915	836.5	-0.47	0.153	25.30	24.29	0.193	1.6
		Edge 3(Bottom)	1	0	26915	836.5	0.20	0.170	25.30	24.29	0.215	1.6
		Edge 4(Left)	1	0	26915	836.5	0.06	0.162	25.30	24.29	0.204	1.6

Note:

- When the 1-g Reported SAR is  $\leq 0.8$  W/kg, testing for low and high channel is optional. Refer to KDB 447498.
- The test separation for body back, body front and 4 Edges is 10mm of all above table.

Any report having not been signed by authorized approver, or having been altered without authorization, or having not been stamped by the "Dedicated Testing/Inspection Stamp" is deemed to be invalid. Copying or excerpting portion of, or altering the content of the report is not permitted without the written authorization of AGC. The test results presented in the report apply only to the tested sample. Any objections to report issued by AGC should be submitted to AGC within 15days after the issuance of the test report. Further enquiry of validity or verification of the test report should be addressed to AGC by agc01@agccert.com.

SAR MEASUREMENT												
Depth of Liquid (cm):>15						Relative Humidity (%): 51.2						
Product: Smartphone												
Test Mode: LTE Band 26B												
BW MHz	MOD	Position	Test Mode		Ch.	Freq. (MHz)	Power Drift (<math>\pm 5\%</math>)	SAR (1g) (W/kg)	Max. Tuneup Power (dBm)	Meas. output Power (dBm)	Scaled SAR (W/kg)	Limit (W/kg)
			UL RB Allocation	UL RB START								
20	QPSK	Left Cheek	1	0	26740	819	-0.24	0.275	25.80	24.91	0.338	1.6
		Left Tilt	1	0	26740	819	0.23	0.136	25.80	24.91	0.167	1.6
		Right Cheek	1	0	26740	819	0.47	<b>0.330</b>	25.80	24.91	<b>0.405</b>	1.6
		Right Tilt	1	0	26740	819	0.04	0.141	25.80	24.91	0.173	1.6
		Body back	1	0	26740	819	-0.26	<b>0.360</b>	25.80	24.91	<b>0.442</b>	1.6
		Body front	1	0	26740	819	0.20	0.196	25.80	24.91	0.241	1.6
		Edge 1 (Top)	1	0	26740	819	-0.45	0.102	25.80	24.91	0.125	1.6
		Edge 2(Right)	1	0	26740	819	0.24	0.139	25.80	24.91	0.171	1.6
		Edge 3(Bottom)	1	0	26740	819	-0.15	0.164	25.80	24.91	0.201	1.6
		Edge 4(Left)	1	0	26740	819	-0.13	0.150	25.80	24.91	0.184	1.6

Note:

- When the 1-g Reported SAR is  $\leq 0.8$  W/kg, testing for low and high channel is optional. Refer to KDB 447498.
- The test separation for body back, body front and 4 Edges is 10mm of all above table

Any report having not been signed by authorized approver, or having been altered without authorization, or having not been stamped by the "Dedicated Testing/Inspection Stamp" is deemed to be invalid. Copying or excerpting portion of, or altering the content of the report is not permitted without the written authorization of AGC. The test results presented in the report apply only to the tested sample. Any objections to report issued by AGC should be submitted to AGC within 15days after the issuance of the test report. Further enquiry of validity or verification of the test report should be addressed to AGC by agc01@agccert.com.



SAR MEASUREMENT												
Depth of Liquid (cm):>15						Relative Humidity (%): 58.2						
Product: Smartphone												
Test Mode: LTE Band 41												
BW MHz	MOD	Position	Test Mode		Ch.	Freq. (MHz)	Power Drift (<math>\pm 5\%</math>)	SAR (1g) (W/kg)	Max. Tuneup Power (dBm)	Meas. output Power (dBm)	Scaled SAR (W/kg)	Limit (W/kg)
			UL RB Allocation	UL RB START								
20	QPSK	Left Cheek	1	0	40620	2593	-0.40	0.024	24.50	23.77	0.028	1.6
		Left Tilt	1	0	40620	2593	0.24	0.015	24.50	23.77	0.018	1.6
		Right Cheek	1	0	40620	2593	-0.35	<b>0.028</b>	24.50	23.77	<b>0.033</b>	1.6
		Right Tilt	1	0	40620	2593	-0.07	0.019	24.50	23.77	0.022	1.6
		Body back	1	0	40620	2593	0.25	<b>0.207</b>	24.50	23.77	<b>0.245</b>	1.6
		Body front	1	0	40620	2593	-0.16	0.113	24.50	23.77	0.134	1.6
		Edge 1 (Top)	1	0	40620	2593	-0.39	0.041	24.50	23.77	0.049	1.6
		Edge 2(Right)	1	0	40620	2593	0.38	0.095	24.50	23.77	0.112	1.6
		Edge 3(Bottom)	1	0	40620	2593	-0.12	0.137	24.50	23.77	0.162	1.6
		Edge 4(Left)	1	0	40620	2593	0.41	0.099	24.50	23.77	0.117	1.6

Note:

- When the 1-g Reported SAR is  $\leq 0.8$  W/kg, testing for low and high channel is optional. Refer to KDB 447498.
- The test separation for body back, body front and 4 Edges is 10mm of all above table

Any report having not been signed by authorized approver, or having been altered without authorization, or having not been stamped by the "Dedicated Testing/Inspection Stamp" is deemed to be invalid. Copying or excerpting portion of, or altering the content of the report is not permitted without the written authorization of AGC. The test results presented in the report apply only to the tested sample. Any objections to report issued by AGC should be submitted to AGC within 15days after the issuance of the test report. Further enquiry of validity or verification of the test report should be addressed to AGC by agc01@agccert.com.

SAR MEASUREMENT												
Depth of Liquid (cm):>15						Relative Humidity (%): 51.9						
Product: LTE smartphone												
Test Mode: LTE Band 66												
BW MHz	MOD	Position	Test Mode		Ch.	Freq. (MHz)	Power Drift (<±5%)	SAR (1g) (W/kg)	Max. Tuneup Power (dBm)	Meas. output Power (dBm)	Scaled SAR (W/Kg)	Limit (W/kg)
			UL RB Allocation	UL RB START								
20	QPSK	Left Cheek	1	0	132322	1745	-0.11	0.035	25.30	25.08	0.037	1.6
		Left Tilt	1	0	132322	1745	0.39	0.021	25.30	25.08	0.022	1.6
		Right Cheek	1	0	132322	1745	-0.21	<b>0.037</b>	25.30	25.08	<b>0.039</b>	1.6
		Right Tilt	1	0	132322	1745	0.22	0.042	25.30	25.08	0.044	1.6
		Body back	1	0	132322	1745	-0.02	<b>0.675</b>	25.30	25.08	<b>0.710</b>	1.6
		Body front	1	0	132322	1745	0.08	0.342	25.30	25.08	0.360	1.6
		Edge 1 (Top)	1	0	132322	1745	-0.11	0.103	25.30	25.08	0.108	1.6
		Edge 2(Right)	1	0	132322	1745	-0.34	0.184	25.30	25.08	0.194	1.6
		Edge 3(Bottom)	1	0	132322	1745	0.08	0.265	25.30	25.08	0.279	1.6
		Edge 4(Left)	1	0	132322	1745	-0.12	0.197	25.30	25.08	0.207	1.6

Note:

- When the 1-g Reported SAR is ≤ 0.8 W/kg, testing for low and high channel is optional. Refer to KDB 447498.
- The test separation for body back, body front and 4 Edges is 10mm of all above table

Any report having not been signed by authorized approver, or having been altered without authorization, or having not been stamped by the “Dedicated Testing/Inspection Stamp” is deemed to be invalid. Copying or excerpting portion of, or altering the content of the report is not permitted without the written authorization of AGC. The test results presented in the report apply only to the tested sample. Any objections to report issued by AGC should be submitted to AGC within 15days after the issuance of the test report. Further enquiry of validity or verification of the test report should be addressed to AGC by agc01@agccert.com.

SAR MEASUREMENT												
Depth of Liquid (cm):>15						Relative Humidity (%): 56.7						
Product: LTE smartphone												
Test Mode: LTE Band 71												
BW MHz	MOD	Position	Test Mode		Ch.	Freq. (MHz)	Power Drift (<±5%)	SAR (1g) (W/kg)	Max. Tuneup Power (dBm)	Meas. output Power (dBm)	Scaled SAR (W/Kg)	Limit (W/kg)
			UL RB Allocation	UL RB START								
20	QPSK	Left Cheek	1	0	133322	683	-0.12	0.269	24.20	23.32	0.329	1.6
		Left Tilt	1	0	133322	683	-0.36	0.157	24.20	23.32	0.192	1.6
		Right Cheek	1	0	133322	683	0.38	<b>0.273</b>	24.20	23.32	<b>0.334</b>	1.6
		Right Tilt	1	0	133322	683	-0.10	0.166	24.20	23.32	0.203	1.6
		Body back	1	0	133322	683	-0.38	<b>0.363</b>	24.20	23.32	<b>0.445</b>	1.6
		Body front	1	0	133322	683	0.32	0.269	24.20	23.32	0.329	1.6
		Edge 1 (Top)	1	0	133322	683	-0.42	0.098	24.20	23.32	0.120	1.6
		Edge 2(Right)	1	0	133322	683	-0.10	0.112	24.20	23.32	0.137	1.6
		Edge 3(Bottom)	1	0	133322	683	-0.03	0.196	24.20	23.32	0.240	1.6
		Edge 4(Left)	1	0	133322	683	0.35	0.127	24.20	23.32	0.156	1.6

Note:

- When the 1-g Reported SAR is ≤ 0.8 W/kg, testing for low and high channel is optional. Refer to KDB 447498.
- The test separation for body back, body front and 4 Edges is 10mm of all above table

Any report having not been signed by authorized approver, or having been altered without authorization, or having not been stamped by the “Dedicated Testing/Inspection Stamp” is deemed to be invalid. Copying or excerpting portion of, or altering the content of the report is not permitted without the written authorization of AGC. The test results presented in the report apply only to the tested sample. Any objections to report issued by AGC should be submitted to AGC within 15days after the issuance of the test report. Further enquiry of validity or verification of the test report should be addressed to AGC by agc01@agccert.com.

SAR MEASUREMENT									
Depth of Liquid (cm):>15					Relative Humidity (%): 54.3				
Product: Smartphone									
Test Mode:802.11b									
Position	Mode	Ch.	Fr. (MHz)	Power Drift (<±5%)	SAR (1g) (W/kg)	Max. Tune-up Power (dBm)	Meas. output Power (dBm)	Scaled SAR (W/kg)	Limit (W/kg)
Left Cheek	DTS	6	2437	-0.21	0.026	16.60	15.11	0.037	1.6
Left Tilt	DTS	6	2437	0.15	0.014	16.60	15.11	0.020	1.6
Right Cheek	DTS	6	2437	0.02	<b>0.029</b>	16.60	15.11	<b>0.041</b>	1.6
Right Tilt	DTS	6	2437	-0.41	0.017	16.60	15.11	0.024	1.6
Body back	DTS	6	2437	-0.39	<b>0.089</b>	16.60	15.11	<b>0.125</b>	1.6
Body front	DTS	6	2437	0.34	0.029	16.60	15.11	0.041	1.6
Edge 1 (Top)	DTS	6	2437	-0.22	0.073	16.60	15.11	0.103	1.6
Edge 2(Right)	DTS	6	2437	-0.38	0.046	16.60	15.11	0.065	1.6
Edge 3(Bottom)	DTS	6	2437	0.15	0.023	16.60	15.11	0.032	1.6
Edge 4(Left)	DTS	6	2437	0.36	0.060	16.60	15.11	0.085	1.6

Note:

- According to KDB248227, SAR is not required for 802.11n HT20/HT40 channels when the maximum average output power is less than 1/4 dB higher than that measured on the corresponding 802.11a/b channels.
- All of above “DTS” means data transmitters.
- The test separation for body back, body front and 4 Edges is 10mm of all above table.

Any report having not been signed by authorized approver, or having been altered without authorization, or having not been stamped by the “Dedicated Testing/Inspection Stamp” is deemed to be invalid. Copying or excerpting portion of, or altering the content of the report is not permitted without the written authorization of AGC. The test results presented in the report apply only to the tested sample. Any objections to report issued by AGC should be submitted to AGC within 15days after the issuance of the test report. Further enquiry of validity or verification of the test report should be addressed to AGC by agc01@agccert.com.

Repeated SAR											
Product: Smartphone											
Test Mode: WCDMA Band IV & LTE Band 2& LTE Band 4											
Position	Mode		Ch.	Fr. (MHz)	Power Drift (<±5%)	Once SAR (1g) (W/kg)	Power Drift (<±5%)	Twice SAR (1g) (W/kg)	Power Drift (<±5%)	Third SAR (1g) (W/kg)	Limit W/kg
Body back	RMC 12.2kbps		8662	1732.4	-0.12	0.886	--	--	--	--	1.6
Position	Mode		Ch.	Fr. (MHz)	Power Drift (<±5%)	Once SAR (1g) (W/kg)	Power Drift (<±5%)	Twice SAR (1g) (W/kg)	Power Drift (<±5%)	Third SAR (1g) (W/kg)	Limit W/kg
	UL RB Allocation	UL RB START									
Body back	1	0	18900	1880	-0.20	0.851	--	--	--	--	1.6
Body back	1	0	20175	1732.5	0.03	0.950	--	--	--	--	1.6

The second repeated SAR judge reference									
Product: Smartphone									
Band	Position	Mode		Ch.	Fr. (MHz)	Original SAR (1g) (W/kg)	First SAR (1g) (W/kg)	Ratio	Limit
WCDMA Band IV	Body back	RMC 12.2kbps		8662	1732.4	0.900	0.886	1.016	<1.2
Band	Position	Mode		Ch.	Fr. (MHz)	Original SAR (1g) (W/kg)	First SAR (1g) (W/kg)	Ratio	Limit
		UL RB Allocation	UL RB START						
LTE Band 2	Body back	1	0	18900	1880	0.969	0.851	1.139	<1.2
LTE Band 4	Body back	1	0	18900	1880	0.986	0.950	1.038	<1.2

Any report having not been signed by authorized approver, or having been altered without authorization, or having not been stamped by the "Dedicated Testing/Inspection Stamp" is deemed to be invalid. Copying or excerpting portion of, or altering the content of the report is not permitted without the written authorization of AGC. The test results presented in the report apply only to the tested sample. Any objections to report issued by AGC should be submitted to AGC within 15days after the issuance of the test report. Further enquiry of validity or verification of the test report should be addressed to AGC by agc01@agccert.com.

**Simultaneous Multi-band Transmission Evaluation:  
Application Simultaneous Transmission information:**

NO	Simultaneous state	Portable Handset		
		Head	Body-worn	Hotspot
1	GSM(voice)+ WLAN 2.4GHz/ WLAN 5GHz	Yes	Yes	-
2	GSM(voice)+ Bluetooth(data)	Yes	Yes	-
3	GSM (Data) + WLAN 2.4GHz/ WLAN 5GHz	-	Yes	Yes
4	GSM (Data) + Bluetooth(data)	-	Yes	Yes
5	WCDMA+ WLAN 2.4GHz/ WLAN 5GHz	Yes	Yes	Yes
6	WCDMA+ Bluetooth(data)	Yes	Yes	Yes
7	LTE + WLAN 2.4GHz/ WLAN 5GHz	Yes	Yes	Yes
8	LTE + Bluetooth(data)	Yes	Yes	Yes

**NOTE:**

1. WIFI and BT share the same antenna, and cannot transmit simultaneously.
2. Simultaneous with every transmitter must be the same test position.
3. KDB 447498 D01, BT SAR is excluded as below table.
4. KDB 447498 D01, for handsets the test separation distance is determined by the smallest distance between the outer surface of the device and the user; which is 0mm for head SAR and 10mm for body-worn SAR.
5. According to KDB 447498 D01 4.3.1, Standalone SAR test exclusion is as follow:  
For 100 MHz to 6 GHz and test separation distances  $\leq 50$  mm, the 1-g and 10-g SAR test exclusion thresholds are determined by the following:  

$$[(\text{max. power of channel, including tune-up tolerance, mW}) / (\text{min. test separation distance, mm})] \cdot [\sqrt{f(\text{GHz})}] \leq 3.0$$
for 1-g SAR, and  $\leq 7.5$  for 10-g extremity SAR<sup>30</sup>, where
  - f(GHz) is the RF channel transmit frequency in GHz
  - Power and distance are rounded to the nearest mW and mm before calculation<sup>31</sup>
  - The result is rounded to one decimal place for comparison
  - The values 3.0 and 7.5 are referred to as numeric thresholds in step b) below
The test exclusions are applicable only when the minimum test separation distance is  $\leq 50$  mm, and for transmission frequencies between 100 MHz and 6 GHz. When the minimum test separation distance is  $< 5$  mm, a distance of 5 mm according to 4.1 f) is applied to determine SAR test exclusion.
6. If the test separation distance is  $< 5$ mm, 5mm is used for excluded SAR calculation.
7. According to KDB 447498 D01 4.3.2, simultaneous transmission SAR test exclusion is as follow:
  - (1) Simultaneous transmission SAR test exclusion is determined for each operating configuration and exposure condition according to the reported standalone SAR of each applicable simultaneous transmitting antenna.
  - (2) Any transmitters and antennas should be considered when calculating simultaneous mode.
  - (3) For mobile phone and PC, it's the sum of all transmitters and antennas at the same mode with same position in each applicable exposure condition
  - (4) When the standalone SAR test exclusion of section 4.3.2 is applied to an antenna that transmits simultaneously with other antennas, the standalone SAR must be estimated according to the following to det  

$$[(\text{max. power of channel, including tune-up tolerance, mW}) / (\text{min. test separation distance, mm})] \cdot [\sqrt{f(\text{GHz})}] \leq x$$
W/kg for test separation distances  $\leq 50$  mm;  
where  $x = 7.5$  for 1-g SAR, and  $x = 18.75$  for 10-g SAR.

Any report having not been signed by authorized approver, or having been altered without authorization, or having not been stamped by the "Dedicated Testing/Inspection Stamp" is deemed to be invalid. Copying or excerpting portion of, or altering the content of the report is not permitted without the written authorization of AGC. The test results presented in the report apply only to the tested sample. Any objections to report issued by AGC should be submitted to AGC within 15days after the issuance of the test report. Further enquiry of validity or verification of the test report should be addressed to AGC by agc01@agccert.com.

8. When the sum of SAR is larger than the limit, SAR test exclusion is determined by the SAR to peak location separation ratio. The simultaneous transmitting antennas in each operating mode and exposure condition combination must be considered one pair at a time to determine the SAR to peak location separation ratio to qualify for test exclusion. The ratio is determined by  $(SAR1 + SAR2)1.5/R_i$ , rounded to two decimal digits, and must be  $\leq 0.04$  for all antenna pairs in the configuration to qualify for 1-g SAR test exclusion.

Estimated SAR		Max Power including Tune-up Tolerance		Separation Distance (mm)	Estimated SAR (W/kg)
		dBm	mW		
BT	Head	4	2.512	0	0.104
	Body	4	2.512	10	0.052
U-NII-2A	Head	0	1	0	0.061
	Body	0	1	10	0.031
U-NII-2C	Head	6	3.981	0	0.253
	Body	6	3.981	10	0.127

Any report having not been signed by authorized approver, or having been altered without authorization, or having not been stamped by the "Dedicated Testing/Inspection Stamp" is deemed to be invalid. Copying or excerpting portion of, or altering the content of the report is not permitted without the written authorization of AGC. The test results presented in the report apply only to the tested sample. Any objections to report issued by AGC should be submitted to AGC within 15days after the issuance of the test report. Further enquiry of validity or verification of the test report should be addressed to AGC by [agc01@agccert.com](mailto:agc01@agccert.com).

**Sum of the SAR for GSM 850 & Wi-Fi & BT:**

RF Exposure Conditions	Test Position	Simultaneous Transmission Scenario			Σ1-g SAR (W/kg)	SPLSR (Yes/No)
		GSM 850	Wi-Fi DTS Band	Bluetooth		
Head (voice)	Left Touch	0.327	0.037		0.364	No
	Left Tilt	0.191	0.020		0.211	No
	Right Touch	0.336	0.041		0.377	No
	Right Tilt	0.217	0.024		0.241	No
Head (voice)	Left Touch	0.327		0.104	0.431	No
	Left Tilt	0.191		0.104	0.295	No
	Right Touch	0.336		0.104	0.440	No
	Right Tilt	0.217		0.104	0.321	No
Body-worn (voice)	Rear	0.514	0.125		0.639	No
		0.514		0.052	0.566	No
	Front	0.318	0.041		0.359	No
		0.318		0.052	0.370	No
Body-worn (Data)	Rear	0.619		0.052	0.671	No
		0.619	0.125		0.744	No
	Front	0.341		0.052	0.393	No
		0.341	0.041		0.382	No
Body-worn (Hotspot)	Edge 1	0.155	0.103		0.258	No
	Edge 2	0.170	0.065		0.235	No
	Edge 3	0.278	0.032		0.310	No
	Edge 4	0.125	0.085		0.210	No
	Edge 1	0.155		0.052	0.207	No
	Edge 2	0.170		0.052	0.222	No
	Edge 3	0.278		0.052	0.330	No
	Edge 4	0.125		0.052	0.177	No

**Note:**

·According to KDB 447498 D01 General RF Exposure Guidance, when the simultaneous transmission SAR is less than 1.6 W/kg, SPLSR assessment is not required.

·SPLSR mean is “The SAR to Peak Location Separation Ratio “

Any report having not been signed by authorized approver, or having been altered without authorization, or having not been stamped by the “Dedicated Testing/Inspection Stamp” is deemed to be invalid. Copying or excerpting portion of, or altering the content of the report is not permitted without the written authorization of AGC. The test results presented in the report apply only to the tested sample. Any objections to report issued by AGC should be submitted to AGC within 15 days after the issuance of the test report. Further enquiry of validity or verification of the test report should be addressed to AGC by agc01@agccert.com.



RF Exposure Conditions	Test Position	Simultaneous Transmission Scenario			Σ1-g SAR (W/kg)	SPLSR (Yes/No)
		GSM 850	U-NII-2A	U-NII-2C		
Head (voice)	Left Touch	0.327	0.061		0.388	No
	Left Tilt	0.191	0.061		0.252	No
	Right Touch	0.336	0.061		0.397	No
	Right Tilt	0.217	0.061		0.278	No
Head (voice)	Left Touch	0.327		0.253	0.580	No
	Left Tilt	0.191		0.253	0.444	No
	Right Touch	0.336		0.253	0.589	No
	Right Tilt	0.217		0.253	0.470	No
Body-worn (voice)	Rear	0.514	0.031		0.545	No
		0.514		0.127	0.641	No
	Front	0.318	0.031		0.349	No
		0.318		0.127	0.445	No
Body-worn (Data)	Rear	0.619		0.127	0.746	No
		0.619	0.031		0.650	No
	Front	0.341		0.127	0.468	No
		0.341	0.031		0.372	No
Body-worn (Hotspot)	Edge 1	0.155	0.031		0.186	No
	Edge 2	0.170	0.031		0.201	No
	Edge 3	0.278	0.031		0.309	No
	Edge 4	0.125	0.031		0.156	No
	Edge 1	0.155		0.127	0.155	No
	Edge 2	0.170		0.127	0.170	No
	Edge 3	0.278		0.127	0.278	No
	Edge 4	0.125		0.127	0.125	No

**Note:**

- According to KDB 447498 D01 General RF Exposure Guidance, when the simultaneous transmission SAR is less than 1.6 W/kg, SPLSR assessment is not required.
- SPLSR mean is “The SAR to Peak Location Separation Ratio “

Any report having not been signed by authorized approver, or having been altered without authorization, or having not been stamped by the “Dedicated Testing/Inspection Stamp” is deemed to be invalid. Copying or excerpting portion of, or altering the content of the report is not permitted without the written authorization of AGC. The test results presented in the report apply only to the tested sample. Any objections to report issued by AGC should be submitted to AGC within 15 days after the issuance of the test report. Further enquiry of validity or verification of the test report should be addressed to AGC by agc01@agccert.com.

**Sum of the SAR for GSM 1900 & Wi-Fi & BT:**

RF Exposure Conditions	Test Position	Simultaneous Transmission Scenario			Σ1-g SAR (W/kg)	SPLSR (Yes/No)
		PCS 1900	Wi-Fi DTS Band	Bluetooth		
Head (voice)	Left Touch	0.026	0.037		0.063	No
	Left Tilt	0.021	0.020		0.041	No
	Right Touch	0.034	0.041		0.075	No
	Right Tilt	0.023	0.024		0.047	No
Head (voice)	Left Touch	0.026		0.104	0.130	No
	Left Tilt	0.021		0.104	0.125	No
	Right Touch	0.034		0.104	0.138	No
	Right Tilt	0.023		0.104	0.127	No
Body-worn (voice)	Rear	0.365	0.125		0.490	No
		0.365		0.052	0.417	No
	Front	0.175	0.041		0.216	No
		0.175		0.052	0.227	No
Body-worn (Data)	Rear	0.379		0.052	0.431	No
		0.379	0.125		0.504	No
	Front	0.259		0.052	0.311	No
		0.259	0.041		0.300	No
Body-worn (Hotspot)	Edge 1	0.111	0.103		0.214	No
	Edge 2	0.152	0.065		0.217	No
	Edge 3	0.287	0.032		0.319	No
	Edge 4	0.158	0.085		0.243	No
	Edge 1	0.111		0.052	0.163	No
	Edge 2	0.152		0.052	0.204	No
	Edge 3	0.287		0.052	0.339	No
	Edge 4	0.158		0.052	0.210	No

**Note:**

- According to KDB 447498 D01 General RF Exposure Guidance, when the simultaneous transmission SAR is less than 1.6 W/kg, SPLSR assessment is not required.
- SPLSR mean is “The SAR to Peak Location Separation Ratio “

Any report having not been signed by authorized approver, or having been altered without authorization, or having not been stamped by the “Dedicated Testing/Inspection Stamp” is deemed to be invalid. Copying or excerpting portion of, or altering the content of the report is not permitted without the written authorization of AGC. The test results presented in the report apply only to the tested sample. Any objections to report issued by AGC should be submitted to AGC within 15 days after the issuance of the test report. Further enquiry of validity or verification of the test report should be addressed to AGC by agc01@agccert.com.

RF Exposure Conditions	Test Position	Simultaneous Transmission Scenario			Σ1-g SAR (W/kg)	SPLSR (Yes/No)
		PCS 1900	U-NII-2A	U-NII-2C		
Head (voice)	Left Touch	0.026	0.061		0.087	No
	Left Tilt	0.021	0.061		0.082	No
	Right Touch	0.034	0.061		0.095	No
	Right Tilt	0.023	0.061		0.084	No
Head (voice)	Left Touch	0.026		0.253	0.279	No
	Left Tilt	0.021		0.253	0.274	No
	Right Touch	0.034		0.253	0.287	No
	Right Tilt	0.023		0.253	0.276	No
Body-worn (voice)	Rear	0.365	0.031		0.396	No
		0.365		0.127	0.492	No
	Front	0.175	0.031		0.206	No
		0.175		0.127	0.302	No
Body-worn (Data)	Rear	0.379		0.127	0.506	No
		0.379	0.031		0.410	No
	Front	0.259		0.127	0.386	No
		0.259	0.031		0.290	No
Body-worn (Hotspot)	Edge 1	0.111	0.031		0.142	No
	Edge 2	0.152	0.031		0.183	No
	Edge 3	0.287	0.031		0.318	No
	Edge 4	0.158	0.031		0.189	No
	Edge 1	0.111		0.127	0.238	No
	Edge 2	0.152		0.127	0.279	No
	Edge 3	0.287		0.127	0.414	No
	Edge 4	0.158		0.127	0.285	No

**Note:**

- According to KDB 447498 D01 General RF Exposure Guidance, when the simultaneous transmission SAR is less than 1.6 W/kg, SPLSR assessment is not required.
- SPLSR mean is “The SAR to Peak Location Separation Ratio “

Any report having not been signed by authorized approver, or having been altered without authorization, or having not been stamped by the “Dedicated Testing/Inspection Stamp” is deemed to be invalid. Copying or excerpting portion of, or altering the content of the report is not permitted without the written authorization of AGC. The test results presented in the report apply only to the tested sample. Any objections to report issued by AGC should be submitted to AGC within 15 days after the issuance of the test report. Further enquiry of validity or verification of the test report should be addressed to AGC by agc01@agccert.com.

**Sum of the SAR for WCDMA Band II & Wi-Fi & BT:**

RF Exposure Conditions	Test Position	Simultaneous Transmission Scenario			Σ1-g SAR (W/kg)	SPLSR (Yes/No)
		WCDMA Band II	Wi-Fi DTS Band	Bluetooth		
Head	Left Touch	0.074	0.037		0.111	No
	Left Tilt	0.068	0.020		0.088	No
	Right Touch	0.100	0.041		0.141	No
	Right Tilt	0.064	0.024		0.088	No
Head	Left Touch	0.074		0.104	0.178	No
	Left Tilt	0.068		0.104	0.172	No
	Right Touch	0.100		0.104	0.204	No
	Right Tilt	0.064		0.104	0.168	No
Body-worn	Rear	0.775	0.125		0.900	No
	Front	0.443	0.041		0.484	No
	Edge 1	0.157	0.103		0.260	No
	Edge 2	0.226	0.065		0.291	No
	Edge 3	0.321	0.032		0.353	No
	Edge 4	0.271	0.085		0.356	No
	Rear	0.775		0.052	0.827	No
	Front	0.443		0.052	0.495	No
	Edge 1	0.157		0.052	0.209	No
	Edge 2	0.226		0.052	0.278	No
	Edge 3	0.321		0.052	0.373	No
	Edge 4	0.271		0.052	0.323	No

**Note:**

- According to KDB 447498 D01 General RF Exposure Guidance, when the simultaneous transmission SAR is less than 1.6 W/kg, SPLSR assessment is not required.
- SPLSR mean is “The SAR to Peak Location Separation Ratio “

Any report having not been signed by authorized approver, or having been altered without authorization, or having not been stamped by the “Dedicated Testing/Inspection Stamp” is deemed to be invalid. Copying or excerpting portion of, or altering the content of the report is not permitted without the written authorization of AGC. The test results presented in the report apply only to the tested sample. Any objections to report issued by AGC should be submitted to AGC within 15 days after the issuance of the test report. Further enquiry of validity or verification of the test report should be addressed to AGC by agc01@agccert.com.

RF Exposure Conditions	Test Position	Simultaneous Transmission Scenario			Σ1-g SAR (W/kg)	SPLSR (Yes/No)
		WCDMA Band II	U-NII-2A	U-NII-2C		
Head	Left Touch	0.074	0.061		0.135	No
	Left Tilt	0.068	0.061		0.129	No
	Right Touch	0.100	0.061		0.161	No
	Right Tilt	0.064	0.061		0.125	No
Head	Left Touch	0.074		0.253	0.327	No
	Left Tilt	0.068		0.253	0.321	No
	Right Touch	0.100		0.253	0.353	No
	Right Tilt	0.064		0.253	0.317	No
Body-worn	Rear	0.775	0.031		0.806	No
	Front	0.443	0.031		0.474	No
	Edge 1	0.157	0.031		0.104	No
	Edge 2	0.226	0.031		0.257	No
	Edge 3	0.321	0.031		0.352	No
	Edge 4	0.271	0.031		0.302	No
	Rear	0.775		0.127	0.902	No
	Front	0.443		0.127	0.443	No
	Edge 1	0.157		0.127	0.157	No
	Edge 2	0.226		0.127	0.226	No
	Edge 3	0.321		0.127	0.321	No
	Edge 4	0.271		0.127	0.271	No

**Note:**

- According to KDB 447498 D01 General RF Exposure Guidance, when the simultaneous transmission SAR is less than 1.6 W/kg, SPLSR assessment is not required.
- SPLSR mean is “The SAR to Peak Location Separation Ratio “

Any report having not been signed by authorized approver, or having been altered without authorization, or having not been stamped by the “Dedicated Testing/Inspection Stamp” is deemed to be invalid. Copying or excerpting portion of, or altering the content of the report is not permitted without the written authorization of AGC. The test results presented in the report apply only to the tested sample. Any objections to report issued by AGC should be submitted to AGC within 15 days after the issuance of the test report. Further enquiry of validity or verification of the test report should be addressed to AGC by agc01@agccert.com.

**Sum of the SAR for WCDMA Band IV & Wi-Fi & BT:**

RF Exposure Conditions	Test Position	Simultaneous Transmission Scenario			Σ1-g SAR (W/kg)	SPLSR (Yes/No)
		WCDMA Band IV	Wi-Fi DTS Band	Bluetooth		
Head	Left Touch	0.030	0.037		0.067	No
	Left Tilt	0.022	0.020		0.042	No
	Right Touch	0.037	0.041		0.078	No
	Right Tilt	0.025	0.024		0.049	No
Head	Left Touch	0.030		0.104	0.134	No
	Left Tilt	0.022		0.104	0.126	No
	Right Touch	0.037		0.104	0.141	No
	Right Tilt	0.025		0.104	0.129	No
Body-worn	Rear	0.917	0.125		1.042	No
	Front	0.431	0.041		0.472	No
	Edge 1	0.206	0.103		0.309	No
	Edge 2	0.332	0.065		0.397	No
	Edge 3	0.477	0.032		0.509	No
	Edge 4	0.313	0.085		0.398	No
	Rear	0.917		0.052	0.969	No
	Front	0.431		0.052	0.483	No
	Edge 1	0.206		0.052	0.258	No
	Edge 2	0.332		0.052	0.384	No
	Edge 3	0.477		0.052	0.529	No
	Edge 4	0.313		0.052	0.365	No

**Note:**

- According to KDB 447498 D01 General RF Exposure Guidance, when the simultaneous transmission SAR is less than 1.6 W/kg, SPLSR assessment is not required.
- SPLSR mean is “The SAR to Peak Location Separation Ratio “

Any report having not been signed by authorized approver, or having been altered without authorization, or having not been stamped by the “Dedicated Testing/Inspection Stamp” is deemed to be invalid. Copying or excerpting portion of, or altering the content of the report is not permitted without the written authorization of AGC. The test results presented in the report apply only to the tested sample. Any objections to report issued by AGC should be submitted to AGC within 15 days after the issuance of the test report. Further enquiry of validity or verification of the test report should be addressed to AGC by agc01@agccert.com.

RF Exposure Conditions	Test Position	Simultaneous Transmission Scenario			Σ1-g SAR (W/kg)	SPLSR (Yes/No)
		WCDMA Band IV	U-NII-2A	U-NII-2C		
Head	Left Touch	0.030	0.061		0.091	No
	Left Tilt	0.022	0.061		0.083	No
	Right Touch	0.037	0.061		0.098	No
	Right Tilt	0.025	0.061		0.086	No
Head	Left Touch	0.030		0.253	0.283	No
	Left Tilt	0.022		0.253	0.275	No
	Right Touch	0.037		0.253	0.290	No
	Right Tilt	0.025		0.253	0.278	No
Body-worn	Rear	0.917	0.031		0.948	No
	Front	0.431	0.031		0.462	No
	Edge 1	0.206	0.031		0.237	No
	Edge 2	0.332	0.031		0.363	No
	Edge 3	0.477	0.031		0.508	No
	Edge 4	0.313	0.031		0.344	No
	Rear	0.917		0.127	1.044	No
	Front	0.431		0.127	0.431	No
	Edge 1	0.206		0.127	0.206	No
	Edge 2	0.332		0.127	0.332	No
	Edge 3	0.477		0.127	0.477	No
	Edge 4	0.313		0.127	0.313	No

**Note:**

- According to KDB 447498 D01 General RF Exposure Guidance, when the simultaneous transmission SAR is less than 1.6 W/kg, SPLSR assessment is not required.
- SPLSR mean is “The SAR to Peak Location Separation Ratio “

Any report having not been signed by authorized approver, or having been altered without authorization, or having not been stamped by the “Dedicated Testing/Inspection Stamp” is deemed to be invalid. Copying or excerpting portion of, or altering the content of the report is not permitted without the written authorization of AGC. The test results presented in the report apply only to the tested sample. Any objections to report issued by AGC should be submitted to AGC within 15 days after the issuance of the test report. Further enquiry of validity or verification of the test report should be addressed to AGC by agc01@agccert.com.

**Sum of the SAR for WCDMA Band V & Wi-Fi & BT:**

RF Exposure Conditions	Test Position	Simultaneous Transmission Scenario			Σ1-g SAR (W/kg)	SPLSR (Yes/No)
		WCDMA Band V	Wi-Fi DTS Band	Bluetooth		
Head	Left Touch	0.248	0.037		0.285	No
	Left Tilt	0.104	0.020		0.124	No
	Right Touch	0.262	0.041		0.303	No
	Right Tilt	0.121	0.024		0.145	No
Head	Left Touch	0.248		0.104	0.352	No
	Left Tilt	0.104		0.104	0.208	No
	Right Touch	0.262		0.104	0.366	No
	Right Tilt	0.121		0.104	0.225	No
Body-worn	Rear	0.327	0.125		0.452	No
	Front	0.149	0.041		0.190	No
	Edge 1	0.087	0.103		0.190	No
	Edge 2	0.129	0.065		0.194	No
	Edge 3	0.181	0.032		0.213	No
	Edge 4	0.112	0.085		0.197	No
	Rear	0.327		0.052	0.379	No
	Front	0.149		0.052	0.201	No
	Edge 1	0.087		0.052	0.139	No
	Edge 2	0.129		0.052	0.181	No
	Edge 3	0.181		0.052	0.233	No
	Edge 4	0.112		0.052	0.164	No

**Note:**

- According to KDB 447498 D01 General RF Exposure Guidance, when the simultaneous transmission SAR is less than 1.6 W/kg, SPLSR assessment is not required.
- SPLSR mean is “The SAR to Peak Location Separation Ratio “

Any report having not been signed by authorized approver, or having been altered without authorization, or having not been stamped by the “Dedicated Testing/Inspection Stamp” is deemed to be invalid. Copying or excerpting portion of, or altering the content of the report is not permitted without the written authorization of AGC. The test results presented in the report apply only to the tested sample. Any objections to report issued by AGC should be submitted to AGC within 15 days after the issuance of the test report. Further enquiry of validity or verification of the test report should be addressed to AGC by agc01@agccert.com.



RF Exposure Conditions	Test Position	Simultaneous Transmission Scenario			Σ1-g SAR (W/kg)	SPLSR (Yes/No)
		WCDMA Band V	U-NII-2A	U-NII-2C		
Head	Left Touch	0.248	0.061		0.309	No
	Left Tilt	0.104	0.061		0.165	No
	Right Touch	0.262	0.061		0.323	No
	Right Tilt	0.121	0.061		0.182	No
Head	Left Touch	0.248		0.253	0.501	No
	Left Tilt	0.104		0.253	0.357	No
	Right Touch	0.262		0.253	0.515	No
	Right Tilt	0.121		0.253	0.374	No
Body-worn	Rear	0.327	0.031		0.358	No
	Front	0.149	0.031		0.180	No
	Edge 1	0.087	0.031		0.118	No
	Edge 2	0.129	0.031		0.160	No
	Edge 3	0.181	0.031		0.212	No
	Edge 4	0.112	0.031		0.143	No
	Rear	0.327		0.127	0.454	No
	Front	0.149		0.127	0.276	No
	Edge 1	0.087		0.127	0.214	No
	Edge 2	0.129		0.127	0.256	No
	Edge 3	0.181		0.127	0.308	No
	Edge 4	0.112		0.127	0.239	No

**Note:**

- According to KDB 447498 D01 General RF Exposure Guidance, when the simultaneous transmission SAR is less than 1.6 W/kg, SPLSR assessment is not required.
- SPLSR mean is “The SAR to Peak Location Separation Ratio “

Any report having not been signed by authorized approver, or having been altered without authorization, or having not been stamped by the “Dedicated Testing/Inspection Stamp” is deemed to be invalid. Copying or excerpting portion of, or altering the content of the report is not permitted without the written authorization of AGC. The test results presented in the report apply only to the tested sample. Any objections to report issued by AGC should be submitted to AGC within 15 days after the issuance of the test report. Further enquiry of validity or verification of the test report should be addressed to AGC by agc01@agccert.com.

**Sum of the SAR for LTE Band 2 & Wi-Fi & BT:**

RF Exposure Conditions	Test Position	Simultaneous Transmission Scenario			Σ1-g SAR (W/kg)	SPLSR (Yes/No)
		LTE Band 2	Wi-Fi DTS Band	Bluetooth		
Head	Left Touch	0.102	0.037		0.139	No
	Left Tilt	0.089	0.020		0.109	No
	Right Touch	0.105	0.041		0.146	No
	Right Tilt	0.092	0.024		0.116	No
Head	Left Touch	0.102		0.104	0.206	No
	Left Tilt	0.089		0.104	0.193	No
	Right Touch	0.105		0.104	0.209	No
	Right Tilt	0.092		0.104	0.196	No
Body-worn	Rear	0.978	0.125		1.103	No
	Front	0.630	0.041		0.671	No
	Edge 1	0.133	0.103		0.236	No
	Edge 2	0.263	0.065		0.328	No
	Edge 3	0.372	0.032		0.404	No
	Edge 4	0.257	0.085		0.342	No
	Rear	0.978		0.052	1.030	No
	Front	0.630		0.052	0.682	No
	Edge 1	0.133		0.052	0.185	No
	Edge 2	0.263		0.052	0.315	No
	Edge 3	0.372		0.052	0.424	No
	Edge 4	0.257		0.052	0.309	No

**Note:**

- According to KDB 447498 D01 General RF Exposure Guidance, when the simultaneous transmission SAR is less than 1.6 W/kg, SPLSR assessment is not required.
- SPLSR mean is “The SAR to Peak Location Separation Ratio “

Any report having not been signed by authorized approver, or having been altered without authorization, or having not been stamped by the “Dedicated Testing/Inspection Stamp” is deemed to be invalid. Copying or excerpting portion of, or altering the content of the report is not permitted without the written authorization of AGC. The test results presented in the report apply only to the tested sample. Any objections to report issued by AGC should be submitted to AGC within 15 days after the issuance of the test report. Further enquiry of validity or verification of the test report should be addressed to AGC by agc01@agccert.com.

RF Exposure Conditions	Test Position	Simultaneous Transmission Scenario			Σ1-g SAR (W/kg)	SPLSR (Yes/No)
		LTE Band 2	U-NII-2A	U-NII-2C		
Head	Left Touch	0.102	0.061		0.163	No
	Left Tilt	0.089	0.061		0.150	No
	Right Touch	0.105	0.061		0.166	No
	Right Tilt	0.092	0.061		0.153	No
Head	Left Touch	0.102		0.253	0.355	No
	Left Tilt	0.089		0.253	0.342	No
	Right Touch	0.105		0.253	0.358	No
	Right Tilt	0.092		0.253	0.345	No
Body-worn	Rear	0.978	0.031		1.009	No
	Front	0.630	0.031		0.661	No
	Edge 1	0.133	0.031		0.164	No
	Edge 2	0.263	0.031		0.294	No
	Edge 3	0.372	0.031		0.403	No
	Edge 4	0.257	0.031		0.288	No
	Rear	0.978		0.127	1.105	No
	Front	0.630		0.127	0.630	No
	Edge 1	0.133		0.127	0.133	No
	Edge 2	0.263		0.127	0.263	No
	Edge 3	0.372		0.127	0.372	No
	Edge 4	0.257		0.127	0.257	No

**Note:**

- According to KDB 447498 D01 General RF Exposure Guidance, when the simultaneous transmission SAR is less than 1.6 W/kg, SPLSR assessment is not required.
- SPLSR mean is “The SAR to Peak Location Separation Ratio “

Any report having not been signed by authorized approver, or having been altered without authorization, or having not been stamped by the “Dedicated Testing/Inspection Stamp” is deemed to be invalid. Copying or excerpting portion of, or altering the content of the report is not permitted without the written authorization of AGC. The test results presented in the report apply only to the tested sample. Any objections to report issued by AGC should be submitted to AGC within 15days after the issuance of the test report. Further enquiry of validity or verification of the test report should be addressed to AGC by agc01@agccert.com.

**Sum of the SAR for LTE Band 4 & Wi-Fi & BT:**

RF Exposure Conditions	Test Position	Simultaneous Transmission Scenario			Σ1-g SAR (W/kg)	SPLSR (Yes/No)
		LTE Band 4	Wi-Fi DTS Band	Bluetooth		
Head	Left Touch	0.045	0.037		0.082	No
	Left Tilt	0.013	0.020		0.033	No
	Right Touch	0.049	0.041		0.090	No
	Right Tilt	0.028	0.024		0.052	No
Head	Left Touch	0.045		0.104	0.149	No
	Left Tilt	0.013		0.104	0.117	No
	Right Touch	0.049		0.104	0.153	No
	Right Tilt	0.028		0.104	0.132	No
Body-worn	Rear	1.196	0.125		1.321	No
	Front	0.781	0.041		0.822	No
	Edge 1	0.284	0.103		0.387	No
	Edge 2	0.397	0.065		0.462	No
	Edge 3	0.538	0.032		0.570	No
	Edge 4	0.351	0.085		0.436	No
	Rear	1.196		0.052	1.248	No
	Front	0.781		0.052	0.833	No
	Edge 1	0.284		0.052	0.336	No
	Edge 2	0.397		0.052	0.449	No
	Edge 3	0.538		0.052	0.590	No
	Edge 4	0.351		0.052	0.403	No

**Note:**

- According to KDB 447498 D01 General RF Exposure Guidance, when the simultaneous transmission SAR is less than 1.6 W/kg, SPLSR assessment is not required.
- SPLSR mean is “The SAR to Peak Location Separation Ratio “

Any report having not been signed by authorized approver, or having been altered without authorization, or having not been stamped by the “Dedicated Testing/Inspection Stamp” is deemed to be invalid. Copying or excerpting portion of, or altering the content of the report is not permitted without the written authorization of AGC. The test results presented in the report apply only to the tested sample. Any objections to report issued by AGC should be submitted to AGC within 15 days after the issuance of the test report. Further enquiry of validity or verification of the test report should be addressed to AGC by agc01@agccert.com.

RF Exposure Conditions	Test Position	Simultaneous Transmission Scenario			Σ1-g SAR (W/kg)	SPLSR (Yes/No)
		LTE Band 4	U-NII-2A	U-NII-2C		
Head	Left Touch	0.045	0.061		0.106	No
	Left Tilt	0.013	0.061		0.074	No
	Right Touch	0.049	0.061		0.110	No
	Right Tilt	0.028	0.061		0.089	No
Head	Left Touch	0.045		0.253	0.298	No
	Left Tilt	0.013		0.253	0.266	No
	Right Touch	0.049		0.253	0.302	No
	Right Tilt	0.028		0.253	0.281	No
Body-worn	Rear	1.196	0.031		1.227	No
	Front	0.781	0.031		0.812	No
	Edge 1	0.284	0.031		0.315	No
	Edge 2	0.397	0.031		0.428	No
	Edge 3	0.538	0.031		0.569	No
	Edge 4	0.351	0.031		0.382	No
	Rear	1.196		0.127	<b>1.323</b>	No
	Front	0.781		0.127	0.781	No
	Edge 1	0.284		0.127	0.284	No
	Edge 2	0.397		0.127	0.397	No
	Edge 3	0.538		0.127	0.538	No
	Edge 4	0.351		0.127	0.351	No

**Note:**

- According to KDB 447498 D01 General RF Exposure Guidance, when the simultaneous transmission SAR is less than 1.6 W/kg, SPLSR assessment is not required.
- SPLSR mean is “The SAR to Peak Location Separation Ratio “

Any report having not been signed by authorized approver, or having been altered without authorization, or having not been stamped by the “Dedicated Testing/Inspection Stamp” is deemed to be invalid. Copying or excerpting portion of, or altering the content of the report is not permitted without the written authorization of AGC. The test results presented in the report apply only to the tested sample. Any objections to report issued by AGC should be submitted to AGC within 15 days after the issuance of the test report. Further enquiry of validity or verification of the test report should be addressed to AGC by agc01@agccert.com.

**Sum of the SAR for LTE Band 5 & Wi-Fi & BT:**

RF Exposure Conditions	Test Position	Simultaneous Transmission Scenario			Σ1-g SAR (W/kg)	SPLSR (Yes/No)
		LTE Band 5	Wi-Fi DTS Band	Bluetooth		
Head	Left Touch	0.329	0.037		0.366	No
	Left Tilt	0.180	0.020		0.200	No
	Right Touch	0.358	0.041		0.399	No
	Right Tilt	0.200	0.024		0.224	No
Head	Left Touch	0.329		0.104	0.433	No
	Left Tilt	0.180		0.104	0.284	No
	Right Touch	0.358		0.104	0.462	No
	Right Tilt	0.200		0.104	0.304	No
Body-worn	Rear	0.530	0.125		0.655	No
	Front	0.264	0.041		0.305	No
	Edge 1	0.133	0.103		0.236	No
	Edge 2	0.141	0.065		0.206	No
	Edge 3	0.299	0.032		0.331	No
	Edge 4	0.203	0.085		0.288	No
	Rear	0.530		0.052	0.582	No
	Front	0.264		0.052	0.316	No
	Edge 1	0.133		0.052	0.185	No
	Edge 2	0.141		0.052	0.193	No
	Edge 3	0.299		0.052	0.351	No
	Edge 4	0.203		0.052	0.255	No

**Note:**

- According to KDB 447498 D01 General RF Exposure Guidance, when the simultaneous transmission SAR is less than 1.6 W/kg, SPLSR assessment is not required.
- SPLSR mean is “The SAR to Peak Location Separation Ratio “

Any report having not been signed by authorized approver, or having been altered without authorization, or having not been stamped by the “Dedicated Testing/Inspection Stamp” is deemed to be invalid. Copying or excerpting portion of, or altering the content of the report is not permitted without the written authorization of AGC. The test results presented in the report apply only to the tested sample. Any objections to report issued by AGC should be submitted to AGC within 15 days after the issuance of the test report. Further enquiry of validity or verification of the test report should be addressed to AGC by agc01@agccert.com.

RF Exposure Conditions	Test Position	Simultaneous Transmission Scenario			Σ1-g SAR (W/kg)	SPLSR (Yes/No)
		LTE Band 5	U-NII-2A	U-NII-2C		
Head	Left Touch	0.329	0.061		0.390	No
	Left Tilt	0.180	0.061		0.241	No
	Right Touch	0.358	0.061		0.419	No
	Right Tilt	0.200	0.061		0.261	No
Head	Left Touch	0.329		0.253	0.582	No
	Left Tilt	0.180		0.253	0.433	No
	Right Touch	0.358		0.253	0.611	No
	Right Tilt	0.200		0.253	0.453	No
Body-worn	Rear	0.530	0.031		0.561	No
	Front	0.264	0.031		0.295	No
	Edge 1	0.133	0.031		0.164	No
	Edge 2	0.141	0.031		0.172	No
	Edge 3	0.299	0.031		0.330	No
	Edge 4	0.203	0.031		0.234	No
	Rear	0.530		0.127	0.657	No
	Front	0.264		0.127	0.391	No
	Edge 1	0.133		0.127	0.260	No
	Edge 2	0.141		0.127	0.268	No
	Edge 3	0.299		0.127	0.426	No
	Edge 4	0.203		0.127	0.330	No

**Note:**

- According to KDB 447498 D01 General RF Exposure Guidance, when the simultaneous transmission SAR is less than 1.6 W/kg, SPLSR assessment is not required.
- SPLSR mean is “The SAR to Peak Location Separation Ratio “

Any report having not been signed by authorized approver, or having been altered without authorization, or having not been stamped by the “Dedicated Testing/Inspection Stamp” is deemed to be invalid. Copying or excerpting portion of, or altering the content of the report is not permitted without the written authorization of AGC. The test results presented in the report apply only to the tested sample. Any objections to report issued by AGC should be submitted to AGC within 15days after the issuance of the test report. Further enquiry of validity or verification of the test report should be addressed to AGC by agc01@agccert.com.

**Sum of the SAR for LTE Band 12 & Wi-Fi & BT:**

RF Exposure Conditions	Test Position	Simultaneous Transmission Scenario			Σ1-g SAR (W/kg)	SPLSR (Yes/No)
		LTE Band 12	Wi-Fi DTS Band	Bluetooth		
Head	Left Touch	0.345	0.037		0.382	No
	Left Tilt	0.144	0.020		0.164	No
	Right Touch	0.361	0.041		0.402	No
	Right Tilt	0.158	0.024		0.182	No
Head	Left Touch	0.345		0.104	0.449	No
	Left Tilt	0.144		0.104	0.248	No
	Right Touch	0.361		0.104	0.465	No
	Right Tilt	0.158		0.104	0.262	No
Body-worn	Rear	0.450	0.125		0.575	No
	Front	0.221	0.041		0.262	No
	Edge 1	0.121	0.103		0.224	No
	Edge 2	0.182	0.065		0.247	No
	Edge 3	0.271	0.032		0.303	No
	Edge 4	0.186	0.085		0.271	No
	Rear	0.450		0.052	0.502	No
	Front	0.221		0.052	0.273	No
	Edge 1	0.121		0.052	0.173	No
	Edge 2	0.182		0.052	0.234	No
	Edge 3	0.271		0.052	0.323	No
	Edge 4	0.186		0.052	0.238	No

**Note:**

- According to KDB 447498 D01 General RF Exposure Guidance, when the simultaneous transmission SAR is less than 1.6 W/kg, SPLSR assessment is not required.
- SPLSR mean is “The SAR to Peak Location Separation Ratio “

Any report having not been signed by authorized approver, or having been altered without authorization, or having not been stamped by the “Dedicated Testing/Inspection Stamp” is deemed to be invalid. Copying or excerpting portion of, or altering the content of the report is not permitted without the written authorization of AGC. The test results presented in the report apply only to the tested sample. Any objections to report issued by AGC should be submitted to AGC within 15 days after the issuance of the test report. Further enquiry of validity or verification of the test report should be addressed to AGC by agc01@agccert.com.



RF Exposure Conditions	Test Position	Simultaneous Transmission Scenario			Σ1-g SAR (W/kg)	SPLSR (Yes/No)
		LTE Band 12	U-NII-2A	U-NII-2C		
Head	Left Touch	0.345	0.061		0.406	No
	Left Tilt	0.144	0.061		0.205	No
	Right Touch	0.361	0.061		0.422	No
	Right Tilt	0.158	0.061		0.219	No
Head	Left Touch	0.345		0.253	0.598	No
	Left Tilt	0.144		0.253	0.397	No
	Right Touch	0.361		0.253	0.614	No
	Right Tilt	0.158		0.253	0.411	No
Body-worn	Rear	0.450	0.031		0.481	No
	Front	0.221	0.031		0.252	No
	Edge 1	0.121	0.031		0.152	No
	Edge 2	0.182	0.031		0.213	No
	Edge 3	0.271	0.031		0.302	No
	Edge 4	0.186	0.031		0.217	No
	Rear	0.450		0.127	0.577	No
	Front	0.221		0.127	0.348	No
	Edge 1	0.121		0.127	0.248	No
	Edge 2	0.182		0.127	0.309	No
	Edge 3	0.271		0.127	0.398	No
	Edge 4	0.186		0.127	0.313	No

**Note:**

- According to KDB 447498 D01 General RF Exposure Guidance, when the simultaneous transmission SAR is less than 1.6 W/kg, SPLSR assessment is not required.
- SPLSR mean is “The SAR to Peak Location Separation Ratio “

Any report having not been signed by authorized approver, or having been altered without authorization, or having not been stamped by the “Dedicated Testing/Inspection Stamp” is deemed to be invalid. Copying or excerpting portion of, or altering the content of the report is not permitted without the written authorization of AGC. The test results presented in the report apply only to the tested sample. Any objections to report issued by AGC should be submitted to AGC within 15days after the issuance of the test report. Further enquiry of validity or verification of the test report should be addressed to AGC by agc01@agccert.com.

**Sum of the SAR for LTE Band 13 & Wi-Fi & BT:**

RF Exposure Conditions	Test Position	Simultaneous Transmission Scenario			Σ1-g SAR (W/kg)	SPLSR (Yes/No)
		LTE Band 13	Wi-Fi DTS Band	Bluetooth		
Head	Left Touch	0.138	0.037		0.175	No
	Left Tilt	0.093	0.020		0.113	No
	Right Touch	0.153	0.041		0.194	No
	Right Tilt	0.106	0.024		0.130	No
Head	Left Touch	0.138		0.104	0.242	No
	Left Tilt	0.093		0.104	0.197	No
	Right Touch	0.153		0.104	0.257	No
	Right Tilt	0.106		0.104	0.210	No
Body-worn	Rear	0.208	0.125		0.333	No
	Front	0.158	0.041		0.199	No
	Edge 1	0.068	0.103		0.171	No
	Edge 2	0.116	0.065		0.181	No
	Edge 3	0.153	0.032		0.185	No
	Edge 4	0.110	0.085		0.195	No
	Rear	0.208		0.052	0.260	No
	Front	0.158		0.052	0.210	No
	Edge 1	0.068		0.052	0.120	No
	Edge 2	0.116		0.052	0.168	No
	Edge 3	0.153		0.052	0.205	No
	Edge 4	0.110		0.052	0.162	No

**Note:**

- According to KDB 447498 D01 General RF Exposure Guidance, when the simultaneous transmission SAR is less than 1.6 W/kg, SPLSR assessment is not required.
- SPLSR mean is “The SAR to Peak Location Separation Ratio “

Any report having not been signed by authorized approver, or having been altered without authorization, or having not been stamped by the “Dedicated Testing/Inspection Stamp” is deemed to be invalid. Copying or excerpting portion of, or altering the content of the report is not permitted without the written authorization of AGC. The test results presented in the report apply only to the tested sample. Any objections to report issued by AGC should be submitted to AGC within 15 days after the issuance of the test report. Further enquiry of validity or verification of the test report should be addressed to AGC by agc01@agccert.com.

RF Exposure Conditions	Test Position	Simultaneous Transmission Scenario			Σ1-g SAR (W/kg)	SPLSR (Yes/No)
		LTE Band 13	U-NII-2A	U-NII-2C		
Head	Left Touch	0.138	0.061		0.199	No
	Left Tilt	0.093	0.061		0.154	No
	Right Touch	0.153	0.061		0.214	No
	Right Tilt	0.106	0.061		0.167	No
Head	Left Touch	0.138		0.253	0.391	No
	Left Tilt	0.093		0.253	0.346	No
	Right Touch	0.153		0.253	0.406	No
	Right Tilt	0.106		0.253	0.359	No
Body-worn	Rear	0.208	0.031		0.239	No
	Front	0.158	0.031		0.189	No
	Edge 1	0.068	0.031		0.099	No
	Edge 2	0.116	0.031		0.147	No
	Edge 3	0.153	0.031		0.184	No
	Edge 4	0.110	0.031		0.141	No
	Rear	0.208		0.127	0.335	No
	Front	0.158		0.127	0.285	No
	Edge 1	0.068		0.127	0.195	No
	Edge 2	0.116		0.127	0.243	No
	Edge 3	0.153		0.127	0.280	No
	Edge 4	0.110		0.127	0.237	No

**Note:**

- According to KDB 447498 D01 General RF Exposure Guidance, when the simultaneous transmission SAR is less than 1.6 W/kg, SPLSR assessment is not required.
- SPLSR mean is “The SAR to Peak Location Separation Ratio “

Any report having not been signed by authorized approver, or having been altered without authorization, or having not been stamped by the “Dedicated Testing/Inspection Stamp” is deemed to be invalid. Copying or excerpting portion of, or altering the content of the report is not permitted without the written authorization of AGC. The test results presented in the report apply only to the tested sample. Any objections to report issued by AGC should be submitted to AGC within 15days after the issuance of the test report. Further enquiry of validity or verification of the test report should be addressed to AGC by agc01@agccert.com.

**Sum of the SAR for LTE Band 17 & Wi-Fi & BT:**

RF Exposure Conditions	Test Position	Simultaneous Transmission Scenario			Σ1-g SAR (W/kg)	SPLSR (Yes/No)
		LTE Band 17	Wi-Fi DTS Band	Bluetooth		
Head	Left Touch	0.346	0.037		0.383	No
	Left Tilt	0.166	0.020		0.186	No
	Right Touch	0.377	0.041		0.418	No
	Right Tilt	0.201	0.024		0.225	No
Head	Left Touch	0.346		0.104	0.450	No
	Left Tilt	0.166		0.104	0.270	No
	Right Touch	0.377		0.104	0.481	No
	Right Tilt	0.201		0.104	0.305	No
Body-worn	Rear	0.466	0.125		0.591	No
	Front	0.215	0.041		0.256	No
	Edge 1	0.054	0.103		0.157	No
	Edge 2	0.080	0.065		0.145	No
	Edge 3	0.170	0.032		0.202	No
	Edge 4	0.101	0.085		0.186	No
	Rear	0.466		0.052	0.518	No
	Front	0.215		0.052	0.267	No
	Edge 1	0.054		0.052	0.106	No
	Edge 2	0.080		0.052	0.132	No
	Edge 3	0.170		0.052	0.222	No
	Edge 4	0.101		0.052	0.153	No

**Note:**

- According to KDB 447498 D01 General RF Exposure Guidance, when the simultaneous transmission SAR is less than 1.6 W/kg, SPLSR assessment is not required.
- SPLSR mean is “The SAR to Peak Location Separation Ratio “

Any report having not been signed by authorized approver, or having been altered without authorization, or having not been stamped by the “Dedicated Testing/Inspection Stamp” is deemed to be invalid. Copying or excerpting portion of, or altering the content of the report is not permitted without the written authorization of AGC. The test results presented in the report apply only to the tested sample. Any objections to report issued by AGC should be submitted to AGC within 15 days after the issuance of the test report. Further enquiry of validity or verification of the test report should be addressed to AGC by agc01@agccert.com.

RF Exposure Conditions	Test Position	Simultaneous Transmission Scenario			Σ1-g SAR (W/kg)	SPLSR (Yes/No)
		LTE Band 17	U-NII-2A	U-NII-2C		
Head	Left Touch	0.346	0.061		0.407	No
	Left Tilt	0.166	0.061		0.227	No
	Right Touch	0.377	0.061		0.438	No
	Right Tilt	0.201	0.061		0.262	No
Head	Left Touch	0.346		0.253	0.599	No
	Left Tilt	0.166		0.253	0.419	No
	Right Touch	0.377		0.253	0.630	No
	Right Tilt	0.201		0.253	0.454	No
Body-worn	Rear	0.466	0.031		0.497	No
	Front	0.215	0.031		0.246	No
	Edge 1	0.054	0.031		0.085	No
	Edge 2	0.080	0.031		0.111	No
	Edge 3	0.170	0.031		0.201	No
	Edge 4	0.101	0.031		0.132	No
	Rear	0.466		0.127	0.593	No
	Front	0.215		0.127	0.342	No
	Edge 1	0.054		0.127	0.181	No
	Edge 2	0.080		0.127	0.207	No
	Edge 3	0.170		0.127	0.297	No
	Edge 4	0.101		0.127	0.228	No

**Note:**

- According to KDB 447498 D01 General RF Exposure Guidance, when the simultaneous transmission SAR is less than 1.6 W/kg, SPLSR assessment is not required.
- SPLSR mean is “The SAR to Peak Location Separation Ratio “

Any report having not been signed by authorized approver, or having been altered without authorization, or having not been stamped by the “Dedicated Testing/Inspection Stamp” is deemed to be invalid. Copying or excerpting portion of, or altering the content of the report is not permitted without the written authorization of AGC. The test results presented in the report apply only to the tested sample. Any objections to report issued by AGC should be submitted to AGC within 15days after the issuance of the test report. Further enquiry of validity or verification of the test report should be addressed to AGC by agc01@agccert.com.

**Sum of the SAR for LTE Band 25 & Wi-Fi & BT:**

RF Exposure Conditions	Test Position	Simultaneous Transmission Scenario			Σ1-g SAR (W/kg)	SPLSR (Yes/No)
		LTE Band 25	Wi-Fi DTS Band	Bluetooth		
Head	Left Touch	0.062	0.037		0.099	No
	Left Tilt	0.018	0.020		0.038	No
	Right Touch	0.079	0.041		0.120	No
	Right Tilt	0.025	0.024		0.049	No
Head	Left Touch	0.062		0.104	0.166	No
	Left Tilt	0.018		0.104	0.122	No
	Right Touch	0.079		0.104	0.183	No
	Right Tilt	0.025		0.104	0.129	No
Body-worn	Rear	0.771	0.125		0.896	No
	Front	0.450	0.041		0.491	No
	Edge 1	0.133	0.103		0.236	No
	Edge 2	0.182	0.065		0.247	No
	Edge 3	0.255	0.032		0.287	No
	Edge 4	0.191	0.085		0.276	No
	Rear	0.771		0.052	0.823	No
	Front	0.450		0.052	0.502	No
	Edge 1	0.133		0.052	0.185	No
	Edge 2	0.182		0.052	0.234	No
	Edge 3	0.255		0.052	0.307	No
	Edge 4	0.191		0.052	0.243	No

**Note:**

- According to KDB 447498 D01 General RF Exposure Guidance, when the simultaneous transmission SAR is less than 1.6 W/kg, SPLSR assessment is not required.
- SPLSR mean is “The SAR to Peak Location Separation Ratio “

Any report having not been signed by authorized approver, or having been altered without authorization, or having not been stamped by the “Dedicated Testing/Inspection Stamp” is deemed to be invalid. Copying or excerpting portion of, or altering the content of the report is not permitted without the written authorization of AGC. The test results presented in the report apply only to the tested sample. Any objections to report issued by AGC should be submitted to AGC within 15 days after the issuance of the test report. Further enquiry of validity or verification of the test report should be addressed to AGC by agc01@agccert.com.

RF Exposure Conditions	Test Position	Simultaneous Transmission Scenario			Σ1-g SAR (W/kg)	SPLSR (Yes/No)
		LTE Band 25	U-NII-2A	U-NII-2C		
Head	Left Touch	0.062	0.061		0.123	No
	Left Tilt	0.018	0.061		0.079	No
	Right Touch	0.079	0.061		0.140	No
	Right Tilt	0.025	0.061		0.086	No
Head	Left Touch	0.062		0.253	0.315	No
	Left Tilt	0.018		0.253	0.271	No
	Right Touch	0.079		0.253	0.332	No
	Right Tilt	0.025		0.253	0.278	No
Body-worn	Rear	0.771	0.031		0.802	No
	Front	0.450	0.031		0.481	No
	Edge 1	0.133	0.031		0.164	No
	Edge 2	0.182	0.031		0.213	No
	Edge 3	0.255	0.031		0.286	No
	Edge 4	0.191	0.031		0.222	No
	Rear	0.771		0.127	0.898	No
	Front	0.450		0.127	0.577	No
	Edge 1	0.133		0.127	0.260	No
	Edge 2	0.182		0.127	0.309	No
	Edge 3	0.255		0.127	0.382	No
	Edge 4	0.191		0.127	0.318	No

**Note:**

- According to KDB 447498 D01 General RF Exposure Guidance, when the simultaneous transmission SAR is less than 1.6 W/kg, SPLSR assessment is not required.
- SPLSR mean is “The SAR to Peak Location Separation Ratio “

Any report having not been signed by authorized approver, or having been altered without authorization, or having not been stamped by the “Dedicated Testing/Inspection Stamp” is deemed to be invalid. Copying or excerpting portion of, or altering the content of the report is not permitted without the written authorization of AGC. The test results presented in the report apply only to the tested sample. Any objections to report issued by AGC should be submitted to AGC within 15 days after the issuance of the test report. Further enquiry of validity or verification of the test report should be addressed to AGC by agc01@agccert.com.

**Sum of the SAR for LTE Band 26a & Wi-Fi & BT:**

RF Exposure Conditions	Test Position	Simultaneous Transmission Scenario			Σ1-g SAR (W/kg)	SPLSR (Yes/No)
		LTE Band 26a	Wi-Fi DTS Band	Bluetooth		
Head	Left Touch	0.372	0.037		0.409	No
	Left Tilt	0.178	0.020		0.198	No
	Right Touch	0.403	0.041		0.444	No
	Right Tilt	0.204	0.024		0.228	No
Head	Left Touch	0.372		0.104	0.476	No
	Left Tilt	0.178		0.104	0.282	No
	Right Touch	0.403		0.104	0.507	No
	Right Tilt	0.204		0.104	0.308	No
Body-worn	Rear	0.556	0.125		0.681	No
	Front	0.275	0.041		0.316	No
	Edge 1	0.132	0.103		0.235	No
	Edge 2	0.193	0.065		0.258	No
	Edge 3	0.215	0.032		0.247	No
	Edge 4	0.204	0.085		0.289	No
	Rear	0.556		0.052	0.608	No
	Front	0.275		0.052	0.327	No
	Edge 1	0.132		0.052	0.184	No
	Edge 2	0.193		0.052	0.245	No
	Edge 3	0.215		0.052	0.267	No
	Edge 4	0.204		0.052	0.256	No

**Note:**

- According to KDB 447498 D01 General RF Exposure Guidance, when the simultaneous transmission SAR is less than 1.6 W/kg, SPLSR assessment is not required.
- SPLSR mean is “The SAR to Peak Location Separation Ratio “

Any report having not been signed by authorized approver, or having been altered without authorization, or having not been stamped by the “Dedicated Testing/Inspection Stamp” is deemed to be invalid. Copying or excerpting portion of, or altering the content of the report is not permitted without the written authorization of AGC. The test results presented in the report apply only to the tested sample. Any objections to report issued by AGC should be submitted to AGC within 15 days after the issuance of the test report. Further enquiry of validity or verification of the test report should be addressed to AGC by agc01@agccert.com.



RF Exposure Conditions	Test Position	Simultaneous Transmission Scenario			Σ1-g SAR (W/kg)	SPLSR (Yes/No)
		LTE Band 26a	U-NII-2A	U-NII-2C		
Head	Left Touch	0.372	0.061		0.433	No
	Left Tilt	0.178	0.061		0.239	No
	Right Touch	0.403	0.061		0.464	No
	Right Tilt	0.204	0.061		0.265	No
Head	Left Touch	0.372		0.253	0.625	No
	Left Tilt	0.178		0.253	0.431	No
	Right Touch	0.403		0.253	0.656	No
	Right Tilt	0.204		0.253	0.457	No
Body-worn	Rear	0.556	0.031		0.587	No
	Front	0.275	0.031		0.306	No
	Edge 1	0.132	0.031		0.163	No
	Edge 2	0.193	0.031		0.224	No
	Edge 3	0.215	0.031		0.246	No
	Edge 4	0.204	0.031		0.235	No
	Rear	0.556		0.127	0.683	No
	Front	0.275		0.127	0.402	No
	Edge 1	0.132		0.127	0.259	No
	Edge 2	0.193		0.127	0.320	No
	Edge 3	0.215		0.127	0.342	No
	Edge 4	0.204		0.127	0.331	No

**Note:**

- According to KDB 447498 D01 General RF Exposure Guidance, when the simultaneous transmission SAR is less than 1.6 W/kg, SPLSR assessment is not required.
- SPLSR mean is “The SAR to Peak Location Separation Ratio “

Any report having not been signed by authorized approver, or having been altered without authorization, or having not been stamped by the “Dedicated Testing/Inspection Stamp” is deemed to be invalid. Copying or excerpting portion of, or altering the content of the report is not permitted without the written authorization of AGC. The test results presented in the report apply only to the tested sample. Any objections to report issued by AGC should be submitted to AGC within 15days after the issuance of the test report. Further enquiry of validity or verification of the test report should be addressed to AGC by agc01@agccert.com.

**Sum of the SAR for LTE Band 26b & Wi-Fi & BT:**

RF Exposure Conditions	Test Position	Simultaneous Transmission Scenario			Σ1-g SAR (W/kg)	SPLSR (Yes/No)
		LTE Band 26b	Wi-Fi DTS Band	Bluetooth		
Head	Left Touch	0.338	0.037		0.375	No
	Left Tilt	0.167	0.020		0.187	No
	Right Touch	0.405	0.041		0.446	No
	Right Tilt	0.173	0.024		0.197	No
Head	Left Touch	0.338		0.104	0.442	No
	Left Tilt	0.167		0.104	0.271	No
	Right Touch	0.405		0.104	0.509	No
	Right Tilt	0.173		0.104	0.277	No
Body-worn	Rear	0.442	0.125		0.567	No
	Front	0.241	0.041		0.282	No
	Edge 1	0.125	0.103		0.228	No
	Edge 2	0.171	0.065		0.236	No
	Edge 3	0.201	0.032		0.233	No
	Edge 4	0.184	0.085		0.269	No
	Rear	0.442		0.052	0.494	No
	Front	0.241		0.052	0.293	No
	Edge 1	0.125		0.052	0.177	No
	Edge 2	0.171		0.052	0.223	No
	Edge 3	0.201		0.052	0.253	No
	Edge 4	0.184		0.052	0.236	No

**Note:**

- According to KDB 447498 D01 General RF Exposure Guidance, when the simultaneous transmission SAR is less than 1.6 W/kg, SPLSR assessment is not required.
- SPLSR mean is “The SAR to Peak Location Separation Ratio “

Any report having not been signed by authorized approver, or having been altered without authorization, or having not been stamped by the “Dedicated Testing/Inspection Stamp” is deemed to be invalid. Copying or excerpting portion of, or altering the content of the report is not permitted without the written authorization of AGC. The test results presented in the report apply only to the tested sample. Any objections to report issued by AGC should be submitted to AGC within 15 days after the issuance of the test report. Further enquiry of validity or verification of the test report should be addressed to AGC by agc01@agccert.com.

RF Exposure Conditions	Test Position	Simultaneous Transmission Scenario			Σ1-g SAR (W/kg)	SPLSR (Yes/No)
		LTE Band 26b	U-NII-2A	U-NII-2C		
Head	Left Touch	0.338	0.061		0.399	No
	Left Tilt	0.167	0.061		0.228	No
	Right Touch	0.405	0.061		0.466	No
	Right Tilt	0.173	0.061		0.234	No
Head	Left Touch	0.338		0.253	0.591	No
	Left Tilt	0.167		0.253	0.420	No
	Right Touch	0.405		0.253	0.658	No
	Right Tilt	0.173		0.253	0.426	No
Body-worn	Rear	0.442	0.031		0.473	No
	Front	0.241	0.031		0.272	No
	Edge 1	0.125	0.031		0.156	No
	Edge 2	0.171	0.031		0.202	No
	Edge 3	0.201	0.031		0.232	No
	Edge 4	0.184	0.031		0.215	No
	Rear	0.442		0.127	0.569	No
	Front	0.241		0.127	0.368	No
	Edge 1	0.125		0.127	0.252	No
	Edge 2	0.171		0.127	0.298	No
	Edge 3	0.201		0.127	0.328	No
	Edge 4	0.184		0.127	0.311	No

**Note:**

- According to KDB 447498 D01 General RF Exposure Guidance, when the simultaneous transmission SAR is less than 1.6 W/kg, SPLSR assessment is not required.
- SPLSR mean is “The SAR to Peak Location Separation Ratio “

Any report having not been signed by authorized approver, or having been altered without authorization, or having not been stamped by the “Dedicated Testing/Inspection Stamp” is deemed to be invalid. Copying or excerpting portion of, or altering the content of the report is not permitted without the written authorization of AGC. The test results presented in the report apply only to the tested sample. Any objections to report issued by AGC should be submitted to AGC within 15days after the issuance of the test report. Further enquiry of validity or verification of the test report should be addressed to AGC by agc01@agccert.com.

**Sum of the SAR for LTE Band 41 & Wi-Fi & BT:**

RF Exposure Conditions	Test Position	Simultaneous Transmission Scenario			Σ1-g SAR (W/kg)	SPLSR (Yes/No)
		LTE Band 41	Wi-Fi DTS Band	Bluetooth		
Head	Left Touch	0.028	0.037		0.065	No
	Left Tilt	0.018	0.020		0.038	No
	Right Touch	0.033	0.041		0.074	No
	Right Tilt	0.022	0.024		0.046	No
Head	Left Touch	0.028		0.104	0.132	No
	Left Tilt	0.018		0.104	0.122	No
	Right Touch	0.033		0.104	0.137	No
	Right Tilt	0.022		0.104	0.126	No
Body-worn	Rear	0.245	0.125		0.370	No
	Front	0.134	0.041		0.175	No
	Edge 1	0.049	0.103		0.152	No
	Edge 2	0.112	0.065		0.177	No
	Edge 3	0.162	0.032		0.194	No
	Edge 4	0.117	0.085		0.202	No
	Rear	0.245		0.052	0.297	No
	Front	0.134		0.052	0.186	No
	Edge 1	0.049		0.052	0.101	No
	Edge 2	0.112		0.052	0.164	No
	Edge 3	0.162		0.052	0.214	No
	Edge 4	0.117		0.052	0.169	No

**Note:**

- According to KDB 447498 D01 General RF Exposure Guidance, when the simultaneous transmission SAR is less than 1.6 W/kg, SPLSR assessment is not required.
- SPLSR mean is “The SAR to Peak Location Separation Ratio “

Any report having not been signed by authorized approver, or having been altered without authorization, or having not been stamped by the “Dedicated Testing/Inspection Stamp” is deemed to be invalid. Copying or excerpting portion of, or altering the content of the report is not permitted without the written authorization of AGC. The test results presented in the report apply only to the tested sample. Any objections to report issued by AGC should be submitted to AGC within 15 days after the issuance of the test report. Further enquiry of validity or verification of the test report should be addressed to AGC by agc01@agccert.com.

RF Exposure Conditions	Test Position	Simultaneous Transmission Scenario			Σ1-g SAR (W/kg)	SPLSR (Yes/No)
		LTE Band 41	U-NII-2A	U-NII-2C		
Head	Left Touch	0.028	0.061		0.089	No
	Left Tilt	0.018	0.061		0.079	No
	Right Touch	0.033	0.061		0.094	No
	Right Tilt	0.022	0.061		0.083	No
Head	Left Touch	0.028		0.253	0.281	No
	Left Tilt	0.018		0.253	0.271	No
	Right Touch	0.033		0.253	0.286	No
	Right Tilt	0.022		0.253	0.275	No
Body-worn	Rear	0.245	0.031		0.276	No
	Front	0.134	0.031		0.165	No
	Edge 1	0.049	0.031		0.080	No
	Edge 2	0.112	0.031		0.143	No
	Edge 3	0.162	0.031		0.193	No
	Edge 4	0.117	0.031		0.148	No
	Rear	0.245		0.127	0.372	No
	Front	0.134		0.127	0.261	No
	Edge 1	0.049		0.127	0.176	No
	Edge 2	0.112		0.127	0.239	No
	Edge 3	0.162		0.127	0.289	No
	Edge 4	0.117		0.127	0.244	No

**Note:**

- According to KDB 447498 D01 General RF Exposure Guidance, when the simultaneous transmission SAR is less than 1.6 W/kg, SPLSR assessment is not required.
- SPLSR mean is “The SAR to Peak Location Separation Ratio “

Any report having not been signed by authorized approver, or having been altered without authorization, or having not been stamped by the “Dedicated Testing/Inspection Stamp” is deemed to be invalid. Copying or excerpting portion of, or altering the content of the report is not permitted without the written authorization of AGC. The test results presented in the report apply only to the tested sample. Any objections to report issued by AGC should be submitted to AGC within 15days after the issuance of the test report. Further enquiry of validity or verification of the test report should be addressed to AGC by agc01@agccert.com.

**Sum of the SAR for LTE Band 66 & Wi-Fi & BT:**

RF Exposure Conditions	Test Position	Simultaneous Transmission Scenario			Σ1-g SAR (W/kg)	SPLSR (Yes/No)
		LTE Band 66	Wi-Fi DTS Band	Bluetooth		
Head	Left Touch	0.037	0.037		0.074	No
	Left Tilt	0.022	0.020		0.042	No
	Right Touch	0.039	0.041		0.080	No
	Right Tilt	0.044	0.024		0.068	No
Head	Left Touch	0.037		0.104	0.141	No
	Left Tilt	0.022		0.104	0.126	No
	Right Touch	0.039		0.104	0.143	No
	Right Tilt	0.044		0.104	0.148	No
Body-worn	Rear	0.710	0.125		0.835	No
	Front	0.360	0.041		0.401	No
	Edge 1	0.108	0.103		0.211	No
	Edge 2	0.194	0.065		0.259	No
	Edge 3	0.279	0.032		0.311	No
	Edge 4	0.207	0.085		0.292	No
	Rear	0.710		0.052	0.762	No
	Front	0.360		0.052	0.412	No
	Edge 1	0.108		0.052	0.160	No
	Edge 2	0.194		0.052	0.246	No
	Edge 3	0.279		0.052	0.331	No
	Edge 4	0.207		0.052	0.259	No

**Note:**

- According to KDB 447498 D01 General RF Exposure Guidance, when the simultaneous transmission SAR is less than 1.6 W/kg, SPLSR assessment is not required.
- SPLSR mean is “The SAR to Peak Location Separation Ratio “

Any report having not been signed by authorized approver, or having been altered without authorization, or having not been stamped by the “Dedicated Testing/Inspection Stamp” is deemed to be invalid. Copying or excerpting portion of, or altering the content of the report is not permitted without the written authorization of AGC. The test results presented in the report apply only to the tested sample. Any objections to report issued by AGC should be submitted to AGC within 15 days after the issuance of the test report. Further enquiry of validity or verification of the test report should be addressed to AGC by agc01@agccert.com.

RF Exposure Conditions	Test Position	Simultaneous Transmission Scenario			Σ1-g SAR (W/kg)	SPLSR (Yes/No)
		LTE Band 66	U-NII-2A	U-NII-2C		
Head	Left Touch	0.037	0.061		0.098	No
	Left Tilt	0.022	0.061		0.083	No
	Right Touch	0.039	0.061		0.100	No
	Right Tilt	0.044	0.061		0.105	No
Head	Left Touch	0.037		0.253	0.290	No
	Left Tilt	0.022		0.253	0.275	No
	Right Touch	0.039		0.253	0.292	No
	Right Tilt	0.044		0.253	0.297	No
Body-worn	Rear	0.710	0.031		0.741	No
	Front	0.360	0.031		0.391	No
	Edge 1	0.108	0.031		0.139	No
	Edge 2	0.194	0.031		0.225	No
	Edge 3	0.279	0.031		0.310	No
	Edge 4	0.207	0.031		0.238	No
	Rear	0.710		0.127	0.837	No
	Front	0.360		0.127	0.487	No
	Edge 1	0.108		0.127	0.235	No
	Edge 2	0.194		0.127	0.321	No
	Edge 3	0.279		0.127	0.406	No
	Edge 4	0.207		0.127	0.334	No

**Note:**

- According to KDB 447498 D01 General RF Exposure Guidance, when the simultaneous transmission SAR is less than 1.6 W/kg, SPLSR assessment is not required.
- SPLSR mean is “The SAR to Peak Location Separation Ratio “

Any report having not been signed by authorized approver, or having been altered without authorization, or having not been stamped by the “Dedicated Testing/Inspection Stamp” is deemed to be invalid. Copying or excerpting portion of, or altering the content of the report is not permitted without the written authorization of AGC. The test results presented in the report apply only to the tested sample. Any objections to report issued by AGC should be submitted to AGC within 15days after the issuance of the test report. Further enquiry of validity or verification of the test report should be addressed to AGC by agc01@agccert.com.

**Sum of the SAR for LTE Band 71 & Wi-Fi & BT:**

RF Exposure Conditions	Test Position	Simultaneous Transmission Scenario			Σ1-g SAR (W/kg)	SPLSR (Yes/No)
		LTE Band 71	Wi-Fi DTS Band	Bluetooth		
Head	Left Touch	0.329	0.037		0.366	No
	Left Tilt	0.192	0.020		0.212	No
	Right Touch	0.334	0.041		0.375	No
	Right Tilt	0.203	0.024		0.227	No
Head	Left Touch	0.329		0.104	0.433	No
	Left Tilt	0.192		0.104	0.296	No
	Right Touch	0.334		0.104	0.438	No
	Right Tilt	0.203		0.104	0.307	No
Body-worn	Rear	0.445	0.125		0.570	No
	Front	0.329	0.041		0.370	No
	Edge 1	0.120	0.103		0.223	No
	Edge 2	0.137	0.065		0.202	No
	Edge 3	0.240	0.032		0.272	No
	Edge 4	0.156	0.085		0.241	No
	Rear	0.445		0.052	0.497	No
	Front	0.329		0.052	0.381	No
	Edge 1	0.120		0.052	0.172	No
	Edge 2	0.137		0.052	0.189	No
	Edge 3	0.240		0.052	0.292	No
	Edge 4	0.156		0.052	0.208	No

**Note:**

- According to KDB 447498 D01 General RF Exposure Guidance, when the simultaneous transmission SAR is less than 1.6 W/kg, SPLSR assessment is not required.
- SPLSR mean is “The SAR to Peak Location Separation Ratio “

Any report having not been signed by authorized approver, or having been altered without authorization, or having not been stamped by the “Dedicated Testing/Inspection Stamp” is deemed to be invalid. Copying or excerpting portion of, or altering the content of the report is not permitted without the written authorization of AGC. The test results presented in the report apply only to the tested sample. Any objections to report issued by AGC should be submitted to AGC within 15 days after the issuance of the test report. Further enquiry of validity or verification of the test report should be addressed to AGC by agc01@agccert.com.



RF Exposure Conditions	Test Position	Simultaneous Transmission Scenario			Σ1-g SAR (W/kg)	SPLSR (Yes/No)
		LTE Band 71	U-NII-2A	U-NII-2C		
Head	Left Touch	0.329	0.061		0.390	No
	Left Tilt	0.192	0.061		0.253	No
	Right Touch	0.334	0.061		0.395	No
	Right Tilt	0.203	0.061		0.264	No
Head	Left Touch	0.329		0.253	0.582	No
	Left Tilt	0.192		0.253	0.445	No
	Right Touch	0.334		0.253	0.587	No
	Right Tilt	0.203		0.253	0.456	No
Body-worn	Rear	0.445	0.031		0.476	No
	Front	0.329	0.031		0.360	No
	Edge 1	0.120	0.031		0.151	No
	Edge 2	0.137	0.031		0.168	No
	Edge 3	0.240	0.031		0.271	No
	Edge 4	0.156	0.031		0.187	No
	Rear	0.445		0.127	0.572	No
	Front	0.329		0.127	0.456	No
	Edge 1	0.120		0.127	0.247	No
	Edge 2	0.137		0.127	0.264	No
	Edge 3	0.240		0.127	0.367	No
	Edge 4	0.156		0.127	0.283	No

**Note:**

- According to KDB 447498 D01 General RF Exposure Guidance, when the simultaneous transmission SAR is less than 1.6 W/kg, SPLSR assessment is not required.
- SPLSR mean is “The SAR to Peak Location Separation Ratio “

Any report having not been signed by authorized approver, or having been altered without authorization, or having not been stamped by the “Dedicated Testing/Inspection Stamp” is deemed to be invalid. Copying or excerpting portion of, or altering the content of the report is not permitted without the written authorization of AGC. The test results presented in the report apply only to the tested sample. Any objections to report issued by AGC should be submitted to AGC within 15days after the issuance of the test report. Further enquiry of validity or verification of the test report should be addressed to AGC by agc01@agccert.com.

## APPENDIX A. SAR SYSTEM CHECK DATA

Test Laboratory: AGC Lab

Date: Jan. 04, 2024

System Check Head 750 MHz

DUT: Dipole 750 MHz Type: SID 750

Communication System CW; Communication System Band: D750 (750.0 MHz); Duty Cycle: 1:1; Conv.F=1.95

Frequency: 750 MHz; Medium parameters used:  $f = 750$  MHz;  $\sigma = 0.90$  mho/m;  $\epsilon_r = 42.57$ ;  $\rho = 1000$  kg/m<sup>3</sup> ;

Phantom section: Flat Section; Input Power=18dBm

Ambient temperature (°C):21.5, Liquid temperature (°C): 21.3

SATIMO Configuration:

- Probe: SSE2; Calibrated: May 31, 2023; Serial No.: 2023-EPGO-414
- Sensor-Surface: 4mm (Mechanical Surface Detection)
- Phantom: SAM twin phantom
- Measurement SW: OpenSAR V4\_02\_35

Configuration/System Check 750MHz Head/Area Scan: Measurement grid: dx=8mm, dy=8mm

Configuration/System Check 750MHz Head/Zoom Scan: Measurement grid: dx=8mm,dy=8mm, dz=5mm

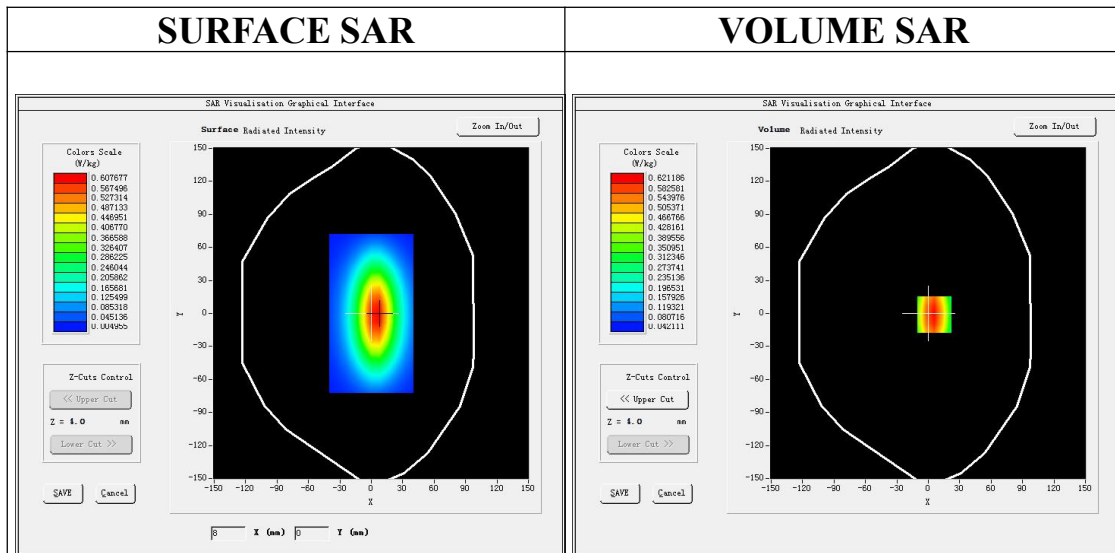

Maximum location: X=6.00, Y=-1.00

SAR Peak: 0.89 W/kg

SAR 10g (W/Kg)	0.353875
SAR 1g (W/Kg)	0.552985

Any report having not been signed by authorized approver, or having been altered without authorization, or having not been stamped by the "Dedicated Testing/Inspection Stamp" is deemed to be invalid. Copying or excerpting portion of, or altering the content of the report is not permitted without the written authorization of AGC. The test results presented in the report apply only to the tested sample. Any objections to report issued by AGC should be submitted to AGC within 15days after the issuance of the test report. Further enquiry of validity or verification of the test report should be addressed to AGC by agc01@agccert.com.

Attestation of Global Compliance(Shenzhen)Co., Ltd

Attestation of Global Compliance(Shenzhen)Std & Tech Co., Ltd

Tel: +86-755 2523 4088 E-mail: agc@agccert.com Web: http://www.agccert.com/

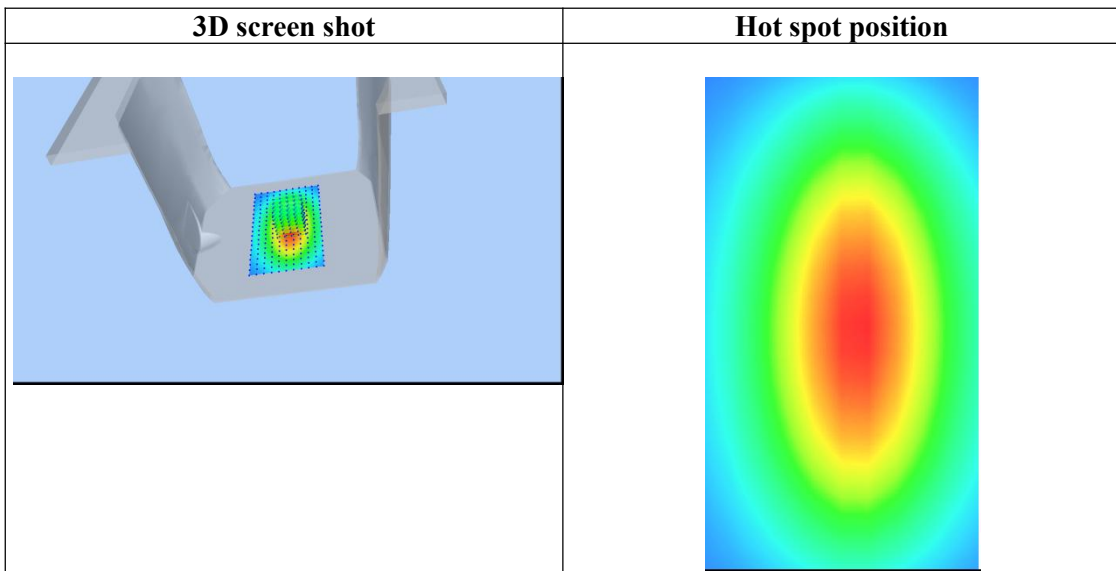
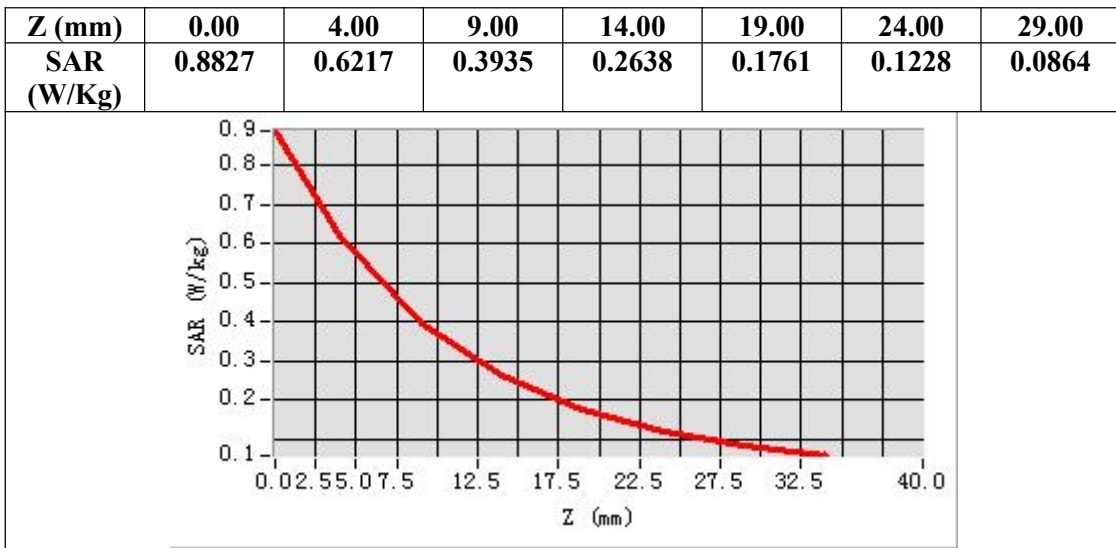

Any report having not been signed by authorized approver, or having been altered without authorization, or having not been stamped by the “Dedicated Testing/Inspection Stamp” is deemed to be invalid. Copying or excerpting portion of, or altering the content of the report is not permitted without the written authorization of AGC. The test results presented in the report apply only to the tested sample. Any objections to report issued by AGC should be submitted to AGC within 15days after the issuance of the test report. Further enquiry of validity or verification of the test report should be addressed to AGC by agc01@agccert.com.

Test Laboratory: AGC Lab

Date: Jan. 03, 2024

System Check Head 835 MHz

DUT: Dipole 835 MHz Type: SID 835

Communication System CW; Communication System Band: D835 (835.0 MHz); Duty Cycle: 1:1; Conv.F=2.02

Frequency: 835 MHz; Medium parameters used:  $f = 835$  MHz;  $\sigma=0.91$  mho/m;  $\epsilon_r = 41.50$ ;  $\rho = 1000$  kg/m<sup>3</sup> ;

Phantom section: Flat Section; Input Power=18dBm

Ambient temperature (°C):21.1, Liquid temperature (°C): 20.8

SATIMO Configuration:

- Probe: SSE2; Calibrated: May 31, 2023; Serial No.: 2023-EPGO-414
- Sensor-Surface: 4mm (Mechanical Surface Detection)
- Phantom: SAM twin phantom
- Measurement SW: OpenSAR V4\_02\_35

Configuration/System Check 835MHz Head/Area Scan: Measurement grid: dx=8mm, dy=8mm

Configuration/System Check 835MHz Head/Zoom Scan: Measurement grid: dx=8mm,dy=8mm, dz=5mm

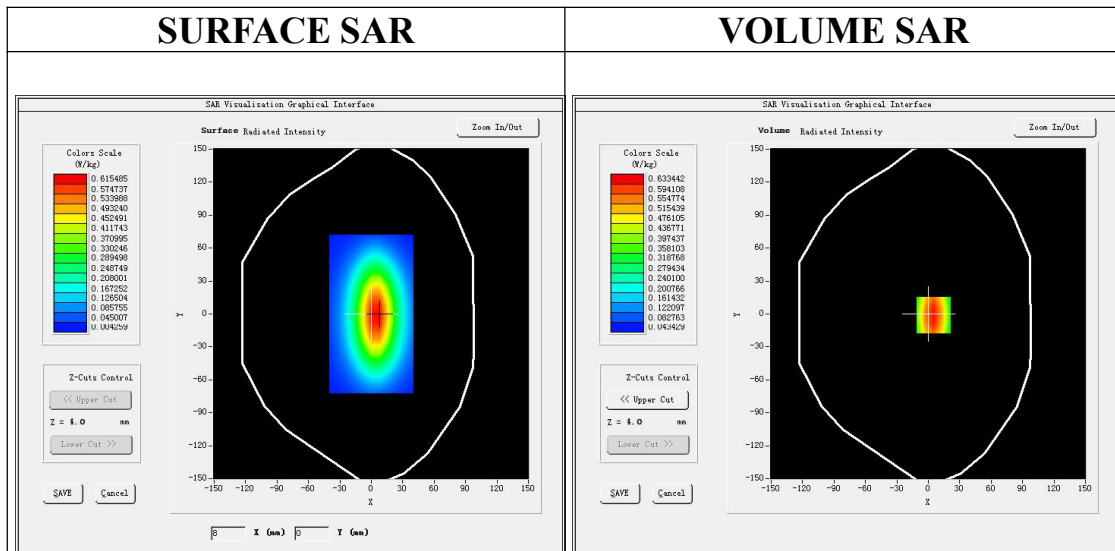

**Maximum location: X=5.00, Y=-1.00**

**SAR Peak: 0.90 W/kg**

<b>SAR 10g (W/Kg)</b>	0.389852
<b>SAR 1g (W/Kg)</b>	0.606834

Any report having not been signed by authorized approver, or having been altered without authorization, or having not been stamped by the "Dedicated Testing/Inspection Stamp" is deemed to be invalid. Copying or excerpting portion of, or altering the content of the report is not permitted without the written authorization of AGC. The test results presented in the report apply only to the tested sample. Any objections to report issued by AGC should be submitted to AGC within 15days after the issuance of the test report. Further enquiry of validity or verification of the test report should be addressed to AGC by agc01@agccert.com.

Attestation of Global Compliance(Shenzhen)Co., Ltd

Attestation of Global Compliance(Shenzhen)Std & Tech Co., Ltd

Tel: +86-755 2523 4088 E-mail: agc@agccert.com Web: http://www.agccert.com/

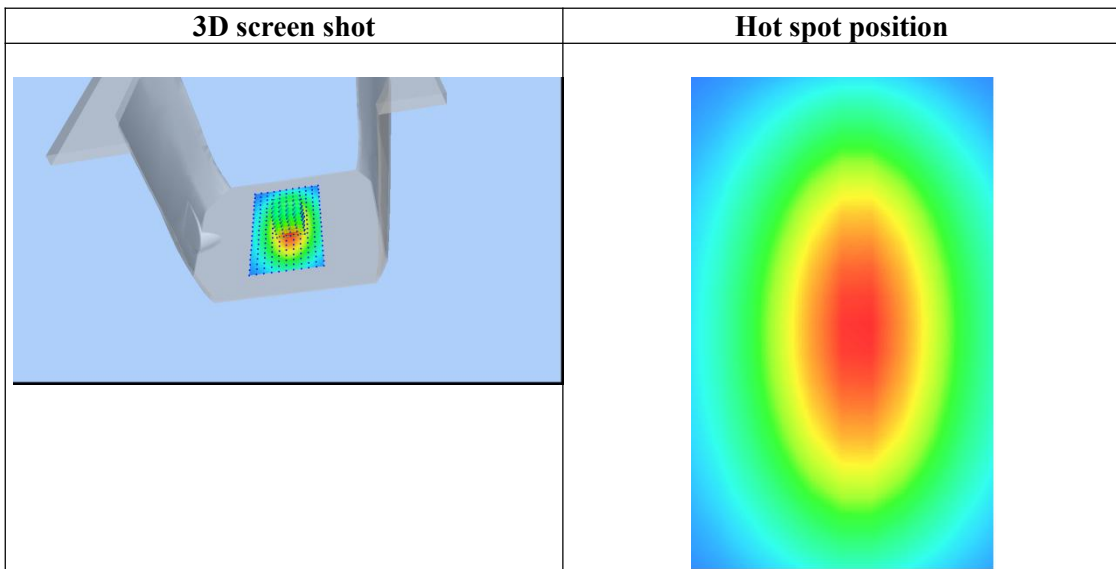
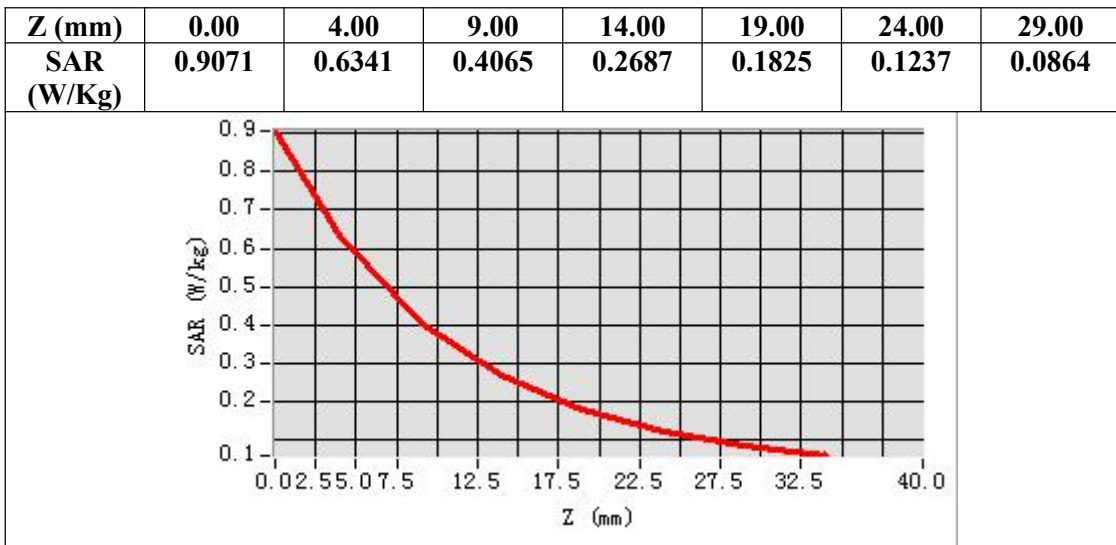

Any report having not been signed by authorized approver, or having been altered without authorization, or having not been stamped by the “Dedicated Testing/Inspection Stamp” is deemed to be invalid. Copying or excerpting portion of, or altering the content of the report is not permitted without the written authorization of AGC. The test results presented in the report apply only to the tested sample. Any objections to report issued by AGC should be submitted to AGC within 15days after the issuance of the test report. Further enquiry of validity or verification of the test report should be addressed to AGC by agc01@agccert.com.

**Test Laboratory: AGC Lab**

**Date: Jan. 07, 2024**

**System Check Head 1750MHz**

DUT: Dipole 1800 MHz; Type: SID 1800

Communication System: CW; Communication System Band: D1700 (1750.0 MHz); Duty Cycle:1:1; Conv.F=2.17

Frequency: 1750 MHz; Medium parameters used:  $f = 1750\text{MHz}$ ;  $\sigma = 1.32 \text{ mho/m}$ ;  $\epsilon_r = 39.71$ ;  $\rho = 1000 \text{ kg/m}^3$  ;

Phantom section: Flat Section; Input Power=18dBm

Ambient temperature ( $^{\circ}\text{C}$ ): 20.9, Liquid temperature ( $^{\circ}\text{C}$ ): 20.6

SATIMO Configuration:

Probe: SSE2; Calibrated: May 31, 2023; Serial No.: 2023-EPGO-414

- Sensor-Surface: 4mm (Mechanical Surface Detection)
- Phantom: SAM twin phantom
- Measurement SW: OpenSAR V4\_02\_35

**Configuration/System Check 1750MHz Head/Area Scan:** Measurement grid:  $dx=8\text{mm}, dy=8\text{mm}$

**Configuration/System Check 1750MHz Head/Zoom Scan:** Measurement grid:  $dx=8\text{mm}, dy=8\text{mm}, dz=5\text{mm}$

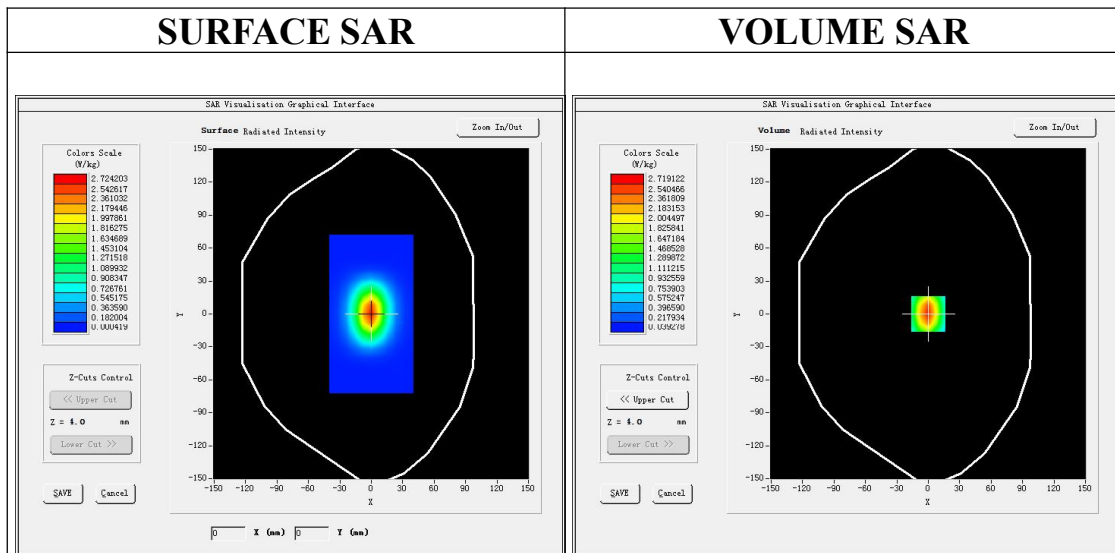

**Maximum location: X=0.00, Y=0.00**

**SAR Peak: 4.41 W/kg**

<b>SAR 10g (W/Kg)</b>	1.291432
<b>SAR 1g (W/Kg)</b>	2.563877

Any report having not been signed by authorized approver, or having been altered without authorization, or having not been stamped by the "Dedicated Testing/Inspection Stamp" is deemed to be invalid. Copying or excerpting portion of, or altering the content of the report is not permitted without the written authorization of AGC. The test results presented in the report apply only to the tested sample. Any objections to report issued by AGC should be submitted to AGC within 15days after the issuance of the test report. Further enquiry of validity or verification of the test report should be addressed to AGC by [agc01@agccert.com](mailto:agc01@agccert.com).

Attestation of Global Compliance(Shenzhen)Co., Ltd

Attestation of Global Compliance(Shenzhen)Std & Tech Co., Ltd

Tel: +86-755 2523 4088 E-mail: [agc@agccert.com](mailto:agc@agccert.com) Web: <http://www.agccert.com/>

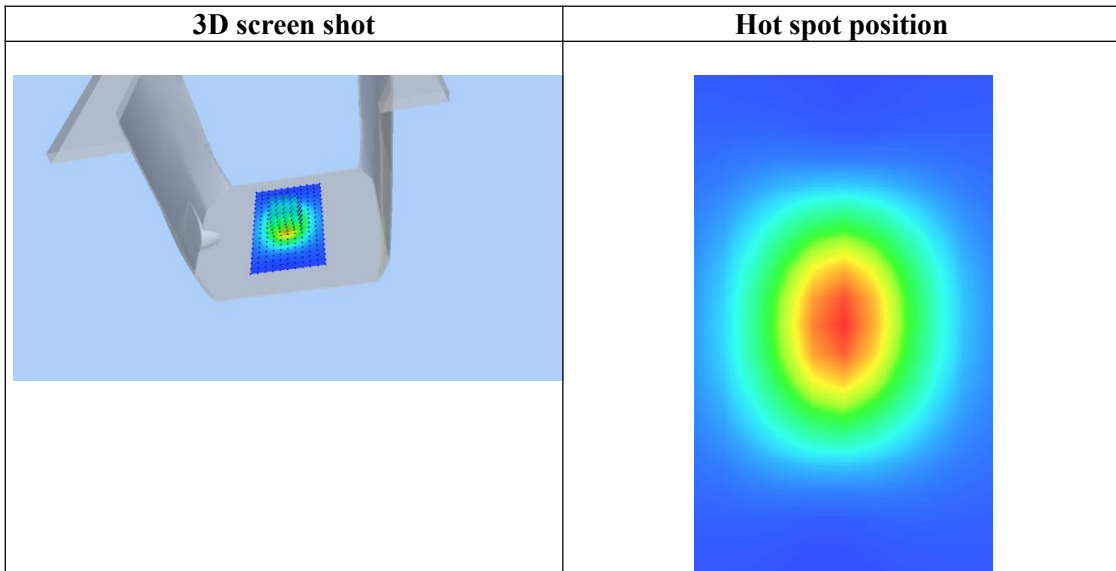
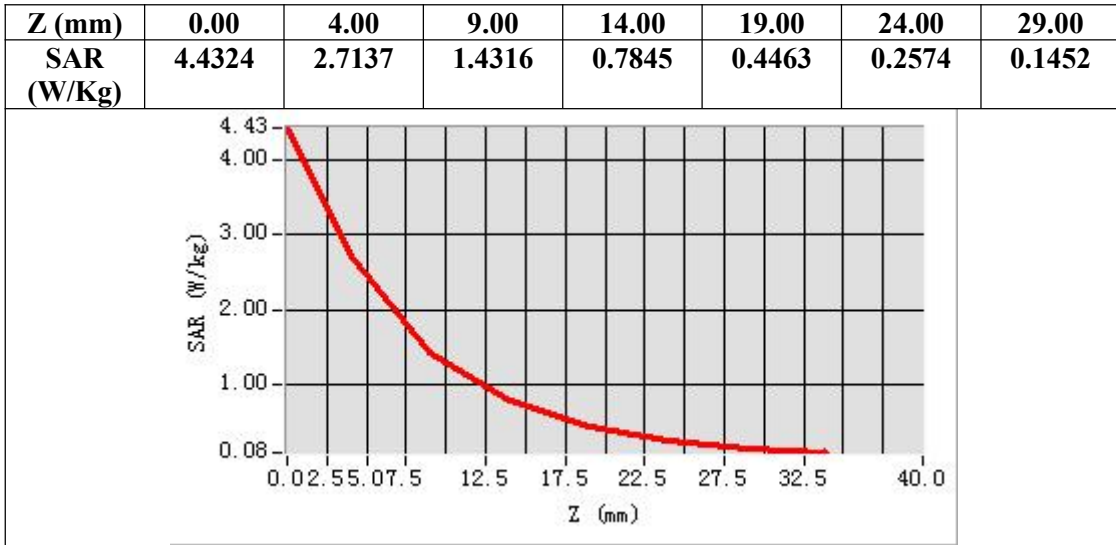

Any report having not been signed by authorized approver, or having been altered without authorization, or having not been stamped by the "Dedicated Testing/Inspection Stamp" is deemed to be invalid. Copying or excerpting portion of, or altering the content of the report is not permitted without the written authorization of AGC. The test results presented in the report apply only to the tested sample. Any objections to report issued by AGC should be submitted to AGC within 15days after the issuance of the test report. Further enquiry of validity or verification of the test report should be addressed to AGC by agc01@agccert.com.

**Test Laboratory: AGC Lab**  
**System Check Head 1900MHz**

**Date: Jan. 08, 2024**

**DUT: Dipole 1900 MHz; Type: SID 1900**

Communication System: CW; Communication System Band: D1900 (1900.0 MHz); Duty Cycle:1:1; Conv.F=2.15  
Frequency: 1900 MHz; Medium parameters used:  $f = 1900$  MHz;  $\sigma=1.36$  mho/m;  $\epsilon_r=39.34$ ;  $\rho= 1000$  kg/m<sup>3</sup> ;  
Phantom section: Flat Section; Input Power=18dBm  
Ambient temperature (°C):20.9, Liquid temperature (°C): 20.4

SATIMO Configuration:

Probe: SSE2; Calibrated: May 31, 2023; Serial No.: 2023-EPGO-414

- Sensor-Surface: 4mm (Mechanical Surface Detection)
- Phantom: SAM twin phantom
- Measurement SW: OpenSAR V4\_02\_35

**Configuration/System Check 1900MHz Head/Area Scan:** Measurement grid: dx=8mm, dy=8mm

**Configuration/System Check 1900MHz Head/Zoom Scan:** Measurement grid: dx=8mm,dy=8mm, dz=5mm

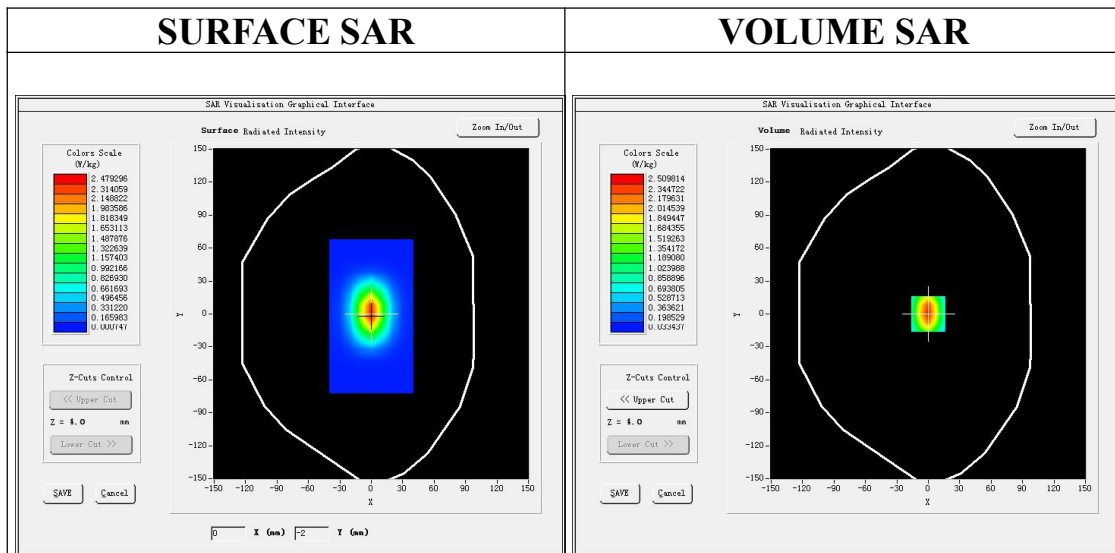

**Maximum location: X=0.00, Y=0.00**

**SAR Peak: 4.09 W/kg**

<b>SAR 10g (W/Kg)</b>	1.286741
<b>SAR 1g (W/Kg)</b>	2.489352

Any report having not been signed by authorized approver, or having been altered without authorization, or having not been stamped by the "Dedicated Testing/Inspection Stamp" is deemed to be invalid. Copying or excerpting portion of, or altering the content of the report is not permitted without the written authorization of AGC. The test results presented in the report apply only to the tested sample. Any objections to report issued by AGC should be submitted to AGC within 15days after the issuance of the test report. Further enquiry of validity or verification of the test report should be addressed to AGC by agc01@agccert.com.



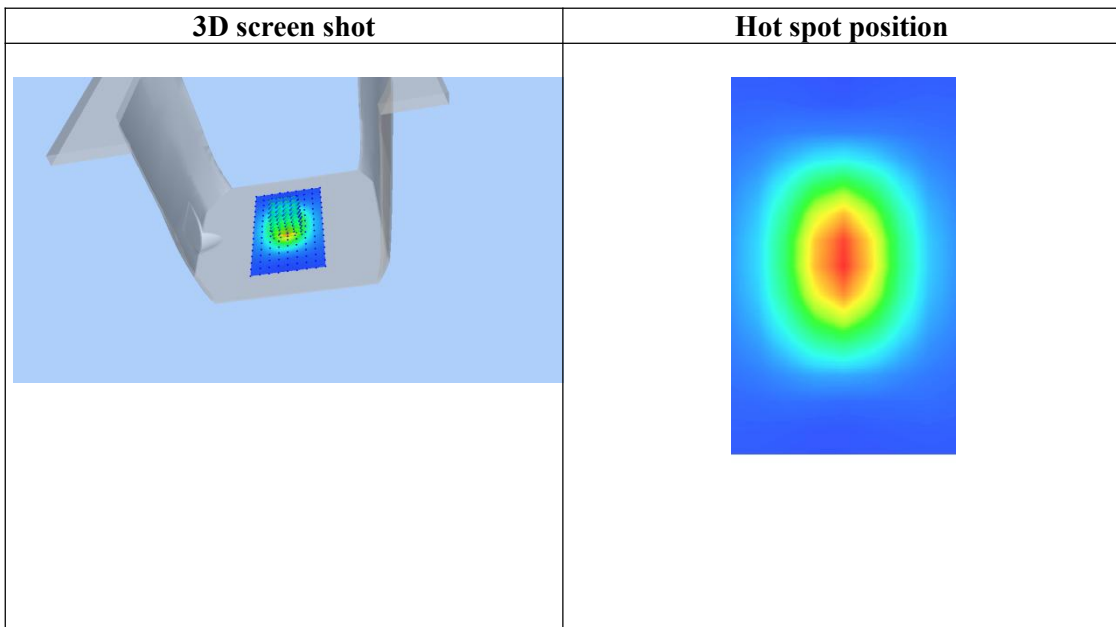
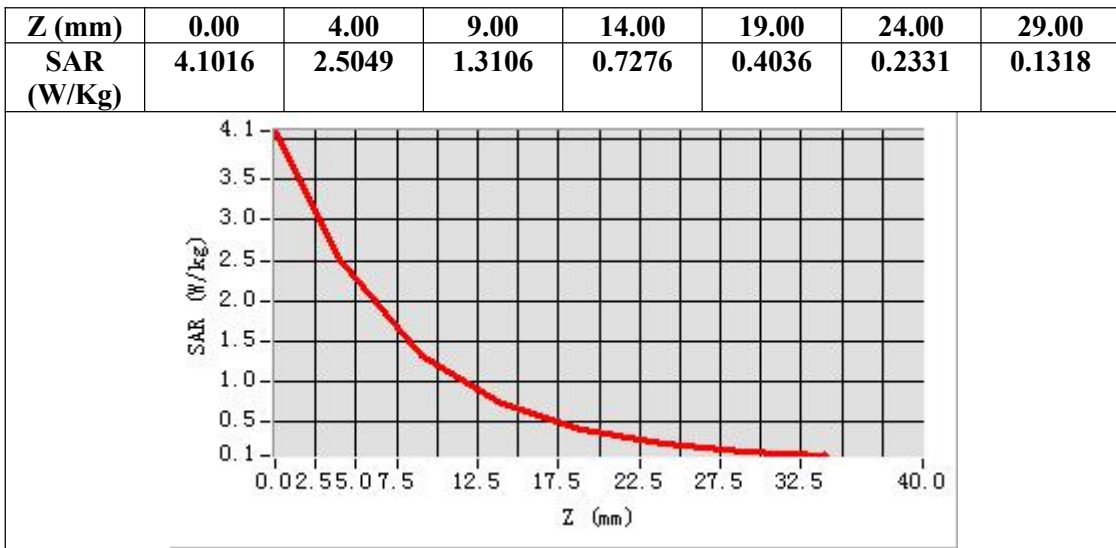

Any report having not been signed by authorized approver, or having been altered without authorization, or having not been stamped by the “Dedicated Testing/Inspection Stamp” is deemed to be invalid. Copying or excerpting portion of, or altering the content of the report is not permitted without the written authorization of AGC. The test results presented in the report apply only to the tested sample. Any objections to report issued by AGC should be submitted to AGC within 15days after the issuance of the test report. Further enquiry of validity or verification of the test report should be addressed to AGC by agc01@agccert.com.

Test Laboratory: AGC Lab

Date: Jan. 06, 2024

System Check Head 2450 MHz

DUT: Dipole 2450 MHz Type: SID 2450

Communication System CW; Communication System Band: D2450 (2450.0 MHz); Duty Cycle: 1:1; Conv.F=2.29

Frequency: 2450 MHz; Medium parameters used:  $f = 2450$  MHz;  $\sigma = 1.82$  mho/m;  $\epsilon_r = 39.43$ ;  $\rho = 1000$  kg/m<sup>3</sup> ;

Phantom section: Flat Section; Input Power=18dBm

Ambient temperature (°C):21.2, Liquid temperature (°C): 20.8

SATIMO Configuration

- Probe: SSE2; Calibrated: May 31, 2023; Serial No.: 2023-EPGO-414
- Sensor-Surface: 4mm (Mechanical Surface Detection)
- Phantom: SAM twin phantom
- Measurement SW: OpenSAR V4\_02\_35

Configuration/System Check 2450MHz Head/Area Scan: Measurement grid: dx=8mm, dy=8mm

Configuration/System Check 2450MHz Head/Zoom Scan: Measurement grid: dx=5mm,dy=5mm, dz=5mm

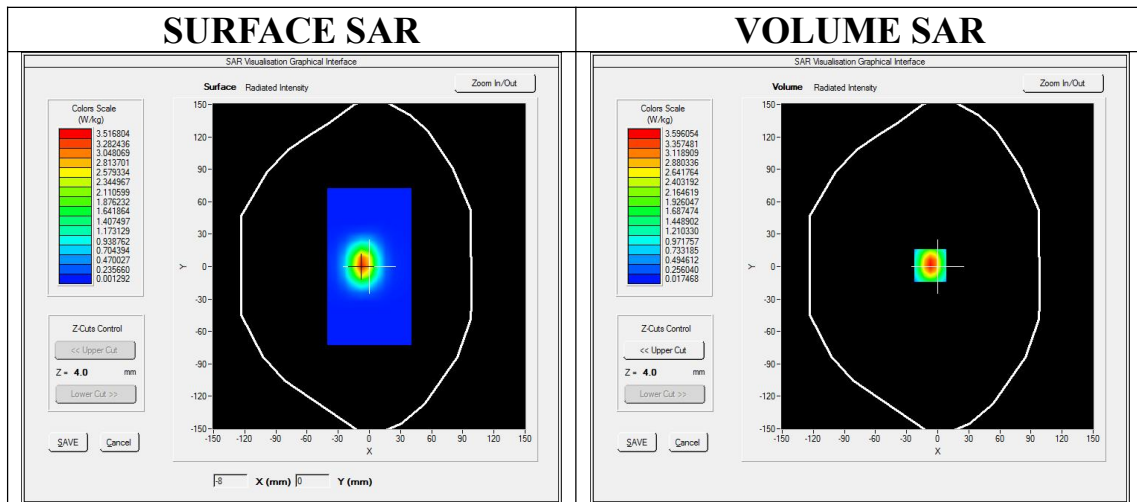

Maximum location: X=-7.00, Y=1.00

SAR Peak: 6.16 W/kg

SAR 10g (W/Kg)	1.496380
SAR 1g (W/Kg)	3.315274

Any report having not been signed by authorized approver, or having been altered without authorization, or having not been stamped by the “Dedicated Testing/Inspection Stamp” is deemed to be invalid. Copying or excerpting portion of, or altering the content of the report is not permitted without the written authorization of AGC. The test results presented in the report apply only to the tested sample. Any objections to report issued by AGC should be submitted to AGC within 15days after the issuance of the test report. Further enquiry of validity or verification of the test report should be addressed to AGC by agc01@agccert.com.

Attestation of Global Compliance(Shenzhen)Co., Ltd

Attestation of Global Compliance(Shenzhen)Std & Tech Co., Ltd

Tel: +86-755 2523 4088 E-mail: agc@agccert.com Web: http://www.agccert.com/

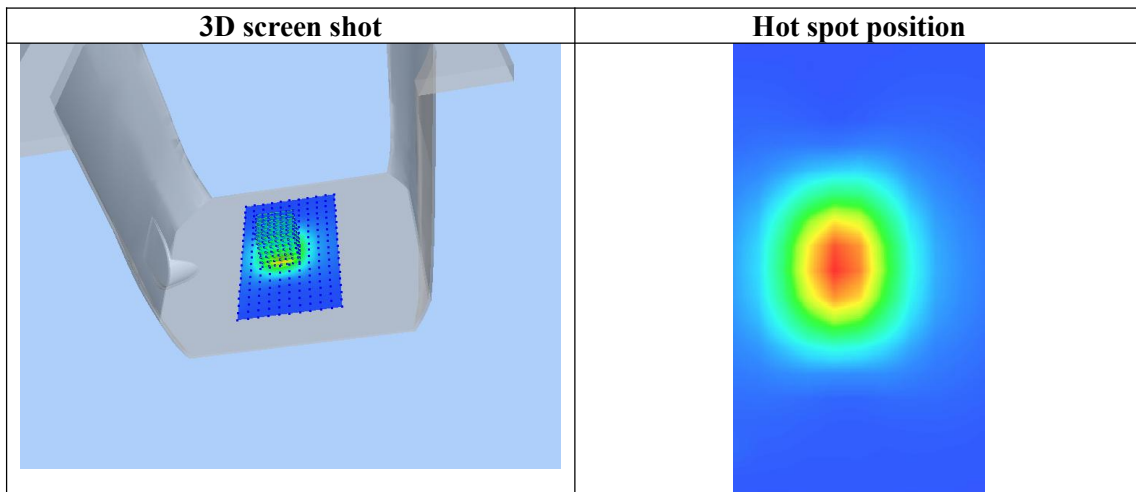
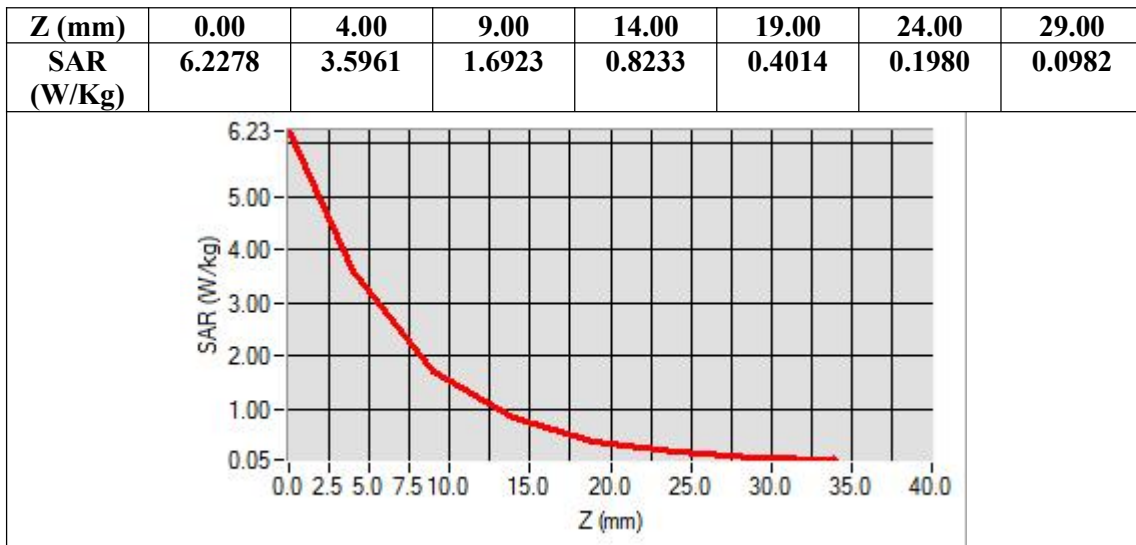

Any report having not been signed by authorized approver, or having been altered without authorization, or having not been stamped by the “Dedicated Testing/Inspection Stamp” is deemed to be invalid. Copying or excerpting portion of, or altering the content of the report is not permitted without the written authorization of AGC. The test results presented in the report apply only to the tested sample. Any objections to report issued by AGC should be submitted to AGC within 15days after the issuance of the test report. Further enquiry of validity or verification of the test report should be addressed to AGC by agc01@agccert.com.

**Test Laboratory: AGC Lab**

**Date: Jan. 05, 2024**

**System Check Head 2600MHz**

DUT: Dipole 2600 MHz; Type: SID 2600

Communication System: CW; Communication System Band: D2600 (2600.0 MHz); Duty Cycle: 1:1; Conv.F=2.13

Frequency:2600 MHz; Medium parameters used:  $f = 2600$  MHz;  $\sigma = 1.99$  mho/m;  $\epsilon_r = 38.18$ ;  $\rho = 1000$  kg/m<sup>3</sup> ;

Phantom section: Flat Section; Input Power=18dBm

Ambient temperature (°C): 21.4, Liquid temperature (°C): 21.2

SATIMO Configuration:

- Probe: SSE2; Calibrated: May 31, 2023; Serial No.: 2023-EPGO-414
- Sensor-Surface: 4mm (Mechanical Surface Detection)
- Phantom: SAM twin phantom
- Measurement SW: OpenSAR V4\_02\_35

**Configuration/System Check 2600 Head/Area Scan:** Measurement grid: dx=8mm,dy=8mm

**Configuration/System Check 2600 Head/Zoom Scan:** Measurement grid: dx=5mm,dy=5mm, dz=5mm

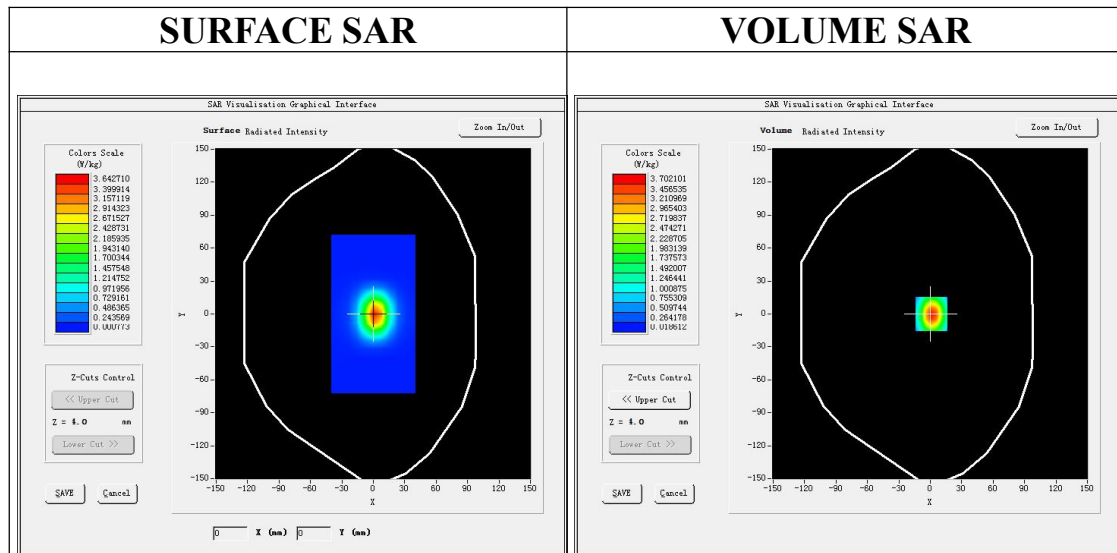

**Maximum location: X=1.00, Y=0.00**

**SAR Peak: 6.40 W/kg**

<b>SAR 10g (W/Kg)</b>	1.533942
<b>SAR 1g (W/Kg)</b>	3.421758

Any report having not been signed by authorized approver, or having been altered without authorization, or having not been stamped by the "Dedicated Testing/Inspection Stamp" is deemed to be invalid. Copying or excerpting portion of, or altering the content of the report is not permitted without the written authorization of AGC. The test results presented in the report apply only to the tested sample. Any objections to report issued by AGC should be submitted to AGC within 15days after the issuance of the test report. Further enquiry of validity or verification of the test report should be addressed to AGC by agc01@agccert.com.

Attestation of Global Compliance(Shenzhen)Co., Ltd

Attestation of Global Compliance(Shenzhen)Std & Tech Co., Ltd

Tel: +86-755 2523 4088 E-mail: agc@agccert.com Web: http://www.agccert.com/

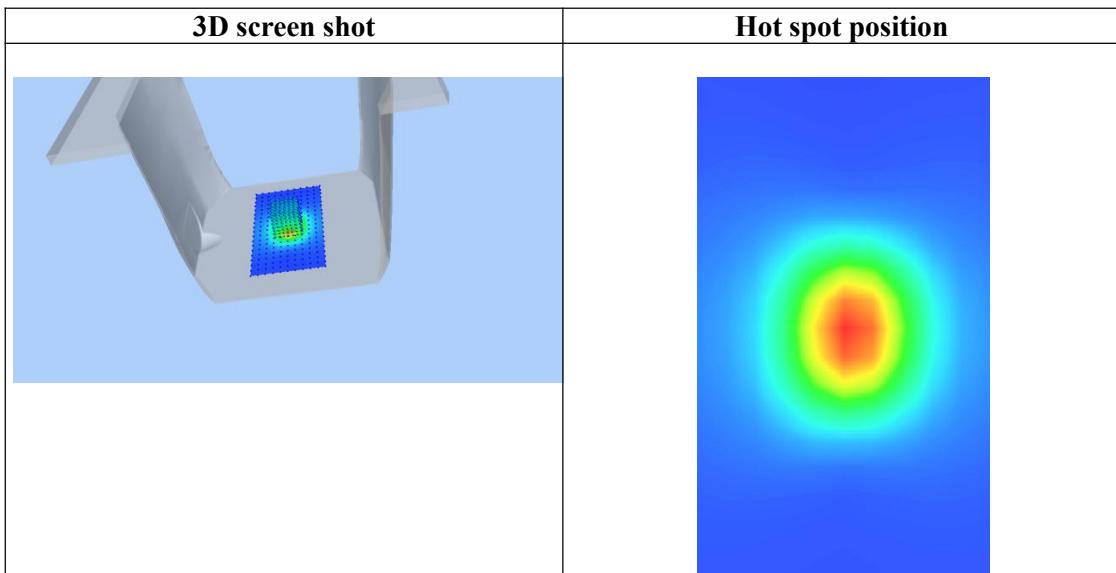
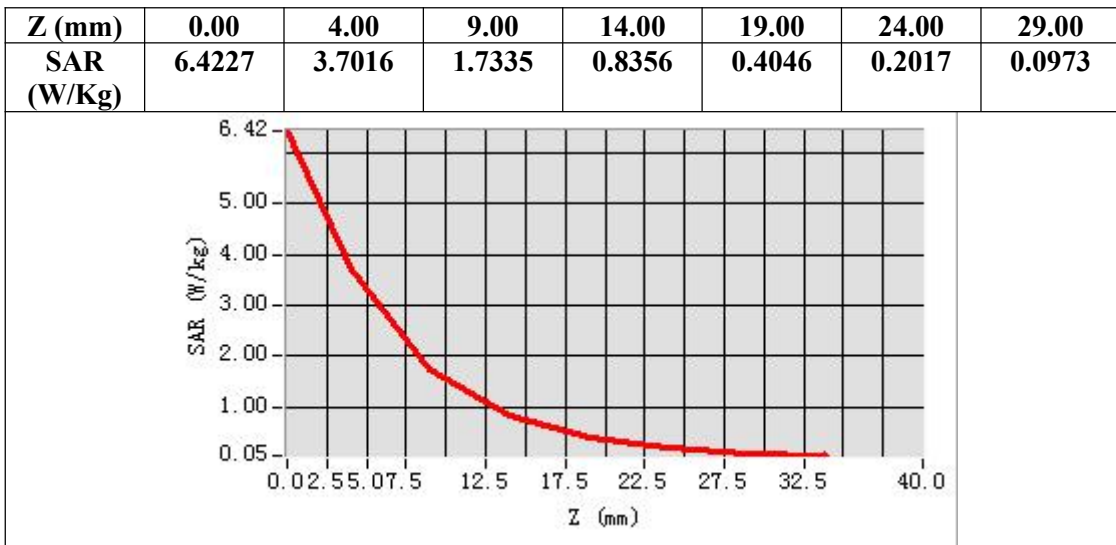

Any report having not been signed by authorized approver, or having been altered without authorization, or having not been stamped by the “Dedicated Testing/Inspection Stamp” is deemed to be invalid. Copying or excerpting portion of, or altering the content of the report is not permitted without the written authorization of AGC. The test results presented in the report apply only to the tested sample. Any objections to report issued by AGC should be submitted to AGC within 15days after the issuance of the test report. Further enquiry of validity or verification of the test report should be addressed to AGC by agc01@agccert.com.

## APPENDIX B. SAR MEASUREMENT DATA

Test Laboratory: AGC Lab

Date: Jan. 03, 2024

GSM 850 Mid-Touch-Right <SIM 1>

DUT: Smartphone; Type: VORTEX HD68

Communication System: Generic GSM; Communication System Band: GSM 850; Duty Cycle: 1:8.3; Conv.F=2.02; Frequency: 836.6 MHz; Medium parameters used:  $f = 835$  MHz;  $\sigma = 0.94$  mho/m;  $\epsilon_r = 40.67$ ;  $\rho = 1000$  kg/m<sup>3</sup>; Phantom section: Right Section  
Ambient temperature (°C): 21.1, Liquid temperature (°C): 20.8

SATIMO Configuration:

- Probe: SSE2; Calibrated: May 31, 2023; Serial No.: 2023-EPGO-414
- Sensor-Surface: 4mm (Mechanical Surface Detection)
- Phantom: SAM twin phantom
- Measurement SW: OpenSAR V4\_02\_35

Configuration/GSM 850 Mid-Touch-Right/Area Scan: Measurement grid: dx=8mm, dy=8mm

Configuration/GSM 850 Mid-Touch-Right/Zoom Scan: Measurement grid: dx=8mm,dy=8mm, dz=5mm;

<b>Area Scan</b>	dx=8mm dy=8mm, h= 5.00 mm
<b>ZoomScan</b>	5x5x7,dx=8mm dy=8mm dz=5mm,Complete
<b>Phantom</b>	Right head
<b>Device Position</b>	Cheek
<b>Band</b>	GSM 850
<b>Channels</b>	Middle
<b>Signal</b>	TDMA (Crest factor: 8.0)

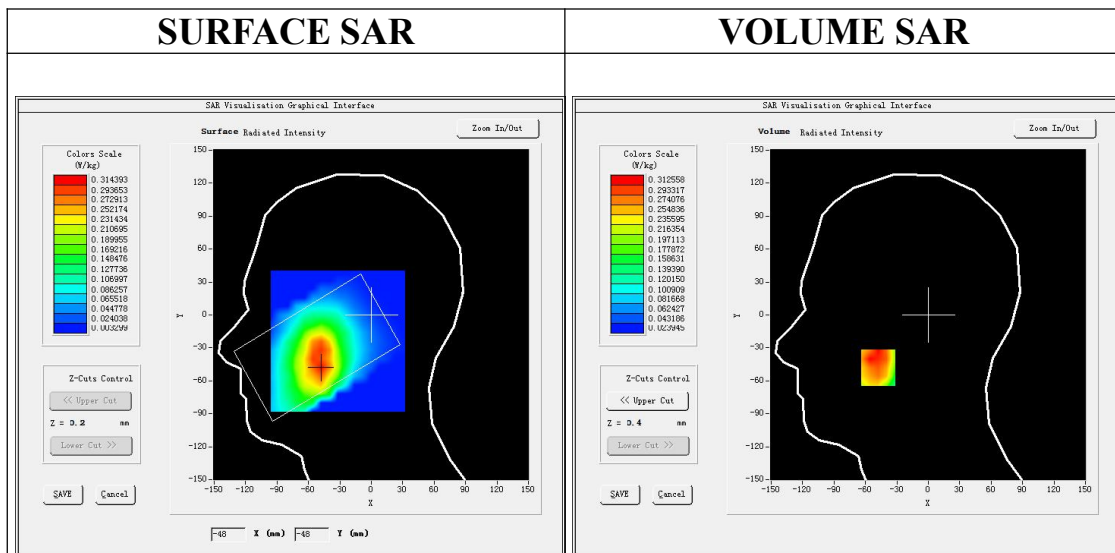

**Maximum location: X=-48.00, Y=-48.00**

**SAR Peak: 0.41 W/kg**

<b>SAR 10g (W/Kg)</b>	0.214604
<b>SAR 1g (W/Kg)</b>	0.302000

Any report having not been signed by authorized approver, or having been altered without authorization, or having not been stamped by the "Dedicated Testing/Inspection Stamp" is deemed to be invalid. Copying or excerpting portion of, or altering the content of the report is not permitted without the written authorization of AGC. The test results presented in the report apply only to the tested sample. Any objections to report issued by AGC should be submitted to AGC within 15days after the issuance of the test report. Further enquiry of validity or verification of the test report should be addressed to AGC by agc01@agccert.com.

Attestation of Global Compliance(Shenzhen)Co., Ltd

Attestation of Global Compliance(Shenzhen)Std & Tech Co., Ltd

Tel: +86-755 2523 4088 E-mail: agc@agccert.com Web: http://www.agccert.com/

<b>Z (mm)</b>	<b>0.00</b>	<b>4.00</b>	<b>9.00</b>	<b>14.00</b>	<b>19.00</b>	<b>24.00</b>	<b>29.00</b>
<b>SAR (W/Kg)</b>	<b>0.5183</b>	<b>0.3126</b>	<b>0.1818</b>	<b>0.1766</b>	<b>0.0984</b>	<b>0.1171</b>	<b>0.0581</b>

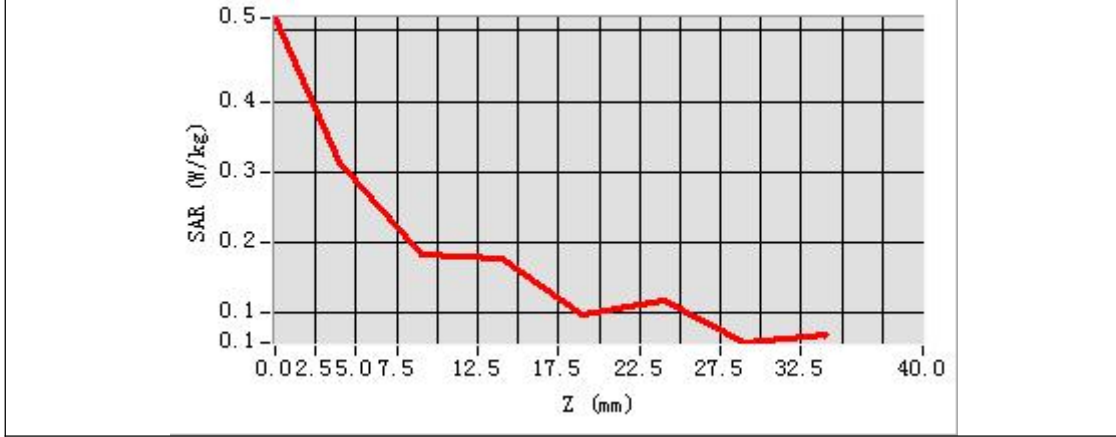

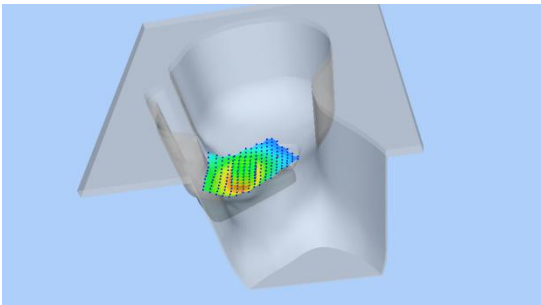
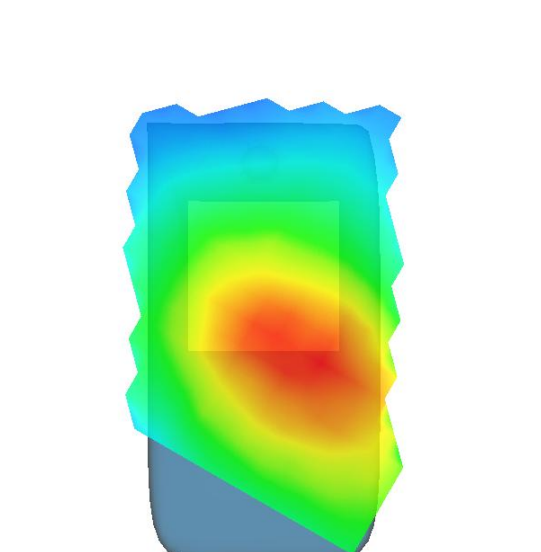
3D screen shot	Hot spot position
	

Any report having not been signed by authorized approver, or having been altered without authorization, or having not been stamped by the “Dedicated Testing/Inspection Stamp” is deemed to be invalid. Copying or excerpting portion of, or altering the content of the report is not permitted without the written authorization of AGC. The test results presented in the report apply only to the tested sample. Any objections to report issued by AGC should be submitted to AGC within 15days after the issuance of the test report. Further enquiry of validity or verification of the test report should be addressed to AGC by agc01@agccert.com.

**Test Laboratory: AGC Lab**  
**GSM 850 Mid- Body- Back (MS)<SIM 1>**  
**DUT: Smartphone; Type: VORTEX HD68**

**Date: Jan. 03, 2024**

Communication System: Generic GSM; Communication System Band: GSM 850; Duty Cycle: 1:8.3; Conv.F=2.02;  
Frequency: 836.6 MHz; Medium parameters used:  $f = 835$  MHz;  $\sigma = 0.94$  mho/m;  $\epsilon_r = 40.67$ ;  $\rho = 1000$  kg/m<sup>3</sup> ;  
Phantom section: Flat Section  
Ambient temperature (°C): 21.1, Liquid temperature (°C): 20.8

**SATIMO Configuration:**

- Probe: SSE2; Calibrated: May 31, 2023; Serial No.: 2023-EPGO-414
- Sensor-Surface: 4mm (Mechanical Surface Detection)
- Phantom: SAM twin phantom
- Measurement SW: OpenSAR V4\_02\_35

**Configuration/GSM 850 Mid-Body-Back/Area Scan:** Measurement grid: dx=8mm, dy=8mm  
**Configuration/GSM 850 Mid-Body-Back/Zoom Scan:** Measurement grid: dx=8mm,dy=8mm, dz=5mm;

<b>Area Scan</b>	surf_sam_plan.txt, h= 5.00 mm
<b>ZoomScan</b>	5x5x7,dx=8mm dy=8mm dz=5mm,Complete
<b>Phantom</b>	Validation plane
<b>Device Position</b>	Body Back
<b>Band</b>	GSM 850
<b>Channels</b>	Middle
<b>Signal</b>	TDMA (Crest factor: 8.0)

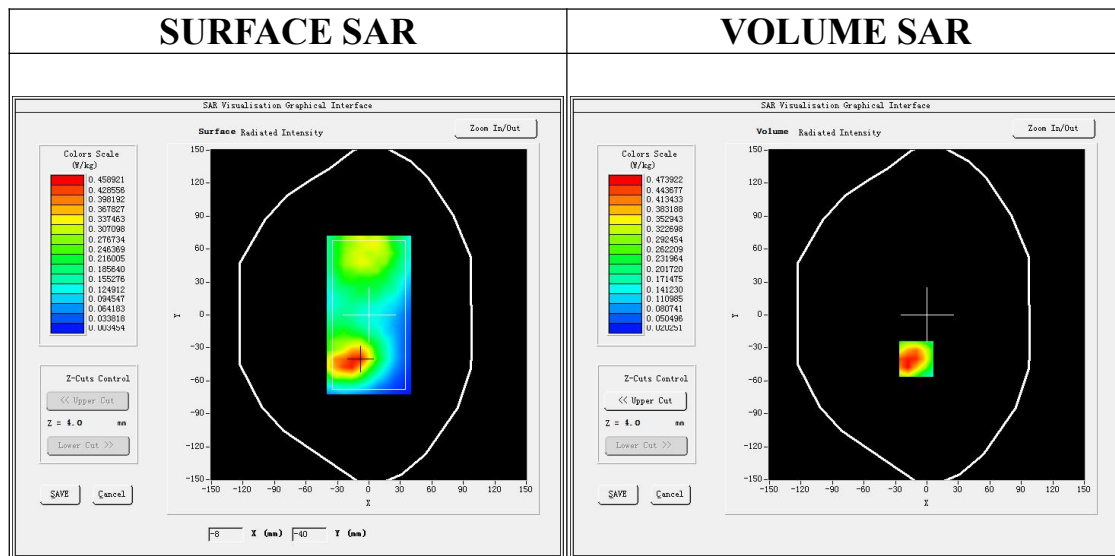

**Maximum location: X=-10.00, Y=-40.00**

**SAR Peak: 0.80 W/kg**

<b>SAR 10g (W/Kg)</b>	0.256546
<b>SAR 1g (W/Kg)</b>	0.462002

Any report having not been signed by authorized approver, or having been altered without authorization, or having not been stamped by the "Dedicated Testing/Inspection Stamp" is deemed to be invalid. Copying or excerpting portion of, or altering the content of the report is not permitted without the written authorization of AGC. The test results presented in the report apply only to the tested sample. Any objections to report issued by AGC should be submitted to AGC within 15days after the issuance of the test report. Further enquiry of validity or verification of the test report should be addressed to AGC by agc01@agccert.com.



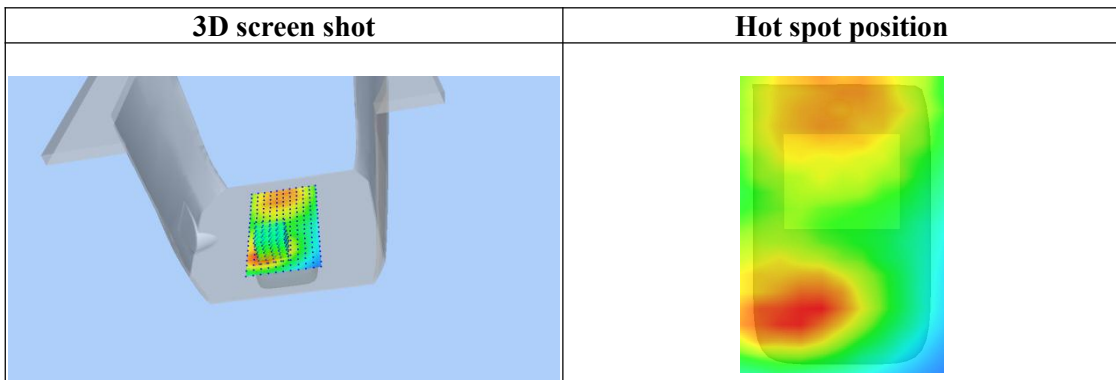

Any report having not been signed by authorized approver, or having been altered without authorization, or having not been stamped by the “Dedicated Testing/Inspection Stamp” is deemed to be invalid. Copying or excerpting portion of, or altering the content of the report is not permitted without the written authorization of AGC. The test results presented in the report apply only to the tested sample. Any objections to report issued by AGC should be submitted to AGC within 15days after the issuance of the test report. Further enquiry of validity or verification of the test report should be addressed to AGC by agc01@agccert.com.

**Test Laboratory: AGC Lab**  
**GPRS 850 Mid- Body- Back (2up)**  
**DUT: Smartphone; Type: VORTEX HD68**

**Date: Jan. 03, 2024**

Communication System: GPRS-2 Slot; Communication System Band: GSM 850; Duty Cycle: 1:4.2; Conv.F=2.02;  
Frequency: 836.6 MHz; Medium parameters used:  $f = 835$  MHz;  $\sigma = 0.94$  mho/m;  $\epsilon_r = 40.67$ ;  $\rho = 1000$  kg/m<sup>3</sup> ;  
Phantom section: Flat Section  
Ambient temperature (°C): 21.1, Liquid temperature (°C): 20.8

**SATIMO Configuration:**

- Probe: SSE2; Calibrated: May 31, 2023; Serial No.: 2023-EPGO-414
- Sensor-Surface: 4mm (Mechanical Surface Detection)
- Phantom: SAM twin phantom
- Measurement SW: OpenSAR V4\_02\_35

**Configuration/GPRS 850 Mid-Body-Back/Area Scan:** Measurement grid: dx=8mm, dy=8mm  
**Configuration/GPRS 850 Mid-Body-Back/Zoom Scan:** Measurement grid: dx=8mm, dy=8mm, dz=5mm;

<b>Area Scan</b>	surf_sam_plan.txt, h= 5.00 mm
<b>Zoom Scan</b>	5x5x7,dx=8mm dy=8mm dz=5mm,Complete
<b>Phantom</b>	Validation plane
<b>Device Position</b>	Body Back
<b>Band</b>	GSM 850
<b>Channels</b>	Middle
<b>Signal</b>	TDMA (Crest factor: 4.0)

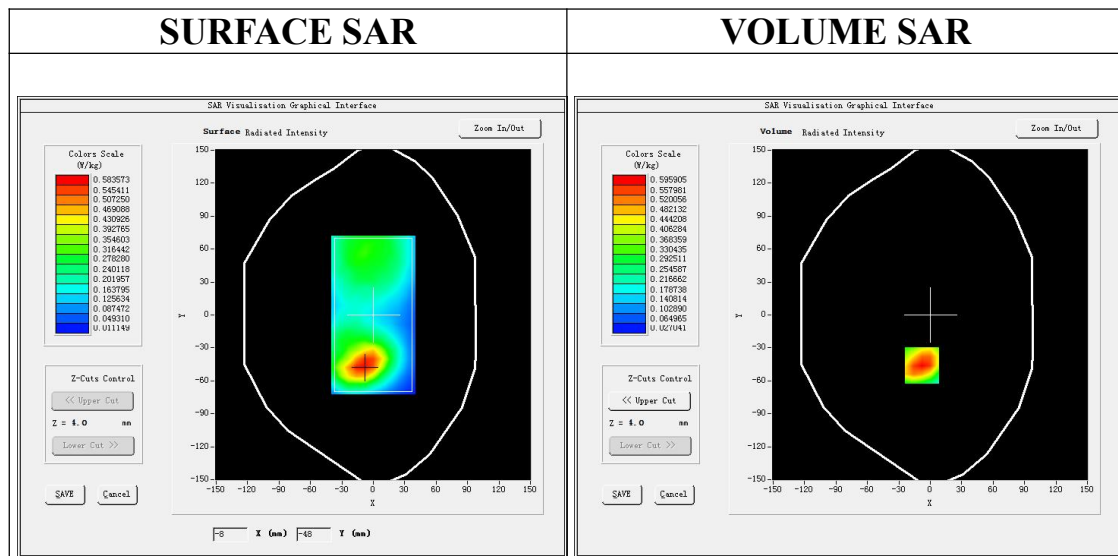

**Maximum location: X=-8.00, Y=-46.00**  
**SAR Peak: 0.90 W/kg**

<b>SAR 10g (W/Kg)</b>	0.333709
<b>SAR 1g (W/Kg)</b>	0.572297

Any report having not been signed by authorized approver, or having been altered without authorization, or having not been stamped by the “Dedicated Testing/Inspection Stamp” is deemed to be invalid. Copying or excerpting portion of, or altering the content of the report is not permitted without the written authorization of AGC. The test results presented in the report apply only to the tested sample. Any objections to report issued by AGC should be submitted to AGC within 15days after the issuance of the test report. Further enquiry of validity or verification of the test report should be addressed to AGC by agc01@agccert.com.

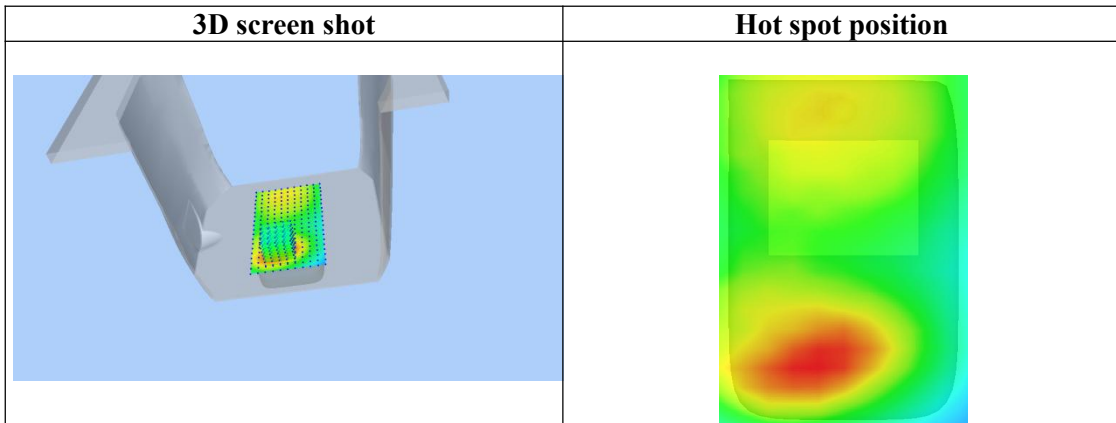
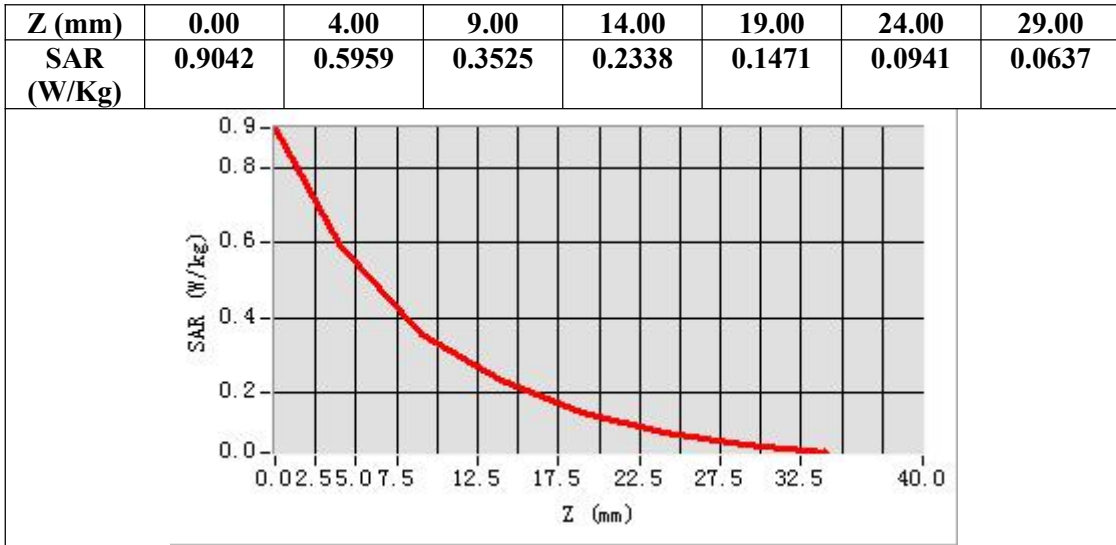

Any report having not been signed by authorized approver, or having been altered without authorization, or having not been stamped by the “Dedicated Testing/Inspection Stamp” is deemed to be invalid. Copying or excerpting portion of, or altering the content of the report is not permitted without the written authorization of AGC. The test results presented in the report apply only to the tested sample. Any objections to report issued by AGC should be submitted to AGC within 15days after the issuance of the test report. Further enquiry of validity or verification of the test report should be addressed to AGC by agc01@agccert.com.

**Test Laboratory: AGC Lab**  
**PCS 1900 Mid-Touch-Right <SIM 1>**  
**DUT: Smartphone; Type: VORTEX HD68**

**Date: Jan. 08, 2024**

Communication System: Generic GSM; Communication System Band: PCS 1900; Duty Cycle: 1:8.3; Conv.F=2.15;  
Frequency: 1880 MHz; Medium parameters used:  $f = 1900$  MHz;  $\sigma = 1.31$  mho/m;  $\epsilon_r = 40.69$ ;  $\rho = 1000$  kg/m<sup>3</sup> ;  
Phantom section: Right Section  
Ambient temperature (°C): 20.9, Liquid temperature (°C): 20.4

**SATIMO Configuration:**

- Probe: SSE2; Calibrated: May 31, 2023; Serial No.: 2023-EPGO-414
- Sensor-Surface: 4mm (Mechanical Surface Detection)
- Phantom: SAM twin phantom
- Measurement SW: OpenSAR V4\_02\_35

**Configuration/PCS1900 Mid-Touch-Right/Area Scan:** Measurement grid: dx=8mm, dy=8mm  
**Configuration/PCS1900 Mid-Touch-Right/Zoom Scan:** Measurement grid: dx=8mm,dy=8mm, dz=5mm;

<b>Area Scan</b>	dx=8mm dy=8mm, h= 5.00 mm
<b>ZoomScan</b>	5x5x7,dx=8mm dy=8mm dz=5mm,Complete
<b>Phantom</b>	Right head
<b>Device Position</b>	Cheek
<b>Band</b>	PCS 1900
<b>Channels</b>	Middle
<b>Signal</b>	TDMA (Crest factor: 8.0)

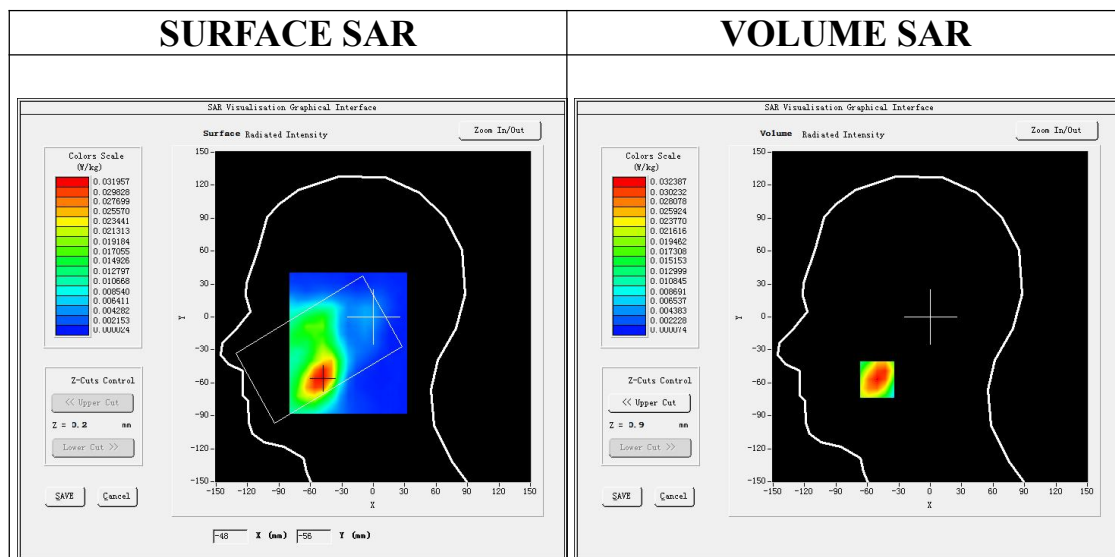

**Maximum location: X=-51.00, Y=-57.00**  
**SAR Peak: 0.05 W/kg**

<b>SAR 10g (W/Kg)</b>	0.017397
<b>SAR 1g (W/Kg)</b>	0.030879

Any report having not been signed by authorized approver, or having been altered without authorization, or having not been stamped by the “Dedicated Testing/Inspection Stamp” is deemed to be invalid. Copying or excerpting portion of, or altering the content of the report is not permitted without the written authorization of AGC. The test results presented in the report apply only to the tested sample. Any objections to report issued by AGC should be submitted to AGC within 15days after the issuance of the test report. Further enquiry of validity or verification of the test report should be addressed to AGC by agc01@agccert.com.

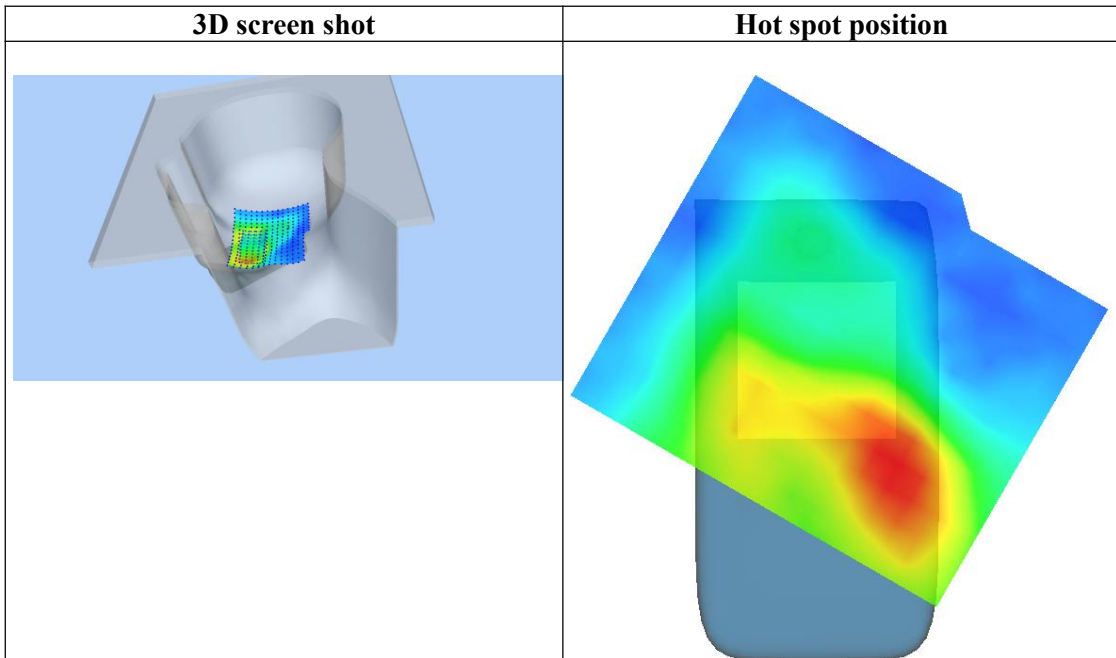
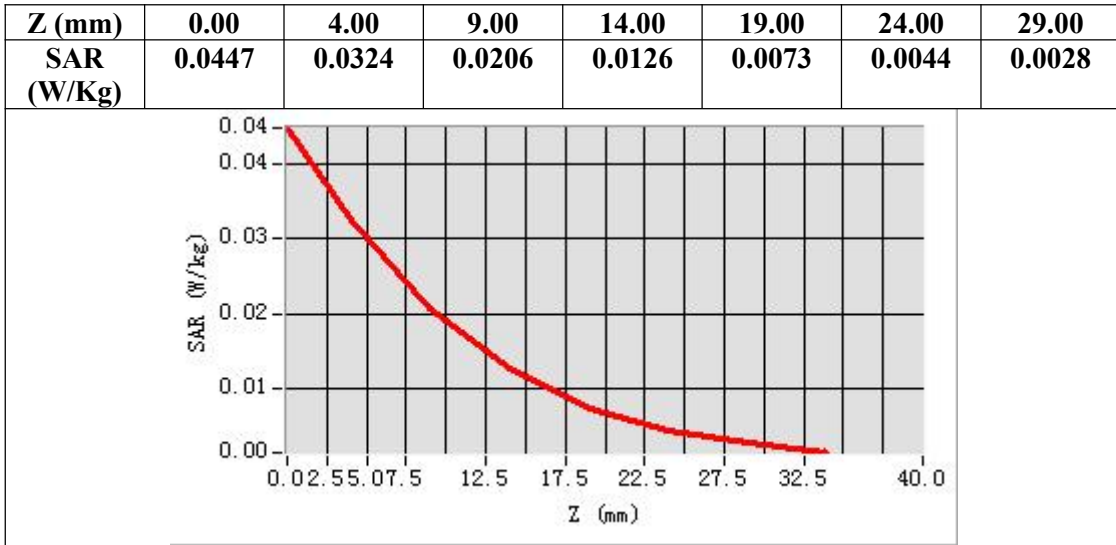

Any report having not been signed by authorized approver, or having been altered without authorization, or having not been stamped by the “Dedicated Testing/Inspection Stamp” is deemed to be invalid. Copying or excerpting portion of, or altering the content of the report is not permitted without the written authorization of AGC. The test results presented in the report apply only to the tested sample. Any objections to report issued by AGC should be submitted to AGC within 15days after the issuance of the test report. Further enquiry of validity or verification of the test report should be addressed to AGC by agc01@agccert.com.

**Test Laboratory: AGC Lab**  
**PCS 1900 Mid-Body-Back (MS)<SIM 1>**  
**DUT: Smartphone; Type: VORTEX HD68**

**Date: Jan. 08, 2024**

Communication System: Generic GSM; Communication System Band: PCS 1900; Duty Cycle: 1:8.3; Conv.F=2.15;  
Frequency: 1880 MHz; Medium parameters used:  $f = 1900$  MHz;  $\sigma = 1.31$  mho/m;  $\epsilon_r = 40.69$ ;  $\rho = 1000$  kg/m<sup>3</sup> ;  
Phantom section: Flat Section  
Ambient temperature (°C): 20.9, Liquid temperature (°C): 20.4

**SATIMO Configuration:**

- Probe: SSE2; Calibrated: May 31, 2023; Serial No.: 2023-EPGO-414
- Sensor-Surface: 4mm (Mechanical Surface Detection)
- Phantom: SAM twin phantom
- Measurement SW: OpenSAR V4\_02\_35

**Configuration/PCS1900 Mid-Body-Back/Area Scan:** Measurement grid: dx=8mm, dy=8mm  
**Configuration/PCS1900 Mid-Body-Back/Zoom Scan:** Measurement grid: dx=8mm,dy=8mm, dz=5mm;

<b>Area Scan</b>	surf_sam_plan.txt, h= 5.00 mm
<b>ZoomScan</b>	5x5x7,dx=8mm dy=8mm dz=5mm,Complete
<b>Phantom</b>	Validation plane
<b>Device Position</b>	Body Back
<b>Band</b>	PCS 1900
<b>Channels</b>	Middle
<b>Signal</b>	TDMA (Crest factor: 8.0)

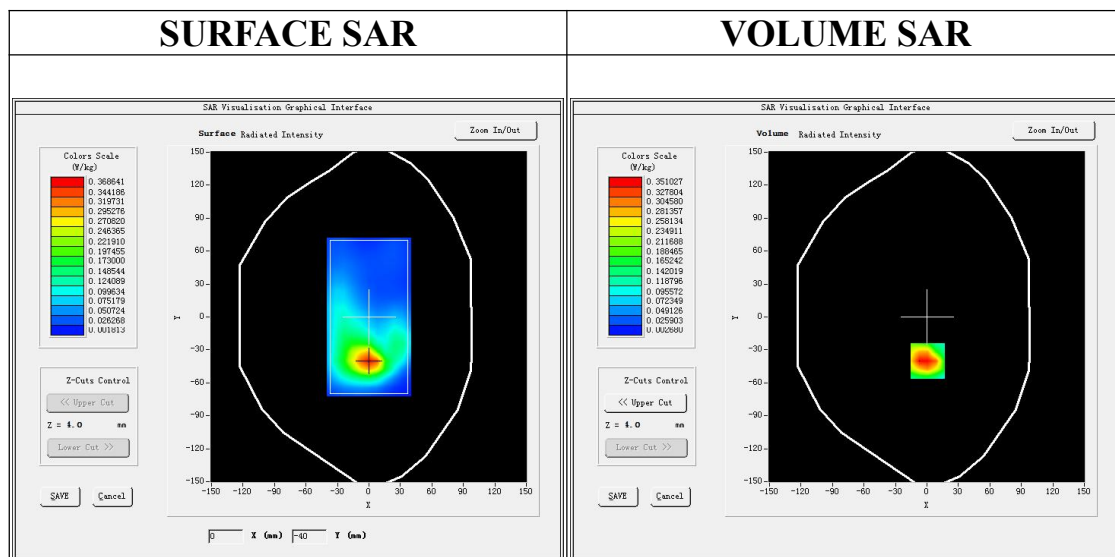

**Maximum location: X=1.00, Y=-40.00**

**SAR Peak: 0.56 W/kg**

<b>SAR 10g (W/Kg)</b>	0.174298
<b>SAR 1g (W/Kg)</b>	0.331294

Any report having not been signed by authorized approver, or having been altered without authorization, or having not been stamped by the “Dedicated Testing/Inspection Stamp” is deemed to be invalid. Copying or excerpting portion of, or altering the content of the report is not permitted without the written authorization of AGC. The test results presented in the report apply only to the tested sample. Any objections to report issued by AGC should be submitted to AGC within 15days after the issuance of the test report. Further enquiry of validity or verification of the test report should be addressed to AGC by agc01@agccert.com.

<b>Z (mm)</b>	<b>0.00</b>	<b>4.00</b>	<b>9.00</b>	<b>14.00</b>	<b>19.00</b>	<b>24.00</b>	<b>29.00</b>
<b>SAR (W/Kg)</b>	<b>0.6432</b>	<b>0.3510</b>	<b>0.1507</b>	<b>0.1163</b>	<b>0.0443</b>	<b>0.0367</b>	<b>0.0119</b>

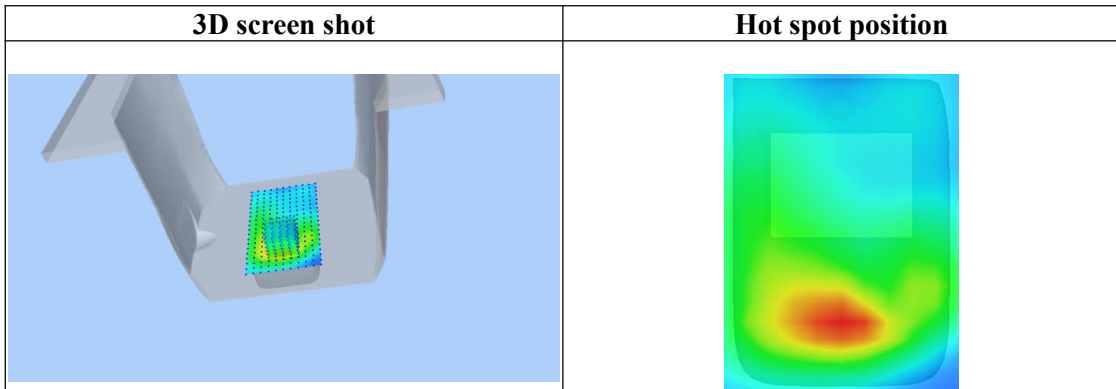
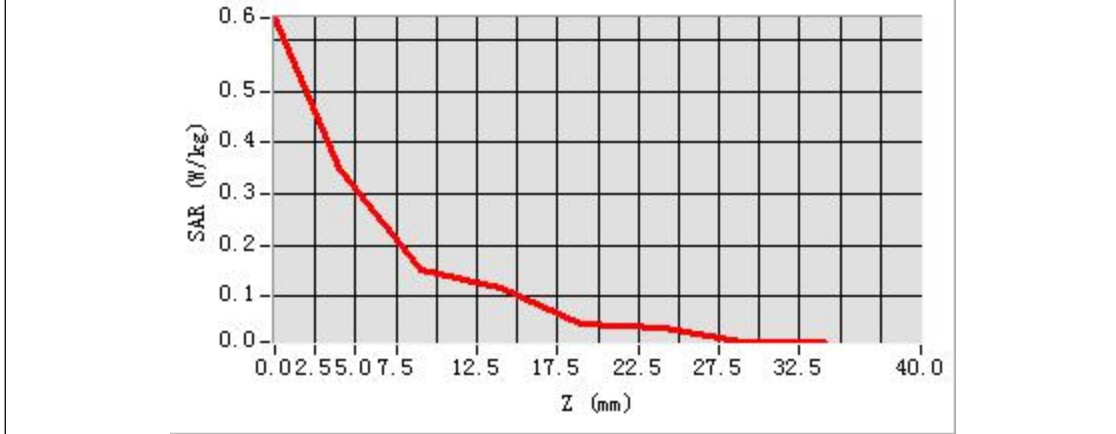

Any report having not been signed by authorized approver, or having been altered without authorization, or having not been stamped by the “Dedicated Testing/Inspection Stamp” is deemed to be invalid. Copying or excerpting portion of, or altering the content of the report is not permitted without the written authorization of AGC. The test results presented in the report apply only to the tested sample. Any objections to report issued by AGC should be submitted to AGC within 15days after the issuance of the test report. Further enquiry of validity or verification of the test report should be addressed to AGC by agc01@agccert.com.

**Test Laboratory: AGC Lab**  
**GPRS 1900 Mid-Body-Back (3up)**  
**DUT: Smartphone; Type: VORTEX HD68**

**Date: Jan. 08, 2024**

Communication System: GPRS-3Slot; Communication System Band: PCS 1900; Duty Cycle: 1:2.7; Conv.F=2.15;  
Frequency: 1880 MHz; Medium parameters used:  $f = 1900$  MHz;  $\sigma = 1.31$  mho/m;  $\epsilon_r = 40.69$ ;  $\rho = 1000$  kg/m<sup>3</sup> ;  
Phantom section: Flat Section  
Ambient temperature (°C): 20.9, Liquid temperature (°C): 20.4

**SATIMO Configuration:**

- Probe: SSE2; Calibrated: May 31, 2023; Serial No.: 2023-EPGO-414
- Sensor-Surface: 4mm (Mechanical Surface Detection)
- Phantom: SAM twin phantom
- Measurement SW: OpenSAR V4\_02\_35

**Configuration/GPRS1900 Mid-Body-Back/Area Scan:** Measurement grid: dx=8mm, dy=8mm  
**Configuration/GPRS1900 Mid-Body-Back/Zoom Scan:** Measurement grid: dx=8mm,dy=8mm, dz=5mm;

<b>Area Scan</b>	surf_sam_plan.txt, h= 5.00 mm
<b>Zoom Scan</b>	5x5x7,dx=8mm dy=8mm dz=5mm,Complete
<b>Phantom</b>	Validation plane
<b>Device Position</b>	Body Back
<b>Band</b>	PCS 1900
<b>Channels</b>	Middle
<b>Signal</b>	TDMA (Crest factor: 2.7)

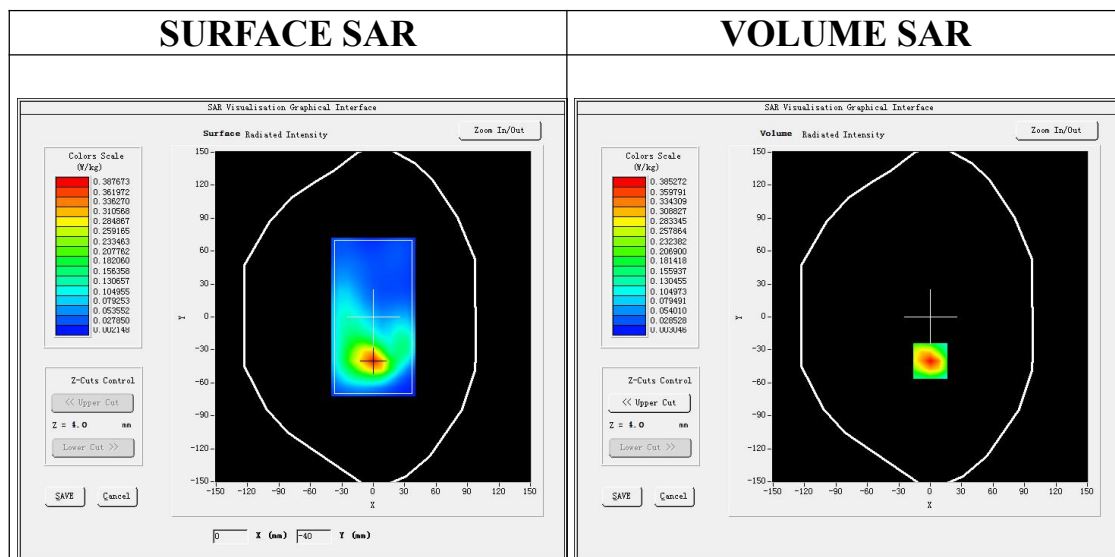

**Maximum location: X=0.00, Y=-40.00**  
**SAR Peak: 0.61 W/kg**

<b>SAR 10g (W/Kg)</b>	0.187246
<b>SAR 1g (W/Kg)</b>	0.360691

Any report having not been signed by authorized approver, or having been altered without authorization, or having not been stamped by the “Dedicated Testing/Inspection Stamp” is deemed to be invalid. Copying or excerpting portion of, or altering the content of the report is not permitted without the written authorization of AGC. The test results presented in the report apply only to the tested sample. Any objections to report issued by AGC should be submitted to AGC within 15days after the issuance of the test report. Further enquiry of validity or verification of the test report should be addressed to AGC by agc01@agccert.com.



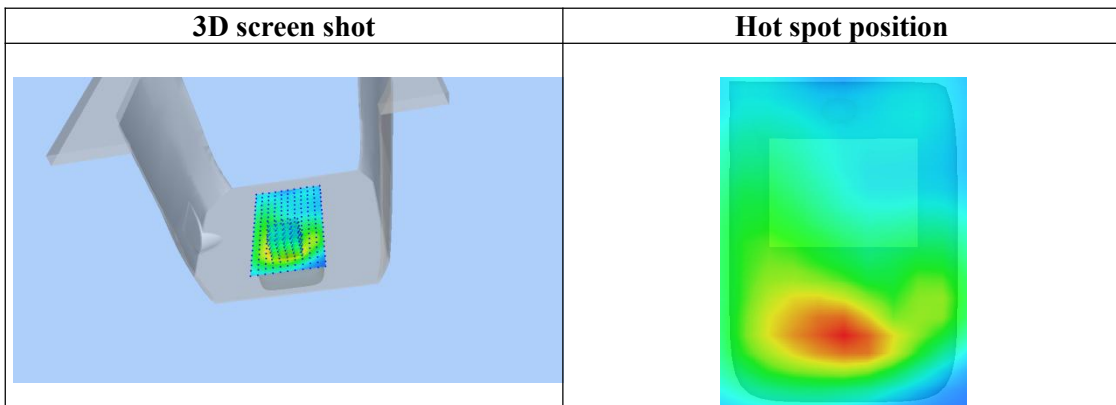
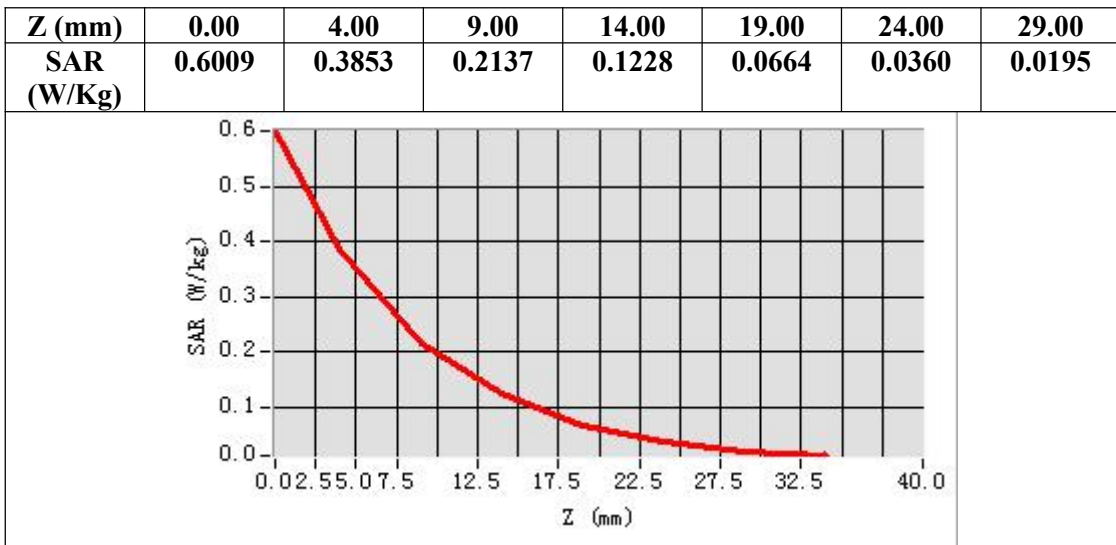

Any report having not been signed by authorized approver, or having been altered without authorization, or having not been stamped by the “Dedicated Testing/Inspection Stamp” is deemed to be invalid. Copying or excerpting portion of, or altering the content of the report is not permitted without the written authorization of AGC. The test results presented in the report apply only to the tested sample. Any objections to report issued by AGC should be submitted to AGC within 15days after the issuance of the test report. Further enquiry of validity or verification of the test report should be addressed to AGC by agc01@agccert.com.

**Test Laboratory: AGC Lab**  
**WCDMA Band II Mid-Touch-Right (RMC)**  
**DUT: Smartphone; Type: VORTEX HD68**

**Date: Jan. 08, 2024**

Communication System: UMTS; Communication System Band: Band II UTRA/FDD ;Duty Cycle:1:1; Conv.F=2.15;  
Frequency: 1880 MHz; Medium parameters used:  $f = 1900$  MHz;  $\sigma = 1.31$  mho/m;  $\epsilon_r = 40.69$ ;  $\rho = 1000$  kg/m<sup>3</sup> ;  
Phantom section: Right Section  
Ambient temperature (°C): 20.9, Liquid temperature (°C): 20.4

**SATIMO Configuration:**

- Probe: SSE2; Calibrated: May 31, 2023; Serial No.: 2023-EPGO-414
- Sensor-Surface: 4mm (Mechanical Surface Detection)
- Phantom: SAM twin phantom
- Measurement SW: OpenSAR V4\_02\_35

**Configuration/WCDMA band II Mid-Touch-Right/Area Scan:** Measurement grid: dx=8mm, dy=8mm  
**Configuration/WCDMA band II Mid-Touch-Right/Zoom Scan:** Measurement grid: dx=8mm,dy=8mm, dz=5mm;

<b>Area Scan</b>	dx=8mm dy=8mm, h= 5.00 mm
<b>ZoomScan</b>	5x5x7,dx=8mm dy=8mm dz=5mm,Complete
<b>Phantom</b>	Right head
<b>Device Position</b>	Cheek
<b>Band</b>	WCDMA band II
<b>Channels</b>	Middle
<b>Signal</b>	CDMA (Crest factor: 1.0)

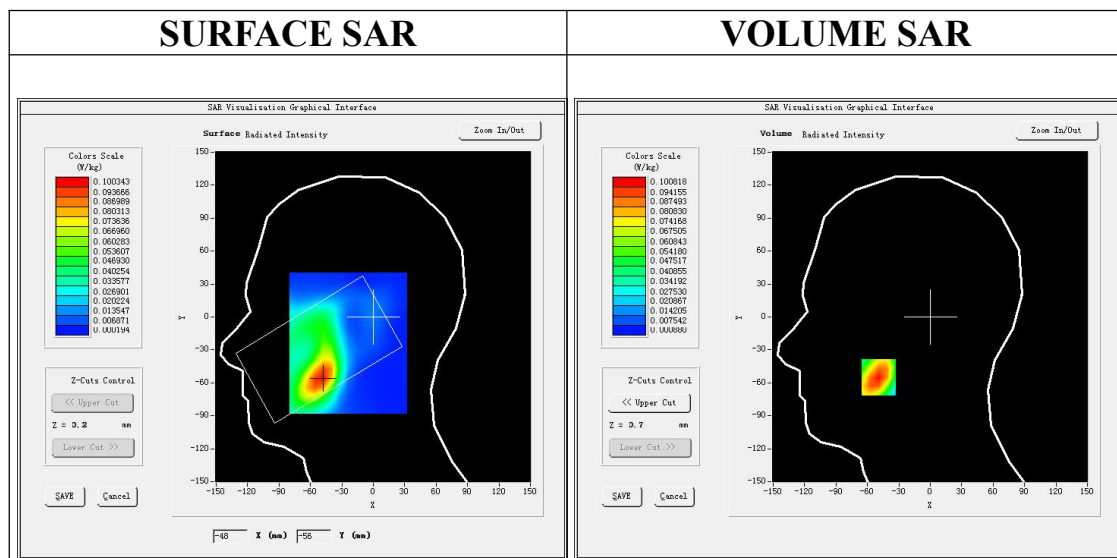

**Maximum location: X=-49.00, Y=-55.00**  
**SAR Peak: 0.15 W/kg**

<b>SAR 10g (W/Kg)</b>	0.054463
<b>SAR 1g (W/Kg)</b>	0.096401

Any report having not been signed by authorized approver, or having been altered without authorization, or having not been stamped by the “Dedicated Testing/Inspection Stamp” is deemed to be invalid. Copying or excerpting portion of, or altering the content of the report is not permitted without the written authorization of AGC. The test results presented in the report apply only to the tested sample. Any objections to report issued by AGC should be submitted to AGC within 15days after the issuance of the test report. Further enquiry of validity or verification of the test report should be addressed to AGC by agc01@agccert.com.

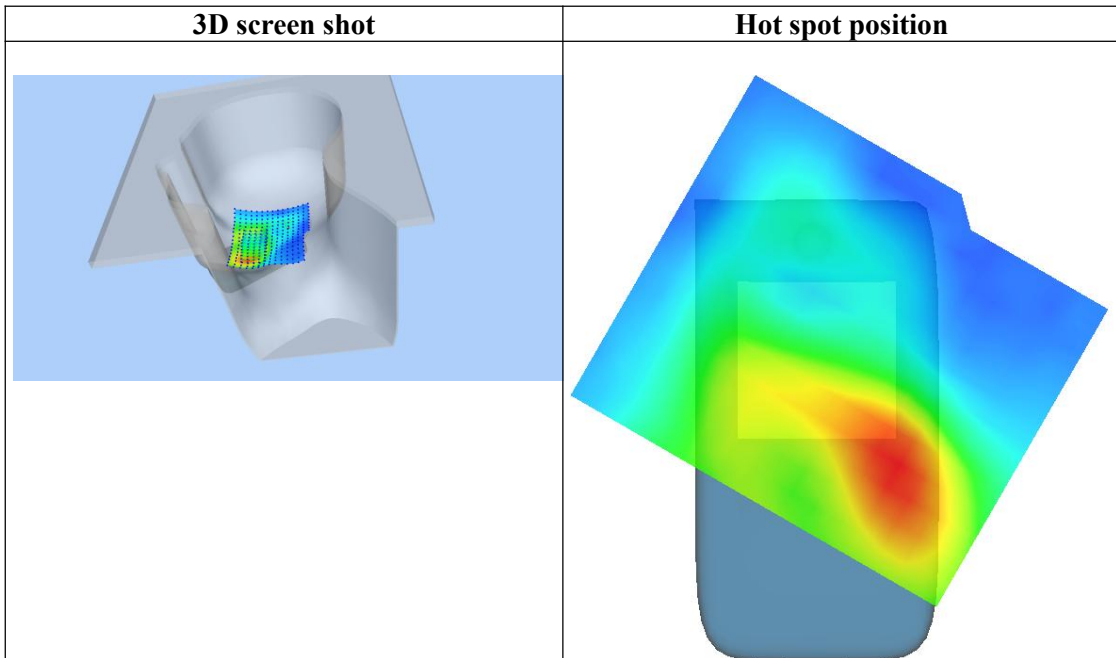
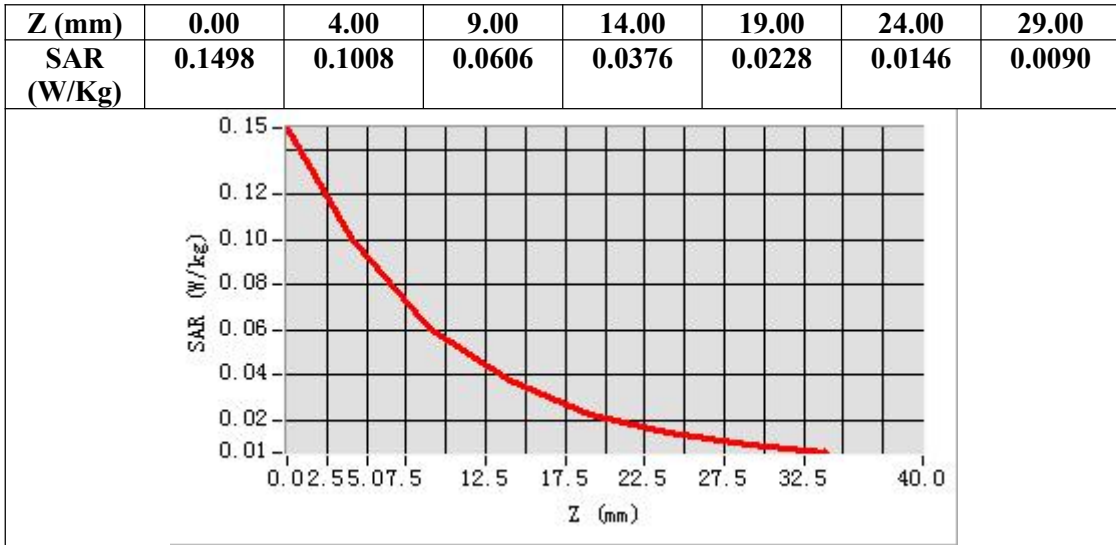

Any report having not been signed by authorized approver, or having been altered without authorization, or having not been stamped by the "Dedicated Testing/Inspection Stamp" is deemed to be invalid. Copying or excerpting portion of, or altering the content of the report is not permitted without the written authorization of AGC. The test results presented in the report apply only to the tested sample. Any objections to report issued by AGC should be submitted to AGC within 15days after the issuance of the test report. Further enquiry of validity or verification of the test report should be addressed to AGC by agc01@agccert.com.

**Test Laboratory: AGC Lab**  
**WCDMA Band II Mid-Body-Towards Grounds (RMC 12.2kbps)**  
**DUT: Smartphone; Type: VORTEX HD68**

**Date: Jan. 08, 2024**

Communication System: UMTS; Communication System Band: Band II UTRA/FDD ;Duty Cycle:1:1; Conv.F=2.15;  
Frequency: 1880 MHz; Medium parameters used:  $f = 1900$  MHz;  $\sigma = 1.31$  mho/m;  $\epsilon_r = 40.69$ ;  $\rho = 1000$  kg/m<sup>3</sup> ;  
Phantom section: Flat Section  
Ambient temperature (°C): 20.9, Liquid temperature (°C): 20.4

SATIMO Configuration:

- Probe: SSE2; Calibrated: May 31, 2023; Serial No.: 2023-EPGO-414
- Sensor-Surface: 4mm (Mechanical Surface Detection)
- Phantom: SAM twin phantom
- Measurement SW: OpenSAR V4\_02\_35

**Configuration/ WCDMA band II Mid-Body-Back/Area Scan:** Measurement grid: dx=8mm, dy=8mm  
**Configuration/ WCDMA band II Mid-Body-Back/Zoom Scan:** Measurement grid: dx=8mm,dy=8mm, dz=5mm;

<b>Area Scan</b>	surf_sam_plan.txt, h= 5.00 mm
<b>ZoomScan</b>	5x5x7,dx=8mm dy=8mm dz=5mm,Complete
<b>Phantom</b>	Validation plane
<b>Device Position</b>	Body Back
<b>Band</b>	WCDMA band II
<b>Channels</b>	Middle
<b>Signal</b>	CDMA (Crest factor: 1.0)

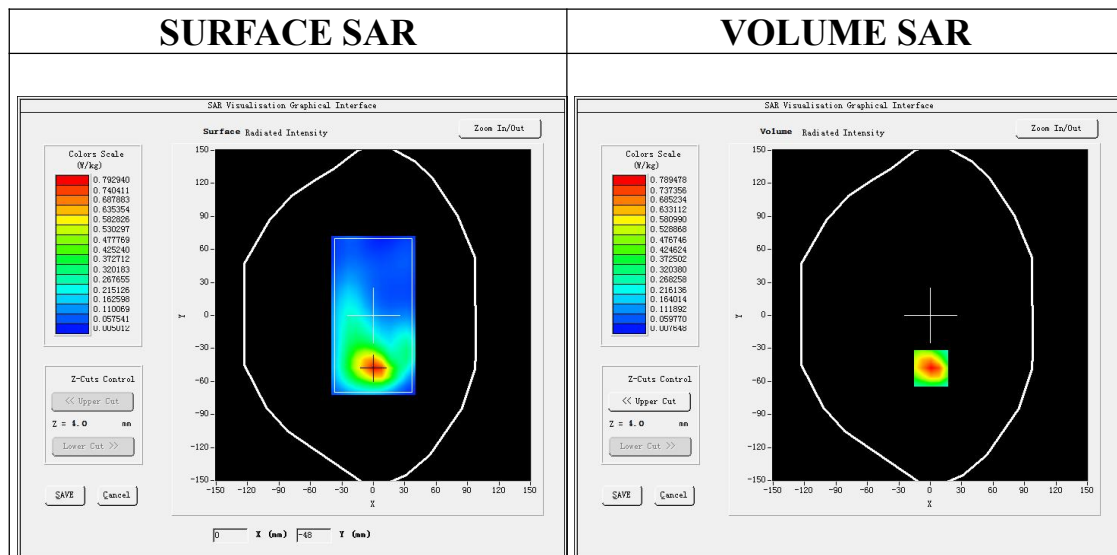

**Maximum location: X=1.00, Y=-48.00**

**SAR Peak: 1.25 W/kg**

<b>SAR 10g (W/Kg)</b>	0.391660
<b>SAR 1g (W/Kg)</b>	0.744658

Any report having not been signed by authorized approver, or having been altered without authorization, or having not been stamped by the "Dedicated Testing/Inspection Stamp" is deemed to be invalid. Copying or excerpting portion of, or altering the content of the report is not permitted without the written authorization of AGC. The test results presented in the report apply only to the tested sample. Any objections to report issued by AGC should be submitted to AGC within 15days after the issuance of the test report. Further enquiry of validity or verification of the test report should be addressed to AGC by agc01@agccert.com.

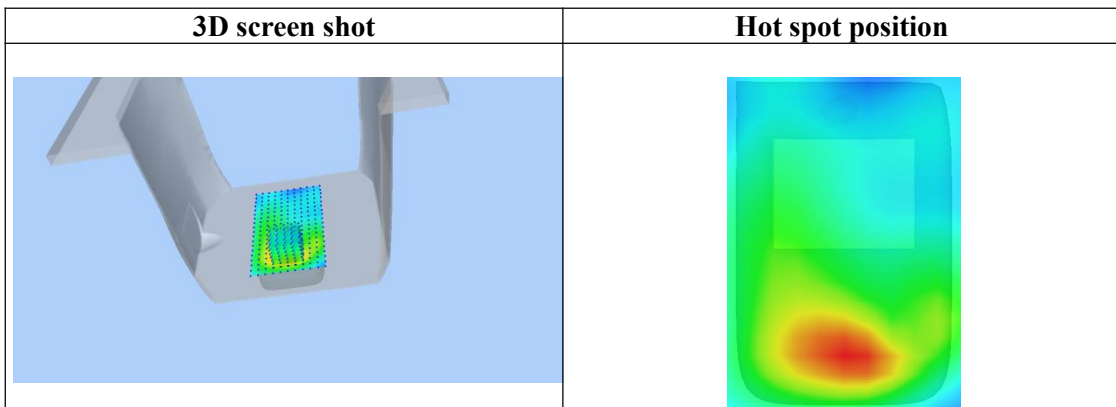
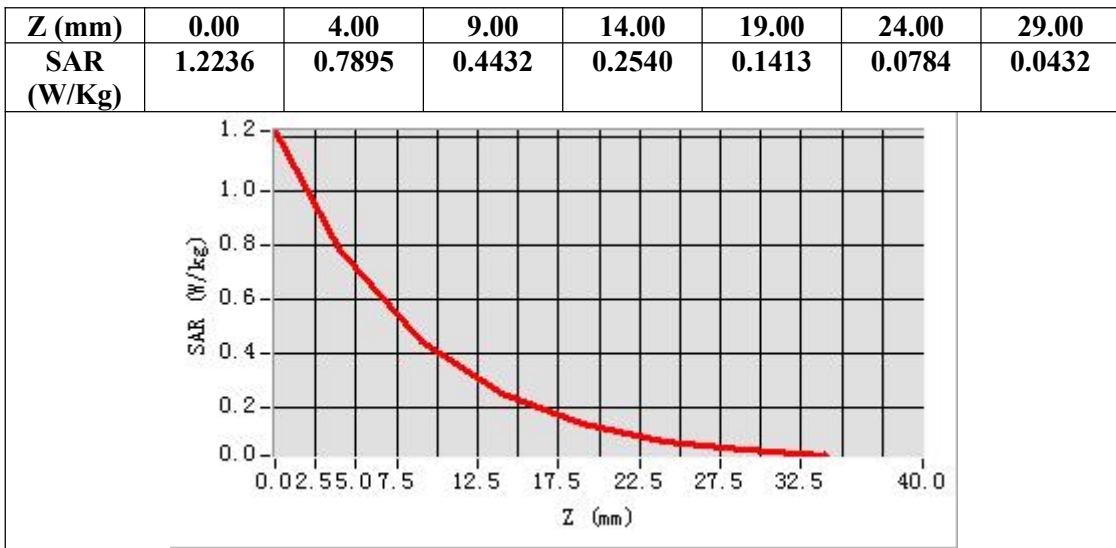

Any report having not been signed by authorized approver, or having been altered without authorization, or having not been stamped by the “Dedicated Testing/Inspection Stamp” is deemed to be invalid. Copying or excerpting portion of, or altering the content of the report is not permitted without the written authorization of AGC. The test results presented in the report apply only to the tested sample. Any objections to report issued by AGC should be submitted to AGC within 15days after the issuance of the test report. Further enquiry of validity or verification of the test report should be addressed to AGC by agc01@agccert.com.

**Test Laboratory: AGC Lab**  
**WCDMA Band IV Mid-Touch-Right (RMC)**  
**DUT: Smartphone; Type: VORTEX HD68**

**Date: Jan. 07, 2024**

Communication System: UMTS; Communication System Band: BAND IV UTRA/FDD; Duty Cycle:1: 1; Conv.F=2.17; Frequency:1732.4 MHz; Medium parameters used:  $f = 1750$  MHz;  $\sigma = 1.28$  mho/m;  $\epsilon_r = 41.39$ ;  $\rho = 1000$  kg/m<sup>3</sup>; Phantom section: Right Section  
Ambient temperature (°C): 20.9, Liquid temperature (°C): 20.6

**SATIMO Configuration:**

- Probe: SSE2; Calibrated: May 31, 2023; Serial No.: 2023-EPGO-414
- Sensor-Surface: 4mm (Mechanical Surface Detection)
- Phantom: SAM twin phantom
- Measurement SW: OpenSAR V4\_02\_35

**Configuration/ WCDMA Band IV Mid-Touch-Right/Area Scan:** Measurement grid: dx=8mm, dy=8mm  
**Configuration/ WCDMA Band IV Mid-Touch-Right/Zoom Scan:** Measurement grid: dx=8mm, dy=8mm, dz=5mm

<b>Area Scan</b>	dx=8mm dy=8mm, h= 5.00 mm
<b>ZoomScan</b>	5x5x7,dx=8mm dy=8mm dz=5mm,Complete
<b>Phantom</b>	Right head
<b>Device Position</b>	Cheek
<b>Band</b>	WCDMA Band IV
<b>Channels</b>	Middle
<b>Signal</b>	CDMA (Crest factor: 1.0)

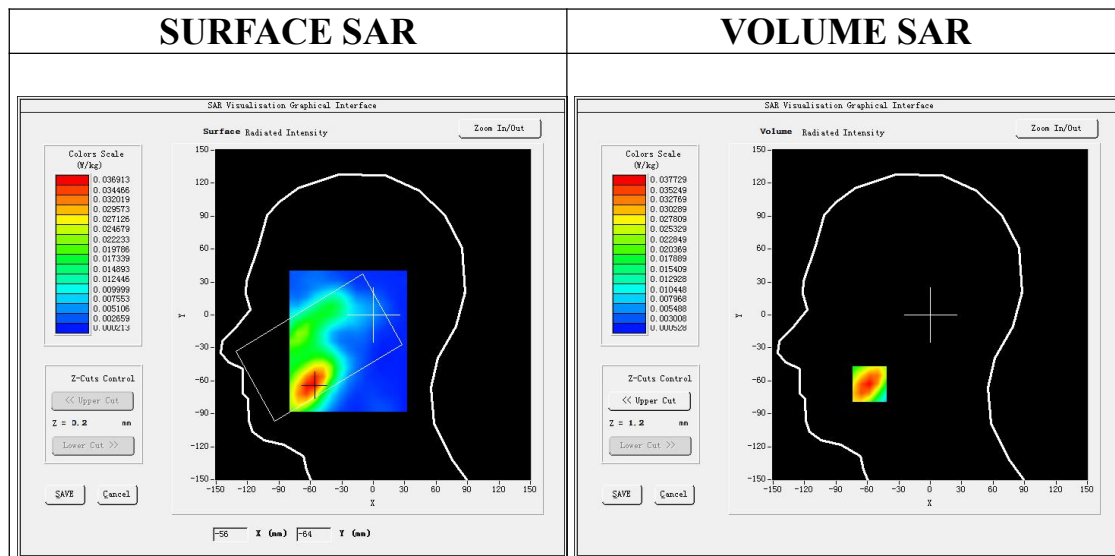

**Maximum location: X=-58.00, Y=-63.00**  
**SAR Peak: 0.06 W/kg**

<b>SAR 10g (W/Kg)</b>	0.020525
<b>SAR 1g (W/Kg)</b>	0.036026

Any report having not been signed by authorized approver, or having been altered without authorization, or having not been stamped by the "Dedicated Testing/Inspection Stamp" is deemed to be invalid. Copying or excerpting portion of, or altering the content of the report is not permitted without the written authorization of AGC. The test results presented in the report apply only to the tested sample. Any objections to report issued by AGC should be submitted to AGC within 15days after the issuance of the test report. Further enquiry of validity or verification of the test report should be addressed to AGC by agc01@agccert.com.

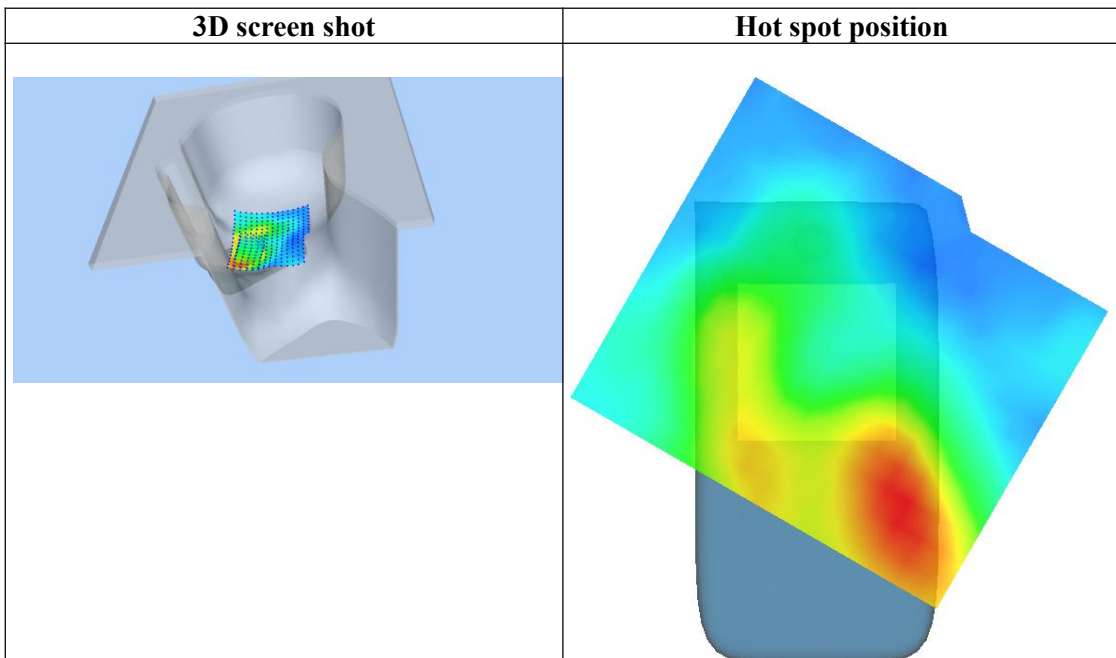
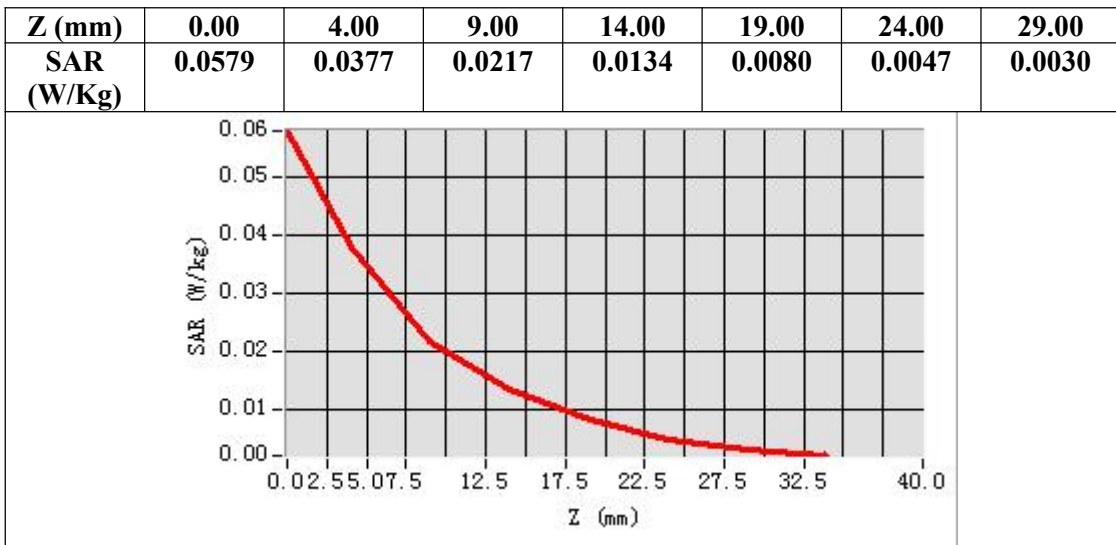

Any report having not been signed by authorized approver, or having been altered without authorization, or having not been stamped by the “Dedicated Testing/Inspection Stamp” is deemed to be invalid. Copying or excerpting portion of, or altering the content of the report is not permitted without the written authorization of AGC. The test results presented in the report apply only to the tested sample. Any objections to report issued by AGC should be submitted to AGC within 15days after the issuance of the test report. Further enquiry of validity or verification of the test report should be addressed to AGC by agc01@agccert.com.

**Test Laboratory: AGC Lab**  
**WCDMA Band IV Mid-Body-Towards Grounds (RMC)**  
**DUT: Smartphone; Type: VORTEX HD68**

**Date: Jan. 07, 2024**

Communication System: UMTS; Communication System Band: BAND IV UTRA/FDD; Duty Cycle:1: 1; Conv.F=2.17;  
Frequency:1732.4 MHz; Medium parameters used:  $f = 1750$  MHz;  $\sigma = 1.28$  mho/m;  $\epsilon_r = 41.39$ ;  $\rho = 1000$  kg/m<sup>3</sup>;  
Phantom section: Flat Section  
Ambient temperature (°C): 20.9, Liquid temperature (°C): 20.6

SATIMO Configuration:

- Probe: SSE2; Calibrated: May 31, 2023; Serial No.: 2023-EPGO-414
- Sensor-Surface: 4mm (Mechanical Surface Detection)
- Phantom: SAM twin phantom
- Measurement SW: OpenSAR V4\_02\_35

**Configuration/ WCDMA Band IV Mid-Body-Back/Area Scan:** Measurement grid: dx=8mm, dy=8mm  
**Configuration/ WCDMA Band IV Mid-Body-Back/Zoom Scan:** Measurement grid: dx=8mm,dy=8mm, dz=5mm;

<b>Area Scan</b>	surf_sam_plan.txt, h= 5.00 mm
<b>ZoomScan</b>	5x5x7,dx=8mm dy=8mm dz=5mm,Complete
<b>Phantom</b>	Validation plane
<b>Device Position</b>	Body Back
<b>Band</b>	WCDMA Band IV
<b>Channels</b>	Middle
<b>Signal</b>	CDMA (Crest factor: 1.0)

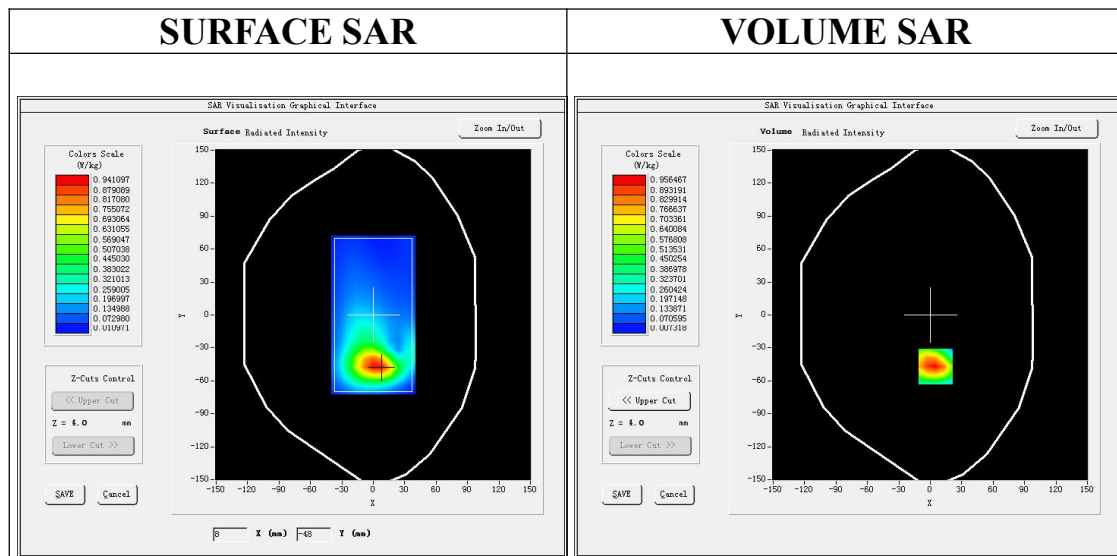

**Maximum location: X=5.00, Y=-47.00**

**SAR Peak: 1.44 W/kg**

<b>SAR 10g (W/Kg)</b>	0.493227
<b>SAR 1g (W/Kg)</b>	0.899911

Any report having not been signed by authorized approver, or having been altered without authorization, or having not been stamped by the "Dedicated Testing/Inspection Stamp" is deemed to be invalid. Copying or excerpting portion of, or altering the content of the report is not permitted without the written authorization of AGC. The test results presented in the report apply only to the tested sample. Any objections to report issued by AGC should be submitted to AGC within 15days after the issuance of the test report. Further enquiry of validity or verification of the test report should be addressed to AGC by agc01@agccert.com.