

Shenzhen 3good Wireless Technology Co., Ltd

Specification

客户 Customer	忆博通	规格型号 Specs	X63B3
三好料号 Part Number		频 段 Frequency Band	BT&2.5G WIFI:2400~2483.5MHZ 5G WIFI:5100~5800MHZ GSM850/900/1800/1900 WCDMA 2/4/5 LTE B2/4/5/12/13/25/26/41/66/71
颜 色 Color	black	版 本 Edition	
销 售 Salesperson		设 计 Design	官炳坤
结 构 Structure	李富伦	确 认 Confirm	周武
日 期 Date		签字日期 Signing Date	

客户确认 Customer confirmation:

Join hands to create the future

Shenzhen Sanhao Wireless Communication Co., Ltd

501-508, Jinfulai Building, No. 49-1 Dabao Road, Bao'an District, Shenzhen

目录

一、产品规格(Product specification)	3
二、电器性能(Electrical performance)	3
1.规格标准(Specification standard)	3
2.天线的匹配电路(Matching circuit)	3
三、参数的测试(Parameter test)	4
1.测试的设置(Test settings)	4
2.测试结果(Test result)	4
四、有源测试的设置(Active test setup)	5
1.测试的场地(Test site)	5
2.测试结果(Test result)	5
3.环境处理 Environmental treatment	5

一、Product specifications

The report mainly provides parameter tests of X63B3 antenna performance. X63B3 antenna is 4G antenna. (As shown in the figure below)

Three in one antenna

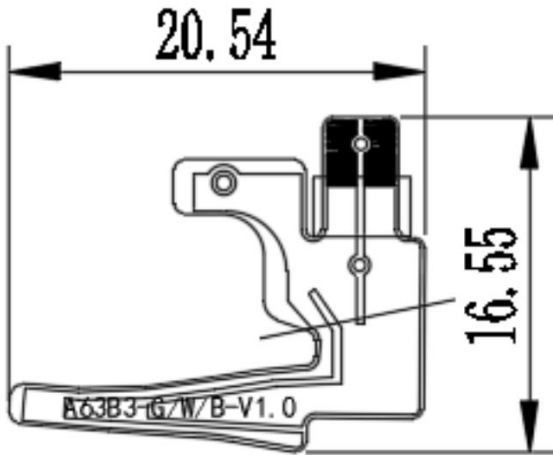

Diversity antenna

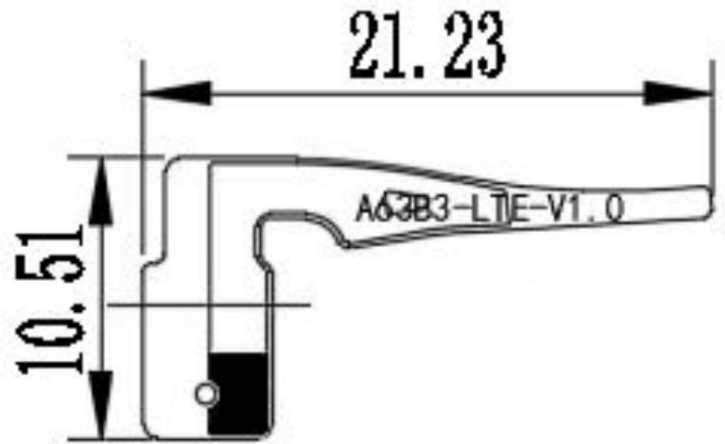

Main set antenna

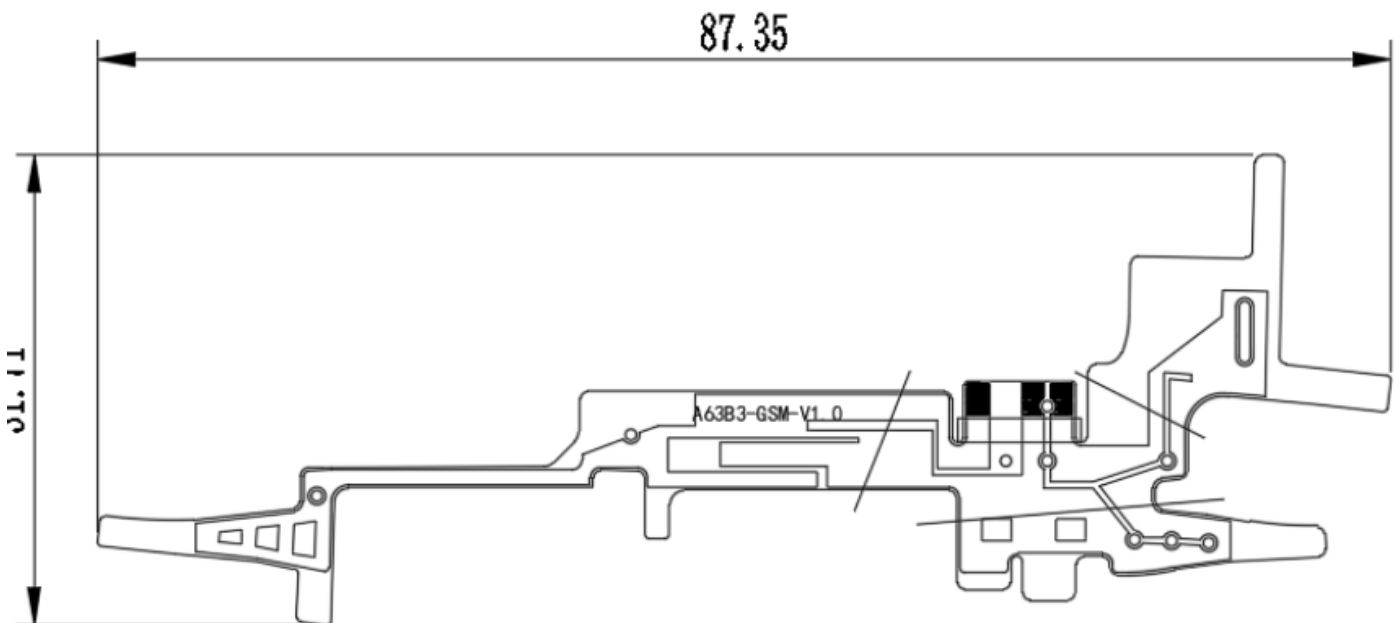

二、Electrical performance

1.Specifications

The operating frequency band of X63B3 antenna is 699~960MHZ and 1710~2700MHZ, in which resonance occurs.

2. Matching circuit of antenna

Matching circuits (匹配电路)

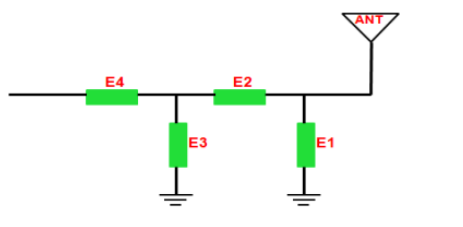

Main Antenna	
Element	Value
E1(C113)	15nH
E2(R112)	1.5nH
E3(C114)	NC
E4(R111)	0Ω



主天线开关逻辑

RF1(R1612): 0Ω,
频段是: GSM900/PCS1900+W2/4+LTE B2/4/7/25/41/66
RF2(R1613): 4.7nH,
频段是: GSM850/DCS1800+W5+LTE B5/26
RF3(R1616): 18nH
频段是: LTE B12/B13
RF4(R1614): 33nH,
频段是: LTE B71

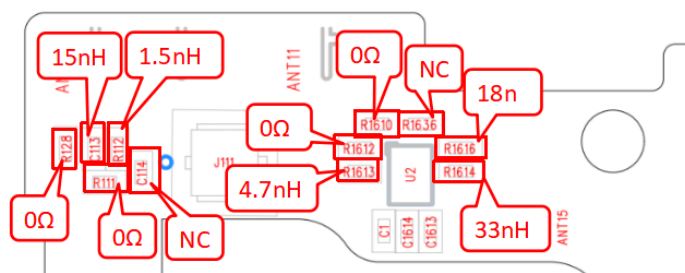

Structure of antenna: FPC

三、Test of parameters

1. Test settings

The connection of VSWR test device is:

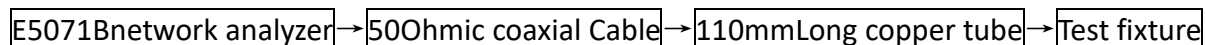

Treatment of test fixture:

Use a hard cable to lead out the SMA-J connector from the 50 ohm test point of the antenna on the mobile phone PCB, connect it to the copper tube with a choke, and then connect other devices in turn.

Passive parameters of main antenna:

工作频段(Working frequency band): 699~960MHZ, 1710~2700MHZ

GSM850/900/1800/1900

WCDMA1/2/4/5

LTE B2/4/5/12/17/25/26/41/66/71

Gain			
频段 Band	gain 增益 (dBi)	频段 Band	gain 增益(dBi)
GSM850,WCDMA-B5,LTE-B5/B26	-2.6	PCS1900,WCDMA-B2,LTE-B1/B2/B25	0.16
GSM900	-0.17	LTE-B41	0.39
DCS1800,WCDMA-B4,LTE-B4/B66	0.39	LTE-B12/B13/B17	-2.98
LTE-B71	-3.25		

600

700

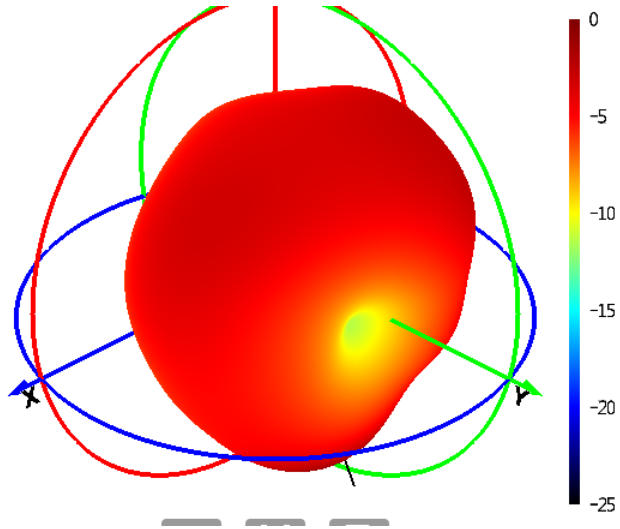
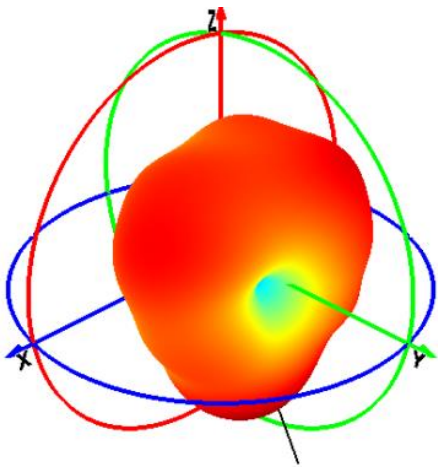

800

900

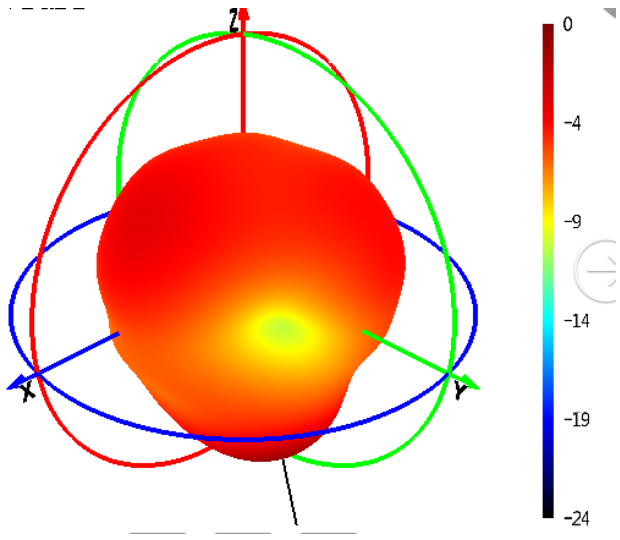

1700

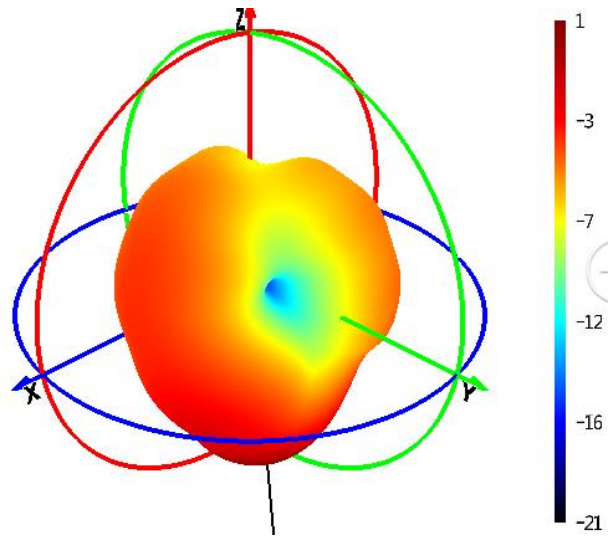

1900

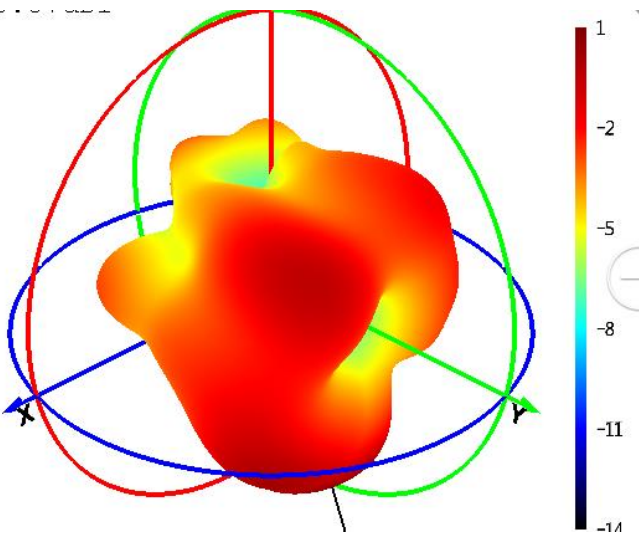

2300

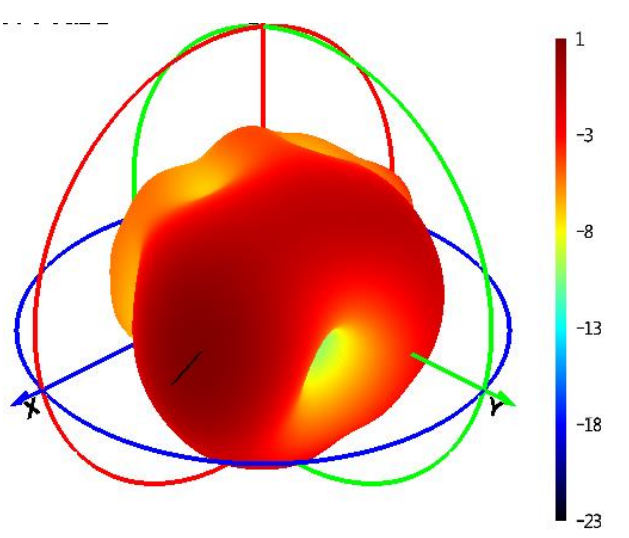

2400

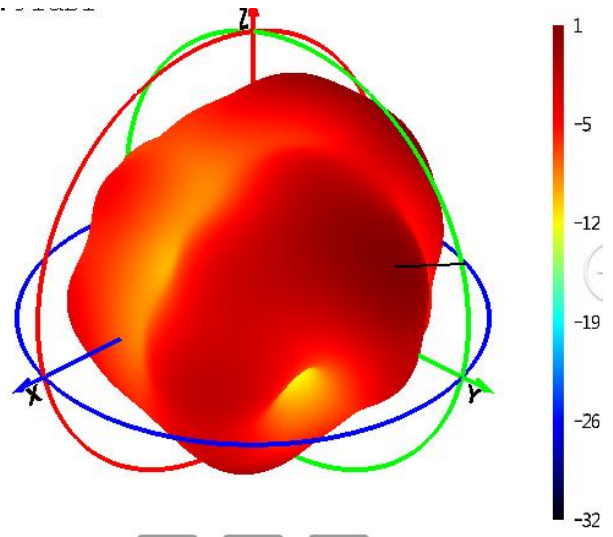
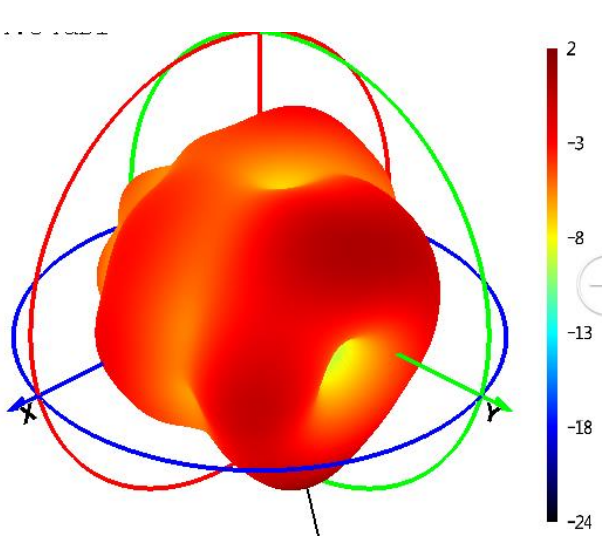

2700

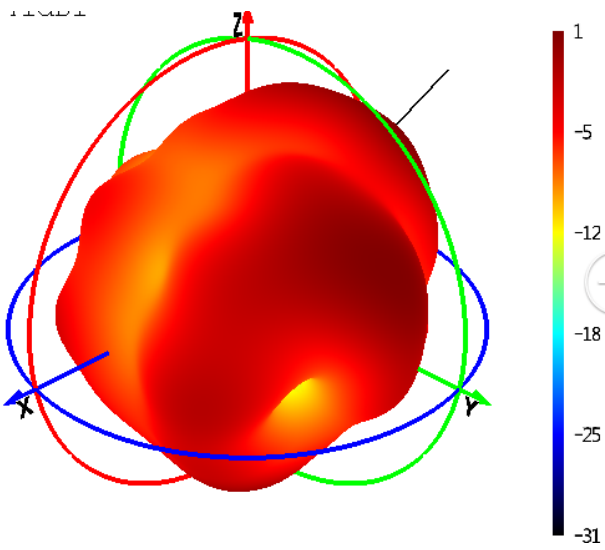

GPS/WIFI/BTPassive parameters of antenna:

工作频段(Working frequency band): 1560~1580MHZ, 2400~2500MHZ,5180~8525MHZ

Gain			
频段 Band	gain 增益 (dBi)	频段 Band	gain 增益 (dBi)
GPS	1.06	2.4G WIFI/BT	-0.18
5G WIFI	-0.18		

GPS

2.4G WIFI/BT

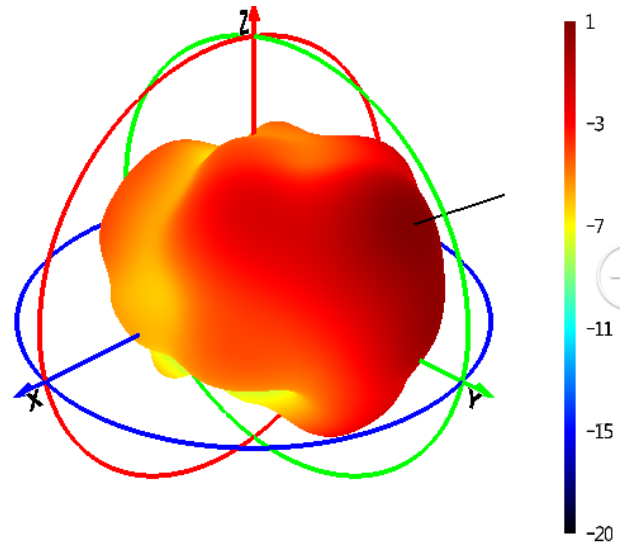
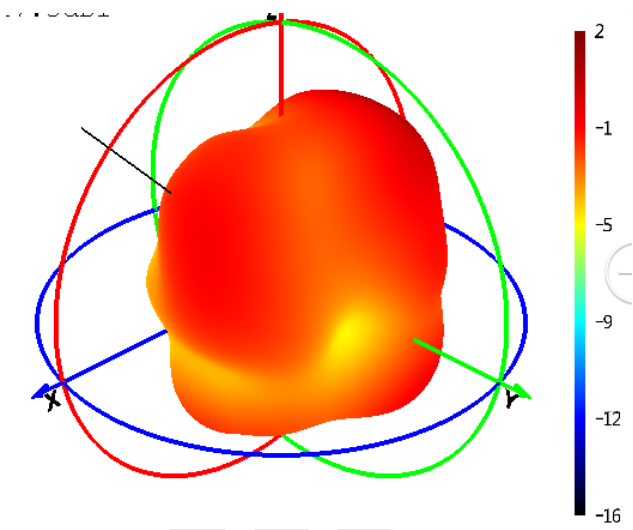

5G WIFI

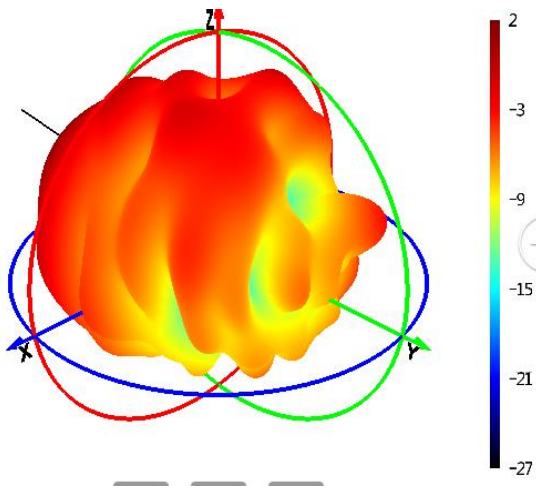

2.test result

business as usual.

四、 Active test setup

The active test devices are sequentially connected as follows:

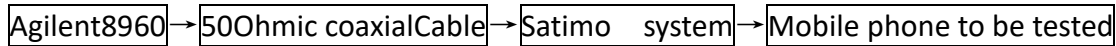

1.Test site

microwave anechoic chamber: the test frequency range is 400MHz - 6GHz, the quiet zone range is 40cm circumference, and the reflectivity is less than - 90 dB.

2.test result

The maximum radiation power and maximum receiving sensitivity reflect the maximum power radiation value and the optimal receiving performance of the antenna in the entire radiation space. TRP and TIS reflect the average radiation power and average receiving sensitivity of the antenna, that is, the overall receiving performance of the antenna.

The following is the active test result of X63B3 mobile phone main antenna:

Test data (测试数据)

	CH	TRP	TIS
GSM850	128	21.33	
	190	21.73	
	251	22.36	-102.61
EGSM900	1	26.04	
	62	26.28	
	124	26.1	-100.33
DCS1800	512	22.39	
	698	22.3	
	885	22.75	-103.66
PCS1900	512	24.04	
	661	24.09	
	810	24.45	-102.52
W2	9626	18.47	
	9400	18.59	
	9538	18.48	-103.41
W4	1312	16.09	
	1413	16.23	
	1513	16.33	-103.4
W5	4132	16.5	
	4183	16.01	
	4233	15.7	-103.28

	CH	TRP	TIS
B2	18650	18.19	
	18900	18.45	
	19150	19.09	-93.48
B4	20000	15.37	
	20175	16.11	
	20300	16.46	-91.39
B5	20450	16.06	
	20525	16.1	
	20600	15.15	-92.63
B12	23035	14.57	
	23095	15.36	
	23155	15.57	-94.9
B13	23230	14.52	-91.87
B25	26065	18.13	
	26365	18.43	
	26665	19.04	-92.48
B26	26715	16.5	
	26865	16.24	
	27015	15.32	-93.94
B66	132022	15.94	
	132322	16.41	
	132622	16.38	-91.14
B71	133172	15.24	
	133297	15.72	
	133422	16.09	-88.27
B41	40340	19.03	
	40620	20.99	
	41140	17.69	-89.36

2-1.Three in one test results

GPS/WIFI Field test (GPS/WIFI场测)



2-2. 蓝牙测试 (Bluetooth Test) :

10 meters online listening to music, making calls smoothly without interruption

3.Environmental treatment

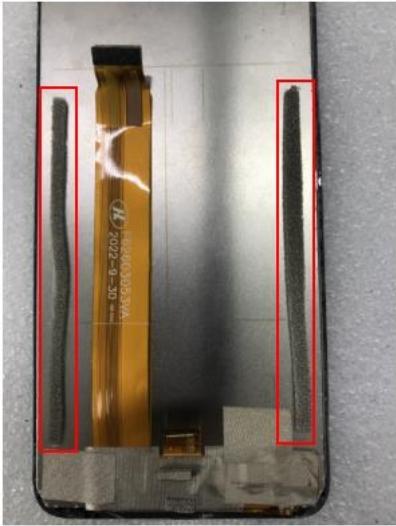

屏幕增加导电泡棉与中框金属相接，此处泡棉需要使用低内阻的，原有泡棉内阻太高，需要更换



屏幕排线贴导电布做接地处理，导电布面积需要超过屏幕排线贴在屏幕的铁框处。导电布也需要采用内阻低的

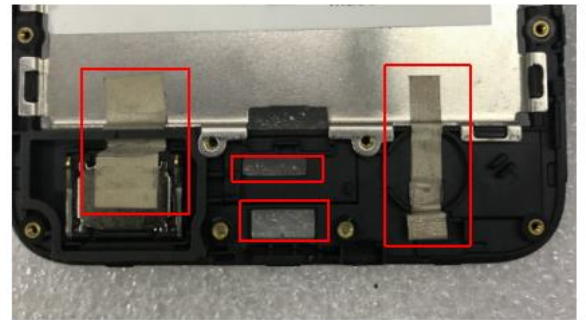

喇叭贴导电布做接地处理，马达处也需要从铁框处引一条导电布出来与小板做接地处理，屏幕排线处增加海绵与小板做接地处理，导电布与海绵也需要采用内阻低的

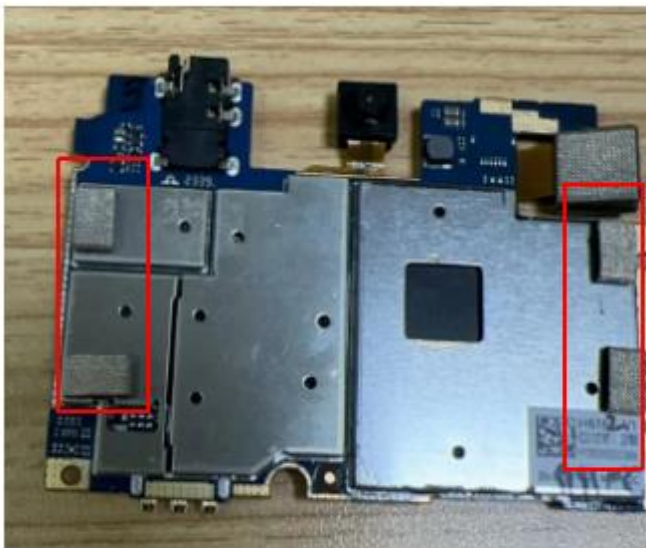

主板做接地处理，海绵需要采用内阻低的