



HAC Receive Volume Control Test Report

For

Applicant Name: Xwireless LLC
Address: 11565 Old Georgetown Road, Rockville, MD, USA
EUT Name: Mobile Phone
Brand Name: Vortex
Model Number: HD67

Issued By

Company Name: BTF Testing Lab (Shenzhen) Co., Ltd.
Address: F101, 201 and 301, Building 1, Block 2, Tantou Industrial Park,
Tantou Community, Songgang Street, Bao'an District, Shenzhen,
China

Report Number: BTF231220R00503
Test Standards: ANSI C63.19:2019 FCC 47 CFR §20.19 TIA-5050:2018
FCC ID: 2ADLJ-HD67

Test Conclusion: Pass
Test Date: 2024-01-30 to 2024-02-01
Date of Issue: 2024-02-02

Prepared By: Zoey Zhang
Zoey Zhang / Project Engineer

Date: 2024-02-02

Approved By: Ryan.CJ
Ryan.CJ / EMC Manager

Date: 2024-02-02



Note: All the test results in this report only related to the testing samples. Which can be duplicated completely for the legal use with approval of applicant; it shall not be reproduced except in full without the written approval of BTF Testing Lab (Shenzhen) Co., Ltd., All the objections should be raised within thirty days from the date of issue. To validate the report, you can contact us.

Revision History		
Version	Issue Date	Revisions Content
Rev_V0	2024-02-02	Original
<i>Note:</i>	<i>Once the revision has been made, then previous versions reports are replaced by the latest version.</i>	

Table of Contents

1. Introduction	4
1.1 Identification of Testing Laboratory	4
1.2 Identification of the Responsible Testing Location	4
1.3 Laboratory Condition	4
1.4 Announcement	4
2. Product Information	5
2.1 Application Information	5
2.2 Manufacturer Information	5
2.3 Factory Information	5
2.4 General Description of Equipment under Test (EUT)	5
2.5 Equipment under Test Ancillary Equipment	6
2.6 Technical Information	6
3. Summary of Test Results	7
3.1 Test Standards	7
3.2 Air Interfaces / Bands Indicating Operating Modes	7
4. Test Uncertainty	8
5. Measurement System	9
5.1 MEASUREMENT SET-UP	9
6. Evaluation of Test	10
6.1 RECEIVE VOLUME CONTROL PERFORMANCE	10
6.2 RECEIVE DISTORTION AND NOISE PERFORMANCE	11
6.3 RECEIVE ACOUSTIC FREQUENCY RESPONSE PERFORMANCE	12
7. Test Equipment List	14
8. Air Interfaces / Bands used for testing	14
9. Test Result	15
9.1 Receive volume control, distortion and noise performance	15
9.2 Receive acoustic frequency response performance	16
10. EUT photograph	18
ANNEX A Test Data	19
1.1 Receive Volume Control Performance 8N NB	19
1.2 Receive Volume Control Performance 2N NB	19
1.3 Receive Distortion and Noise 8N NB	20
1.4 Receive Distortion and Noise 2N NB	22
1.5 Receive Frequency Response	25
ANNEX C CALIBRATION REPORT	26

1. Introduction

1.1 Identification of Testing Laboratory

Company Name:	BTF Testing Lab (Shenzhen) Co., Ltd.
Address:	F101, 201 and 301, Building 1, Block 2, Tantou Industrial Park, Tantou Community, Songgang Street, Bao'an District, Shenzhen, China
Phone Number:	+86-0755-23146130
Fax Number:	+86-0755-23146130

1.2 Identification of the Responsible Testing Location

Test Location:	BTF Testing Lab (Shenzhen) Co., Ltd.
Address:	F101, 201 and 301, Building 1, Block 2, Tantou Industrial Park, Tantou Community, Songgang Street, Bao'an District, Shenzhen, China
Description:	All measurement facilities used to collect the measurement data are located at F101, 201 and 301, Building 1, Block 2, Tantou Industrial Park, Tantou Community, Songgang Street, Bao'an District, Shenzhen, China

1.3 Laboratory Condition

Ambient Temperature:	18°C to 25°C
Ambient Relative Humidity:	32% to 49%
Ambient Pressure:	100 kPa to 102 kPa

1.4 Announcement

- (1) The test report reference to the report template version v0.
- (2) The test report is invalid if not marked with the signatures of the persons responsible for preparing, reviewing and approving the test report.
- (3) The test report is invalid if there is any evidence and/or falsification.
- (4) This document may not be altered or revised in any way unless done so by BTF and all revisions are duly noted in the revisions section.
- (5) Content of the test report, in part or in full, cannot be used for publicity and/or promotional purposes without prior written approval from the laboratory.
- (6) The laboratory is only responsible for the data released by the laboratory, except for the part provided by the applicant.

2. Product Information

2.1 Application Information

Company Name:	Xwireless LLC
Address:	11565 Old Georgetown Road, Rockville, MD, USA

2.2 Manufacturer Information

Company Name:	Xwireless LLC
Address:	11565 Old Georgetown Road, Rockville, MD, USA

2.3 Factory Information

Company Name:	ZTECH COMMUNICATION(SZ) CO LTD
Address:	FL 7 BLOCK D BAO' AN ZHIGU INNOVATION PARK YIN' TIAN ROAD NO. 4 XI' XIANG STR' BAO' AN DISTRICT SZ CHINA

2.4 General Description of Equipment under Test (EUT)

EUT Name	Mobile Phone
Under Test Model Name	HD67
Series Model Name	N/A
Description of Model name differentiation	N/A
Hardware Version	N/A
Software and Firmware Version	N/A
Dimensions (Approx.)	170*78*8.0mm
Weight (Approx.)	184g

2.5 Equipment under Test Ancillary Equipment

Ancillary Equipment 1	Battery	
	Brand Name	Vortex
	Model No.	HD67
	Serial No.	N/A
	Capacity	Typical capacity: 4000mAh
	Rated Voltage	3.85 V

2.6 Technical Information

Network and Wireless connectivity	2G Network GSM/GPRS 850/1900 3G Network WCDMA/HSDPA/HSUPA Band 2/5 4G Network FDD LTE Band 2/4/5/12/13/25/26/66/71 TDD LTE Band 41 2.4G WIFI 802.11b, 802.11g, 802.11n(HT20/40) 5G WIFI 802.11a, 802.11n(HT20/40), 802.11ac(VHT20/40/80) BT (EDR+BLE)
-----------------------------------	--

3. Summary of Test Results

3.1 Test Standards

No.	Identity	Document Title
1	ANSI C63.19-2019	American National Standard for Methods of Measurement of Compatibility between Wireless Communication Devices and Hearing Aids
2	FCC 47 CFR §20.19	Hearing Aid Compatible Mobile Headsets
3	TIA-5050:2018	Telecommunications Communications Products Receive Volume Control Requirements for Wireless (Mobile) Devices

3.2 Air Interfaces / Bands Indicating Operating Modes

Air Interface	Band	Type	Simultaneous Transmitter	Name of Service
GSM	850	VO	WLAN & BT	CMRS Voice
	1900	VO	WLAN & BT	CMRS Voice
	GPRS/EGPRS	DT	N/A	N/A
WCDMA	Band II	VO	WLAN & BT	CMRS Voice
	Band IV	VO	WLAN & BT	CMRS Voice
	Band V	VO	WLAN & BT	CMRS Voice
	HSPA	DT	N/A	N/A
LTE	Band 2	VD	WLAN & BT	VoLTE
	Band 4	VD	WLAN & BT	VoLTE
	Band 5	VD	WLAN & BT	VoLTE
	Band 12	VD	WLAN & BT	VoLTE
	Band 13	VD	WLAN & BT	VoLTE
	Band 25	VD	WLAN & BT	VoLTE
	Band 26	VD	WLAN & BT	VoLTE
	Band 41	VD	WLAN & BT	VoLTE
	Band 66	VD	WLAN & BT	VoLTE
	Band 71	VD	WLAN & BT	VoLTE
WLAN	2.4g & 5g	DT	WWAN	N/A
BT	2450	DT	WWAN	N/A

NA: Not Applicable
 VO: Voice Only
 VD: CMRS and IP Voice Service over Digital Transport
 DT: Digital Transport Only

* HAC Rating was not based on concurrent voice and data modes; Noncurrent mode was found to represent worst case rating for both M and T rating.

4. Test Uncertainty

UNCERTAINTY EVALUATION FOR AUDIO HAC MEASUREMENT					
Uncertainty Component	Tol (+- %)	Prob. Dist.	Div.	Uncertainty (dB)	Uncertainty (%)
Measurement System					
RF reflections	0.1	R	$\sqrt{3}$	0.06	
Acoustic noise	0.1	R	$\sqrt{3}$	0.06	
Probe coil sensitivity	0.49	R	$\sqrt{3}$	0.28	
Reference signal level	0.25	R	$\sqrt{3}$	0.14	
Positioning accuracy	0.4	R	$\sqrt{3}$	0.23	
Cable loss	0.1	N	2	0.05	
Frequency analyzer	0.15	R	$\sqrt{3}$	0.09	
System repeatability	0.2	N	1	0.20	
Repeatability of the WD	0.4	N	1	0.40	
Combined Standard Uncertainty		N	1	0.61	
Expanded uncertainty (confidence level of 95%, k = 2)		N	K=2	1.22	15.05
REPORTED Expanded uncertainty (confidence level of 95%, k = 2)		N	K=2	1.20	15.00

5. Measurement System

5.1 MEASUREMENT SET-UP

The general test arrangement is shown in Figure 1. The Call Box passes the voice channel stream to the DUT without modification. There is no gain or loss in the voice channel stream due to the Call Box interface.

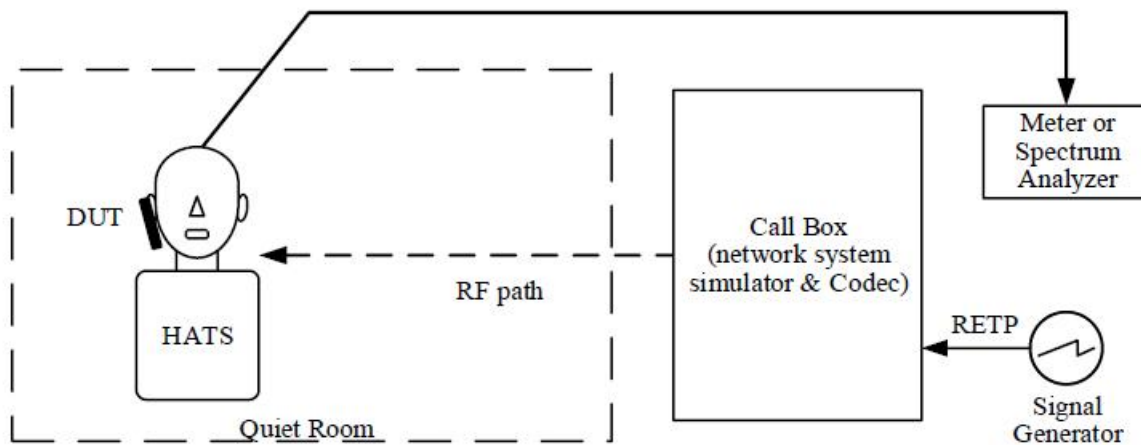

NOTES:

1. Additional information related to the air interface for the various RF technologies is specified in several 3GPP documents. A list of these can be found in 3GPP TS 26.132 V14.0.0 clause 4
2. Additional information related to the test setup can be found in 3GPP TS 26.132, V14.0.0 clause 5.1.
3. The RETP (receive electrical test point) is the point in the device test arrangement where signals are applied to the DUT in the receive direction.

6. Evaluation of Test

6.1 RECEIVE VOLUME CONTROL PERFORMANCE

6.1.1 Requirement

1. With a mounting force of 8N, the DUT shall have at least one volume control setting that will produce a conversational gain of ≥ 6 dB with the output distortion and the frequency response meeting the requirements in clause 5.2.1 & 5.3.1 respectively.
2. With a mounting force of 2N, the DUT shall have at least one volume control setting that will produce a conversational gain of ≥ 6 dB with the output distortion and the frequency response meeting the requirements in clause 5.2.1 & 5.3.1 respectively.

NOTE: Other acoustic receive features may be available such as additional amplification, tone control, automatic gain control, etc. ANSI/TIA-4953-B contains performance requirements for output levels and tone control operation for amplified devices.

6.1.2 Method of Measurement

1. Configure the DUT with a mounting force of 8N and test equipment as shown in Figure 1 in an active call state with the applicable codec for the transmission mode under test.
2. Set the DUT volume control to the maximum setting.
3. If the DUT has an adjustable tone control feature, a tone control setting that meets the frequency response requirements in section 5.3.1 shall be used.
4. Apply the real speech test signal at a level of -20 dBm0 at the RETP and measure the acoustic output at the Drum Reference Point (DRP) over one complete sequence of the test signal.
5. Translate the measurement made at the DRP to the Free Field (FF) using the translation data in Annex B.
6. Over the applicable frequency band, determine the ASL in dBSPL for the resulting sound pressure level in accordance with Method B of ITU-T Recommendation P.56:
 - a. Narrowband 100 Hz through 4000 Hz.
 - b. Wideband 100 Hz through 7720 Hz.
7. Calculate the Conversational Gain by subtracting 70 dB from the measured dBSPL.
[Conversational Gain = (Measured dBSPL Level – 70 dBSPL) dB]
8. Measure the output distortion per clause 5.2. If a distortion failure occurs at the maximum volume control setting, reduce the volume control setting and repeat the measurement to determine if a setting can be found for which the conversational gain requirement is met without a distortion failure.
9. Repeat steps 2-8 with a mounting force of 2N.

6.1.3 Test Result

Refer to test Annex A.

Remark: The report only reflects the test data plots of worst mode (for WCDMA BAND 2).

6.1.4 Test Conclusion

PASS.

6.2 RECEIVE DISTORTION AND NOISE PERFORMANCE

6.2.1 Requirement

With a mounting force of 8N and 2N, the ratio of the stimulus signal power to the 100 Hz to 8000 Hz total A-weighted distortion and noise power shall be ≥ 20 dB when tested over the range of 1/3 octave band center frequencies:

1. Narrowband transmission mode: Each 1/3 octave band center frequency from 400 Hz to 3150 Hz.
2. Wideband transmission mode: Each 1/3 octave band center frequency from 250 Hz to 5000 Hz.

6.2.2 Method of Measurement

1. Configure the DUT with a mounting force of 8N and test equipment as shown in Figure 1 in an active call state with the applicable codec for the transmission mode under test with the volume control at the setting determined in 5.1.1.
2. Receive distortion and noise is measured using the PN-SDNR procedure as described in Annex A.
3. To ensure DUT activation, apply the real speech test signal at a level of -20 dBm0 followed immediately by the initial 1/3 octave center frequency PN test signal in Table A.1 based on the narrowband or wideband operating mode. Measure the acoustic output at the DRP over the complete sequence of the PN test signal.
4. Translate the measurement made at the DRP to the FF using the translation data in Annex B.
5. Calculate the acoustic output unweighted total signal power of the stimulus measurement band as described in A.2.
6. Calculate the notched A-weighting distortion and noise components as described in A.3.
7. Calculate the ratio of the signal power to the total A-weighted distortion and noise power using Eq A-1.
8. Repeat for each of the remaining 1/3 octave center frequencies in Table A.1 based on the narrowband or wideband operating mode.
9. Repeat steps 2-8 with a mounting force of 2N.

6.2.3 Test Result

Refer to test Annex A.

Remark: The report only reflects the test data plots of worst mode (for WCDMA BAND 2).

6.2.4 Test Conclusion

PASS.

6.3 RECEIVE ACOUSTIC FREQUENCY RESPONSE PERFORMANCE

6.3.1 Requirement

1. Narrowband: The 1/12 octave band frequency response after translation to the FF or DF shall fall between the upper and lower limits given in Table 1 and shown in Figure below.

Table 1 – Narrowband Receive Frequency Response Limits

Lower Limit Frequency (Hz)	Lower Limit (dB)	Upper Limit Frequency (Hz)	Upper Limit (dB)
300	-6	100	+6
3400	-6	4000	+6

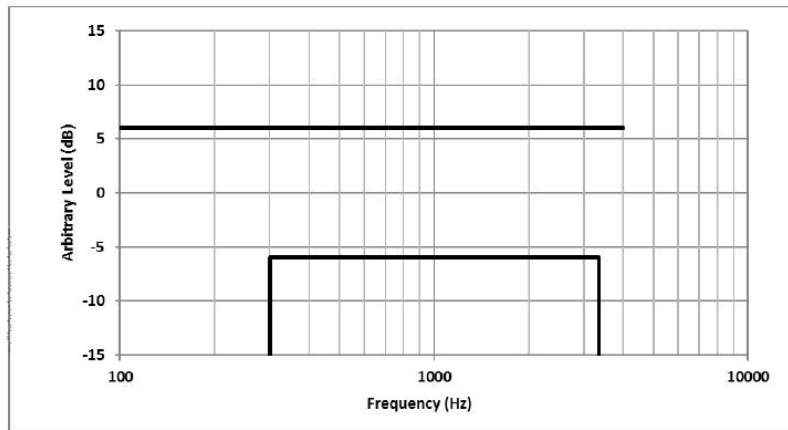

2. Wideband: The 1/12 octave band frequency response after translation to the FF or DF shall fall between the upper and lower limits given in Table 2 and shown in Figure below.

Table 2 – Wideband Receive Frequency Response Limits

Lower Limit Frequency (Hz)	Lower Limit (dB)	Upper Limit Frequency (Hz)	Upper Limit (dB)
200	-10	100	+6
300	-6	1000	+6
5000	-6	2000	+8
6300	-12	8000	+8

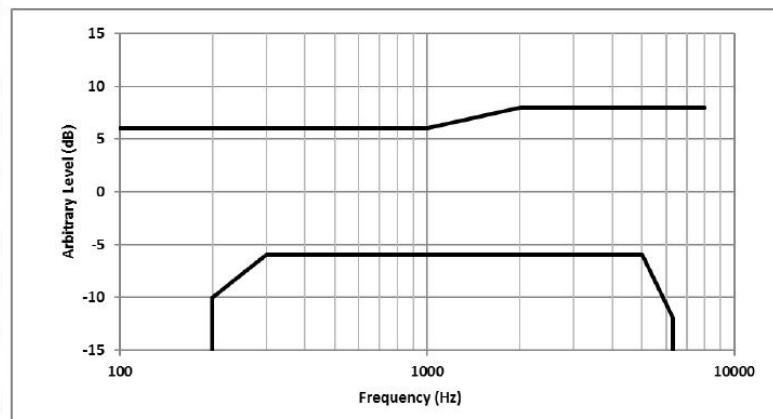

6.3.2 Method of Measurement

1. Configure the DUT with a mounting force of 8N and test equipment as shown in Figure 1 in an active call state with the applicable codec for the transmission mode under test with the volume control at the setting determined in 5.1.1.
2. If the DUT has an adjustable tone control feature the initial measurement is to be performed with the default tone control setting.
3. Apply the real speech test signal with a level of -20 dBm0 at the RETP.
4. Capture the frequency spectrum at the DRP of the HATS using real-time analysis with 1/12 octave bands over the frequency range from 100 Hz to 4000 Hz for narrowband measurements, or over the frequency range from 100 Hz to 8000 Hz for wideband measurements, averaged over the entire duration of the test signal.
5. Transform the DRP frequency spectrum measurement to the FF or DF (see Annex B).
6. Divide the 1/12 octave measurement data by the 1/12 octave frequency spectrum of the test signal at the RETP and present the measurement in terms of dB(Pa/V).
7. Apply the applicable frequency response limits to determine compliance.
8. If the default tone control setting does not meet the requirement, repeat the above steps for other tone control settings to determine a tone control setting that meets the requirements.
9. Repeat with a mounting force of 2N.

6.3.3 Test Result

Refer to test Annex A.

Remark: The report only reflects the test data plots of worst mode (for WCDMA BAND 2).

6.3.4 Test Conclusion

PASS.

7. Test Equipment List

Description	Manufacturer	Model	Internal number	Cal. Date	Cal. Due
WIDEBAND RADIO COMMUNICATION TESTER	ROHDE&SCHWARZ	CMW500	BTF-EM-023	2023/11/16	2024/11/15
Conditioning Amplifier	Brule&Kjaer	Type -2690--030	BTF-EM-146	2024/1/30	2025/1/29
Head and Torso Simulator	Brule&Kjaer	Type 4128C	BTF-EM-148	2024/1/30	2025/1/29
Sound Calibration	Brule&Kjaer	Type 4231	BTF-EM-149	2024/1/30	2025/1/29
Anechoic Test Chamber	MEC	Type 115	BTF-EM-150	N/A	N/A

8. Air Interfaces / Bands used for testing

The codec bit rates of the applicant's choosing are EVS-NB 24.4kbps and EVS-WB 24.4kbps.

Air-interface	Band	Tested Codec	Tested Rate(kbps)
GSM	850/1900	EFR	/
WCDMA(UMTS)	Band 2/5	AMR-NB	4.75/12.2
		AMR-WB	6.6/23.85
VoLTE	Band 2/4/5/12/13/25/26/41/66/71	AMR-NB	4.75/12.2
		AMR-WB	6.6/23.85
		EVS-NB	24.4
		EVS-WB	24.4

9. Test Result

9.1 Receive volume control, distortion and noise performance

Plot No.	Mode	Channel/Freq.	BW	Volume Level	Codec Type	Codec Bandwidth	Mounting Force (N)	Signal Quality (dB)	Conversional Gain	FCC CG Limit (dB)	CG Margin (dB)	Verdict
1	GSM850	251/848.8MHz	/	Max	EFR	NB	2N	78.16	8.16	6.00	2.16	Pass
			/	Max	EFR	NB	8N	81.99	11.99	6.00	5.99	
2	PCS1900	512/1850.2MHz	/	Max	EFR	NB	2N	78.39	8.39	6.00	2.39	Pass
			/	Max	EFR	NB	8N	82.90	12.90	6.00	6.90	
3	WCDMA Band II	9262/1852.4MHz	/	Max	AMR	NB	2N	77.21	7.21	6.00	1.21	Pass
			/	Max	AMR	NB	8N	81.48	11.48	6.00	5.48	
			/	Max	AMR	WB	2N	77.89	7.89	6.00	1.89	
			/	Max	AMR	WB	8N	81.96	11.96	6.00	5.96	
4	WCDMA Band V	4132/826.4MHz	/	Max	AMR	NB	2N	78.56	8.56	6.00	2.56	Pass
			/	Max	AMR	NB	8N	82.81	12.81	6.00	6.81	
			/	Max	AMR	WB	2N	78.30	8.30	6.00	2.30	
			/	Max	AMR	WB	8N	82.77	12.77	6.00	6.77	
5	LTE FDD Band 2	18700/1860.0MHz	20MHz_QPSK_1_50	Max	AMR	NB	2N	78.69	8.69	6.00	2.69	Pass
				Max	AMR	NB	8N	83.59	13.59	6.00	7.59	
				Max	AMR	WB	2N	79.11	9.11	6.00	3.11	
				Max	AMR	WB	8N	83.45	13.45	6.00	7.45	
6	LTE FDD Band 4	20300/1745.0MHz	20MHz_QPSK_1_50	Max	AMR	NB	2N	79.10	9.10	6.00	3.10	Pass
				Max	AMR	NB	8N	82.33	12.33	6.00	6.33	
				Max	AMR	WB	2N	80.02	10.02	6.00	4.02	
				Max	AMR	WB	8N	83.76	13.76	6.00	7.76	
7	LTE FDD Band 5	20450/829.0MHz	10MHz_QPSK_1_25	Max	AMR	NB	2N	77.69	7.69	6.00	1.69	Pass
				Max	AMR	NB	8N	81.95	11.95	6.00	5.95	
				Max	AMR	WB	2N	78.36	8.36	6.00	2.36	
				Max	AMR	WB	8N	82.74	12.74	6.00	6.74	
8	LTE FDD Band 12	23095/707.5MHz	10MHz_QPSK_1_25	Max	AMR	NB	2N	78.93	8.93	6.00	2.93	Pass
				Max	AMR	NB	8N	83.12	13.12	6.00	7.12	
				Max	AMR	WB	2N	79.11	9.11	6.00	3.11	
				Max	AMR	WB	8N	83.23	13.23	6.00	7.23	
9	LTE FDD Band 13	23230/782.0MHz	10MHz_QPSK_1_25	Max	AMR	NB	2N	79.16	9.16	6.00	3.16	Pass
				Max	AMR	NB	8N	84.20	14.20	6.00	8.20	
				Max	AMR	WB	2N	80.05	10.05	6.00	4.05	
				Max	AMR	WB	8N	84.37	14.37	6.00	8.37	
10	LTE FDD Band 25	26140/1860.0MHz	20MHz_QPSK_1_50	Max	AMR	NB	2N	79.01	9.01	6.00	3.01	Pass
				Max	AMR	NB	8N	83.86	13.86	6.00	7.86	
				Max	AMR	WB	2N	78.56	8.56	6.00	2.56	
				Max	AMR	WB	8N	83.41	13.41	6.00	7.41	
11	LTE FDD Band 26	26765/821.5MHz	15MHz_QPSK_1_38	Max	AMR	NB	2N	77.95	7.95	6.00	1.95	Pass
				Max	AMR	NB	8N	82.32	12.32	6.00	6.32	
				Max	AMR	WB	2N	78.09	8.09	6.00	2.09	
				Max	AMR	WB	8N	82.45	12.45	6.00	6.45	
12	LTE TDD Band 41	39750/2506.0MHz	20MHz_QPSK_1_50	Max	AMR	NB	2N	78.69	8.69	6.00	2.69	Pass
				Max	AMR	NB	8N	82.87	12.87	6.00	6.87	
				Max	AMR	WB	2N	78.53	8.53	6.00	2.53	
				Max	AMR	WB	8N	82.64	12.64	6.00	6.64	
13	LTE FDD Band 66	132572/1770MHz	20MHz_QPSK_1_50	Max	AMR	NB	2N	78.49	8.49	6.00	2.49	Pass
				Max	AMR	NB	8N	82.55	12.55	6.00	6.55	
				Max	AMR	WB	2N	79.08	9.08	6.00	3.08	
				Max	AMR	WB	8N	82.99	12.99	6.00	6.99	
14	LTE FDD Band 71	133222/673.0MHz	20MHz_QPSK_1_50	Max	AMR	NB	2N	78.42	8.42	6.00	2.42	Pass
				Max	AMR	NB	8N	82.69	12.69	6.00	6.69	
				Max	AMR	WB	2N	78.60	8.60	6.00	2.60	
				Max	AMR	WB	8N	82.82	12.82	6.00	6.82	

9.2 Receive acoustic frequency response performance

Plot No.	Mode	Channel/Freq.	BW	Volume Level	Codec Type	Codec Bandwidth	Mounting Force (N)	RFR
								Test Result
1	GSM850	251/848.8MHz	/	Max	EFR	NB	2N	Pass
				Max	EFR	NB	8N	
2	PCS1900	512/1850.2MHz	/	Max	EFR	NB	2N	Pass
				Max	EFR	NB	8N	
3	WCDMA Band II	9262/1852.4MHz	/	Max	AMR	NB	2N	Pass
				Max	AMR	NB	8N	
				Max	AMR	WB	2N	
				Max	AMR	WB	8N	
				Max	AMR	NB	8N	
				Max	AMR	WB	2N	
4	WCDMA Band V	4132/826.4MHz	/	Max	AMR	NB	2N	Pass
				Max	AMR	NB	8N	
				Max	AMR	WB	2N	
				Max	AMR	WB	8N	
5	LTE FDD Band 2	18700/1860.0MHz	20MHz_QPSK_1_50	Max	AMR	NB	2N	Pass
				Max	AMR	WB	8N	
				Max	AMR	WB	2N	
6	LTE FDD Band 4	20300/1745.0MHz	20MHz_QPSK_1_50	Max	AMR	NB	2N	Pass
				Max	AMR	NB	8N	
				Max	AMR	WB	2N	
7	LTE FDD Band 5	20450/829.0MHz	10MHz_QPSK_1_25	Max	AMR	WB	8N	Pass
				Max	AMR	WB	2N	
				Max	AMR	WB	8N	
8	LTE FDD Band 12	23095/707.5MHz	10MHz_QPSK_1_25	Max	AMR	NB	2N	Pass
				Max	AMR	NB	8N	
				Max	AMR	WB	2N	
9	LTE FDD Band 13	23230/782.0MHz	10MHz_QPSK_1_25	Max	AMR	NB	2N	Pass
				Max	AMR	NB	8N	
				Max	AMR	WB	2N	
				Max	AMR	WB	8N	
				Max	AMR	NB	8N	
				Max	AMR	WB	2N	
10	LTE FDD Band 25	26140/1860.0MHz	20MHz_QPSK_1_50	Max	AMR	NB	2N	Pass
				Max	AMR	NB	8N	
				Max	AMR	WB	2N	
				Max	AMR	WB	8N	

Plot No.	Mode	Channel/Freq.	BW	Volume Level	Codec Type	Codec Bandwidth	Mounting Force (N)	RFR
								Test Result
11	LTE FDD Band 26	26765/821.5MHz	15MHz_QPSK_1_38	Max	AMR	NB	2N	Pass
				Max	AMR	NB	8N	
				Max	AMR	WB	2N	
				Max	AMR	WB	8N	
12	LTE TDD Band 41	39750/2506.0MHz	20MHz_QPSK_1_50	Max	AMR	NB	2N	Pass
				Max	AMR	NB	8N	
				Max	AMR	WB	2N	
				Max	AMR	WB	8N	
13	LTE FDD Band 66	132572/1770MHz	20MHz_QPSK_1_50	Max	AMR	NB	2N	Pass
				Max	AMR	NB	8N	
				Max	AMR	WB	2N	
				Max	AMR	WB	8N	
14	LTE FDD Band 71	133222/673.0MHz	20MHz_QPSK_1_50	Max	AMR	NB	2N	Pass
				Max	AMR	NB	8N	
				Max	AMR	WB	2N	
				Max	AMR	WB	8N	

10. EUT photograph

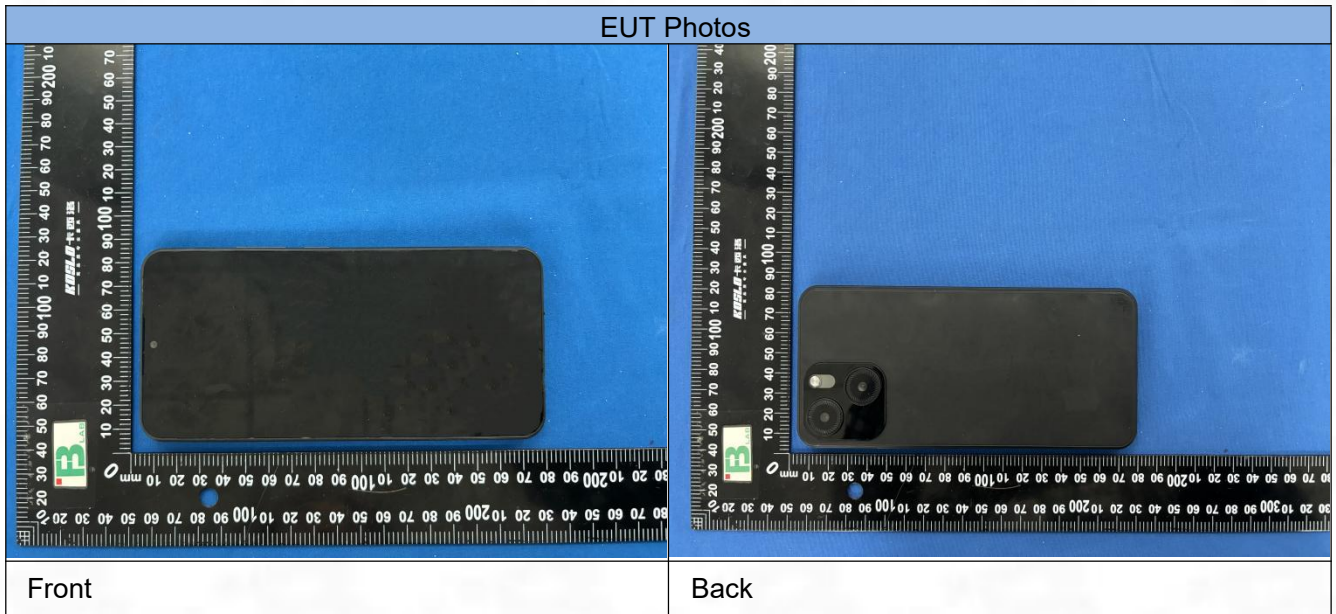

ANNEX A Test Data

1.1 Receive Volume Control Performance 8N NB

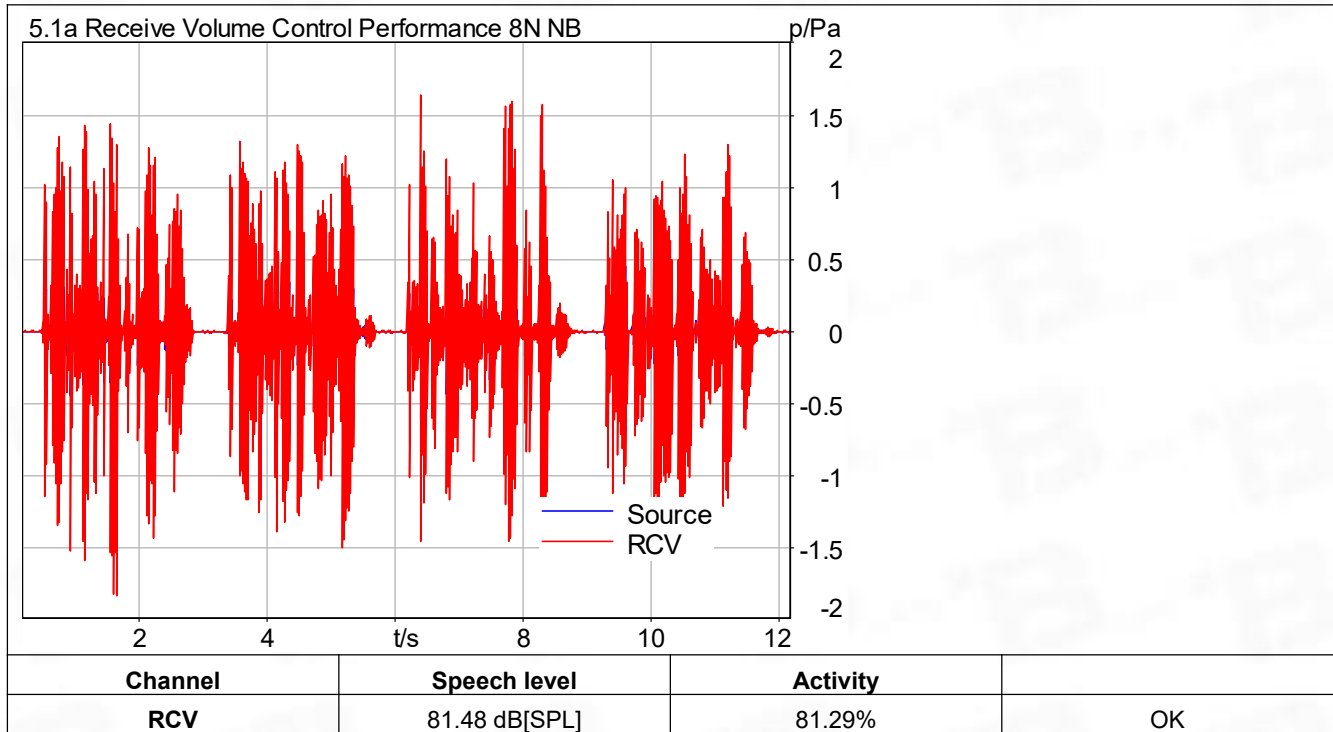

1.2 Receive Volume Control Performance 2N NB

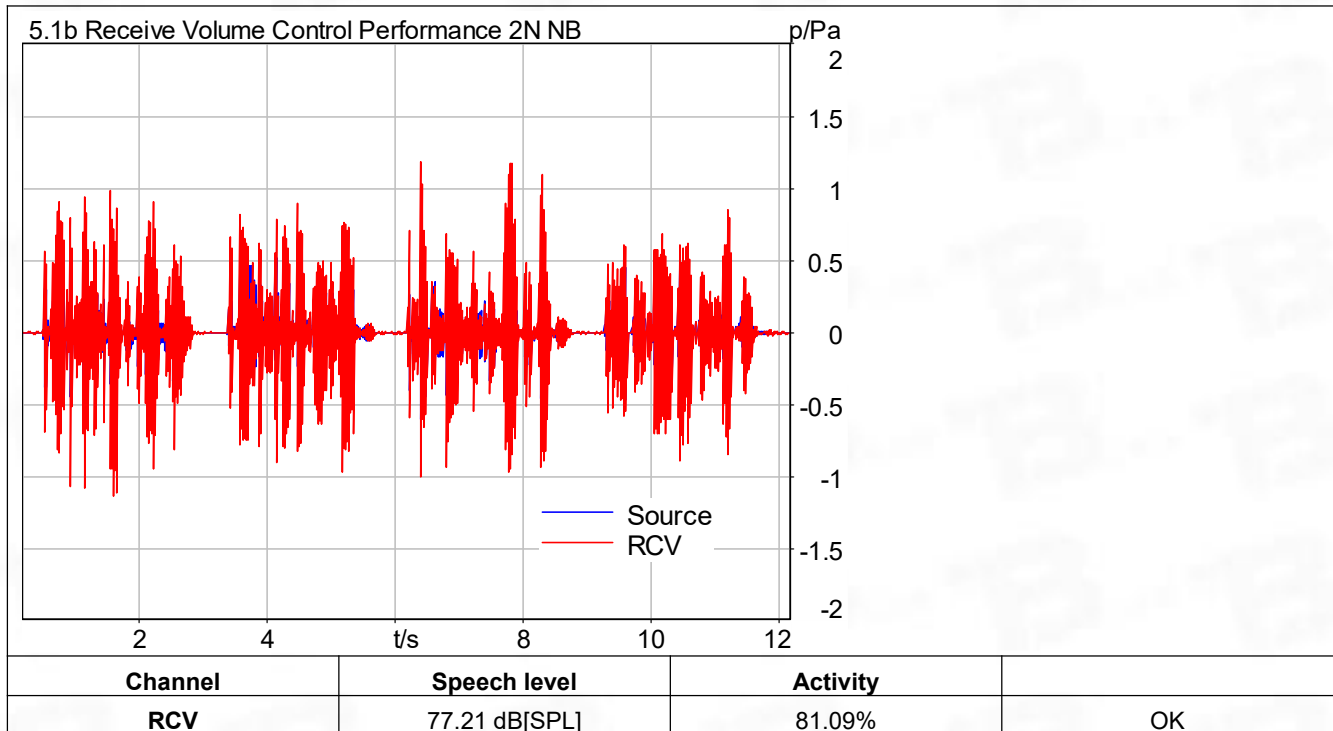

1.3 Receive Distortion and Noise 8N NB

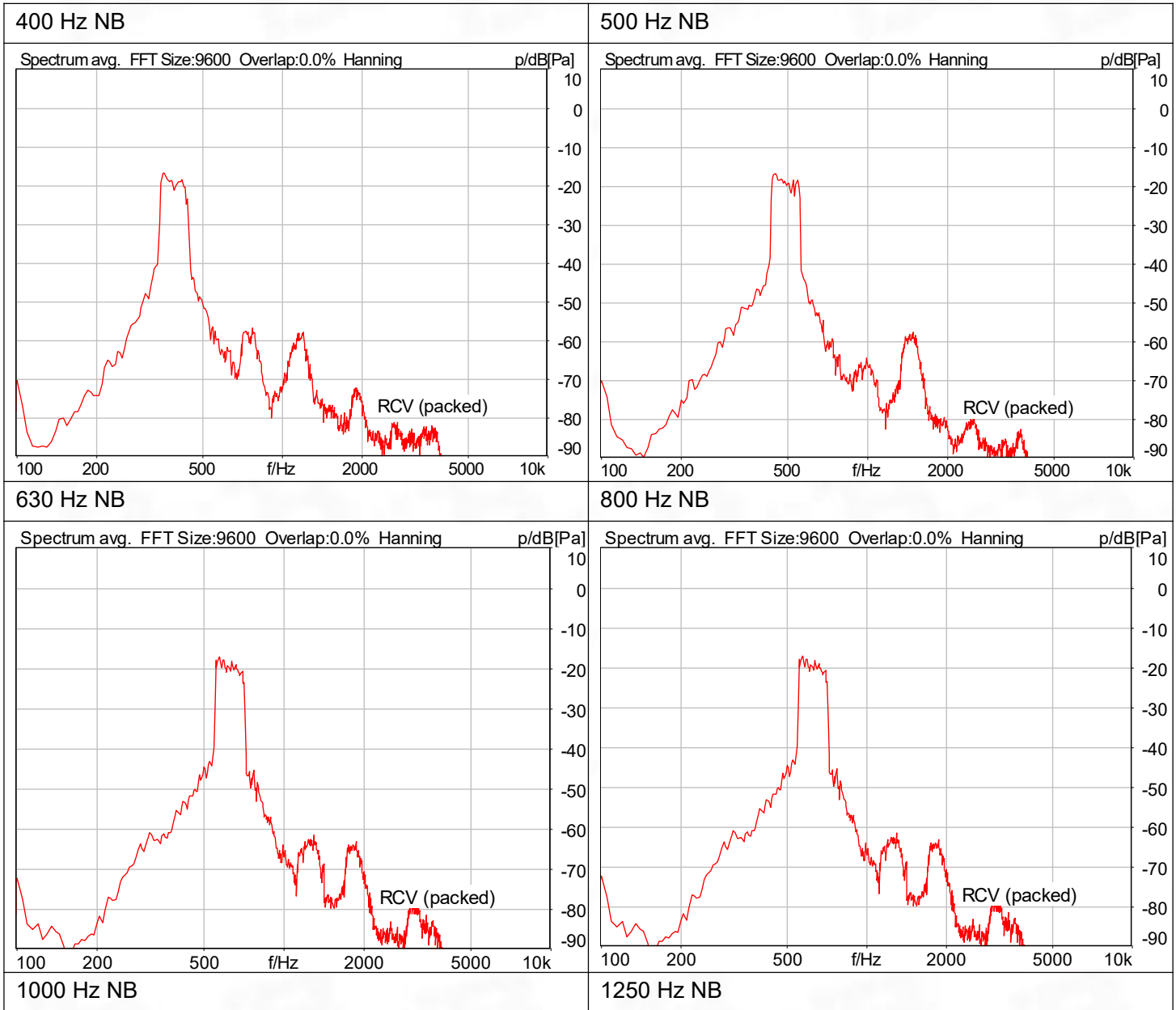

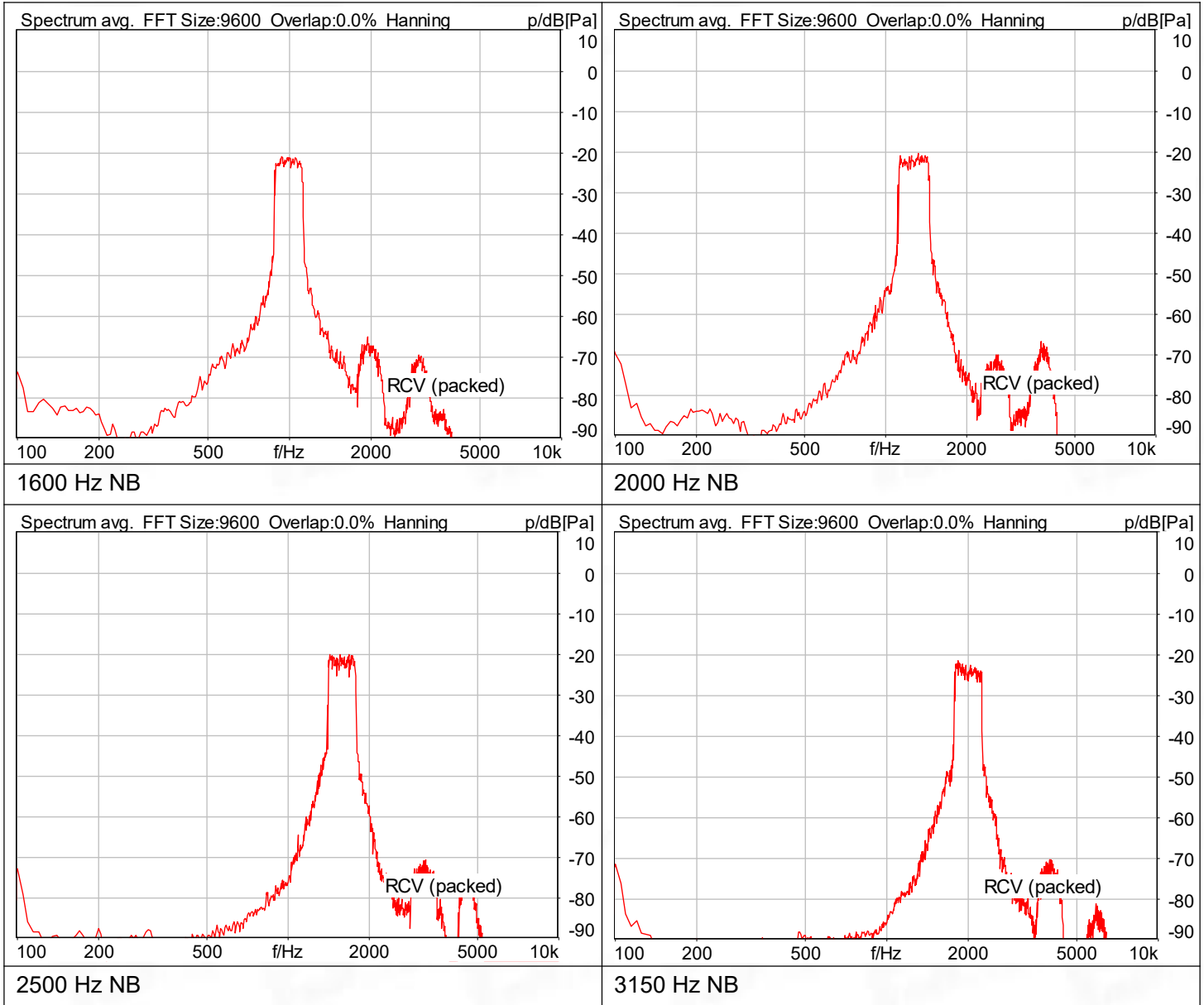

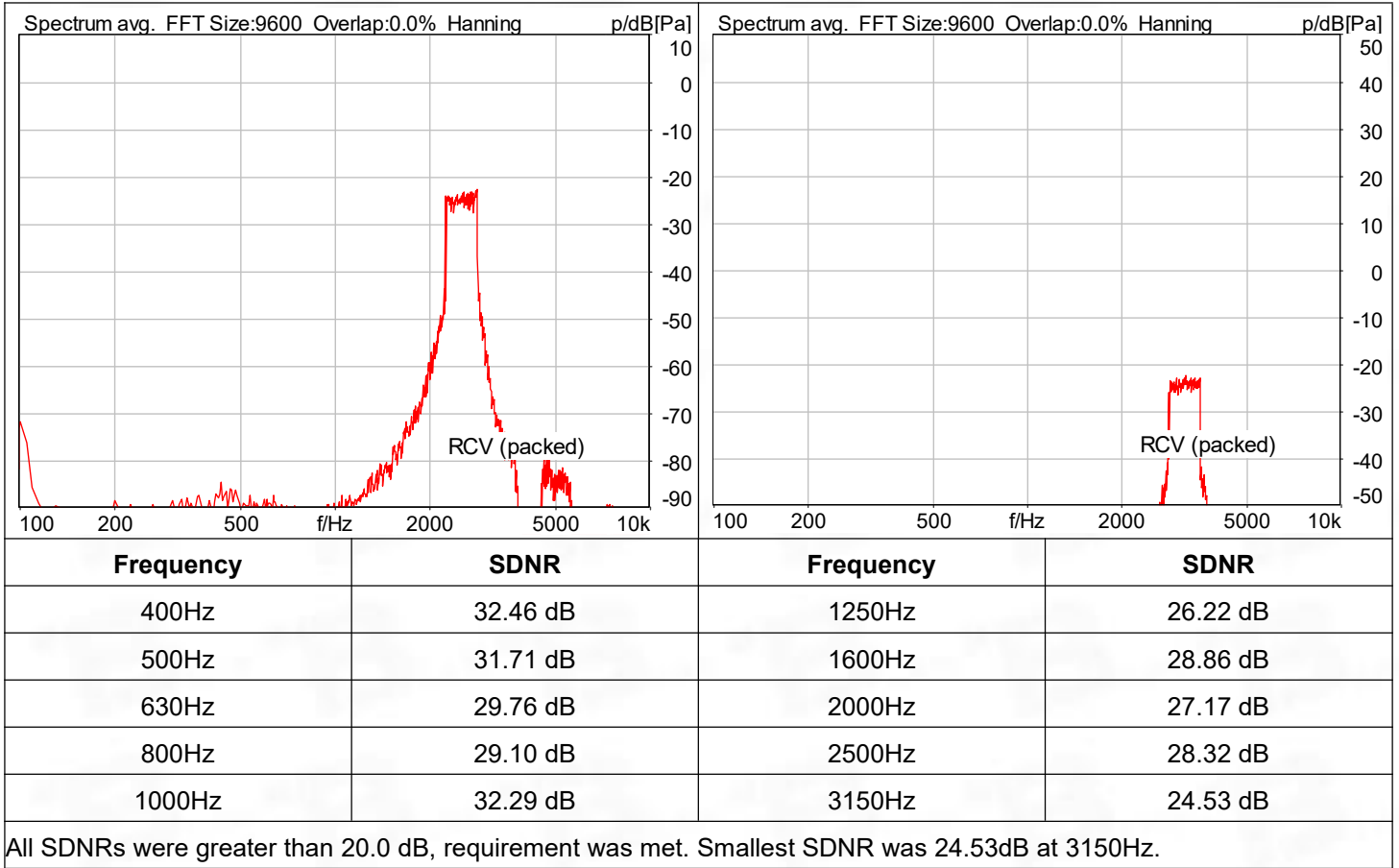

1.4 Receive Distortion and Noise 2N NB

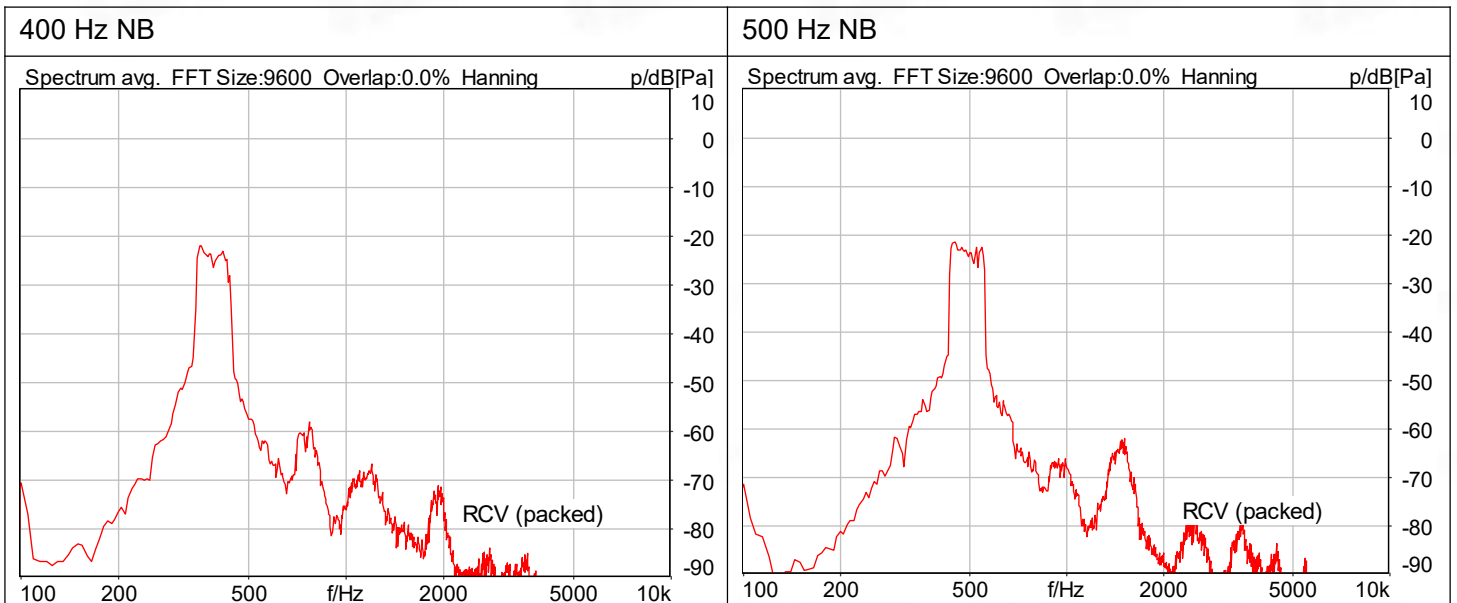

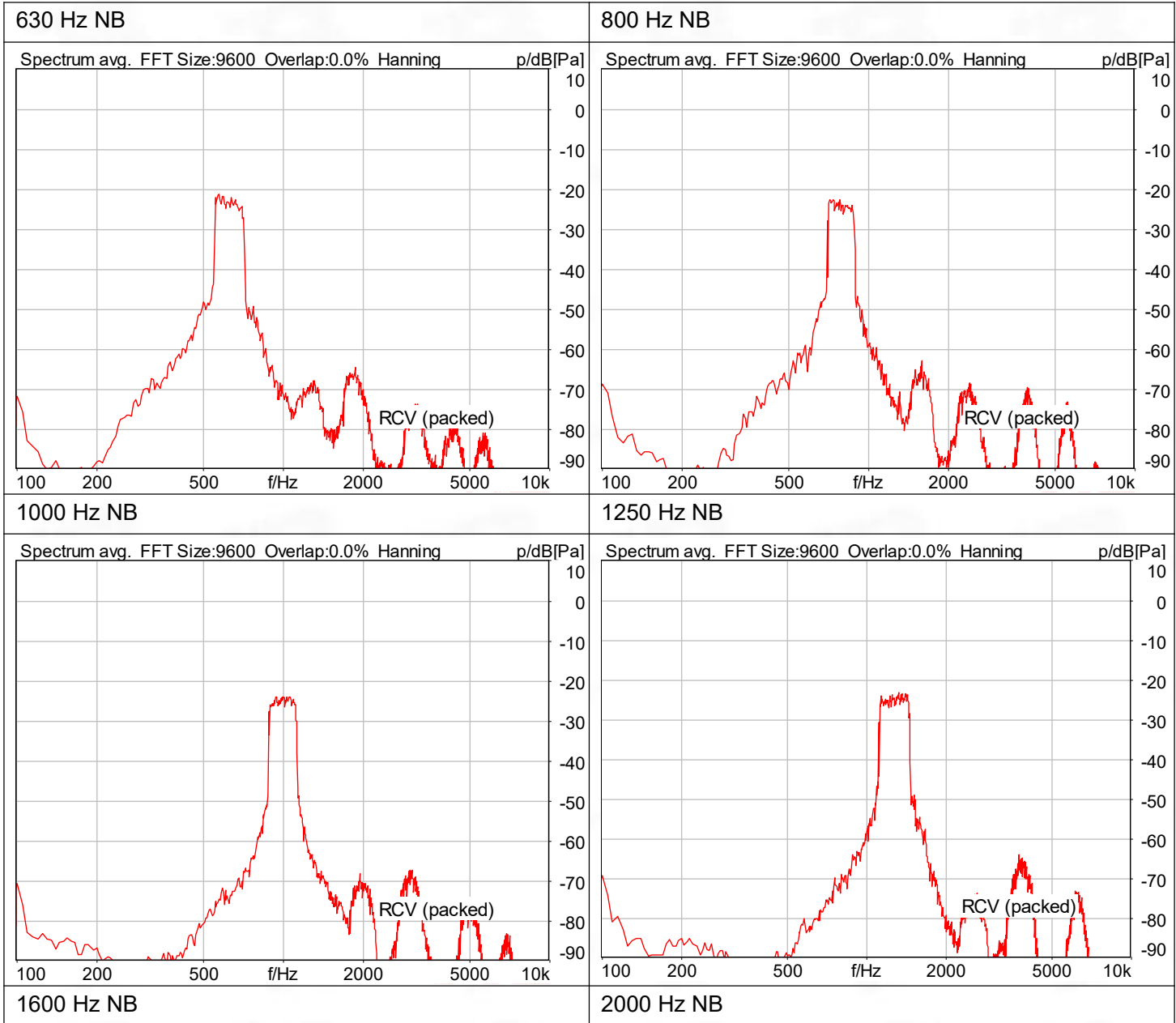

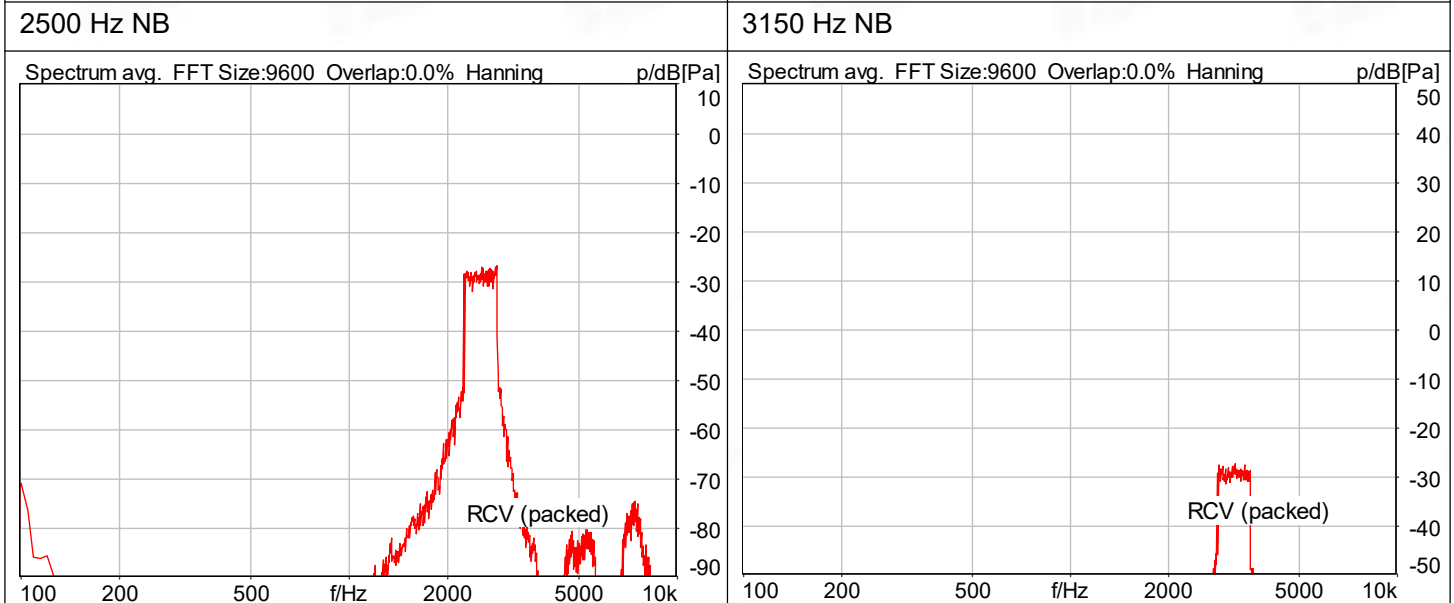
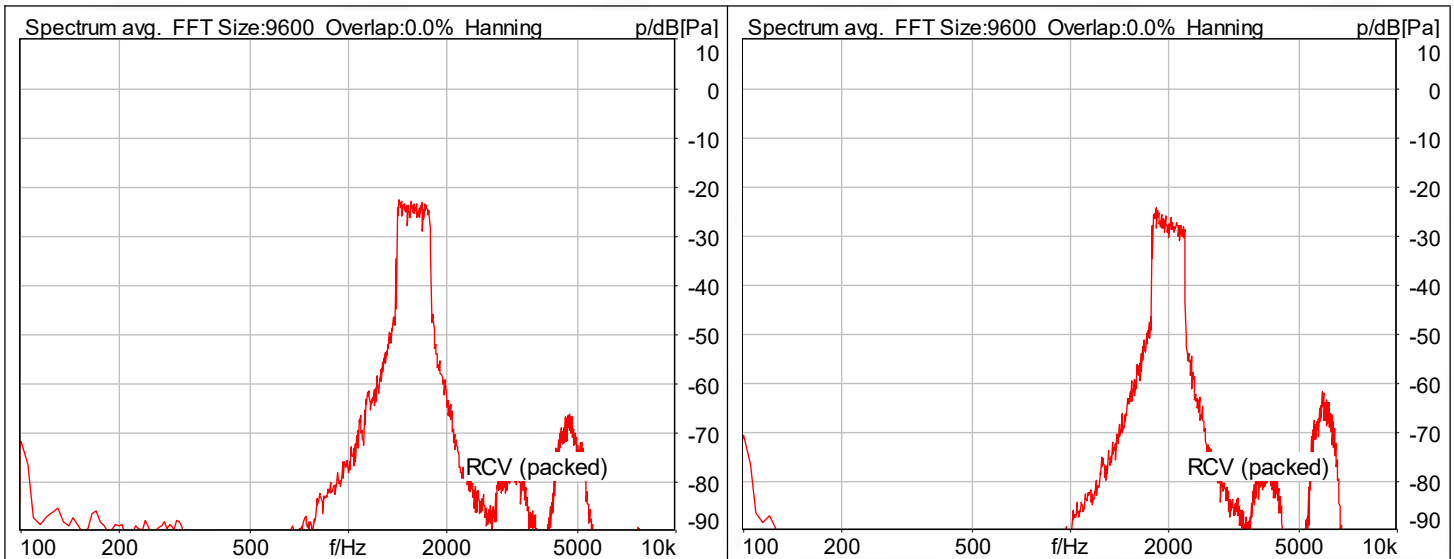

Frequency	SDNR	Frequency	SDNR
400Hz	32.03 dB	1250Hz	26.70 dB
500Hz	31.26 dB	1600Hz	28.86 dB
630Hz	29.58 dB	2000Hz	26.74 dB
800Hz	29.18 dB	2500Hz	27.80 dB
1000Hz	31.67 dB	3150Hz	24.32 dB

All SDNRs were greater than 20.0 dB, requirement was met. Smallest SDNR was 24.32dB at 3150Hz.

1.5 Receive Frequency Response

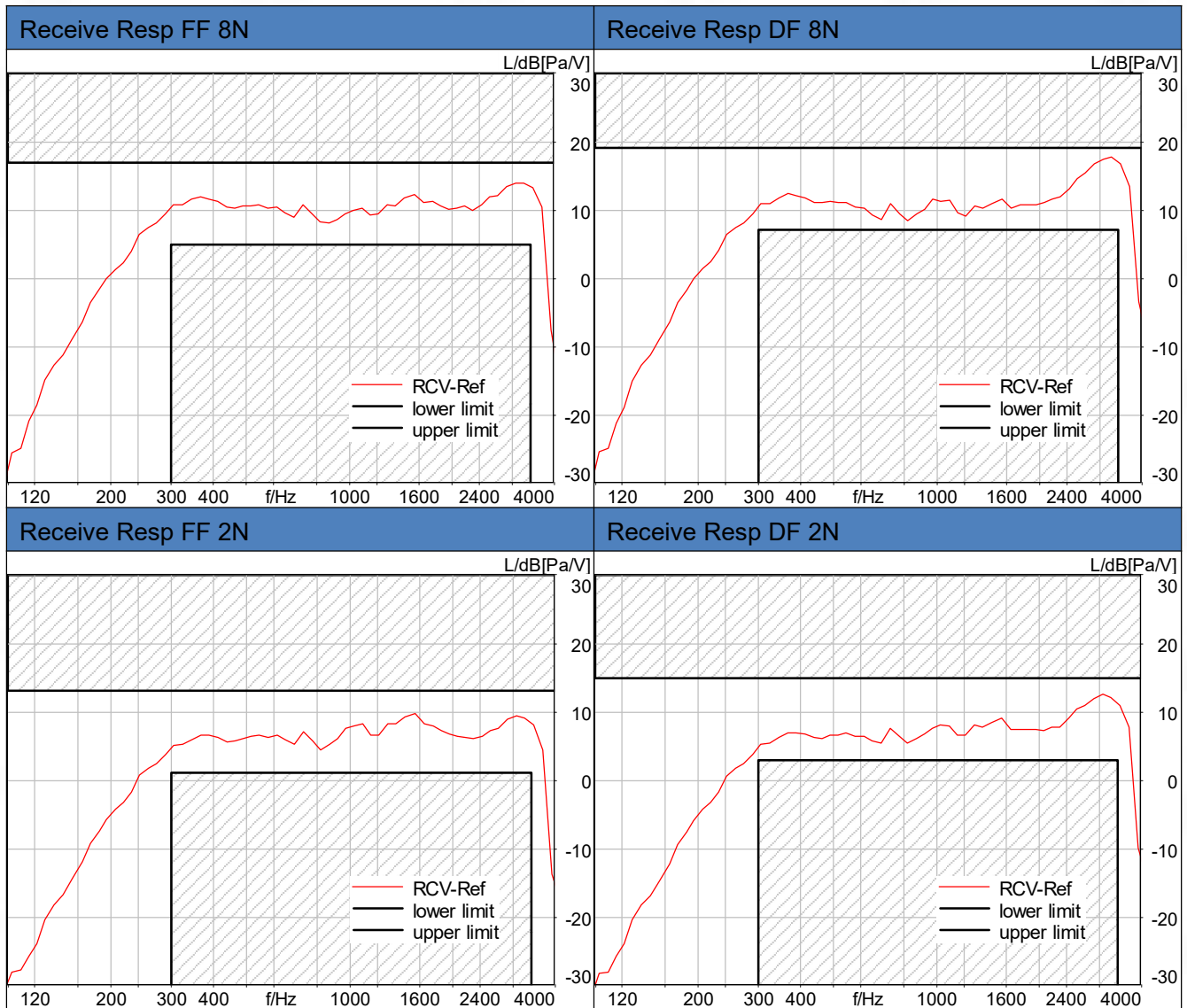

ANNEX B Test Setup Photo



ANNEX C CALIBRATION REPORT

Please refer the document "CALIBRATION REPORT.pdf".



BTF Testing Lab (Shenzhen) Co., Ltd.

F101, 201 and 301, Building 1, Block 2, Tantou Industrial Park, Tantou Community, Songgang Street,
Bao'an District, Shenzhen, China

www.btf-lab.com

--END OF REPORT--