

深圳市八方达通信有限公司

Z6010天线测试报告

工程：毛宇峥

测试日期：2023-05-05

工程电话：13424326585

天线频段设计

射频	网络模式	GSM+W+BT+WIFI+GPS	
	频段要求	GSM: B2 B3 B5 B8 WCDMA: B2 B5 LTE: B2 B4 B5 B12 B13 B17 B25 B26 B41 B66	
	通讯天线数量	主天线	GSM+W+LTE
		分集天线	
		三合一天线	GPS+WIFI+BT

天线匹配电路说明

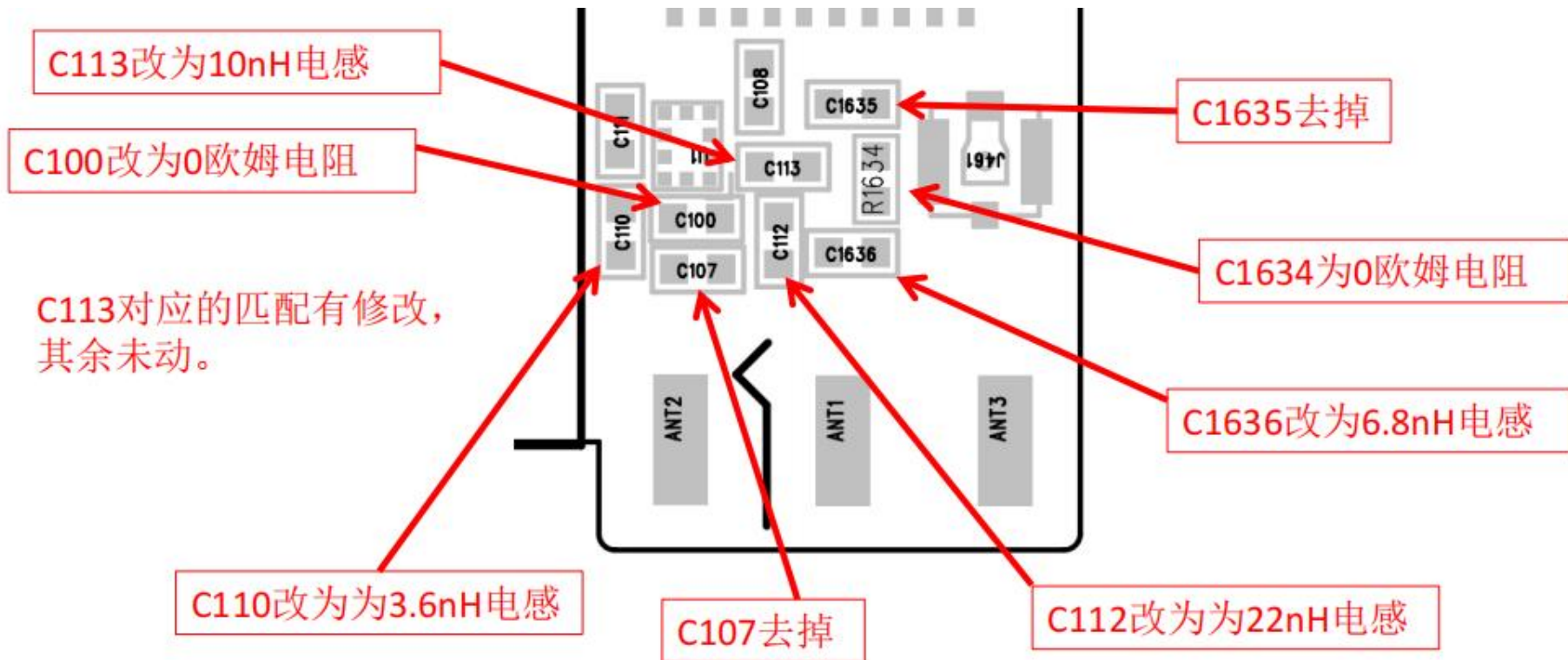

天线数据

Modulation	GSM 850			GSM 900			DCS 1800			PCS 1900		
Channel	Low	Medium	High	Low	Medium	High	Low	Medium	High	Low	Medium	High
TRP	25.67	25.94	25.23	26.52	25.14	24.75	25.32	24.98	25.22	25.38	25.33	24.51
TIS	-101.76	-101.4	-100.24	-99.45	-96.55	-95.22	-104.61	-105.08	-104.81	-104.11	-105.27	-105.3
Modulation	WCDMA B2			WCDMA B5								
Channel	Low	Medium	High	Low	Medium	High						
TRP	19.82	19.20	18.31	17.84	17.91	16.05						
TIS			-102.04			-105.5						

天线数据

Modulation	LTE B2			LTE B4			LTE B5			LTE B12		
Channel	Low	Medium	High	Low	Medium	High	Low	Medium	High	Low	Medium	High
TRP	19.94	18.97	19.65	16.17	16.28	16.45	17.30	16.75	15.16	15.06	15.51	15.90
TIS			-90.79			-93.04			-90.67			-91.35
Modulation	LTE B13			LTE B17			LTE B25			LTE B26		
Channel	Low	Medium	High	Low	Medium	High	Low	Medium	High	Low	Medium	High
TRP		16.65		15.71	15.18	15.66		19.54			17.05	
TIS		-91.28				-92.26		-90.85			-90.23	
Modulation	LTE B41			LTE B66								
Channel	Low	Medium	High	Low	Medium	High						
TRP	15.04	16.88	15.32	16.17	17.72	18.17						
TIS			-90.03			-90.48						.

GPS/WIFI/BT有源测试报告

GPS	最大信号强度	搜星数量	平均定位时间	天气状况
	40	10	110S	晴
WIFI	距WIFI路由器6m处接收信号强度		无障碍正常上网距离	
	-55dB		20m	
BT	背向无障碍清晰通话距离			
	7m			

BT/2.4G WiFi/5G WiFi

Frequency	Efficiency(%)	Gain.(dBi)
2400MHz	56.23	2.23
2410MHz	57.25	2.41
2420MHz	56.27	2.17
2430MHz	56.58	2.17
2440MHz	57.22	2.27
2450MHz	60.11	2.30
2460MHz	60.15	2.36
2470MHz	57.84	2.27
2480MHz	60.31	2.37
2490MHz	57.55	2.26
2500MHz	56.68	2.19
5150MHz	56.78	2.39
5250MHz	57.89	2.06
5350MHz	56.98	2.38
5450MHz	56.12	2.37
5550MHz	56.59	2.21
5650MHz	60.13	2.36
5750MHz	57.48	2.41
5850MHz	56.85	2.38

Phi 0 2D 图

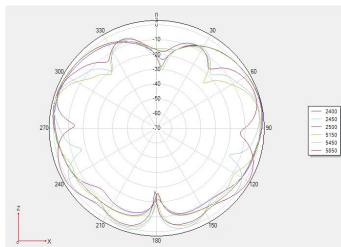

Phi 90 2D 图

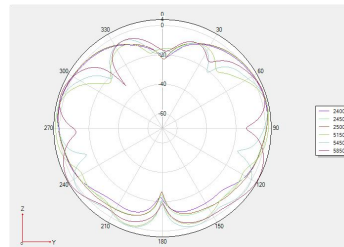

Theta 90 2D 图

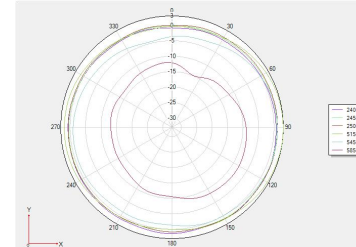

Phi 0 2D 图:

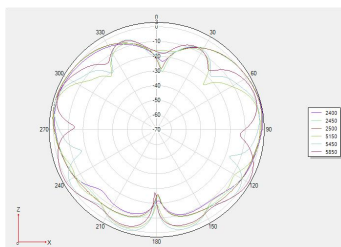

Phi 90 2D 图

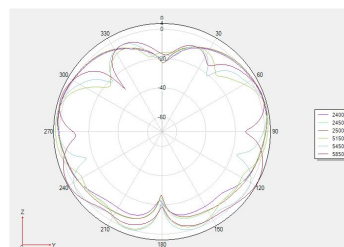

Theta 90 2D 图

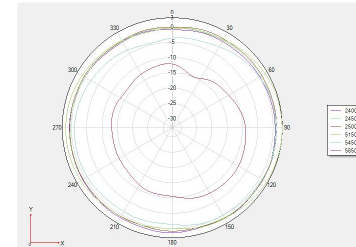

天线增益

Frequency(MHZ)	Gain(dBd)	Gain(dBi)
GSM850	0.53	2.68
GSM900	0.49	2.64
DCS1800	0.33	2.48
PCS1900	0.31	2.46
WCDMA850	0.53	2.68
WCDMA1900	0.31	2.46
LTE B2	0.31	2.46
LTE B4	0.31	2.46
LTE B5	0.51	2.66
LTE B12	0.22	2.37
LTE B13	0.23	2.38
LTE B17	0.22	2.37
LTE B25	0.33	2.48
LTE B26	0.53	2.68
LTE B41	0.57	2.72
LTE B66	0.32	2.47
GPS	0.11	2.26
WIFI/BT	0.26	2.41

深圳市八方达通信有限公司

SHENZHEN BFD COMMUNICATION EQUIPMENT CO.,LTD



公司地址：深圳市福田区车公庙泰然工贸园212栋311

公司电话：0755-82737516 传真：0755-82737505

公司邮箱：best-just@163.com <http://www.best-just.com>