



HAC RF Test Report

For

Applicant Name: Xwireless LLC
Address: 11565 Old Georgetown Road, Rockville, MD, USA
EUT Name: Mobile Phone
Brand Name: Vortex
Model Number: HD55

Issued By

Company Name: BTF Testing Lab (Shenzhen) Co., Ltd.
Address: F101, 201 and 301, Building 1, Block 2, Tantou Industrial Park, Tantou Community, Songgang Street, Bao'an District, Shenzhen, China

Report Number: BTF240105R00501
Test Standards: ANSI C63.19-2019 FCC 47 CFR §20.19 KDB 285076 D01
KDB 285076 D02 KDB 285076 D03
FCC ID: 2ADLJ- HD55

Test Conclusion: Pass
Test Date: 2024-01-17 to 2024-04-07
Date of Issue: 2024-04-11

Prepared By: *Amenda Zhong*
Amenda Zhong / Project Engineer

Date: 2024-04-11

Approved By: *Ryan.CJ*
Ryan.CJ / EMC Manager

Date: 2024-04-11

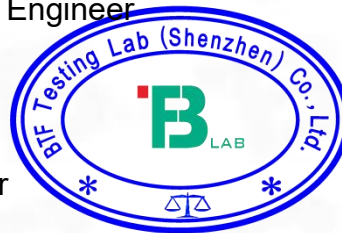

Note: All the test results in this report only related to the testing samples. Which can be duplicated completely for the legal use with approval of applicant; it shall not be reproduced except in full without the written approval of BTF Testing Lab (Shenzhen) Co., Ltd., All the objections should be raised within thirty days from the date of issue. To validate the report, you can contact us.

Revision History		
Version	Issue Date	Revisions Content
R_V0	2024-01-19	Original
R_V1	2024-04-11	Revised the report with Simultaneous and retest again.
Note:	Once the revision has been made, then previous versions reports are invalid.	

Table of Contents

1. Introduction	4
1.1 Identification of Testing Laboratory	4
1.2 Identification of the Responsible Testing Location	4
1.3 Laboratory Condition	4
1.4 Announcement	4
2. Product Information	5
2.1 Application Information	5
2.2 Manufacturer Information	5
2.3 Factory Information	5
2.4 General Description of Equipment under Test (EUT)	5
2.5 Equipment under Test Ancillary Equipment	5
2.6 Technical Information	5
2.7 Air Interfaces / Bands Indicating Operating Modes	6
2.8 Power Reduction Description	6
3. Summary of Test Results	7
3.1 Test Standards	7
3.2 Summary of HAC result	7
3.3 HAC Test Uncertainty	8
4. Measurement System	9
4.1 Definition of Hearing Aid Compatibility (HAC)	9
4.2 HAC RF Test Configuration and Setting	10
4.3 MVG HAC System	10
5. System Validation	13
5.1 System Validation Setup	13
5.2 System Check Procedure	13
5.3 System Validation Procedure	14
6. WD emission requirements	15
7. Modulation Interference Factor (MIF)	16
8. HAC Immunity Measurement Procedures	17
8.1 HAC Measurement Process Diagram	17
8.2 HAC RF Test Setup	18
8.3 RF Emission Measurement Procedures: indirect measurement-preferred	18
9. Max. Conducted RF Output Power	19
9.1 Wi-Fi	23
10. Low-Power Exemption	25
10.1 Tune-up Power	25
10.2 RF Emissions Lower Power Exemption	26
11. Test Equipment List	27
ANNEX A HAC RF System Validation Result	28
ANNEX B HAC RF Measurement Result	30
ANNEX C Test Setup Photos	32
ANNEX D EUT External & Internal Photos	32
ANNEX E Calibration Information	32

1. Introduction

1.1 Identification of Testing Laboratory

Company Name:	BTF Testing Lab (Shenzhen) Co., Ltd.
Address:	F101, 201 and 301, Building 1, Block 2, Tantou Industrial Park, Tantou Community, Songgang Street, Bao'an District, Shenzhen, China
Phone Number:	+86-0755-23146130
Fax Number:	+86-0755-23146130

1.2 Identification of the Responsible Testing Location

Test Location:	BTF Testing Lab (Shenzhen) Co., Ltd.
Address:	F101, 201 and 301, Building 1, Block 2, Tantou Industrial Park, Tantou Community, Songgang Street, Bao'an District, Shenzhen, China
Description:	All measurement facilities used to collect the measurement data are located at F101,201 and 301, Building 1, Block 2, Tantou Industrial Park, Tantou Community, Songgang Street, Bao'an District, Shenzhen, China
FCC Registration Number	518915
Designation Number	CN1330

1.3 Laboratory Condition

Ambient Temperature:	21°C to 25°C
Ambient Relative Humidity:	48% to 59%
Ambient Pressure:	100 kPa to 102 kPa

1.4 Announcement

- (1) The test report reference to the report template version v0.
- (2) The test report is invalid if not marked with the signatures of the persons responsible for preparing, reviewing and approving the test report.
- (3) The test report is invalid if there is any evidence and/or falsification.
- (4) This document may not be altered or revised in any way unless done so by BTF and all revisions are duly noted in the revisions section.
- (5) Content of the test report, in part or in full, cannot be used for publicity and/or promotional purposes without prior written approval from the laboratory.
- (6) The laboratory is only responsible for the data released by the laboratory, except for the part provided by the applicant.

2. Product Information

2.1 Application Information

Company Name:	Xwireless LLC
Address:	11565 Old Georgetown Road, Rockville, MD, USA

2.2 Manufacturer Information

Company Name:	Xwireless LLC
Address:	11565 Old Georgetown Road, Rockville, MD, USA

2.3 Factory Information

Company Name:	ZTECH COMMUNICATION(SZ) CO LTD
Address:	FL 7 BLOCK D BAO' AN ZHIGU INNOVATION PARK YIN' TIAN ROAD NO.4 XI' XIANG STR' BAO' AN DISTRICT SZ CHINA

2.4 General Description of Equipment under Test (EUT)

EUT Name	Mobile Phone
Under Test Model Name	HD55
Sample No.	BTFSN240105006 1/4

2.5 Equipment under Test Ancillary Equipment

Ancillary Equipment 1	Rechargeable Battery	
	Capacity	2300mAh
	Rated Voltage	3.8V

2.6 Technical Information

Network and Wireless connectivity	2G Network GSM/GPRS 850/1900 3G Network WCDMA/HSDPA/HSUPA Band 2/4/5 4G Network FDD LTE Band 2/4/5/12/13/17/25/26/66/71 TDD LTE Band 41 2.4G WIFI 802.11b, 802.11g, 802.11n(HT20/40) 5G WIFI 802.11a, 802.11n(HT20/HT40), 802.11ac(VHT20/40/80) BT (EDR+BLE)
-----------------------------------	---

2.7 Air Interfaces / Bands Indicating Operating Modes

Air Interface	Band	Type	C63.19 RFAIL Tested	Simultaneous Transmitter	Name of Service	Power Reduction
GSM	850	VO	Yes	WLAN & BT	CMRS Voice	No
	1900	VO	Yes	WLAN & BT	CMRS Voice	No
	GPRS/EGPRS	DT	Yes	N/A	N/A	No
WCDMA	Band II	VO	No	WLAN & BT	CMRS Voice	No
	Band IV	VO	No	WLAN & BT	CMRS Voice	No
	Band V	VO	No	WLAN & BT	CMRS Voice	No
	HSPA	DT	No	N/A	N/A	No
LTE	Band 2	VD	No	WLAN & BT	VoLTE	No
	Band 4	VD	No	WLAN & BT	VoLTE	No
	Band 5	VD	No	WLAN & BT	VoLTE	No
	Band 12	VD	No	WLAN & BT	VoLTE	No
	Band 13	VD	No	WLAN & BT	VoLTE	No
	Band 17	VD	No	WLAN & BT	VoLTE	No
	Band 25	VD	No	WLAN & BT	VoLTE	No
	Band 26	VD	No	WLAN & BT	VoLTE	No
	Band 41	VD	No	WLAN & BT	VoLTE	No
	Band 66	VD	No	WLAN & BT	VoLTE	No
	Band 71	VD	No	WLAN & BT	VoLTE	No
WLAN	2.4g & 5g	DT	No	WWAN	N/A	No
BT	2450	DT	No	WWAN	N/A	No

NA: Not Applicable
VO: Voice Only
VD: CMRS and IP Voice Service over Digital Transport
DT: Digital Transport Only

Note1: The air interface max power plus MIF is complies with ANSI63.19-2019 Table 4.1 RFAIPL
Note2: According to ANSI C63.19 2019-version, for the air interface technology of a device is exempt from testing whose peak antenna input power, averaged over intervals $\leq 50 \mu s$, is $\leq 23 \text{ dBm}$.

2.8 Power Reduction Description

Each qualified transmitter is tested individually using the method of ANSI C63.19-2019 Clause 4. Other WD transmitters shall be temporarily disabled or reduced in power level such that their average antenna input power is at least 6 dB lower than the average antenna input power of the transmitter under test. The transmitter under test is set to the fixed and repeatable combination of power and modulation characteristic that is representative of the worst case (highest interference potential) likely to be encountered while the WD is experiencing normal voice mode operation.

The limiting measurement for device qualification is the highest RF audio interference potential measured for any of the WD transmitters. If the highest interference measurement is from a transmitter that is not required for normal voice mode operation, a secondary rating may be given that applies when that transmitter is disabled.

Note: The device does not support power reduction for HAC mode, so we do not need to consider the case of power reduction.

3. Summary of Test Results

3.1 Test Standards

No.	Identity	Document Title
1	ANSI C63.19-2019	American National Standard for Methods of Measurement of Compatibility between Wireless Communication Devices and Hearing Aids
2	FCC 47 CFR §20.19	Hearing Aid Compatible Mobile Headsets
3	KDB 285076 D01	HAC Guidance v06r04
4	KDB 285076 D02	T-Coil testing for CMRS IP v04
5	KDB 285076 D03	HAC FAQ v01r06

3.2 Summary of HAC result

Band	Channel	Measurement Result	
GSM850	Low (128)	E-Field dB (V/m)	24.37
	Middle(190)	E-Field dB (V/m)	25.72
	High(251)	E-Field dB (V/m)	26.00
GSM1900	Low (512)	E-Field dB (V/m)	23.22
	Middle(661)	E-Field dB (V/m)	21.44
	High(810)	E-Field dB (V/m)	20.08

3.3 HAC Test Uncertainty

The following measurement uncertainty levels have been estimated for tests performed on the EUT as specified in ANSI C6 3.19-2019. This uncertainty represents an expanded uncertainty expressed at approximately the 95% confidence level using a coverage factor of k=2.

UNCERTAINTY EVALUATION FOR RF HAC MEASUREMENT					
Uncertainty Component	Tol (±dB)	Prob. Dist.	Div.	Uncertainty (dB)	Uncertainty (%)
Measurement System					
RF reflections	0.1	R	√3	0.06	
Field probe conv. Factor	0.4	R	√3	0.23	
Field probe anisotropy	0.25	R	√3	0.14	
Positioning accuracy	0.2	R	√3	0.12	
Probe cable placement	0.1	R	√3	0.06	
System repeatability	0.2	R	√3	0.12	
EUT repeatability	0.4	N	1	0.40	
Combined Standard Uncertainty		N	1	0.52	
Expanded Uncertainty (95% CONFIDENCE INTERVAL)		N	K=2	1.03	12.65
REPORTED Expanded uncertainty (confidence level of 95%, k = 2)		N	K=2	1.00	13.00

4. Measurement System

4.1 Definition of Hearing Aid Compatibility (HAC)

The purpose of this standard is to establish categories for hearing aids and for WD (wireless communications devices) that can indicate to health care practitioners and hearing aid users which hearing aids are compatible with which WD, and to provide tests that can be used to assess the electromagnetic characteristics of hearing aids and WD and assign them to these categories. The various parameters required, in order to demonstrate compatibility and accessibility are measured. The design of the standard is such that when a hearing aid and WD achieve one of the categories specified, as measured by the methodology of this standard, the indicated performance is realized.

In order to provide for the usability of a hearing aid with a WD, several factors must be coordinated:

- a) Radio frequency (RF) measurements of the near-field electric and magnetic fields emitted by a WD to categorize these emissions for correlation with the RF immunity of a hearing aid.
- b) Magnetic field measurements of a WD emitted via the audio transducer associated with the T-coil mode of the hearing aid, for assessment of hearing aid performance.
- c) Measurements with the hearing aid and a simulation of the categorized WD T-coil emissions to assess the hearing aid RF immunity in the T-coil mode.

The WD radio frequency (RF) and audio band emissions are measured.

Hence, the following are measurements made for the WD:

- a) RF E-Field emissions
- b) T-coil mode, magnetic signal strength in the audio band
- c) T-coil mode, magnetic signal and noise articulation index
- d) T-coil mode, magnetic signal frequency response through the audio band

Corresponding to the WD measurements, the hearing aid is measured for:

- a) RF immunity in microphone mode
- b) RF immunity in T-coil mode

4.2 HAC RF Test Configuration and Setting

For HAC RF emission testing, the EUT was linked and controlled by wireless communication test set. Communication between the EUT and the wireless communication test set was established by air link. The distance between the EUT and the communicating antenna of the test set is larger than 50 cm and the output power radiated from the wireless communication test set antenna is at least 30 dB smaller than the output power of EUT. The EUT was set from the wireless communication test set to radiate maximum output power during HAC testing.

4.3 MVG HAC System

MVG HAC System Diagram

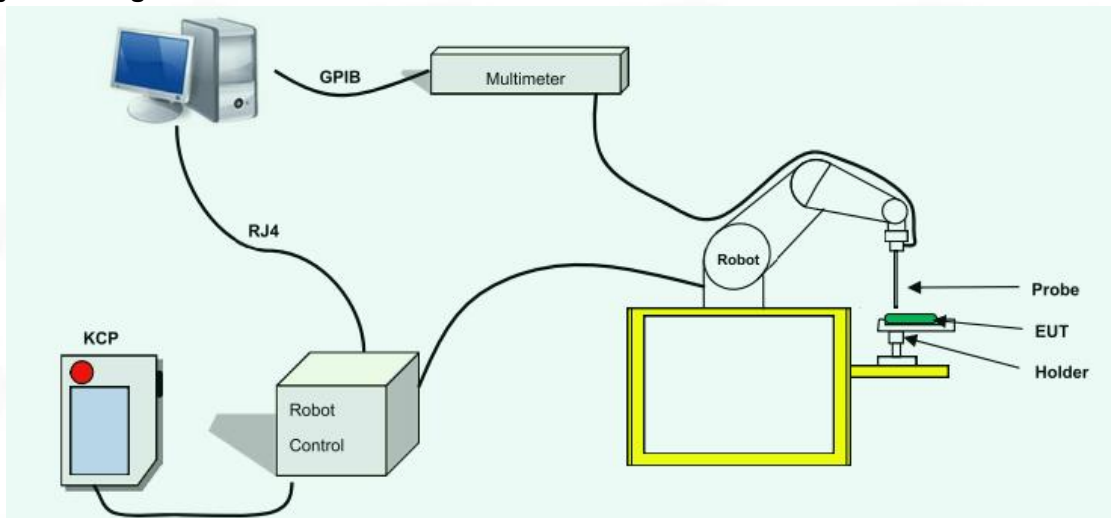

4.3.1 Robot



A standard high precision 6-axis robot (Denso) with t eaches pendant with Scanning System

- It must be able to scan all the volume of the phanto m to evaluate the tridimensional distribution of SAR.
- Must be able to set the probe orthogonal of the surf ace of the phantom ($\pm 30^\circ$).
- Detects stresses on the probe and stop itself if nec essary to keep the integrity of the probe.

4.3.2 E-Field Probe

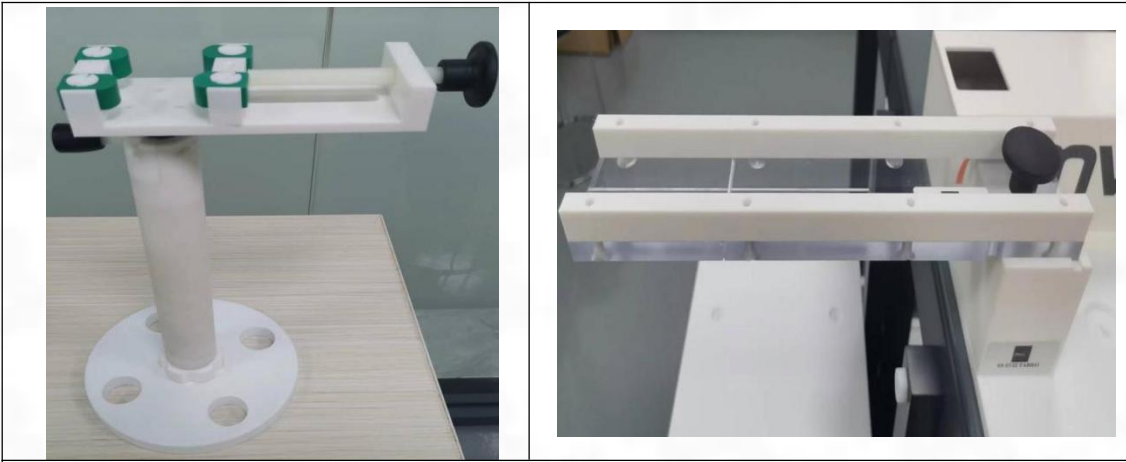

Figure 1 – MVG COMOHAC E field Probe

Probe Length	330 mm
Length of Individual Dipoles	3.3 mm
Maximum external diameter	8 mm
Probe Tip External Diameter	5 mm
Distance between dipoles / probe extremity	3 mm

Device Type	COMOHAC E FIELD PROBE
Manufacturer	MVG
Model	SCE
Serial Number	SN 07/22 EPH50
Product Condition (new / used)	New
Frequency Range of Probe	0.7GHz-2.5GHz
Resistance of Three Dipoles at Connector	Dipole 1: R1=0.208 MΩ Dipole 2: R2=0.220 MΩ Dipole 3: R3=0.212 MΩ

4.3.3 Device Holder/DUT positioner



During test, use DUT positioner adjust DUT to check if the Speaker is aligned with the positioner center.

5. System Validation

According to ANSI C63.19, before hearing aid testing commences, the experimental setup shall be validated. Sub clauses 6.3.1 through 6.3.5 include a set of pretest procedures designed to validate the experimental setup to ensure the accuracy of the results. To verify that the hearing aid performs per the manufacturer's specifications, 6.3.5 advises that the hearing aid be pretested per ANSI S3.22.

5.1 System Validation Setup

Using this setup configuration, the signal generator was adjusted for the desired output power 20dBm (100mW) at a specified frequency. The reference power from the coupled port of the directional coupler is recorded. Next, the output cable is connected to the reference dipole

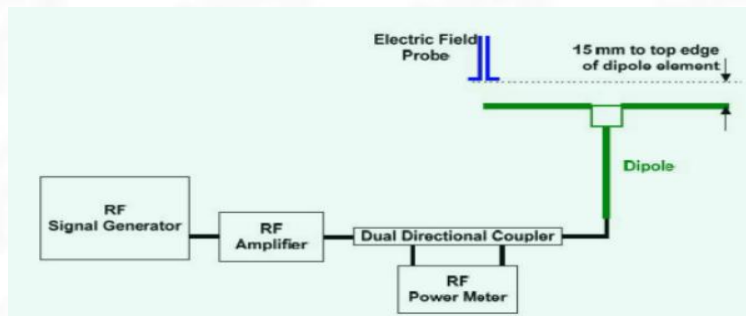

5.2 System Check Procedure

The input signal was an unmodulated continuous wave. The following points were taken into consideration in performing this check:

- Average Input Power $P = 100\text{mW RMS}$ (20dBm RMS) after adjustment for return loss
- The test fixture must meet the 2 wavelength separation criterion
- The proper measurement of the 1 cm probe to dipole separation, which is measured from top surface of the dipole to the calibration reference point of the sensor, defined by the probe manufacturer is shown in the following diagram:

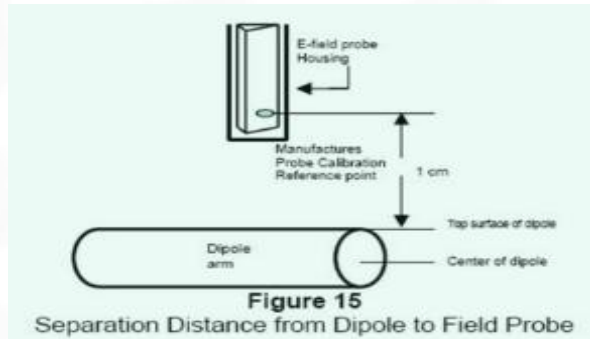

RF power was recorded using both an average reading meter and a peak reading meter. Readings of the probe are provided by the measurement system. To assure proper operation of the near-field measurement probe the input power to the dipole shall be commensurate with the full rated output power of the wireless device (e.g. – for a cellular phone wireless device the average peak antenna input power will be on the order of 100mW (i.e. - 20dBm) RMS after adjustment for any mismatch.

5.3 System Validation Procedure

A dipole antenna meeting the requirements given in C63.19 was placed in the position normally occupied by the WD. The length of the dipole was scanned with both E-field and H-field probes and the maximum values for each were recorded. Using the near-field measurement system, scan the antenna over the radiating dipole and record the greatest field reading observed. Due to the nature of E-fields about free-space dipoles, the two E-field peaks measured over the dipole are averaged to compensate for non-parallelity of the setup see manufacturer method on dipole calibration certificates, Field strength measurements shall be made only when the probe is stationary. RF power was recorded using both an average and a peak power reading meter.

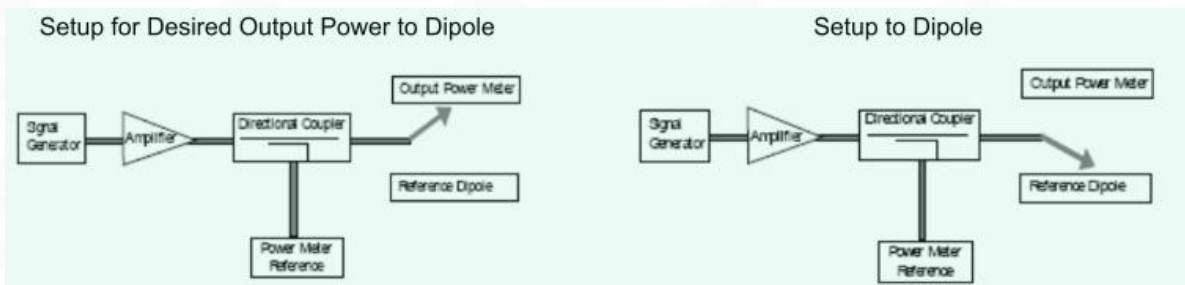

6. WD emission requirements

The WD's conducted power must be at or below either the stated RFAIPL (Table 1.1) or the stated peak power level (Table 1.2), or the average near-field emissions over the measurement area must be at or below the stated RFAII. (Table 1.3), or the stated peak field strength (Table 1.4). The WD may demonstrate compliance by meeting any of these four requirements, but it must do so in each of its operating bands at its established worst-case normal speech-mode operating condition.

Table 1.1—Wireless device RF audio interference power level

Frequency range (MHz)	RFAIPL (dBm)
Ⓢ60	29
960-2000	26
>2000	25

Table 1.2—Wireless device RF peak power level

Frequency range (MHz)	RFpeak Po ^{cr} (dBm)
<960	35
960-2000	32
>2000	31

Table 1.3—Wireless device RF audio interference level

Frequency range (MHz)	RFAII dB(V/m)
<960	39
960-2000	36
>2000	35

Table 1.4-Wireless device RF peak near-field level

Frequency range (MHz)	RFpck dB(V/m)
<960	45
960-2000	42
>2000	41

7. Modulation Interference Factor (MIF)

The HAC Standard ANSI C63.19-2019 defines a new scaling using the Modulation Interference Factor (MIF). For any specific fixed and repeatable modulated signal, a modulation interference factor (MIF, expressed in dB) may be developed that relates its interference potential to its steady-state rms signal level or average power level. This factor is a function only of the audio-frequency amplitude modulation characteristics of the signal and is the same for field-strength and conducted power measurements. It is important to emphasize that the MIF is valid only for a specific repeatable audio-frequency amplitude modulation characteristic. Any change in modulation characteristic requires determination and application of a new MIF.

The MIF may be determined using a radiated RF field, a conducted RF signal, or in a preliminary stage, a mathematical analysis of a modeled RF signal:

a) Verify the slope accuracy and dynamic range capability over the desired operating frequency band of a fast probe or sensor, square-law detector, as specified in D.3, and weighting system as specified in D.4 and D.5. For the probe and instrumentation included in the measurement of MIF, additional calibration and application of calibration factors are not required.

b) Using RF illumination or conducted coupling, apply the specific modulated signal in question to the measurement system at a level within its confirmed operating dynamic range.

c) Measure the steady-state rms level at the output of the fast probe or sensor.

d) Measure the steady-state average level at the weighting output.

e) Without changing the square-law detector or weighting system, and using RF illumination or conducted coupling, substitute for the specific modulated signal a 1kHz, 80% amplitude-modulated carrier at the same frequency and adjust its strength until the level at the weighting output equals the step d) measurement.

f) Without changing the carrier level from step e), remove the 1 kHz modulation and again measure the steady-state rms level indicated at the output of the fast probe or sensor.

g) The MIF for the specific modulation characteristic is provided by the ratio of the step f) measurement to the step c) measurement, expressed in dB ($20 \times \log(\text{step f})/\text{step c})$).

In practice, step e) and step f) need not be repeated for each MIF determination if the relationship between the two measurements has been preestablished for the measurement system over the operating frequency and dynamic ranges.

Modulation group	Modulation characteristics	MIF
GSM	TDMA	3.63
WCDMA	UMTS-FDD	-25.43
LTE	LTE-FDD / RB=1 / BW=20 MHz / QPSK	-9.76
	LTE-TDD / RB=1 / BW=20 MHz / QPSK	-1.44
2.4G WiFi	IEEE 802.11b WiFi 2.4 GHz (DSSS, 11 Mbps)	-2.02
	IEEE 802.11g WiFi 2.4 GHz (DSSS/OFDM, 54 Mbps)	0.12
5G WiFi	IEEE 802.11n (HT Mixed, 20MHz, MCS0, 90pc duty cycle)	-5.59
	IEEE 802.11a/n WiFi 5 GHz (OFDM, 54 Mbps)	-3.15
	IEEE 802.11ac WiFi (40MHz, MCS0, 90pc duty cycle)	-5.57
Bluetooth	IEEE 802.15.1 Bluetooth (GFSK, DH1)	1.02

8. HAC Immunity Measurement Procedures

8.1 HAC Measurement Process Diagram

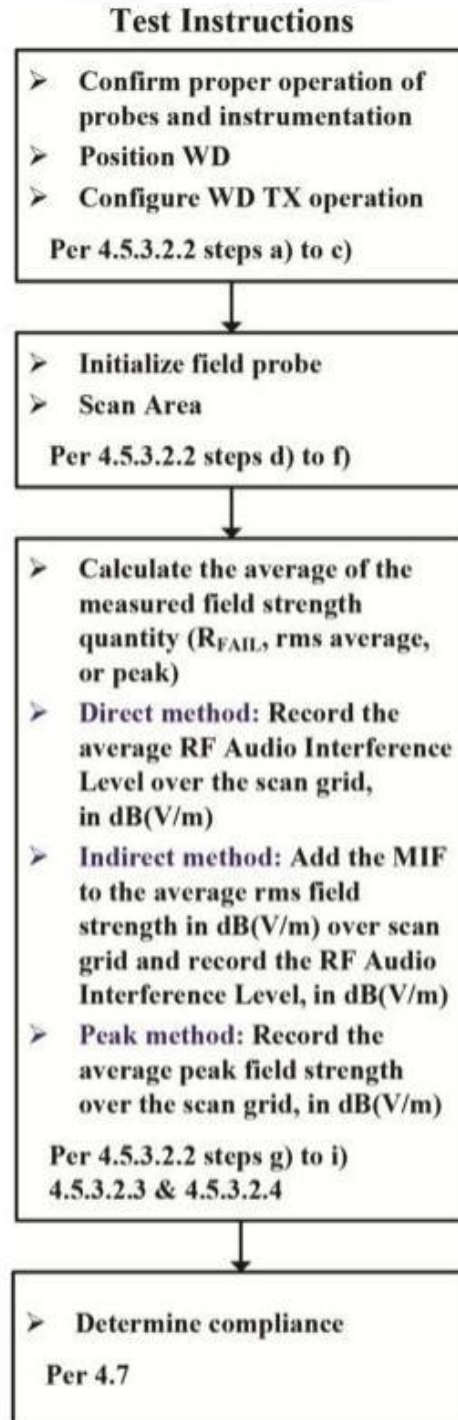

8.2 HAC RF Test Setup



WD reference and plane for RF emission measurements

8.3 RF Emission Measurement Procedures: indirect measurement-preferred

- The measurement procedure using a probe and instrumentation chain with a response of <10 kHz (see ANSI63.19-2019 section4.5.1) is identical to the direct measurement method of ANSI63.19-2019 section4.5.3.2.2: however, because of the bandwidth limitations, it cannot include the direct use of the spectral and temporal weighting functions, The output of such measurement systems must be readings of steady state rms field strength in dB(V/m).
- The RF audio interference level in dB(Vim) is obtained by adding the Modulation Interference Factor (in decibels) to the average steady state rms field strength reading over the measurement area, in dB(V/m), from Step c). Use this result to determine the WD's compliance per ANSI 63.19-2019 section4.7.
- The measurement area shall be centered on the acoustic output or the T-Coil mode measurement reference point, as appropriate. Locate the field probe at the initial test position in the 50 mm by 50 mm measurement area, which is contained in the measurement plane.described in ANSI 63.19-2019 section 4.5.2 and illustrated in Figure A.1. If the field alignment method is used, align the probe for maximum field reception.
- Record the reading at the output of the measurement system.
- Scan the entire 50 mm by 50 mm measurement area in equally spaced step sizes and record the reading at each measurement point. The step size shall meet the specification for step size in ANSI 63.19-2019 section 4.5.3.
- Calculate the average of the measurements taken in Step f.
- Convert the average value found in Step g) to RF audio interference level, in volts per meter, by taking the square root of the reading and then dividing it by the measurement system transfer function, as established in ANSI 63.19-2019 section 4.5.3.2.1 pre-test procedure. Convert the result to dB(V/m) by taking the base-10 logarithm and multiplying it by 20.Expressed as a formula:

$$\text{RF audio interference level in db(V/M)} = 20 \times \log(R_{\text{ave}}^{1/2} / \text{TF})$$

where

R_{ave} is the average reading

- Compare this RF audio interference level to the limits in 6 and record the result.

9. Max. Conducted RF Output Power

2G

Mode: GSM850	Maximum Tune-up(dBm)	Burst Average Power (dBm)		
		CH128	CH190	CH251
		824.2MHz	836.6MHz	848.8MHz
GSM	31.00	30.03	30.39	30.54
Mode: GSM1900	Maximum Tune-up(dBm)	Burst Average Power (dBm)		
		CH512	CH661	CH810
		1850.2MHz	1880.0MHz	1909.8MHz
GSM	29.50	29.20	29.14	29.09

3G

Mode	Maximum Tune-up(dBm)	WCDMA Band II		
		Conducted Power (dBm)		
		CH9262	CH9400	CH9538
RMC 12.2K	21.00	20.69	20.25	19.74
Mode	Maximum Tune-up(dBm)	WCDMA Band IV		
		Conducted Power (dBm)		
		CH1312	CH1413	CH1513
RMC 12.2K	21.50	20.80	21.03	21.09
Mode	Maximum Tune-up(dBm)	WCDMA Band V		
		Conducted Power (dBm)		
		CH4132	CH4183	CH4233
RMC 12.2K	22.00	21.58	21.56	21.46

4G

Band 2

Bandwidth	Modulation	RB allocation	RB offset	Maximum Tune-up(dBm)	18700	18900	19100
					1860.0MHz	1880.0MHz	1900.0MHz
20MHz	QPSK	1	0	21.00	20.92	20.79	20.41
			50	21.50	21.31	21.13	20.78
			99	21.00	20.75	20.52	20.11
		50	0	20.50	20.30	20.01	19.43
			25	20.50	20.20	20.00	19.52
			50	20.50	20.21	19.63	19.11
	16QAM	100	0	20.50	20.24	19.86	19.31
			0	20.50	20.48	19.86	19.63
			50	21.00	20.76	20.35	19.90
		50	99	20.50	20.14	19.69	19.35
			0	19.50	19.38	19.04	18.45
			25	19.50	19.25	19.05	18.61
100	50	19.50	19.26	18.68	18.20		
	0	19.50	19.33	18.94	18.34		

Band 4

Bandwidth	Modulation	RB allocation	RB offset	Maximum Tune-up(dBm)	18700	18900	19100
					1860.0MHz	1880.0MHz	1900.0MHz
20MHz	QPSK	1	0	21.00	20.92	20.79	20.41
			50	21.50	21.31	21.13	20.78
			99	21.00	20.75	20.52	20.11
		50	0	20.50	20.30	20.01	19.43
			25	20.50	20.20	20.00	19.52
			50	20.50	20.21	19.63	19.11
	100	0	20.50	20.24	19.86	19.31	
	16QAM	1	0	20.50	20.48	19.86	19.63
			50	21.00	20.76	20.35	19.90
			99	20.50	20.14	19.69	19.35
		50	0	19.50	19.38	19.04	18.45
			25	19.50	19.25	19.05	18.61
			50	19.50	19.26	18.68	18.20
		100	0	19.50	19.33	18.94	18.34

Band 5

Bandwidth	Modulation	RB allocation	RB offset	Maximum Tune-up(dBm)	20450	20525	20600
					829.0MHz	836.5MHz	844.0MHz
10MHz	QPSK	1	0	22.50	22.18	22.04	22.03
			25	22.50	22.37	22.25	22.21
			49	22.50	22.07	22.09	22.02
		25	0	21.50	21.09	21.23	21.00
			13	21.50	21.16	21.15	21.07
			25	21.50	21.10	21.08	20.85
	50	0	21.50	21.09	21.15	20.95	
	16QAM	1	0	21.50	21.02	21.17	21.37
			25	22.00	21.33	21.38	21.58
			49	21.50	21.05	21.11	21.31
		25	0	20.50	20.16	20.28	20.03
			13	20.50	20.27	20.22	20.13
			25	20.50	20.21	20.07	19.94
		50	0	20.50	20.13	20.19	19.99

Band 12

Bandwidth	Modulation	RB allocation	RB offset	Maximum Tune-up(dBm)	23060	23095	23130
					704.0MHz	707.5MHz	711.0MHz
10MHz	QPSK	1	0	22.00	21.40	21.40	21.53
			25	22.00	21.77	21.80	21.79
			49	22.00	21.64	21.54	21.56
		25	0	21.00	20.68	20.74	20.32
			13	21.00	20.62	20.62	20.61
			25	21.00	20.57	20.84	20.23
	50	0	21.00	20.64	20.78	20.31	
	16QAM	1	0	21.00	20.31	20.54	20.95
			25	21.50	20.74	20.87	21.23
			49	21.00	20.53	20.67	20.98
		25	0	20.00	19.69	19.73	19.31
			13	20.00	19.63	19.63	19.62
			25	20.00	19.60	19.84	19.25
		50	0	20.00	19.61	19.74	19.27

Band 13

Bandwidth	Modulation	RB allocation	RB offset	Maximum Tune-up(dBm)	23230
					782.0MHz
10MHz	QPSK	1	0	22.50	22.23
			25	22.50	22.49
			49	22.50	22.35
		25	0	21.50	21.28
			13	21.50	21.46
			25	21.50	21.40
	50	0	21.50	21.38	
	16QAM	1	0	22.00	21.88
			25	22.50	22.05
			49	22.00	21.99
		25	0	20.50	20.35
			13	21.00	20.51
			25	20.50	20.45
		50	0	20.50	20.38

Band 17

Bandwidth	Modulation	RB allocation	RB offset	Maximum Tune-up(dBm)	23780	23790	23800
					709MHz	710MHz	711MHz
10MHz	QPSK	1	0	21.00	20.92	19.92	19.76
			25	22.00	21.36	21.75	21.97
			49	21.00	20.67	19.23	18.61
		25	0	21.00	20.39	20.45	20.94
			13	21.50	21.31	21.48	21.49
			25	22.00	21.77	21.23	20.47
	50	0	21.50	21.09	20.85	20.71	
	16QAM	1	0	20.50	20.39	19.90	20.18
			25	22.50	21.10	21.81	22.41
			49	20.50	20.31	19.28	19.11
		25	0	21.00	20.27	20.41	20.91
			13	21.50	21.22	21.42	21.47
			25	22.00	21.64	21.12	20.44
		50	0	21.00	20.96	20.77	20.66

Band 25

Bandwidth	Modulation	RB allocation	RB offset	Maximum Tune-up(dBm)	26140	26365	26590
					1860.0MHz	1882.5MHz	1905.0MHz
20MHz	QPSK	1	0	21.00	20.93	20.74	20.34
			50	21.50	21.33	21.11	20.64
			99	21.00	20.76	20.41	19.49
		50	0	20.50	20.30	20.07	19.52
			25	20.50	20.23	19.95	19.50
			50	20.50	20.22	19.69	19.41
	100	0	20.50	20.29	19.92	19.51	
	16QAM	1	0	20.50	20.48	19.86	19.51
			50	21.00	20.80	20.28	19.93
			99	20.50	20.18	19.63	19.20
		50	0	19.50	19.39	19.11	18.55
			25	19.50	19.28	19.00	18.61
			50	19.50	19.25	18.79	18.45
		100	0	19.50	19.39	18.99	18.57

Band 26

LTE-TDD Band 26c				Maximum Tune-up(dBm)	Conducted Power(dBm)				
Bandwidth	Modulation	RB allocation	RB offset		26765	26865	26965		
					821.5MHz	831.5MHz	841.5MHz		
15MHz	QPSK	1	0	23.00	22.57	22.64	22.49		
			38	23.00	22.81	22.68	22.74		
			74	23.00	22.58	22.46	22.46		
		36	0	22.00	21.77	21.73	21.72		
			18	22.00	21.82	21.76	21.78		
			39	22.00	21.83	21.65	21.63		
		75	0	22.00	21.82	21.69	21.65		
			16QAM	1	0	22.50	22.02	21.66	21.63
					38	22.50	22.12	22.04	21.68
	74	22.00			21.89	21.68	21.50		
	36	0		21.00	20.80	20.69	20.68		
		18		21.00	20.82	20.77	20.72		
		39		21.00	20.83	20.57	20.57		
	75	0		21.00	20.79	20.68	20.65		

Band 41

Bandwidth	Modulation	RB allocation	RB offset	Maximum Tune-up(dBm)	39750	40620	41490	
					2506.0MHz	2593.0MHz	2680.0MHz	
20MHz	QPSK	1	0	23.00	22.96	21.98	21.90	
			50	23.50	23.30	22.48	22.54	
			99	23.00	22.67	21.90	22.67	
		50	0	22.00	21.94	21.15	21.37	
			25	22.00	21.96	21.16	21.52	
			50	22.00	21.85	21.13	21.71	
		100	0	22.00	21.89	21.11	21.46	
		16QAM	1	0	22.00	21.74	20.87	20.92
				50	22.50	22.03	21.42	21.72
	99			22.00	21.48	20.81	21.70	
	50		0	21.00	20.86	19.60	20.30	
			25	21.00	20.91	19.70	20.51	
			50	21.00	20.71	19.62	20.67	
	100	0	21.00	20.86	19.57	20.52		

Band 66

Bandwidth	Modulation	RB allocation	RB offset	Maximum Tune-up(dBm)	39750	40620	41490	
					2506.0MHz	2593.0MHz	2680.0MHz	
20MHz	QPSK	1	0	23.00	22.96	21.98	21.90	
			50	23.50	23.30	22.48	22.54	
			99	23.00	22.67	21.90	22.67	
		50	0	22.00	21.94	21.15	21.37	
			25	22.00	21.96	21.16	21.52	
			50	22.00	21.85	21.13	21.71	
		100	0	22.00	21.89	21.11	21.46	
		16QAM	1	0	22.00	21.74	20.87	20.92
				50	22.50	22.03	21.42	21.72
	99			22.00	21.48	20.81	21.70	
	50		0	21.00	20.86	19.60	20.30	
			25	21.00	20.91	19.70	20.51	
			50	21.00	20.71	19.62	20.67	
	100	0	21.00	20.86	19.57	20.52		

Band 71

Bandwidth	Modulation	RB allocation	RB offset	Maximum Tune-up(dBm)	133222	133322	133372	
					673.0MHz	683.0MHz	688.0MHz	
20MHz	QPSK	1	0	21.50	21.28	21.25	21.17	
			50	22.00	21.71	21.52	21.53	
			99	21.50	21.24	21.18	21.27	
		50	0	21.00	20.54	20.40	20.53	
			25	21.00	20.57	20.47	20.43	
			50	21.00	20.58	20.44	20.51	
		100	0	21.00	20.53	20.42	20.48	
		16QAM	1	0	21.00	20.63	20.25	19.99
				50	21.50	21.05	20.51	20.38
	99			21.00	20.62	20.19	20.08	
	50		0	19.50	19.46	19.39	19.47	
			25	20.00	19.54	19.44	19.42	
			50	20.00	19.53	19.42	19.43	
	100	0	19.50	19.49	19.39	19.45		

9.1 Wi-Fi

Band (GHz)	Mode	Channel	Freq. (MHz)	Average Power (dBm)	Maximum Tune-up(dBm)	SAR Test Require.
2.4g Wifi (2.4~2.4835)	802.11b	1	2412	16.12	16.50	No
		6	2437	16.38	16.50	Yes
		11	2462	16.31	16.50	No
	802.11g	1	2412	14.37	14.50	No
		6	2437	14.67	15.00	No
		11	2462	14.81	15.00	No
	802.11n(HT20)	1	2412	14.71	15.00	No
		6	2437	14.65	15.00	No
		11	2462	14.89	15.00	No
	802.11n(HT40)	3	2422	14.98	15.00	No
		6	2437	14.86	15.00	No
		9	2452	14.70	15.00	No

5G

Band (GHz)	Mode	Channel	Freq. (MHz)	Average Power (dBm)	Maximum Tune-up(dBm)	SAR Test Require.
U-NII-1 (5.150~5.250)	802.11a	36	5180	10.31	10.50	No
		40	5200	10.13	10.50	No
		48	5240	9.70	10.00	No
	802.11n(HT20)	36	5180	10.37	10.50	No
		40	5200	10.03	10.50	No
		48	5240	9.75	10.00	No
	802.11ac(VHT20)	36	5180	10.47	10.50	No
		40	5200	10.05	10.50	No
		48	5240	9.78	10.00	No
	802.11n(HT40)	38	5190	10.88	11.00	Yes
		46	5230	10.32	10.50	No
	802.11ac(VHT40)	38	5190	10.88	11.00	No
		46	5230	10.36	10.50	No

Band (GHz)	Mode	Channel	Freq. (MHz)	Average Power (dBm)	Maximum Tune-up(dBm)	SAR Test Require.
U-NII-3 (5.725~5.850)	802.11a	149	5745	11.39	11.50	No
		157	5785	11.47	11.50	No
		165	5825	12.14	12.50	No
	802.11n(HT20)	149	5745	11.43	11.50	No
		157	5785	11.69	12.00	No
		165	5825	12.13	12.50	No
	802.11ac(VHT20)	149	5745	11.37	11.50	No
		157	5785	11.44	11.50	No
		165	5825	12.09	12.50	No
	802.11n(HT40)	151	5755	12.17	12.50	No
		159	5795	12.33	12.50	No
	802.11ac(VHT40)	151	5755	12.27	12.50	No
		159	5795	12.56	13.00	Yes

10. Low-Power Exemption

10.1 Tune-up Power

Mode	Tune-up Power (dBm)
GSM 850	31.00
GSM 1900	29.50
WCDMA II	21.00
WCDMA IV	21.50
WCDMA V	22.00
LTE Band 2	21.50
LTE Band 4	22.00
LTE Band 5	22.50
LTE Band 12	22.00
LTE Band 13	22.50
LTE Band 17	22.00
LTE Band 25	21.50
LTE Band 26	23.00
LTE Band 41	23.50
LTE Band 66	22.50
LTE Band 71	22.00
2.4G WIFI	16.50
5.2G WIFI	11.00
5.8G WIFI	13.00
Bluetooth	6.50

10.2 RF Emissions Lower Power Exemption

Mode	Tune-up Power (dBm)	MIF	Power + MIF(dB)	C63.19 Lowest RFAIPL(dBm)	C63.19 Test Required?
GSM 850	31.00	3.63	34.63	26.00	Yes
GSM 1900	29.50	3.63	33.13	26.00	Yes
WCDMA II	21.00	-25.43	-4.43	26.00	No
WCDMA IV	21.50	-25.43	-3.93	26.00	No
WCDMA V	22.00	-25.43	-3.43	26.00	No
LTE Band 2	21.50	-9.76	11.74	25.00	No
LTE Band 4	22.00	-9.76	12.24	25.00	No
LTE Band 5	22.50	-9.76	12.74	25.00	No
LTE Band 12	22.00	-9.76	12.24	25.00	No
LTE Band 13	22.50	-9.76	12.74	25.00	No
LTE Band 17	22.00	-9.76	12.24	25.00	No
LTE Band 25	21.50	-9.76	11.74	25.00	No
LTE Band 26	23.00	-9.76	13.24	25.00	No
LTE Band 41	23.50	-1.44	22.06	25.00	No
LTE Band 66	22.50	-9.76	12.74	25.00	No
LTE Band 71	22.00	-9.76	12.24	25.00	No
2.4G WIFI	16.50	-2.02	14.48	25.00	No
5.2G WIFI	11.00	-5.59	5.41	25.00	No
5.8G WIFI	13.00	-5.57	7.43	25.00	No
Bluetooth	6.50	1.02	7.52	25.00	No

Note:

1. Use maximum power plus worst case MIF to determine whether it complies with RFAIPL
2. If maximum power plus worst case MIF does not comply with RFAIPL, then further evaluation RFAIPL include in section 11.2.
3. EDGE data modes is not necessary due the GSM Voice mode is the worst case.
4. According to ANSI C63.19 2019, if maximum power plus worst case MIF is complies with RFAIPL, means compliance with WD emission requirements.

11. Test Equipment List

Description	Manufacturer	Model	Serial No./Version	Cal. Date	Cal. Due
PC	Dell	N/A	N/A	N/A	N/A
Test Software	MVG	N/A	OpenHAC V5.1.3	N/A	N/A
COMOHAC E-field Probe	MVG	SCE	07/22 EPH50	2024/02/06	2025/02/05
COMOHAC 800-950MHz reference dipole	MVG	SIDB835	07/22 DHA69	2023/02/06	2025/02/05
COMOHAC 1700-2000MHz reference dipole	MVG	SIDB1900	07/22 DHB70	2023/02/06	2025/02/05
6 1/2 Digital Multimeter	Keithley	DMM6500	4527164	2023/11/16	2024/11/15
MXG Vector Signal Generator	Agilent	N5182A	MY46240163	2023/11/16	2024/11/15
E-Series Avg. Power Sensor	KEYSIGHT	E9300A	MY55050017	2024/03/24	2025/03/23
EPM Series Power Meter	KEYSIGHT	E4418B	MY41293435	2024/03/24	2025/03/23
10DB Attenuator	MIDWEST MICROWAVE	263-10dB	/	2024/03/24	2025/03/23
Coupler	MERRIMAC	CWM-10R-10.8G	LOT-83391	2024/03/24	2025/03/23
Wideband Radio Communication Tester	ROHDE & SCHWARZ	CMW500	161997	2023/11/16	2024/11/15

ANNEX A HAC RF System Validation Result

E-Field Scan						
Mode	Frequency (MHz)	Input Power (mW)	Measured Value (dBV/m)	Target Value (dBV/m)	Deviation (%)	Limit (%)
CW	835	100	215.88	210.0	-2.80	±25
CW	1900	100	146.86	146.1	-0.52	±25

System check at 835.00 MHz

Date of measurement: 07/4/2024

Experimental Conditions

Probe	SN_0722_EPH50
Signal	CW
Band	CW835
Channels	middle
Frequency (MHz)	835.00

Results

E-field average [dB(V/m)]	215.88
Right E-field maximum [dB(V/m)]	215.56
Left E-field maximum [dB(V/m)]	216.51

Scan parameter

Scan area: length (mm), width (mm)	20.00, 80.00
Measurement point spacing (mm)	5
distance to reference plane (mm)	10.00
X and Y offset with the reference point (mm)	0.00, 0.00
Number of measurement points	85

RF audio interference near field

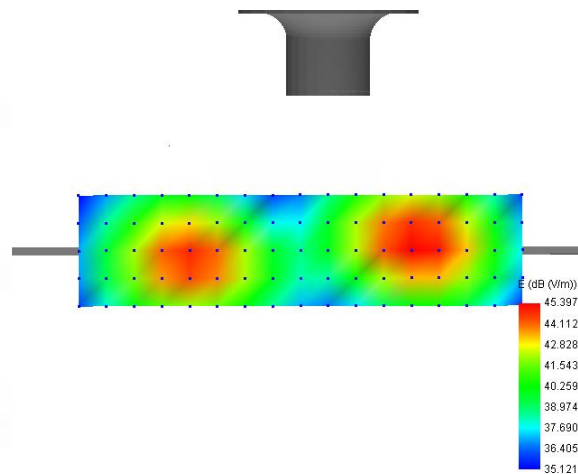

System check at 1900.00 MHz

Date of measurement: 07/4/2024

Experimental Conditions

Probe	SN_0722_EPH50
Signal	CW
Band	CW1900
Channels	middle
Frequency (MHz)	1900.00

Results

E-field average [dB(V/m)]	146.86
Right E-field maximum [dB(V/m)]	146.32
Left E-field maximum [dB(V/m)]	147.91

Scan parameter

Scan area: length (mm), width (mm)	20.00, 80.00
Measurement point spacing (mm)	5
distance to reference plane (mm)	10.00
X and Y offset with the reference point (mm)	0.00, 0.00
Number of measurement points	85

RF audio interference near field

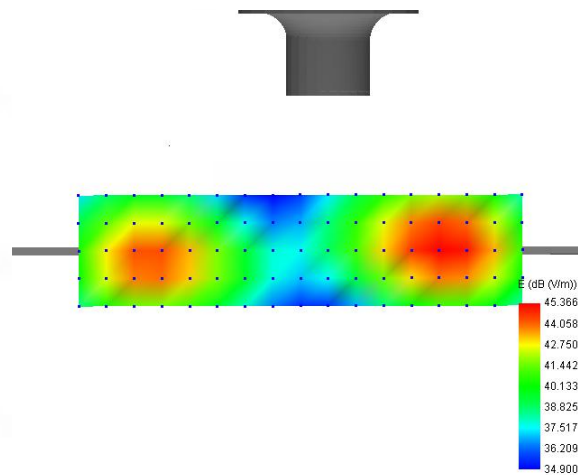

ANNEX B HAC RF Measurement Result

Band	Channel	Frequency (MHz)	RF audio interference level [dB(V/m)]	Device compliant	Plot
GSM850	Low (128)	824.2MHz	24.37	Yes	/
	Middle(190)	836.6MHz	25.72	Yes	/
	High(251)	848.8MHz	26.00	Yes	1#
GSM1900	Low (512)	1850.2MHz	23.22	Yes	2#
	Middle(661)	1880.0MHz	21.44	Yes	/
	High(810)	1909.8MHz	20.08	Yes	/

Measurement at GSM850

Date of measurement: 07/4/2024

Experimental Conditions

Probe	SN_0722_EPH50
Signal	GSM
Band	GSM850
Channels	high
Channels Number	251
Frequency (MHz)	848.80
MIF	3.30

Results

RF audio interference level [dB(V/m)]	26.00
Device compliant	Yes
Measurement status	Complete

Scan parameter

Scan area: length (mm), width (mm)	50.00, 50.00
Measurement point spacing (mm)	10
distance to reference plane (mm)	15.00
X and Y offset with the reference point (mm)	0.00, 0.00
Number of measurement points	36

RF audio interference near field

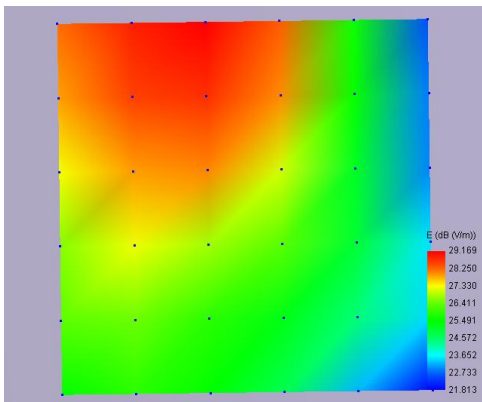

Measurement at GSM1900

Date of measurement: 07/4/2024

Experimental Conditions

Probe	SN_0722_EPH50
Signal	GSM
Band	GSM1900
Channels	low
Channels Number	512
Frequency (MHz)	1850.20
MIF	3.30

Results

RF audio interference level [dB(V/m)]	23.22
Device compliant	Yes
Measurement status	Complete

Scan parameter

Scan area: length (mm), width (mm)	50.00, 50.00
Measurement point spacing (mm)	10
distance to reference plane (mm)	15.00
X and Y offset with the reference point (mm)	0.00, 0.00
Number of measurement points	36

RF audio interference near field

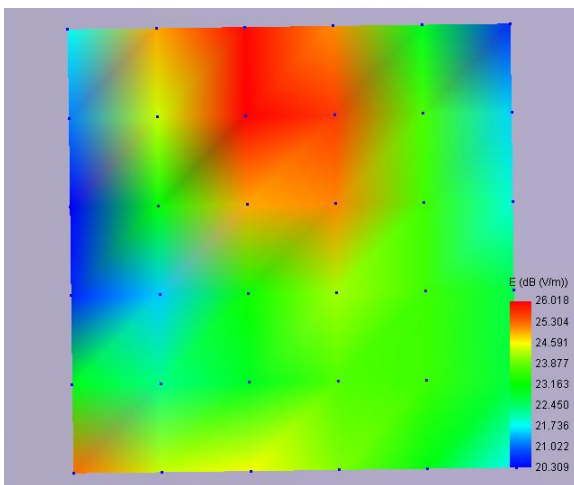

ANNEX C Test Setup Photos



ANNEX D EUT External & Internal Photos

Please refer to RF Report.

ANNEX E Calibration Information

Please refer to the document "Calibration.pdf".



BTF Testing Lab (Shenzhen) Co., Ltd.

F101, 201 and 301, Building 1, Block 2, Tantou Industrial Park, Tantou Community, Songgang Street,
Bao'an District, Shenzhen, China

www.btf-lab.com

--END OF REPORT--