

---

# FCC Test Report

---

Report No.: AGC04482151101FE03

**FCC ID** : 2ADK3XO-8967  
**APPLICATION PURPOSE** : Original Equipment  
**PRODUCT DESIGNATION** : Classic Bluetooth Speaker  
**BRAND NAME** : N/A  
**MODEL NAME** : XO-8967  
**CLIENT** : XING DA INTERNATIONAL ELECTRONICS LIMITED  
**DATE OF ISSUE** : Nov.24,2015  
**STANDARD(S)** : FCC Part 15 Rules  
**TEST PROCEDURE(S)**  
**REPORT VERSION** : V1.0

Attestation of Global Compliance (Shenzhen) Co., Ltd



**CAUTION:**

This report shall not be reproduced except in full without the written permission of the test laboratory and shall not be quoted out of context.



### Report Revise Record

Report Version	Revise Time	Issued Date	Valid Version	Notes
V1.0	/	Nov.24,2015	Valid	Original Report

## TABLE OF CONTENTS

<b>1. VERIFICATION OF CONFORMITY .....</b>	<b>4</b>
<b>2. GENERAL INFORMATION .....</b>	<b>5</b>
2.1. PRODUCT DESCRIPTION.....	5
2.2. TABLE OF CARRIER FREQUENCYS.....	5
<b>3. MEASUREMENT UNCERTAINTY.....</b>	<b>6</b>
<b>4. DESCRIPTION OF TEST MODES.....</b>	<b>6</b>
<b>5. SYSTEM TEST CONFIGURATION .....</b>	<b>7</b>
5.1. CONFIGURATION OF EUT SYSTEM .....	7
5.2. EQUIPMENT USED IN EUT SYSTEM .....	7
5.3. SUMMARY OF TEST RESULTS .....	7
<b>6. TEST FACILITY .....</b>	<b>8</b>
<b>7. ALL TEST EQUIPMENT LIST .....</b>	<b>8</b>
<b>8. RADIATED EMISSION .....</b>	<b>10</b>
8.1TEST LIMIT.....	10
8.2. MEASUREMENT PROCEDURE .....	11
8.3. TEST SETUP.....	13
8.4. TEST RESULT .....	15
<b>9. BAND EDGE EMISSION .....</b>	<b>28</b>
9.1. MEASUREMENT PROCEDURE .....	28
9.2 TEST SETUP .....	28
9.3 RADIATED TEST RESULT .....	29
<b>10. 20DB BANDWIDTH.....</b>	<b>33</b>
10.1. MEASUREMENT PROCEDURE .....	33
10.2. TEST SET-UP .....	33
10.3. LIMITS AND MEASUREMENT RESULTS.....	33
<b>11. FCC LINE CONDUCTED EMISSION TEST .....</b>	<b>40</b>
11.1. LIMITS OF LINE CONDUCTED EMISSION TEST .....	40
11.2. BLOCK DIAGRAM OF LINE CONDUCTED EMISSION TEST.....	40
11.3. PRELIMINARY PROCEDURE OF LINE CONDUCTED EMISSION TEST .....	41
11.4. FINAL PROCEDURE OF LINE CONDUCTED EMISSION TEST.....	41
11.5. TEST RESULT OF LINE CONDUCTED EMISSION TEST.....	42
<b>APPENDIX A: PHOTOGRAPHS OF TEST SETUP .....</b>	<b>44</b>
<b>APPENDIX B: PHOTOGRAPHS OF EUT .....</b>	<b>46</b>

**1. VERIFICATION OF CONFORMITY**

<b>Applicant</b>	XING DA INTERNATIONAL ELECTRONICS LIMITED
<b>Address</b>	#98 LiWu Swan Industrial District, Qiao Tou Town, Dong Guan, Guang Dong, China
<b>Manufacturer</b>	XING DA INTERNATIONAL ELECTRONICS LIMITED
<b>Address</b>	#98 LiWu Swan Industrial District, Qiao Tou Town, Dong Guan, Guang Dong, China
<b>Product Designation</b>	Classic Bluetooth Speaker
<b>Brand Name</b>	N/A
<b>Test Model</b>	XO-8967
<b>Date of test</b>	Nov.07,2015 Nov.10,2015
<b>Deviation</b>	None
<b>Condition of Test Sample</b>	Normal
<b>Report Template</b>	AGCRT-US-BR/RF

We hereby certify that:

The above equipment was tested by Dongguan Precise Testing Service Co., Ltd. The test data, data evaluation, test procedures, and equipment configurations shown in this report were made in accordance with the procedures given in ANSI C63.4 (2009) and the energy emitted by the sample EUT tested as described in this report is in compliance with radiated emission limits of FCC Rules Part 15.249.

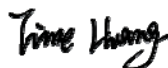
Tested By   
Time Huang(Huang Nanhui) Nov.24,2015

Reviewed By   
Forrest Lei(Lei Yonggang) Nov.24,2015

Approved By   
Solger Zhang(Zhang Hongyi)  
Authorized Officer Nov.24,2015

## 2. GENERAL INFORMATION

### 2.1. PRODUCT DESCRIPTION

A major technical description of EUT is described as following

<b>Operation Frequency</b>	2.402 GHz to 2.480GHz
<b>RF Output Power</b>	-2.75dBm(Max)
<b>Bluetooth Version</b>	V2.1+EDR
<b>Modulation</b>	GFSK, $\pi/4$ -DQPSK, 8DPSK
<b>Number of channels</b>	79
<b>Hardware Version</b>	8967-AC4605-V1.2
<b>Software Version</b>	N/A
<b>Antenna Designation</b>	PCB Antenna (Met 15.203 Antenna requirement)
<b>Antenna Gain</b>	0dBi
<b>Power Supply</b>	DC 3.7V by battery

Note: The USB port only used for charging and can't be used to transfer data with PC.

### 2.2. TABLE OF CARRIER FREQUENCIES

Frequency Band	Channel Number	Frequency
2400~2483.5MHZ	0	2402MHZ
	1	2403MHZ
	:	:
	38	2440 MHZ
	39	2441 MHZ
	40	2442 MHZ
	:	:
	77	2479 MHZ
	78	2480 MHZ

### 3. MEASUREMENT UNCERTAINTY

The reported uncertainty of measurement  $y \pm U$ , where expanded uncertainty  $U$  is based on a standard uncertainty multiplied by a coverage factor of  $k=2$ , providing a level of confidence of approximately 95 %.

No.	Item	Uncertainty
1	Conducted Emission Test	$\pm 3.18\text{dB}$
2	All emissions, radiated	$\pm 3.91\text{dB}$
3	Temperature	$\pm 0.5^\circ\text{C}$
4	Humidity	$\pm 2\%$

### 4. DESCRIPTION OF TEST MODES

NO.	TEST MODE DESCRIPTION
1	Low channel GFSK
2	Middle channel GFSK
3	High channel GFSK
4	Low channel $\pi/4$ -DQPSK
5	Middle channel $\pi/4$ -DQPSK
6	High channel $\pi/4$ -DQPSK
7	Low channel 8DPSK
8	Middle channel 8DPSK
9	High channel 8DPSK
10	BT Link with charging

Note:

1. Only the result of the worst case was recorded in the report, if no other cases.
2. For Radiated Emission, 3axis were chosen for testing for each applicable mode.
3. The EUT used fully-charged battery when tested.

## 5. SYSTEM TEST CONFIGURATION

### 5.1. CONFIGURATION OF EUT SYSTEM

Configure 1: (Normal hopping)

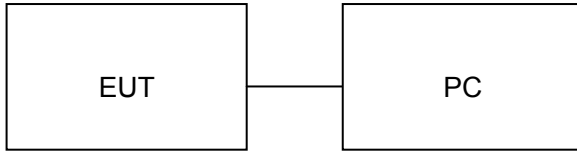

Configure 2: (Control continuous TX)

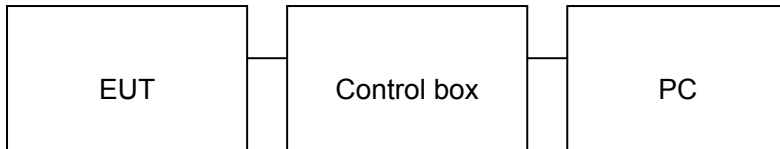

### 5.2. EQUIPMENT USED IN EUT SYSTEM

Item	Equipment	Model No.	ID or Specification	Remark
1	Classic Bluetooth Speaker	N/A	XO-8967	EUT
2	Control box	N/A	N/A	A.E
3	PC	SONY	E1412AYCW	A.E
4	USB Cable	N/A	0.4m, unshielded	A.E

### 5.3. SUMMARY OF TEST RESULTS

FCC RULES	DESCRIPTION OF TEST	RESULT
§15.249	Radiated Emission	Compliant
§15.249	Band Edges	Compliant
§15.207	Conduction Emission	Compliant
N/A	BANDWIDTH	Compliant

## 6. TEST FACILITY

<b>Site</b>	Dongguan Precise Testing Service Co., Ltd.
<b>Location</b>	Building D,Baoding Technology Park,Guangming Road2,Dongcheng District, Dongguan, Guangdong, China,
<b>FCC Registration No.</b>	371540
<b>Description</b>	The test site is constructed and calibrated to meet the FCC requirements in documents ANSI C63.4:2009.

## 7. ALL TEST EQUIPMENT LIST

FOR RADIATED EMISSION TEST (BELOW 1GHZ)

Radiated Emission Test Site					
Name of Equipment	Manufacturer	Model Number	Serial Number	Last Calibration	Due Calibration
EMI Test Receiver	Rohde & Schwarz	ESCI	101417	July 4, 2015	July 3, 2016
Trilog Broadband Antenna (25M-1GHz)	SCHWARZBECK	VULB9160	9160-3355	July 4, 2015	July 3, 2016
Signal Amplifier	SCHWARZBECK	BBV 9475	9745-0013	July 4, 2015	July 3, 2016
RF Cable	SCHWARZBECK	AK9515E	96221	July 4, 2015	July 3, 2016
3m Anechoic Chamber	CHENGYU	966	PTS-001	June 6, 2015	June 5, 2016
MULTI-DEVICE Positioning Controller	Max-Full	MF-7802	MF780208339	N/A	N/A
Active loop antenna (9K-30MHz)	Schwarzbeck	FMZB1519	1519-038	June 6, 2015	June 5, 2016
Spectrum analyzer	Agilent	E4407B	MY46185649	June 6, 2015	June 5, 2016

FOR RADIATED EMISSION TEST (1GHZ ABOVE)

Radiated Emission Test Site					
Name of Equipment	Manufacturer	Model Number	Serial Number	Last Calibration	Due Calibration
EMI Test Receiver	Rohde & Schwarz	ESCI	101417	July 4, 2015	July 3, 2016
Horn Antenna (1G-18GHz)	SCHWARZBECK	BBHA9120D	9120D-1246	July 11, 2015	July 10, 2016
Spectrum Analyzer	Agilent	E4411B	MY4511453	July 4, 2015	July 3, 2016
Signal Amplifier	SCHWARZBECK	BBV 9718	9718-269	July 7, 2015	July 6, 2016
RF Cable	SCHWARZBECK	AK9515H	96220	July 8, 2015	July 7, 2016
3m Anechoic Chamber	CHENGYU	966	PTS-001	June 6, 2015	June 5, 2016
MULTI-DEVICE Positioning Controller	Max-Full	MF-7802	MF780208339	N/A	N/A
Horn Ant (18G-40GHz)	Schwarzbeck	BBHA 9170	9170-181	June 6, 2015	June 5, 2016



<b>Conducted Emission Test Site</b>					
<b>Name of Equipment</b>	<b>Manufacturer</b>	<b>Model Number</b>	<b>Serial Number</b>	<b>Last Calibration</b>	<b>Due Calibration</b>
EMI Test Receiver	- Rohde & Schwarz	ESCI	101417	July 4, 2015	July 3, 2016
Artificial Mains Network	Narda	L2-16B	000WX31025	July 8, 2015	July 7, 2016
Artificial Mains Network (AUX)	Narda	L2-16B	000WX31026	July 8, 2015	July 7, 2016
RF Cable	SCHWARZBECK	AK9515E	96222	July 4, 2015	July 3, 2016
Shielded Room	CHENGYU	843	PTS-002	June 6,2015	June 5,2016

## 8. RADIATED EMISSION

### 8.1 TEST LIMIT

#### Standard FCC15.249

Fundamental Frequency	Field Strength of Fundamental (millivolts/meter)	Field Strength of Harmonics (microvolts/meter)
900-928MHz	50	500
2400-2483.5MHz	50	500
5725-5875MHz	50	500
24.0-24.25GHz	250	2500

#### Standard FCC 15.209

Frequency (MHz)	Distance Meters	Field Strengths Limit	
		$\mu$ V/m	dB( $\mu$ V)/m
0.009 ~ 0.490	300	2400/F(kHz)	---
0.490 ~ 1.705	30	24000/F(kHz)	---
1.705 ~ 30	30	30	---
30 ~ 88	3	100	40.0
88 ~ 216	3	150	43.5
216 ~ 960	3	200	46.0
960 ~ 1000	3	500	54.0
Above 1000	3	Other:74.0 dB( $\mu$ V)/m (Peak) 54.0 dB( $\mu$ V)/m (Average)	

Remark: (1) Emission level dB  $\mu$  V = 20 log Emission level  $\mu$  V/m  
(2) The smaller limit shall apply at the cross point between two frequency bands.  
(3) Distance is the distance in meters between the measuring instrument, antenna and the closest point of any part of the device or system.

## 8.2. MEASUREMENT PROCEDURE

1. Configure the EUT according to ANSI C63.4. The EUT was placed on the top of the turntable 0.8 meter above ground. The phase center of the receiving antenna mounted on the top of a height-variable antenna tower was placed 3 meters far away from the turntable.
2. Power on the EUT and all the supporting units. The turntable was rotated by 360 degrees to determine the position of the highest radiation.
3. The height of the broadband receiving antenna was varied between one meter and four meters above ground to find the maximum emissions field strength of both horizontal and vertical polarization.
4. For each suspected emissions, the antenna tower was scan (from 1 M to 4 M) and then the turntable was rotated (from 0 degree to 360 degrees) to find the maximum reading.
5. Set the test-receiver system to Peak or CISPR quasi-peak Detect Function with specified bandwidth under Maximum Hold Mode.
6. For emissions above 1GHz, use 1.5MHz VBW and RBW for peak reading. Then 1.5MHz RBW and 10Hz VBW for average reading in spectrum analyzer.
7. When the radiated emissions limits are expressed in terms of the average value of the emissions, and pulsed operation is employed, the measurement field strength shall be determined by averaging over one complete pulse train, including blanking intervals, as long as the pulse train does not exceed 0.1 seconds. As an alternative (provided the transmitter operates for longer than 0.1 seconds) or in cases where the pulse train exceeds 0.1 seconds, the measured field strength shall be determined from the average absolute voltage during a 0.1 second interval during which the field strength is at its maximum values.
8. If the emissions level of the EUT in peak mode was 3 dB lower than the average limit specified, then testing will be stopped and peak values of EUT will be reported, otherwise, the emissions which do not have 3 dB margin will be repeated one by one using the quasi-peak method for below 1GHz.
9. For testing above 1GHz, the emissions level of the EUT in peak mode was lower than average limit (that means the emissions level in peak mode also complies with the limit in average mode), then testing will be stopped and peak values of EUT will be reported, otherwise, the emissions will be measured in average mode again and reported.
10. In case the emission is lower than 30MHz, loop antenna has to be used for measurement and the recorded data should be QP measured by receiver. High - Low scan is not required in this case.

The following table is the setting of spectrum analyzer and receiver.

<b>Spectrum Parameter</b>	<b>Setting</b>
Start ~Stop Frequency	9KHz~150KHz/RB 200Hz for QP
Start ~Stop Frequency	150KHz~30MHz/RB 9KHz for QP
Start ~Stop Frequency	30MHz~1000MHz/RB 120KHz for QP
Start ~Stop Frequency	1GHz~26.5GHz 1.5MHz/1.5MHz for Peak, 1.5MHz/10Hz for Average

<b>Receiver Parameter</b>	<b>Setting</b>
Start ~Stop Frequency	9KHz~150KHz/RB 200Hz for QP
Start ~Stop Frequency	150KHz~30MHz/RB 9KHz for QP
Start ~Stop Frequency	30MHz~1000MHz/RB 120KHz for QP

8.3. TEST SETUP

Radiated Emission Test-Setup Frequency Below 30MHz

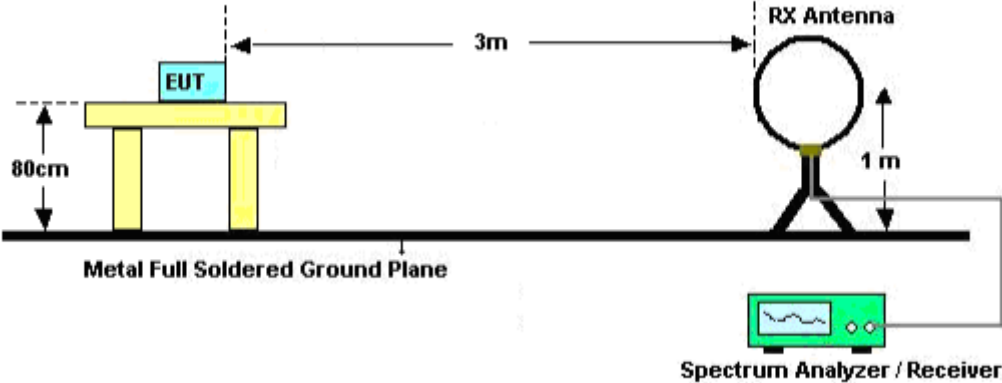

RADIATED EMISSION TEST SETUP 30MHz-1000MHz

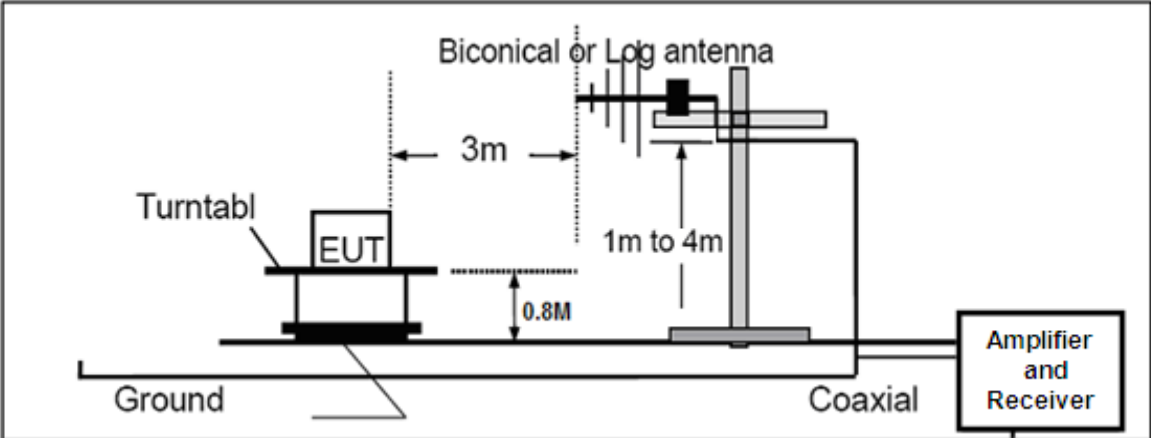

RADIATED EMISSION TEST SETUP ABOVE 1000MHz

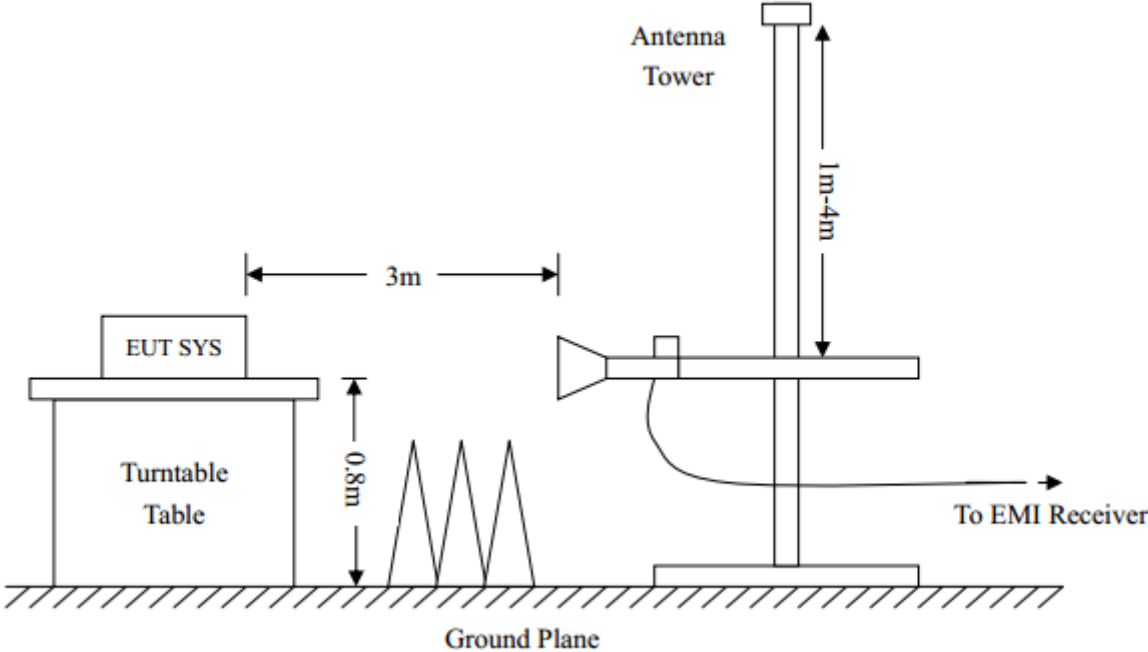

**8.4. TEST RESULT**

**(Worst modulation:GFSK)**

**RADIATED EMISSION BELOW 30MHZ**

No emission found between lowest internal used/generated frequencies to 30MHz.

**RADIATED EMISSION BELOW 1GHZ**

**RADIATED EMISSION TEST- (30MHZ-1GHZ)-LOW CHANNEL-HORIZONTAL**

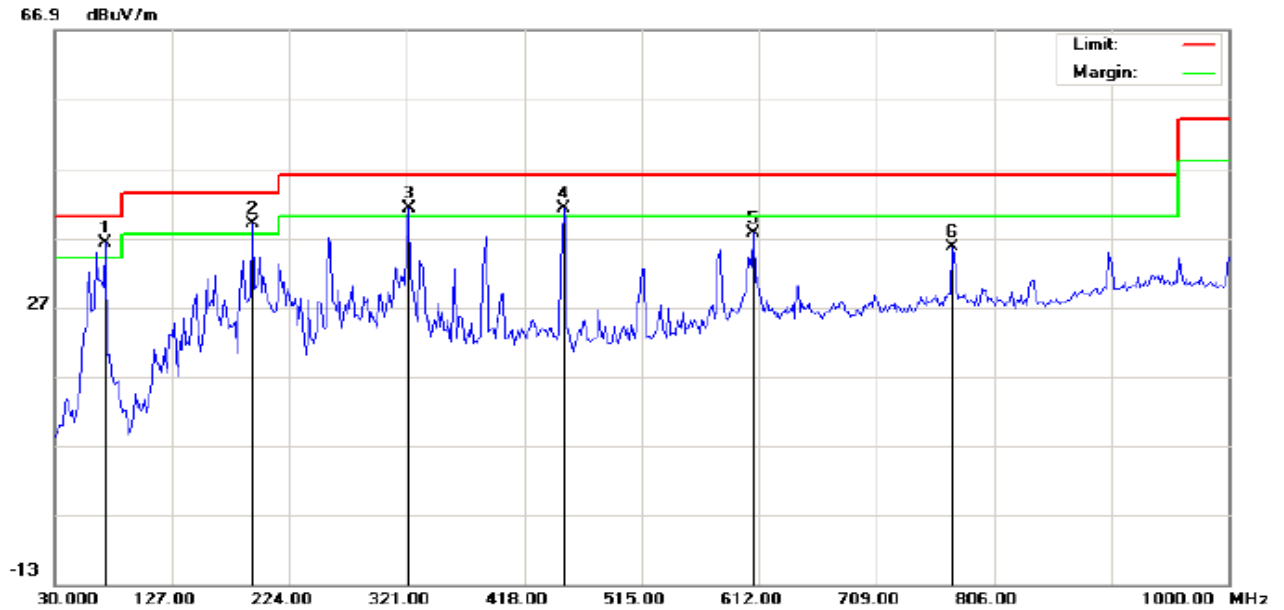

Site: site #1  
Limit: FCC Class B 3M Radiation  
EUT: Classic Bluetooth Speaker  
M/N: XO-8967  
Mode: Low Channel TX  
Note:

Polarization: *Horizontal*  
Power:  
Distance: 3m

Temperature: 22.7  
Humidity: 53.6 %

No.	Mk	Freq.	Reading	Factor	Measurement	Limit	Over	Detector	Antenna Height	Table Degree	Comment
		MHz	dBuV	dB/m	dBuV/m	dBuV/m	dB		cm	degree	
1	*	72.0331	26.06	10.17	36.23	40.00	-3.77	peak			
2	!	193.2832	27.35	11.69	39.04	43.50	-4.46	peak			
3	!	322.6166	24.38	16.92	41.30	46.00	-4.70	peak			
4	!	450.3333	20.58	20.59	41.17	46.00	-4.83	peak			
5		607.1499	13.91	23.75	37.66	46.00	-8.34	peak			
6		772.0499	8.64	26.93	35.57	46.00	-10.43	peak			

**RESULT: PASS**

RADIATED EMISSION TEST- (30MHZ-1GHZ)-LOW CHANNEL -VERTICAL

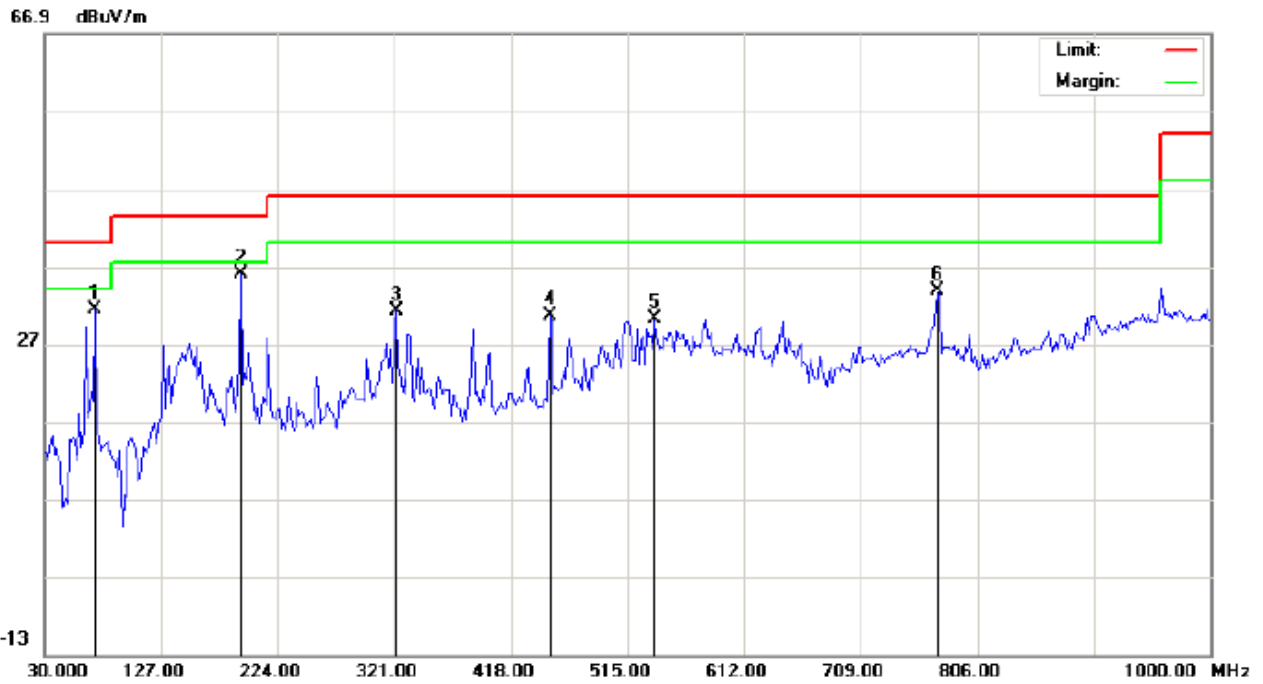

Site: site #1  
Limit: FCC Class B 3M Radiation  
EUT: Classic Bluetooth Speaker  
M/N: XO-8967  
Mode: Low Channel TX  
Note:

Polarization: **Vertical**  
Power:  
Distance: 3m

Temperature: 22.7  
Humidity: 53.6 %

No.	Mk	Freq.	Reading	Factor	Measurement	Limit	Over	Detector	Antenna Height	Table Degree	Comment
		MHz	dBuV	dB/m	dBuV/m	dBuV/m	dB		cm	degree	
1		72.0331	27.64	3.76	31.40	40.00	-8.60	peak			
2	*	193.2832	25.24	10.70	35.94	43.50	-7.56	peak			
3		322.6166	14.19	16.92	31.11	46.00	-14.89	peak			
4		450.3333	9.92	20.59	30.51	46.00	-15.49	peak			
5		537.6332	8.06	22.15	30.21	46.00	-15.79	peak			
6		773.6666	6.86	26.96	33.82	46.00	-12.18	peak			

**RESULT: PASS**

**Note:** 1. Factor=Antenna Factor + Cable loss, Margin=Measurement-Limit.

2. The "Factor" value can be calculated automatically by software of measurement system.



RADIATED EMISSION TEST- (30MHZ-1GHZ)-MIDDLE CHANNEL-HORIZONTAL

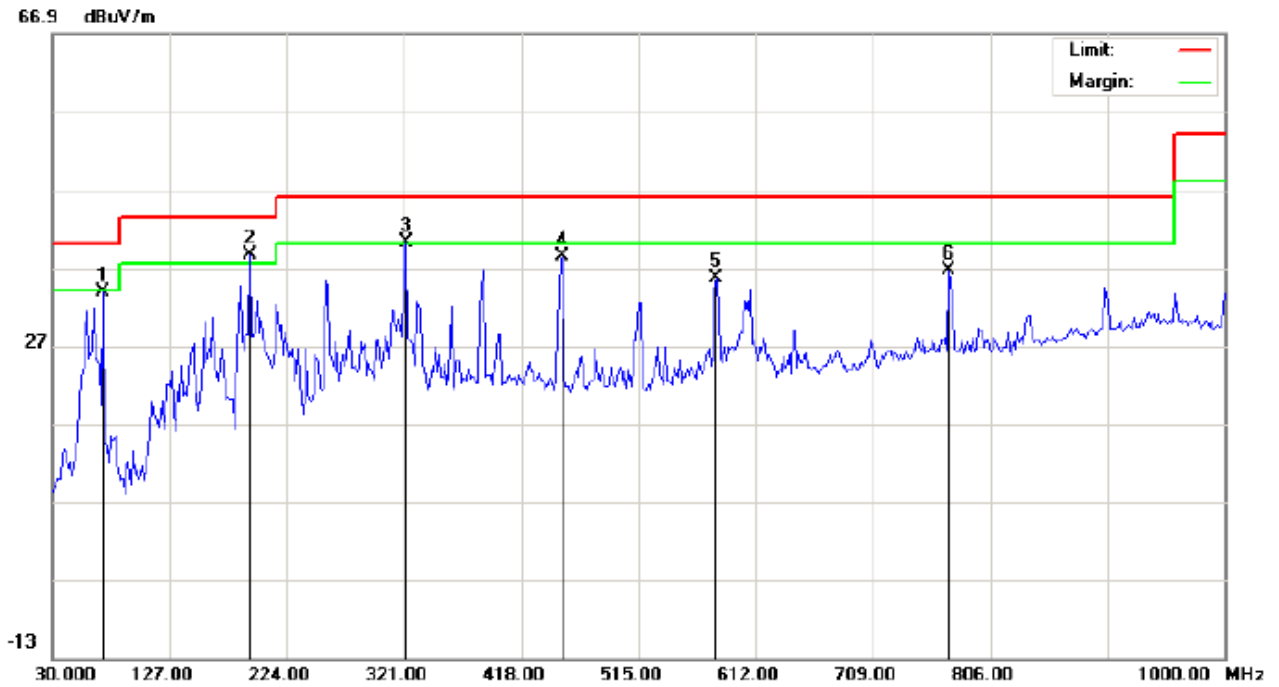

Site: site #1  
 Limit: FCC Class B 3M Radiation  
 EUT: Classic Bluetooth Speaker  
 M/N: XO-8967  
 Mode: Middle Channel TX  
 Note:

Polarization: *Horizontal*  
 Power:  
 Distance: 3m

Temperature: 22.7  
 Humidity: 53.6 %

No.	Mk	Freq.	Reading	Factor	Measurement	Limit	Over	Detector	Antenna Height	Table Degree	Comment
		MHz	dBuV	dB/m	dBuV/m	dBuV/m	dB		cm	degree	
1		72.0331	23.56	10.17	33.73	40.00	-6.27	peak			
2	*	193.2832	26.85	11.69	38.54	43.50	-4.96	peak			
3	!	322.6166	23.38	16.92	40.30	46.00	-5.70	peak			
4		451.9499	17.70	20.61	38.31	46.00	-7.69	peak			
5		579.6666	12.44	23.22	35.66	46.00	-10.34	peak			
6		772.0499	9.64	26.93	36.57	46.00	-9.43	peak			

**RESULT: PASS**

RADIATED EMISSION TEST- (30MHZ-1GHZ)- MIDDLE CHANNEL -VERTICAL

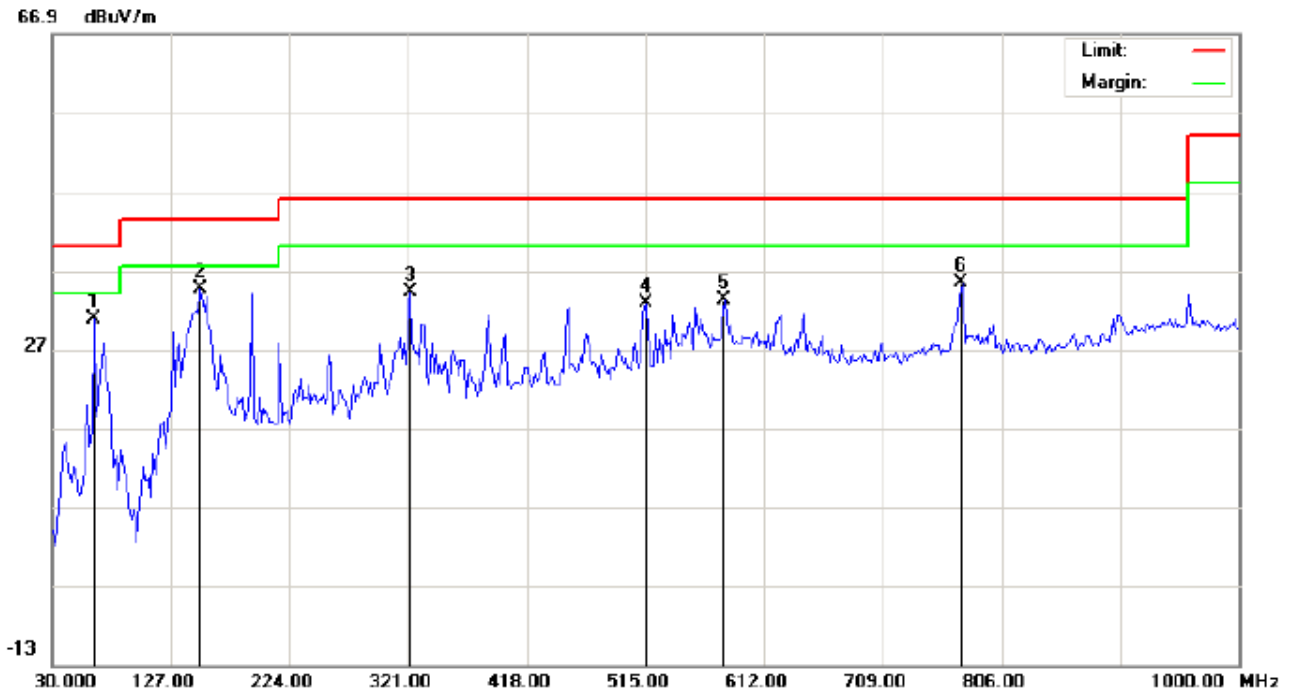

Site: site #1  
Limit: FCC Class B 3M Radiation  
EUT: Classic Bluetooth Speaker  
M/N: XO-8967  
Mode: Middle Channel TX  
Note:

Polarization: *Vertical*  
Power:  
Distance: 3m

Temperature: 22.7  
Humidity: 53.6 %

No.	Mk	Freq.	Reading	Factor	Measurement	Limit	Over	Detector	Antenna Height	Table Degree	Comment
		MHz	dBuV	dB/m	dBuV/m	dBuV/m	dB		cm	degree	
1		63.9500	24.15	6.61	30.76	40.00	-9.24	peak			
2	*	151.2500	19.28	15.27	34.55	43.50	-8.95	peak			
3		322.6166	17.19	16.92	34.11	46.00	-11.89	peak			
4		515.0000	11.19	21.53	32.72	46.00	-13.28	peak			
5		579.6666	10.53	22.63	33.16	46.00	-12.84	peak			
6		773.6666	8.36	26.96	35.32	46.00	-10.68	peak			

**RESULT: PASS**

**Note:** 1. Factor=Antenna Factor + Cable loss, Margin=Measurement-Limit.

2. The "Factor" value can be calculated automatically by software of measurement system.

RADIATED EMISSION TEST- (30MHZ-1GHZ)-HIGH CHANNEL-HORIZONTAL

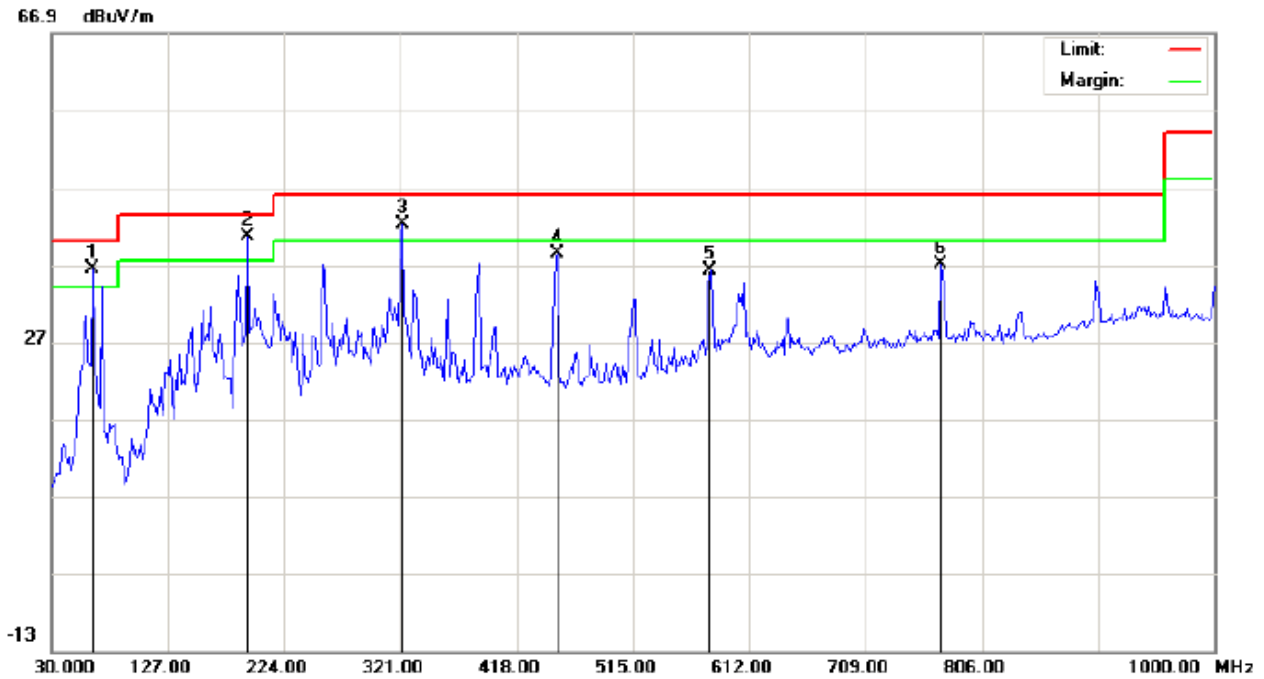

Site: site #1  
Limit: FCC Class B 3M Radiation  
EUT: Classic Bluetooth Speaker  
M/N: XO-8967  
Mode: High Channel TX  
Note:

Polarization: *Horizontal*  
Power:  
Distance: 3m

Temperature: 22.7  
Humidity: 53.6 %

No.	Mk	Freq.	Reading	Factor	Measurement	Limit	Over	Detector	Antenna Height	Table Degree	Comment
		MHz	dBuV	dB/m	dBuV/m	dBuV/m	dB		cm	degree	
1	!	63.9500	25.57	10.80	36.37	40.00	-3.63	peak			
2	*	193.2832	28.85	11.69	40.54	43.50	-2.96	peak			
3	!	322.6166	25.38	16.92	42.30	46.00	-3.70	peak			
4		451.9499	17.70	20.61	38.31	46.00	-7.69	peak			
5		579.6666	12.94	23.22	36.16	46.00	-9.84	peak			
6		772.0499	10.14	26.93	37.07	46.00	-8.93	peak			

**RESULT: PASS**

RADIATED EMISSION TEST- (30MHZ-1GHZ)-HIGH CHANNEL -VERTICAL

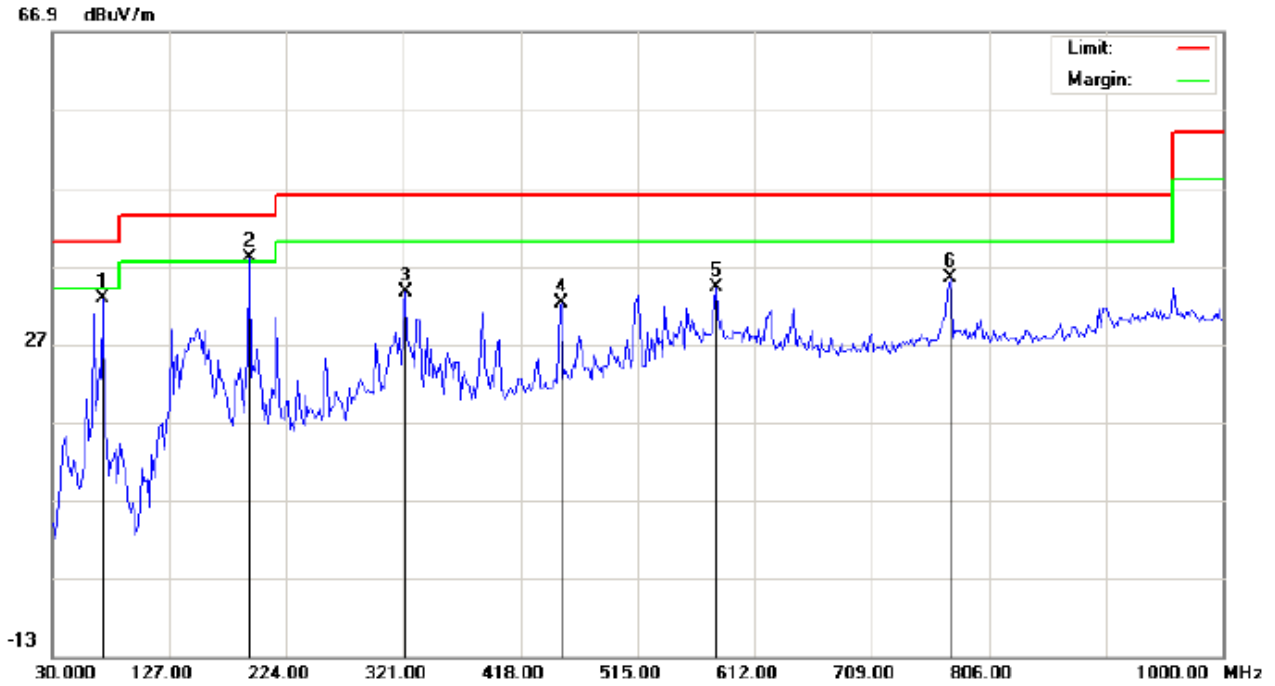

Site: site #1  
Limit: FCC Class B 3M Radiation  
EUT: Classic Bluetooth Speaker  
M/N: XO-8967  
Mode: High Channel TX  
Note:

Polarization: *Vertical*  
Power:  
Distance: 3m

Temperature: 22.7  
Humidity: 53.6 %

No.	Mk	Freq.	Reading	Factor	Measurement	Limit	Over	Detector	Antenna Height	Table Degree	Comment
		MHz	dBuV	dB/m	dBuV/m	dBuV/m	dB		cm	degree	
1		72.0333	29.14	3.76	32.90	40.00	-7.10	peak			
2	*	193.2833	27.24	10.70	37.94	43.50	-5.56	peak			
3		322.6167	16.69	16.92	33.61	46.00	-12.39	peak			
4		451.9500	11.54	20.61	32.15	46.00	-13.85	peak			
5		579.6667	11.53	22.63	34.16	46.00	-11.84	peak			
6		773.6667	8.36	26.96	35.32	46.00	-10.68	peak			

**RESULT: PASS**

**Note:** 1. Factor=Antenna Factor + Cable loss, Margin=Measurement-Limit.

2. The "Factor" value can be calculated automatically by software of measurement system.

**RADIATED EMISSION ABOVE 1GHZ**

**RADIATED EMISSION TEST- (ABOVE 1GHZ)-LOW CHANNEL-HORIZONTAL**

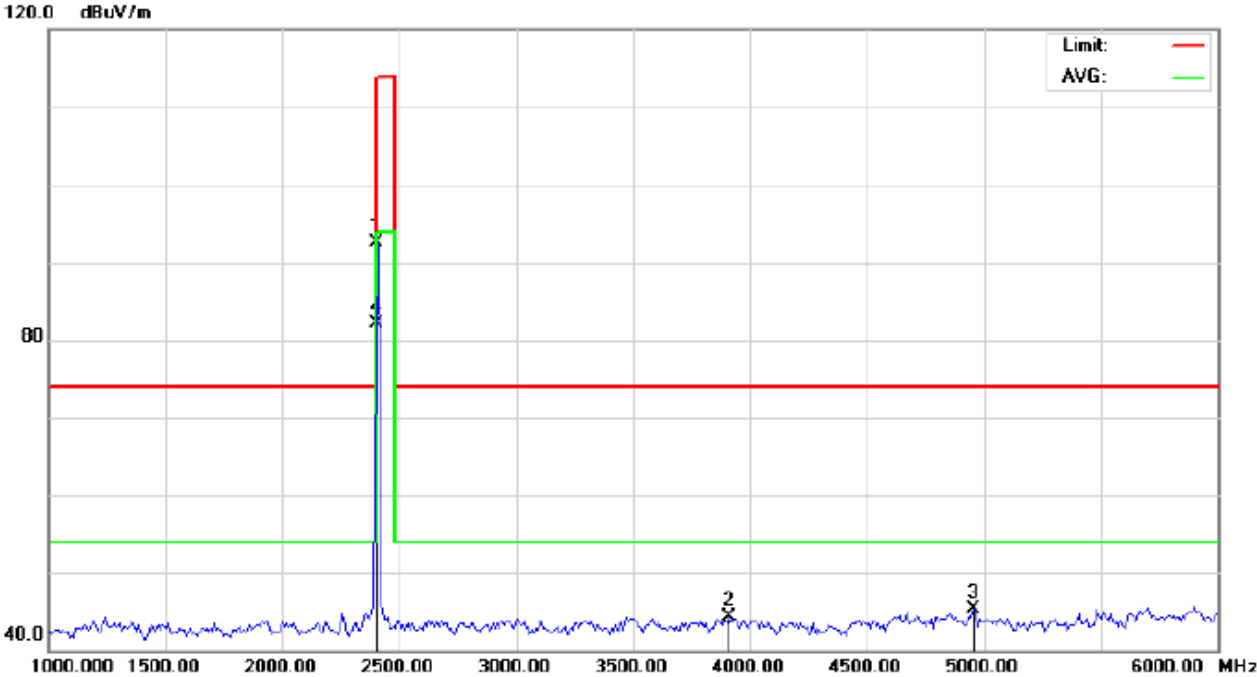

Site: site #1  
Limit: FCC Class B 3M Radiation above 1GHZ(PK)-  
EUT: Classic Bluetooth Speaker  
M/N: XO-8967  
Mode: Low Channel TX  
Note:

Polarization: *Horizontal*  
Power:  
Distance: 3m

Temperature: 26  
Humidity: 60 %

No.	Mk	Freq.	Reading	Factor	Measurement	Limit	Over	Detector	Antenna Height	Table Degree	Comment
		MHz	dBuV	dB/m	dBuV/m	dBuV/m	dB		cm	degree	
1		2402.000	102.16	-9.68	92.48	114.00	-21.52	peak			
2		3908.333	49.69	-5.37	44.32	74.00	-29.68	peak			
3		4958.333	47.12	-1.91	45.21	74.00	-28.79	peak			
4	*	2402.000	91.75	-9.68	82.07	94.00	-11.93	AVG	100	317	

**RESULT: PASS**

RADIATED EMISSION TEST- (ABOVE 1GHZ)-LOW CHANNEL- VERTICAL

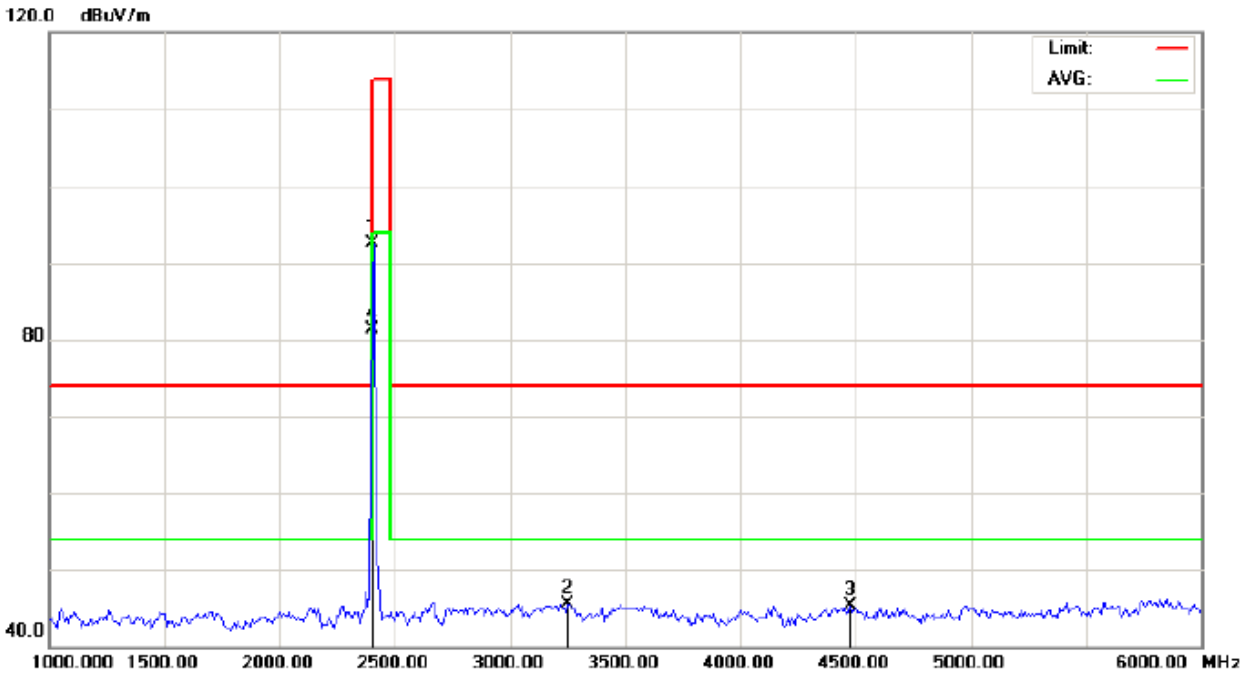

Site: site #1 Polarization: *Vertical* Temperature: 26  
Limit: FCC Class B 3M Radiation above 1GHZ(PK)- Power: Humidity: 60 %  
EUT: Classic Bluetooth Speaker Distance: 3m  
M/N: XO-8967  
Mode: Low Channel TX  
Note:

No.	Mk	Freq.	Reading	Factor	Measurement	Limit	Over	Detector	Antenna Height	Table Degree	Comment
		MHz	dBuV	dB/m	dBuV/m	dBuV/m	dB		cm	degree	
1		2402.000	102.23	-9.68	92.55	114.00	-21.45	peak			
2		3250.000	53.70	-8.12	45.58	74.00	-28.42	peak			
3		4475.000	48.43	-3.19	45.24	74.00	-28.76	peak			
4	*	2402.000	91.01	-9.68	81.33	94.00	-12.67	AVG	100	228	

RESULT: PASS

RADIATED EMISSION TEST- (ABOVE 1GHZ)-MIDDLE CHANNEL-HORIZONTAL

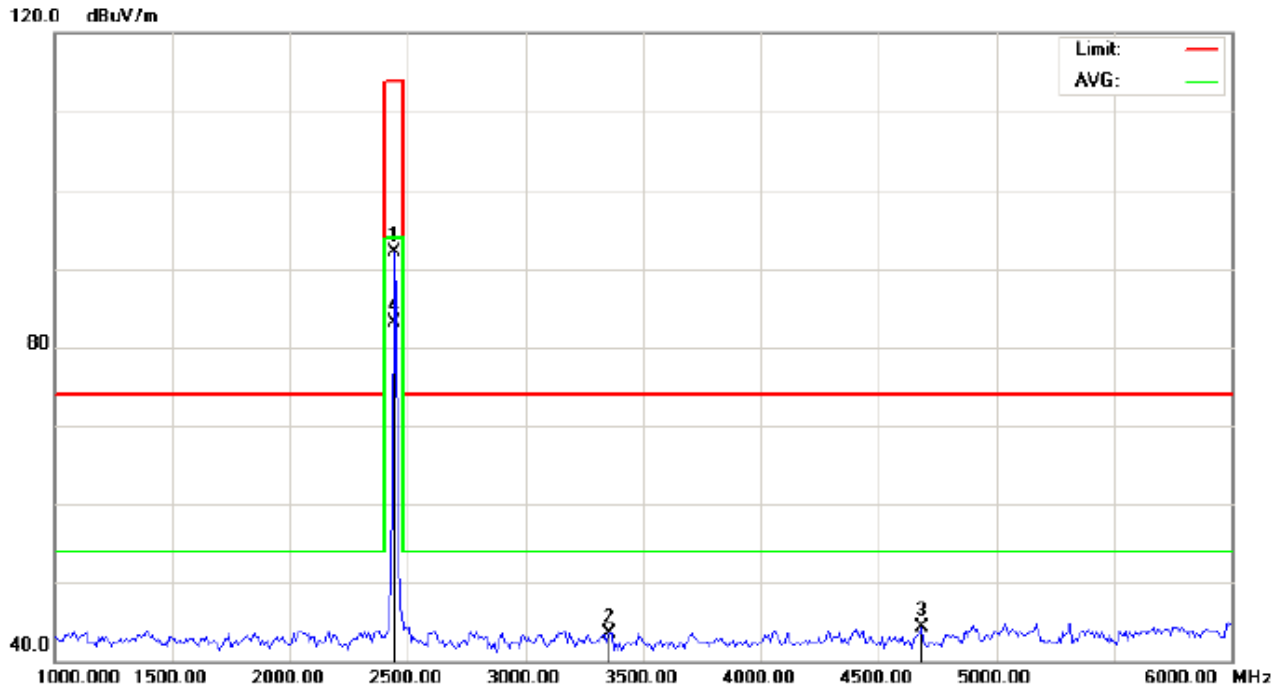

Site: site #1

Polarization: *Horizontal*

Temperature: 26

Limit: FCC Class B 3M Radiation above 1GHZ(PK)-

Power:

Humidity: 60 %

EUT: Classic Bluetooth Speaker

Distance: 3m

M/N: XO-8967

Mode: Middle Channel TX

Note:

No.	Mk	Freq.	Reading	Factor	Measurement	Limit	Over	Detector	Antenna Height	Table Degree	Comment
		MHz	dBuV	dB/m	dBuV/m	dBuV/m	dB		cm	degree	
1		2441.000	101.79	-9.63	92.16	114.00	-21.84	peak			
2		3358.333	51.54	-8.02	43.52	74.00	-30.48	peak			
3		4683.333	47.03	-2.63	44.40	74.00	-29.60	peak			
4	*	2441.000	92.74	-9.63	83.11	94.00	-10.89	AVG	100	319	

RESULT: PASS

RADIATED EMISSION TEST- (ABOVE 1GHZ)-MIDDLE CHANNEL- VERTICAL

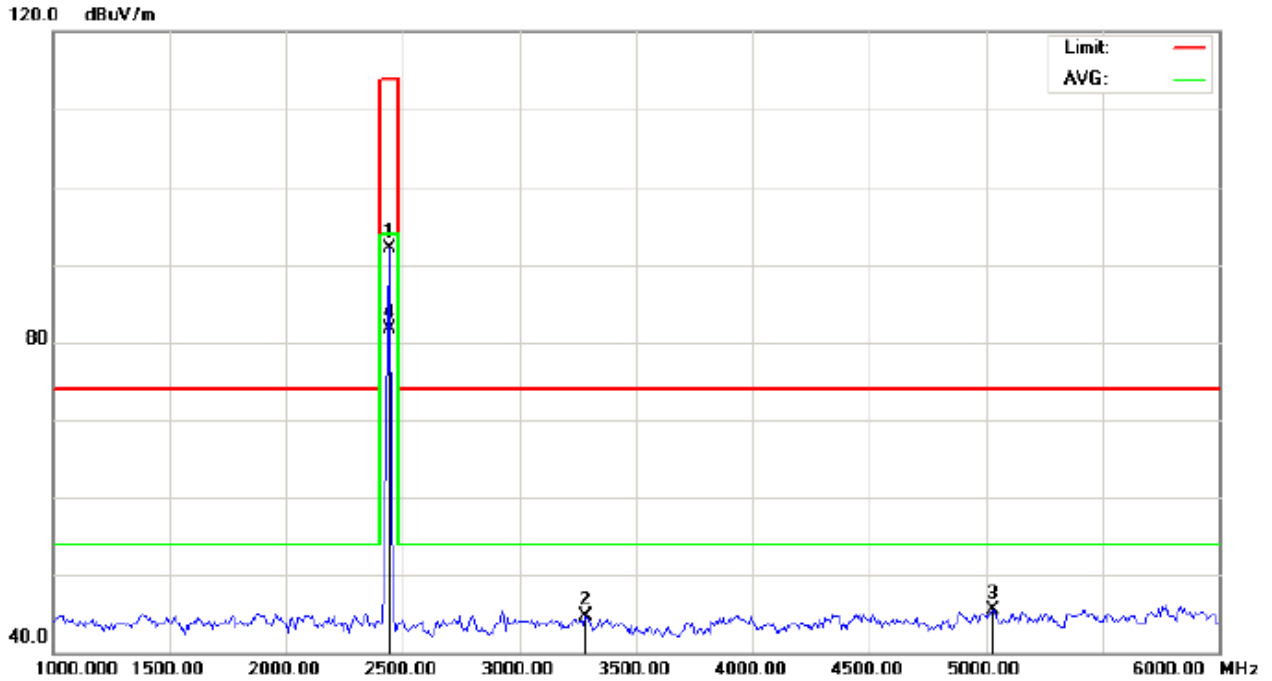

Site: site #1  
Limit: FCC Class B 3M Radiation above 1GHZ(PK)-  
EUT: Classic Bluetooth Speaker  
M/N: XO-8967  
Mode: Middle Channel TX  
Note:

Polarization: *Vertical*  
Power:  
Distance: 3m

Temperature: 26  
Humidity: 60 %

No.	Mk	Freq.	Reading	Factor	Measurement	Limit	Over	Detector	Antenna Height	Table Degree	Comment
		MHz	dBuV	dB/m	dBuV/m	dBuV/m	dB		cm	degree	
1		2441.000	101.73	-9.63	92.10	114.00	-21.90	peak			
2		3283.333	52.80	-8.09	44.71	74.00	-29.29	peak			
3		5033.333	47.30	-1.80	45.50	74.00	-28.50	peak			
4	*	2441.000	91.30	-9.63	81.67	94.00	-12.33	AVG	100	225	

**RESULT: PASS**



RADIATED EMISSION TEST- (ABOVE 1GHZ)-HIGH CHANNEL-HORIZONTAL

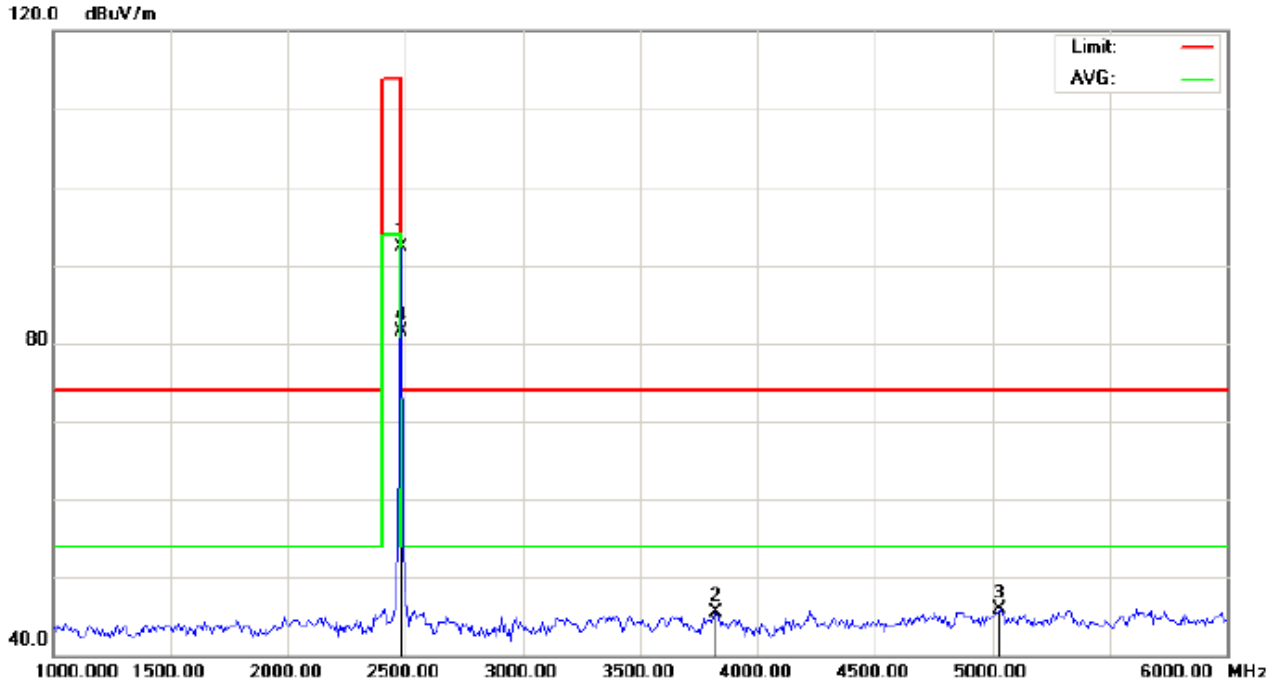

Site: site #1      Polarization: *Horizontal*      Temperature: 26  
 Limit: FCC Class B 3M Radiation above 1GHZ(PK)-      Power:      Humidity: 60 %  
 EUT: Classic Bluetooth Speaker      Distance: 3m  
 M/N: XO-8967  
 Mode: High Channel TX  
 Note:

No.	Mk	Freq.	Reading	Factor	Measurement	Limit	Over	Detector	Antenna Height	Table Degree	Comment
		MHz	dBuV	dB/m	dBuV/m	dBuV/m	dB		cm	degree	
1		2480.000	101.87	-9.59	92.28	114.00	-21.72	peak			
2		3825.000	51.38	-5.89	45.49	74.00	-28.51	peak			
3		5033.333	47.65	-1.80	45.85	74.00	-28.15	peak			
4	*	2480.000	91.13	-9.59	81.54	94.00	-12.46	AVG	100	315	

**RESULT: PASS**

RADIATED EMISSION TEST- (ABOVE 1GHZ)-HIGH CHANNEL- VERTICAL

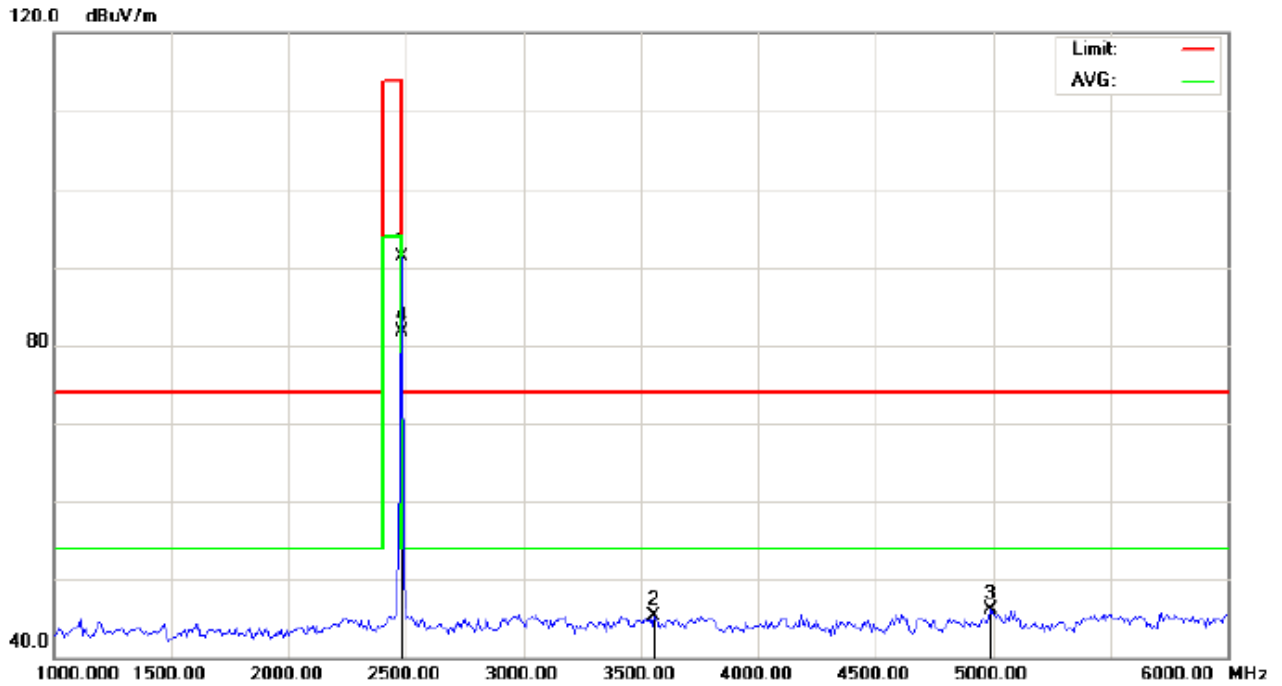

Site: site #1  
Limit: FCC Class B 3M Radiation above 1GHZ(PK)-  
EUT: Classic Bluetooth Speaker  
M/N: XO-8967  
Mode: High Channel TX  
Note:

Polarization: *Vertical*  
Power:  
Distance: 3m

Temperature: 26  
Humidity: 60 %

No.	Mk	Freq.	Reading	Factor	Measurement	Limit	Over	Detector	Antenna	Table	Comment
		MHz	dBuV	dB/m	dBuV/m	dBuV/m	dB		Height	Degree	
									cm	degree	
1		2480.000	100.87	-9.59	91.28	114.00	-22.72	peak			
2		3558.333	52.93	-7.53	45.40	74.00	-28.60	peak			
3		4991.667	47.95	-1.82	46.13	74.00	-27.87	peak			
4	*	2480.000	91.28	-9.59	81.69	94.00	-12.31	AVG	100	219	

**RESULT: PASS**

**Note:** 6~25GHz at least have 20dB margin. No recording in the test report.

Factor=Antenna Factor + Cable loss - Amplifier gain, Margin=Measurement-Limit.

The "Factor" value can be calculated automatically by software of measurement system.

**Field strength of the fundamental signal**

**Peak value**

Frequency	Reading Level	Factor	Measurement	Limit	Over	Antenna
(MHz)	(dBuv)	(dB/m)	(dBuv/m)	(dBuv/m)	(dB)	Polarization
2402	102.16	-9.68	92.48	114	-21.52	Horizontal
2402	102.23	-9.68	92.55	114	-21.45	Vertical
2441	101.79	-9.63	92.16	114	-21.84	Horizontal
2441	101.73	-9.63	92.10	114	-21.90	Vertical
2480	101.87	-9.59	92.28	114	-21.72	Horizontal
2480	100.87	-9.59	91.28	114	-22.72	Vertical

**Average value**

Frequency	Reading Level	Factor	Measurement	Limit	Over	Antenna
(MHz)	(dBuv)	(dB/m)	(dBuv/m)	(dBuv/m)	(dB)	Polarization
2402	91.75	-9.68	82.07	94	-11.93	Horizontal
2402	91.01	-9.68	81.33	94	-12.67	Vertical
2441	92.74	-9.63	83.11	94	-10.89	Horizontal
2441	91.30	-9.63	81.67	94	-12.33	Vertical
2480	91.13	-9.59	81.54	94	-12.46	Horizontal
2480	91.28	-9.59	81.69	94	-12.31	Vertical

### 9. BAND EDGE EMISSION

#### 9.1. MEASUREMENT PROCEDURE

1The EUT operates at hopping-off test mode. The lowest or highest channels are tested to verify the largest transmission and spurious emissions power at the continuous transmission mode.

2Max hold the trace of the setp 1,and the EUT operates at hopping-on test mode to verify the largest spurious emissions power.

3Set the spectrum analyzer in the following setting in order to capture the lower and upper band-edges of the emission: (a) PEAK: RBW=VBW=1.5MHz / Sweep=AUTO

#### 9.2 TEST SETUP

RADIATED EMISSION TEST SETUP

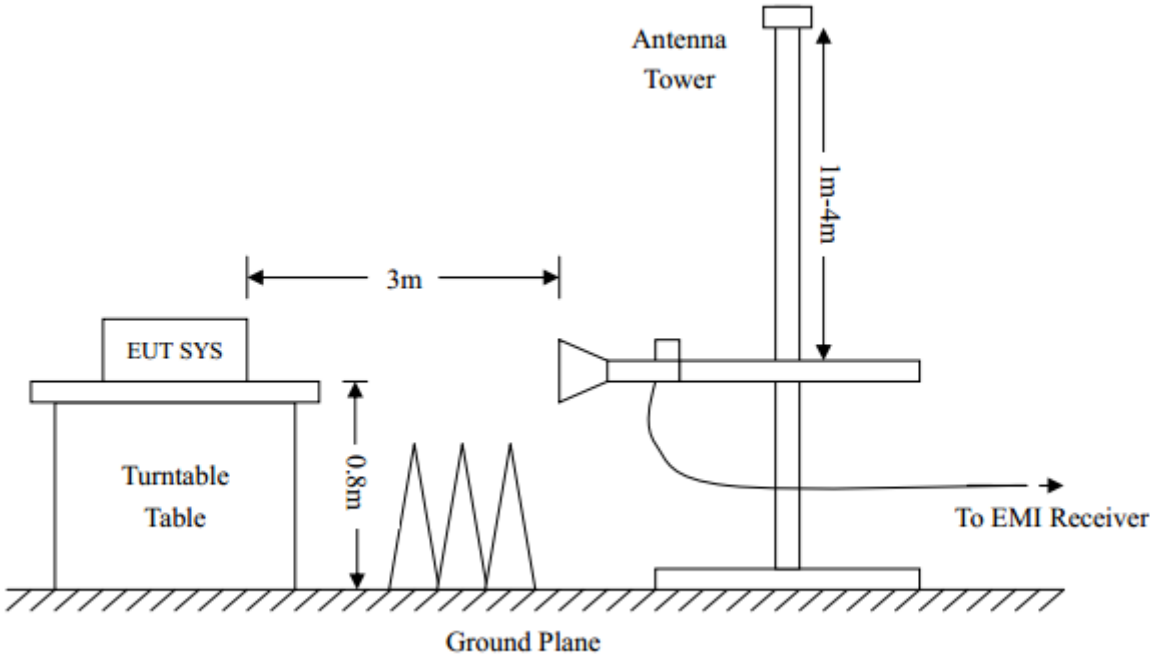

### 9.3 RADIATED TEST RESULT

(Worst modulation:GFSK)

TEST PLOT OF BAND EDGE FOR LOW CHANNEL-Horizontal

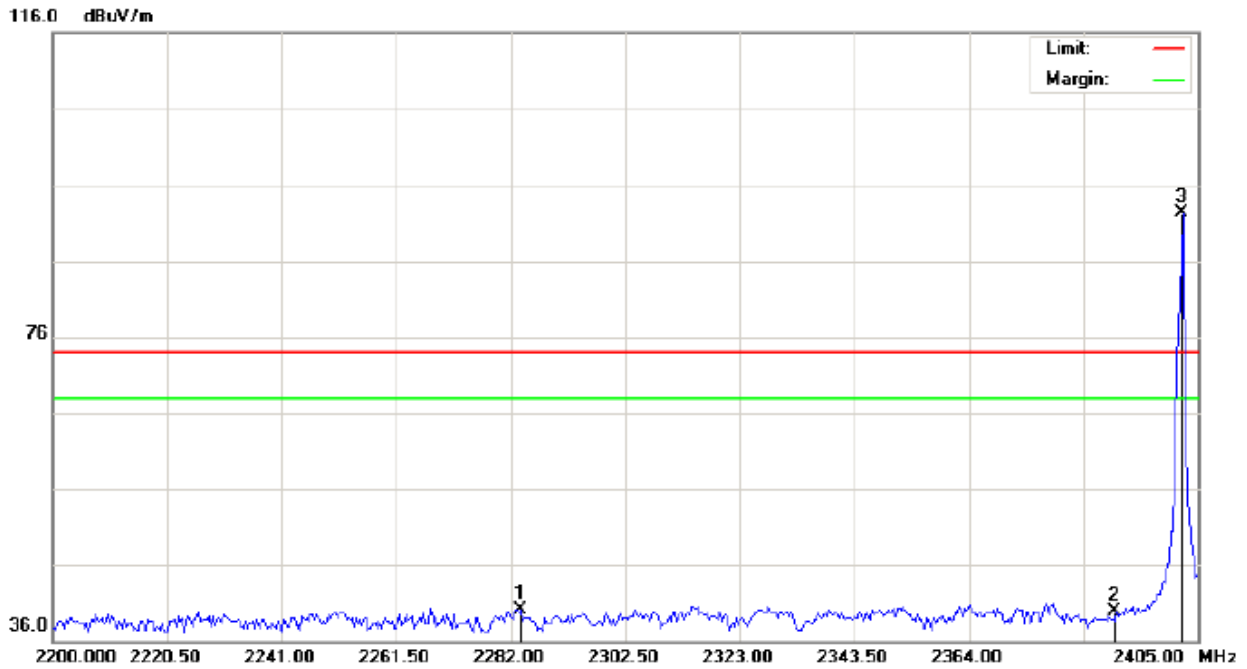

Site: site #1	Polarization: <i>Horizontal</i>	Temperature: 26
Limit: FCC Class B 3M Radiation above 1GHZ(PK)	Power:	Humidity: 60 %
EUT: Classic Bluetooth Speaker	Distance:	
M/N: XO-8967		
Mode: Low Channel TX		
Note:		

No.	Mk	Freq.	Reading	Factor	Measurement	Limit	Over	Detector	Antenna Height	Table Degree	Comment
		MHz	dBuV	dB/m	dBuV/m	dBuV/m	dB		cm	degree	
1		2283.708	29.88	10.19	40.07	74.00	-33.93	peak			
2		2390.000	29.62	10.31	39.93	74.00	-34.07	peak			
3	*	2402.000	81.91	10.32	92.23	74.00	18.23	peak			

### TEST PLOT OF BAND EDGE FOR LOW CHANNEL -Vertical



Site: site #1  
Limit: FCC Class B 3M Radiation above 1GHZ(PK)  
EUT: Classic Bluetooth Speaker  
M/N: XO-8967  
Mode: Low Channel TX  
Note:

Polarization: *Vertical*  
Power:  
Distance:

Temperature: 26  
Humidity: 60 %

No.	Mk	Freq.	Reading	Factor	Measurement	Limit	Over	Detector	Antenna Height	Table Degree	Comment
		MHz	dBuV	dB/m	dBuV/m	dBuV/m	dB		cm	degree	
1		2279.950	29.77	10.19	39.96	74.00	-34.04	peak			
2		2390.000	28.35	10.31	38.66	74.00	-35.34	peak			
3	*	2402.000	82.26	10.32	92.58	74.00	18.58	peak			

TEST PLOT OF BAND EDGE FOR HIGH CHANNEL -Horizontal

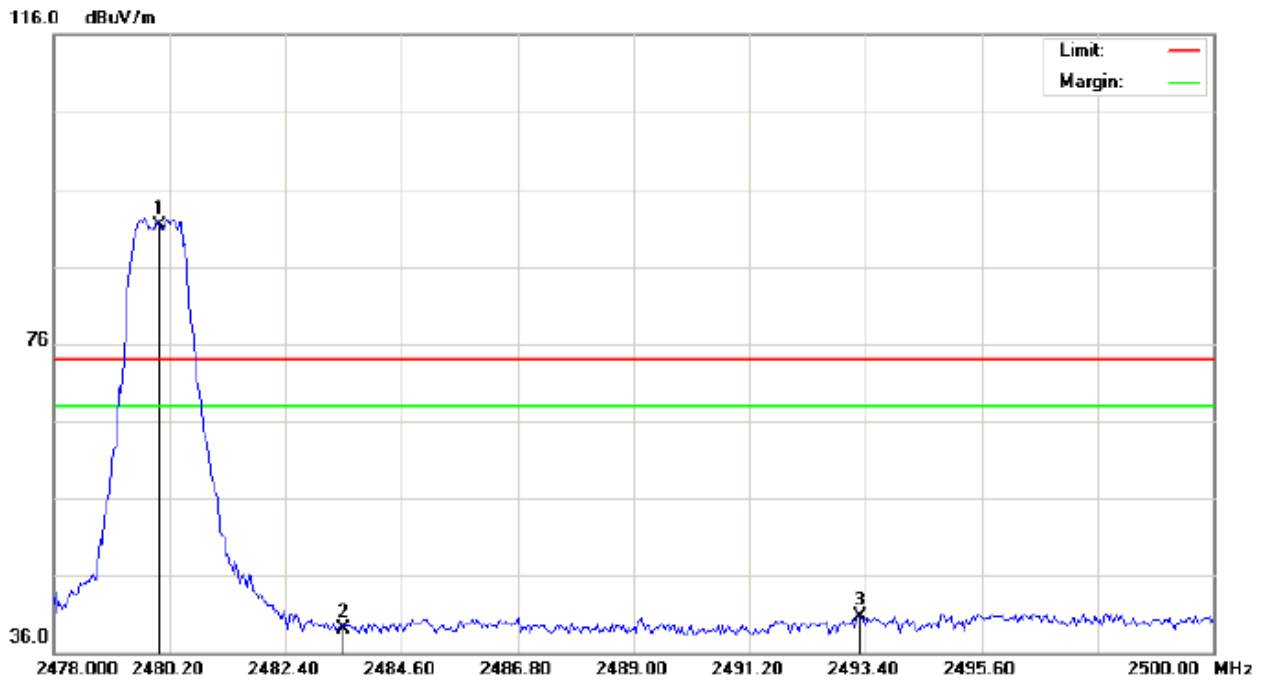

Site: site #1      Polarization: *Horizontal*      Temperature: 26  
 Limit: FCC Class B 3M Radiation above 1GHZ(PK)      Power:      Humidity: 60 %  
 EUT: Classic Bluetooth Speaker      Distance:  
 M/N: XO-8967  
 Mode: High Channel TX  
 Note:

No.	Mk	Freq.	Reading	Factor	Measurement	Limit	Over	Detector	Antenna Height	Table Degree	Comment
		MHz	dBuV	dB/m	dBuV/m	dBuV/m	dB		cm	degree	
1	*	2480.000	80.96	10.41	91.37	74.00	17.37	peak			
2		2483.500	28.75	10.41	39.16	74.00	-34.84	peak			
3		2493.290	30.25	10.42	40.67	74.00	-33.33	peak			

TEST PLOT OF BAND EDGE FOR HIGH CHANNEL-Vertical

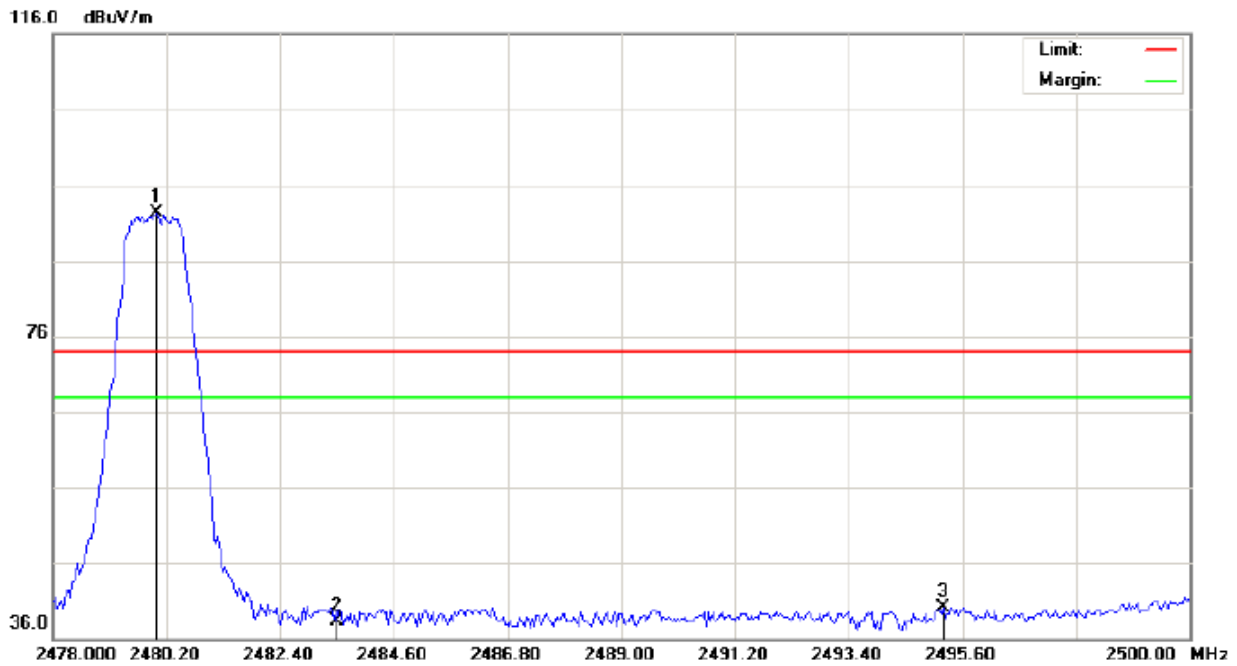

Site: site #1 Polarization: *Vertical* Temperature: 26  
Limit: FCC Class B 3M Radiation above 1GHZ(PK) Power: Humidity: 60 %  
EUT: Classic Bluetooth Speaker Distance:  
M/N: XO-8967  
Mode: High Channel TX  
Note:

No.	Mk	Freq.	Reading	Factor	Measurement	Limit	Over	Detector	Antenna Height	Table Degree	Comment
		MHz	dBuV	dB/m	dBuV/m	dBuV/m	dB		cm	degree	
1	*	2480.000	81.85	10.41	92.26	74.00	18.26	peak			
2		2483.500	27.87	10.41	38.28	74.00	-35.72	peak			
3		2495.233	29.62	10.42	40.04	74.00	-33.96	peak			

**RESULT: PASS**

**Note:** The other modes radiation emission have enough 20dB margin.

Factor=Antenna Factor + Cable loss - Amplifier gain, Over=Measure-Limit.

The "Factor" value can be calculated automatically by software of measurement system.



## 10. 20DB BANDWIDTH

### 10.1. MEASUREMENT PROCEDURE

1. Connect EUT RF output port to the Spectrum Analyzer through an RF attenuator
2. Set the EUT Work on the top, the middle and the bottom operation frequency individually.
3. Set Span = approximately 2 to 3 times the 20 dB bandwidth, centered on a hopping channel  
RBW  $\geq$  1% of the 20 dB bandwidth, VBW  $\geq$  RBW; Sweep = auto; Detector function = peak
4. Set SPA Trace 1 Max hold, then View.

### 10.2. TEST SET-UP

(BLOCK DIAGRAM OF CONFIGURATION)

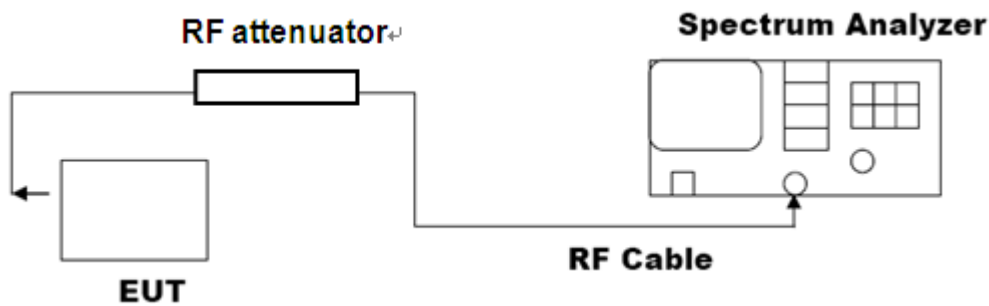

### 10.3. LIMITS AND MEASUREMENT RESULTS

BLUETOOTH 1MBPS LIMITS AND MEASUREMENT RESULT			
Applicable Limits	Measurement Result		
	Test Data (MHz)		Criteria
N/A	Low Channel	0.826	PASS
	Middle Channel	0.856	PASS
	High Channel	0.838	PASS

TEST PLOT OF BANDWIDTH FOR LOW CHANNEL

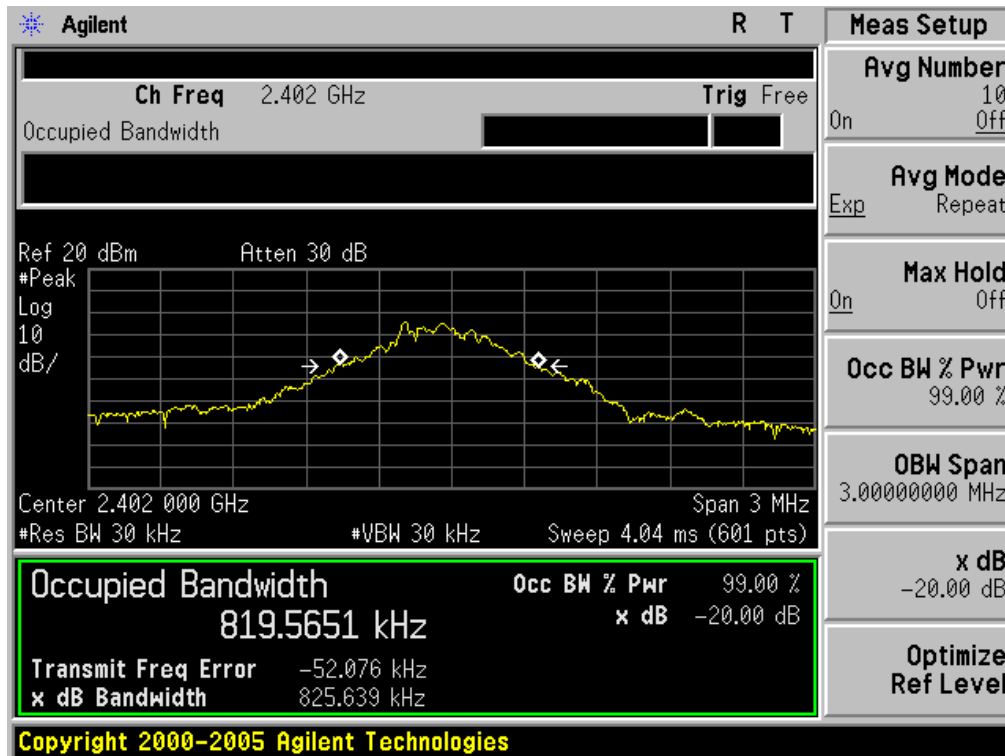

TEST PLOT OF BANDWIDTH FOR MIDDLE CHANNEL

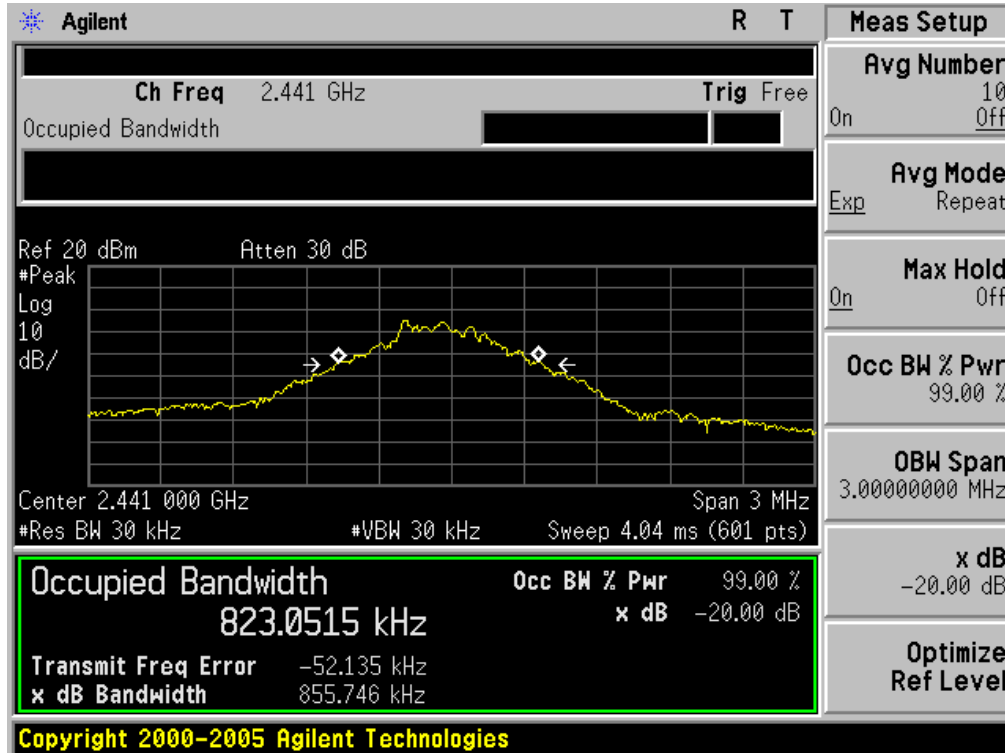

TEST PLOT OF BANDWIDTH FOR HIGH CHANNEL

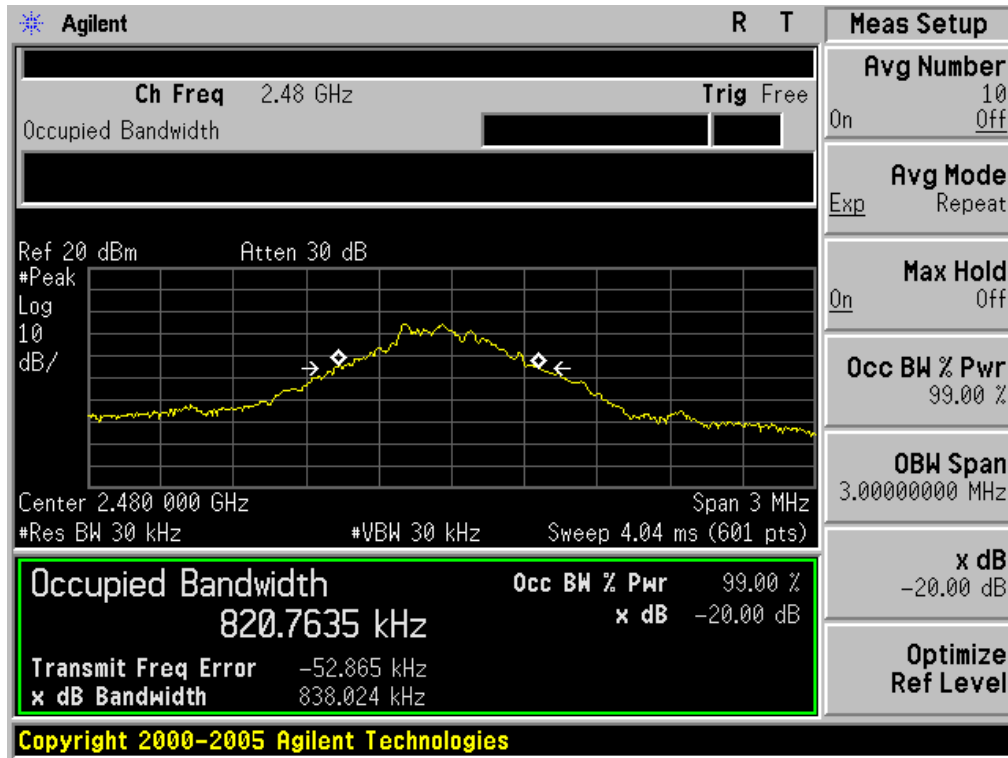

BLUETOOTH 2Mbps LIMITS AND MEASUREMENT RESULT			
Applicable Limits	Measurement Result		
	Test Data (MHz)		Criteria
N/A	Low Channel	1.301	PASS
	Middle Channel	1.304	PASS
	High Channel	1.308	PASS

TEST PLOT OF BANDWIDTH FOR LOW CHANNEL

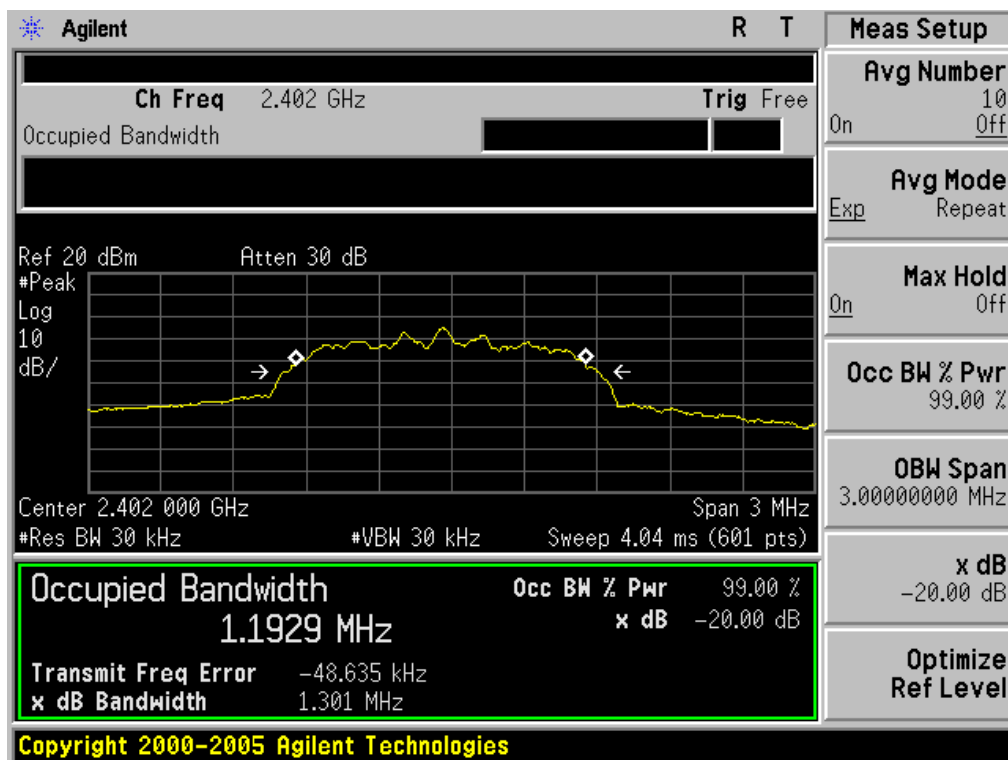

TEST PLOT OF BANDWIDTH FOR MIDDLE CHANNEL

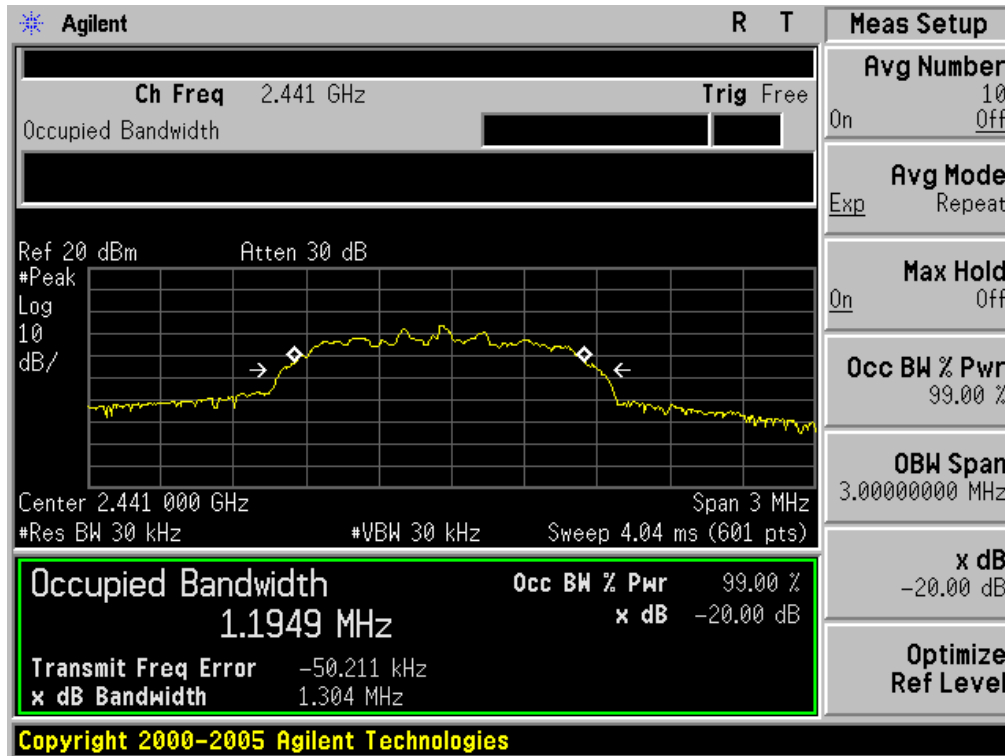

TEST PLOT OF BANDWIDTH FOR HIGH CHANNEL

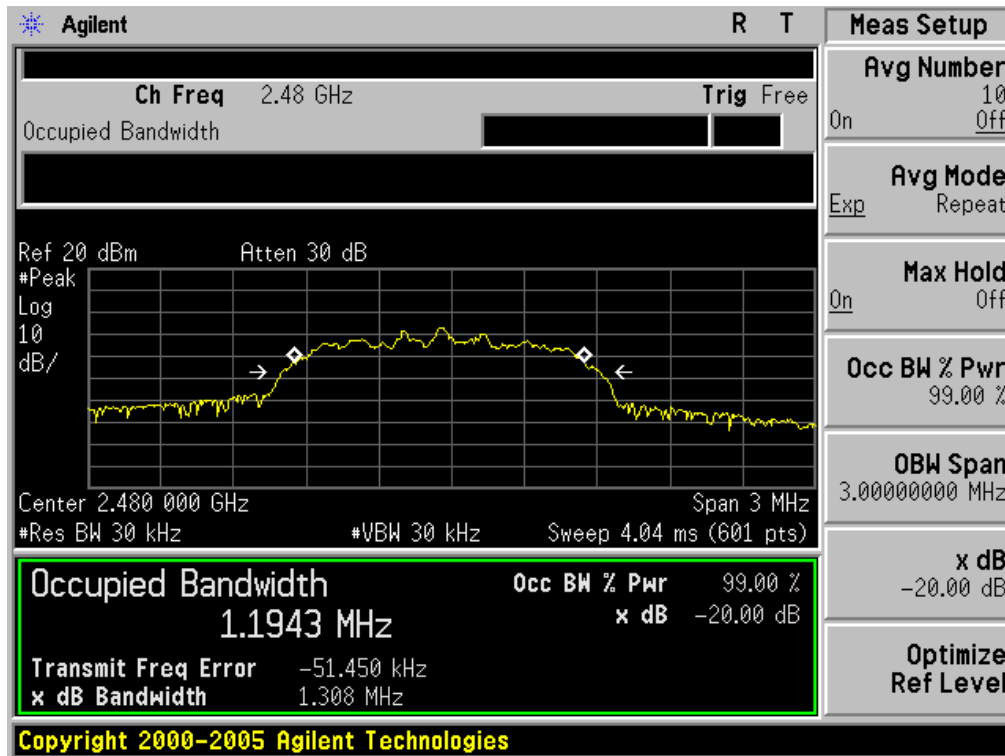

BLUETOOTH 3MBPS LIMITS AND MEASUREMENT RESULT			
Applicable Limits	Measurement Result		
	Test Data (MHz)		Criteria
N/A	Low Channel	1.331	PASS
	Middle Channel	1.296	PASS
	High Channel	1.333	PASS

TEST PLOT OF BANDWIDTH FOR LOW CHANNEL

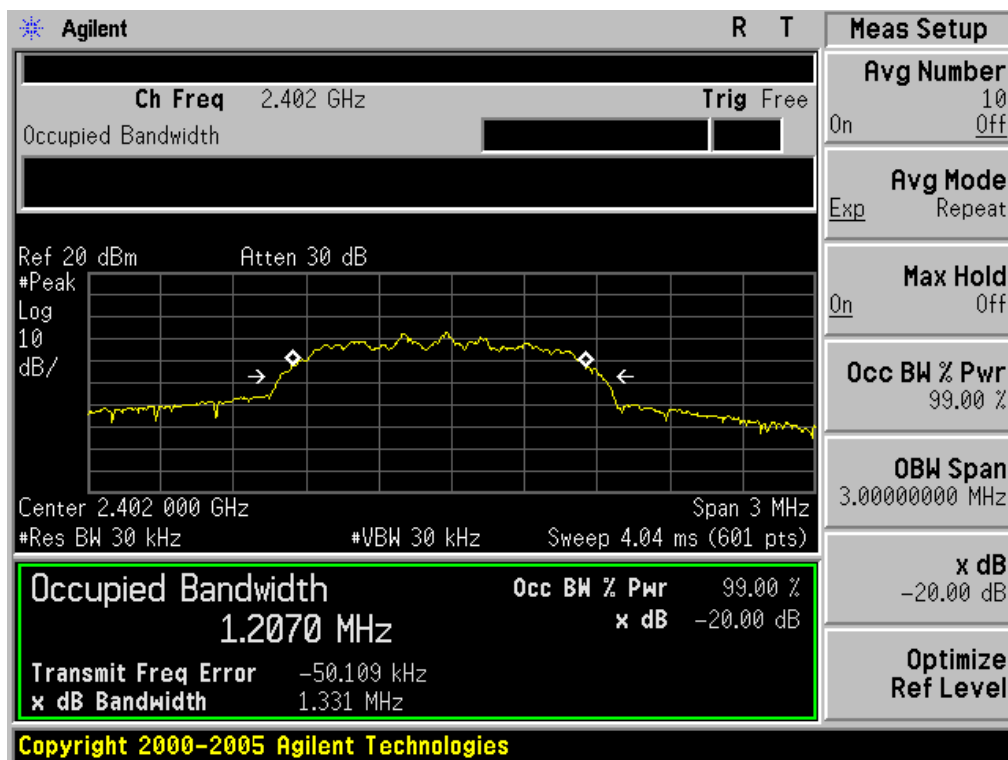

TEST PLOT OF BANDWIDTH FOR MIDDLE CHANNEL

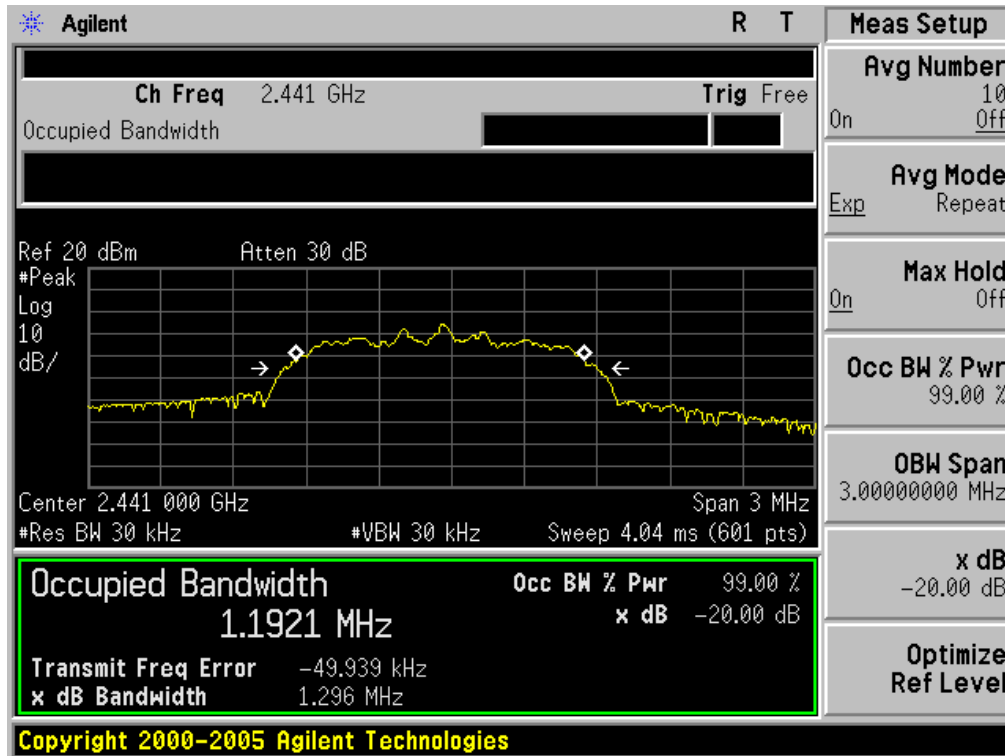

TEST PLOT OF BANDWIDTH FOR HIGH CHANNEL

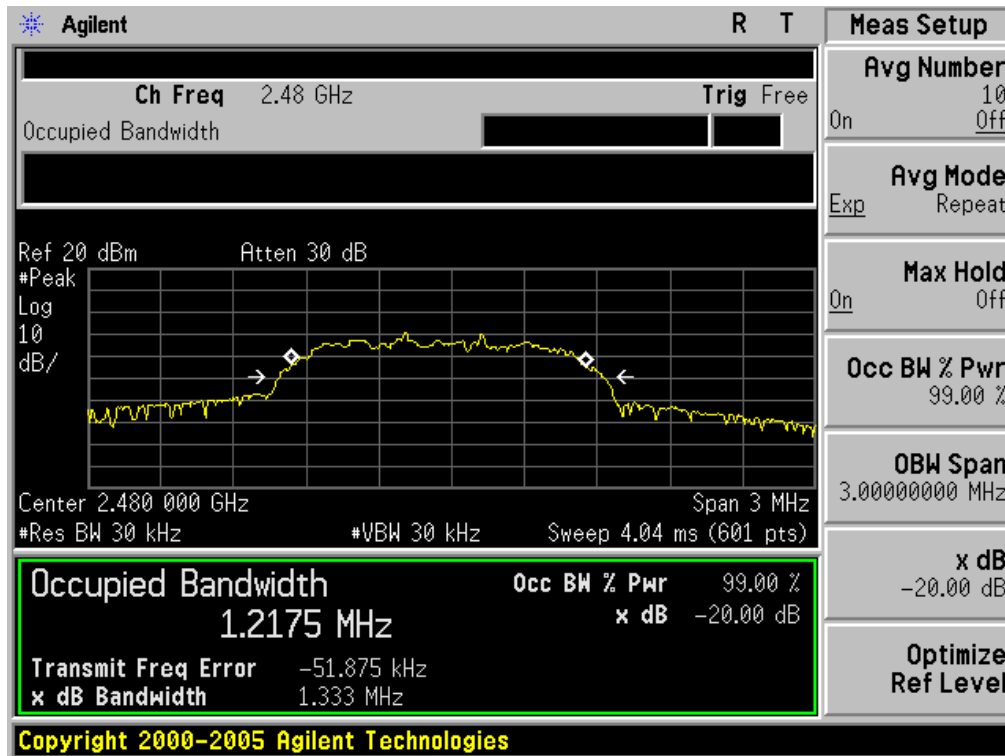

## 11. FCC LINE CONDUCTED EMISSION TEST

### 11.1. LIMITS OF LINE CONDUCTED EMISSION TEST

Frequency	Maximum RF Line Voltage	
	Q.P.( dBuV)	Average( dBuV)
150kHz~500kHz	66-56	56-46
500kHz~5MHz	56	46
5MHz~30MHz	60	50

Note:

1. The lower limit shall apply at the transition frequency.
2. The limit decreases linearly with the logarithm of the frequency in the range 0.15 MHz to 0.50 MHz.

### 11.2. BLOCK DIAGRAM OF LINE CONDUCTED EMISSION TEST

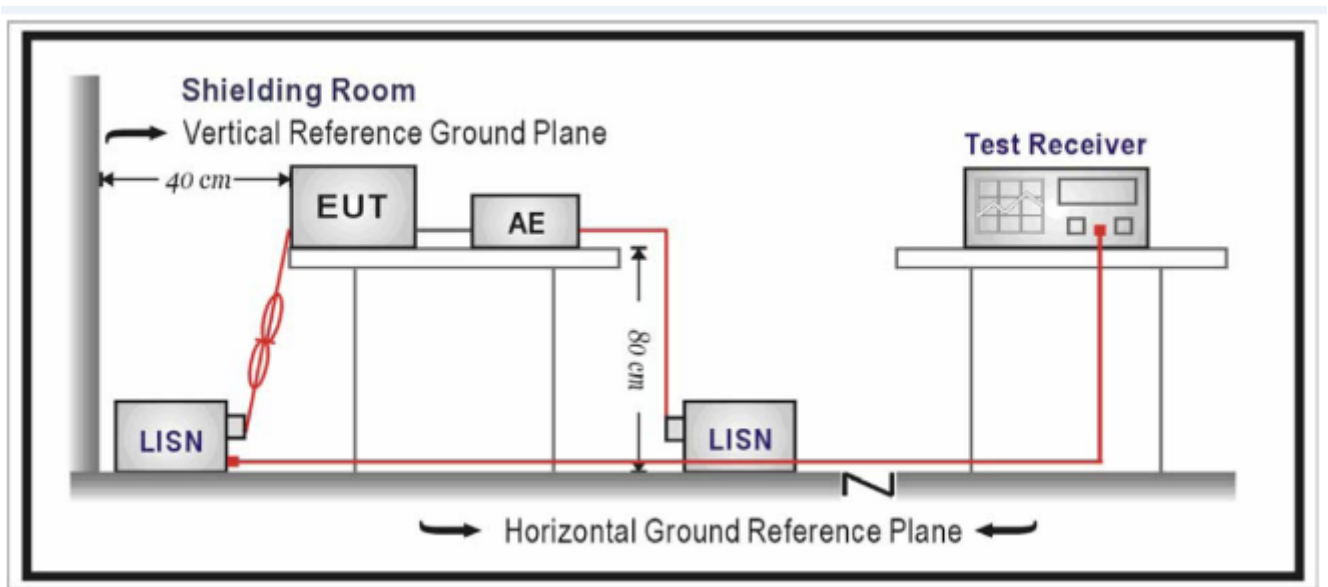



### 11.3. PRELIMINARY PROCEDURE OF LINE CONDUCTED EMISSION TEST

1. The equipment was set up as per the test configuration to simulate typical actual usage per the user's manual. When the EUT is a tabletop system, a wooden table with a height of 0.8 meters is used and is placed on the ground plane as per ANSI C63.4 (see Test Facility for the dimensions of the ground plane used). When the EUT is a floor-standing equipment, it is placed on the ground plane which has a 3-12 mm non-conductive covering to insulate the EUT from the ground plane.
2. Support equipment, if needed, was placed as per ANSI C63.4.
3. All I/O cables were positioned to simulate typical actual usage as per ANSI C63.4.
4. All support equipments received AC120V/60Hz power from a LISN, if any.
5. The EUT received DC charging voltage by PC which received 120V/60Hz power by a LISN..
6. The test program was started. Emissions were measured on each current carrying line of the EUT using a spectrum Analyzer / Receiver connected to the LISN powering the EUT. The LISN has two monitoring points: Line 1 (Hot Side) and Line 2 (Neutral Side). Two scans were taken: one with Line 1 connected to Analyzer / Receiver and Line 2 connected to a 50 ohm load; the second scan had Line 1 connected to a 50 ohm load and Line 2 connected to the Analyzer / Receiver.
7. Analyzer / Receiver scanned from 150 kHz to 30MHz for emissions in each of the test modes.
8. During the above scans, the emissions were maximized by cable manipulation.
9. The test mode(s) were scanned during the preliminary test.

Then, the EUT configuration and cable configuration of the above highest emission level were recorded for reference of final testing.

### 11.4. FINAL PROCEDURE OF LINE CONDUCTED EMISSION TEST

- EUT and support equipment was set up on the test bench as per step 2 of the preliminary test.
2. A scan was taken on both power lines, Line 1 and Line 2, recording at least the six highest emissions. Emission frequency and amplitude were recorded into a computer in which correction factors were used to calculate the emission level and compare reading to the applicable limit. If EUT emission level was less -2dB to the A.V. limit in Peak mode, then the emission signal was re-checked using Q.P and Average detector.
3. The test data of the worst case condition(s) was reported on the Summary Data page.

11.5. TEST RESULT OF LINE CONDUCTED EMISSION TEST

Line Conducted Emission Test Line 1-L

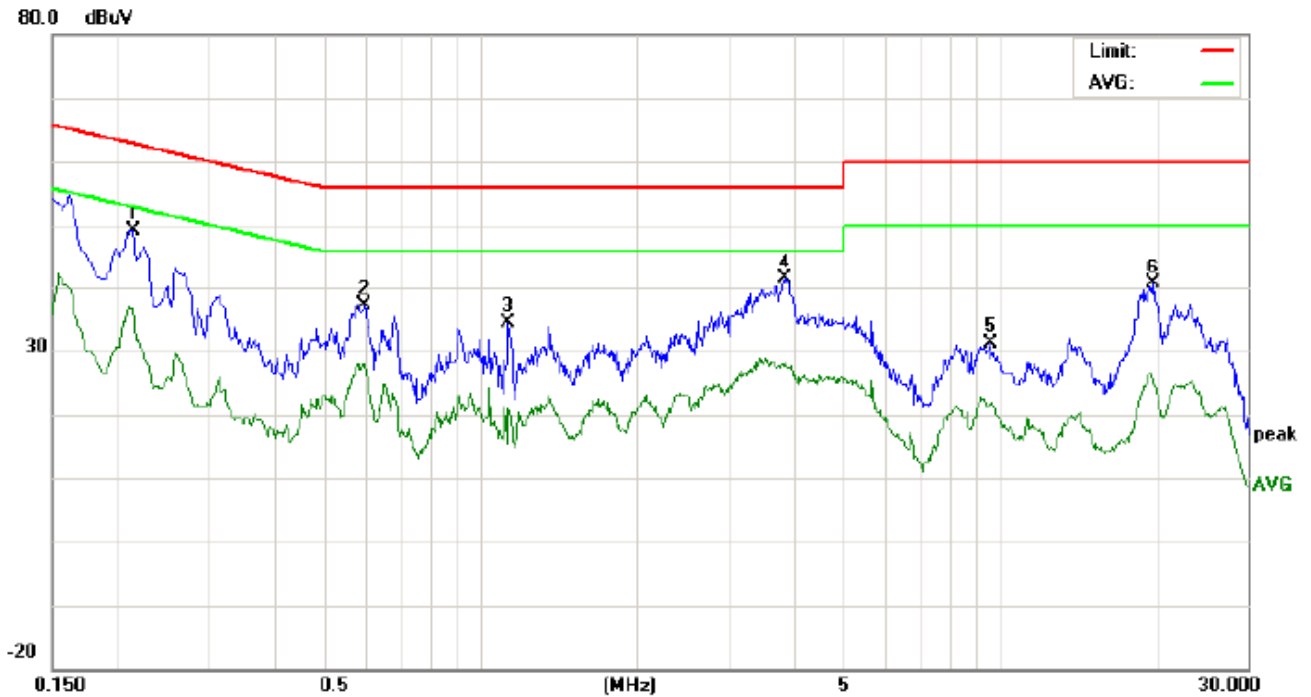

Site: Conduction Phase: **L1** Temperature: 23.5  
 Limit: EN55022 Class B Conduction(QP) Power: Humidity: 52.6 %  
 EUT: Classic Bluetooth Speaker  
 M/N: XO-8967  
 Mode: BT Link with charging  
 Note:

No.	Freq. (MHz)	Reading_Level (dBuV)			Correct Factor (dB)	Measurement (dBuV)			Limit (dBuV)		Margin (dB)		P/F	Comment
		Peak	QP	AVG		Peak	QP	AVG	QP	AVG	QP	AVG		
1	0.2140	38.97		26.30	10.23	49.20		36.53	63.04	53.04	-13.84	-16.51	P	
2	0.5980	26.89		17.62	10.31	37.20		27.93	56.00	46.00	-18.80	-18.07	P	
3	1.1340	43.85		25.59	10.37	54.22		35.96	56.00	46.00	-1.78	-10.04	P	
4	3.8500	30.84		17.75	10.45	41.29		28.20	56.00	46.00	-14.71	-17.80	P	
5	9.5620	20.68		11.07	10.34	31.02		21.41	60.00	50.00	-28.98	-28.59	P	
6	19.8260	30.49		14.85	10.11	40.60		24.96	60.00	50.00	-19.40	-25.04	P	

Line Conducted Emission Test Line 2-N

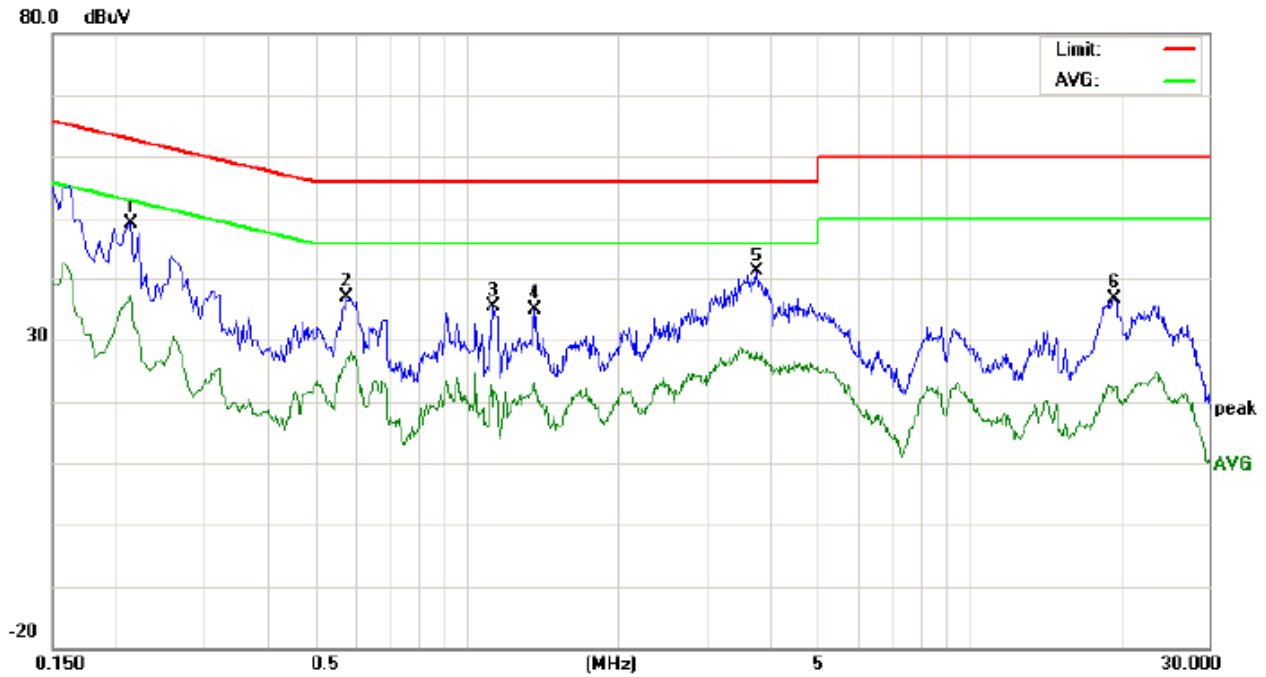

Site: Conduction Phase: **N** Temperature: 23.5  
Limit: EN55022 Class B Conduction(QP) Power: Humidity: 52.6 %  
EUT: Classic Bluetooth Speaker  
M/N: XO-8967  
Mode: BT Link with charging  
Note:

No.	Freq. (MHz)	Reading_Level (dBuV)			Correct Factor (dB)	Measurement (dBuV)			Limit (dBuV)		Margin (dB)		P/F	Comment
		Peak	QP	AVG		Peak	QP	AVG	QP	AVG	QP	AVG		
1	0.2140	38.97		26.96	10.23	49.20		37.19	63.04	53.04	-13.84	-15.85	P	
2	0.5780	26.49		16.39	10.33	36.82		26.72	56.00	46.00	-19.18	-19.28	P	
3	1.1340	24.96		11.62	10.37	35.33		21.99	56.00	46.00	-20.67	-24.01	P	
4	1.3619	24.49		12.73	10.38	34.87		23.11	56.00	46.00	-21.13	-22.89	P	
5	3.7940	30.57		16.62	10.46	41.03		27.08	56.00	46.00	-14.97	-18.92	P	
6	19.4740	26.49		11.88	10.12	36.61		22.00	60.00	50.00	-23.39	-28.00	P	

**APPENDIX A: PHOTOGRAPHS OF TEST SETUP**  
FCC LINE CONDUCTED EMISSION TEST SETUP

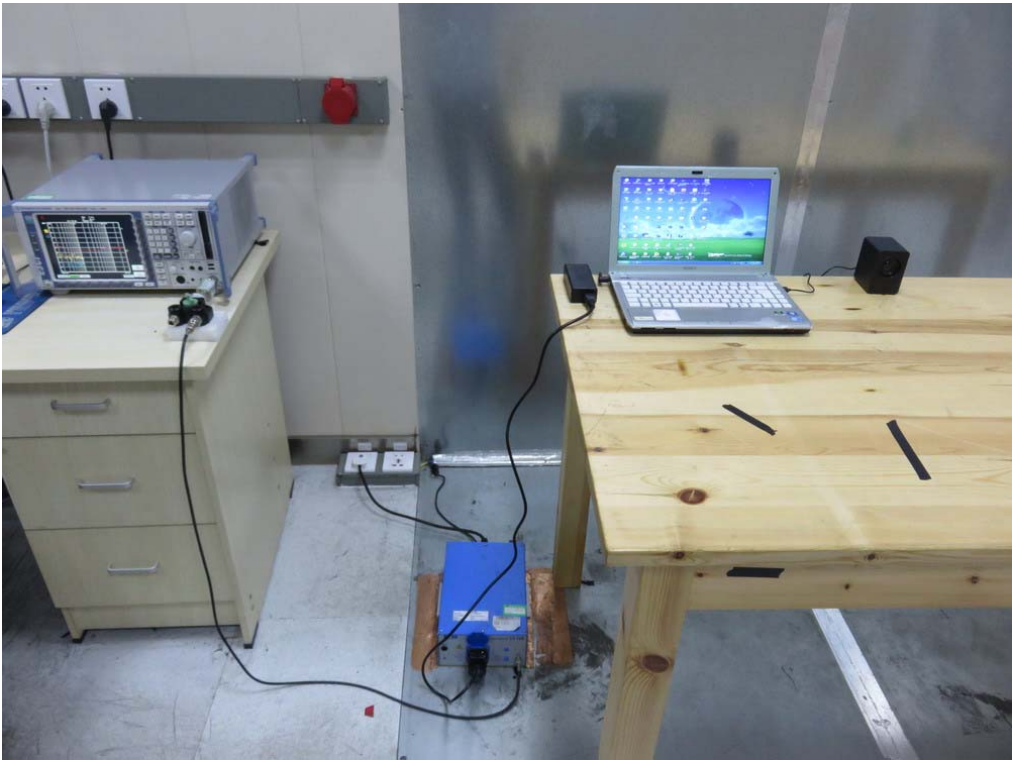

FCC RADIATED EMISSION TEST SETUP

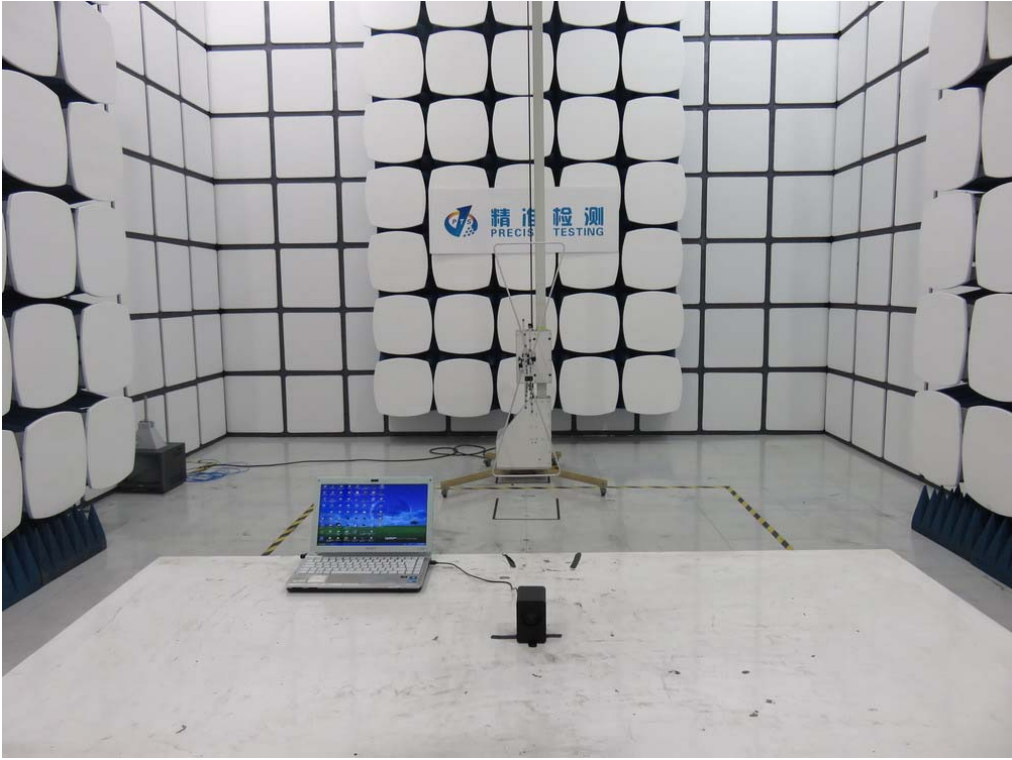

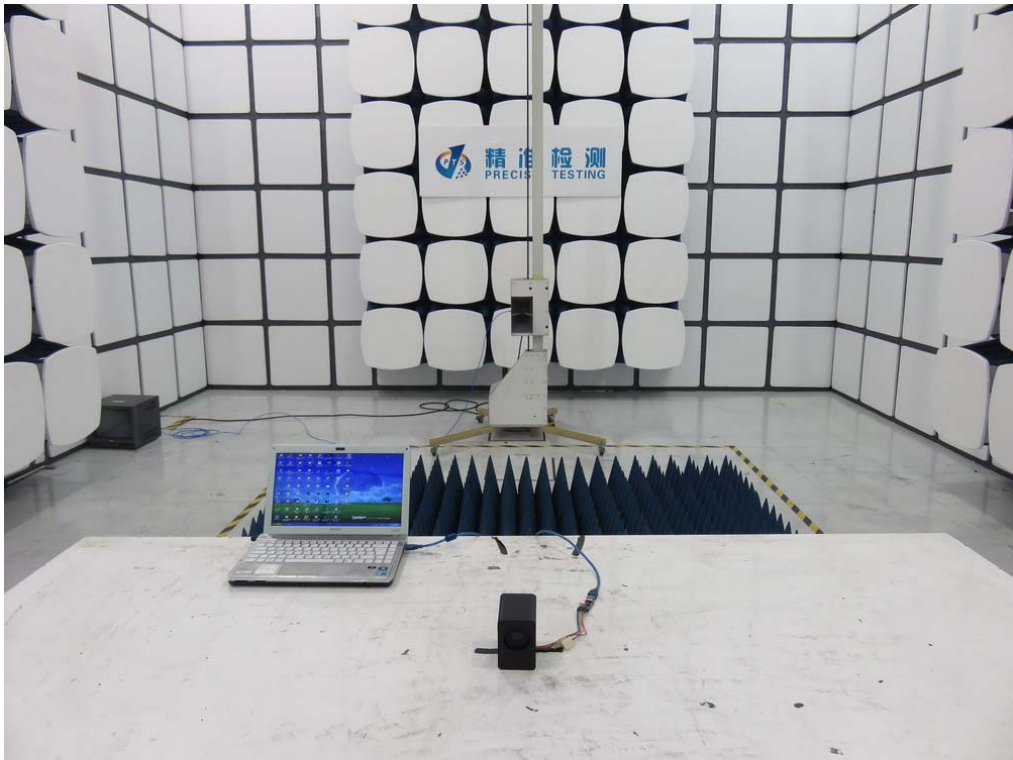

**APPENDIX B: PHOTOGRAPHS OF EUT**  
TOP VIEW OF EUT

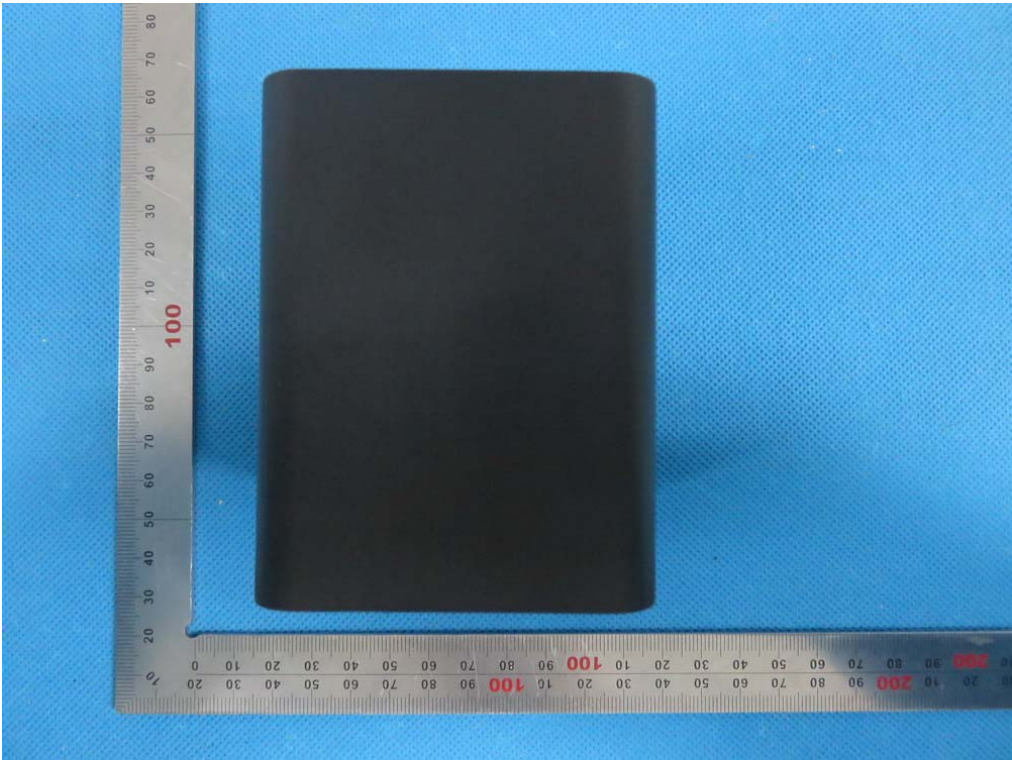

BOTTOM VIEW OF EUT

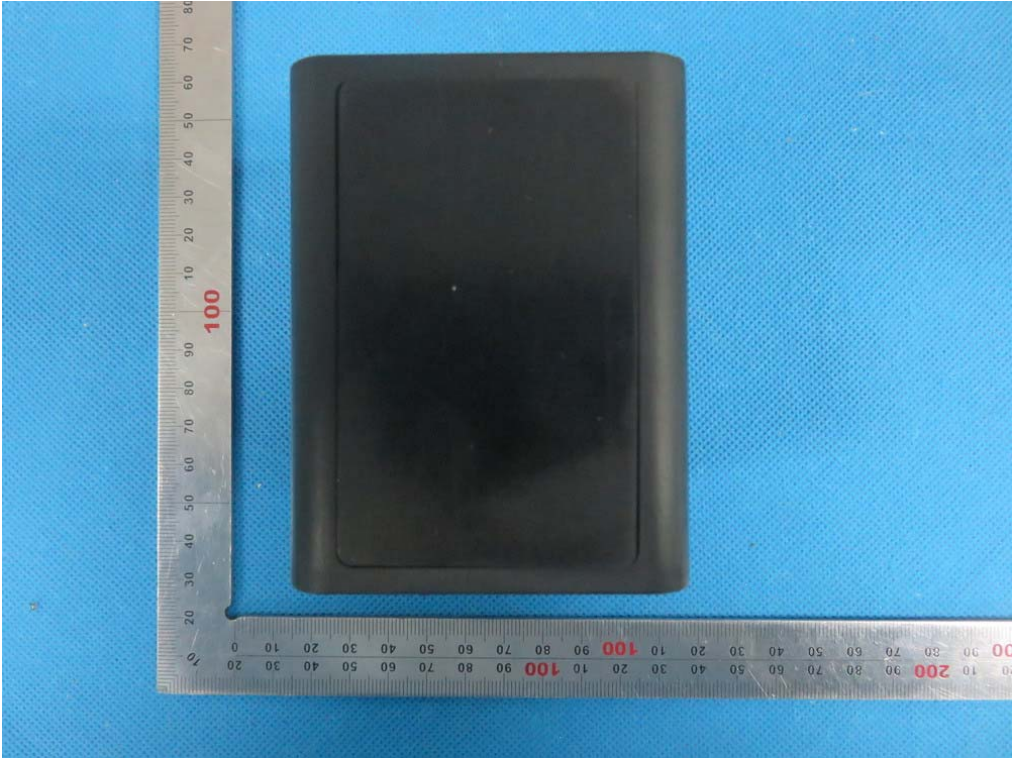

FRONT VIEW OF EUT



BACK VIEW OF EUT

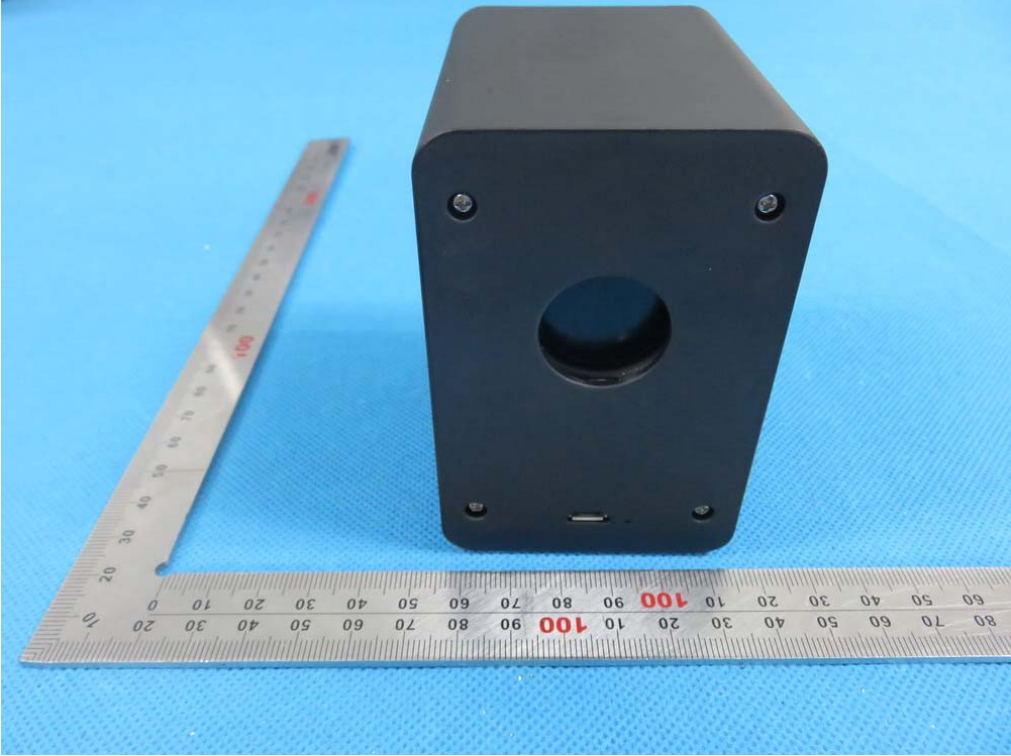

LEFT VIEW OF EUT

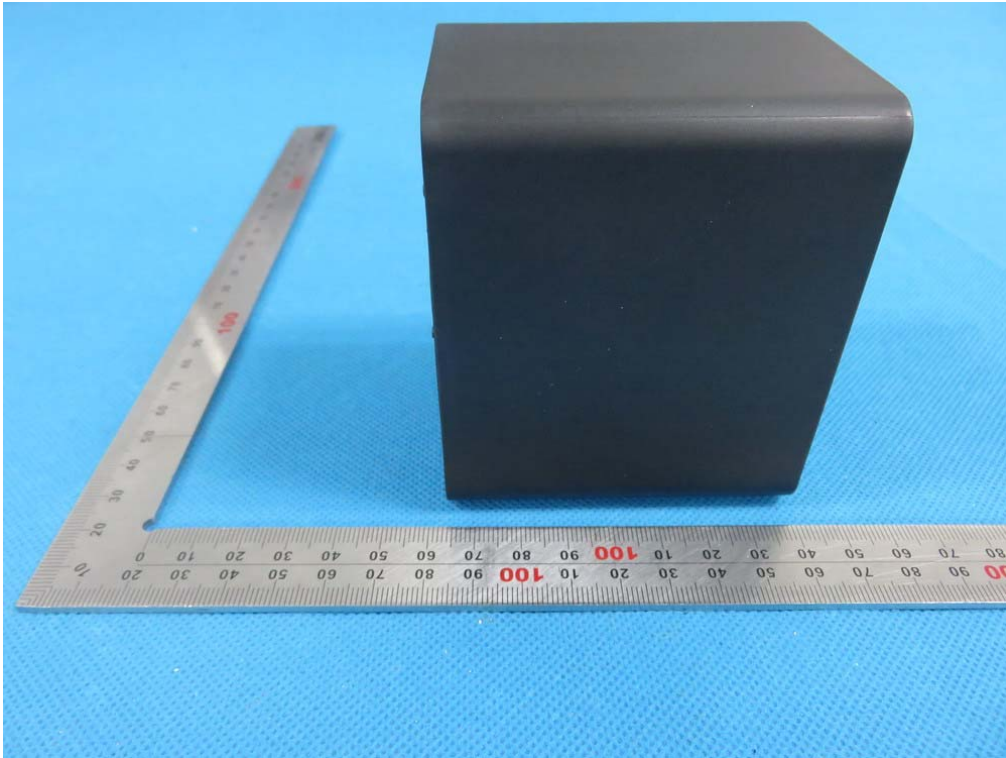

RIGHT VIEW OF EUT

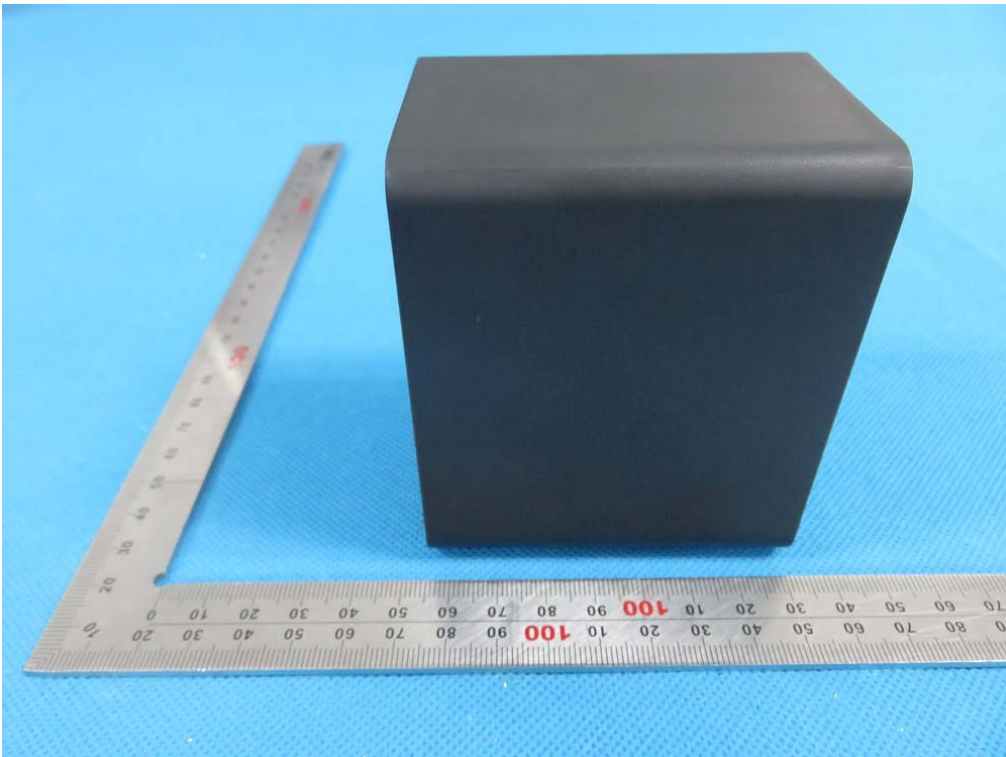



VIEW OF EUT (PORT)



OPEN VIEW OF EUT



INTERNAL VIEW OF EUT-1

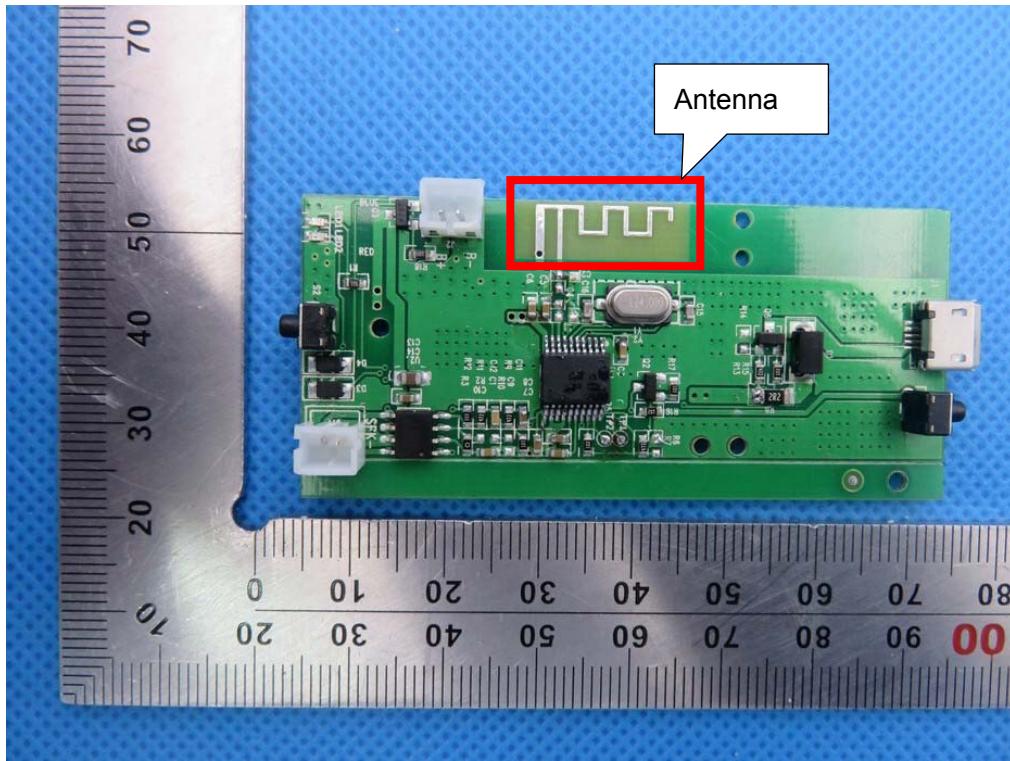

INTERNAL VIEW OF EUT-2

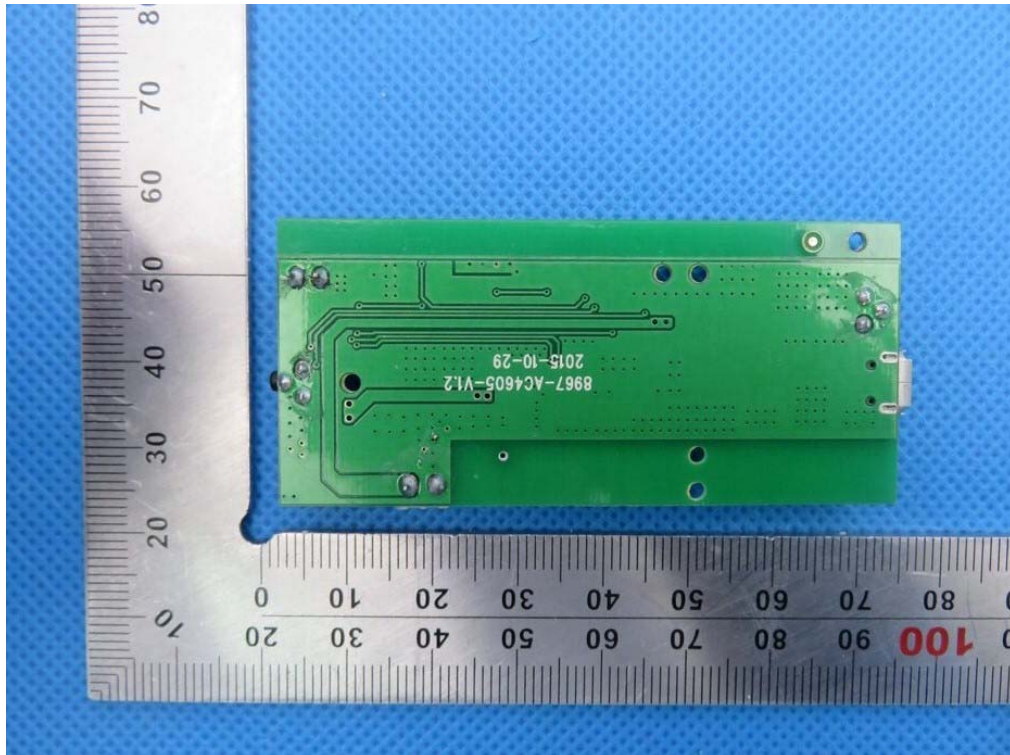

INTERNAL VIEW OF EUT-3

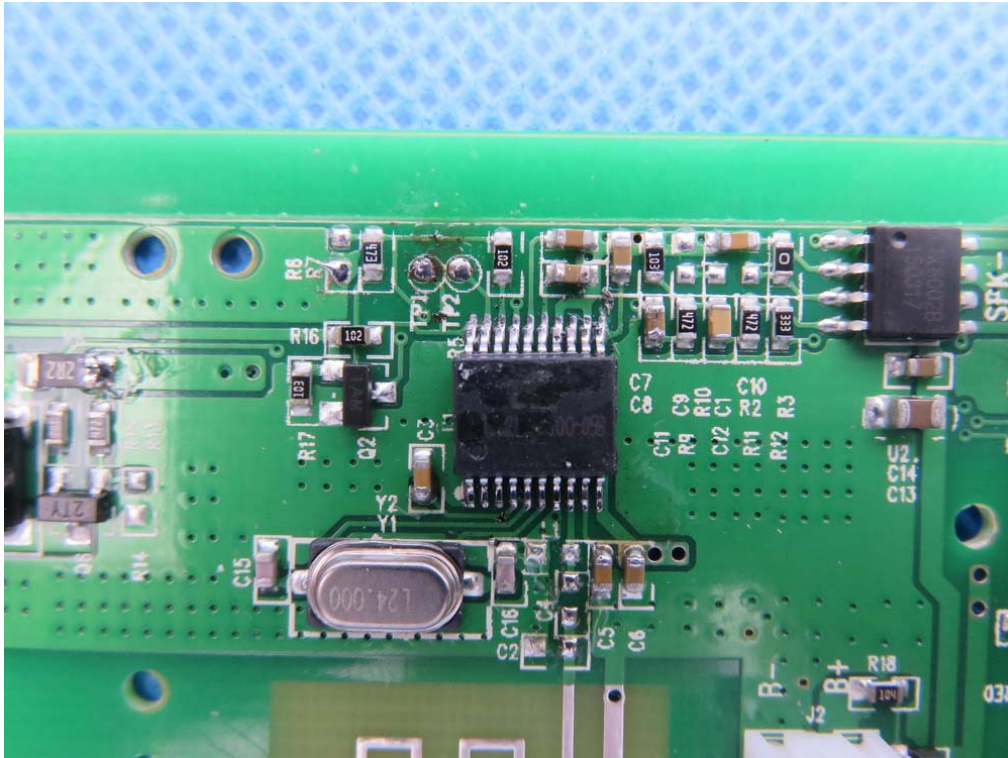

----END OF REPORT----