



# Test Report - FCC PART 80 (MRD)

## Prepared For: Alphon Marine USA, Inc.

Approved for Release By:

Signature: Bruno Clavier

Name & Title: Bruno Clavier, General Manager

Date of Signature

(YYYY-MM-DD): 2021-04-30

This test report shall not be reproduced except in full without the written and signed permission of Timco Engineering Inc. (IIA). This test report relates only to the items tested as identified and is not valid for any subsequent changes or modifications made to the equipment under test.



## Table of Contents

---

<b>1.</b>	<b>CUSTOMER INFORMATION.....</b>	<b>4</b>
1.1	PART 80 TEST RESULT SUMMARY .....	4
<b>2.</b>	<b>LOCATION OF TESTING .....</b>	<b>5</b>
2.1	TEST LABORATORY .....	5
2.2	TESTING WAS PERFORMED, REVIEWED BY .....	5
<b>3.</b>	<b>TEST SAMPLE(S) (EUT/DUT).....</b>	<b>6</b>
3.1	DESCRIPTION OF THE EUT.....	6
3.2	CONFIGURATION OF EUT .....	7
3.3	TEST SETUP OF EUT.....	7
<b>4.</b>	<b>TEST METHODS &amp; APPLICABLE REGULATORY LIMITS.....</b>	<b>8</b>
4.1	TEST METHODS/STANDARDS/GUIDANCE: .....	8
4.2	APPLIED LIMITS AND REGULATORY LIMITS:.....	8
<b>5.</b>	<b>MEASUREMENT UNCERTAINTY.....</b>	<b>8</b>
<b>6.</b>	<b>ENVIRONMENTAL CONDITIONS .....</b>	<b>8</b>
6.1	TEMPERATURE & HUMIDITY.....	8
<b>7.</b>	<b>LIST OF TEST EQUIPMENT AND TEST FACILITY.....</b>	<b>9</b>
7.1	LIST OF TEST EQUIPMENT .....	9
<b>8.</b>	<b>TEST RESULTS .....</b>	<b>10</b>
8.1	POWER AT THE FINAL AMPLIFIER.....	11
8.2	RF OUTPUT POWER .....	12
8.3	BANDWIDTH & EMISSION .....	13
8.3.1	<i>Bandwidth Plot, 99%, 9402 MHz, 0.25 nm</i> .....	14
8.3.2	<i>Bandwidth Plot, 99%, 9402 MHz, 3nm</i> .....	15
8.3.3	<i>Bandwidth Plot, 99%, 9402 MHz, 8 nm</i> .....	16
8.3.4	<i>Bandwidth Plot, 40 dB BW, 9402 MHz, 0.25 nm</i> .....	17
8.3.5	<i>Bandwidth Plot, 40 dB BW, 9402 MHz, 3 nm</i> .....	18
8.3.6	<i>Bandwidth Plot, 40 dB BW, 9402 MHz, 8 nm</i> .....	19
8.4	EMISSION LIMITATIONS, IN-BAND.....	20
8.4.1	<i>Emission Mask, 9402 MHz, 0.25 nm</i> .....	21
8.4.2	<i>Emission Mask, 9402 MHz, 3 nm</i> .....	22
8.4.3	<i>Emission Mask, 9402 MHz, 8 nm</i> .....	23
8.5	EMISSION LIMITATIONS, OUT-OF-BAND .....	24
8.5.1	<i>Conducted Emissions 30 MHz to 1 GHz, 9402 MHz, 0.25 nm</i> .....	25
8.5.2	<i>Conducted Emissions 1 GHz to Band Edge, 9402 MHz, 0.25 nm</i> .....	26
8.5.3	<i>Conducted Emissions Band Edge to 40 GHz , 9402 MHz, 0.25 nm</i> .....	27
8.5.4	<i>Conducted Emissions 30 MHz to 1 GHz, 9402 MHz, 3 nm</i> .....	28
8.5.5	<i>Conducted Emissions 1 GHz to Band Edge, 9402 MHz, 3 nm</i> .....	29



8.5.6	Conducted Emissions Band Edge to 40 GHz , 9402 MHz, 3 nm .....	30
8.5.7	Conducted Emissions 30 MHz to 1 GHz, 9402 MHz, 8 nm.....	31
8.5.8	Conducted Emissions 1 GHz to Band Edge, 9402 MHz, 8 nm.....	32
8.5.9	Conducted Emissions 1 GHz to Band Edge, 9402 MHz, 3 nm .....	33
8.5.10	Conducted Emissions Band Edge to 40 GHz , 9402 MHz, 8 nm .....	34
8.6	RADIATED EMISSIONS.....	35
8.6.1	Radiated Emissions, 9402 MHz. 0.25 nm.....	36
8.6.2	Radiated Emissions, 9402 MHz. 3 nm.....	36
8.6.3	Radiated Emissions, 9402 MHz. 8 nm.....	37
8.7	MODULATION CHARACTERISTICS.....	38
8.7.1	Audio Frequency Response.....	38
8.7.2	Low Pass Filter Response.....	38
8.7.3	Modulation Limiting .....	38
8.8	FREQUENCY STABILITY.....	39
8.8.1	Frequency Stability Data .....	40
8.8.2	Frequency Stability Plot .....	41
8.9	TRANSIENT FREQUENCY BEHAVIOR.....	42
8.10	ADJACENT CHANNEL POWER LIMITS.....	43
9.	ANNEX-A - PHOTOGRAPHS OF THE EUT.....	44
10.	ANNEX-B – TEST SETUP PHOTOGRAPHS.....	44
11.	HISTORY OF TEST REPORT CHANGES.....	44

## 1. Customer Information

**Applicant:** Alpatron Marine USA, Inc.  
**Address:** 1205 Butler Road  
 League City, TX 77573

### 1.1 Part 80 Test Result Summary

The following test procedure and guidance were used for measuring FCC PART 80 (STATIONS IN THE MARITIME SERVICES) known as Licensed Maritime Radiotelephone; ANSI C63.26-2015. Full test results are available in this report.

The Following is for Test item FCC ID: 2ADJKNKE387

Applicable Clauses from Part 2		
FCC Clauses	Description of the requirements	Result: (Pass, Fail, N/A)
2.202	Bandwidth & Emission	Pass
2.1033 (c)(8)	Power at the Final Amplifier	Reported
2.1046 (a)	RF Output Power	Pass
2.1047	Modulation characteristics	Pass
2.1049	Occupied Bandwidth	Pass
2.1051	Spurious emissions at antenna terminals	Pass
2.1053	Field strength of spurious radiation	Pass
2.1055	Frequency stability	Pass

Applicable Clauses from Part 80		
FCC Clauses	Description of the requirements	Result: (Pass, Fail, N/A)
80.205 (a), (d)	Bandwidths & Emission designator	Reported
80.209 (c)	Transmitter Frequency Tolerance	Pass
80.211 (f)	Emission Limitations, In-band	Pass
80.211 (f)	Emission Limitations, Out-of-band	Pass
80.213 (g)	Modulation Requirements	Pass
80.215 (a) (3), (n) (3)	Transmitter Power	Pass

## 2. Location of Testing

### 2.1 Test Laboratory

Timco Engineering Inc. is a subsidiary of Industrial Inspection & Analysis, Inc. ("IIA").  
Testing was performed at Timco's permanent laboratory located at 849 NW State Road 45, Newberry, Florida 32669

FCC test firm # 578780  
FCC Designation # US1070  
FCC site registration is under A2LA certificate # 0955.01  
ISED Canada test site registration # 2056A  
EU Notified Body # 1177  
For all designations see A2LA scope # 0955.01

### 2.2 Testing was performed, reviewed by

Dates of Testing: April 15 - 29, 2021

Signature:



Name & Title: Terri Allen, Technical Assistant

Date of Signature

(YYYY-MM-DD): 2021-04-30

Signature:



Sr. EMC Engineer  
EMC-003838-NE



Name & Title: Tim Royer, EMC Engineer

Date of Signature

(YYYY-MM-DD): 2021-04-30

### 3. Test Sample(s) (EUT/DUT)

The test sample was received: April 22, 2021

#### 3.1 Description of the EUT

A description as well as unambiguous identification of the EUT(s) tested. Where more than one sample is required for technical reasons (such as the use of connected units for the purpose of conducted output power testing where the product units will have integral antennas), each specific test shall identify which unit was tested.

Identification	
FCC ID:	2ADJKNKE387
Brief Description	River Radar
Type of Modular	n/a
Model(s) #	NKE-387
Trade name	n/a
Firmware version	n/a
Software version	n/a
Serial Number	n/a

Technical Characteristics	
Technology	Radar
Frequency Range	9200 - 9500 MHz
RF O/P Power (Max.)	5.5 kW
Modulation	Pulse w/ no modulated information
Bandwidth & Emission Class	66M3PON
Number of Channels	n/a
Duty Cycle	0.12%
Antenna Connector	Proprietary (fitted with WR-90 adapter for testing)
Voltage Rating (AC or Batt.)	DC 24 V

Antenna Characteristics		
Antenna Name	Frequency Range	Dimensions
Swing Circle 1880 mm	9.0 – 9.5 GHz	6'
Swing Circle 2240 mm	9.0 – 9.5 GHz	7'
Swing Circle 2810 mm	9.0 – 9.5 GHz	9'

### 3.2 Configuration of EUT

Test Modes				
Band	Mode (#)	Test Frequencies	BW (nominal)	Modulation
9.3 – 9.5 GHz	0.25 nm	9402 GHz	66.26 MHz	Pulse
9.3 – 9.5 GHz	3 nm	9402 GHz	51.57 MHz	Pulse
9.3 – 9.5 GHz	8 nm	9402 GHz	18 MHz	Pulse

#### Operating conditions during Testing:

The device was operated without the provided antenna(s).

No other modifications of the device under test (including firmware, specific software settings, and input/output signal levels to the EUT) were made.

#### Peripherals used during Testing:

A laptop provided by the manufacturer was used to control the EUT.

### 3.3 Test Setup of EUT

Equipment, antenna, and cable arrangement. The setup of the equipment and cable or wire placement on the test site that produces the highest radiated and the highest ac power line conducted emissions shall be shown clearly and described. Information on the orientation of portable equipment during testing shall be included. Drawings or photographs may be used for this purpose.

Test Setups are included in the test report.

#### 4. Test methods & Applicable Regulatory Limits

##### 4.1 Test methods/Standards/Guidance:

Test procedures and guidance for measuring Licensed Part 80 Licensed device:

- 1) ANSI C63.26-2015
- 2) ITU-R M.1177-3 (per 80.273 (a) (6))

##### 4.2 Applied Limits and Regulatory Limits:

- 1) FCC CFR 47 Part 80

#### 5. Measurement Uncertainty

Parameter	Uncertainty (dB)
Conducted Emissions	± 3.14 dB
Radiated Emissions (9kHz – 30 MHz)	± 3.08 dB
Radiated Emissions (30 – 200 MHz)	± 2.16 dB
Radiated Emissions (200 – 1000 MHz)	± 2.15 dB
Radiated Emissions (1 GHz – 18 GHz)	± 2.14 dB
Radiated Emissions (18 GHz – 40 GHz)	± 2.31 dB
<b>Note:</b> The uncertainties provided in this table represent an expanded uncertainty expressed at approximately the 95% confidence level using a coverage factor of K=2.	

#### 6. Environmental Conditions

##### 6.1 Temperature & Humidity

Measurements performed at the test site did not exceed the following:

Temperature	23 C +/- 5%
Humidity	55% +/- 5%
<b>Note:</b> Specific environmental conditions that are applicable to a specific test are available in the test result section.	



## 7. List of Test Equipment and Test Facility

The test equipment used identified by type, manufacturer, serial number, or other identification and the date on which the next calibration or service check is due.

Description of the firmware or software used to operate EUT for testing purposes.

A complete list of all test equipment used shall be included with the test report. The manufacturer's model and serial numbers, and date of last calibration, and calibration interval shall be included. Measurement cable loss, measuring instrument bandwidth and detector function, video bandwidth, if appropriate, and antenna factors shall also be included where applicable.

### 7.1 List of Test Equipment

Device	Manufacturer	Model	SN #	Current Cal	Cal Due
<a href="#">Audio Analyzer</a>	HP	8903B	3011A13084	1/13/21	1/13/2024
<a href="#">Function Generator</a>	Standford	DS340	25200	1/13/21	1/13/2024
<a href="#">Modulation Analyzer</a>	HP	8901A	3050A05856	4/23/20	4/23/2023
<a href="#">Oscilloscope</a>	LeCroy	LT364	00414	3/28/19	3/27/2022
<a href="#">Signal Generator HP 8648C</a>	HP	8648C	3847A04696	3/31/21	3/30/2024
<a href="#">Signal Generator R&amp;S SMU-200A</a>	Rohde & Schwarz	SMU200A	103195	5/23/18	5/22/2021
<a href="#">Sweep/Signal Generator</a>	Anritsu	68369B	985112	1/19/21	1/19/2024
<a href="#">Digital Multimeter</a>	Fluke	77	35053830	9/9/20	9/9/2023
<a href="#">Digital Multimeter</a>	Fluke	77	43850817	7/20/19	7/19/2022
<a href="#">Digital Multimeter</a>	Fluke	FLUKE-77-3	79510408	9/9/20	9/9/2023
<a href="#">Multimeter</a>	HP	973A	JP37006959	9/9/20	9/9/2023
<a href="#">R&amp;S 18 GHz USB Peak Power Sensor</a>	Rohde & Schwarz	NRP-Z85	1411.7501.02-102085-WV	2/4/19	2/3/2022
<a href="#">Active Loop</a>	ETS-Lindgren	6502	00062529	10/20/20	10/20/2023
<a href="#">Biconical 1057</a>	Eaton	94455-1	1057	10/16/20	10/16/2023
<a href="#">Log-Periodic 1243</a>	Eaton	96005	1243	5/20/18	5/19/2021
<a href="#">Double-Ridged Horn/ETS Horn 1</a>	ETS-Lindgren	3117	00035923	2/25/20	2/24/2023
<a href="#">Double-Ridged Horn 18-40 GHz</a>	EMCO	3116	9011-2145	10/19/20	10/19/2023
<a href="#">CHAMBER</a>	Panashield	3M	N/A	3/12/19	3/11/2022
<a href="#">Pre-amp</a>	RF-LAMBDA	RLNA00M45GA	NA	2/27/19	2/26/2022
<a href="#">EMI Test Receiver R&amp;S ESIB 40</a>	Rohde & Schwarz	ESIB 40	100274	7/22/19	7/21/2022
<a href="#">EMI Test Receiver R&amp;S ESU 40</a>	Rohde & Schwarz	ESU 40	100320	8/28/18	8/27/2021
<a href="#">Frequency Counter Small</a>	HP	5385A	3242A07460	9/9/20	9/9/2023
<a href="#">Type K J Thermometer</a>	Martel	303	080504494	1/18/20	1/17/2023

Software	Author	Version	Validation Or
ESU Firmware	Rohde & Schwarz	4.43 SP3; BIOS v5.1-24-3	2018
RSCCommander	Rohde & Schwarz	1.6.4	2014
ScopeExplorer	LeCroy	v2.25.0.0	2009
Field Strength	Timco	v4.10.7.0	2016

## 8. Test Results

The results of the test are usually indicated in the form of tables, spectrum analyzer plots, charts, sample calculations, as appropriate for each test procedure.

A description and/or a block diagram of the test setup is usually provided.

The measurement results, along with the appropriate limits for comparison, may be presented in tabular or graphical form. In addition, any variation in the measurement environment may be reported if applicable (e.g., a significant change of temperature that could affect the cable loss and amplifier response).

Unless noted otherwise in the referenced standard, the measurements of **ac power-line conducted emissions and conducted power output** will be reported in units of dB $\mu$ V. Unless noted otherwise in the referenced standard, the measurements of **radiated emissions** will be reported in units of decibels, referenced to one microvolt per meter (dB $\mu$ V/m) for electric fields, or to one ampere per meter (dBA/m) for magnetic fields, at the distance specified in the appropriate standards or requirements. The measurements of antenna-conducted power for receivers may be reported in units of dB $\mu$ V if the impedance of the measuring instrument is also reported. Otherwise, antenna-conducted power will be reported in units of decibels referenced to one milliwatt (dBm). All formulas for data conversions and conversion factors, if used, will be included in this measurement report.

## 8.1 Power at the Final Amplifier

Limits from FCC Part 2.1033 (c)(8).

No method of measurement is specified. The result has been calculated based on all available information.

Test Results		
EUT Operating Voltage (V)	EUT Current (A)	Power at the Final Amplifier
120 V AC	10.5 A	1050 W
230 V AC	4.57 A	1050 W

## 8.2 RF Output Power

Limits from FCC Parts 2.1046(a), 80.215 (a) (3), (n) (3) test procedure from ANSI C63.26-2015.

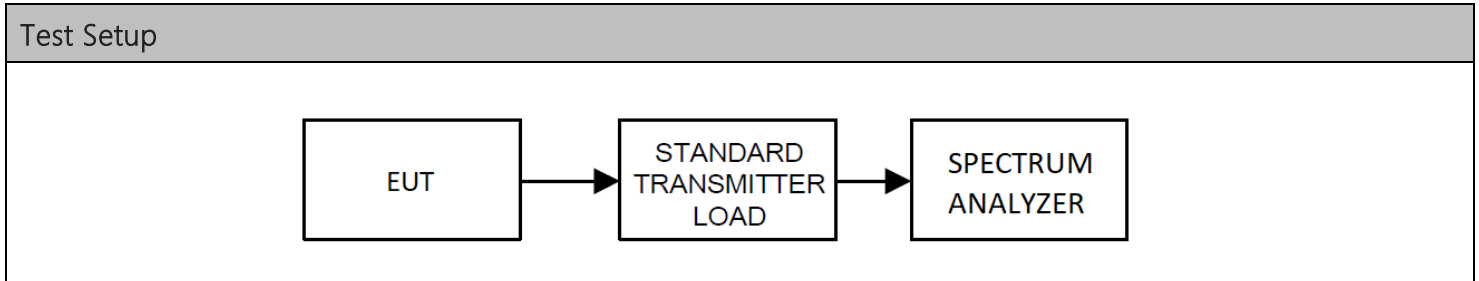

		Test Results, Mode 1				
Mode	Tuned Frequency (MHz)	Method	Measured Power Output (dBm)	Duty Cycle Correction	Power Output (dBm)	Power Output (W)
0.25 nm	9402.0	Conducted	66.36	0.02	49.37	86.5
3 nm	9402.0	Conducted	67.25	0.04	53.27	212.35
8 nm	9402.0	Conducted	67.43	0.12	58.22	664.02

Note : The mean power was calculated based on formula:  
 $P_a = P_m * DC$

### 8.3 Bandwidth & Emission

Limits from FCC Parts 2.1049, 80.205 (a), (d), test procedure from ANSI C63.26-2015.

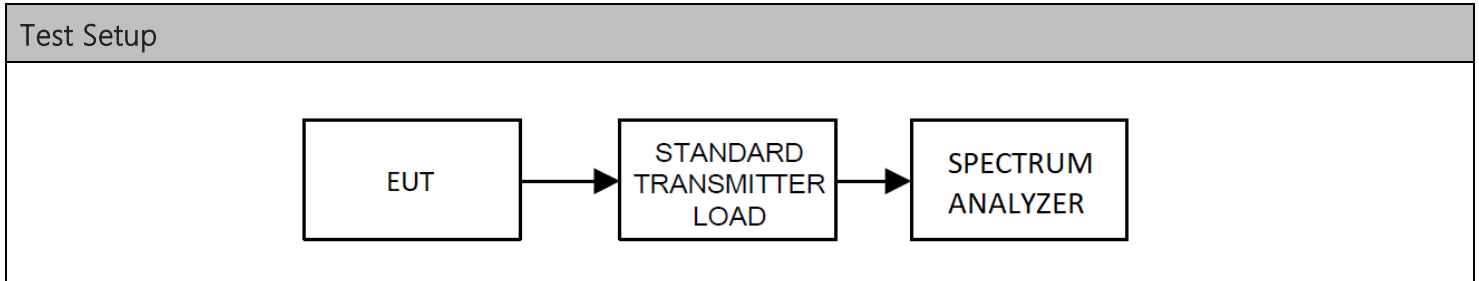

Test Results, Authorized Bandwidth		
Rule Part	Operating Range	Authorized Bandwidth
Part 80	9.3 – 9.5 GHz	300 MHz

Test Results, Occupied Bandwidth		
Tuned Frequency (MHz)	Occupied Bandwidth (MHz)	Bandwidth Type
9402.0, 0.25 nm	66.26	99% Power
9402.0, 3 nm	51.57	99% Power
9402.0, 8 nm	18.006	99% Power
9402.0, 0.25 nm	236.85	40 dB
9402.0, 3 nm	233.17	40 dB
9402.0, 8 nm	134.61	40 dB

Test Results, Necessary Bandwidth			
Tuned Frequency (MHz)	Necessary Bandwidth (MHz)	Emission Designator	Bandwidth Type
9402.0	250.00	PON	40 dB Down

## Occupied Bandwidth, Spectrum Plots

### 8.3.1 Bandwidth Plot, 99%, 9402 MHz, 0.25 nm

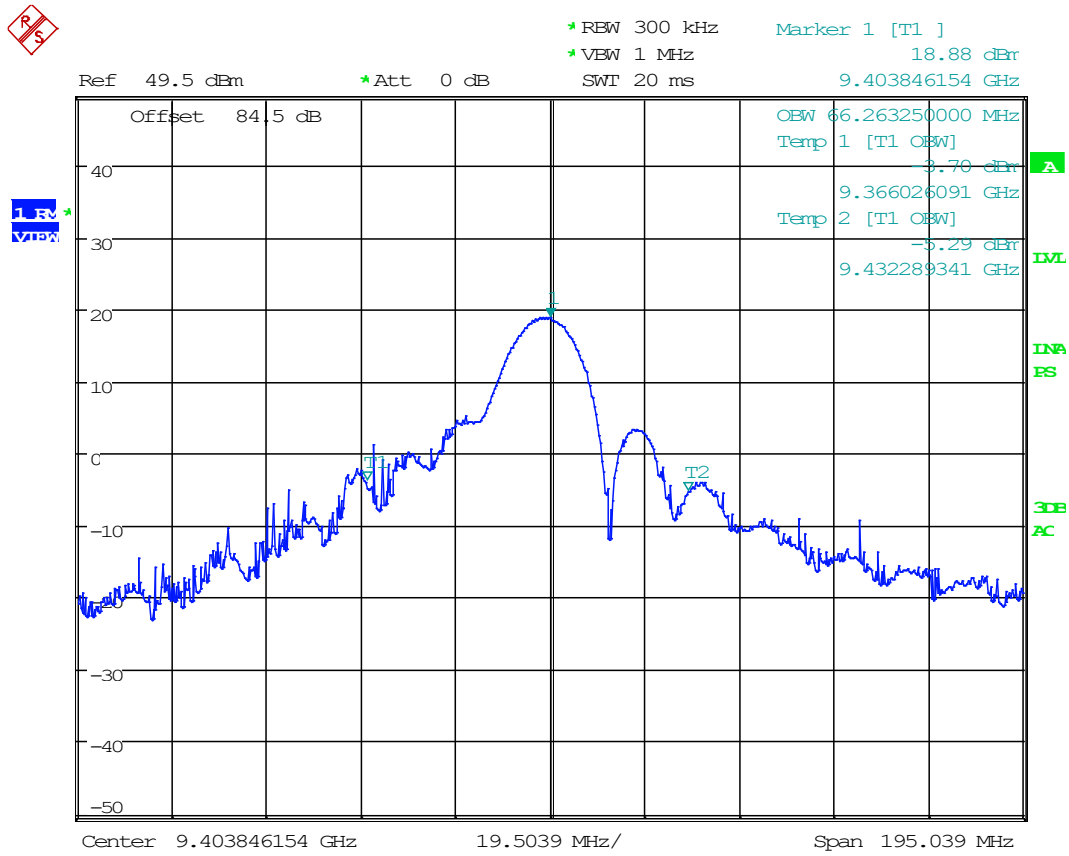

Date: 15.APR.2021 10:53:58

### 8.3.2 Bandwidth Plot, 99%, 9402 MHz, 3nm

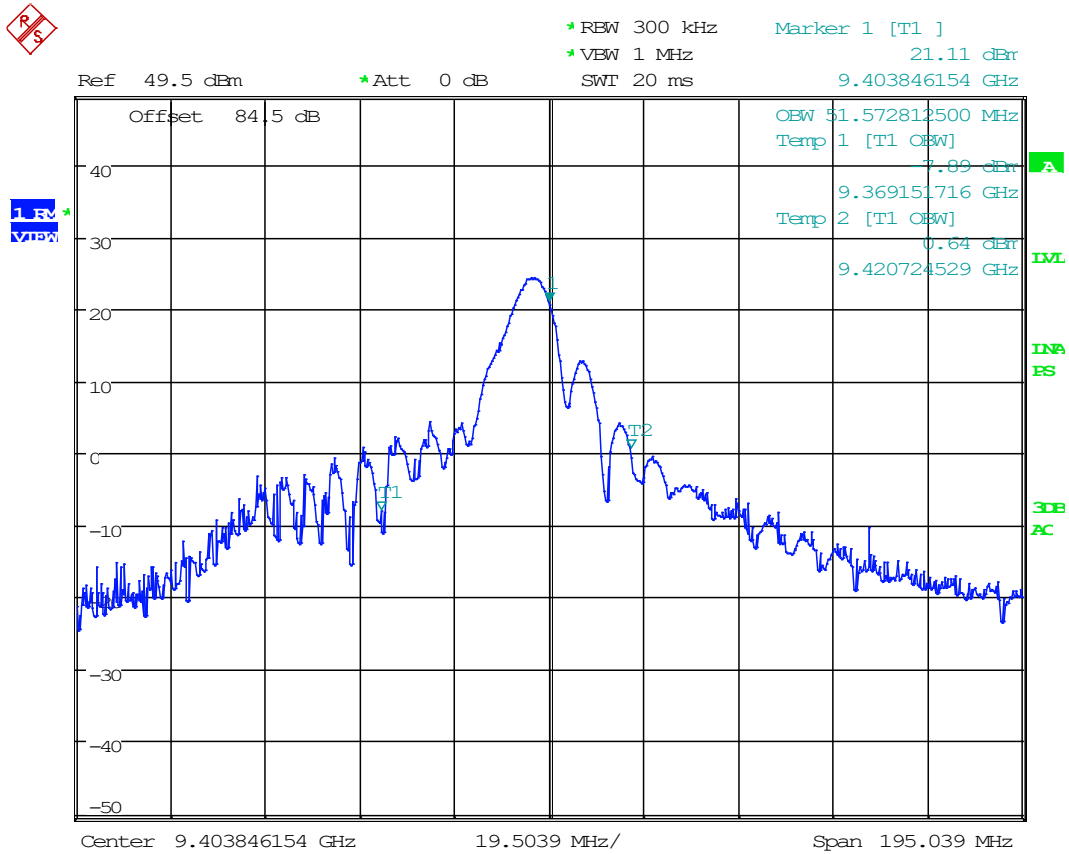

Date: 15.APR.2021 10:56:19

### 8.3.3 Bandwidth Plot, 99%, 9402 MHz, 8 nm

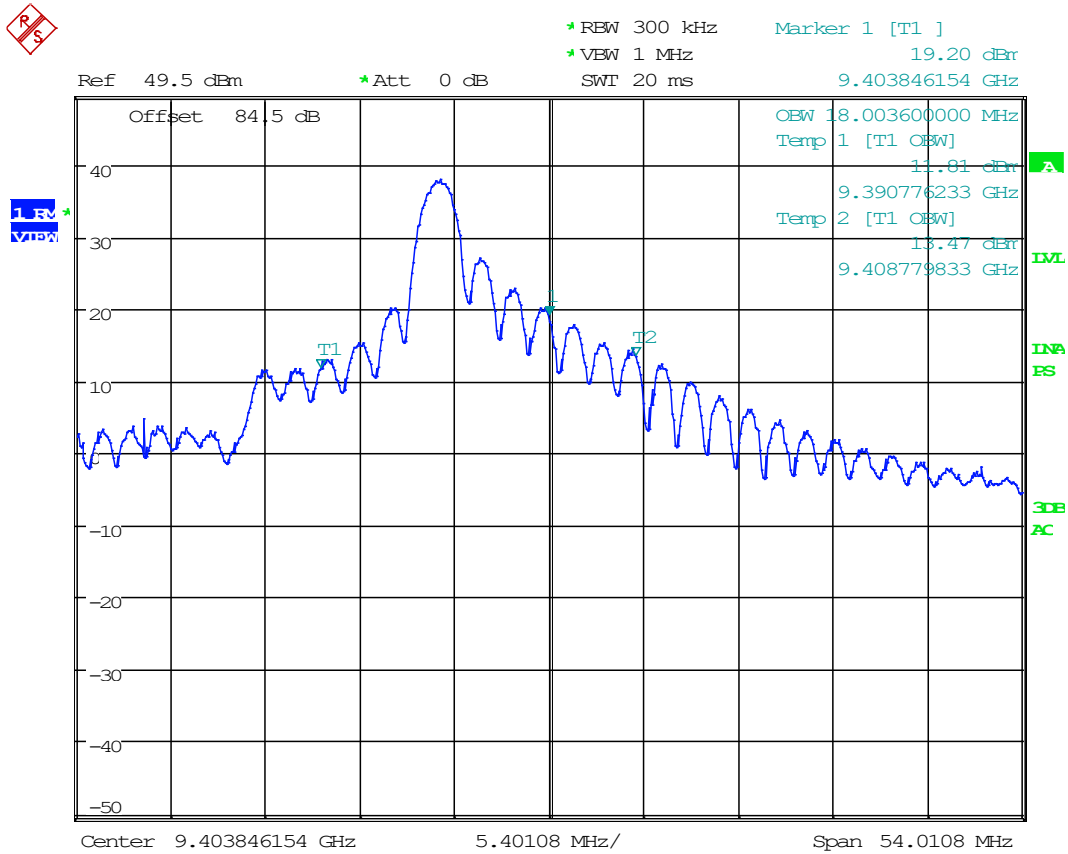

Date: 15.APR.2021 10:58:05



### 8.3.4 Bandwidth Plot, 40 dB BW, 9402 MHz, 0.25 nm

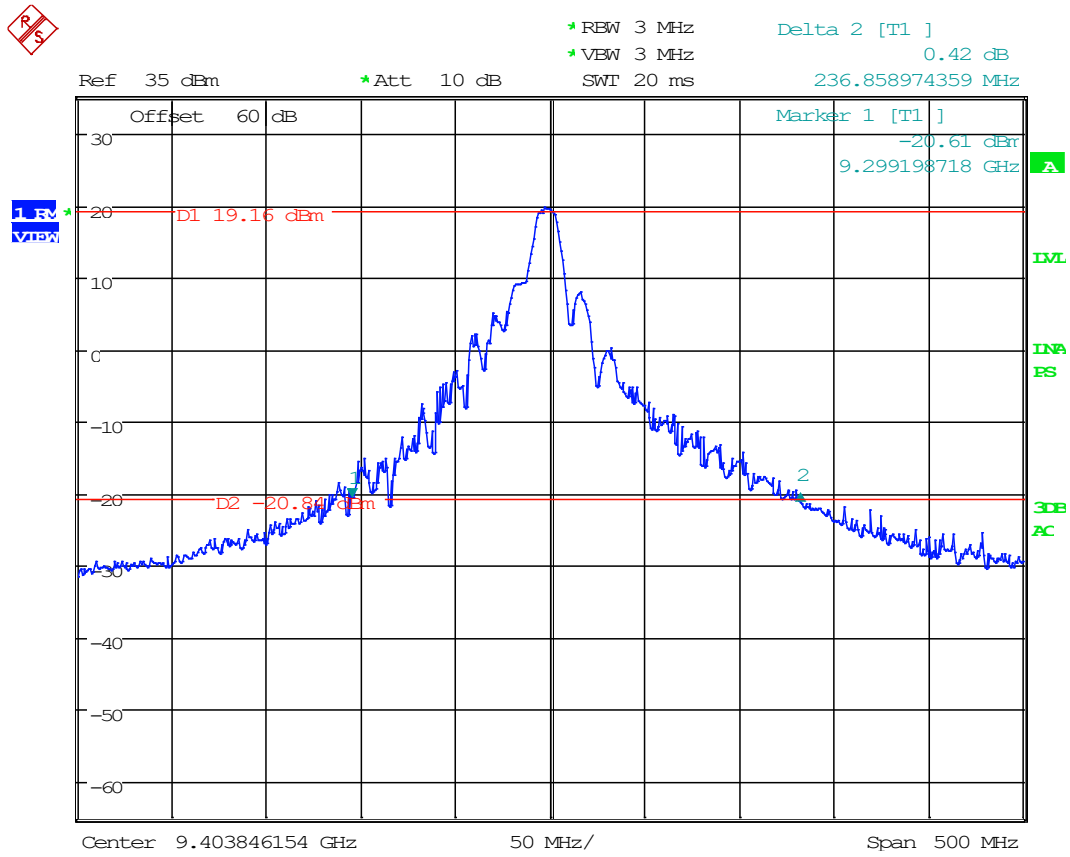

Date: 15.APR.2021 11:49:36

### 8.3.5 Bandwidth Plot, 40 dB BW, 9402 MHz, 3 nm

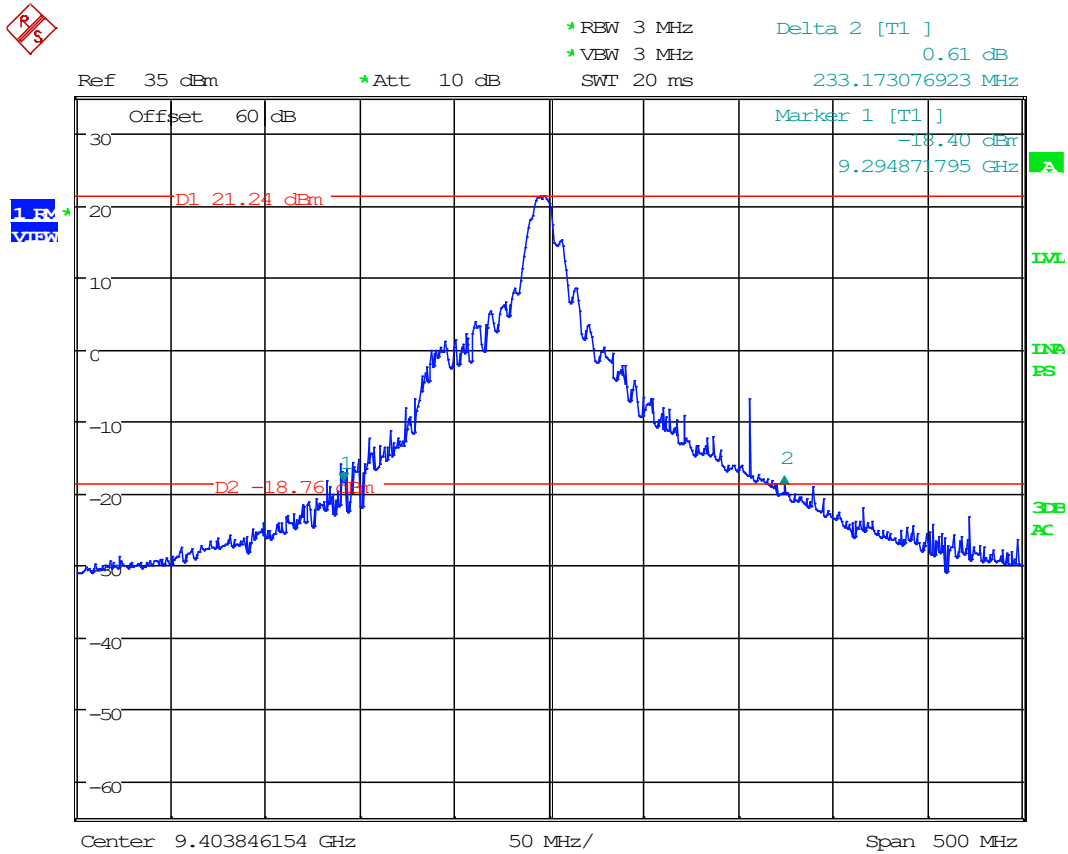

Date: 15.APR.2021 11:55:31

### 8.3.6 Bandwidth Plot, 40 dB BW, 9402 MHz, 8 nm

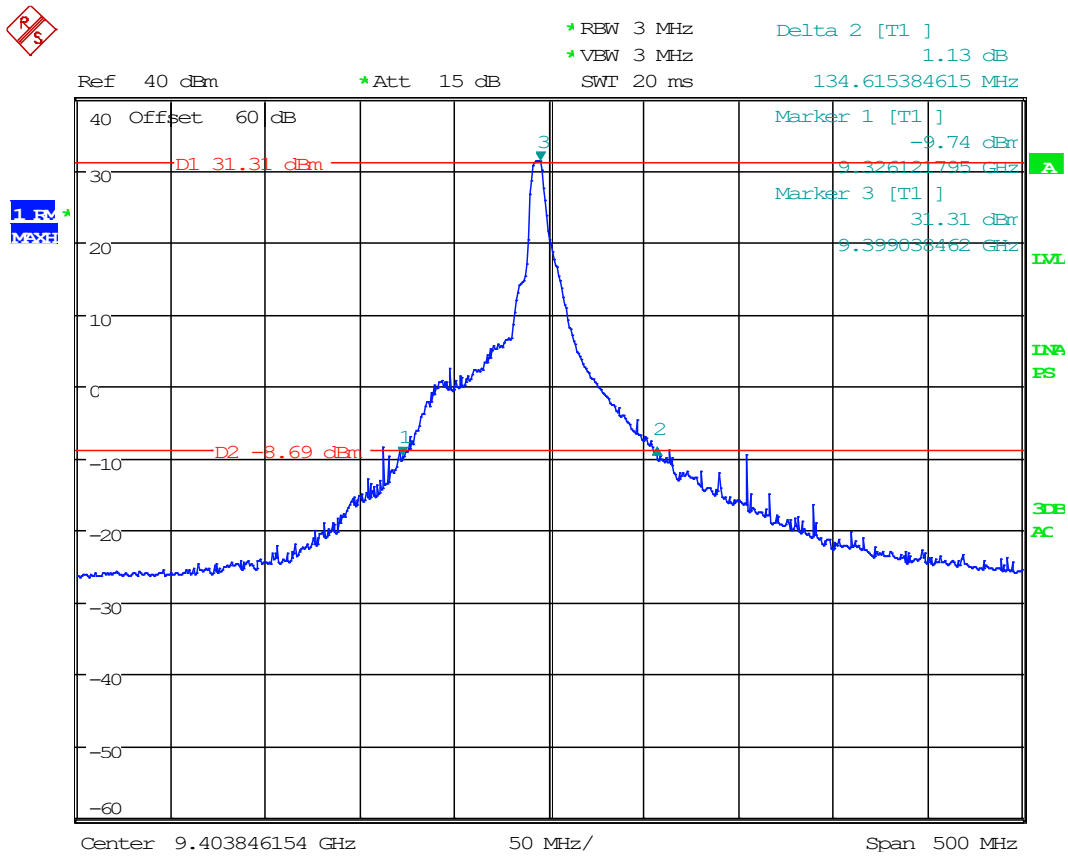

Date: 15.APR.2021 11:59:01

## 8.4 Emission Limitations, In-Band

Limits from FCC Parts 80.211 (f) and test procedure from ANSI C63.26-2015.

### Conducted Test Setup

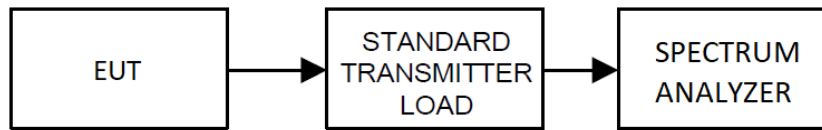

### Conducted Emissions Mask, Spectrum Plots

#### 8.4.1 Emission Mask, 9402 MHz, 0.25 nm

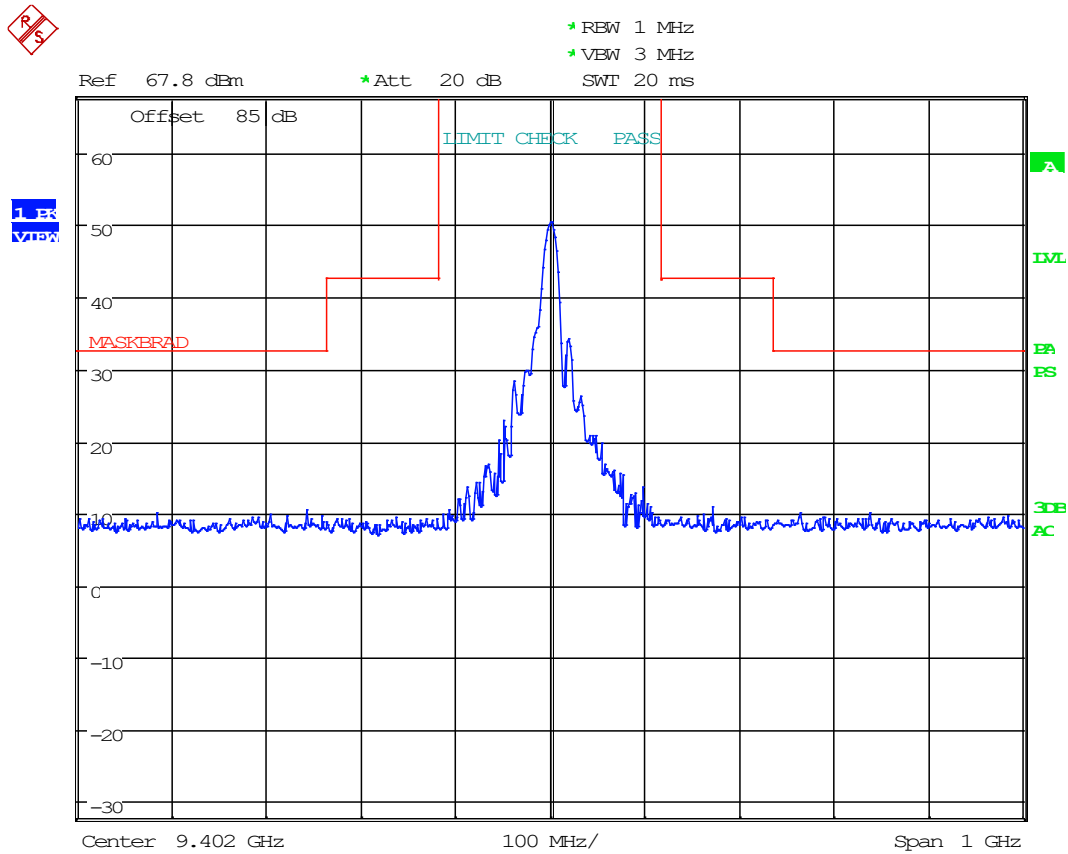

Date: 15.APR.2021 17:09:50

### 8.4.2 Emission Mask, 9402 MHz, 3 nm

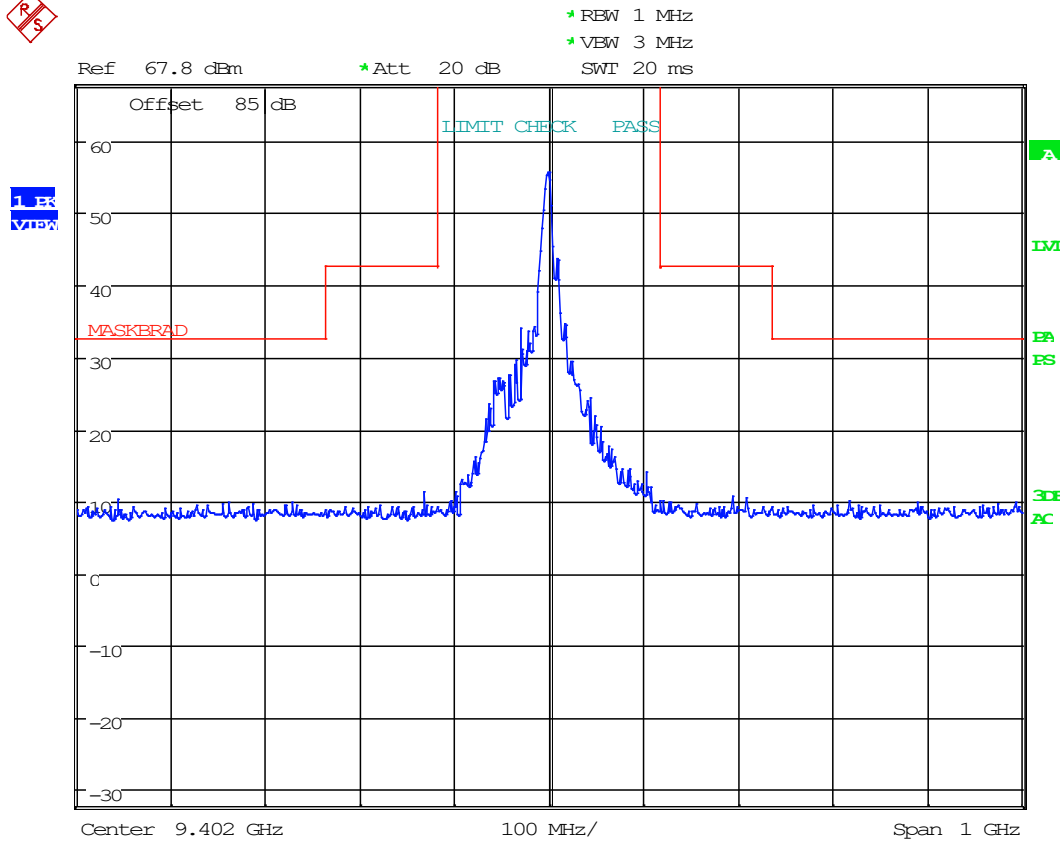

Date: 15.APR.2021 17:14:43

### 8.4.3 Emission Mask, 9402 MHz, 8 nm

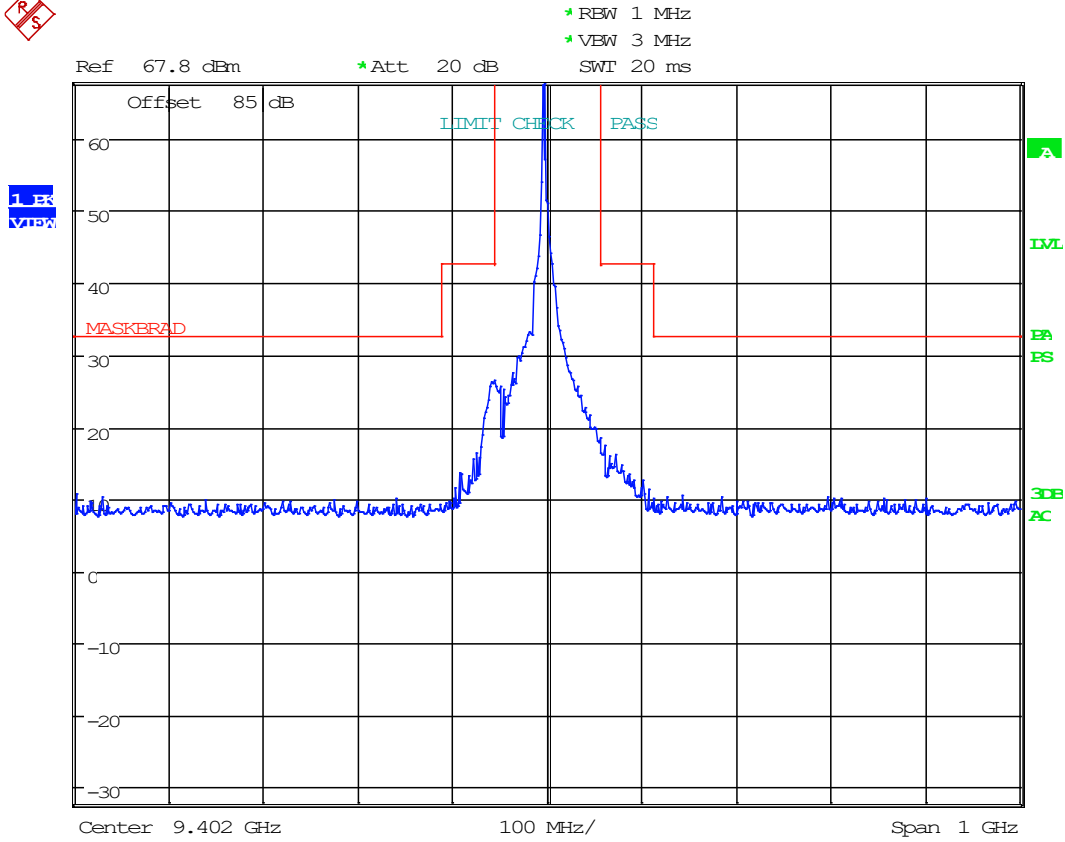

Date: 15.APR.2021 17:18:33

## 8.5 Emission Limitations, Out-of-Band

Limits from FCC Parts 2.1051, 80.211 (f), 87.139 (a), and 90.210 (n); and test procedure from ANSI C63.26-2015.

### Conducted Test Setup

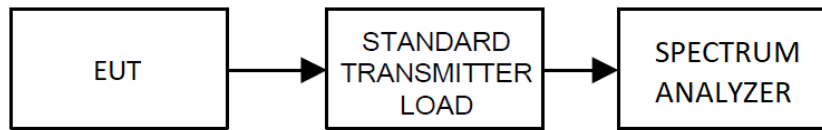



## Conducted Emissions Spectrum Plots

### 8.5.1 Conducted Emissions 30 MHz to 1 GHz, 9402 MHz, 0.25 nm

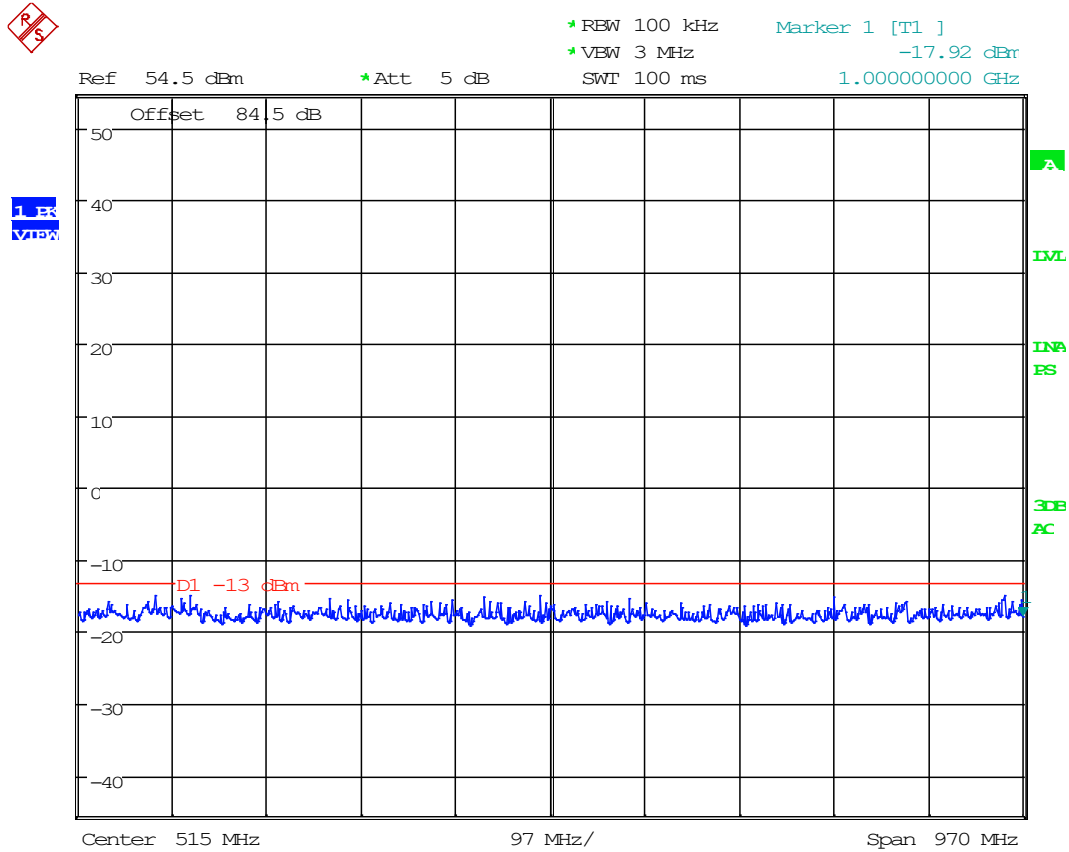

Date: 15.APR.2021 13:00:26

### 8.5.2 Conducted Emissions 1 GHz to Band Edge, 9402 MHz, 0.25 nm

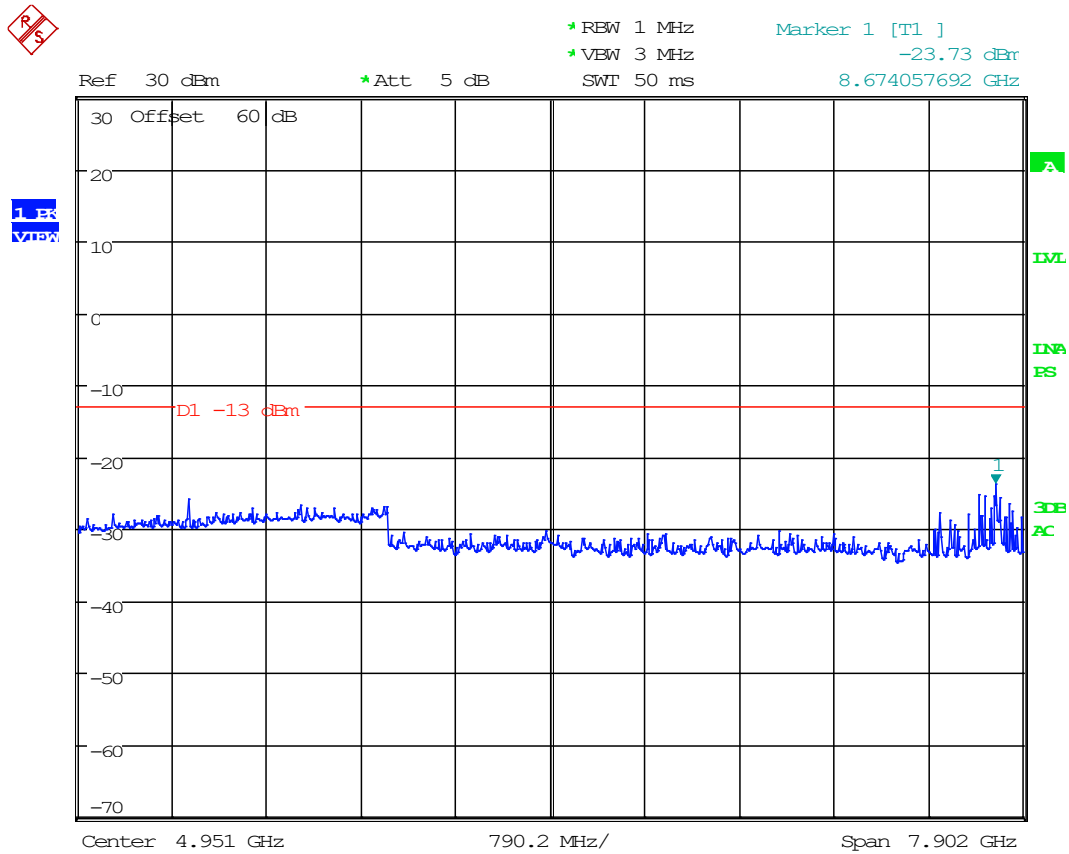

Date: 15.APR.2021 13:08:58

### 8.5.3 Conducted Emissions Band Edge to 40 GHz , 9402 MHz, 0.25 nm

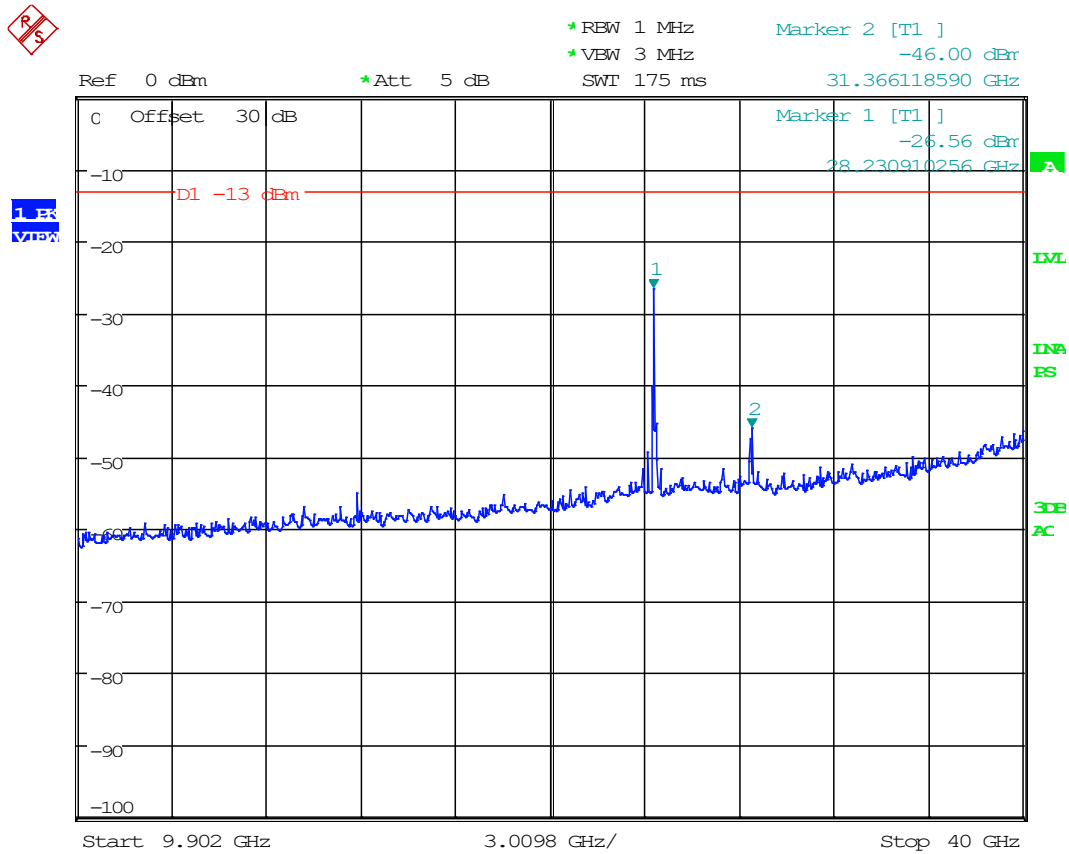

Date: 15.APR.2021 13:21:14

### 8.5.4 Conducted Emissions 30 MHz to 1 GHz, 9402 MHz, 3 nm

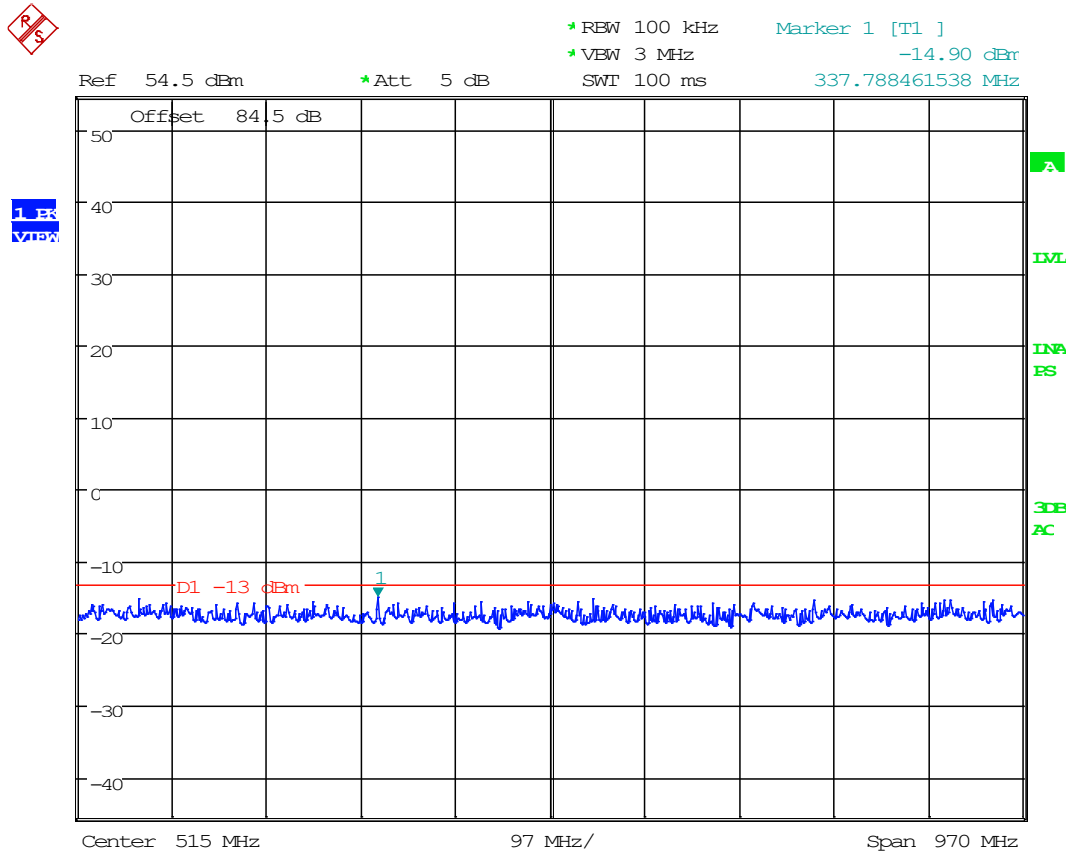

Date: 15.APR.2021 13:02:54

### 8.5.5 Conducted Emissions 1 GHz to Band Edge, 9402 MHz, 3 nm

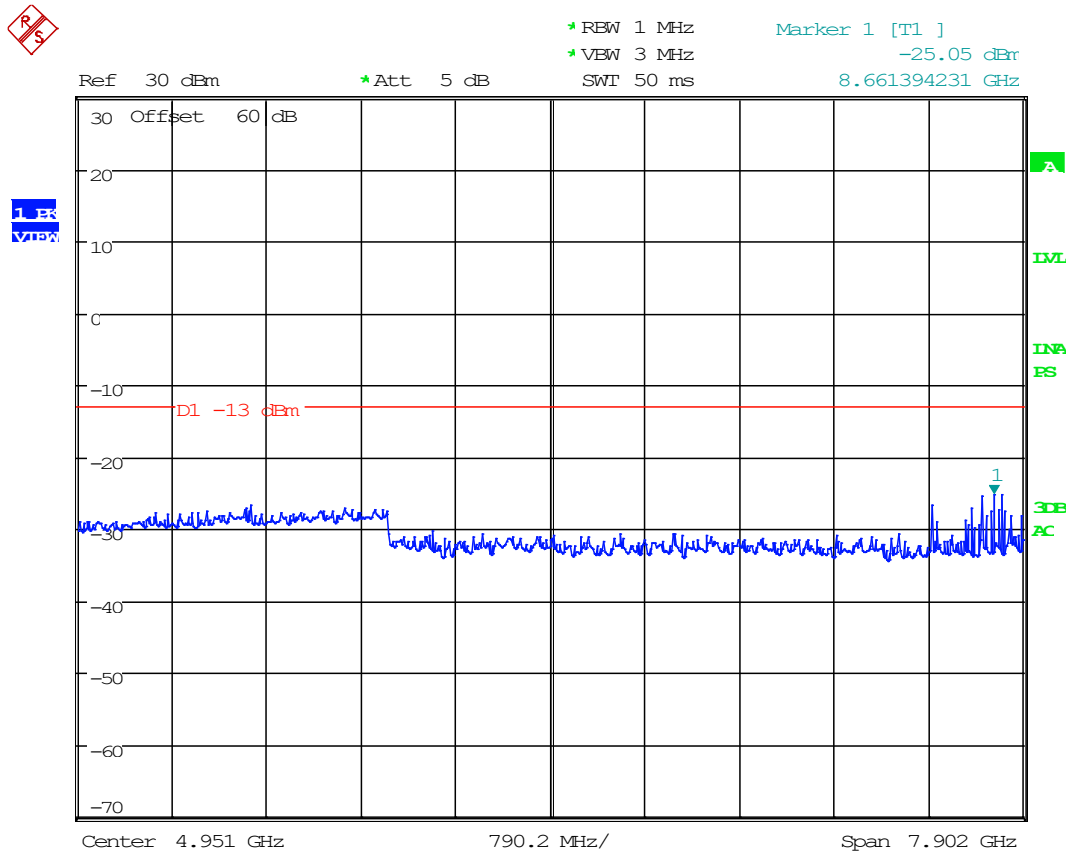

Date: 15.APR.2021 13:10:34

### 8.5.6 Conducted Emissions Band Edge to 40 GHz , 9402 MHz, 3 nm

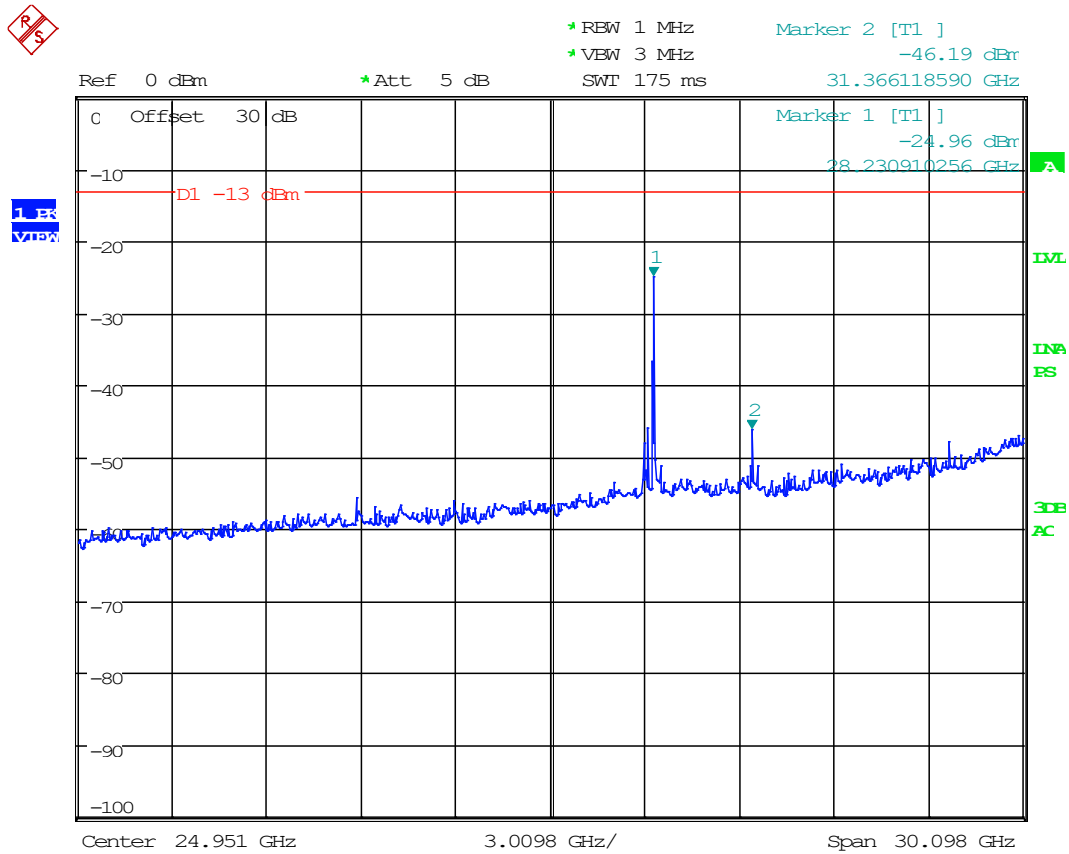

Date: 15.APR.2021 13:23:15

### 8.5.7 Conducted Emissions 30 MHz to 1 GHz, 9402 MHz, 8 nm

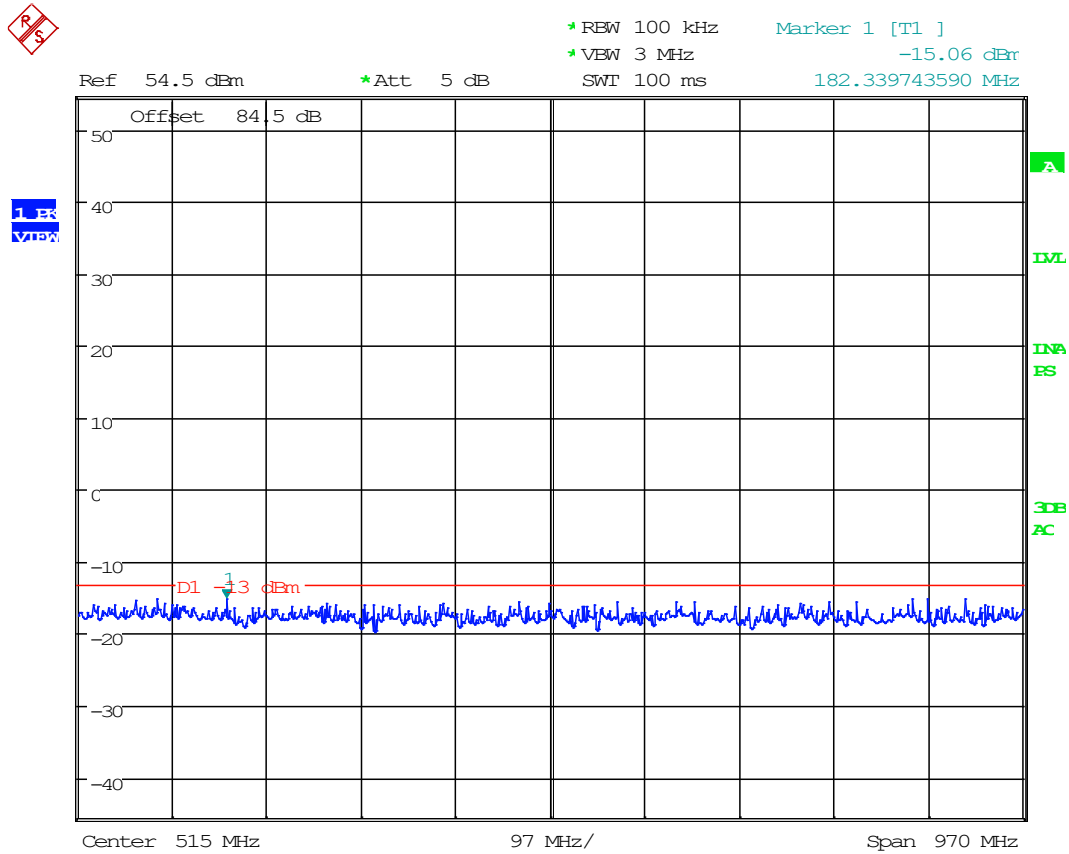

Date: 15.APR.2021 13:03:35

### 8.5.8 Conducted Emissions 1 GHz to Band Edge, 9402 MHz, 8 nm

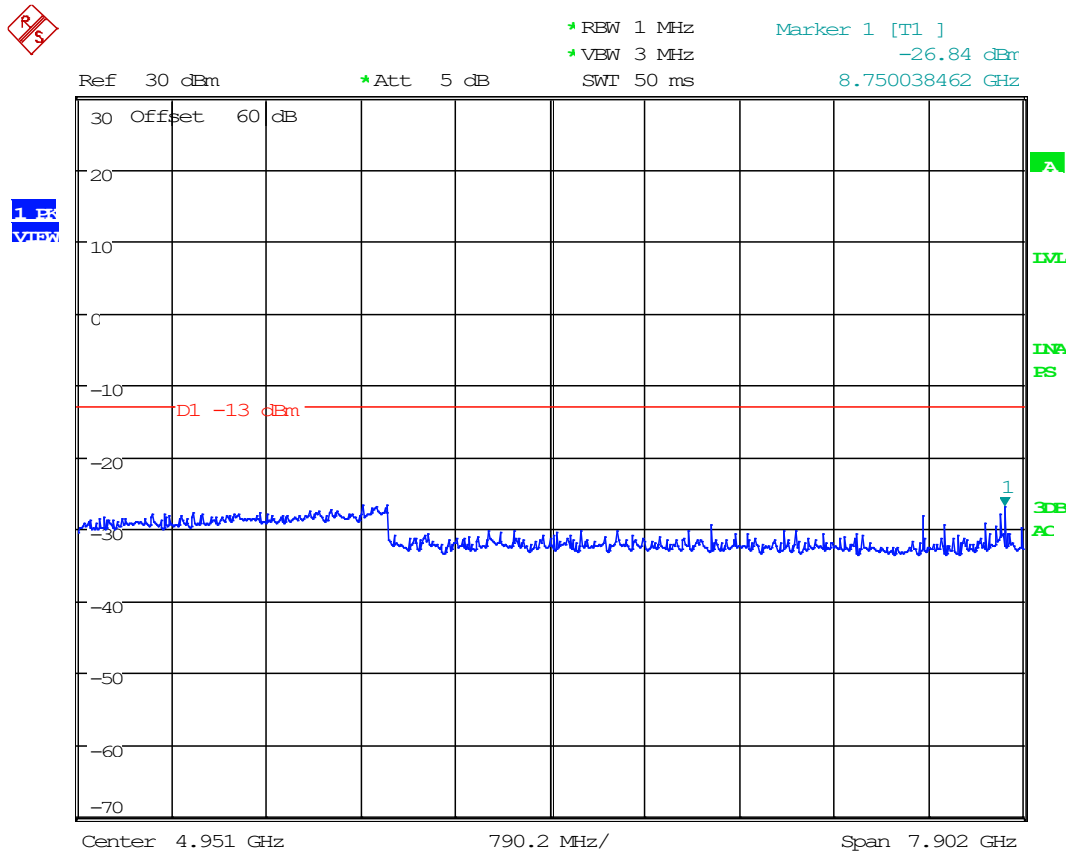

Date: 15.APR.2021 13:11:16





### 8.5.10 Conducted Emissions Band Edge to 40 GHz , 9402 MHz, 8 nm

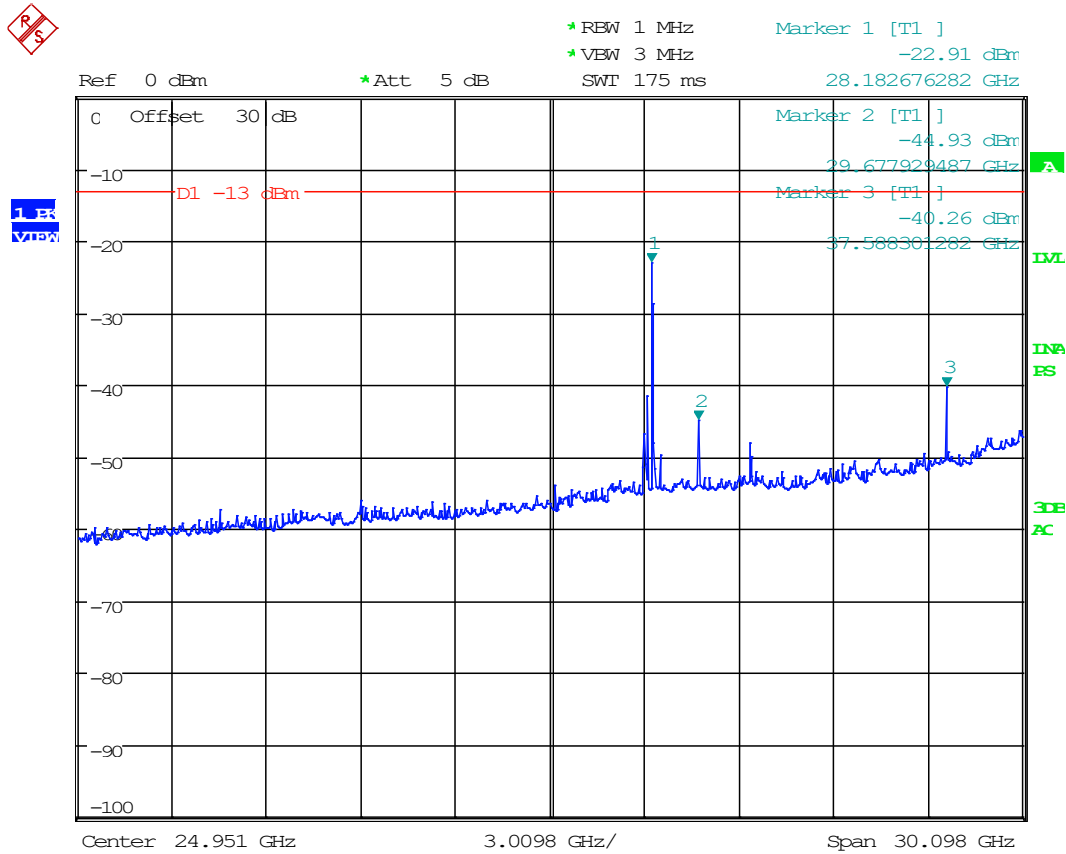

Date: 15.APR.2021 13:24:06

## 8.6 Radiated Emissions

Limits from FCC Parts 2.1053, 80.211 (f), 87.139 (a), and 90.210 (n); and test procedure from ANSI C63.26-2015.

### Radiated Test Setup, 30 – 1000 MHz

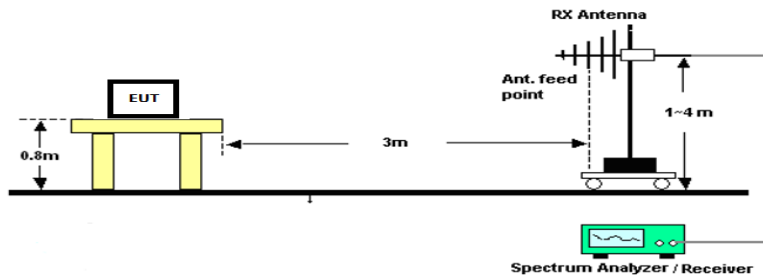

### Radiated Test Setup, Above 1000 MHz

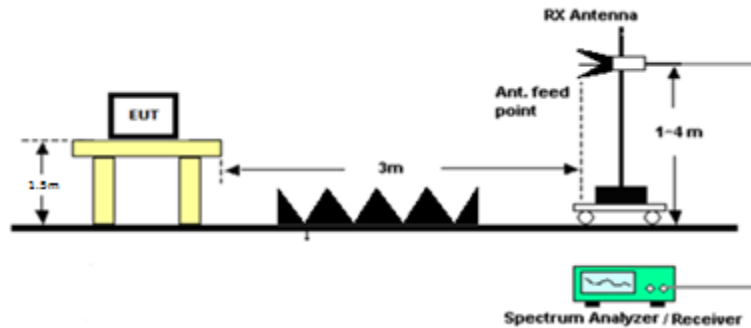

## Radiated Emissions, Tabular Data

### 8.6.1 Radiated Emissions, 9402 MHz. 0.25 nm

Tuned Frequency (MHz)	Emission Frequency (MHz)	Detector	Meter Reading (dBuV)	Antenna Polarity	Coax Loss (dB)	Antenna Correction Factor (dB/m)	Distance (m)	Field Strength (dBuV/m)	ERP (dBm)	Spurious Limit (dBm)	Margin (dB)
9402.00	241.02	PK	60.00	V	1.78	10.56	3.00	72.34	-25.03	-13.00	12.03
9402.00	462.80	PK	49.58	V	2.50	15.88	3.00	67.96	-29.42	-13.00	16.42
9402.00	167.85	PK	35.68	H	1.50	15.52	3.00	52.70	-44.68	-13.00	31.68
9402.00	41.98	PK	37.46	V	0.72	13.10	3.00	51.29	-46.09	-13.00	33.09
9402.00	579.48	PK	53.79	V	2.86	18.18	3.00	74.83	-22.55	-13.00	9.55
9402.00	168.66	PK	32.60	V	1.51	15.43	3.00	49.54	-47.83	-13.00	34.83
9402.00	244.87	PK	56.14	H	1.83	10.79	3.00	68.76	-28.62	-13.00	15.62
9402.00	458.90	PK	46.21	H	2.49	15.62	3.00	64.32	-33.06	-13.00	20.06
9402.00	580.76	PK	50.32	H	2.86	18.26	3.00	71.44	-25.94	-13.00	12.94
9402.00	18804.00	PK	7.01	H	15.57	44.74	3.00	67.33	-30.05	-13.00	17.05
9402.00	18804.00	PK	6.85	V	15.57	44.74	3.00	67.17	-30.21	-13.00	17.21
9402.00	28206.00	PK	16.47	H	18.81	46.82	3.00	82.10	-15.28	-13.00	2.28
9402.00	28206.00	PK	14.00	V	18.81	46.82	3.00	79.63	-17.75	-13.00	4.75
9402.00	37608.00	PK	14.38	H	22.69	45.74	3.00	82.80	-14.57	-13.00	1.57
9402.00	37608.00	PK	12.90	V	22.69	45.74	3.00	81.32	-16.05	-13.00	3.05

### 8.6.2 Radiated Emissions, 9402 MHz. 3 nm

Tuned Frequency (MHz)	Emission Frequency (MHz)	Detector	Meter Reading (dBuV)	Antenna Polarity	Coax Loss (dB)	Antenna Correction Factor (dB/m)	Distance (m)	Field Strength (dBuV/m)	ERP (dBm)	Spurious Limit (dBm)	Margin (dB)
9402.00	168.66	PK	32.06	V	1.51	15.43	3.00	49.00	-48.37	-13.00	35.37
9402.00	42.26	PK	37.94	V	0.73	13.05	3.00	51.72	-45.66	-13.00	32.66
9402.00	45.53	PK	37.19	H	0.77	12.44	3.00	50.40	-46.98	-13.00	33.98
9402.00	169.49	PK	36.48	V	1.52	15.35	3.00	53.35	-44.03	-13.00	31.03
9402.00	251.28	PK	57.79	H	1.91	11.33	3.00	71.02	-26.35	-13.00	13.35
9402.00	247.44	PK	61.15	V	1.86	11.00	3.00	74.00	-23.37	-13.00	10.37
9402.00	456.40	PK	52.04	V	2.48	15.67	3.00	70.19	-27.19	-13.00	14.19
9402.00	455.13	PK	45.57	H	2.48	15.70	3.00	63.74	-33.63	-13.00	20.63
9402.00	583.33	PK	53.54	H	2.86	18.47	3.00	74.87	-22.51	-13.00	9.51
9402.00	585.90	PK	55.29	V	2.87	18.56	3.00	76.72	-20.66	-13.00	7.66
9402.00	18804.00	PK	6.27	H	15.57	44.74	3.00	66.59	-30.79	-13.00	17.79
9402.00	18804.00	PK	6.14	V	15.57	44.74	3.00	66.46	-30.92	-13.00	17.92
9402.00	28206.00	PK	13.60	H	18.81	46.82	3.00	79.23	-18.15	-13.00	5.15
9402.00	28206.00	PK	15.16	V	18.81	46.82	3.00	80.79	-16.59	-13.00	3.59
9402.00	37608.00	PK	14.85	H	22.69	45.74	3.00	83.27	-14.10	-13.00	1.10
9402.00	37608.00	PK	14.75	V	22.69	45.74	3.00	83.17	-14.20	-13.00	1.20

### 8.6.3 Radiated Emissions, 9402 MHz. 8 nm

Tuned Frequency (MHz)	Emission Frequency (MHz)	Detector	Meter Reading (dBuV)	Antenna Polarity	Coax Loss (dB)	Antenna Correction Factor (dB)	Distance (m)	Field Strength (dBuV/m)	ERP (dBm)	Spurious Limit (dBm)	Margin (dB)
9402.00	169.49	PK	35.31	H	1.52	15.35	3.00	52.18	-45.20	-13.00	32.20
9402.00	169.49	PK	33.09	V	1.52	15.35	3.00	49.96	-47.42	-13.00	34.42
9402.00	42.26	PK	37.05	V	0.73	13.05	3.00	50.83	-46.55	-13.00	33.55
9402.00	242.30	PK	54.74	H	1.80	10.64	3.00	67.18	-30.20	-13.00	17.20
9402.00	247.44	PK	58.74	V	1.86	11.00	3.00	71.59	-25.78	-13.00	12.78
9402.00	460.26	PK	49.02	V	2.49	15.63	3.00	67.14	-30.24	-13.00	17.24
9402.00	456.41	PK	45.80	H	2.48	15.67	3.00	63.95	-33.43	-13.00	20.43
9402.00	587.18	PK	49.47	V	2.87	18.51	3.00	70.85	-26.53	-13.00	13.53
9402.00	578.20	PK	50.07	H	2.86	18.13	3.00	71.06	-26.32	-13.00	13.32
9402.00	18804.00	PK	7.37	H	15.57	44.74	3.00	67.69	-29.69	-13.00	16.69
9402.00	18804.00	PK	7.06	V	15.57	44.74	3.00	67.38	-30.00	-13.00	17.00
9402.00	28206.00	PK	14.71	H	18.81	46.82	3.00	80.34	-17.04	-13.00	4.04
9402.00	28206.00	PK	13.96	V	18.81	46.82	3.00	79.59	-17.79	-13.00	4.79
9402.00	37608.00	PK	14.07	V	22.69	45.74	3.00	82.49	-14.88	-13.00	1.88
9402.00	37608.00	PK	14.24	H	22.69	45.74	3.00	82.66	-14.71	-13.00	1.71

## 8.7 Modulation Characteristics

Limits from FCC Parts 2.1047, 80.213 (g), and test procedure from ANSI C63.26-2015

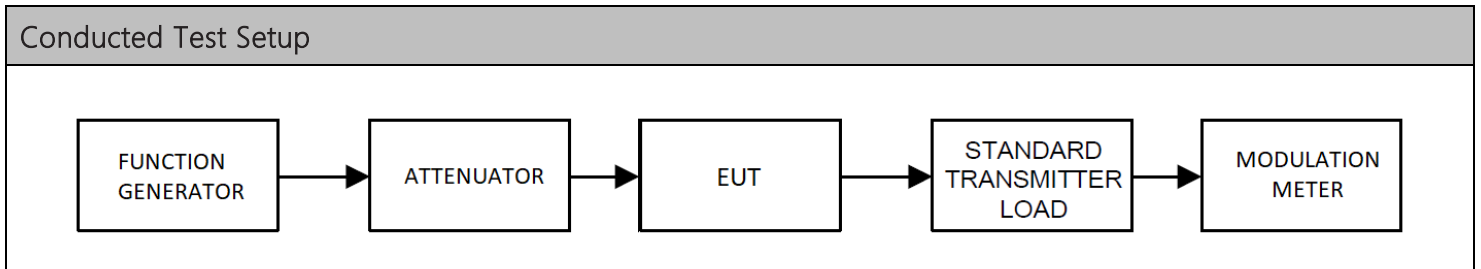

**FCC 80.213(g) – Device is allowed any modulation type.**

### 8.7.1 Audio Frequency Response

**N/A. Device does not carry Audio.**

### 8.7.2 Low Pass Filter Response

**N/A. Device does not carry Audio.**

### 8.7.3 Modulation Limiting

**N/A. Device does not need to limit modulation.**

## 8.8 Frequency Stability

Limits from FCC Parts 2.1055, 80.209 (c), and test procedure from ANSI C63.26-2015.

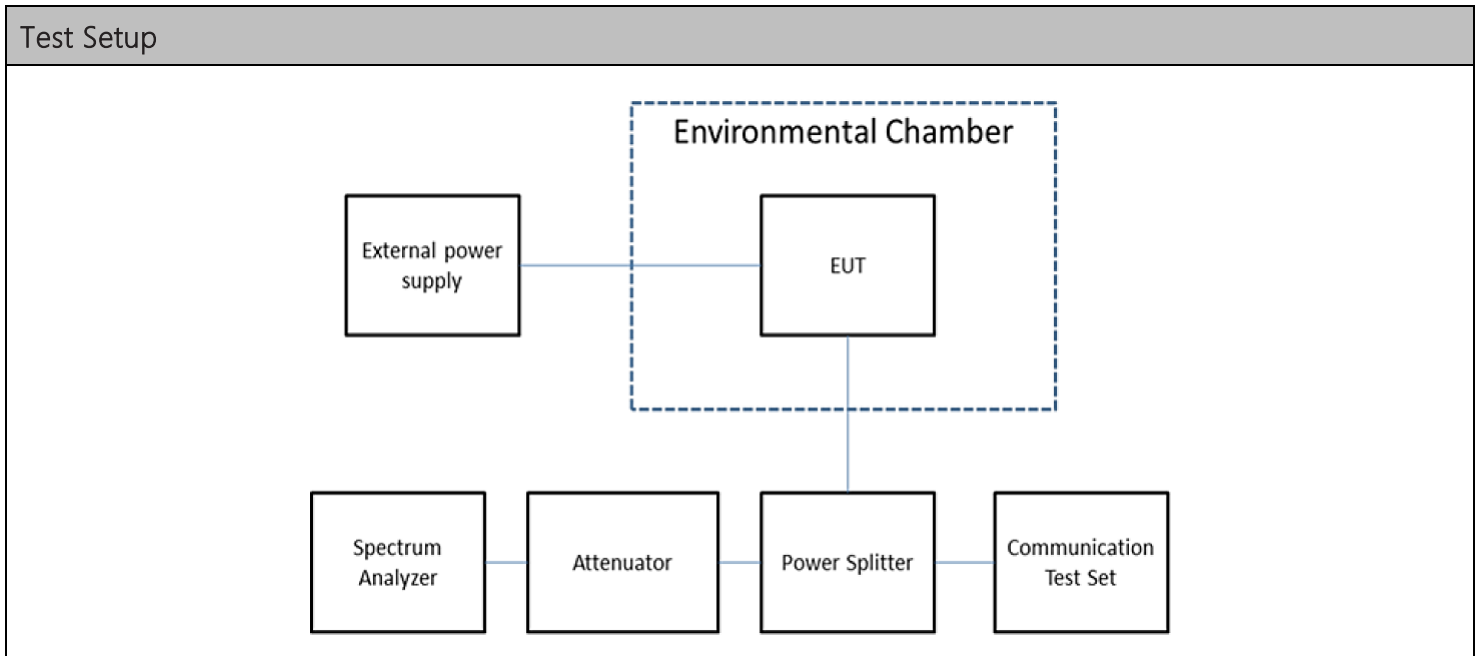

Test Results, Mode 1		
Tuned Frequency (MHz)	Max Deviation (ppm)	Limit (ppm)
9100.0	396	1250

**Note:** This EUT is designed to operate within FCC Parts 80 and in accordance with ISED RSS-238.

**Note:** The frequency determining element is the same component for both low and high ranges. The Frequency Stability testing was not repeated for both bands.

## Frequency Stability, Tabular Data

### 8.8.1 Frequency Stability Data

Limit (ppm)	1250.00		
Limit (Hz)	11754253.513		
Lower Limit (MHz)	9391.648556		
Upper Limit (MHz)	9415.157064		
Rated Supply Voltage	24.0	<input type="radio"/> AC	<input checked="" type="radio"/> DC
Temperature / Voltage Variation			
Temperature (°C)	Supplied Voltage (V)	Frequency (MHz)	Deviation (kHz)
-30	24.0	9403.002000	400.810
-20	24.0	9403.803610	-400.800
-10	24.0	9403.402806	0.004
0	24.0	9403.002000	400.810
+10	24.0	9403.401200	1.610
+20 (reference)	24.0	9403.402810	0.000
+20	20.4	9403.402810	0.000
+20	27.6	9403.402810	0.000
+30	24.0	9403.402810	0.000
+40	24.0	9403.402810	0.000
+50	24.0	9403.402800	0.010



### 8.8.2 Frequency Stability Plot

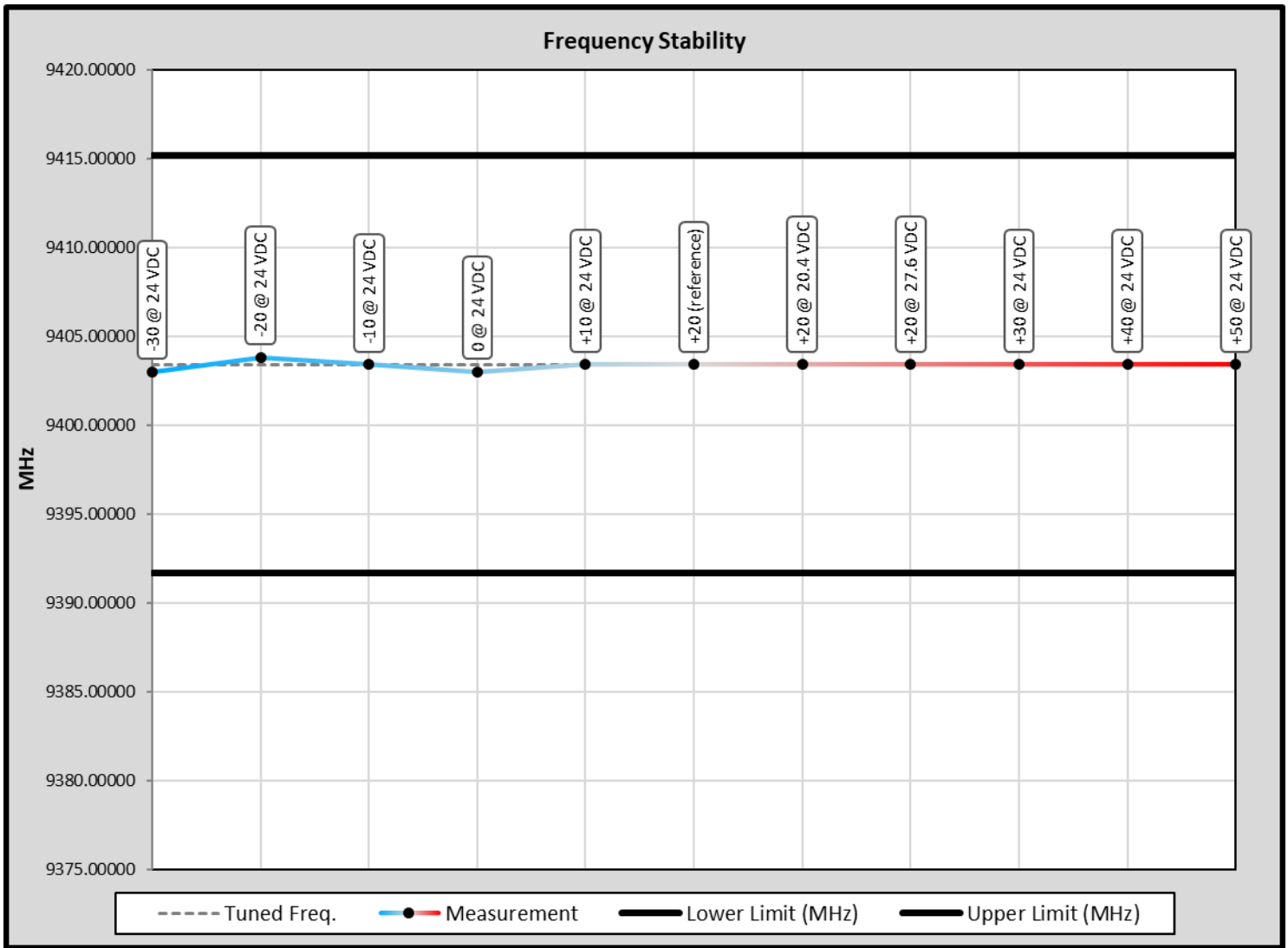

## 8.9 Transient Frequency Behavior

Limits from test procedure from ANSI C63.26-2015.

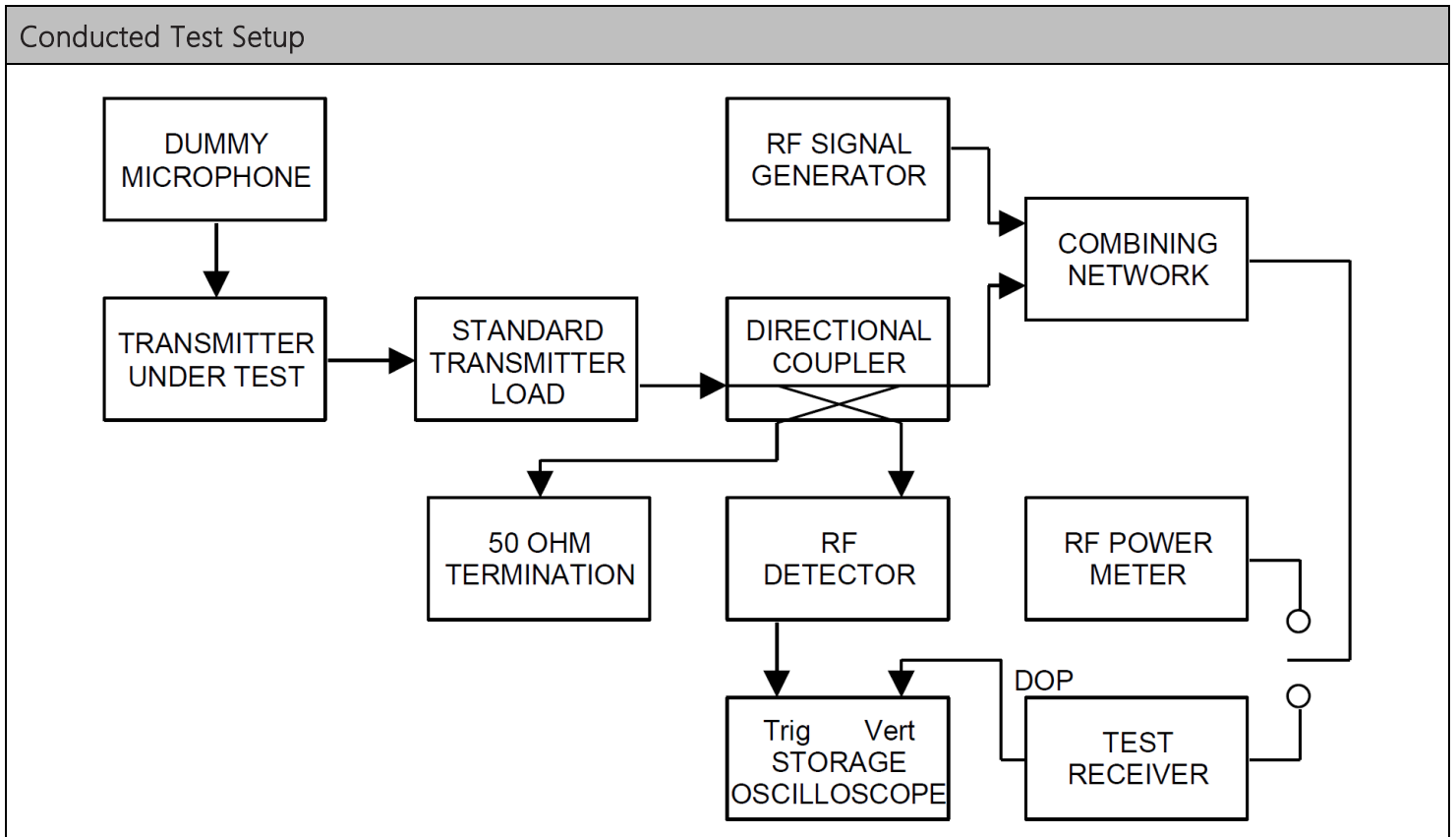

**N/A. Device does not operate in a band requiring TFR measurement.**

### 8.10 Adjacent channel power limits

Limits from and test procedure from ANSI C63.26-2015.

#### Conducted Test Setup

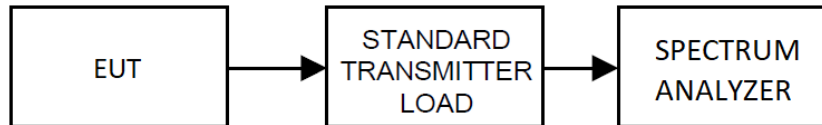

**N/A. Device does not operate in a band requiring ACP measurement.**

## 9. ANNEX-A - Photographs of the EUT

Photographs of the EUT and any manufacturer supplied accessories to be used with the EUT are in separate supplementary documents labelled EXTERNAL PHOTOS and INTERNAL PHOTOS.

## 10. ANNEX-B – Test Setup Photographs

Test setup photographs are located in a separate supplementary ANNEX-B document.

## 11. History of Test Report Changes

Test Report #	Revision #	Description	Date of Issue
TR_1573-21_FCC_PT80_1	1	Initial release	April 30, 2021
	2	Revised Pages 7, 12 & 13	June 22, 2021
	3	Clerical Update – Model #	July 1, 2021

---

END OF TEST REPORT