**COMPLIANCE WORLDWIDE INC.
TEST REPORT 318-18**

**In Accordance with the Requirements of
Federal Communications Commission Part 15.247, Subpart C
Innovation, Science and Economic Development Canada RSS 247, Issue 2
Digital Transmission Systems (DTSS), Frequency Hopping Systems (FHSs)
and License-Exempt Local Area Network (LE-LAN) Devices**

**Issued to
The Coca Cola Company
1 Coca-Cola Plaza, Freestyle Products
Atlanta, GA 30313**

**for the
PN 0015252 RFID Switching Antenna 12 SW
RFID Reader Antenna**

**FCC ID: 2ADIR-XQ8-FS-RFID
IC: 8593A-XQ8FSRFID**

Report Issued on October 21, 2018

Tested by



Brian F. Breault

Reviewed by



Larry K. Stillings

This test report shall not be reproduced, except in full, without written permission from Compliance Worldwide, Inc.

Table of Contents

1. Scope	3
2. Product Details	3
2.1. Manufacturer	3
2.2. Model Number	3
2.3. Serial Number.....	3
2.4. Description of EUT	3
2.5. Power Source	3
2.6. EMC Modifications.....	3
3. Product Configuration.....	4
3.1. Support Equipment.....	4
3.2. Cables	4
3.3. Operational Characteristics & Software.....	4
3.4. Block Diagram	4
4. Measurements Parameters	5
4.1. Measurement Equipment Used to Perform Test	5
4.2. Measurement & Equipment Setup.....	6
4.3. Measurement Procedure	6
4.4. Measurement Uncertainty	6
5. Choice of Equipment for Test Suites	7
5.1. Choice of Model.....	7
5.2. Presentation	7
5.3. Choice of Operating Frequencies	7
6. Measurement Summary	8
7. Measurement Data	9
7.1. Antenna Requirement.....	9
7.2. Frequency Hopping Requirements.....	9
7.3. Maximum Peak Conducted Output Power	20
7.4. Operation with directional antenna gains greater than 6 dBi	27
7.5. Emissions Outside of the Frequency Band	27
7.6. Transmitter Spurious Radiated Emissions	30
7.7. Spurious Radiated Emissions – Harmonic Emissions.....	35
7.8. Conducted Emissions.....	38
7.9. Public Exposure to Radio Frequency Energy Levels	41
8. Test Site Description	42
9. Test Setup Photographs.....	43

1. Scope

This test report certifies that The Coca Cola Company PN 0015252 RFID Antenna 12 SW, as tested, meets the FCC Part 15, Subpart C and Industry Canada RSS 247, Issue 2 requirements. The scope of this test report is limited to the test sample provided by the client, only in as much as that sample represents other production units. If any significant changes are made to the unit, the changes shall be evaluated and a retest may be required.

2. Product Details

- 2.1. Manufacturer:** The Coca Cola Company
- 2.2. Model Number:** PN 0015252 RFID Switching Antenna 12 SW
- 2.3. Serial Number:** 17828252
- 2.4. Description:** This device is intended for use as a radio frequency identification (RFID) component used in Coca-Cola freestyle dispenser products.
- 2.5. Power Source:** 5 VDC via USB, 120 Volts, 60 Hz
- 2.6. Hardware Revs.:** Rev 0-00
- 2.7. Software Rev.:** N/A
- 2.8. EMC Modifications:** None

3. Product Configuration

3.1. Support Equipment

Device	Manufacturer	Model	Serial No.	Comment
Laptop	Lenovo	ThinkPad T440S	20ARS0AS00PF 019AAT	
Laptop Power Supply	Lenovo	65W-20V-AC-Adapter		

3.2. Cables

Cable Type	Length	Shield	From	To
USB Cable	3M	Yes	EUT	Laptop
Power Cable / Supply	2M + 1M	Yes	Laptop	120 VAC, 60 Hz

3.3. Operational Characteristics & Software

1. After boot up on the laptop, connect the RFID Reader USB Module.
2. Using the RFID Tag Reader Software, connect to the module using USB COM4
3. Connect to Reader. Select Ant, Select Slot under Bluebird Demo Tab, Press Start

3.4. Block Diagram

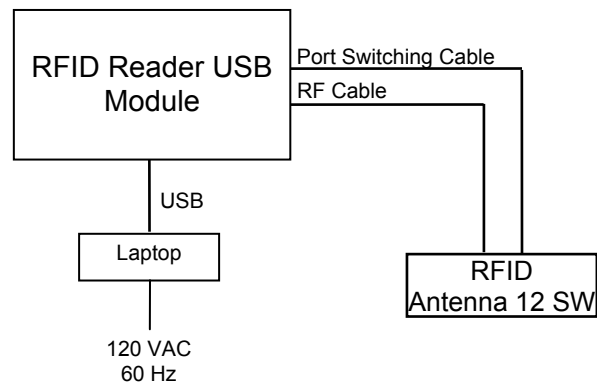

4. Measurements Parameters

4.1. Measurement Equipment Used to Perform Test

Device	Manufacturer	Model No.	Serial No.	Cal Due	Interval
EMI Test Receiver, 9kHz - 7GHz ¹	Rohde & Schwarz	ESR7	101156	09/10/2021	2 Years
Spectrum Analyzer 20 Hz – 40 GHz ²	Rohde & Schwarz	FSV40	100899	09/10/2021	3 Years
Spectrum Analyzer, 9 kHz - 40 GHz ³	Rohde & Schwarz	FSVR40	100909	5/3/2019	2 Years
Spectrum Analyzer, 2 Hz - 26 GHz ⁴	Rohde & Schwarz	FSW26	102057	09/13/2020	2 Years
EMI Receiver	Hewlett Packard	8546A	3650A00360	09/11/2020	2 Years
Passive Loop Antenna, 9 kHz to 30 MHz	EMCO	6512	9309-1139	10/26/2018	2 Years
Biconilog Antenna, 30 MHz to 2 GHz	Sunol Sciences	JB1	A050913	6/3/2019	2 Years
Horn Antenna, 960 MHz to 18 GHz	Electro-Metrics	EM-6961	6337	10/3/2020	2 Years
Preamplifier, 1 GHz to 26.5 GHz	Hewlett Packard	8449B	3008A00329	09/11/2021	3 Years
LISN 50 ohm 50 µH, 9 kHz to 30 MHz	EMCO	3825/2	9109-1860	09/10/2020	2 Years
1.8 to 9.3 GHz Band Pass Filter	Mini-Circuits	VHP-16	0341	3/9/2019	1 Year
Digital Barometer	Control Company	4195	ID236	4/3/2020	2 Years
Digital Multi-meter	Fluke	187	83030167	3/30/2019	1 Year

¹ ESR7 Firmware revision: V3.36, Date installed: 05/16/2017 Previous V2.26 SP2, installed 11/15/2016.
² FSV40 Firmware revision: V2.30 SP4, Date installed: 05/04/2016 Previous V2.30 SP1, installed 10/22/2014.
³ FSVR40 Firmware revision: V2.23 SP1, Date installed: 08/19/2016 Previous V2.23, installed 10/20/2014.
⁴ FSW26 Firmware revision: V2.61 SP1, Date installed: 04/04/2017 Previous V2.40, installed 05/04/2016.

Manufacturer	Software Description	Title or Model #	Rev.	Report Sections
Compliance Worldwide	Test Report Generation Software	Test Report Generator	1.0	7.7. Conducted Emissions

4. Measurements Parameters (continued)

4.2. Measurement & Equipment Setup

Test Dates:	8/20/2018 - 8/29/2018 9/14/2018, 9/17/2018,
Test Engineers:	Brian Breault
Normal Site Temperature (15 - 35°C):	21.2
Relative Humidity (20 -75%RH):	33
Frequency Range:	1 MHz to 9.5 GHz
Measurement Distance:	3 Meters
EMI Receiver IF Bandwidth:	9 kHz – 9 kHz to 30 MHz 120 kHz – 30 MHz to 1 GHz 1 MHz – Above 1 GHz
EMI Receiver Avg Bandwidth:	30 kHz – 9 kHz to 30 MHz 300 kHz – 30 MHz to 1 GHz 3 MHz – Above 1 GHz
Detector Function:	Peak, Quasi-Peak & Average

4.3. Measurement Procedure

Testing was performed in accordance with the requirements detailed in ANSI C63.10-2013, American National Standard of Procedures for Compliance Testing of Unlicensed Wireless Devices. In addition, FCC DA 00-705, Filing and Measurement Guidelines for Frequency Hopping Spread Spectrum Systems, was also referenced.

Test measurements were made in accordance with FCC Part 15.247, ANSI C63.10-2013 and ISED RSS-247, Issue 2 Digital Transmission System (DTSS), Frequency Hopping System (FHSs) and License-Exempt Local Area Network (LE-LAN) Devices.

The test methods used to generate the data in this test report is in accordance with ANSI C63.10-2013, American National Standard for Testing Unlicensed Wireless Devices.

4.4. Measurement Uncertainty

The following uncertainties are expressed for an expansion/coverage factor of K=2.

RF Frequency	$\pm 1 \times 10^{-8}$
Radiated Emission of Transmitter	± 4.55 dB
Radiated Emission of Receiver	± 4.55 dB
Temperature	$\pm 0.91^{\circ}$ C
Humidity	$\pm 5\%$

5. Choice of Equipment for Test Suites

5.1 Choice of Model

This test report is based on the test samples supplied by the manufacturer and are reported by the manufacturer to be equivalent to the production units.

5.2 Presentation

This test sample was tested complete with all required ancillary equipment. Refer to Section 3 of this report for product equipment configuration.

5.3 Choice of Operating Frequencies

The RFID Reader, USB utilizes 50 channels in the 902 MHz to 928 MHz frequency range. In accordance with ANSI C63.10-2013, Section 5.6, three channels are detailed in this test report:

In accordance with ANSI C63.10-2013, Section 5.6, the choice of operating frequencies selected for the testing outlined in this report was based on the lowest, middle and highest operating frequencies. The frequencies selected were:

- Low Channel – 902.750 MHz
- Middle Channel – 915.250 MHz
- High Channel – 927.250 MHz

6. Measurement Summary

Test Requirement	FCC Part 15.247 Reference	IC RSS-247 Reference	Test Report Section	Result	Comment
Antenna Requirement	15.203	RSS-GEN 6.7	7.1	Compliant	
Frequency Hopping Requirements	15.247 (a)	5.1(c)	7.2	Compliant	
Minimum 20 dB Bandwidth		5.1(c)			
Number of Hopping Channels		5.1(c)			
Channel Separation		5.1(c)			
99% Bandwidth	N/A	RSS-GEN 6.6			
Maximum Peak Conducted Output Power	15.247 (b)	5.4(a)	7.3	Compliant	
Operation with directional antenna gains greater than 6 dBi	15.247 (c)	5.4(f)	7.4	N/A	Antenna gain <6 dBi
Lower and Upper Band Edge	15.247 (d), 15.209	N/A	7.5	Compliant	
Spurious Radiated Emissions		5.5	7.6	Compliant	
Spurious Radiated Emissions (> GHz) - Harmonic Measurements		3.3 RSS-GEN 8.10	7.7	Compliant	
Power Spectral Density	15.247(e)	NR	NR	Compliant	Frequency hopping device
Conducted Emissions	FCC 15.207	N/A	7.8	Compliant	
Public Exposure to Radio Frequency Energy Levels	1.1307 (b) (1)	RSS 102, Issue 5	7.9	Compliant	

7. Measurement Data

7.1. Antenna Requirement (Section 15.203, RSS GEN 6.7)

Requirement: An intentional radiator shall be designed to ensure that no antenna other than that furnished by the responsible party shall be used with the device. The use of a permanently attached antenna or of an antenna that uses a unique coupling to the intentional radiator shall be considered sufficient to comply with the provisions of this Section.

Status: The device under test is designed specifically to mount inside an enclosure that is inaccessible to anyone but qualified company personnel.

7.2. Frequency Hopping Requirements (Section 15.247 (a), RSS-247 5.1(c))

Requirements: Frequency hopping systems shall have hopping channel carrier frequencies separated by a minimum of 25 kHz or the 20 dB bandwidth of the hopping channel, whichever is greater.

For frequency hopping systems operating in the 902-928 MHz band: if the 20 dB bandwidth of the hopping channel is less than 250 kHz, the system shall use at least 50 hopping frequencies and the average time of occupancy on any frequency shall not be greater than 0.4 seconds within a 20 second period; if the 20 dB bandwidth of the hopping channel is 250 kHz or greater, the system shall use at least 25 hopping frequencies and the average time of occupancy on any frequency shall not be greater than 0.4 seconds within a 10 second period. The maximum allowed 20 dB bandwidth of the hopping channel is 500 kHz.

7.2.1. 20 dB Bandwidth

Channel	Frequency (MHz)	20 dB Bandwidth (kHz)	Maximum 20 dB Bandwidth (kHz)	Result
Low	902.750	83.90	250	Compliant
Mid	915.250	89.78	250	Compliant
High	927.250	84.54	250	Compliant

7. Measurement Data (continued)

7.2. Frequency Hopping Requirements (Section 15.247 (a), RSS-247 5.1(c)) (continued)

7.2.1. 20 dB Bandwidth (continued)

7.2.1.1. 20 dB Bandwidth – Low Frequency

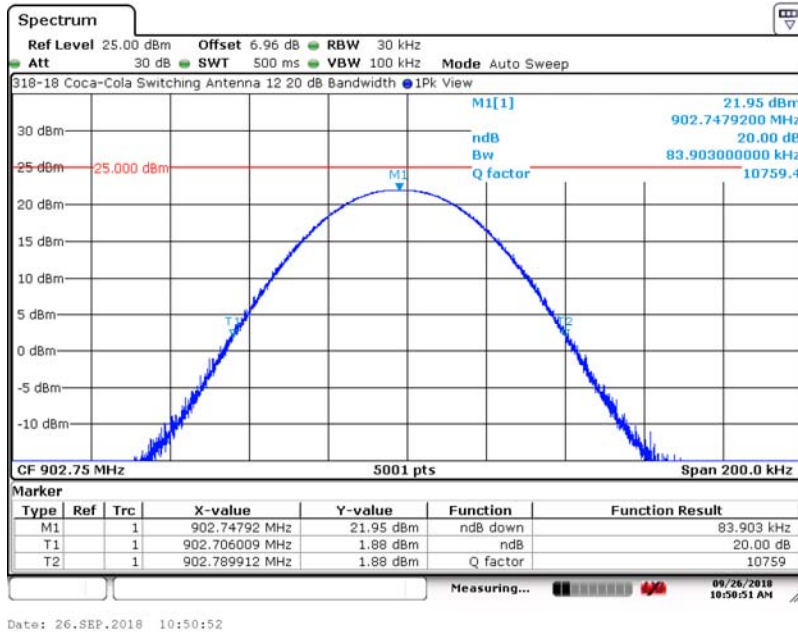

7.2.1.2. 20 dB Bandwidth – Middle Frequency

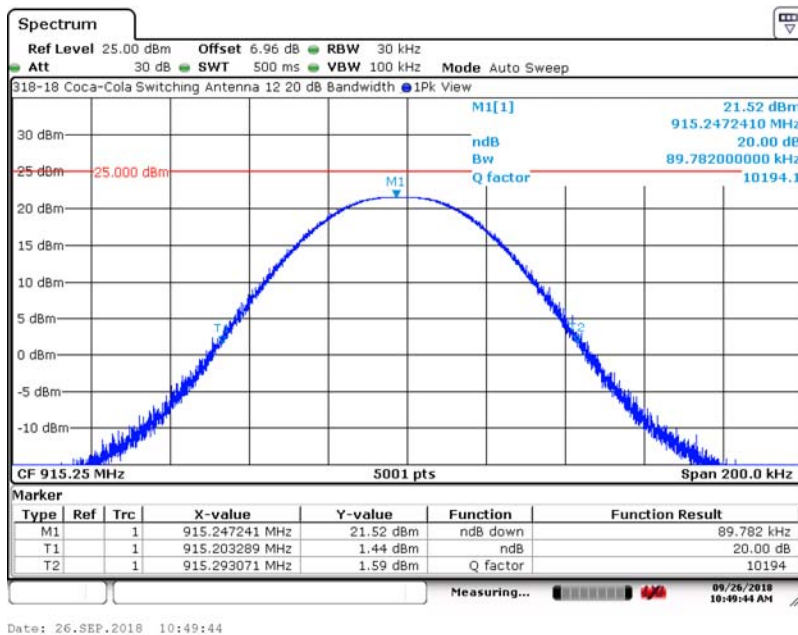

7. Measurement Data (continued)

7.2. Frequency Hopping Requirements (Section 15.247 (a), RSS-247 5.1(c)) (continued)

7.2.1. 20 dB Bandwidth (continued)

7.2.1.3. 20 dB Bandwidth – High Frequency

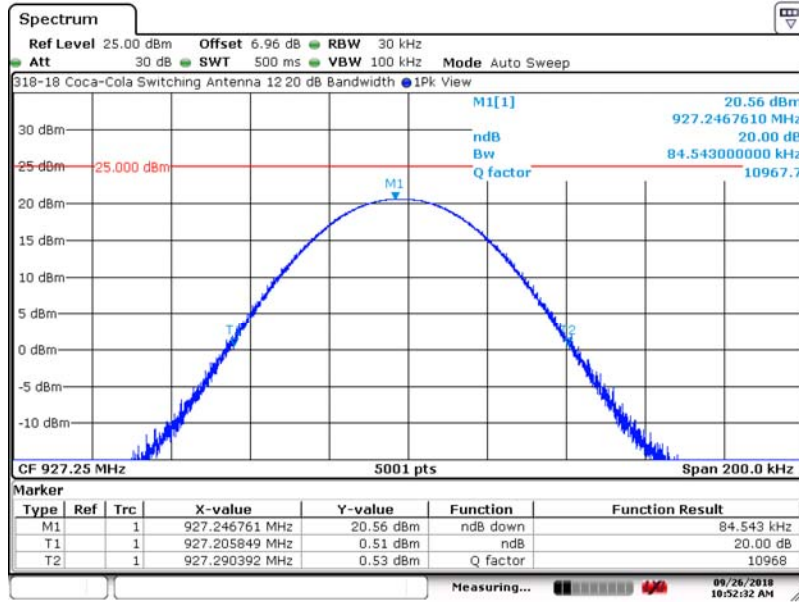

Date: 26.SEP.2018 10:52:33

7.2.2. 99% Bandwidth

Channel	Channel Frequency (MHz)	99% Power Bandwidth (kHz)
Low	902.750	72.35
Middle	915.250	70.11
High	927.250	73.51

7. Measurement Data (continued)

7.2. Frequency Hopping Requirements (Section 15.247 (a), RSS-247 5.1(c)) (continued)

7.2.2. 99% Bandwidth (continued)

7.2.2.1. 99% Bandwidth – Low Frequency

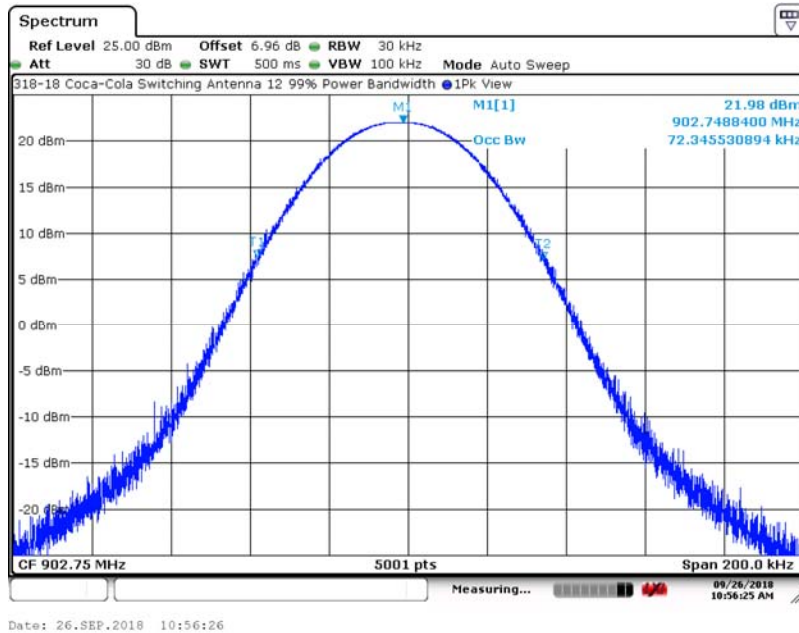

7.2.2.2. 99% Bandwidth – Middle Frequency

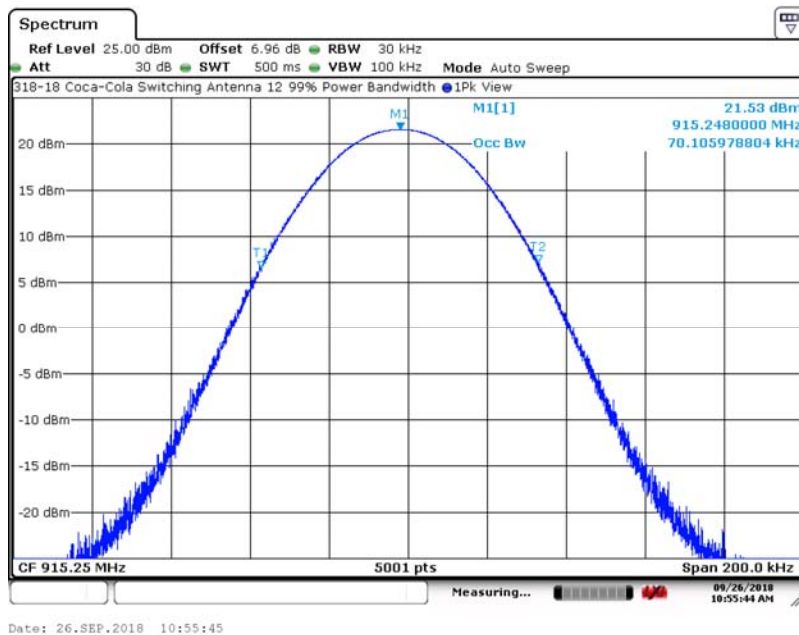

7. Measurement Data (continued)

7.2. Frequency Hopping Requirements (Section 15.247 (a), RSS-247 5.1(c)) (continued)

7.2.2. 99% Bandwidth (continued)

7.2.2.3. 99% Bandwidth – High Frequency

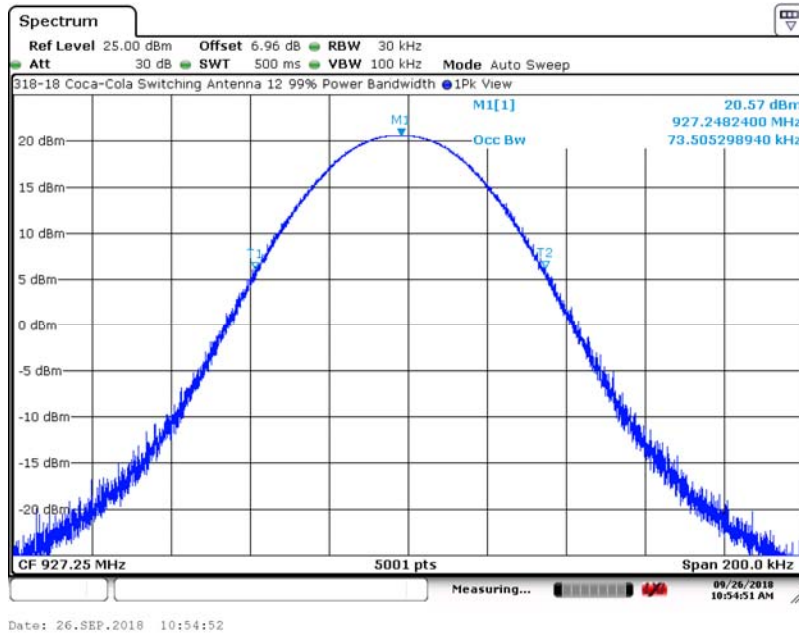

7.2.3. Number of Hopping Channels = 50

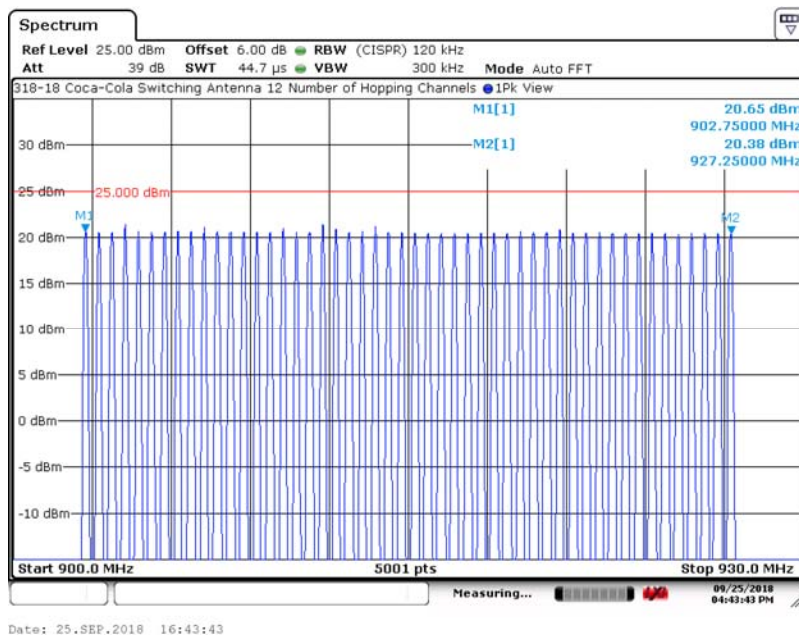

7. Measurement Data (continued)

7.2. Frequency Hopping Requirements (Section 15.247 (a), RSS-247 5.1(c)) (continued)

7.2.4. Channel Separation

Channel	Channel Pair	Channel Separation (kHz)	Required Channel Separation (kHz)	Result
Low	902.750	500	89.8	Compliant
	903.250			
Middle	915.250	500	89.8	Compliant
	915.750			
High	926.750	500	89.8	Compliant
	927.250			

7.2.4.1. Channel Separation - Low Channels

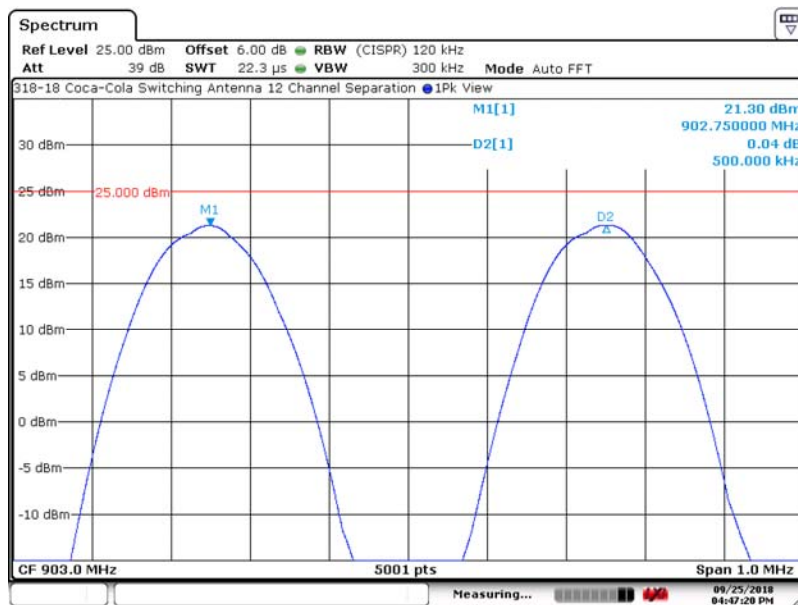

Date: 25.SEP.2018 16:47:20

7. Measurement Data (continued)

7.2. Frequency Hopping Requirements (Section 15.247 (a), RSS-247 5.1(c)) (continued)

7.2.4. Channel Separation

7.2.4.2. Channel Separation - Middle Channels

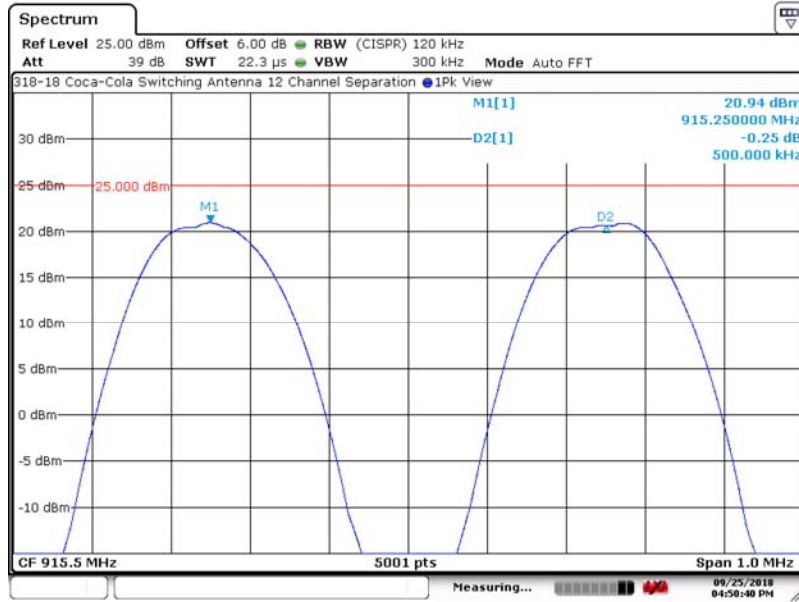

Date: 25.SEP.2018 16:50:40

7.2.4.3. Channel Separation - High Channels

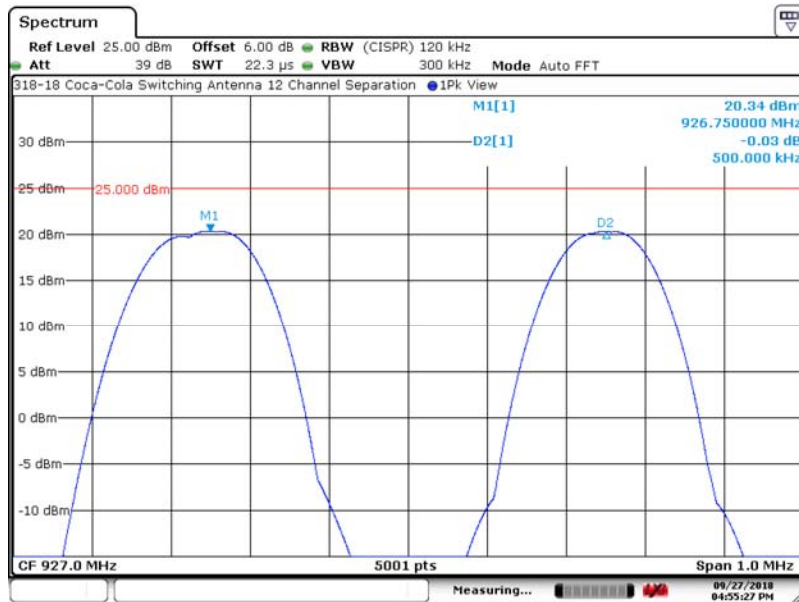

Date: 27.SEP.2018 16:55:27

7. Measurement Data (continued)

7.2. Frequency Hopping Requirements (Section 15.247 (a), RSS-247 5.1(c)) (continued)

7.2.5. Average Time of Occupancy per Period (Period = 20 Seconds)

Channel	Frequency (MHz)	Pulse Width (Sec)	Avg Time per Period (20 Seconds)	Maximum Time per Period	Result
Low	902.750	0.045	0.135	0.4000	Compliant
Middle	915.250	0.044	0.133	0.4000	Compliant
High	927.250	0.045	0.135	0.4000	Compliant

Note: Two Pulses occur every 20 seconds.

7.2.5.1. Pulse Width - Low Channel

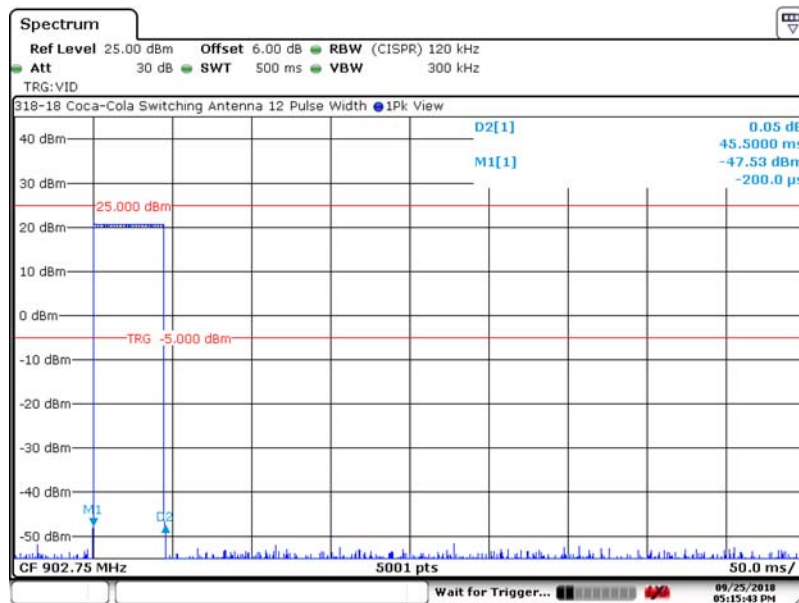

Date: 25.SEP.2018 17:15:43

7. Measurement Data (continued)

7.2. Frequency Hopping Requirements (Section 15.247 (a), RSS-247 5.1(c)) (continued)

7.2.5. Average Time of Occupancy per Period (Period = 20 Seconds)

7.2.5.2. Pulses per 20 Second Period - Low Channel

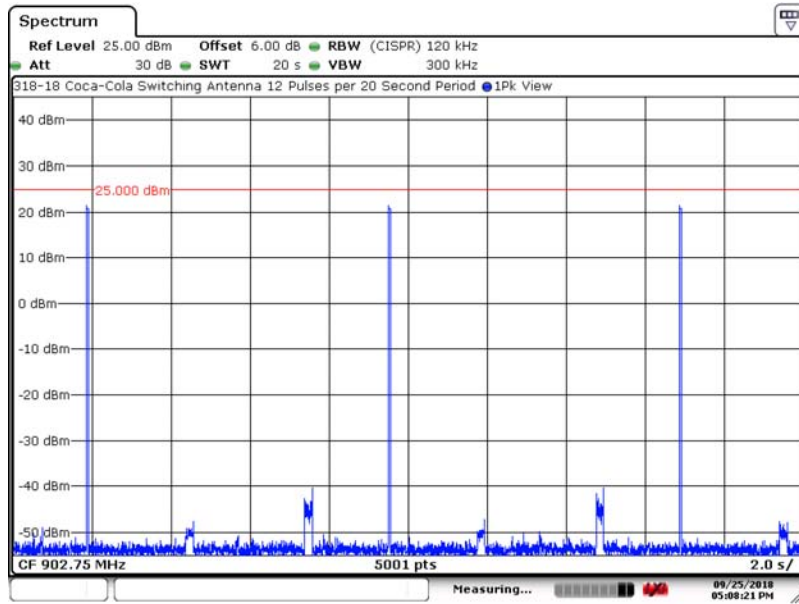

Date: 25.SEP.2018 17:08:22

7.2.5.3. Pulse Width - Middle Channel

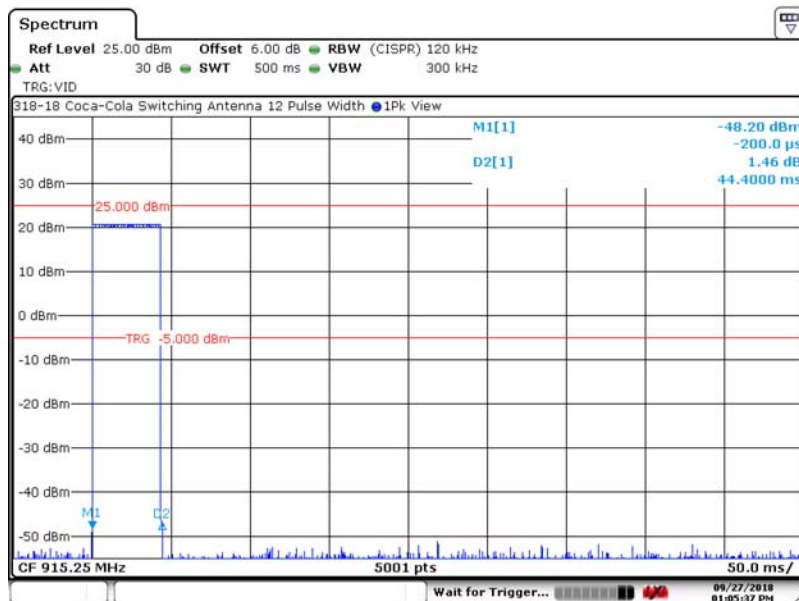

Date: 27.SEP.2018 13:05:37

7. Measurement Data (continued)

7.2. Frequency Hopping Requirements (Section 15.247 (a), RSS-247 5.1(c)) (continued)

7.2.5. Average Time of Occupancy per Period (Period = 20 Seconds)

7.2.5.4. Pulses per 20 Second Period - Middle Channel

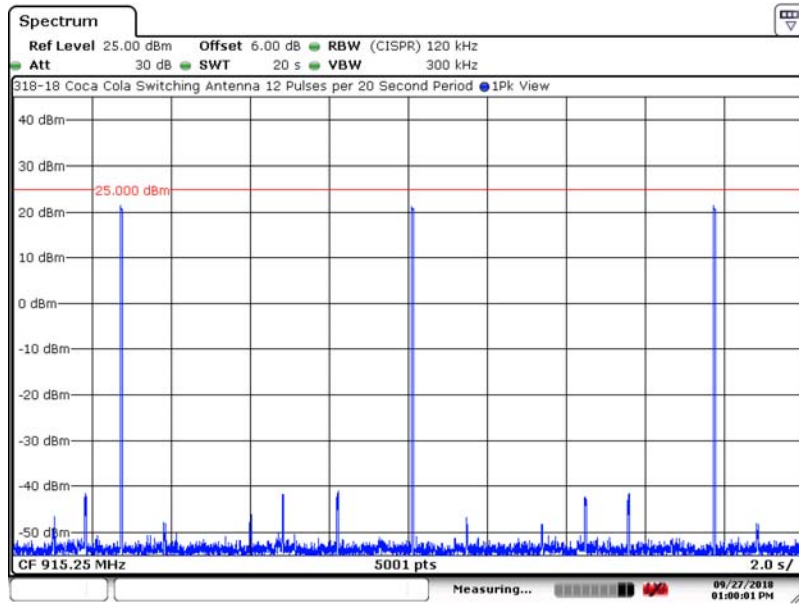

Date: 27.SEP.2018 13:00:01

7.2.5.5. Pulse Width - High Channel

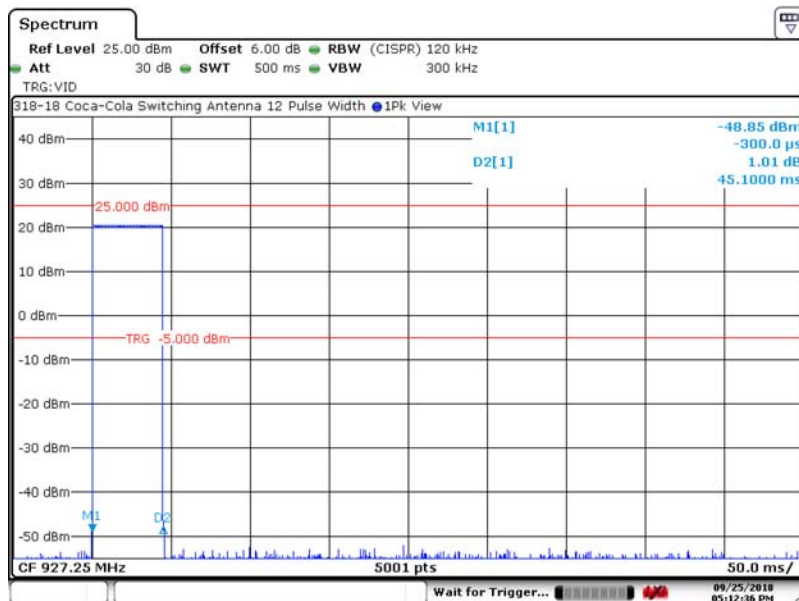

Date: 25.SEP.2018 17:12:36

7. Measurement Data (continued)

7.2. Frequency Hopping Requirements (Section 15.247 (a), RSS-247 5.1(c)) (continued)

7.2.5. Average Time of Occupancy per Period (Period = 20 Seconds)

7.2.5.6. Pulses per 20 Second Period - High Channel

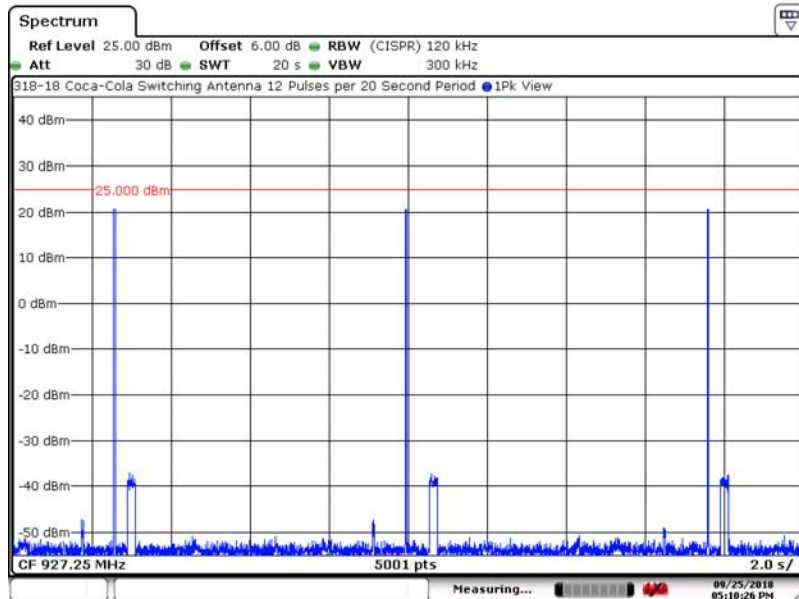

Date: 25.SEP.2018 17:10:26

7. Measurement Data (continued)

7.3. Maximum Peak Conducted Output Power (Section 15.247 (b), RSS-247 5.4(a))

Requirements: The maximum peak conducted output power of the intentional radiator shall not exceed the following: For frequency hopping systems operating in the 902-928 MHz band: 1 watt for systems employing at least 50 hopping channels; and, 0.25 watts for systems employing less than 50 hopping channels, but at least 25 hopping channels, as permitted under paragraph (a)(1)(i) of this section.

Channel	Frequency (MHz)	Max Conducted Output Power (dBm)	Max Peak Conducted Output Power (Watts)	Limit (Watts)	Result
Low – Antenna 12 SW	902.750	21.51	0.142	1	Compliant
Middle – Antenna 12 SW	915.250	21.77	0.150	1	Compliant
High – Antenna 12 SW	927.250	21.57	0.144	1	Compliant

Note: Port Ant1 for Switching Antenna 12 SW is worse case, as this port has the shortest trace length from the output of the RF switch on the board.

7.3.1. Maximum Peak Conducted Output Power – Low Channel

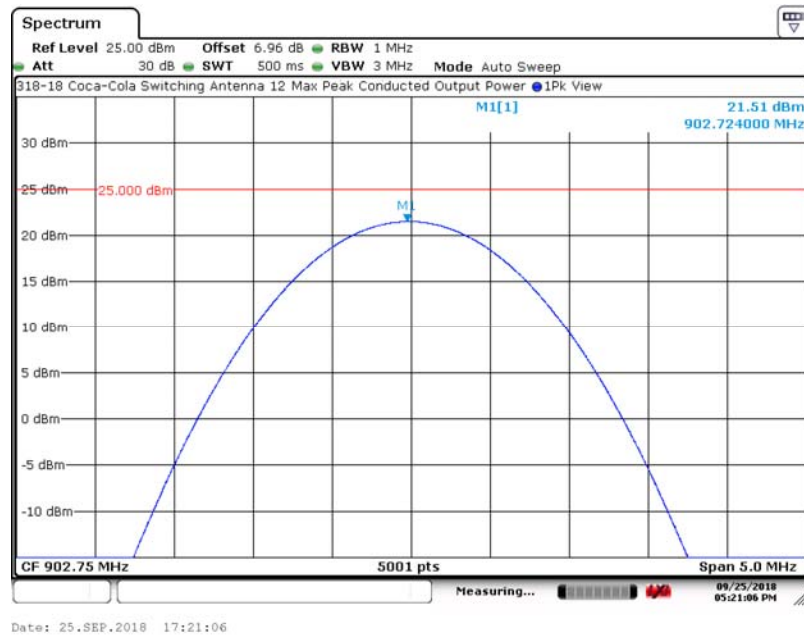

7. Measurement Data (continued)

7.3. Maximum Peak Conducted Output Power (Section 15.247 (b), 5.4(a)) (continued)

7.3.2. Maximum Peak Conducted Output Power – Middle Channel

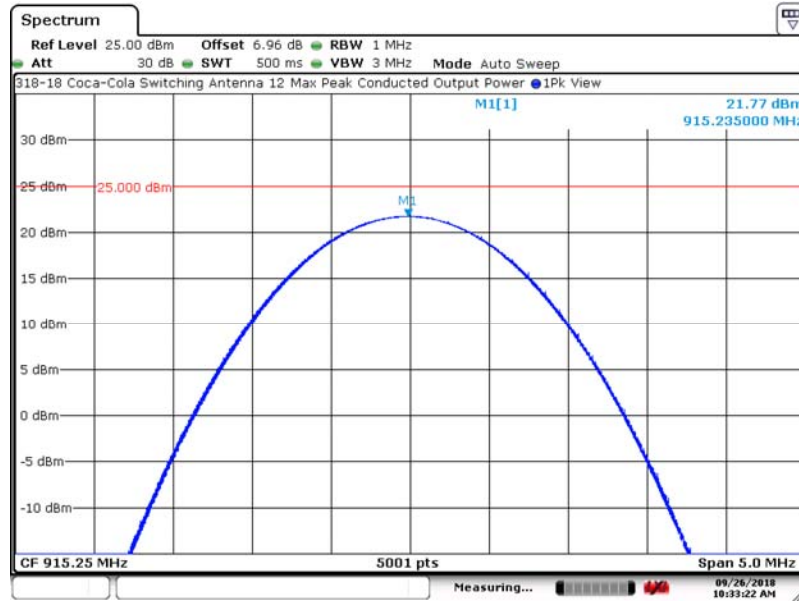

Date: 26.SEP.2018 10:33:22

7.3.3. Maximum Peak Conducted Output Power – High Channel

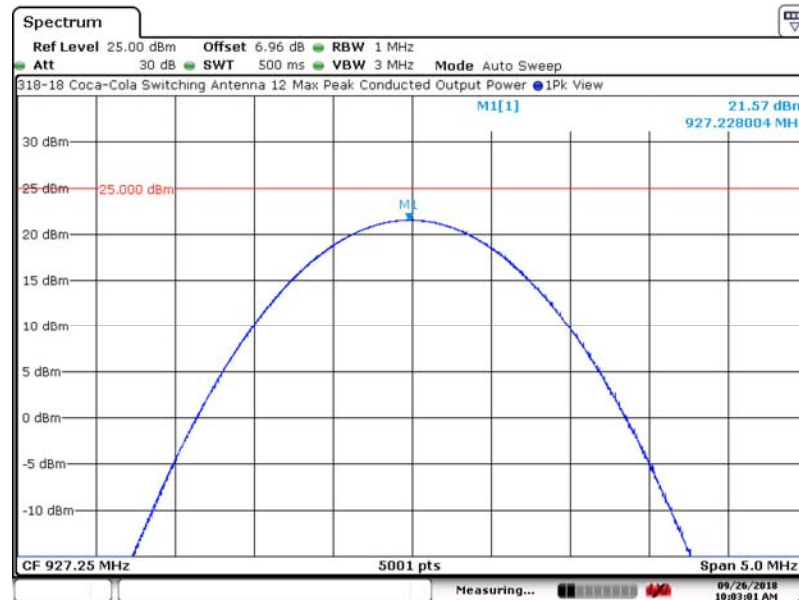

Date: 26.SEP.2018 10:03:01

7. Measurement Data (continued)

7.3. Maximum Peak Conducted Output Power (Section 15.247 (b), 5.4(a)) (continued)

7.3.4. Maximum Peak Power Radiated Measurements at 3 meters – Low Frequency

Frequency (MHz)	Antenna	PeakField Strength (dBµV/m)	Antenna Polarity (H/V)	Antenna Height (cm)	Turntable Position (deg)
Maximum Peak Level	Antenna 12 SW Slot 1	83.35	V	208	0
		-11.85 dBm			
	Antenna 12 SW Slot 2	82.36	H	228	10
		-12.84 dBm			
	Antenna 12 SW Slot 3	89.10	V	168	40
		-6.10 dBm			
	Antenna 12 SW Slot 4	87.68	H	185	48
		-7.52 dBm			
	Antenna 12 SW Slot 5	86.18	V	220	354
		-9.02 dBm			
	Antenna 12 SW Slot 6	84.66	V	278	230
		-10.54 dBm			
	Antenna 8 SW Slot 7	84.96	V	110	30
		-10.24 dBm			
	Antenna 12 SW Slot 8	83.99	H	164	40
		-11.21 dBm			
	Antenna 12 SW Slot 9	85.12	V	110	108
		-10.08 dBm			
	Antenna 12 SW Slot 10	84.88	V	156	280
		-10.32 dBm			
	Antenna 8 SW Slot 11	87.32	V	121	4
		-7.88 dBm			
	Antenna 12 SW Slot 12	86.64	H	143	28
		-8.56 dBm			

Note: dBm levels were determined by subtracting 95.2 from the 3 meter field strength levels. Antennas for the EUT are designed to measure / activate tags at very short distances.

7. Measurement Data (continued)

7.3. Maximum Peak Conducted Output Power (Section 15.247 (b), 5.4(a)) (continued)

7.3.5. Maximum Peak Power Radiated Measurements at 3 meters – Middle Frequency

Frequency (MHz)	Antenna	PeakField Strength (dBµV/m)	Antenna Polarity (H/V)	Antenna Height (cm)	Turntable Position (deg)
Maximum Peak Level	Antenna 12 SW Slot 1	81.24	V	177	40
		-13.96 dBm			
	Antenna 12 SW Slot 2	81.02	H	185	44
		-14.18 dBm			
	Antenna 12 SW Slot 3	84.59	V	100	320
		-10.61 dBm			
	Antenna 12 SW Slot 4	83.37	V	105	200
		-11.83 dBm			
	Antenna 12 SW Slot 5	83.1	V	170	30
		-12.10 dBm			
	Antenna 12 SW Slot 6	84.41	H	196	8
		-10.79 dBm			
Antenna 8 SW Slot 7	82.86	V	113	338	
	-12.34 dBm				
Antenna 12 SW Slot 8	82.09	H	310	48	
	-13.11 dBm				
Antenna 12 SW Slot 9	84.94	H	302	34	
	-10.26 dBm				
Antenna 12 SW Slot 10	84.31	H	100	34	
	-10.89 dBm				
Antenna 8 SW Slot 11	85.72	V	122	350	
	-9.48 dBm				
Antenna 12 SW Slot 12	84.64	H	301	34	
	-10.56 dBm				

Note: dBm levels were determined by subtracting 95.2 from the 3 meter field strength levels. Antennas for the EUT are designed to measure / activate tags at very short distances.

7. Measurement Data (continued)

7.3. Maximum Peak Conducted Output Power (Section 15.247 (b), 5.4(a)) (continued)

7.3.6. Maximum Peak Power Radiated Measurements at 3 meters – High Frequency

Frequency (MHz)	Antenna	PeakField Strength (dBµV/m)	Antenna Polarity (H/V)	Antenna Height (cm)	Turntable Position (deg)
Maximum Peak Level	Antenna 12 SW Slot 1	79.48	V	171	128
		-15.72 dBm			
	Antenna 12 SW Slot 2	81.13	H	184	24
		-14.07 dBm			
	Antenna 12 SW Slot 3	84.85	V	201	74
		-10.35 dBm			
	Antenna 12 SW Slot 4	82.22	H	181	20
		-12.98 dBm			
	Antenna 12 SW Slot 5	83.24	V	136	344
		-11.96 dBm			
	Antenna 12 SW Slot 6	81.32	H	168	354
		-13.88 dBm			
	Antenna 8 SW Slot 7	83.17	V	137	0
		-12.03 dBm			
	Antenna 12 SW Slot 8	81.5	H	169	0
		-13.70 dBm			
	Antenna 12 SW Slot 9	83.75	V	121	348
		-11.45 dBm			
	Antenna 12 SW Slot 10	83.99	H	172	20
		-11.21 dBm			
	Antenna 8 SW Slot 11	83.36	H	173	350
		-11.84 dBm			
	Antenna 12 SW Slot 12	83.73	H	173	4
		-11.47 dBm			

Note: dBm levels were determined by subtracting 95.2 from the 3 meter field strength levels. Antennas for the EUT are designed to measure / activate tags at very short distances.

7. Measurement Data (continued)

7.4. Operation with Directional Antenna Gains Greater than 6 dBi (Section 15.247 (c))

Status: Section 15.247 (c) does not apply to the product under test.

7.5. Emissions Outside the Frequency Band (Section 15.247 (d), RSS-247 5.5)

Requirements: In any 100 kHz bandwidth outside the frequency band in which the spread spectrum or digitally modulated intentional radiator is operating, the radio frequency power that is produced by the intentional radiator shall be at least 20 dB below that in the 100 kHz bandwidth within the band that contains the highest level of the desired power, based on either an RF conducted or a radiated measurement, provided the transmitter demonstrates compliance with the peak conducted power limits.

Test Note: The measurement methodology detailed in FCC Office of Engineering and Technology Publication Number: 913591 is used to determine the band edge values.

7.5.1. Band Edge Measurements

Lower Band Edge

Lowest Channel (MHz)	Measured Power (dBm)	Band Edge Frequency (MHz)	Measured Power (dBm)	Requirement (-20 dB from Peak)	Margin (dB)	Result
	Peak		Peak	Peak		
902.75	21.88	902	-48.67	1.88	-50.55	Compliant

Upper Band Edge

Highest Channel (MHz)	Measured Power (dBm)	Band Edge Frequency (MHz)	Measured Power (dBm)	Requirement (-20 dB from Peak)	Margin (dB)	Result
	Peak		Peak	Peak		
927.25	20.46	928	-49.23	0.46	-49.69	Compliant

7.5.2. Band Edge Measurements (Frequency Hopping Mode)

Lower Band Edge

Lowest Channel (MHz)	Measured Power (dBm)	Band Edge Frequency (MHz)	Measured Power (dBm)	Requirement (-20 dB from Peak)	Margin (dB)	Result
	Peak		Peak	Peak		
902.75	21.89	902	-49.44	1.89	-51.33	Compliant

Upper Band Edge

Highest Channel (MHz)	Measured Power (dBm)	Band Edge Frequency (MHz)	Measured Power (dBm)	Requirement (-20 dB from Peak)	Margin (dB)	Result
	Peak		Peak	Peak		
927.25	21.49	928	-45.82	1.49	-47.31	Compliant

7. Measurement Data (continued)

7.5. Emissions outside the Frequency Band (15.247 (d), RSS-247 5.5) (continued)

7.5.3.1. Lower and Upper Band Edges

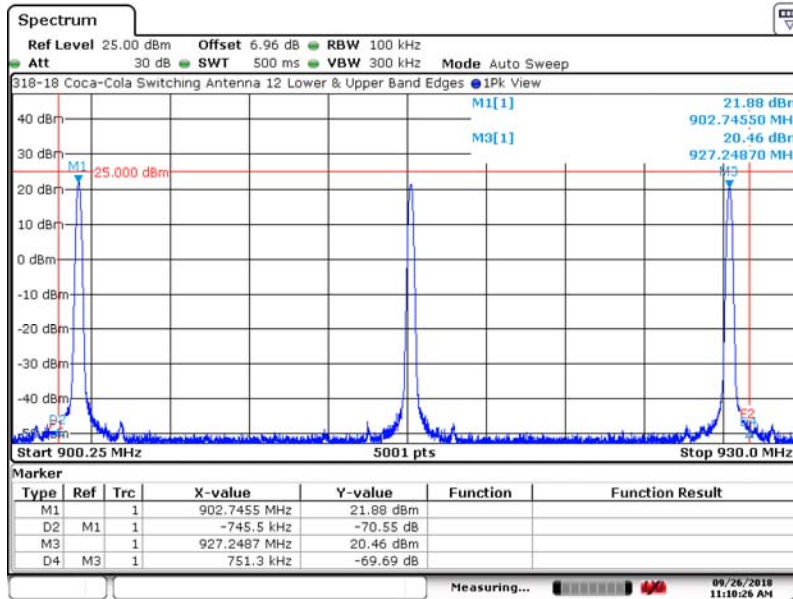

Date: 26.SEP.2018 11:10:27

7.5.3.2. Lower and Upper Band Edges (Frequency Hopping Mode)

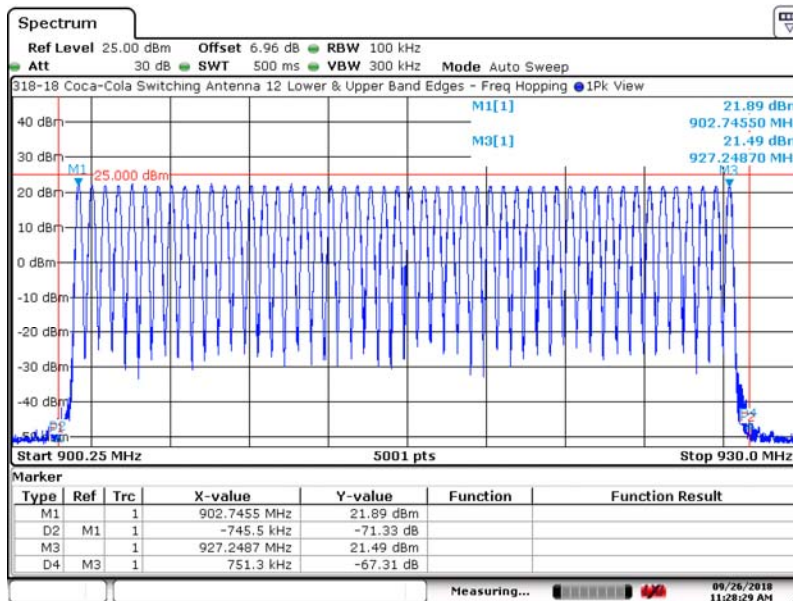

Date: 26.SEP.2018 11:28:30

7. Measurement Data (continued)

7.6. Transmitter Spurious Radiated Emissions (1 MHz to 9.5 GHz)

Note: The spurious emissions detailed in this section represent the combined worst case emissions of the low, middle and high operating frequencies.

7.6.1. Regulatory Limit: FCC Part 209, A.8.5 Quasi-Peak

Frequency Range (MHz)	Distance (Meters)	Limit (dBµV/m)
0.490 to 1.705	3	73.8 to 63.0
1.705 to 30	3	69.5
30 to 88	3	40.0
88 to 216	3	43.5
216 to 960	3	46.0
>960	3	54.0

7.6.2. Spurious Radiated Emissions (1 to 30 MHz) Test Results

7.6.2.1. Measurement Results – Parallel with Antenna 12 SW

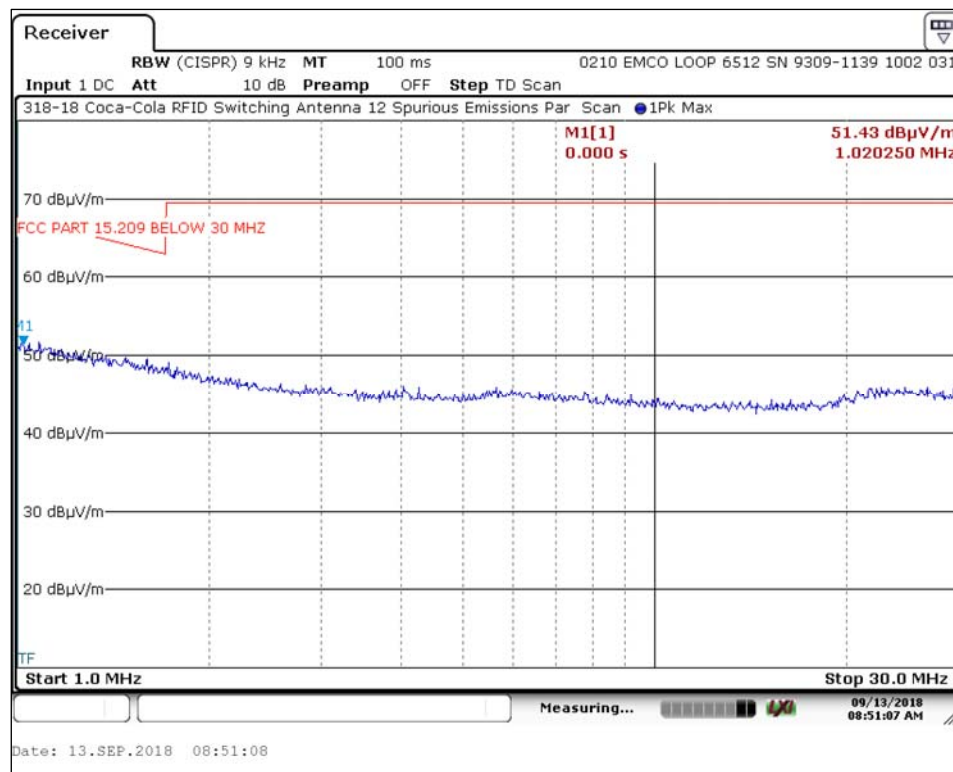

7. Measurement Data (continued)

7.6. Spurious Radiated Emissions (1 MHz to 9.5 GHz) (continued)

7.6.2. Spurious Radiated Emissions (1 MHz to 30 MHz) Test Results

7.6.2.2. Measurement Results – Perpendicular with Antenna 12 SW

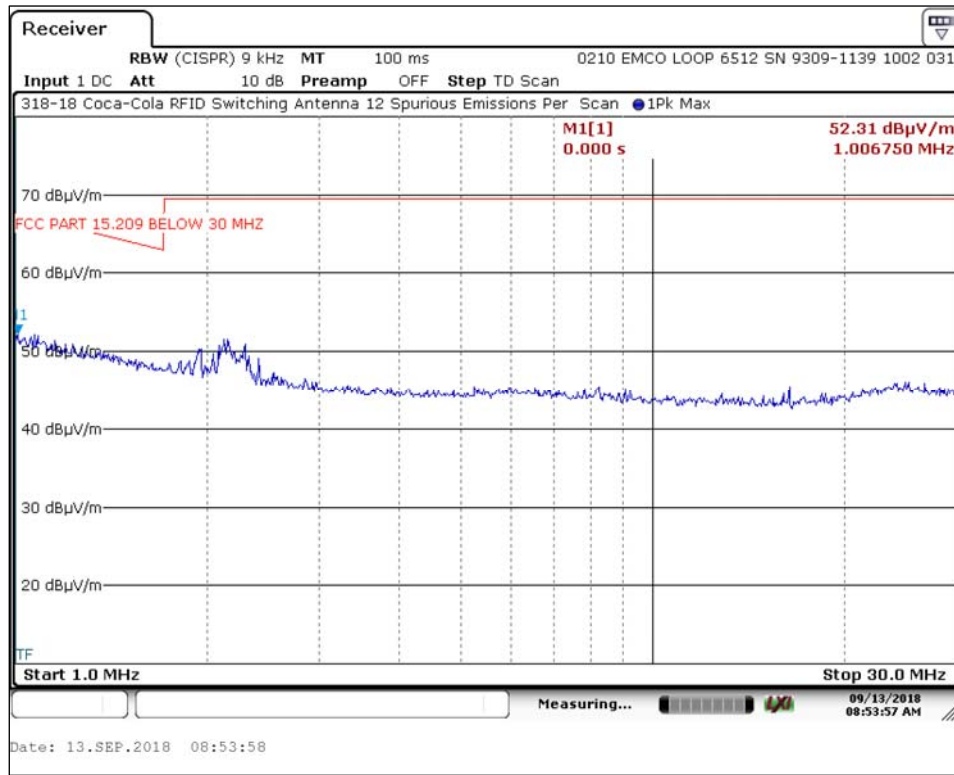

7. Measurement Data (continued)

7.6. Spurious Radiated Emissions (1 MHz to 9.5 GHz) (continued)

7.6.2. Spurious Radiated Emissions (1 MHz to 30 MHz) Test Results

7.6.2.3. Measurement Results – Ground Parallel with Antenna 12 SW

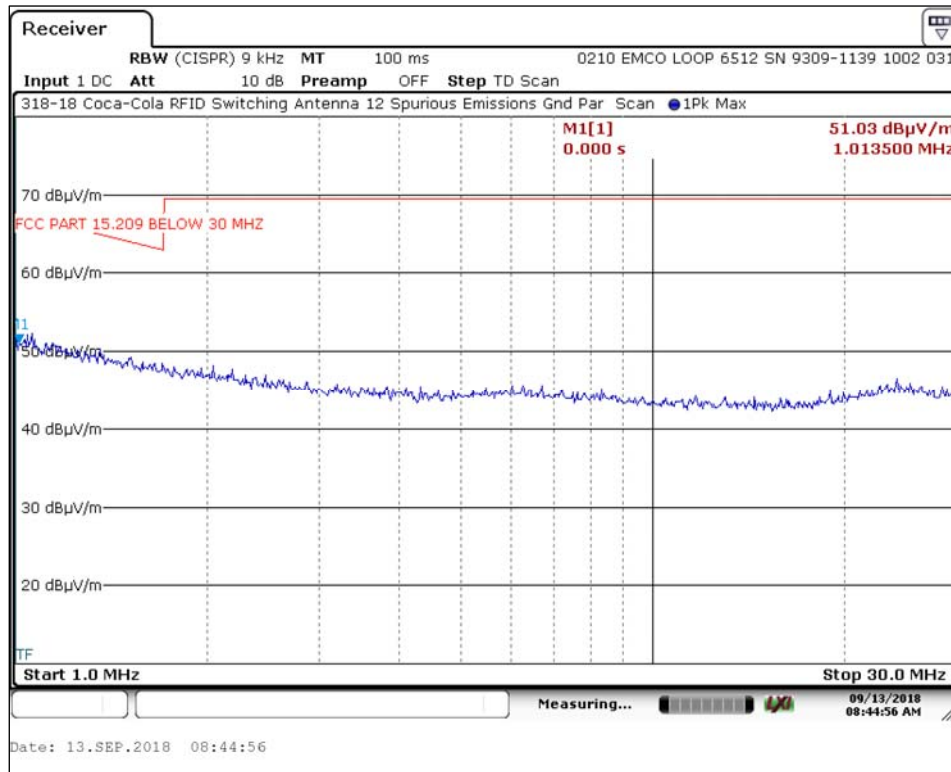

7. Measurement Data (continued)

7.6. Spurious Radiated Emissions (1 MHz to 9.5 GHz) (continued)

7.6.3. Spurious Radiated Emissions (30 MHz to 1 GHz) Test Results

7.6.3.1. Measurement Results – Horizontal with Antenna 12 SW

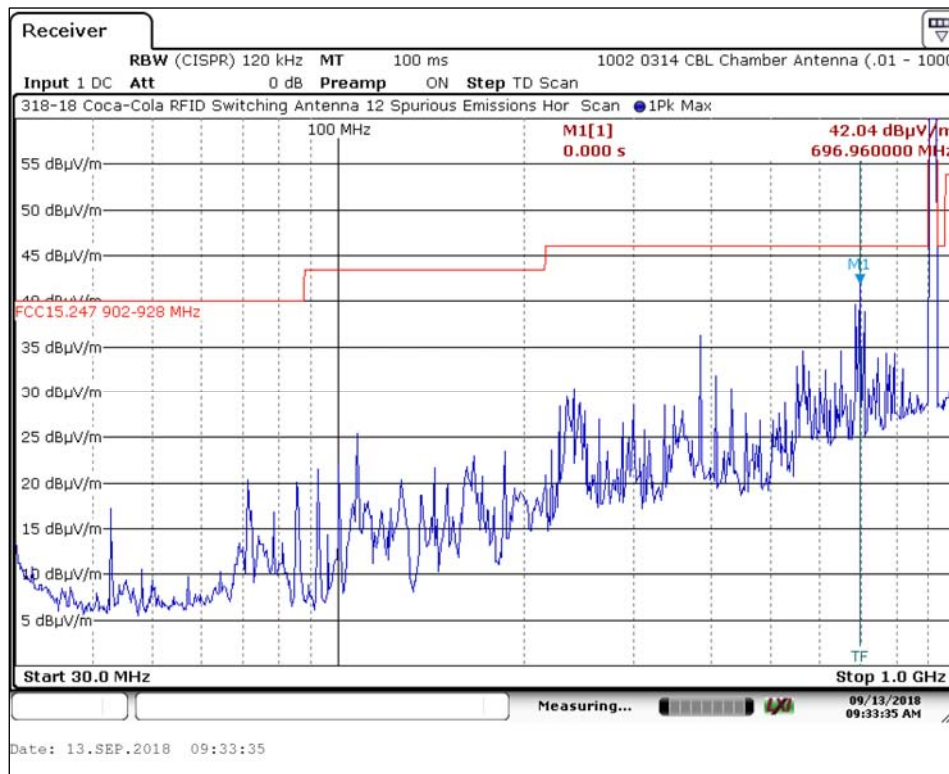

7. Measurement Data (continued)

7.6. Spurious Radiated Emissions (1 MHz to 9.5 GHz) (continued)

7.6.3. Spurious Radiated Emissions (30 MHz to 1 GHz) Test Results

7.6.3.2. Measurement Results – Vertical with Antenna 12 SW

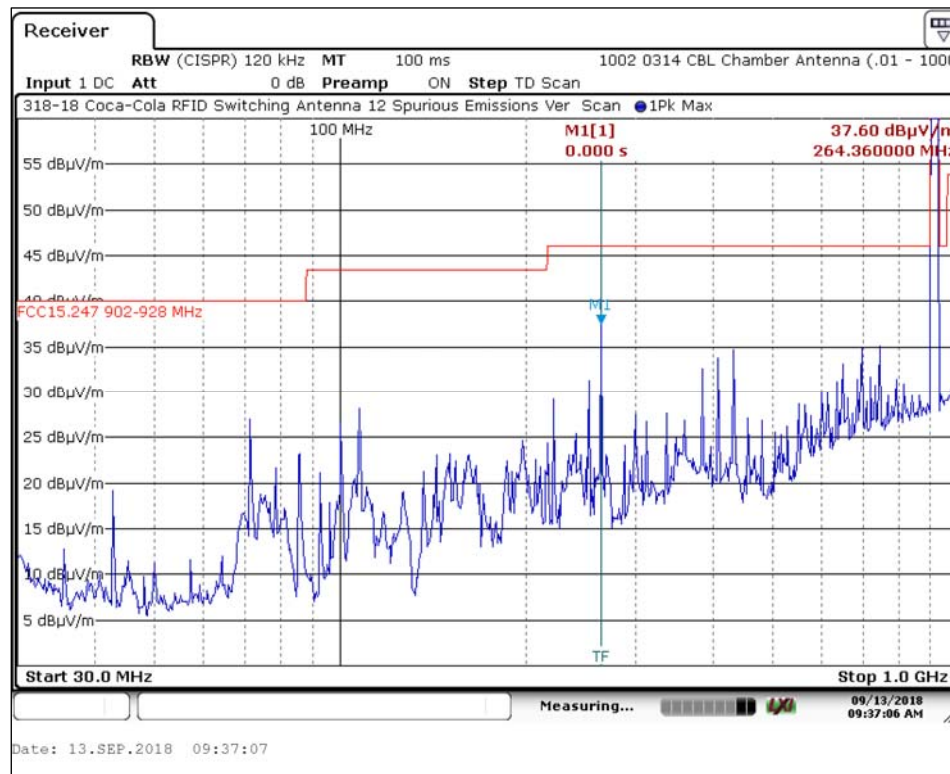

7. Measurement Data (continued)

7.6. Spurious Radiated Emissions (1 MHz to 9.5 GHz) (continued)

7.6.3. Spurious Radiated Emissions (1 to 9.5 GHz) Test Results

7.6.3.3. Measurement Results – Horizontal measured at 1 Meter with Antenna 12 SW

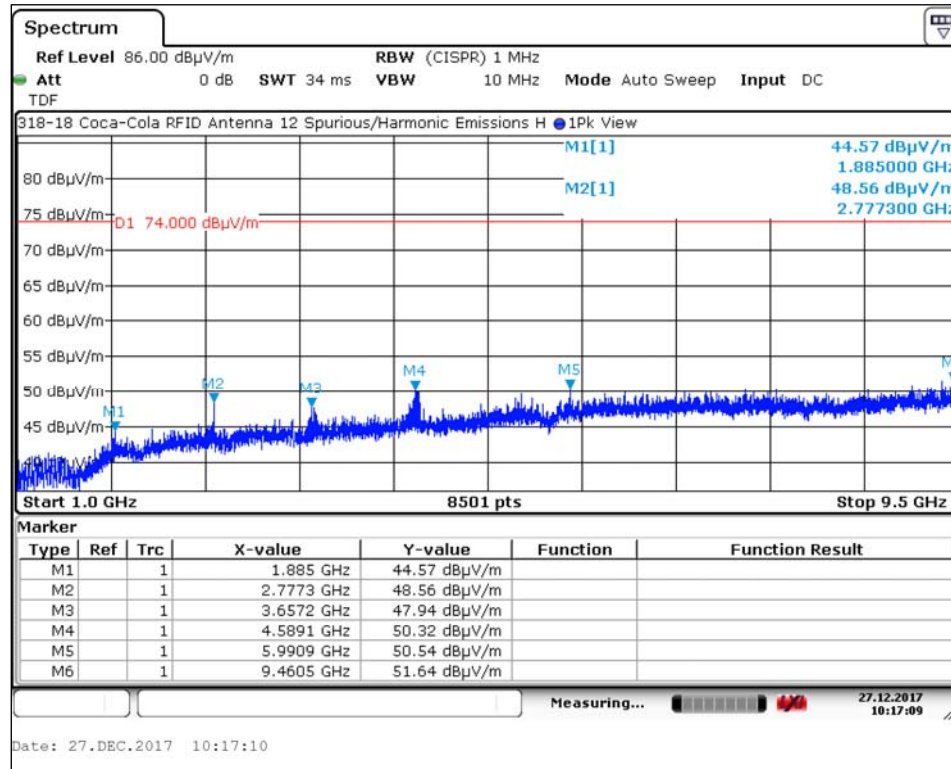

Note: Harmonics within restricted bands are detailed in the table in Section 7.7

7. Measurement Data (continued)

7.6. Spurious Radiated Emissions (1 MHz to 10 GHz) (continued)

7.6.3. Spurious Radiated Emissions (1 to 9.5 GHz) Test Results

7.6.3.4. Measurement Results – Vertical measured at 1 Meter with Antenna 12 SW

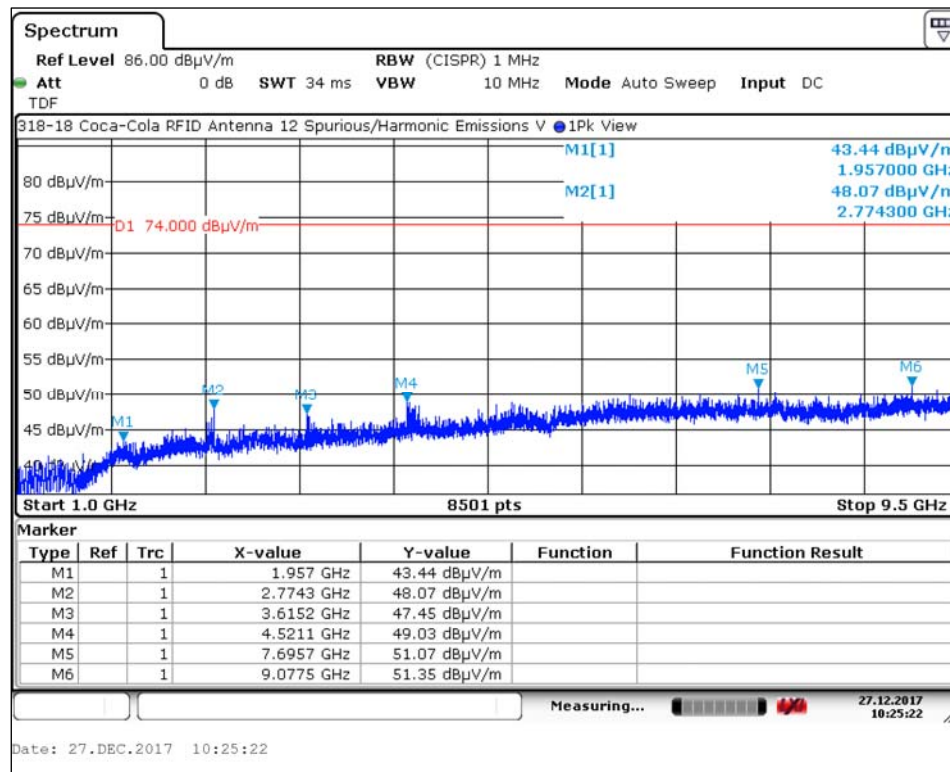

Note: Harmonics within restricted bands are detailed in the table in Section 7.7

7. Measurement Data (continued)

7.7. Spurious Radiated Emissions – Harmonic Emissions

Note: The harmonic emissions detailed in this section represent the combined worst case emissions of the low, middle and high operating frequencies within the restricted bands of operation per FCC P15.205 and ISED RSS-GEN.

7.7.1. Spurious Radiated Emissions (Harmonic Measurements) Test Results

Antenna 12 SW

Freq. (MHz)	Field Strength (dBµV/m) ¹		Limit (dBµV/m)		Margin (dBµV/m)		Antenna Polarity (H/V)	Result
	Peak	Average	Peak	Average	Peak	Average		
2708.25	50.92	42.08	74.00	54.00	-23.08	-11.92	H	Compliant
2745.75	51.47	42.30	74.00	54.00	-22.53	-11.70	H	Compliant
2781.75	51.16	41.57	74.00	54.00	-22.84	-12.43	H	Compliant
3611.00	51.31	39.78	74.00	54.00	-22.69	-14.22	V	Compliant
3661.00	51.00	40.51	74.00	54.00	-23.00	-13.49	H	Compliant
3709.00	51.01	40.37	74.00	54.00	-22.99	-13.63	V	Compliant
4513.75	52.85	41.56	74.00	54.00	-21.15	-12.44	V	Compliant
4576.25	51.59	39.86	74.00	54.00	-22.41	-14.14	V	Compliant
4636.25	51.23	39.33	74.00	54.00	-22.77	-14.67	V	Compliant
5416.50	51.84	39.20	74.00	54.00	-22.16	-14.80	H	Compliant
7322.00	52.38	37.76	74.00	54.00	-21.62	-16.24	V	Compliant
7418.00	52.84	38.69	74.00	54.00	-21.16	-15.31	V	Compliant
8124.75	53.33	39.53	74.00	54.00	-20.67	-14.47	H	Compliant
8237.25	53.64	40.03	74.00	54.00	-20.36	-13.97	V	Compliant
8345.25	54.06	40.06	74.00	54.00	-19.94	-13.94	V	Compliant
9027.50	54.07	39.63	74.00	54.00	-19.93	-14.37	H	Compliant
9152.50	54.55	41.02	74.00	54.00	-19.45	-12.98	H	Compliant

¹ All correction factors are stored in the spectrum analyzer and applied to this column entry.

7. Measurement Data (continued)

7.8. Conducted Emissions

7.8.1. Regulatory Limit: FCC Part 15, Class B (Part 15.207)

Frequency Range (MHz)	Limits (dBµV)	
	Quasi-Peak	Average
0.15 to 0.50	66 to 56*	56 to 46*
0.50 to 5.0	56	46
5.0 to 30.0	60	50

* Decreases with the logarithm of the frequency.

7.8.2. Measurement & Equipment Setup

Test Date: 9/28/2018
 Test Engineer: Sean Defelice
 Site Temperature (°C): 21.5
 Relative Humidity (%RH): 25
 Frequency Range: 0.15 MHz to 30 MHz
 EMI Receiver IF Bandwidth: 9 kHz
 EMI Receiver Avg Bandwidth: 30 kHz
 Detector Functions: Peak, Quasi-Peak. & Average

7. Measurement Data (continued)

7.8. Conducted Emissions

7.8.3. 120 Volts, 60 Hz Phase

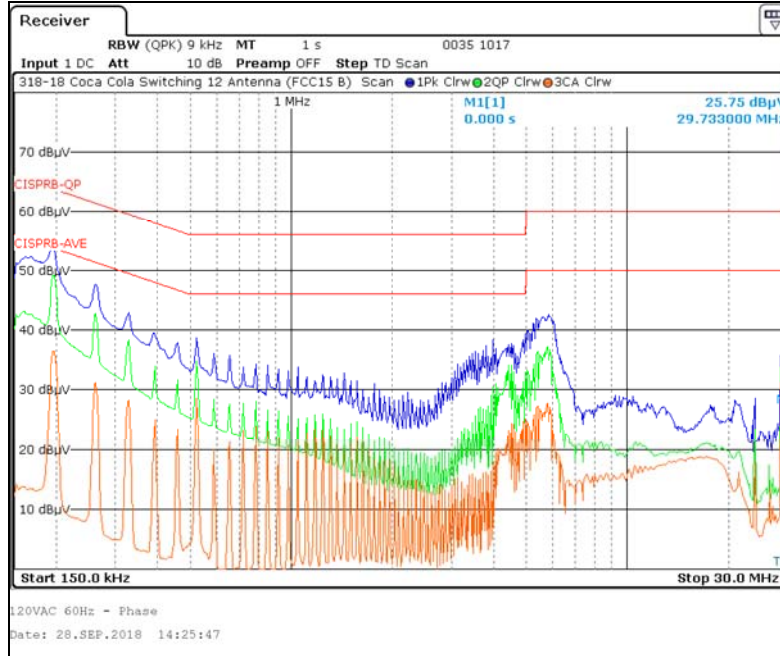

7.8.4. 120 Volts, 60 Hz Neutral

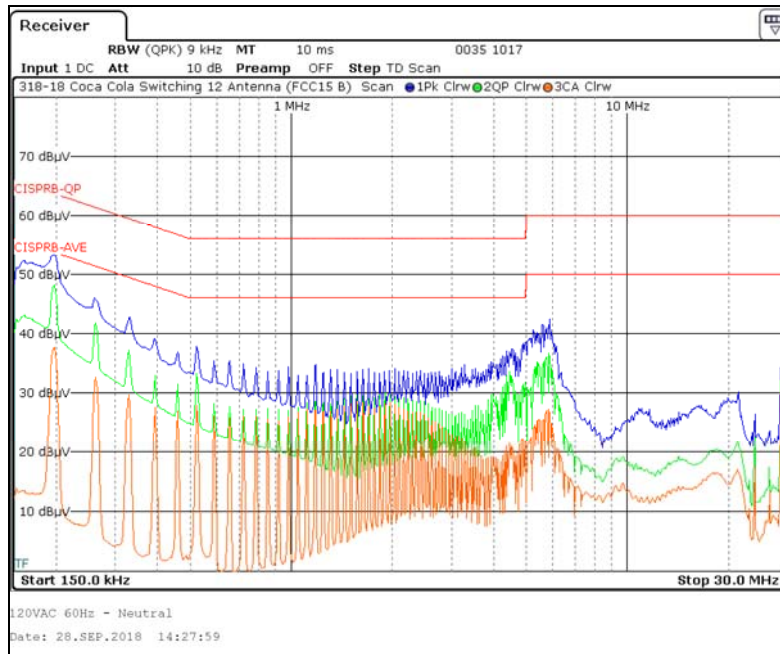

7. Measurement Data (continued)

7.9. Public Exposure to Radio Frequency Energy Levels (15.247(i) (1.1307 (b)(1))
RSS-GEN, RSS 102

Antenna 12SW

Frequency (MHz)	MPE Distance (cm)	DUT Output Power (dBm)	DUT Antenna Gain (dBi)	Power Density		Limit (mW/cm ²)	Result
				(mW/cm ²)	(W/m ²)		
				(4)			
902.75	20.0	21.70	-18.68	0.0003988	0.0039878	1	Compliant
915.25	20.0	21.21	-18.68	0.0003554	0.0035541	1	Compliant
927.25	20.0	20.33	-18.68	0.0002909	0.0029089	1	Compliant

$$PD = \frac{OP + AG}{(4 \times \pi \times d^2)}$$

- PD = Power Density (mW/cm²)
- OP = DUT Output Power (dBm)
- AG = DUT Antenna Gain (dBi)
- d = MPE Distance (cm)

1. Reference CFR 2.1093(b): For purposes of this section, a portable device is defined as a transmitting device designed to be used so that the radiating structure(s) of the device is/are within 20 centimeters of the body of the user.
2. Section 7.4 of this test report.
3. Data supplied by the client. Antenna specification data of worst case antenna used by the DUT.
4. Time Averaging Duty Cycle Correction Factor.
5. Power density is calculated from field strength measurement and antenna gain.
6. Reference CFR 1.1310, Table 1: Limits for Maximum Permissible Exposure (MPE), Section (B): Limits for General Population/Uncontrolled Exposure.

8. Test Site Description

Compliance Worldwide is located at 357 Main Street in Sandown, New Hampshire. The test sites at Compliance Worldwide are used for conducted and radiated emissions testing in accordance with the Federal Communications Commission (FCC) and Industry Canada standards. Through our American Association for Laboratory Accreditation (A2LA) ISO Guide 17025:2005 Accreditation our test sites are designated with the FCC (designation number **US1091**), Industry Canada (file number **IC 3023A-1**) and VCCI (Member number 3168) under registration number A-0274.

Compliance Worldwide is also designated as a Phase 1 CAB under APEC-MRA (US0132) for Australia/New Zealand AS/NZS CISPR 22, Chinese-Taipei (Taiwan) BSMI CNS 13438 and Korea (RRA) KN 11, KN 13, KN 14-1, KN 22, KN 32, KN 61000-6-3, KN 61000-6-4.

The radiated emissions test site is a 3 and 10 meter enclosed open area test site (OATS). Personnel, support equipment and test equipment are located in the basement beneath the OATS ground plane.

The conducted emissions site is part of a 16' x 20' x 12' ferrite tile chamber and uses one of the walls for the vertical ground plane required by EN 55022. A second conducted emissions site is also located in the basement of the OATS site with a 2.3 x 2.5 meter ground plane and a 2.4 x 2.4 meter vertical wall.

Both sites are designed to test products or systems 1.5 meters W x 1.5 meters L x 2.0 meters H, floor standing or table top.