



REPORT No.: SZ17070160W02

# FCC RF TEST REPORT

**APPLICANT** : Shenzhen Medica Technology Development Co.,Ltd  
**PRODUCT NAME** : Smart Sleep Light  
**MODEL NAME** : SA1001  
**TRADE NAME** : N/A  
**BRAND NAME** : N/A  
**FCC ID** : 2ADIOSA1001  
**STANDARD(S)** : 47 CFR Part 15 Subpart C  
**ISSUE DATE** : 2017-11-22

**SHENZHEN MORLAB COMMUNICATIONS TECHNOLOGY Co., Ltd.**

NOTE: This document is issued by MORLAB, the test report shall not be reproduced except in full without prior written permission of the company. The test results apply only to the particular sample(s) tested and to the specific tests carried out which is available on request for validation and information confirmed at our website.



# DIRECTORY

**TEST REPORT DECLARATION .....4**

**1. TECHNICAL INFORMATION.....5**

**1.1 APPLICANT INFORMATION .....5**

**1.2 EQUIPMENT UNDER TEST (EUT) DESCRIPTION .....5**

1.2.1 IDENTIFICATION OF ALL USED EUTS .....5

**1.3 TEST STANDARDS AND RESULTS.....6**

1.3.1 TEST ENVIRONMENT CONDITIONS .....6

**2. 47 CFR PART 15C REQUIREMENTS .....7**

**2.1 ANTENNA REQUIREMENT .....7**

2.1.1 APPLICABLE STANDARD .....7

2.1.2 RESULT: COMPLIANT .....7

**2.2 NUMBER OF HOPPING FREQUENCY .....7**

2.2.1 REQUIREMENT .....7

2.2.2 TEST DESCRIPTION .....7

2.2.3 TEST PROCEDURE .....8

2.2.4 TEST RESULT .....8

**2.3 PEAK OUTPUT POWER.....12**

2.3.1 REQUIREMENT .....12

2.3.2 TEST DESCRIPTION .....12

2.3.3 TEST RESULT .....12

**2.4 20DB BANDWIDTH .....14**

2.4.1 DEFINITION .....14

2.4.2 TEST DESCRIPTION .....14

2.4.3 TEST PROCEDURE .....14

2.4.4 TEST RESULT .....14

**2.5 CARRIED FREQUENCY SEPARATION .....24**

2.5.1 DEFINITION .....24

2.5.2 TEST DESCRIPTION .....24

2.5.3 TEST PROCEDURE .....24

2.5.4 TEST RESULT .....25

**2.6 TIME OF OCCUPANCY (DWELL TIME) .....28**



2.6.1 REQUIREMENT..... 28

2.6.2 TEST DESCRIPTION ..... 28

2.6.3 TEST PROCEDURE..... 28

2.6.4 TEST RESULT..... 29

**2.7 CONDUCTED SPURIOUS EMISSIONS..... 41**

2.7.1 REQUIREMENT..... 41

2.7.2 TEST DESCRIPTION ..... 41

2.7.3 TEST PROCEDURE..... 41

2.7.4 TEST RESULT..... 42

**2.8 RESTRICTED FREQUENCY BANDS..... 54**

2.8.1 REQUIREMENT..... 54

2.8.2 TEST DESCRIPTION ..... 54

2.8.3 TEST PROCEDURE..... 55

2.8.4 TEST RESULT..... 55

**2.9 CONDUCTED EMISSION ..... 63**

2.9.1 REQUIREMENT..... 63

2.9.2 TEST DESCRIPTION ..... 63

2.9.3 TEST RESULT..... 64

**2.10 RADIATED EMISSION ..... 66**

2.10.1 REQUIREMENT..... 66

2.10.2 TEST DESCRIPTION ..... 67

2.10.3 TEST PROCEDURE..... 69

2.10.4 TEST RESULT..... 69

**ANNEX A GENERAL INFORMATION ..... 79**

Change History		
Issue	Date	Reason for change
1.0	2017-11-22	First edition



### TEST REPORT DECLARATION

Applicant	Shenzhen Medica Technology Development Co.,Ltd
Applicant Address	2F Building A, Tongfang Information Harbor, No. 11, East Langshan Road, Nanshan District, Shenzhen, P.R. China
Manufacturer	Shenzhen Medica Technology Development Co.,Ltd
Manufacturer Address	2F Building A, Tongfang Information Harbor, No. 11, East Langshan Road, Nanshan District, Shenzhen, P.R. China
Product Name	Smart Sleep Light
Model Name	SA1001
Brand Name	N/A
HW Version	V1.0
SW Version	V0.85
Test Standards	47 CFR Part 15 Subpart C
Test Date	2017-09-13 to 2017-10-27
Test Result	PASS

Tested by : Su Hang  
Su Hang (Test Engineer)

Approved by : Andy Yeh  
Andy Yeh (Technical Director)



## 1. TECHNICAL INFORMATION

Note: Provide by applicant.

### 1.1 Applicant Information

Company:	Shenzhen Medica Technology Development Co.,Ltd
Address:	2F Building A, Tongfang Information Harbor, No. 11, East Langshan Road, Nanshan District, Shenzhen, P.R. China

### 1.2 Equipment under Test (EUT) Description

Brand Name:	N/A
Trade Name:	N/A
Model Name:	SA1001
Frequency Range:	The frequency range used is 2402MHz – 2480MHz (79 channels, at intervals of 1MHz); The frequency block is 2400MHz to 2483.5MHz.
Modulation Type:	Bluetooth: FHSS (GFSK(1Mbps), $\pi/4$ -DQPSK(EDR 2Mbps), 8-DPSK(EDR 3Mbps))
Bluetooth Version:	Bluetooth 2.1 + EDR
Antenna Type:	Ceramic Antenna
Antenna Gain:	2.41 dBi

**NOTE 1:** The EUT is a Smart Sleep Light. It contains Bluetooth Module operating at 2.4GHz ISM band; the frequencies allocated for the Bluetooth Module is  $F(\text{MHz})=2402+1*n$  ( $0 \leq n \leq 78$ ). The lowest, middle, highest channel numbers of the Bluetooth Module used and tested in this report are separately 0 (2402MHz), 39 (2441MHz) and 78 (2480MHz).

**NOTE 2:** The EUT connected to the serial port of the computer with a serial communication cable, we use the dedicated software to control the EUT into the test mode, and then use MT8852B base station to control the EUT continuous transmission.

For a more detailed description, please refer to Specification or User's Manual supplied by the applicant and/or manufacturer.

#### 1.2.1 Identification of all used EUTs

The EUT identity consists of numerical and letter characters, the letter character indicates the test sample, and the following two numerical characters indicate the software version of the test sample.

EUT Identity	Hardware Version	Software Version
A01	V1.0	V0.85



### 1.3 Test Standards and Results

The objective of the report is to perform testing according to 47 CFR Part 15 Subpart C (Bluetooth, 2.4GHz ISM band radiators) for the EUT FCC ID Certification:

No.	Identity	Document Title
1	47 CFR Part 15 (10-1-15 Edition)	Radio Frequency Devices

Test detailed items/section required by FCC rules and results are as below:

No.	Section in CFR 47	Description	Test Date	Result
1	15.203	Antenna Requirement	N/A	<b><u>PASS</u></b>
2	15.247(a)	Number of Hopping Frequency	Sep 13, 2017	<b><u>PASS</u></b>
3	15.247(b)	Peak Output Power	Sep 13, 2017	<b><u>PASS</u></b>
4	15.247(a)	20dB Bandwidth	Sep 13, 2017	<b><u>PASS</u></b>
5	15.247(a)	Carrier Frequency Separation	Sep 13, 2017	<b><u>PASS</u></b>
6	15.247(a)	Time of Occupancy (Dwell time)	Sep 13, 2017	<b><u>PASS</u></b>
7	15.247(d)	Conducted Spurious Emission	Sep 13, 2017	<b><u>PASS</u></b>
8	15.247(d)	Restricted Frequency Bands	Oct 26, 2017	<b><u>PASS</u></b>
9	15.209 15.247(d)	Radiated Emission	Oct 26, 2017	<b><u>PASS</u></b>
10	15.207	Conducted Emission	Oct 27, 2017	<b><u>PASS</u></b>

**NOTE:** The tests were performed according to the method of measurements prescribed in ANSI C63.10-2013.

#### 1.3.1 Test Environment Conditions

During the measurement, the environmental conditions were within the listed ranges:

Temperature (°C):	15 - 35
Relative Humidity (%):	30 -60
Atmospheric Pressure (kPa):	86-106

## 2. 47 CFR PART 15C REQUIREMENTS

### 2.1 Antenna requirement

#### 2.1.1 Applicable Standard

According to FCC 15.203, an intentional radiator shall be designed to ensure that no antenna other than that furnished by the responsible party shall be used with the device. The use of a permanently attached antenna or of an antenna that uses a unique coupling to the intentional radiator shall be considered sufficient to comply with the provisions of this section.

#### 2.1.2 Result: Compliant

The EUT has a permanently and irreplaceable attached antenna. Please refer to the EUT internal photos.

### 2.2 Number of Hopping Frequency

#### 2.2.1 Requirement

According to FCC §15.247(a)(1)(iii), frequency hopping systems operating in the 2400MHz to 2483.5MHz bands shall use at least 15 hopping frequencies.

#### 2.2.2 Test Description

##### A. Test Setup:

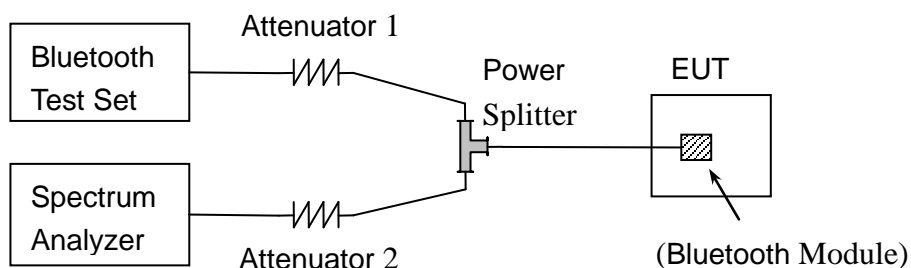

The Bluetooth Module of the EUT is coupled to the Spectrum Analyzer (SA) and the Bluetooth Test Set with Attenuators through the Power Splitter; the RF load attached to the EUT antenna terminal is 50Ohm; the path loss as the factor is calibrated to correct the reading. During the measurement, the Bluetooth Module of the EUT is activated and controlled by the SS, and is set to operate under test mode transmitting 339 bytes DH5 packages at maximum power.

##### B. Equipments List:

Please reference ANNEX A(1.5).



### 2.2.3 Test Procedure

The EUT must have its hopping function enabled. Use the following spectrum analyzer settings:

Span = the frequency band of operation

RBW  $\geq$  1% of the span

VBW  $\geq$  RBW

Sweep = auto

Detector function = peak

Trace = max hold

Allow the trace to stabilize

### 2.2.4 Test Result

The Bluetooth Module operates at hopping-on test mode; the frequencies number employed is counted to verify the Module's using the number of hopping frequency.

#### A. Test Verdict:

Test Mode	Frequency Block (MHz)	Measured Channel Numbers	Min. Limit	Refer to Plot	Verdict
GFSK	2400 - 2483.5	79	15	Plot A	PASS
$\pi/4$ -DQPSK	2400 - 2483.5	79	15	Plot B	PASS
8-DPSK	2400 - 2483.5	79	15	Plot C	PASS

#### B. Test Plots:

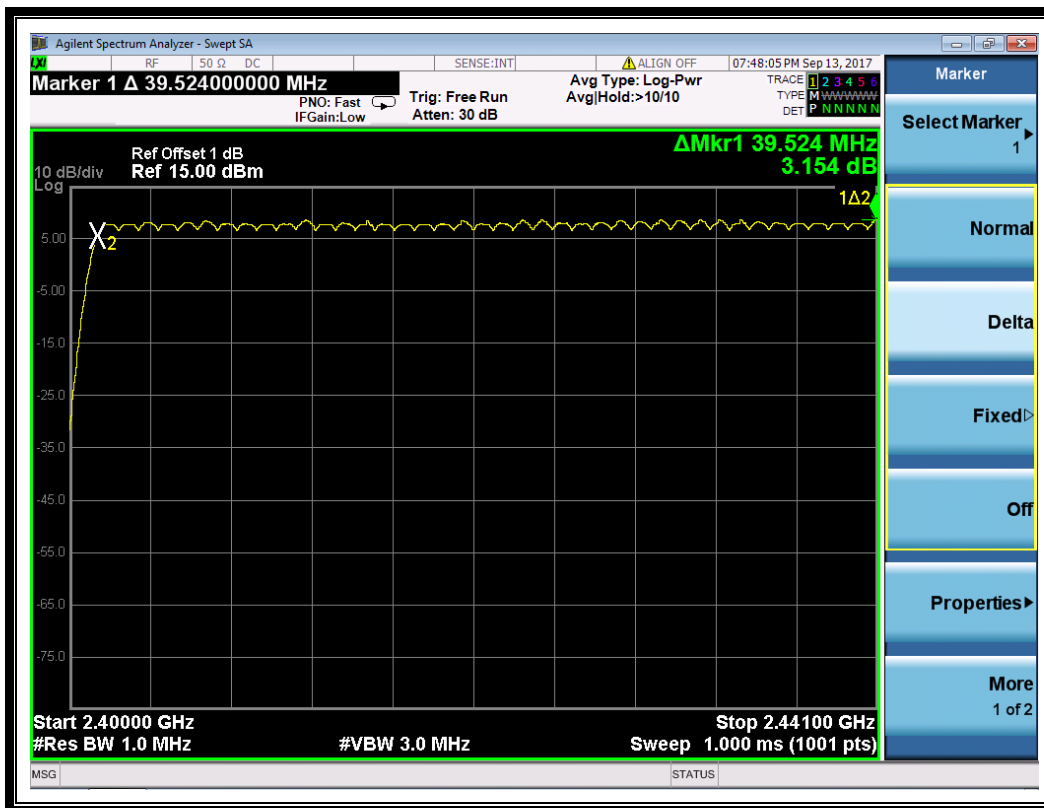



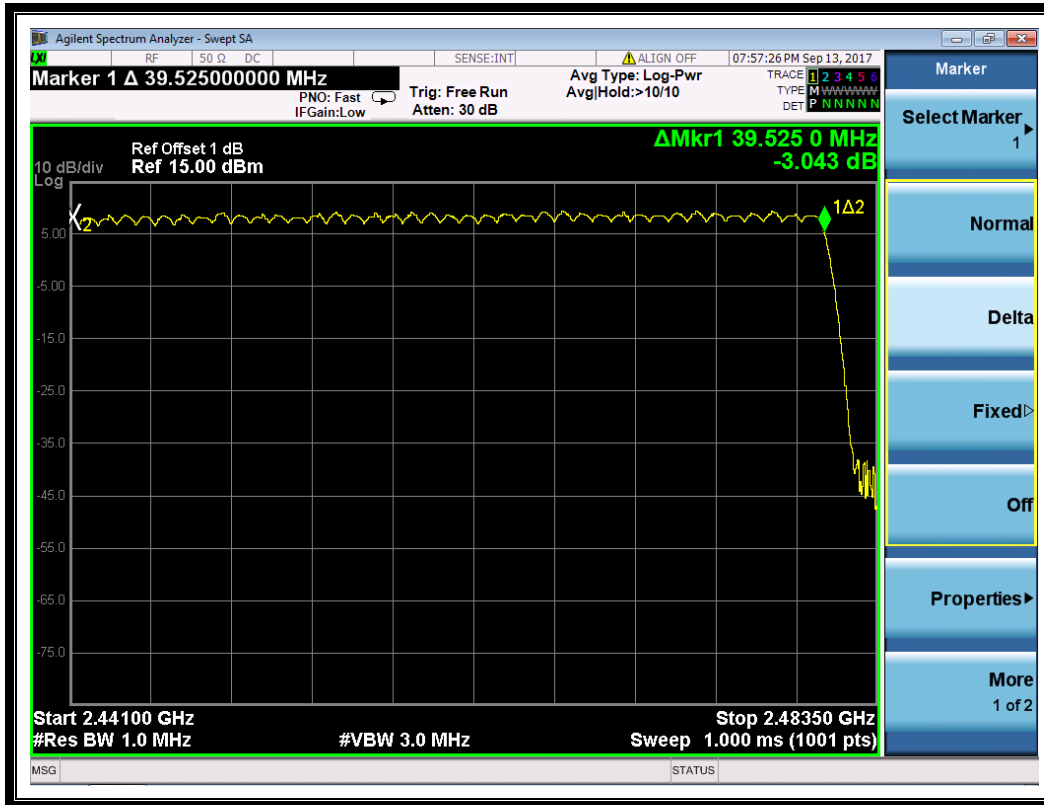

(Plot A: GFSK)

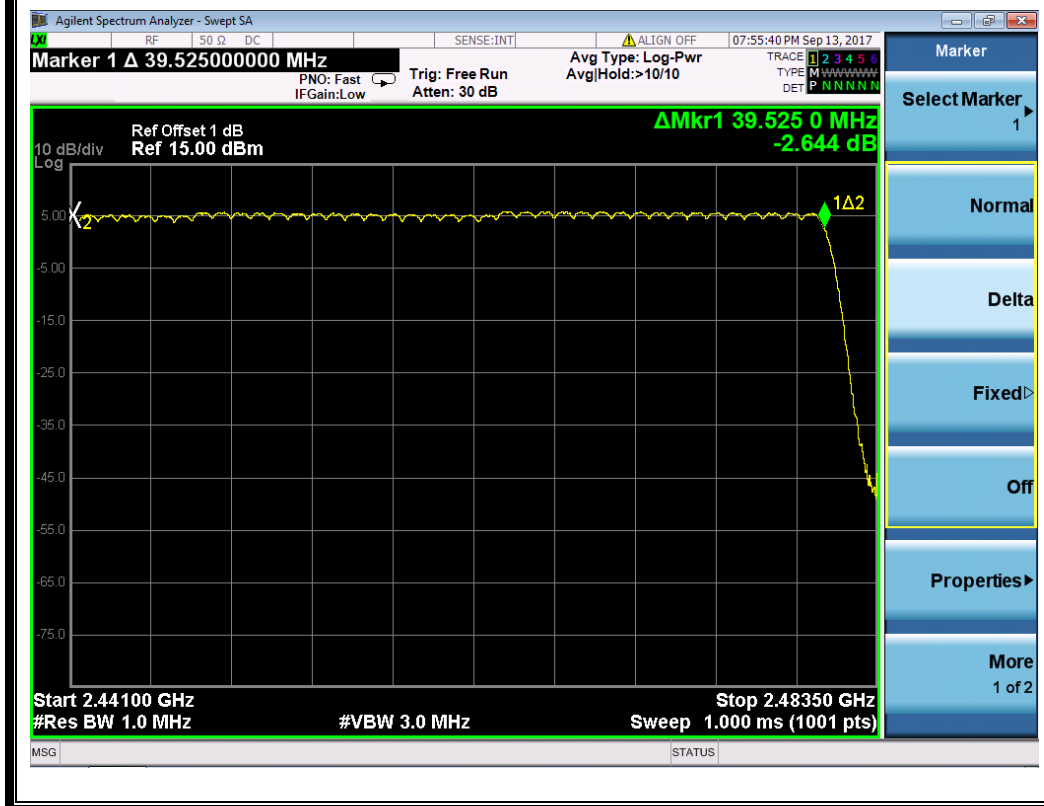
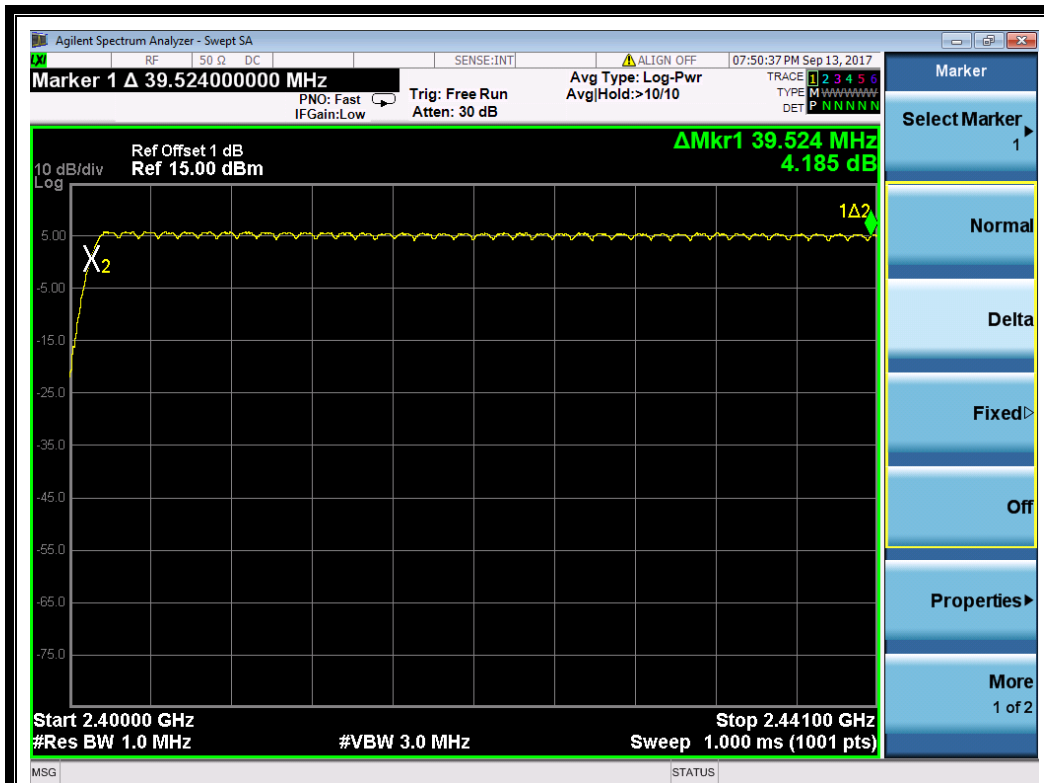

(Plot B:  $\pi/4$ -DQPSK)



(Plot C: 8- DPSK)

## 2.3 Peak Output Power

### 2.3.1 Requirement

According to FCC §15.247(b)(1), for frequency hopping systems that operates in the 2400MHz to 2483.5MHz band employing at least 75 hopping channels, the maximum peak output power of the intentional radiator shall not exceed 1Watt. For all other frequency hopping systems in the 2400MHz to 2483.5MHz band, it is 0.125Watts.

### 2.3.2 Test Description

#### A. Test Setup:

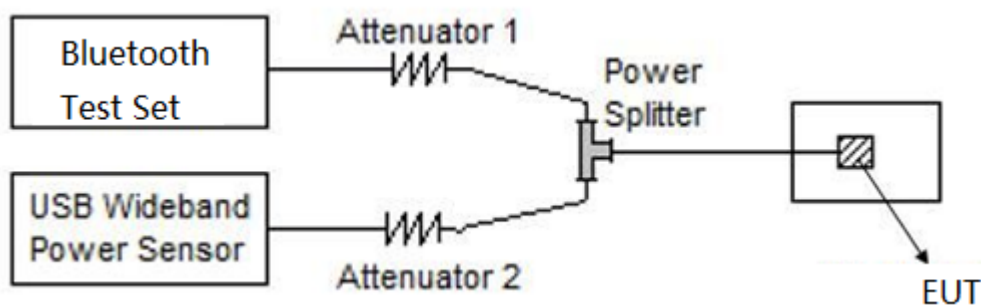

The Bluetooth Module of the EUT is coupled to the USB Wideband Power Sensor and the Bluetooth Test Set with Attenuators through the Power Splitter; the RF load attached to the EUT antenna terminal is 50Ohm; the path loss as the factor is calibrated to correct the reading. During the measurement, the Bluetooth Module of the EUT is activated and controlled by the SS, and is set to operate under test mode transmitting 339 bytes DH5 packages at maximum power.

#### B. Equipments List:

Please reference ANNEX A(1.5).

### 2.3.3 Test Result

The Bluetooth Module operates at hopping-off test mode. The lowest, middle and highest channels are selected to perform testing to verify the conducted RF output peak power of the module. The lowest, middle and highest channel were tested by USB Wideband Power Sensor.

**2.3.3.1 GFSK Mode****A. Test Verdict:**

Channel	Frequency (MHz)	Measured Output Peak Power		Limit		Verdict
		dBm	W	dBm	W	
0	2402	9.87	0.009705	30	1	PASS
39	2441	10.01	0.010023			PASS
78	2480	9.35	0.008610			PASS

**2.3.3.2  $\pi/4$ -DQPSK Mode****B. Test Verdict:**

Channel	Frequency (MHz)	Measured Output Peak Power		Limit		Verdict
		dBm	W	dBm	W	
0	2402	8.50	0.007079	20.97	0.125	PASS
39	2441	7.35	0.005433			PASS
78	2480	5.14	0.003266			PASS

**2.3.3.3 8-DPSK Mode****C. Test Verdict:**

Channel	Frequency (MHz)	Measured Output Peak Power		Limit		Verdict
		dBm	W	dBm	W	
0	2402	8.52	0.007112	20.97	0.125	PASS
39	2441	7.52	0.005649			PASS
78	2480	5.37	0.003443			PASS

## 2.4 20dB Bandwidth

### 2.4.1 Definition

According to FCC §15.247(a)(1), the 20dB bandwidth is known as the 99% emission bandwidth, or 20dB bandwidth ( $10 \cdot \log 1\% = 20\text{dB}$ ) taking the total RF output power.

### 2.4.2 Test Description

#### A. Test Setup:

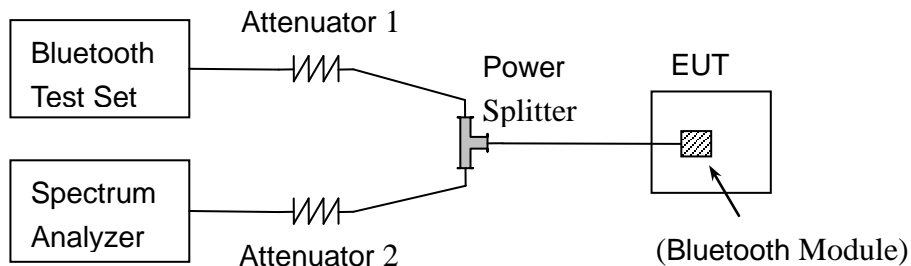

The Bluetooth Module of the EUT is coupled to the Spectrum Analyzer (SA) and the Bluetooth Test Set with Attenuators through the Power Splitter; the RF load attached to the EUT antenna terminal is 50Ohm; the path loss as the factor is calibrated to correct the reading. During the measurement, the Bluetooth Module of the EUT is activated and controlled by the SS, and is set to operate under test mode transmitting 339 bytes DH5 packages at maximum power.

#### B. Equipments List:

Please reference ANNEX A(1.5).

### 2.4.3 Test Procedure

Use the following spectrum analyzer settings:

Span = approximately 2 to 3 times the 20 dB bandwidth, centered on a hopping channel

RBW  $\geq$  1% of the 20 dB bandwidth

VBW  $\geq$  RBW

Sweep = auto

Detector function = peak

Trace = max hold

### 2.4.4 Test Result

The Bluetooth Module operates at hopping-off test mode. The lowest, middle and highest channels are selected to perform testing to record the 20dB bandwidth of the Module.



2.4.4.1 GFSK Mode

A. Test Verdict:

The maximum 20dB bandwidth measured is 1.031 MHz according to the table below.

Channel	Frequency (MHz)	20dB Bandwidth (MHz)	Refer to Plot
0	2402	1.031	Plot A
39	2441	1.031	Plot B
78	2480	1.031	Plot C

B. Test Plots:

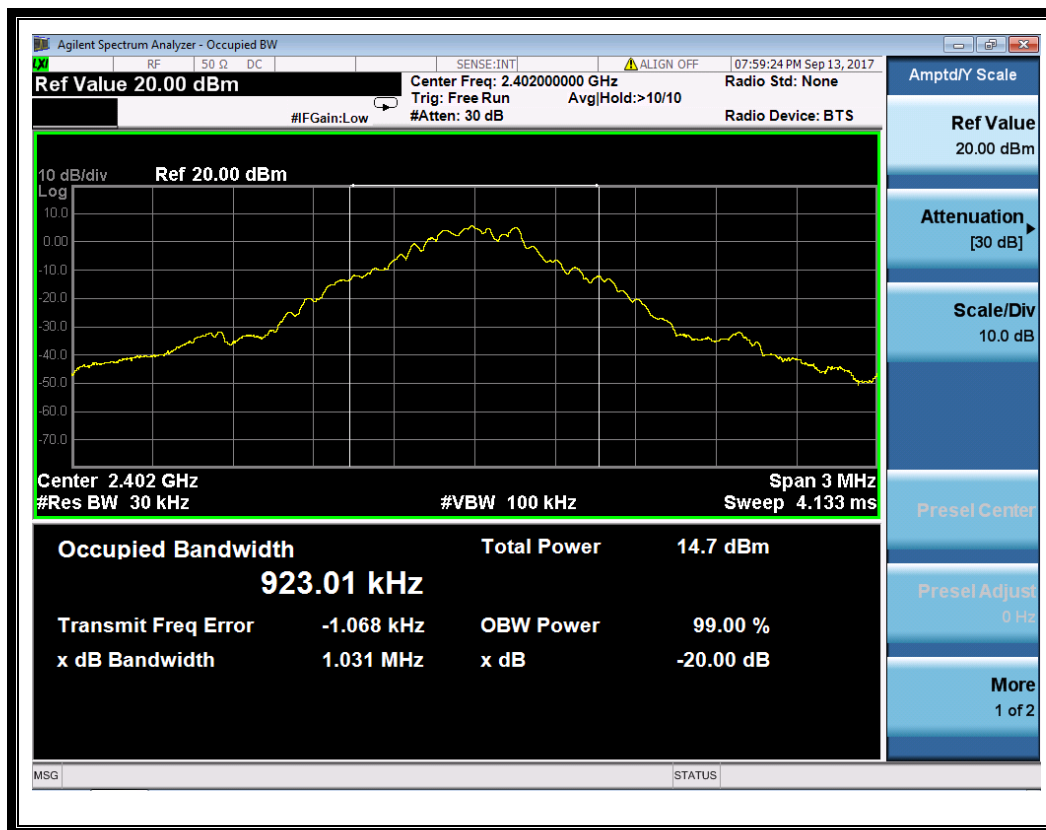

(Plot A: Channel = 2402 @ GFSK)



(Plot B: Channel = 2441 @ GFSK)



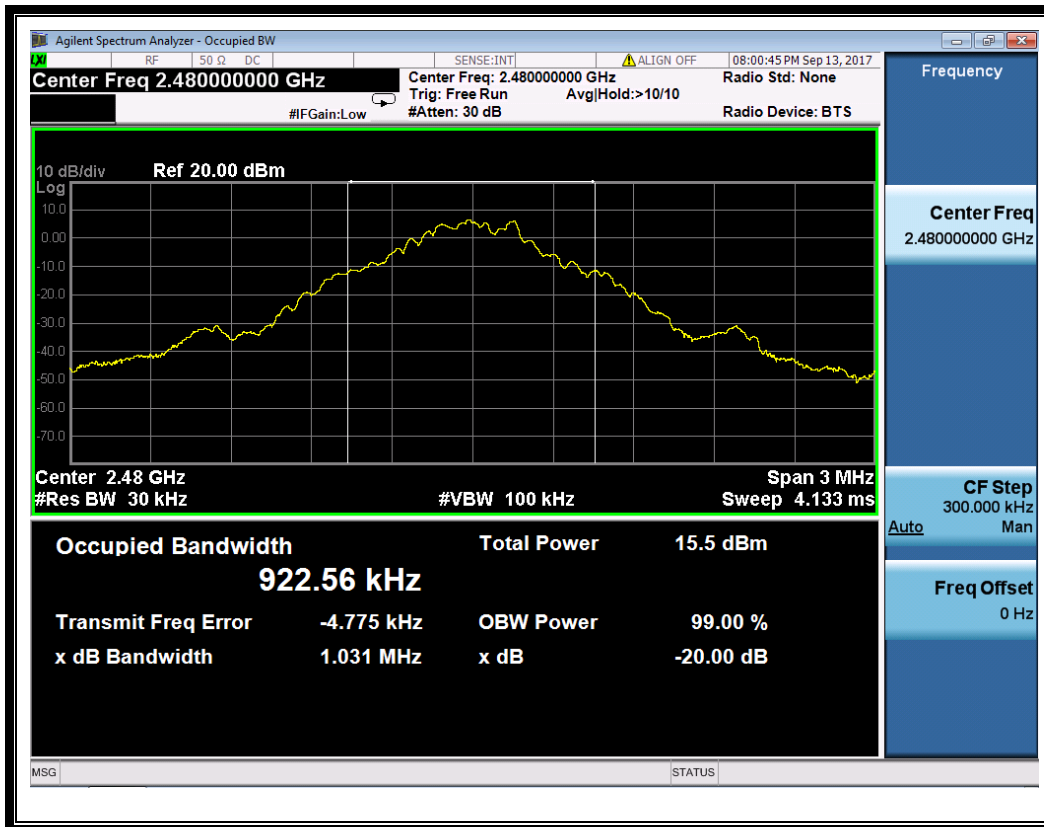

(Plot C: Channel = 2480 @ GFSK)

#### 2.4.4.2 $\pi/4$ -DQPSK Mode

##### A. Test Verdict:

The maximum 20dB bandwidth measured is 1.354 MHz according to the table below.

Channel	Frequency (MHz)	20dB Bandwidth (MHz)	Refer to Plot
0	2402	1.350	Plot D
39	2441	1.350	Plot E
78	2480	1.354	Plot F

##### B. Test Plots:

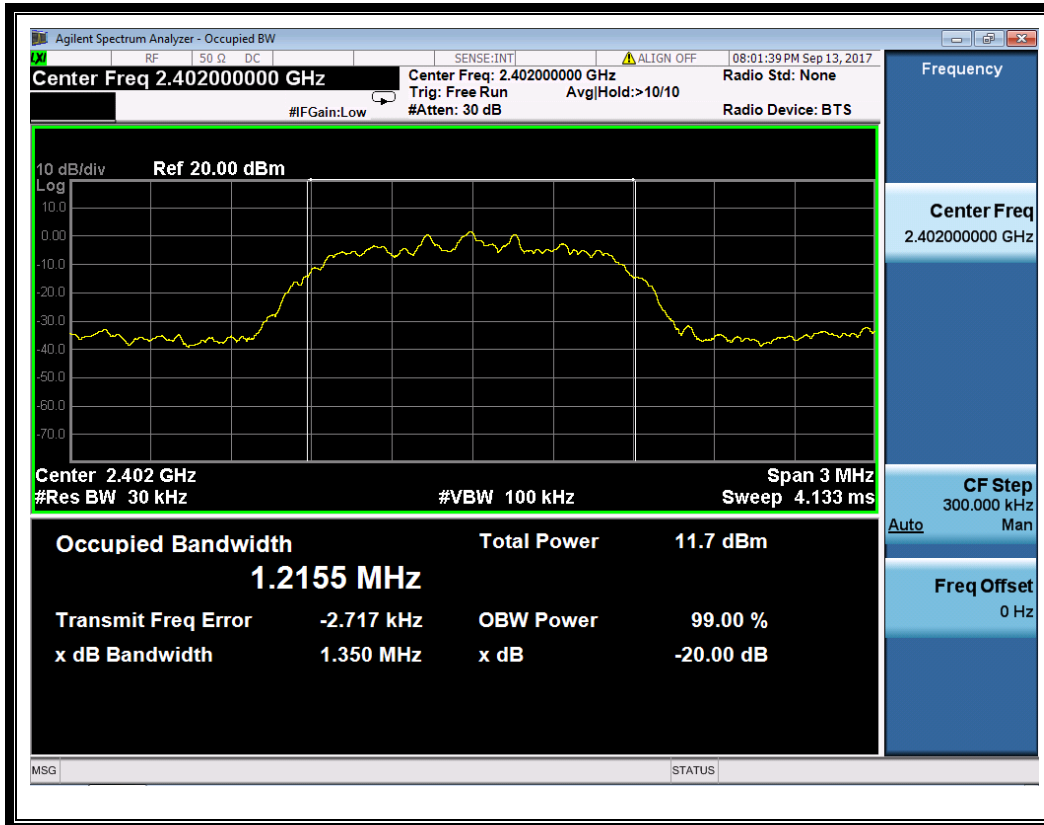

(Plot D: Channel = 2402 @  $\pi/4$ -DQPSK)

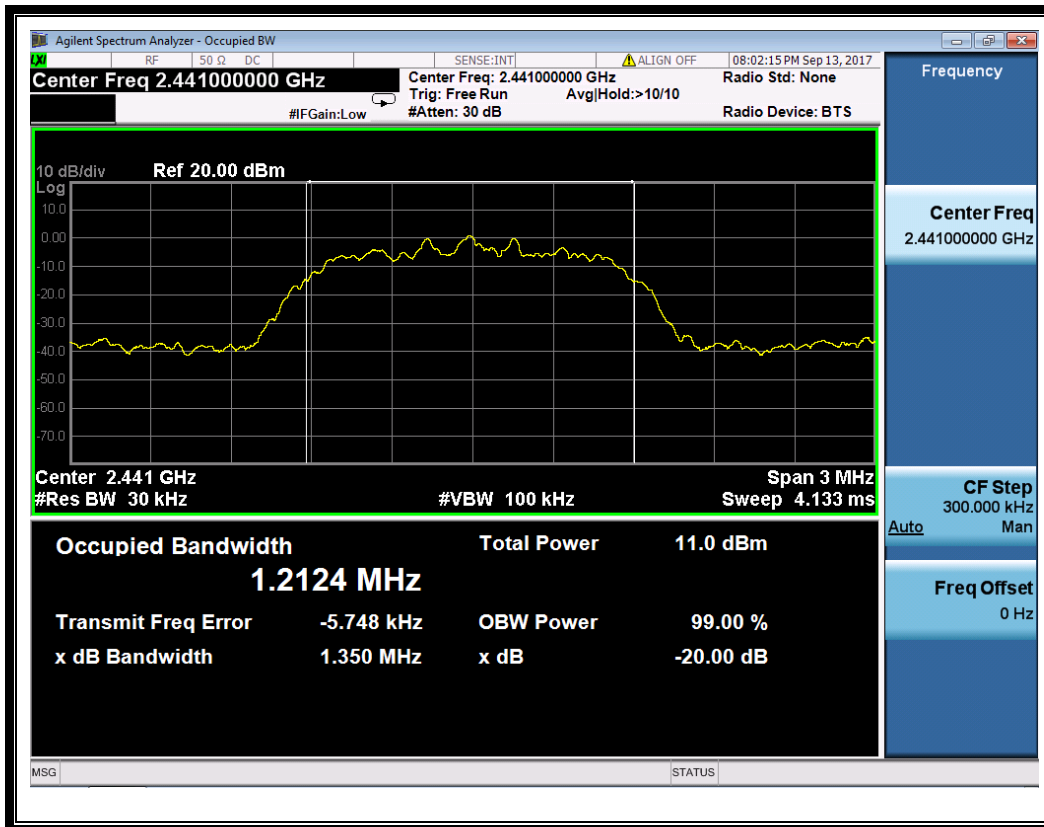

(Plot E: Channel = 2441 @  $\pi/4$ -DQPSK)

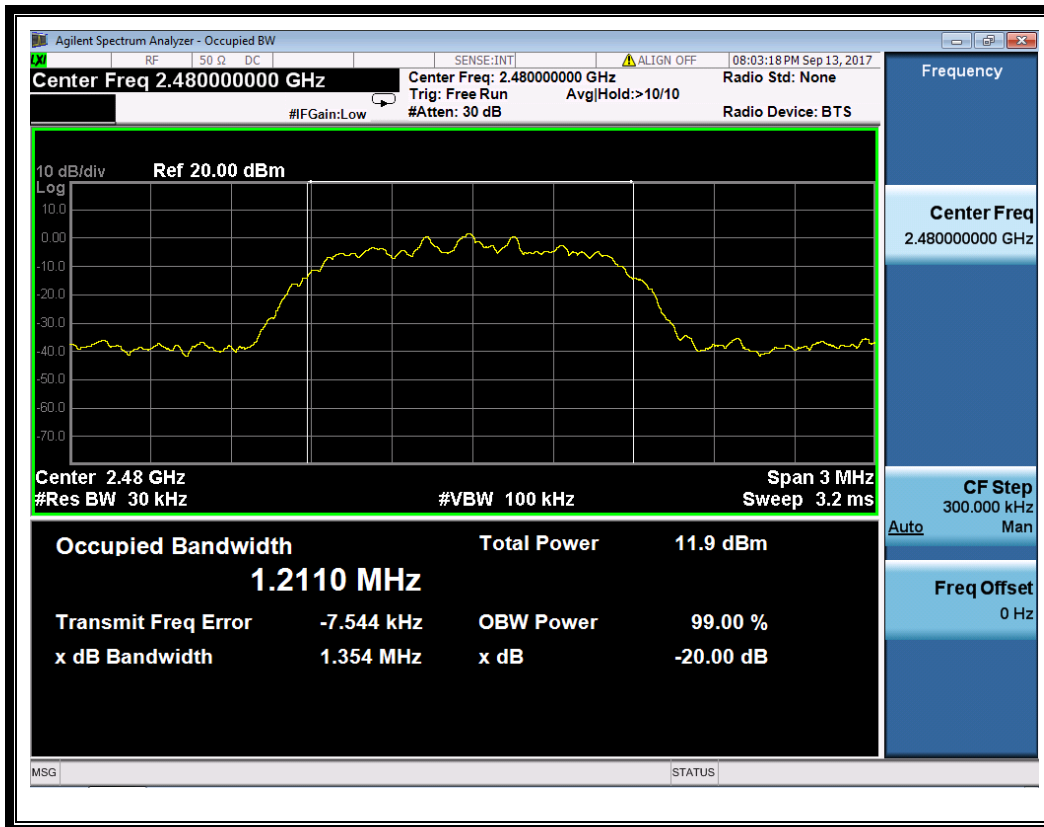

(Plot F: Channel = 2480 @  $\pi/4$ -DQPSK)

### 2.4.4.3 8-DPSK Mode

#### A. Test Verdict:

The maximum 20dB bandwidth measured is 1.337 MHz according to the table below.

Channel	Frequency (MHz)	20dB Bandwidth (MHz)	Refer to Plot
0	2402	1.335	Plot G
39	2441	1.337	Plot H
78	2480	1.337	Plot I

#### B. Test Plots:

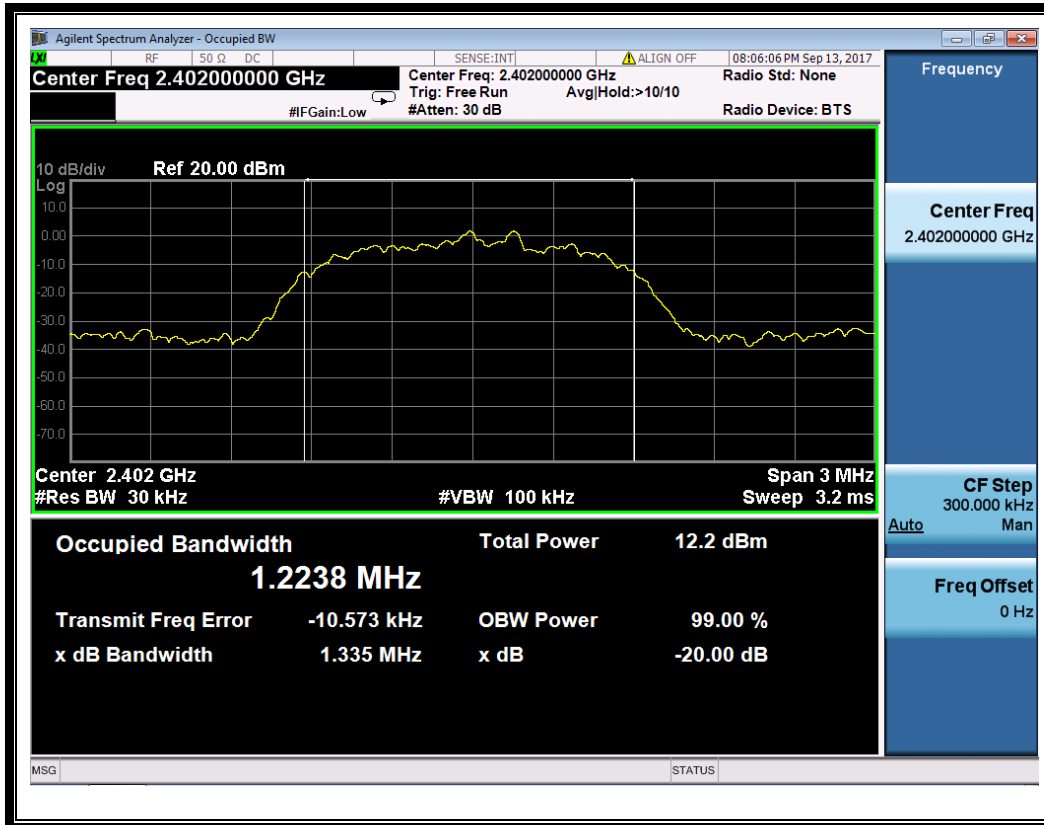

(Plot G: Channel = 2402 @ 8-DPSK)

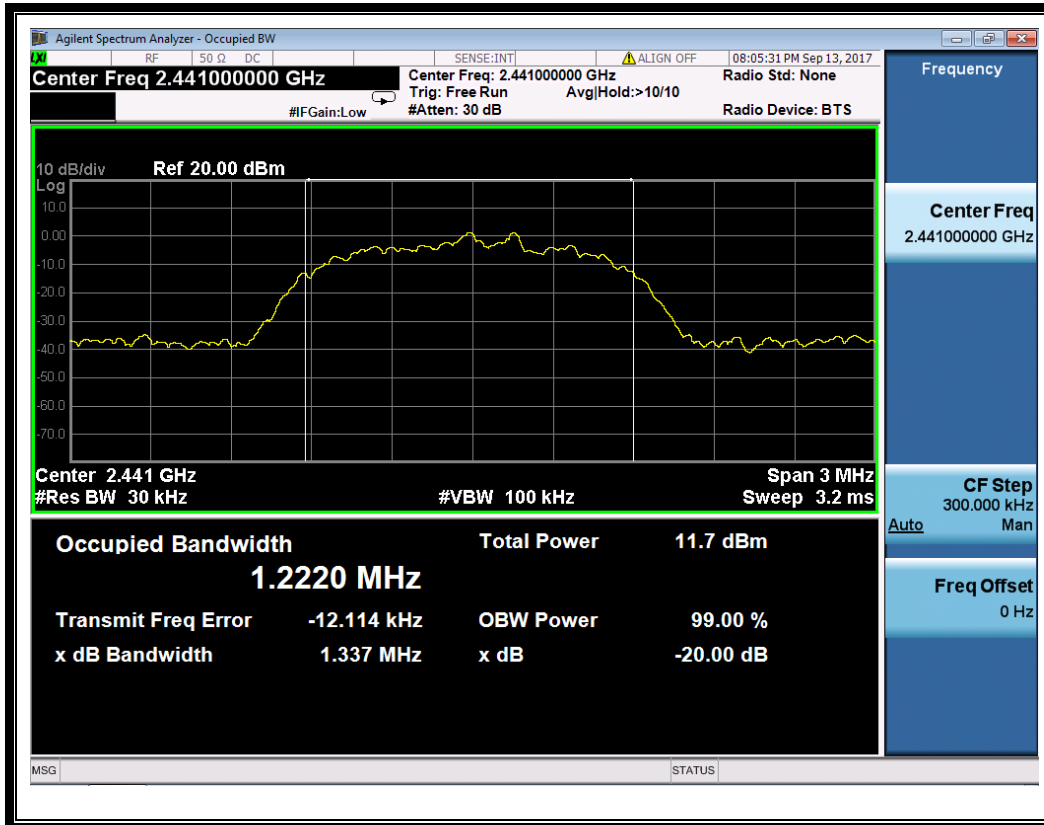

(Plot H: Channel = 2441 @ 8-DPSK)

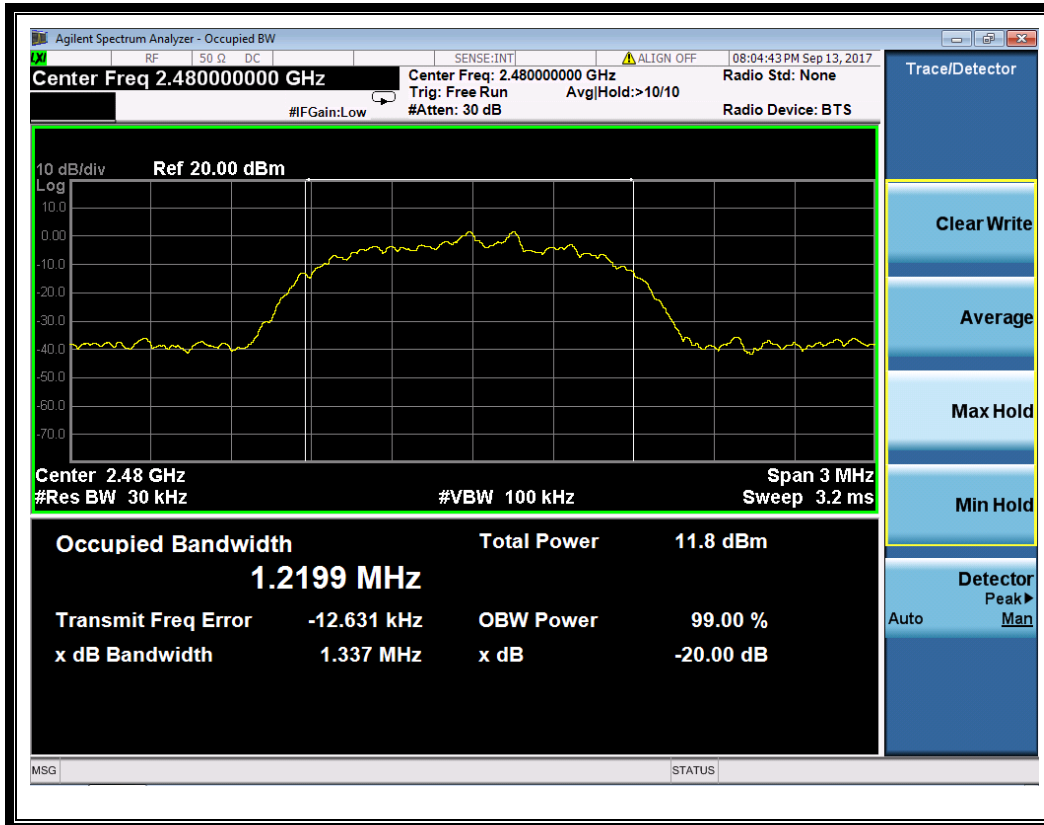

(Plot I: Channel = 2480 @ 8-DPSK)

## 2.5 Carried Frequency Separation

### 2.5.1 Definition

According to FCC §15.247(a)(1), frequency hopping systems shall have hopping channel carrier frequencies separated by a minimum of 25kHz or two-thirds of the 20dB bandwidth of the hopping channel, whichever is greater.

### 2.5.2 Test Description

#### A. Test Setup:

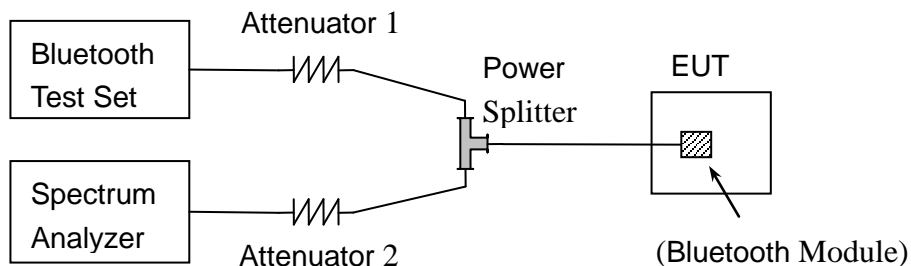

The Bluetooth Module of the EUT is coupled to the Spectrum Analyzer (SA) and the Bluetooth Test Set with Attenuators through the Power Splitter; the RF load attached to the EUT antenna terminal is 50Ohm; the path loss as the factor is calibrated to correct the reading. During the measurement, the Bluetooth Module of the EUT is activated and controlled by the SS, and is set to operate under test mode transmitting 339 bytes DH5 packages at maximum power.

#### B. Equipments List:

Please reference ANNEX A(1.5).

### 2.5.3 Test Procedure

The EUT must have its hopping function enabled. Use the following spectrum analyzer settings:

Span = wide enough to capture the peaks of two adjacent channels

Resolution (or IF) Bandwidth (RBW)  $\geq$  1% of the span

Video (or Average) Bandwidth (VBW)  $\geq$  RBW

Sweep = auto

Detector function = peak

Trace = max hold

Allow the trace to stabilize. Use the marker-delta function to determine the separation between the peaks of the adjacent channels.



### 2.5.4 Test Result

The Bluetooth Module operates at hopping-on test mode. For any adjacent channels (e.g. the channel 39 and 40 as showed in the Plot A), the Module does have hopping channel carrier frequencies separated by a minimum of 25kHz or two-thirds of the 20dB bandwidth of the hopping channel (refer to section 2.4.4), whichever is greater. So, the verdict is PASSING

Test Mode	Measured Channel Numbers	Carried Frequency Separation	Refer to Plot	20dB bandwidth (MHz)	Min. Limit	Verdict
GFSK	39 and 40	1.002	Plot A	1.031	two-thirds of the 20dB bandwidth	PASS
$\pi/4$ -DQPSK	39 and 40	1.002	Plot B	1.354		PASS
8-DPSK	39 and 40	1.002	Plot C	1.337		PASS

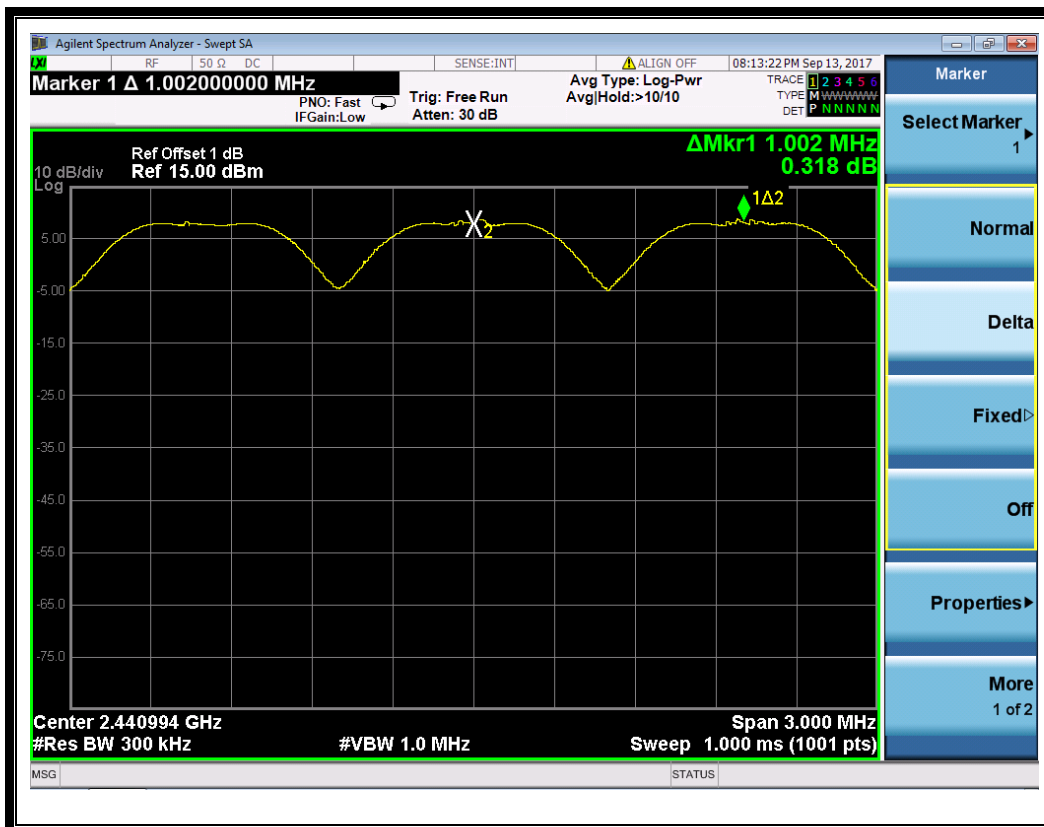

(Plot A: GFSK)

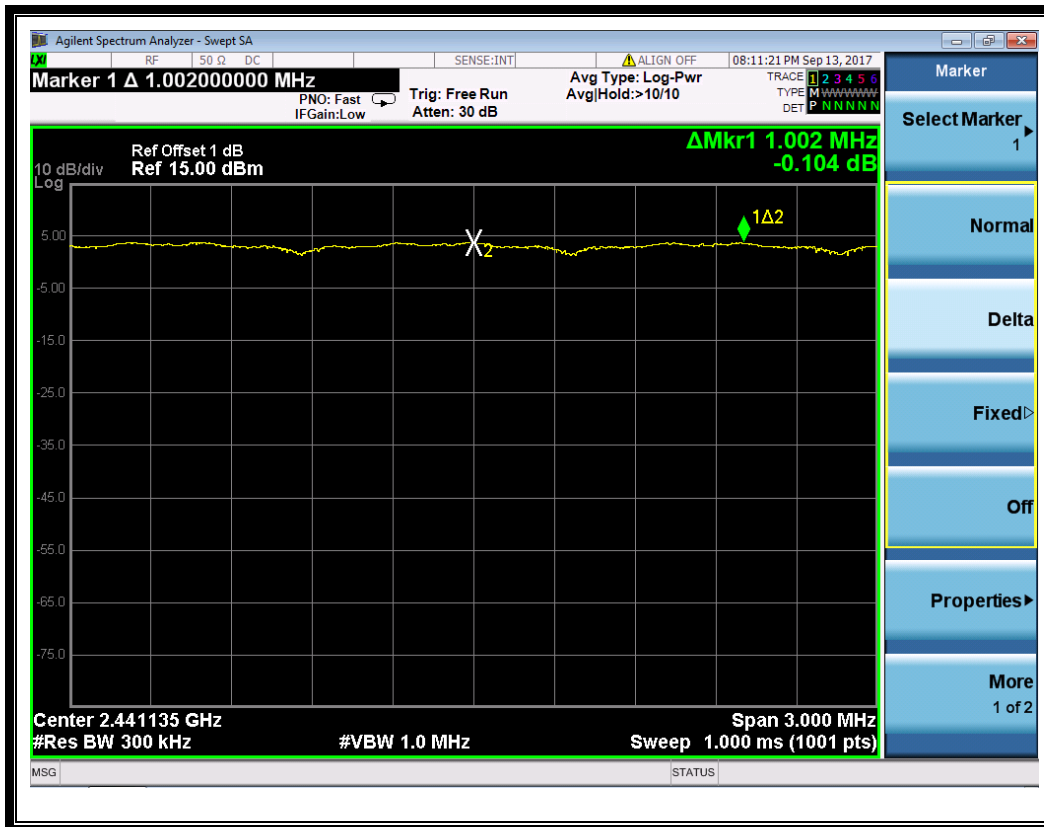

(Plot B:  $\pi/4$ -DQPSK)

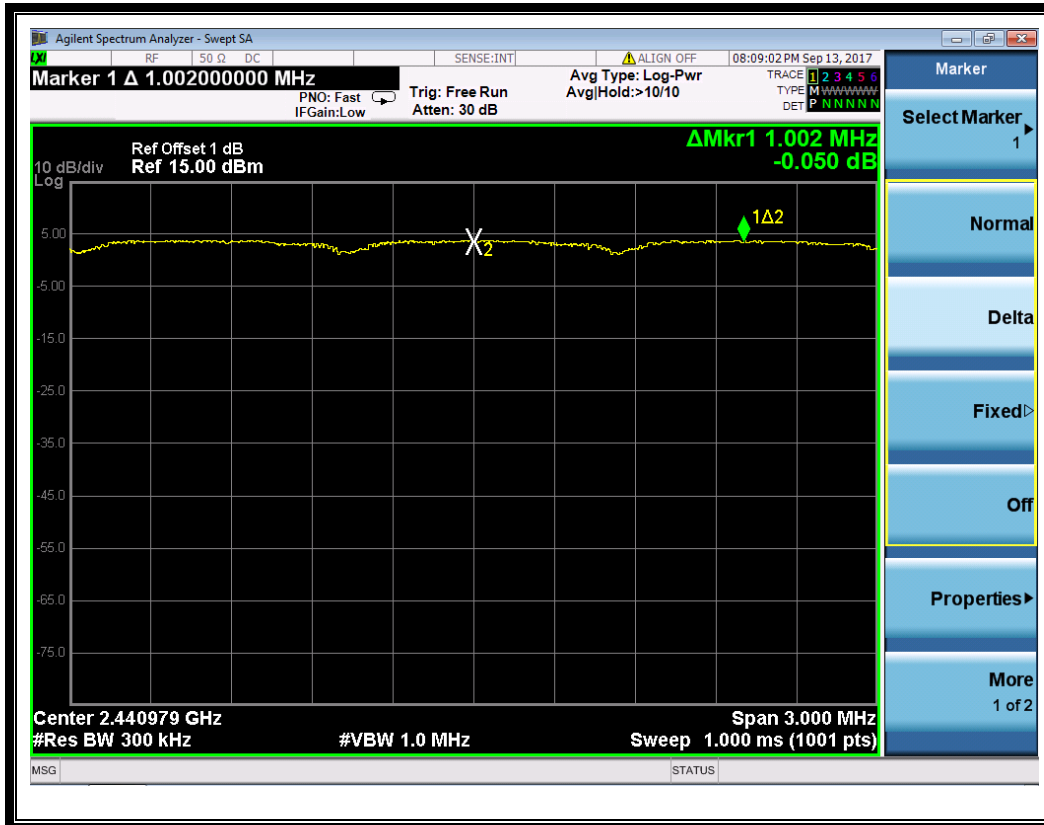

(Plot C: 8-DPSK)

## 2.6 Time of Occupancy (Dwell time)

### 2.6.1 Requirement

According to FCC §15.247(a) (1) (iii), frequency hopping systems in the 2400 - 2483.5MHz band shall use at least 15 non-overlapping channels. The average time of occupancy on any channel shall not be greater than 0.4 seconds within a period of 0.4 seconds multiplied by the number of hopping channels employed. Frequency hopping systems may avoid or suppress transmissions on a particular hopping frequency provided that a minimum of 15 channels are used.

### 2.6.2 Test Description

#### A. Test Setup:

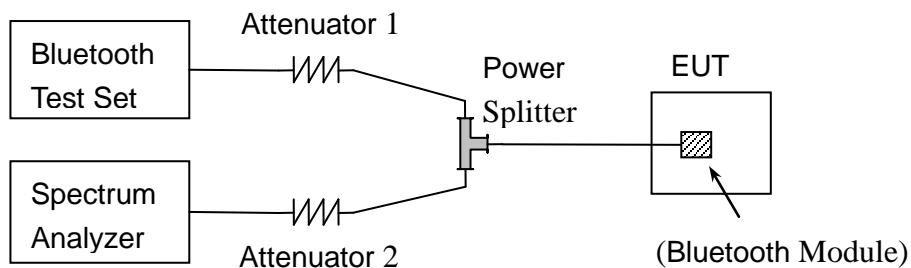

The Bluetooth Module of the EUT is coupled to the Spectrum Analyzer (SA) and the Bluetooth Test Set with Attenuators through the Power Splitter; the RF load attached to the EUT antenna terminal is 50Ohm; the path loss as the factor is calibrated to correct the reading. During the measurement, the Bluetooth Module of the EUT is activated and controlled by the SS, and is set to operate under test mode transmitting 339 bytes DH5 packages at maximum power.

#### B. Equipments List:

Please reference ANNEX A(1.5).

### 2.6.3 Test Procedure

The transmitter output is connected to a spectrum analyzer. The span is set to 0 Hz, centered on a single, selected hopping channel. The width of a single pulse is measured in a fast scan. The number of pulses is measured in a 3.16 second scan, to enable resolution of each occurrence.

The average time of occupancy in the specified 31.6 second period (79 channel \* 0.4 s) is equal to  $10 * (\# \text{ of pulses in } 3.16 \text{ s}) * \text{ pulse width}$ .



2.6.4 Test Result

2.6.4.1 GFSK Mode

A. Test Verdict:

DH Packet	Pulse Width (msec)	Number of pulse in 3.16 seconds	Average Time of Occupancy in 3.16 seconds (sec)	Average Time of Occupancy in 31.6 seconds (sec)	Limit (sec)	Verdict
DH1	0.38	32	0.01216	0.1216	0.4	PASS
DH3	1.65	14	0.02310	0.2310		PASS
DH5	2.88	9	0.02592	0.2592		PASS

B. Test Plots:

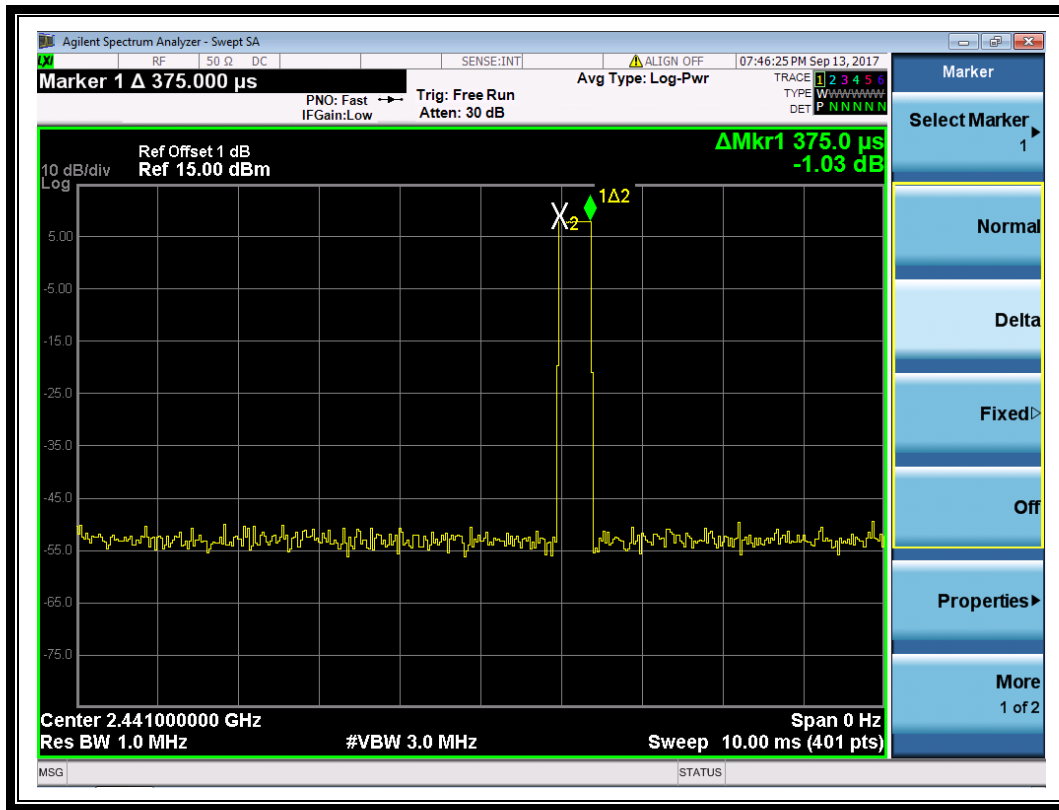

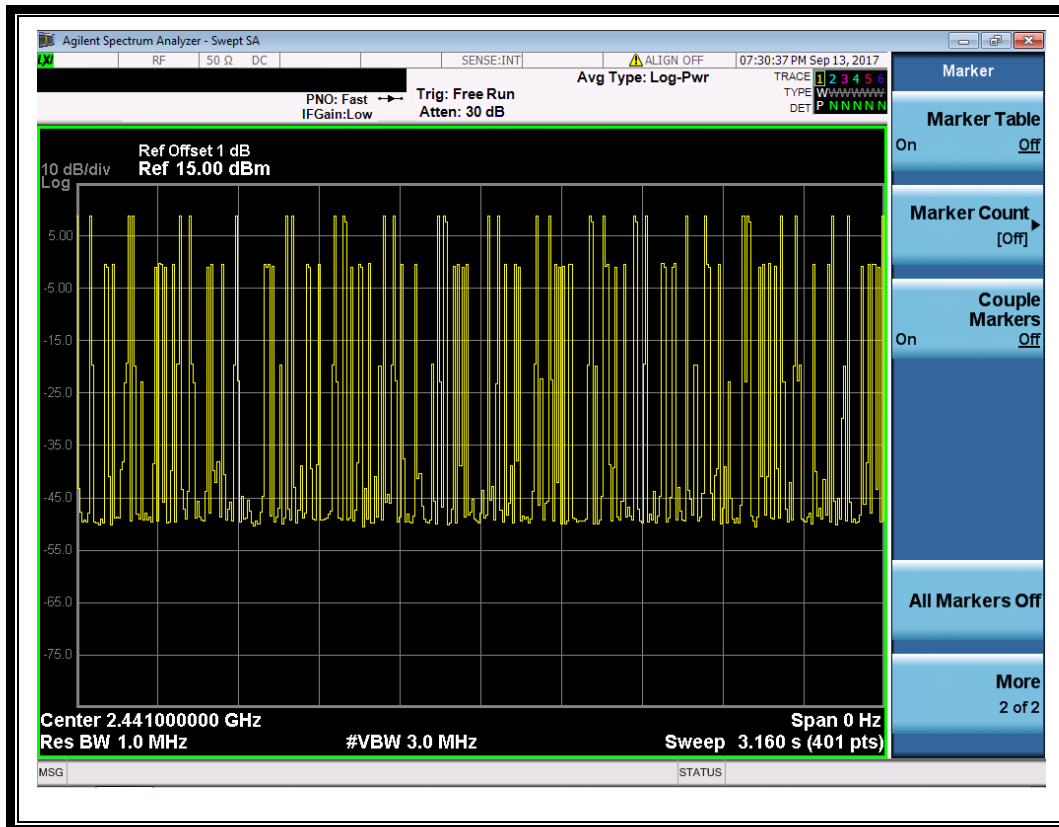

(Plot A: DH1 @ GFSK)

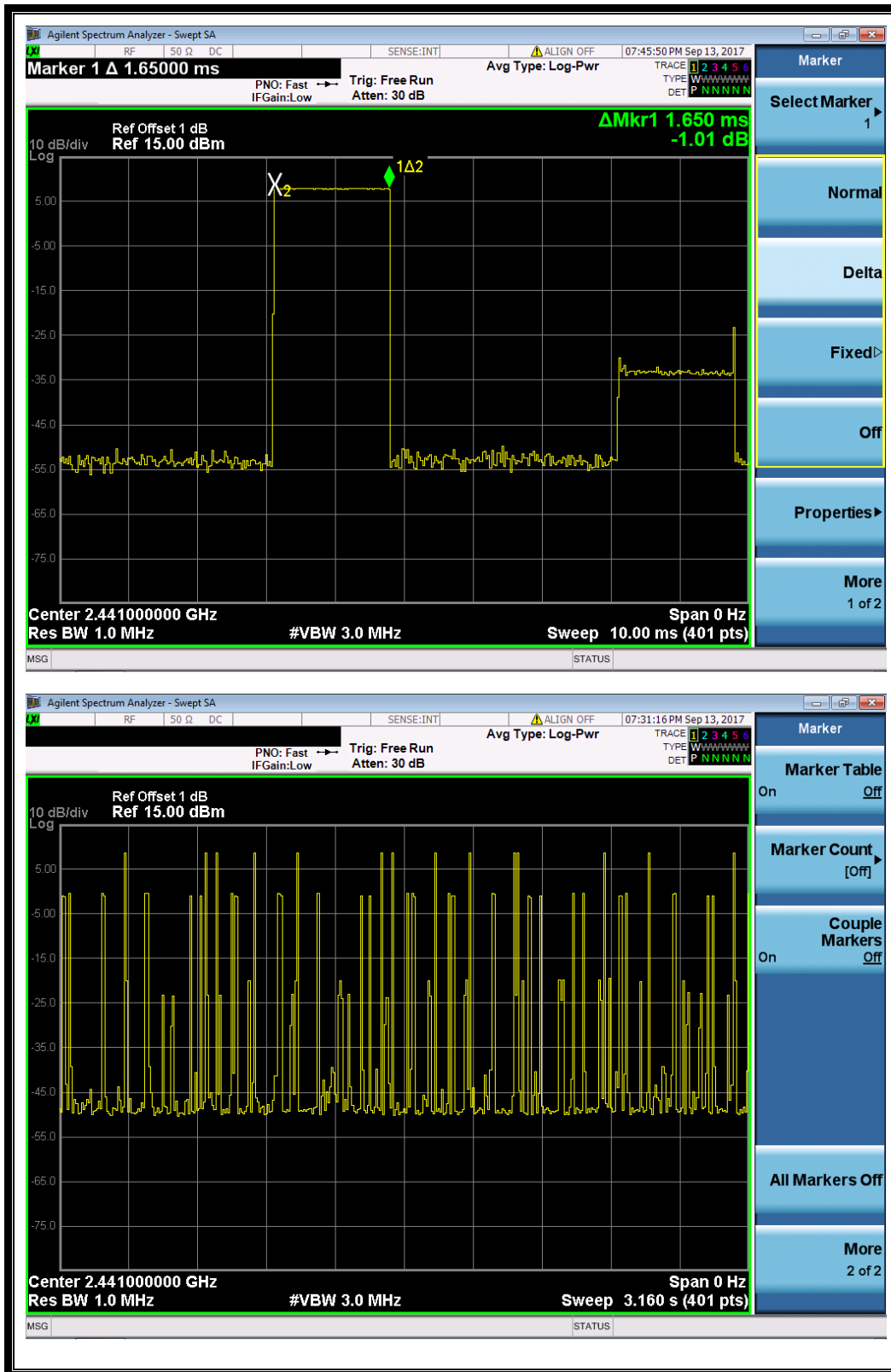

(Plot B: DH3 @ GFSK)

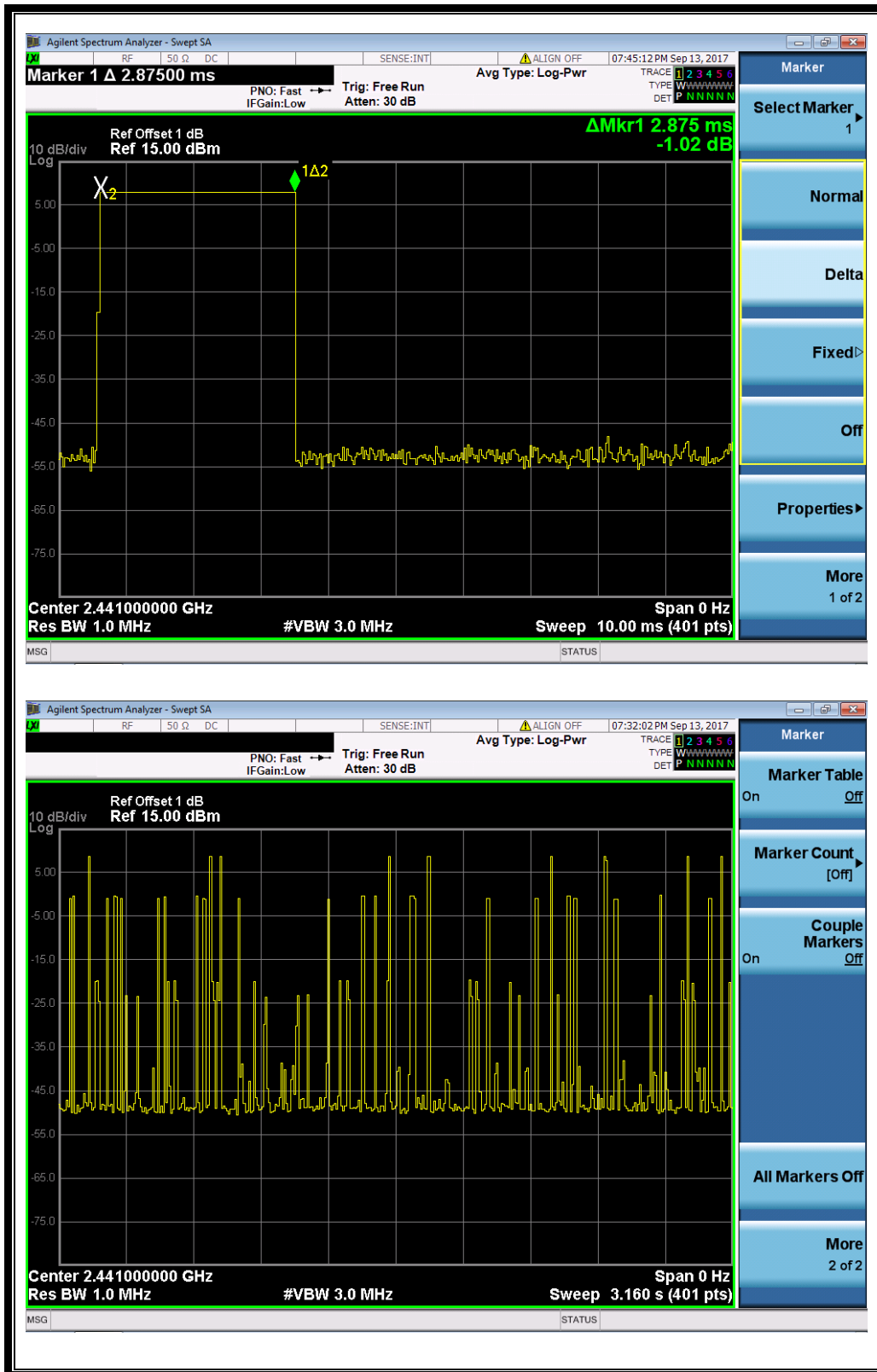

(Plot C: DH5 @ GFSK)





2.6.4.2  $\pi/4$ -DQPSK Mode

A. Test Verdict:

DH Packet	Pulse Width (msec)	Number of pulse in 3.16 seconds	Average Time of Occupancy in 3.16 seconds (sec)	Average Time of Occupancy in 31.6 seconds (sec)	Limit (sec)	Verdict
DH1	0.4	30	0.01200	0.1200	0.4	PASS
DH3	1.65	15	0.02475	0.2475		PASS
DH5	2.88	13	0.03744	0.3744		PASS

B. Test Plots:

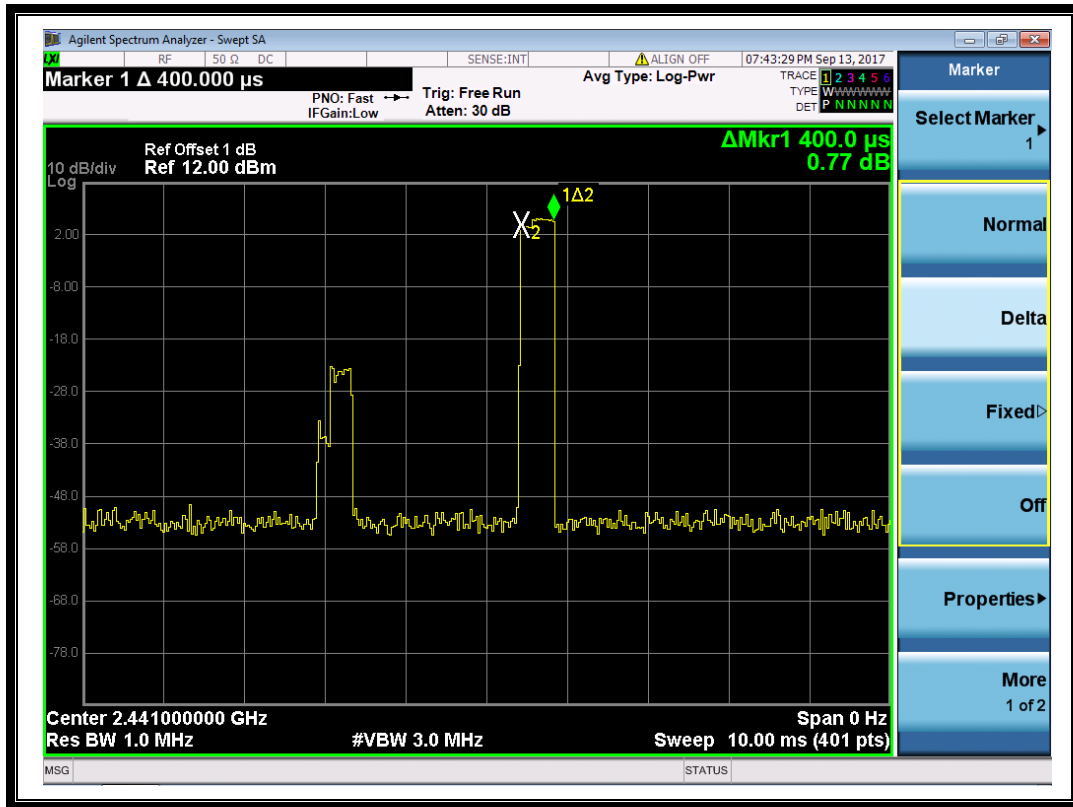

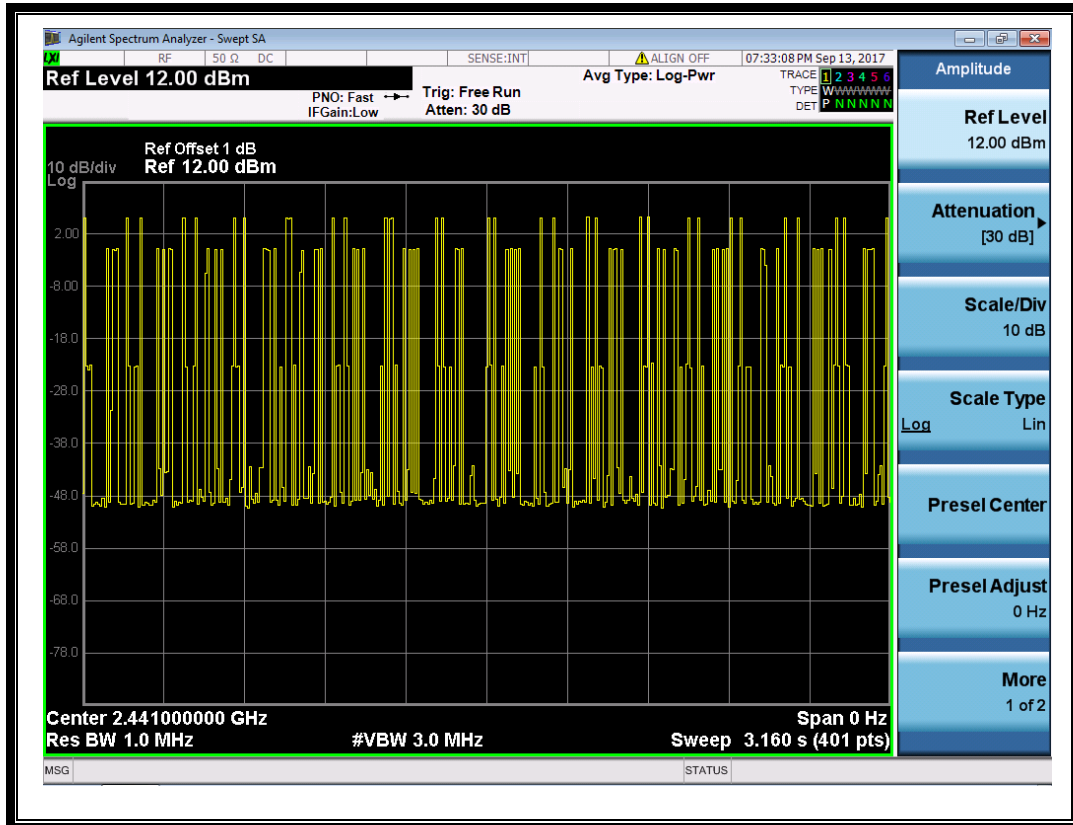

(Plot D: DH1 @  $\pi/4$ -DQPSK)

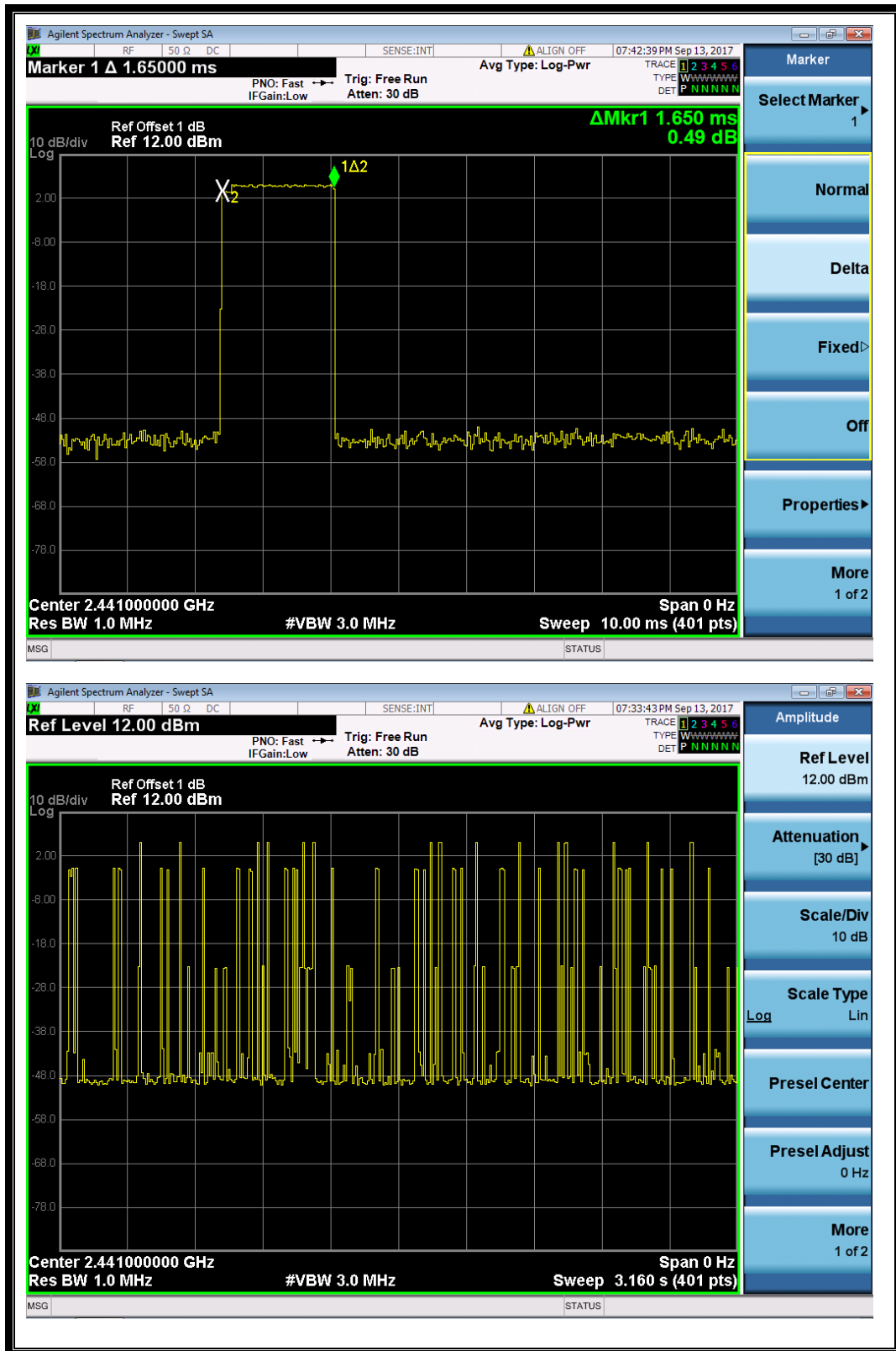

(Plot E: DH3 @  $\pi/4$ -DQPSK)

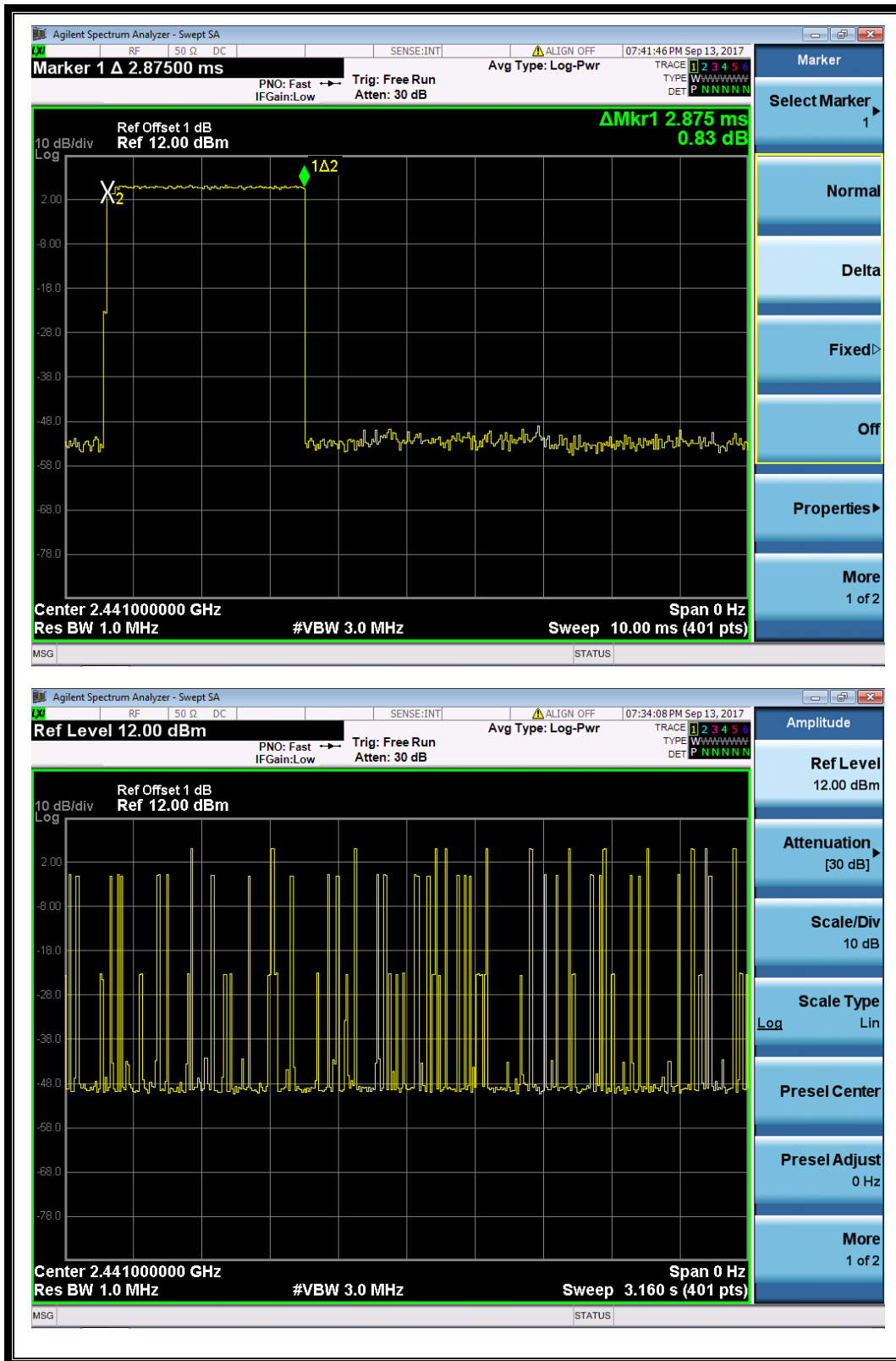

(Plot F: DH5 @  $\pi/4$ -DQPSK)



2.6.4.3 8-DPSK mode

A. Test Verdict:

DH Packet	Pulse Width (msec)	Number of pulse in 3.16 seconds	Average Time of Occupancy in 3.16 seconds (sec)	Average Time of Occupancy in 31.6 seconds (sec)	Limit (sec)	Verdict
DH1	0.38	31	0.01178	0.1178	0.4	PASS
DH3	1.65	15	0.02475	0.2475		PASS
DH5	2.90	12	0.03480	0.3480		PASS

B. Test Plots:

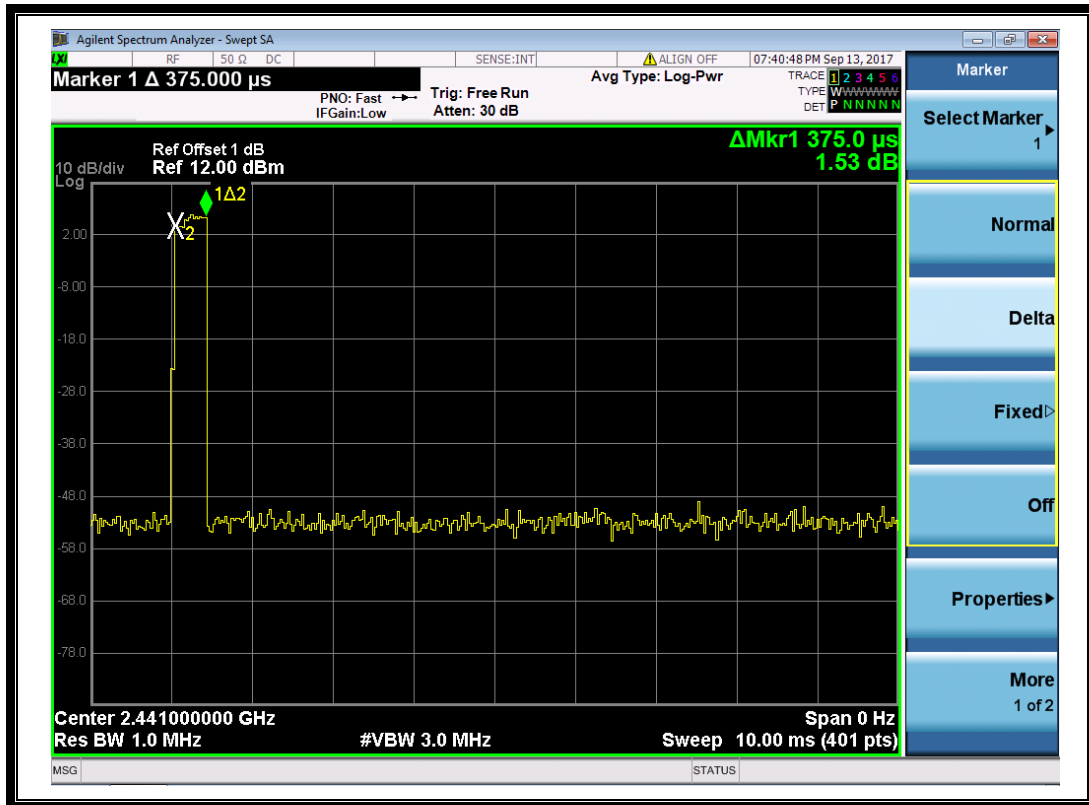



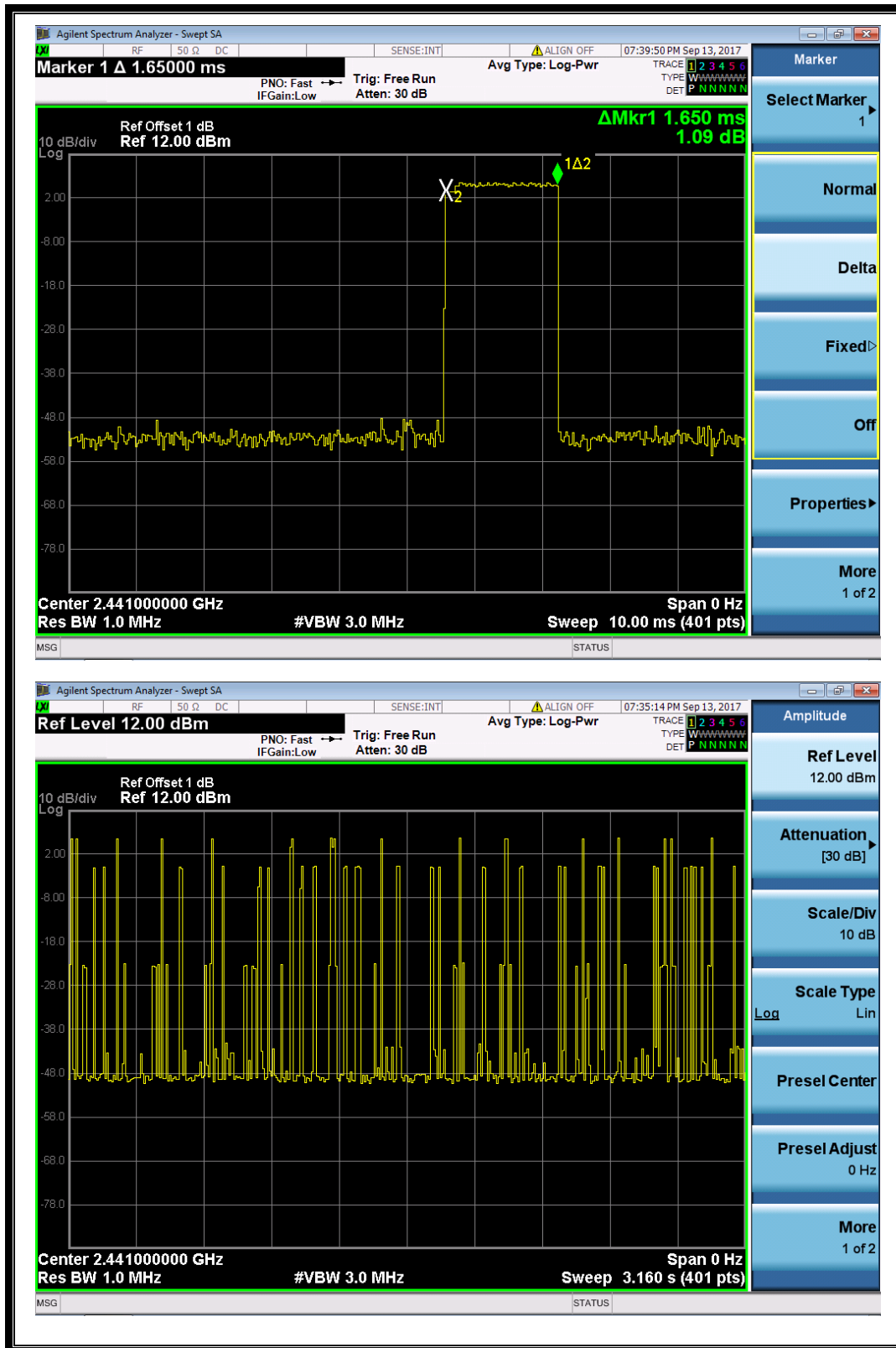

(Plot H: DH3 @ 8-DPSK)

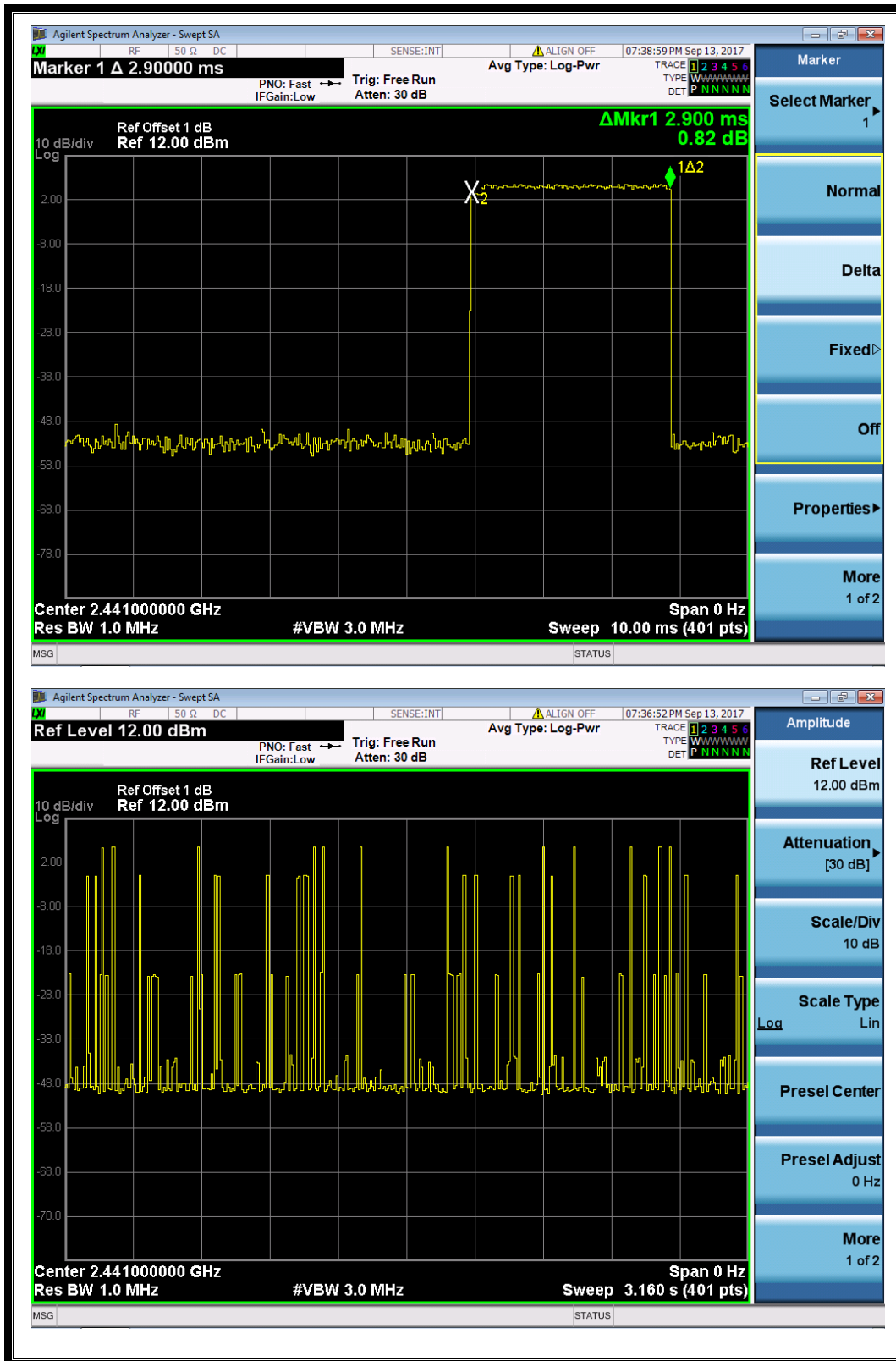

(Plot I: DH5 @ 8-DPSK)



## 2.7 Conducted Spurious Emissions

### 2.7.1 Requirement

According to FCC §15.247(d), in any 100kHz bandwidth outside the frequency band in which the spread spectrum or digitally modulated intentional radiator is operating, the radio frequency power that is produced by the intentional radiator shall be at least 20dB below that in the 100kHz bandwidth within the band that contains the highest level of the desired power, based on either an RF conducted or a radiated measurement.

### 2.7.2 Test Description

#### A. Test Setup:

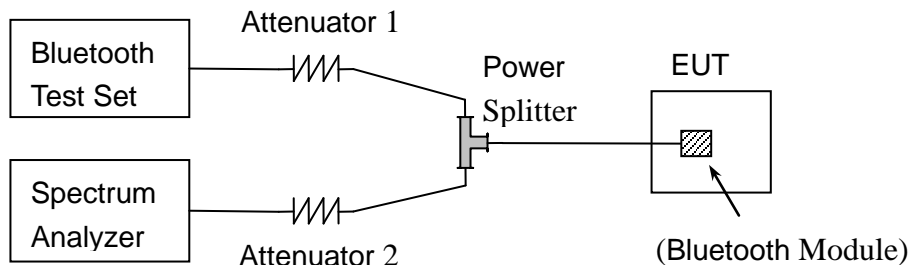

The Bluetooth Module of the EUT is coupled to the Spectrum Analyzer (SA) and the Bluetooth Test Set with Attenuators through the Power Splitter; the RF load attached to the EUT antenna terminal is 50Ohm; the path loss as the factor is calibrated to correct the reading. During the measurement, the Bluetooth Module of the EUT is activated and controlled by the SS, and is set to operate under test mode transmitting 339 bytes DH5 packages at maximum power.

#### B. Equipments List:

Please reference ANNEX A(1.5).

### 2.7.3 Test Procedure

Use the following spectrum analyzer settings:

Span = wide enough to capture the peak level of the in-band emission and all spurious emissions (e.g., harmonics) from the lowest frequency generated in the EUT up through the 10th harmonic. Typically, several plots are required to cover this entire span.

Typically, several plots are required to cover this entire span.

RBW = 100 kHz

VBW  $\geq$  RBW

Sweep = auto

Detector function = peak

Trace = max hold

Allow the trace to stabilize.



**2.7.4 Test Result**

The Bluetooth Module operates at hopping-off test mode. The measurement frequency range is from 30MHz to the 10th harmonic of the fundamental frequency. The lowest, middle and highest channels are tested to verify the spurious emissions.

**2.7.4.1 GFSK Mode**

**A. Test Verdict:**

Channel	Frequency (MHz)	Measured Max. Out of Band Emission (dBm)	Refer to Plot	Limit (dBm)		Verdict
				Carrier Level	Calculated -20dBc Limit	
0	2402	-50.74	Plot A	7.10	-12.90	PASS
39	2441	-49.46	Plot B	6.98	-13.02	PASS
78	2480	-47.83	Plot C	7.66	-12.34	PASS

**B. Test Plots:**

**Note:** the power of the Module transmitting frequency should be ignored.

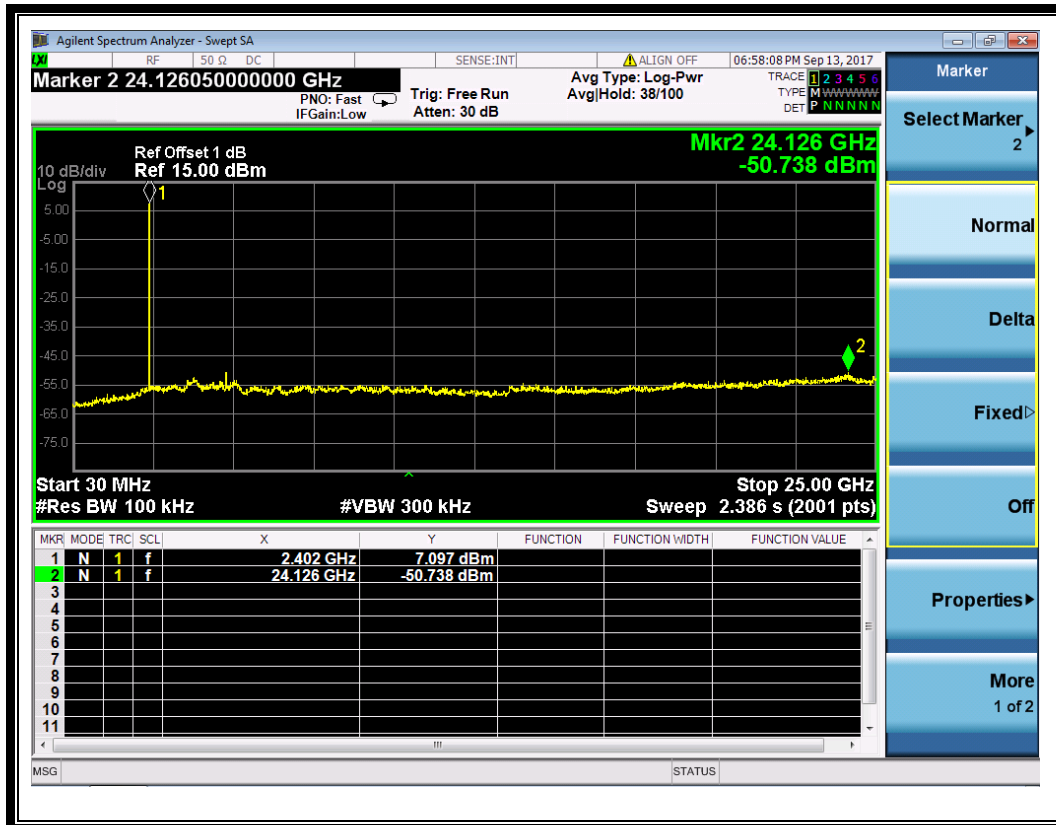

(Plot A: Channel = 0, 30MHz to 25GHz @ GFSK Mode)

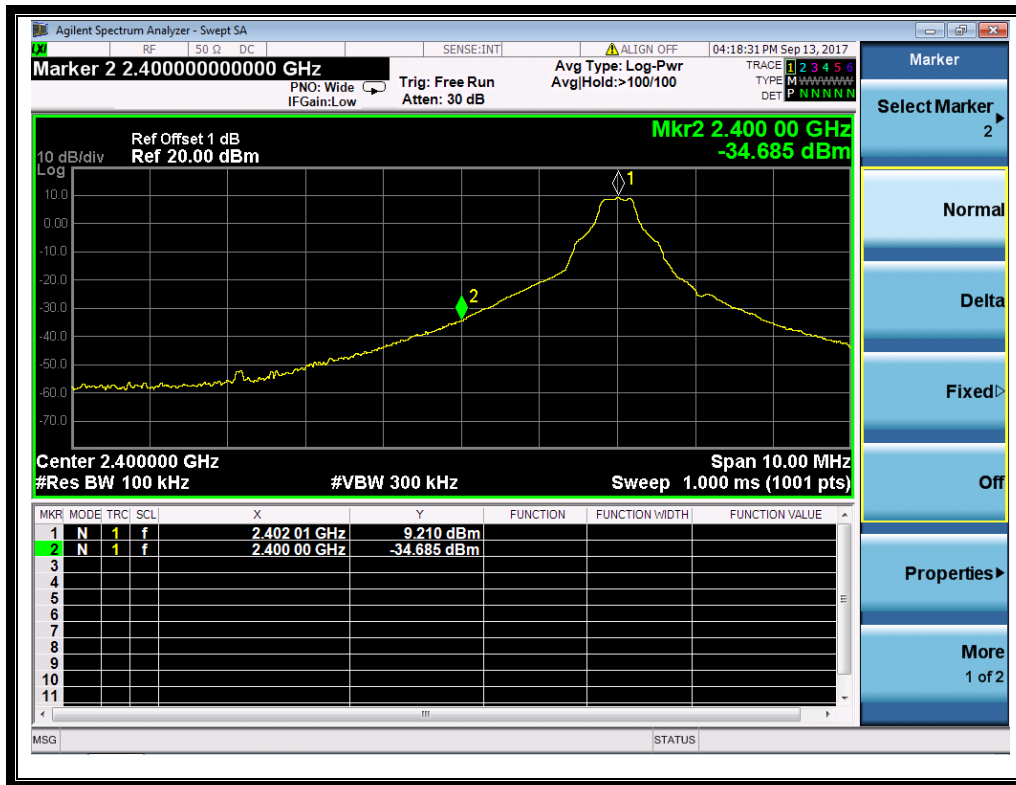

(Channel = 0, Band edge @ GFSK Mode)

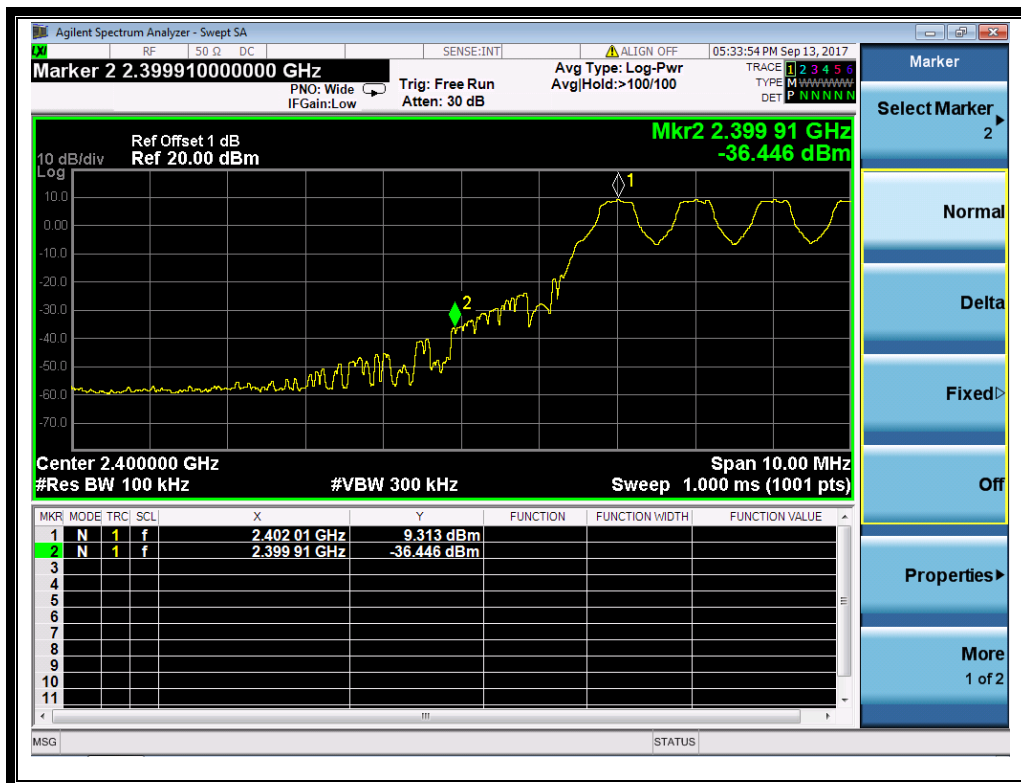

(Channel = 0, Band edge with hopping on @ GFSK Mode)

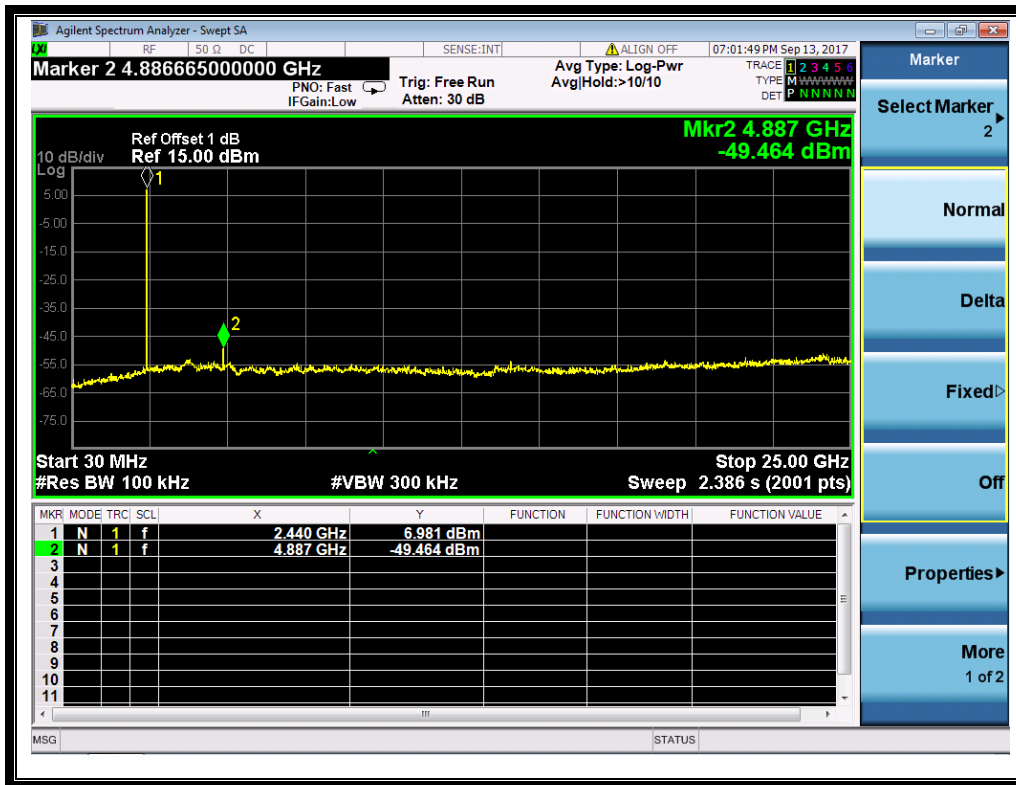

(Plot B: Channel = 39, 30MHz to 25GHz @ GFSK Mode)

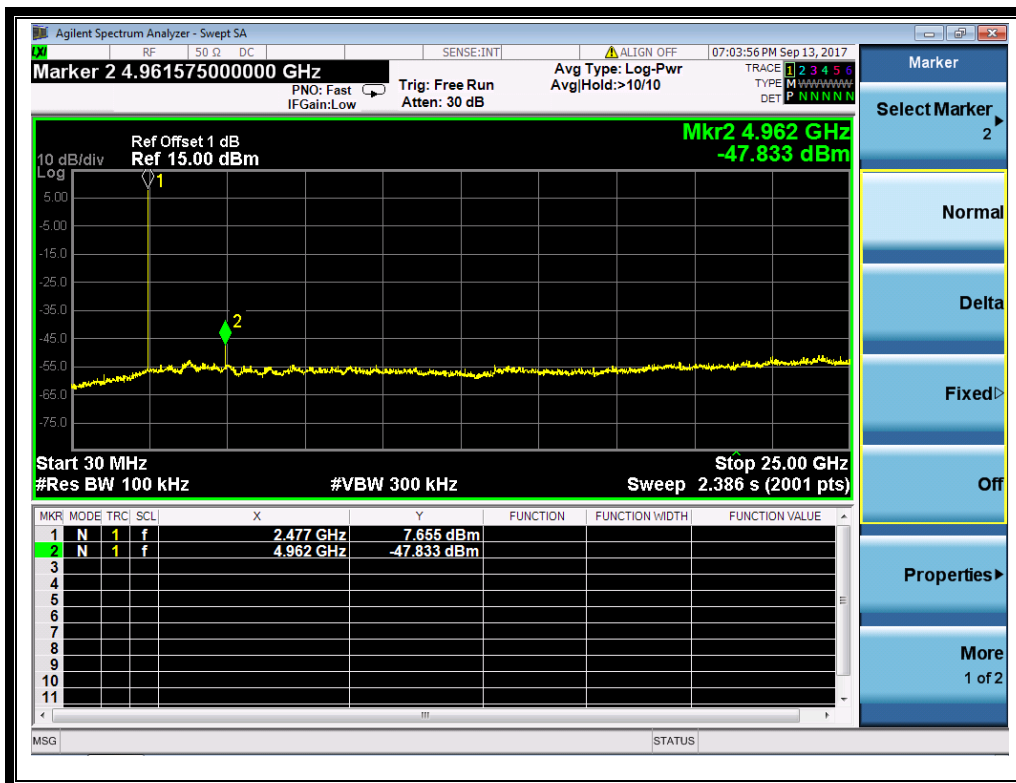

(Plot C: Channel = 78, 30MHz to 25GHz @ GFSK Mode)

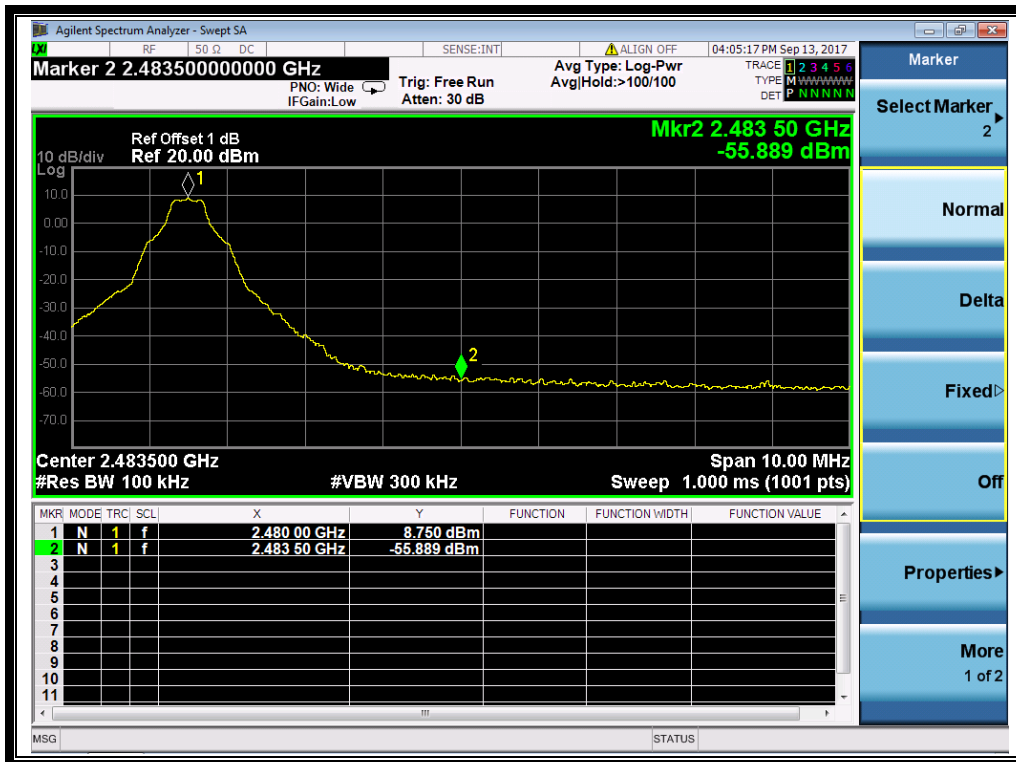

(Channel = 78, Band edge @ GFSK Mode)

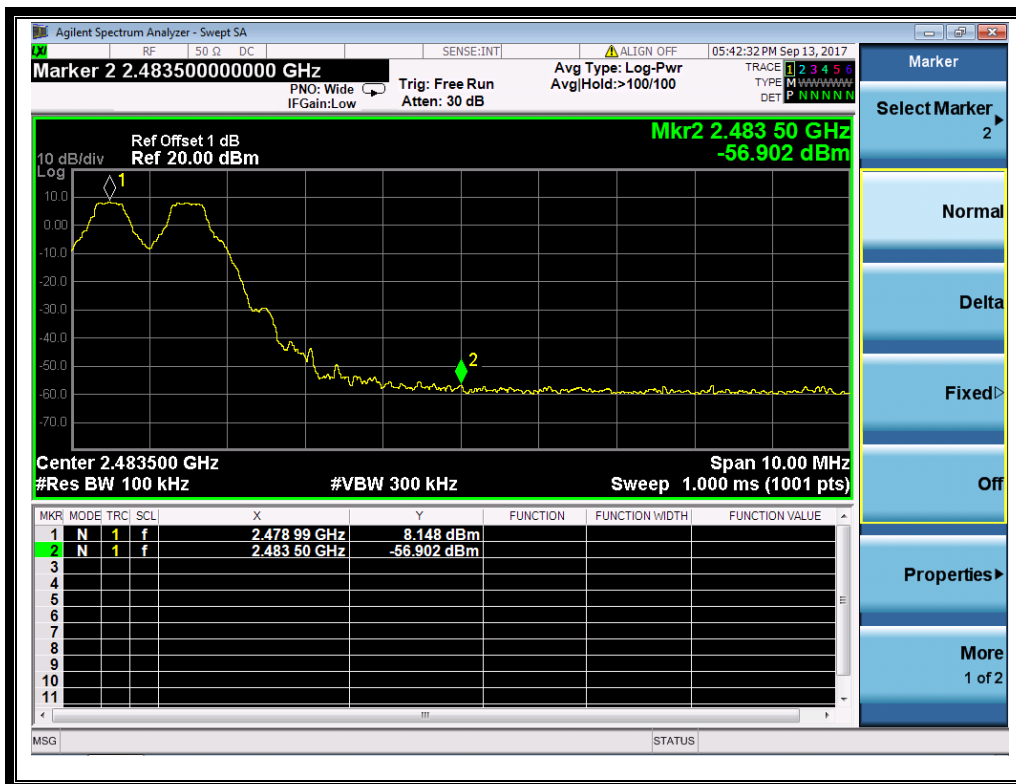

(Channel = 78, Band edge with hopping on @ GFSK Mode)

2.7.4.2  $\pi/4$ -DQPSK Mode

A. Test Verdict:

Channel	Frequency (MHz)	Measured Max. Out of Band Emission (dBm)	Refer to Plot	Limit (dBm)		Verdict
				Carrier Level	Calculated -20dBc Limit	
0	2402	-51.45	Plot D	1.50	-18.50	PASS
39	2441	-49.81	Plot E	0.44	-19.56	PASS
78	2480	-52.59	Plot F	1.18	-18.82	PASS

B. Test Plots:

Note: the power of the Module transmitting frequency should be ignored.

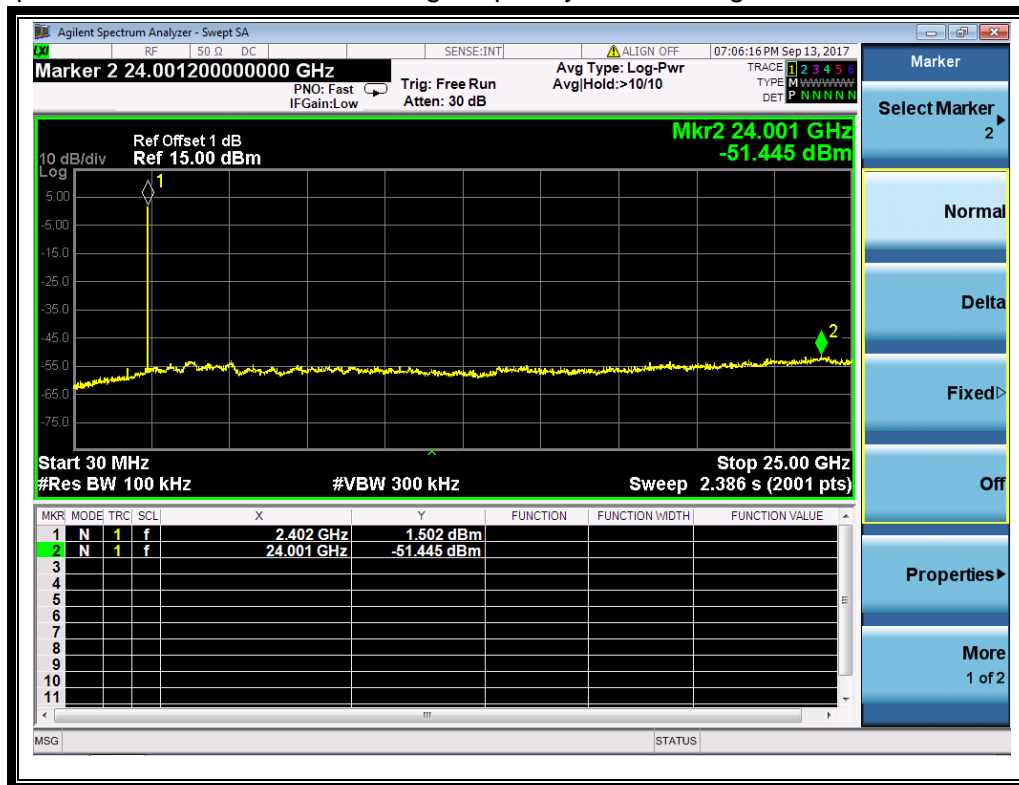

(Plot D: Channel = 0, 30MHz to 25GHz @ $\pi/4$ -DQPSK)

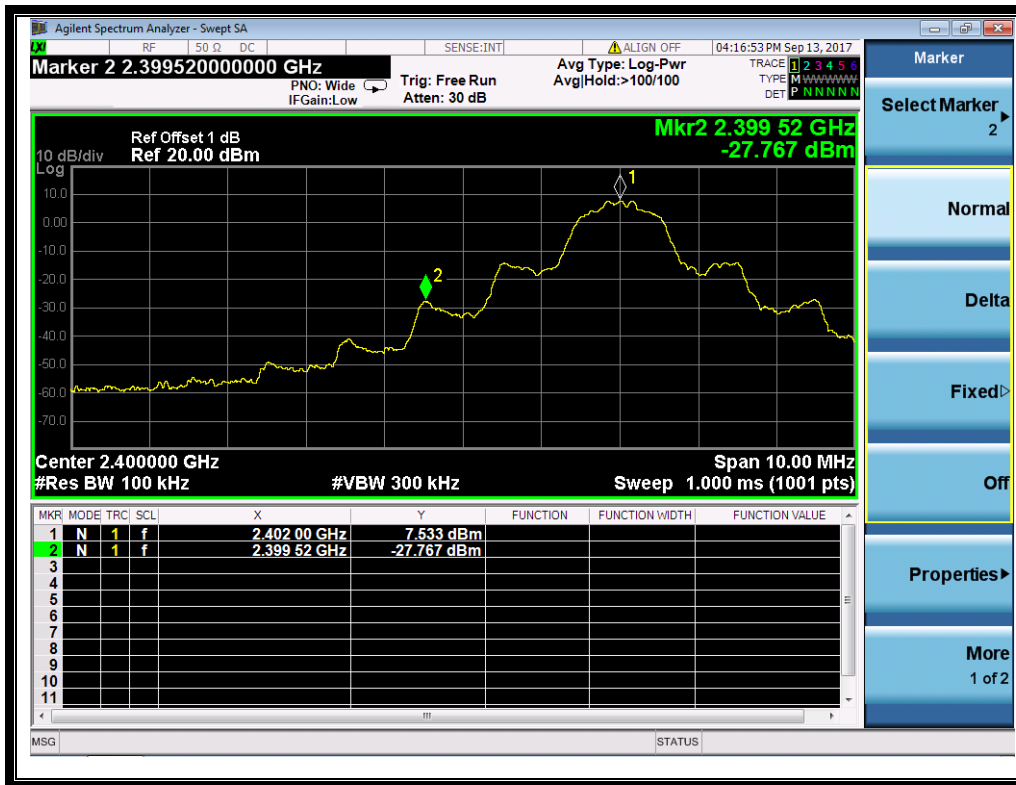

(Channel = 0, Band edge @ $\pi/4$ -DQPSK)

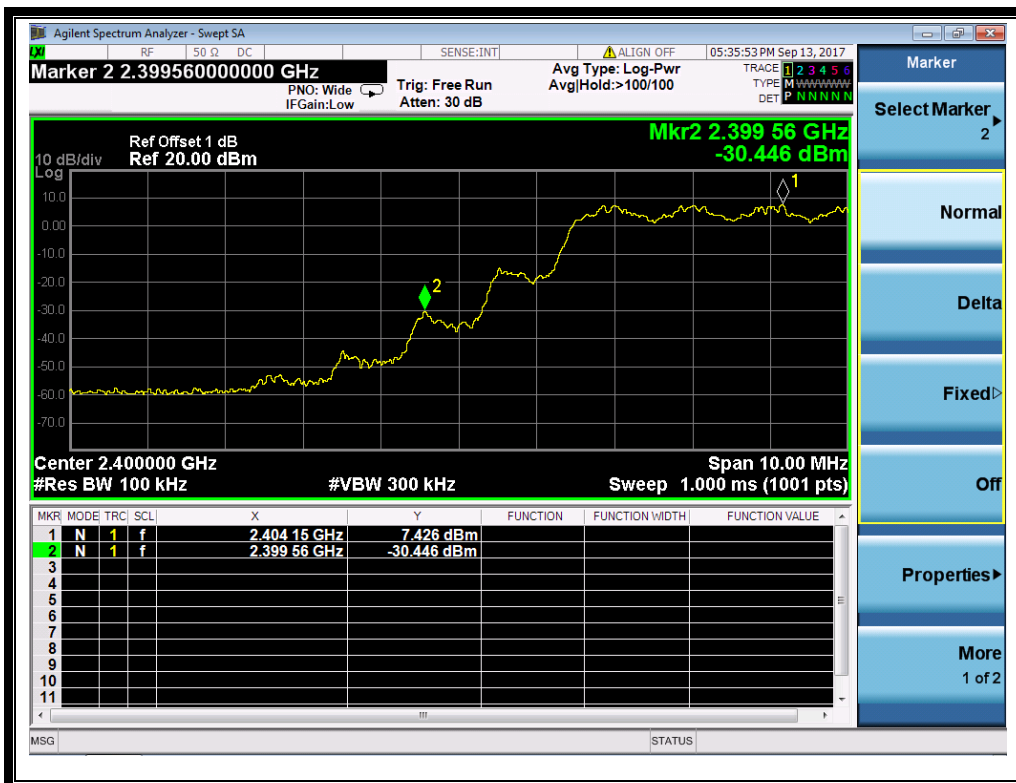

(Channel = 0, Band edge with hopping on @ $\pi/4$ -DQPSK)



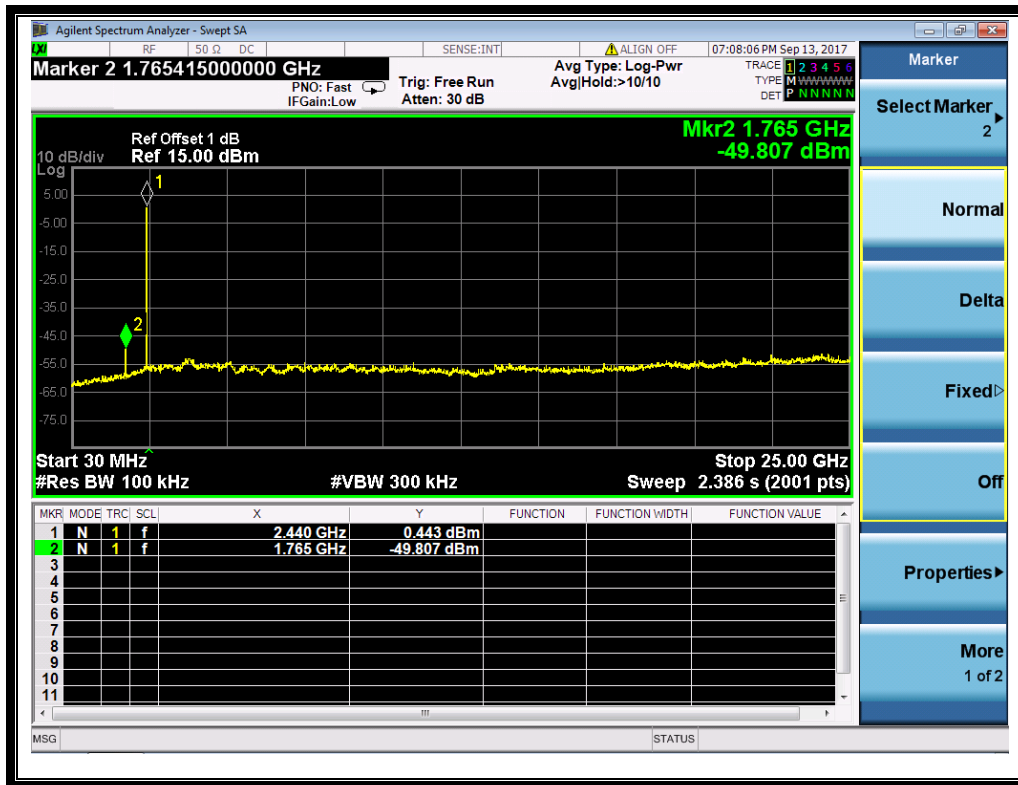

(Plot E: Channel = 39, 30MHz to 25GHz @  $\pi/4$ -DQPSK)

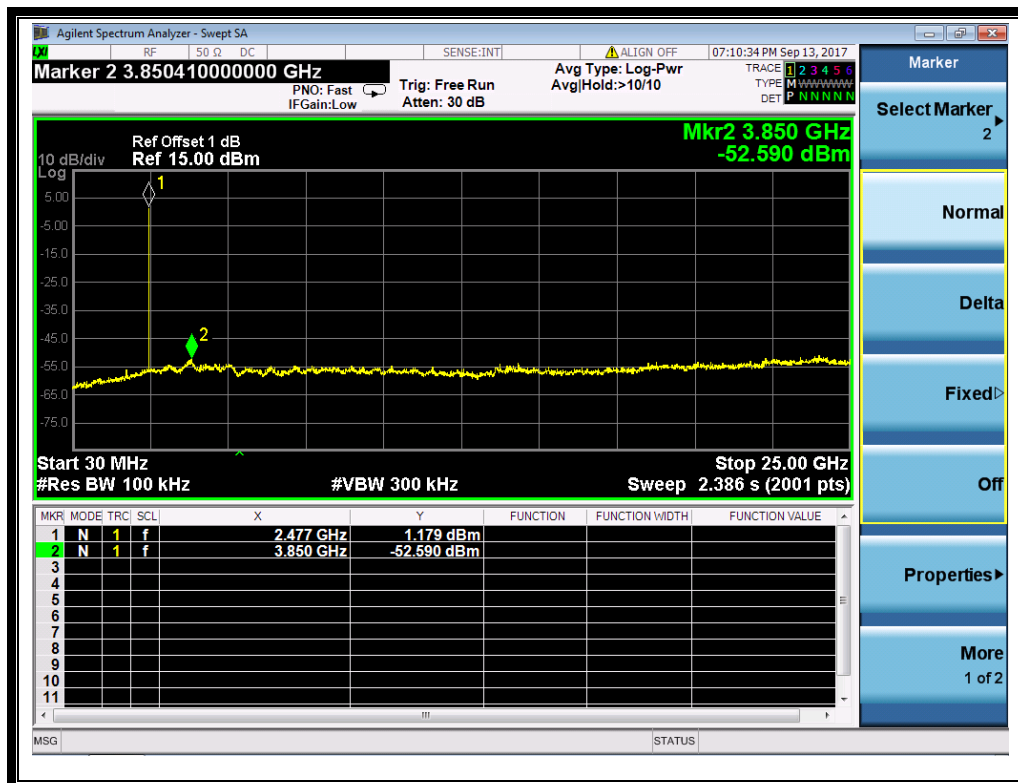

(Plot F: Channel = 78, 30MHz to 25GHz @  $\pi/4$ -DQPSK)



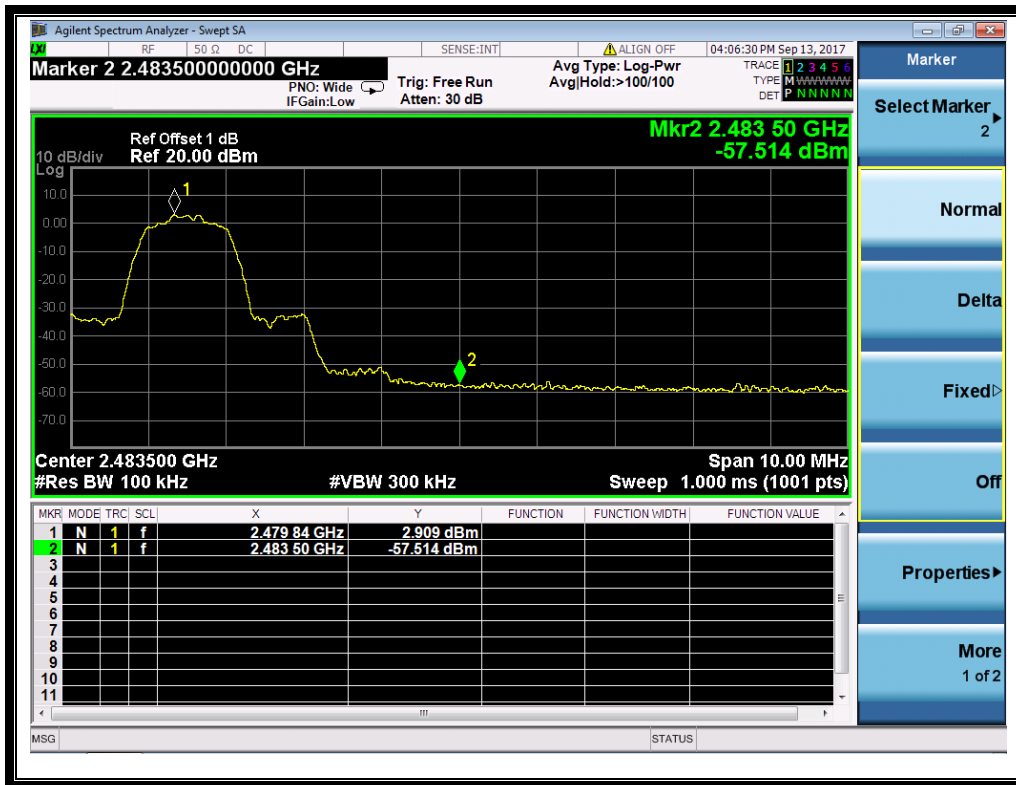

(Channel = 78, Band edge @  $\pi/4$ -DQPSK)

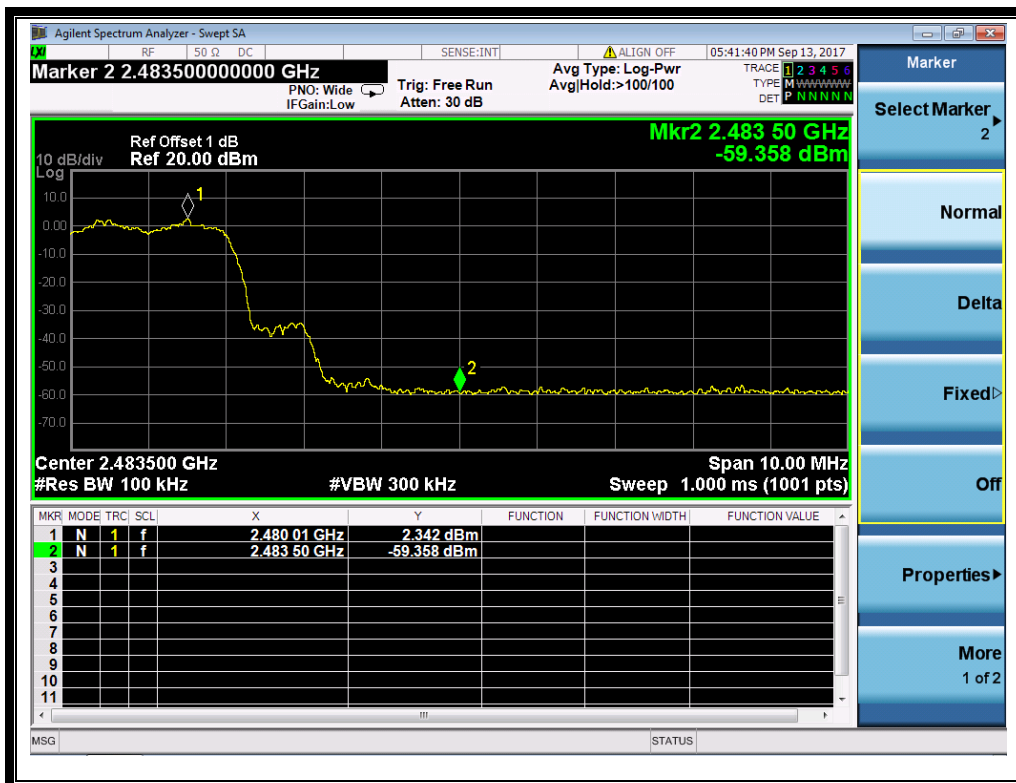

(Channel = 78, Band edge with hopping on @  $\pi/4$ -DQPSK)



2.7.4.3 8-DPSK Mode

A. Test Verdict:

Channel	Frequency (MHz)	Measured Max. Out of Band Emission (dBm)	Refer to Plot	Limit (dBm)		Verdict
				Carrier Level	Calculated -20dBc Limit	
0	2402	-48.11	Plot G	1.66	-18.34	PASS
39	2441	-51.34	Plot H	0.78	-19.22	PASS
78	2480	-50.44	Plot I	2.17	-17.83	PASS

B. Test Plots:

Note: the power of the Module transmitting frequency should be ignored.

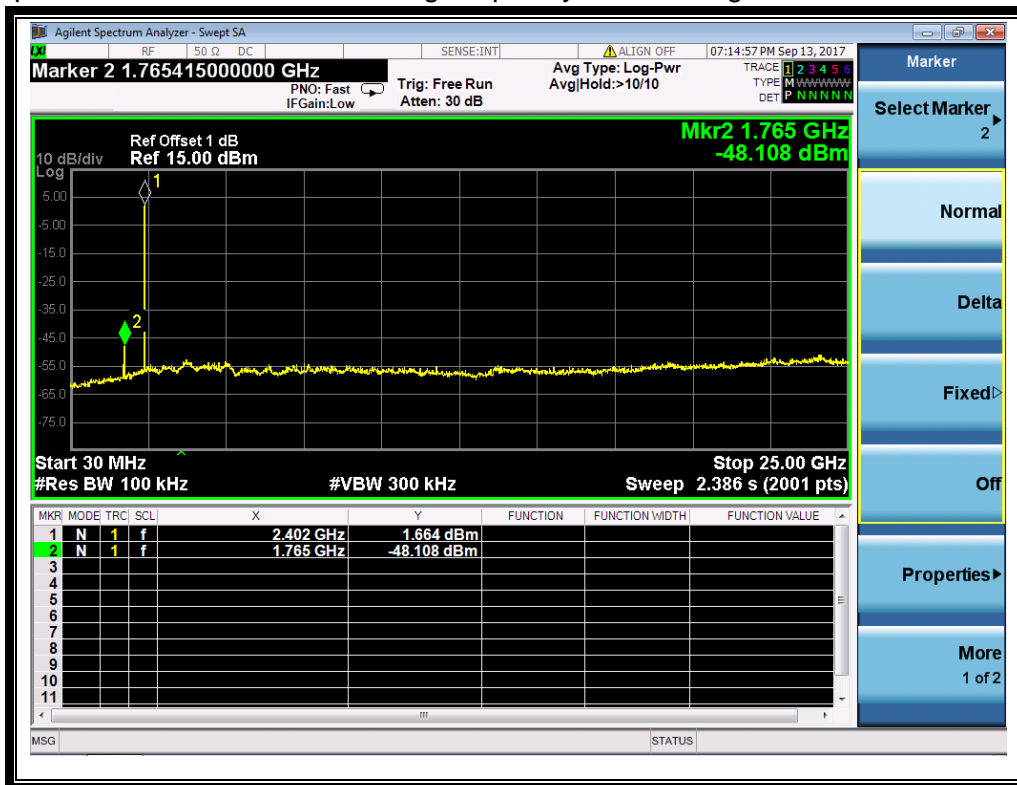

(Plot G: Channel = 0, 30MHz to 25GHz @ 8-DPSK)

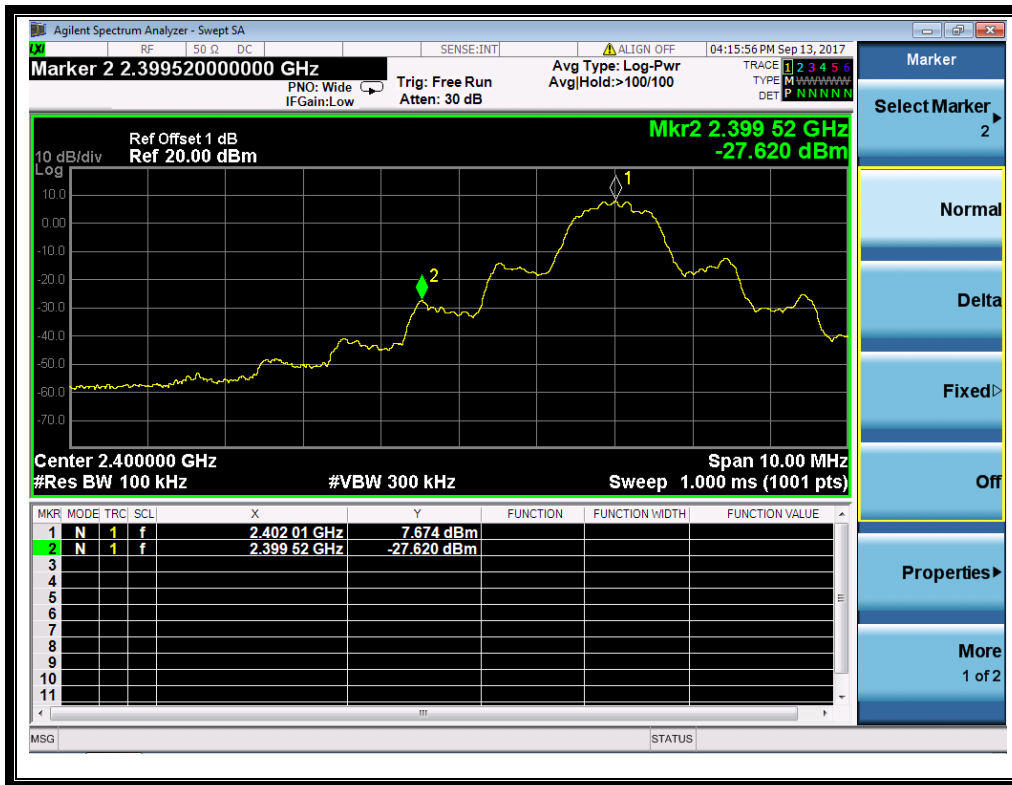

(Channel = 0, Band edge @ 8-DPSK)

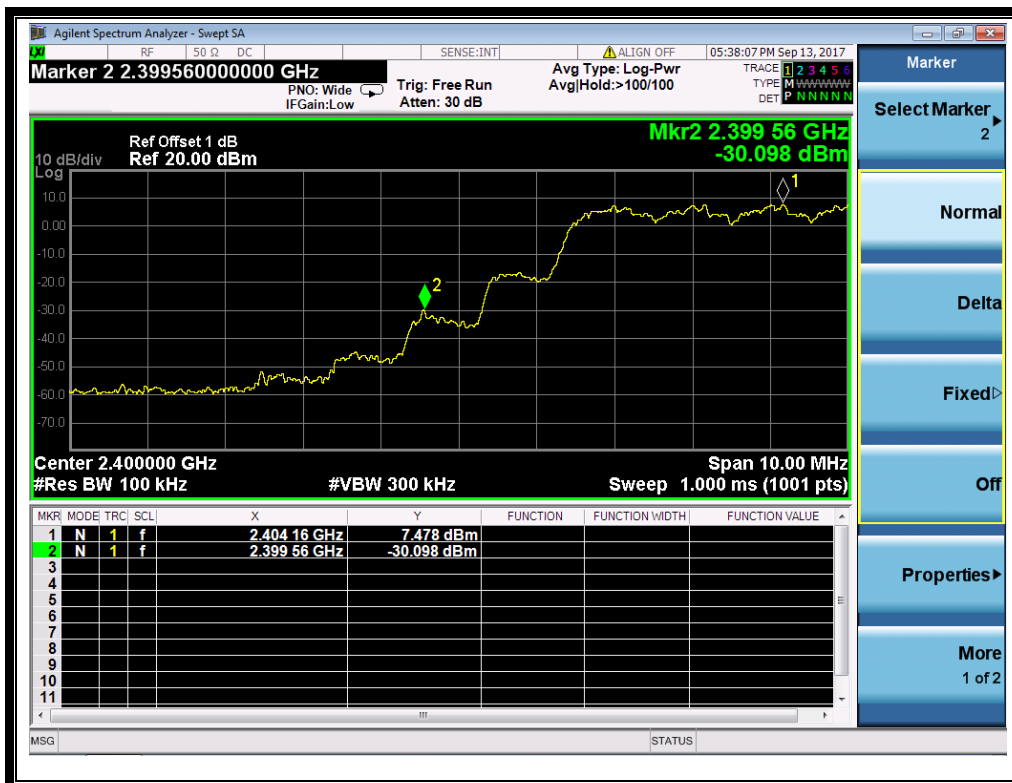

(Channel = 0, Band edge with hopping on @ 8-DPSK)

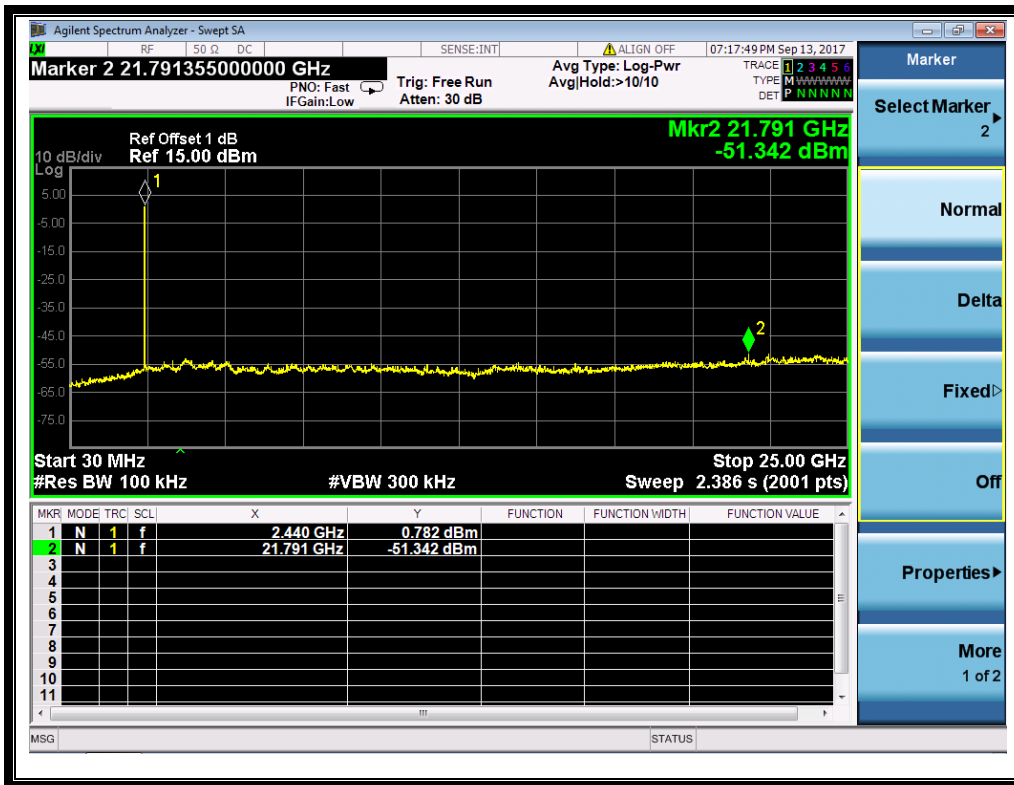

(Plot H: Channel = 39, 30MHz to 25GHz @ 8-DPSK)

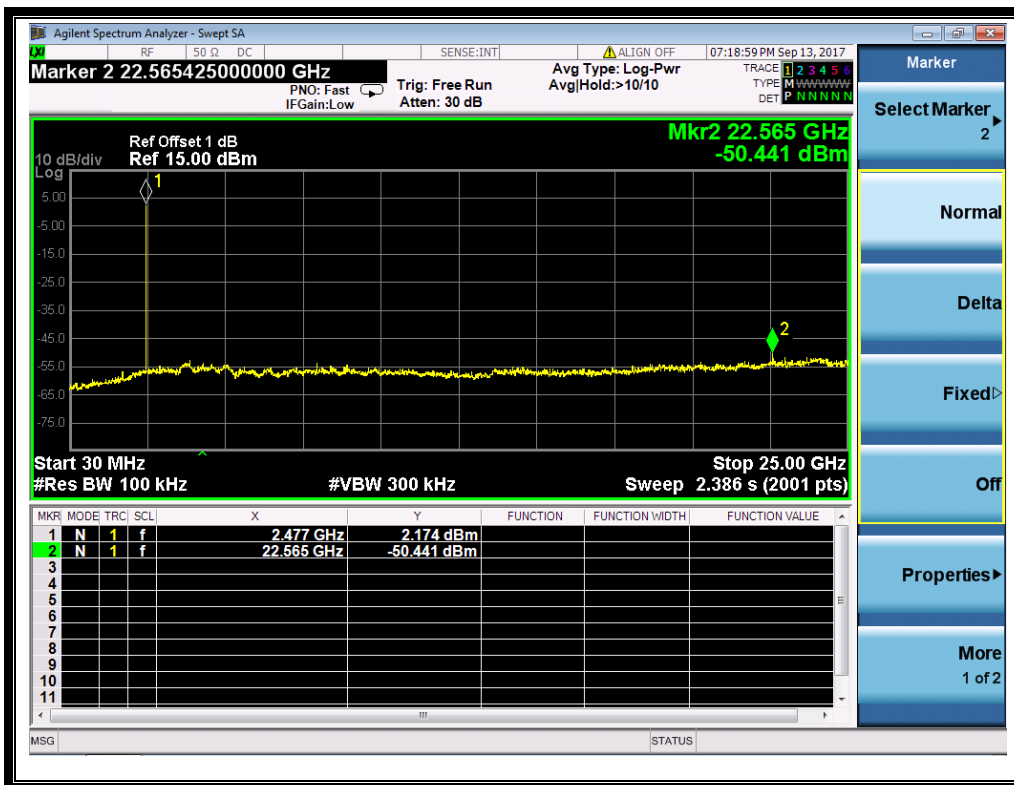

(Plot I: Channel = 78, 30MHz to 25GHz @ 8-DPSK)

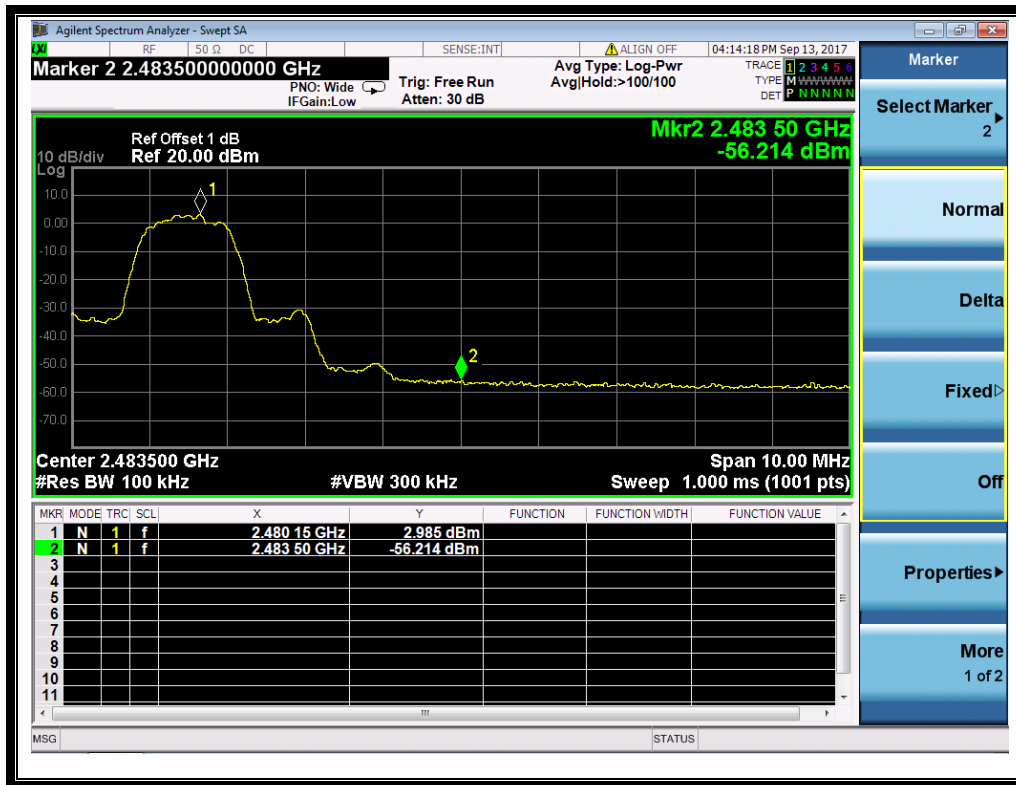

(Plot I.1:Channel = 78, Band edge @ 8-DPSK)

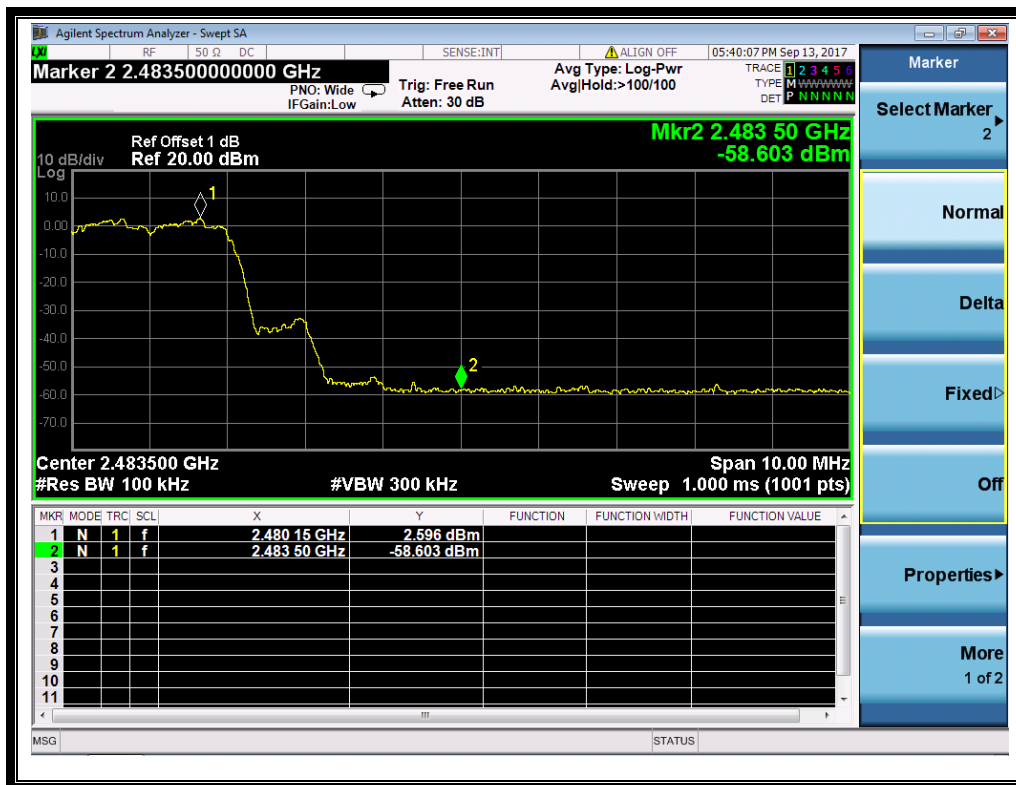

(Plot I.1:Channel = 78, Band edge with hopping on @ 8-DPSK)

## 2.8 Restricted Frequency Bands

### 2.8.1 Requirement

According to FCC section 15.247(d), in any 100kHz bandwidth outside the frequency band in which the spread spectrum or digitally modulated intentional radiator is operating, the radio frequency power that is produced by the intentional radiator shall be at least 20dB below that in the 100kHz bandwidth within the band that contains the highest level of the desired power, In addition, radiated emissions which fall in the restricted bands, as defined in 15.205(a), must also comply with the radiated emission limits specified in 15.209(a).

### 2.8.2 Test Description

#### A. Test Setup:

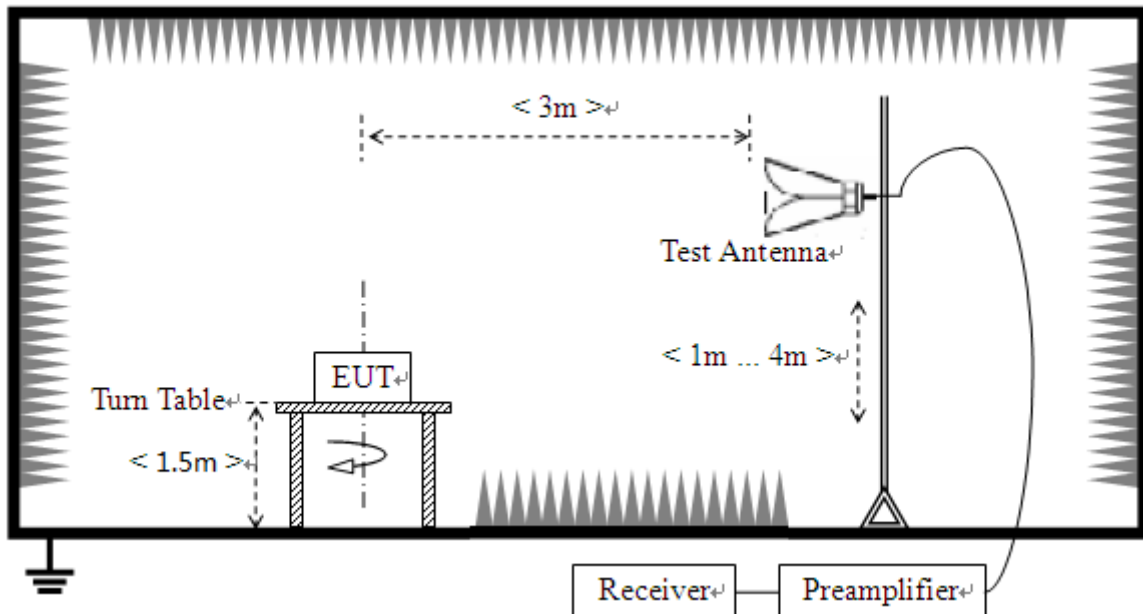

The EUT is located in a 3m Semi-Anechoic Chamber; the antenna factors, cable loss and so on of the site as factors are calculated to correct the reading. During the measurement, the Bluetooth Module of the EUT is activated and controlled by the Bluetooth Service Supplier (SS) via a Common Antenna, and is set to operate under non hopping-on test mode transmitting 339 bytes DH5, 679 bytes 2DH5 and 1021 bytes 3DH5 packages at maximum power.

For the Test Antenna:

Horn Test Antenna is 3m away from the EUT. Test Antenna height is varied from 1m to 4m above the ground to determine the maximum value of the field strength.

**B. Equipments List:**

Please reference ANNEX A(1.5).

**2.8.3 Test Procedure**

Span = wide enough to fully capture the emission being measured

RBW = 1 MHz for  $f \geq 1\text{GHz}$ , 100 KHz for  $f < 1\text{GHz}$

VBW = 3 MHz for peak and 10Hz for average

Sweep = auto

Detector function = peak

Trace = max hold

Allow the trace to stabilize.

**2.8.4 Test Result**

The lowest and highest channels are tested to verify Restricted Frequency Bands.

The measurement results are obtained as below:

$$E \text{ [dB}\mu\text{V/m]} = U_R + A_T + A_{\text{Factor}} \text{ [dB]}; A_T = L_{\text{Cable loss}} \text{ [dB]} - G_{\text{preamp}} \text{ [dB]}$$

AT: Total correction Factor except Antenna

UR: Receiver Reading

Gpreamp: Preamplifier Gain

AFactor: Antenna Factor at 3m

**Note:** Restricted Frequency Bands were performed when antenna was at vertical and horizontal polarity, and only the worse test condition (vertical) was recorded in this test report.

**2.8.4.1 GFSK Mode****A. Test Verdict:**

Channel	Frequency (MHz)	Detector	Receiver Reading	$A_T$ (dB)	$A_{\text{Factor}}$ (dB@3m)	Max. Emission E (dB $\mu$ V/m)	Limit (dB $\mu$ V/m)	Verdict
		PK/ AV	$U_R$ (dB $\mu$ V)					
0	2381.95	PK	45.03	-33.63	32.56	43.96	74	Pass
0	2381.95	AV	32.90	-33.63	32.56	31.83	54	Pass
78	2489.00	PK	45.15	-33.18	32.50	44.47	74	Pass
78	2489.00	AV	32.77	-33.18	32.50	32.09	54	Pass





B. Test Plots:

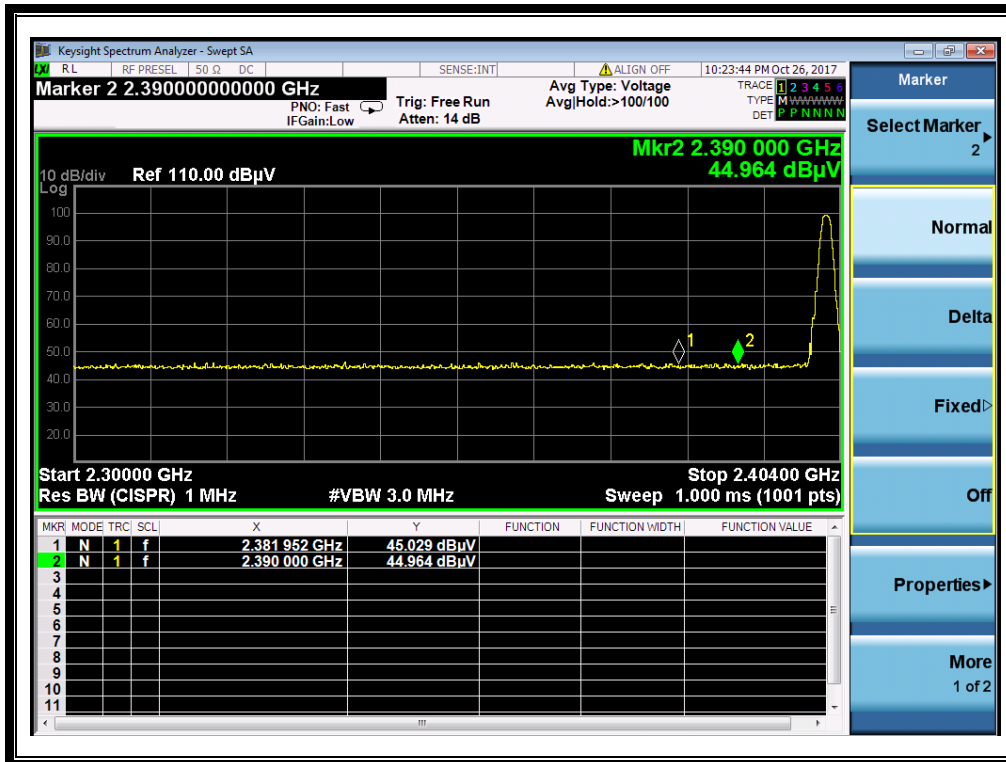

(Plot A1:Channel = 0 PEAK @ GFSK)

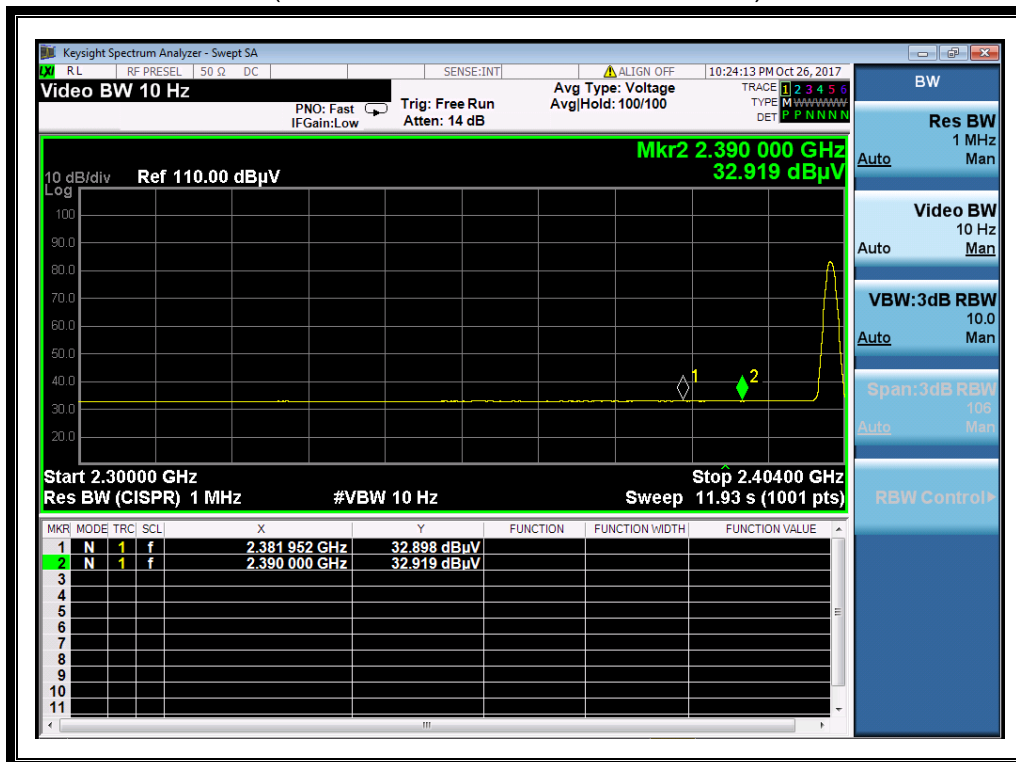

(Plot A2:Channel = 0 AVERAGE @ GFSK)



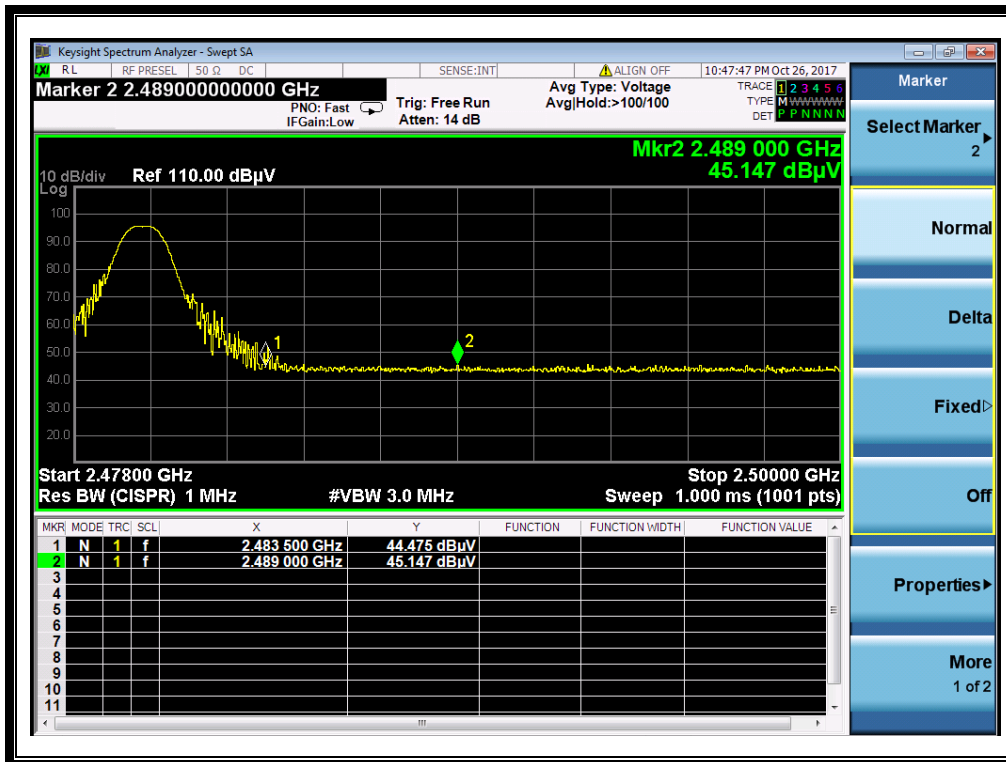

(Plot B1: Channel = 78 PEAK @ GFSK)

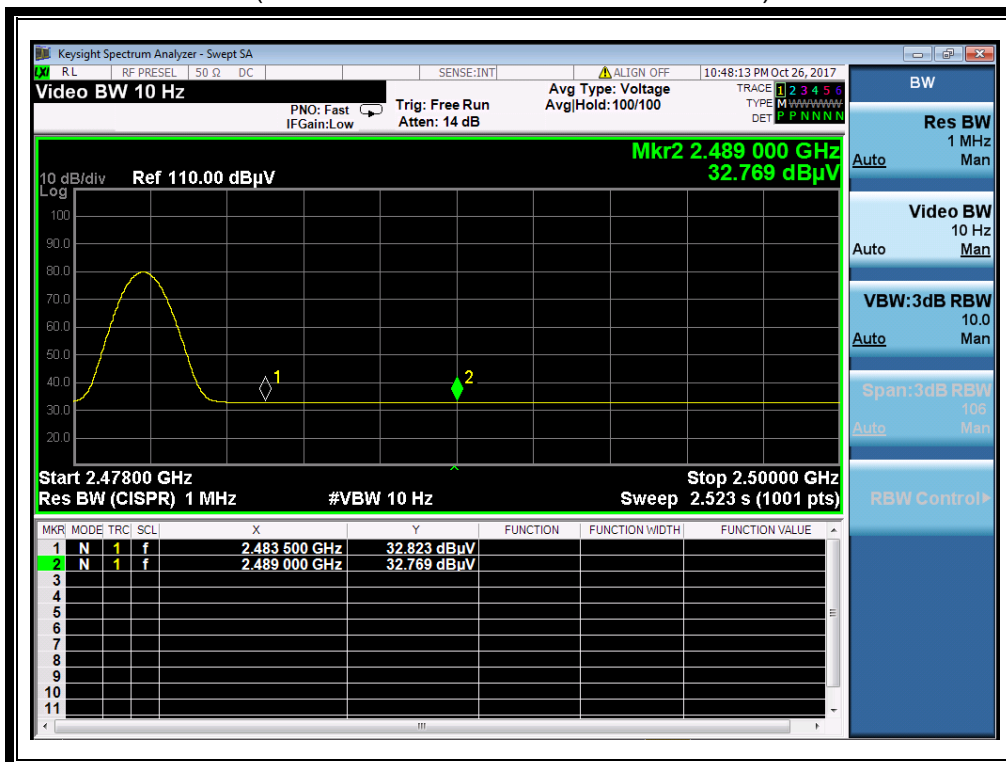

(Plot B2: Channel = 78 AVERAGE @ GFSK)



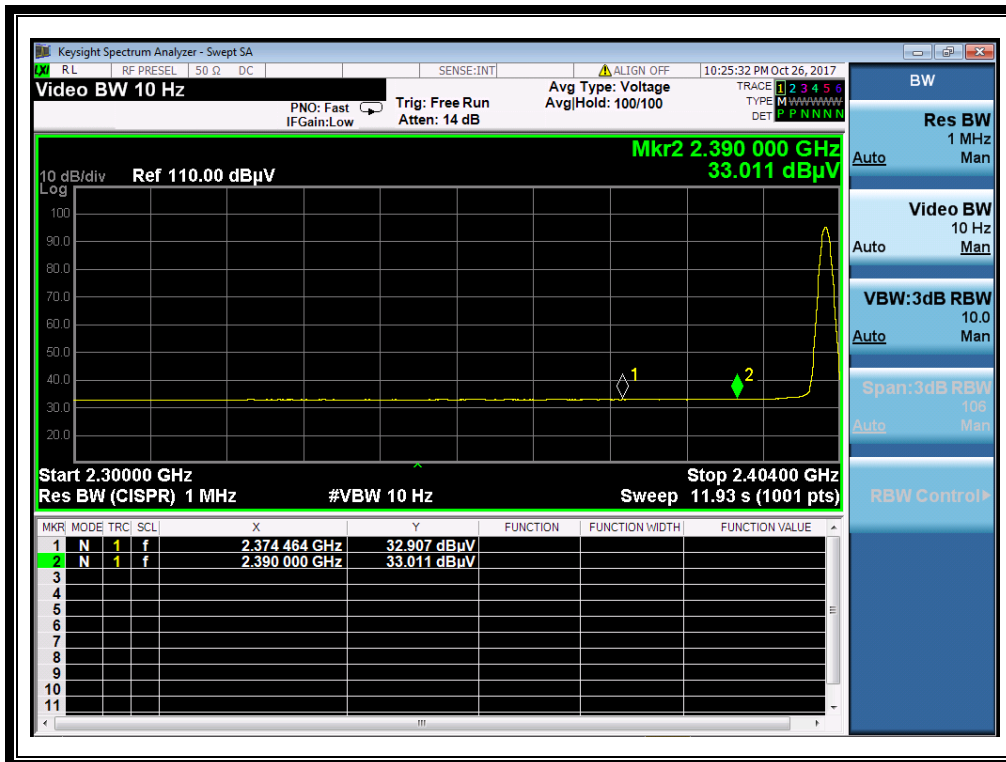

(Plot C2: Channel = 0 AVERAGE @  $\pi/4$ -DQPSK)

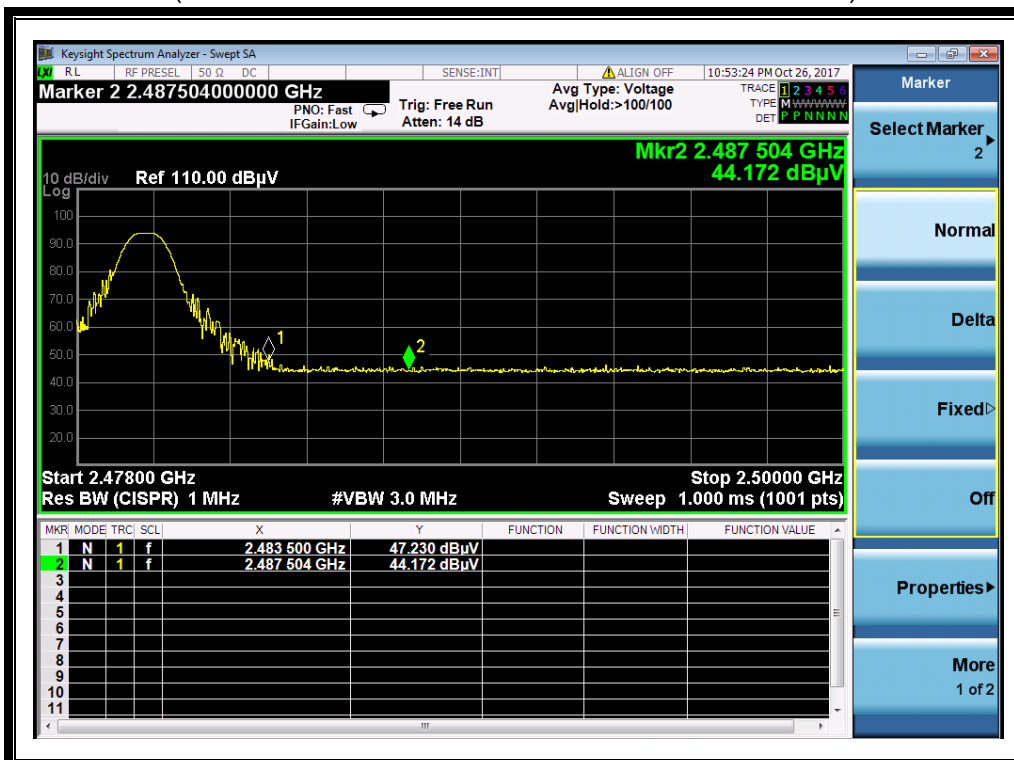

(Plot D1: Channel = 78 PEAK @  $\pi/4$ -DQPSK)

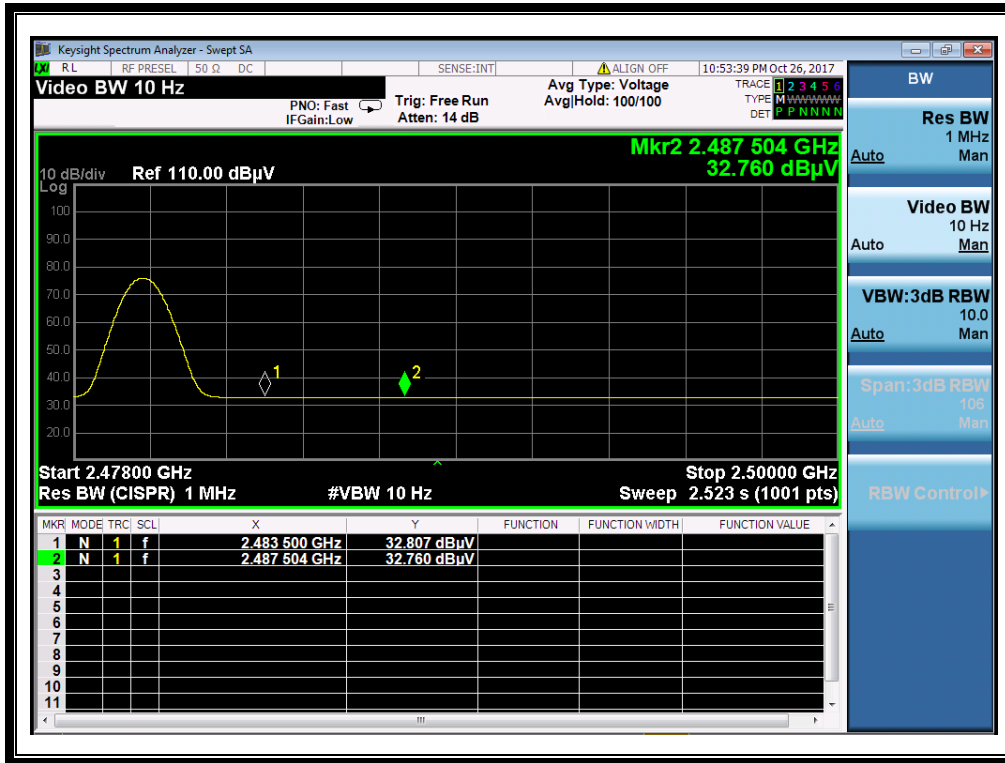

(Plot D2: Channel = 78 AVERAGE @  $\pi/4$ -DQPSK)

### 2.8.4.3 8-DPSK Mode

#### A. Test Verdict:

Channel	Frequency (MHz)	Detector	Receiver Reading $U_R$ (dBuV)	$A_T$ (dB)	$A_{Factor}$ (dB@3m)	Max. Emission E (dBμV/m)	Limit (dBμV/m)	Verdict
		PK/ AV						
0	2380.29	PK	42.69	-33.63	32.56	41.62	74	Pass
0	2380.29	AV	32.94	-33.63	32.56	31.87	54	Pass
78	2485.59	PK	43.40	-33.18	32.5	42.72	74	Pass
78	2485.59	AV	32.99	-33.18	32.5	32.31	54	Pass



B. Test Plots:

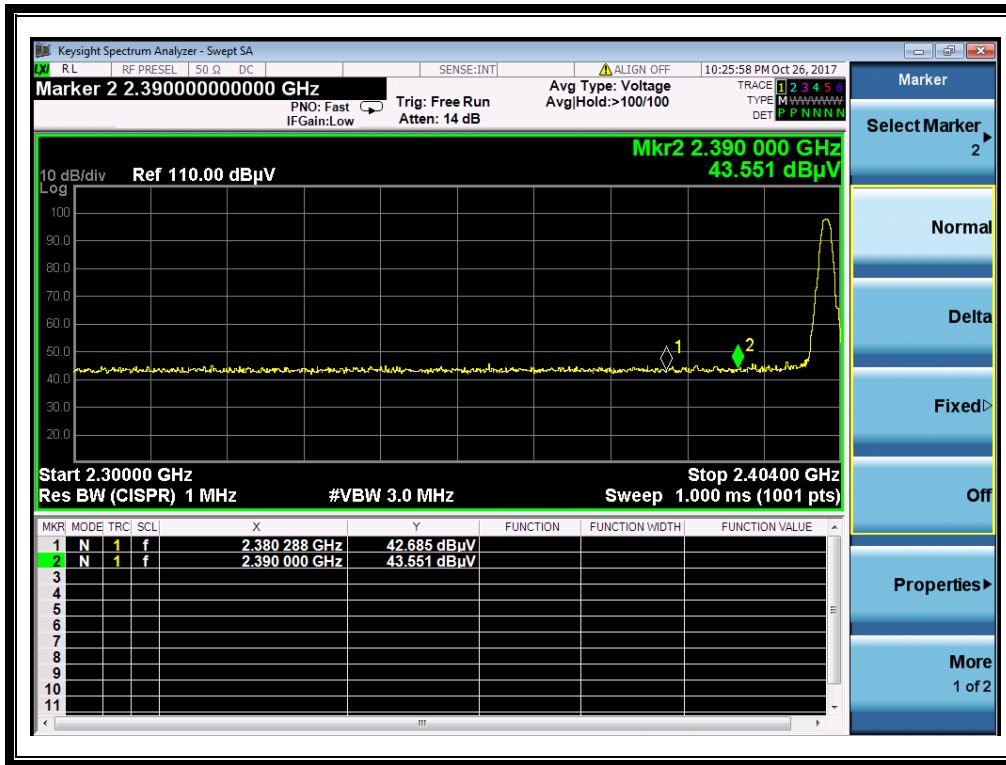

(Plot E1: Channel = 0 PEAK @ 8-DPSK Mode)

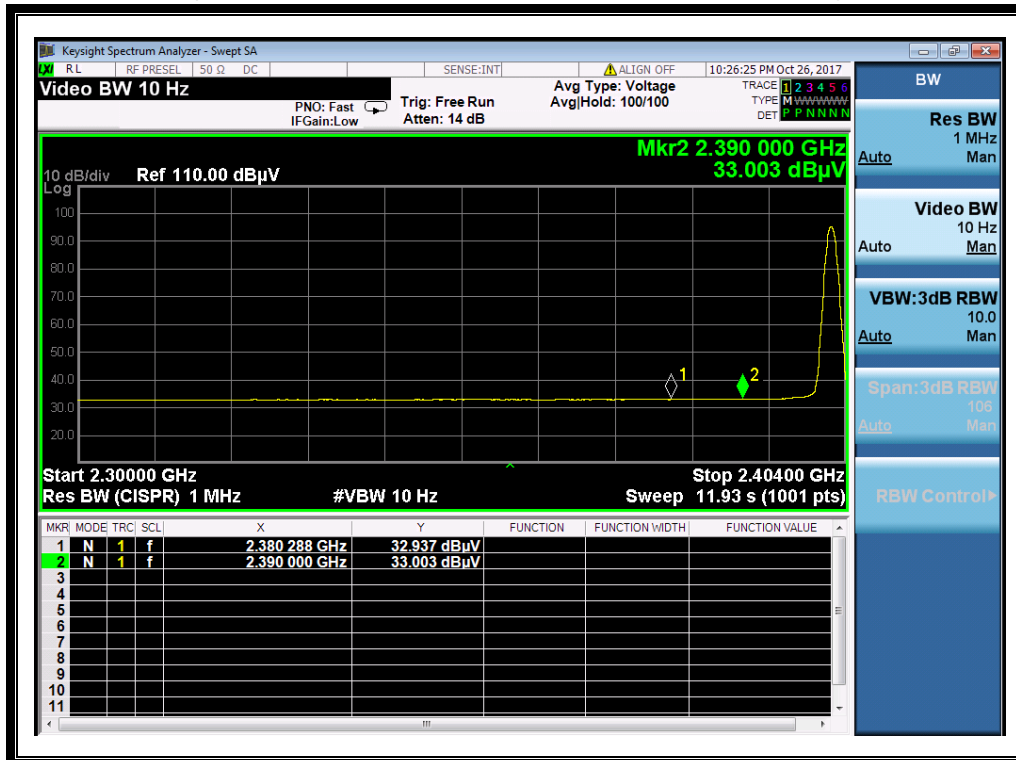

(Plot E2: Channel = 0 AVERAGE @ 8-DPSK Mode)

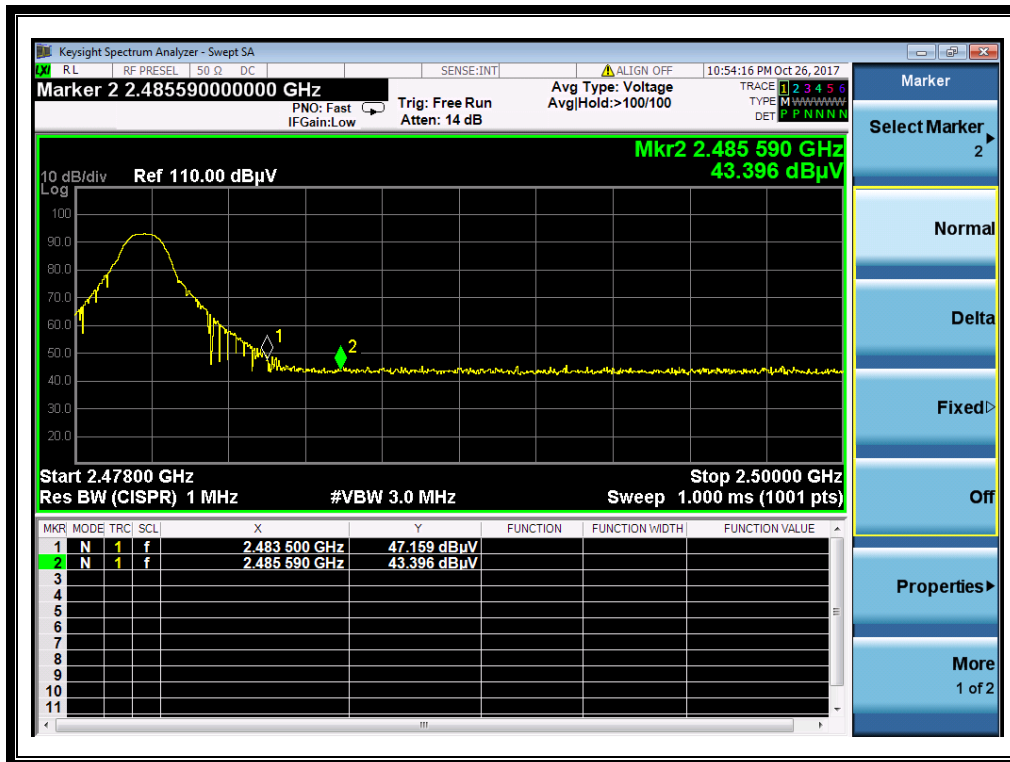

(Plot F1:Channel = 78 PEAK @ 8-DPSK Mode)

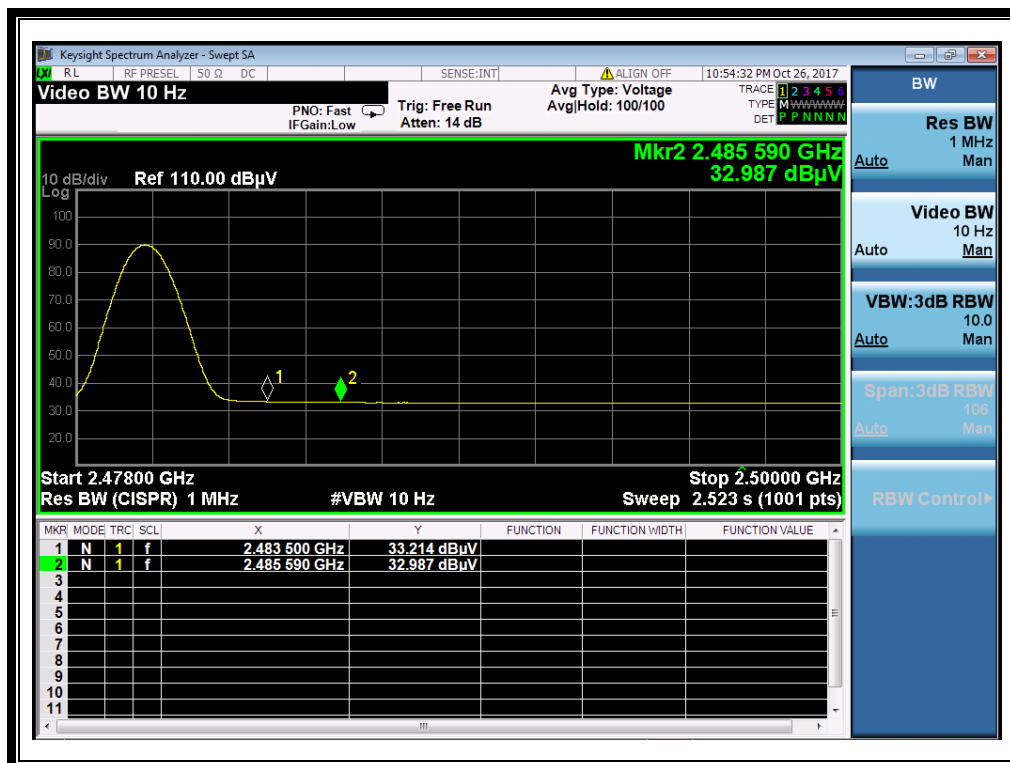

(Plot F2:Channel = 78 AVERAGE @ 8-DPSK Mode)

## 2.9 Conducted Emission

### 2.9.1 Requirement

According to RSS-GEN section 8.8, for an intentional radiator that is designed to be connected to the public utility (AC) power line, the radio frequency voltage that is conducted back onto the AC power line on any frequency within the band 150kHz to 30MHz shall not exceed the limits in the following table, as measured using a 50μH/50Ω line impedance stabilization network (LISN).

Frequency range (MHz)	Conducted Limit (dBμV)	
	Quai-peak	Average
0.15 - 0.50	66 to 56	56 to 46
0.50 - 5	56	46
5- 30	60	50

**NOTE:**

- (a) The lower limit shall apply at the band edges.
- (b) The limit decreases linearly with the logarithm of the frequency in the range 0.15 - 0.50MHz.

### 2.9.2 Test Description

#### A. Test Setup:

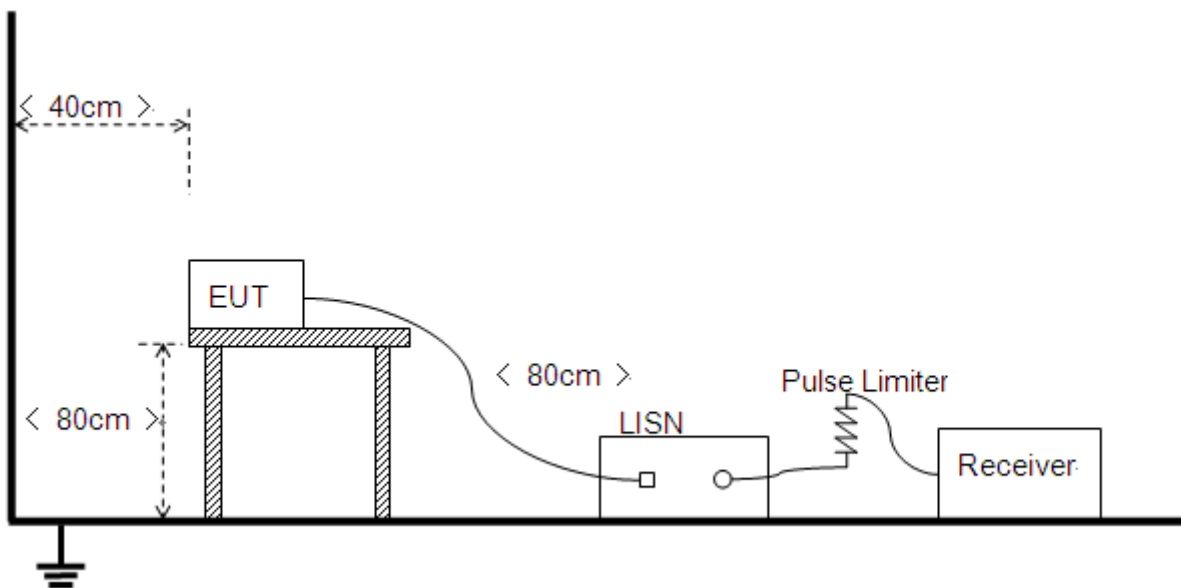

The Table-top EUT was placed upon a non-metallic table 0.8m above the horizontal metal reference ground plane. EUT was connected to LISN and LISN was connected to reference Ground Plane. EUT was 80cm from LISN. The set-up and test methods were according to ANSI C63.10: 2013.

The factors of the site are calibrated to correct the reading. During the measurement, the Bluetooth EUT is activated and controlled by the Bluetooth Service Supplier (SS) via a Common Antenna, and is set to operate under hopping-on test mode transmitting 339 bytes DH5 packages at maximum power.





**B. Equipments List:**

Please reference ANNEX A(1.5).

**2.9.3 Test Result**

The maximum conducted interference is searched using Peak (PK), if the emission levels more than the AV and QP limits, and that have narrow margins from the AV and QP limits will be re-measured with AV and QP detectors. Tests for both L phase and N phase lines of the power mains connected to the EUT are performed. Refer to recorded points and plots below.

**A. Test setup:**

The EUT configuration of the emission tests is EUT + Link.

**Note:** The test voltage is AC 120V/60Hz.

**B. Test Plots:**

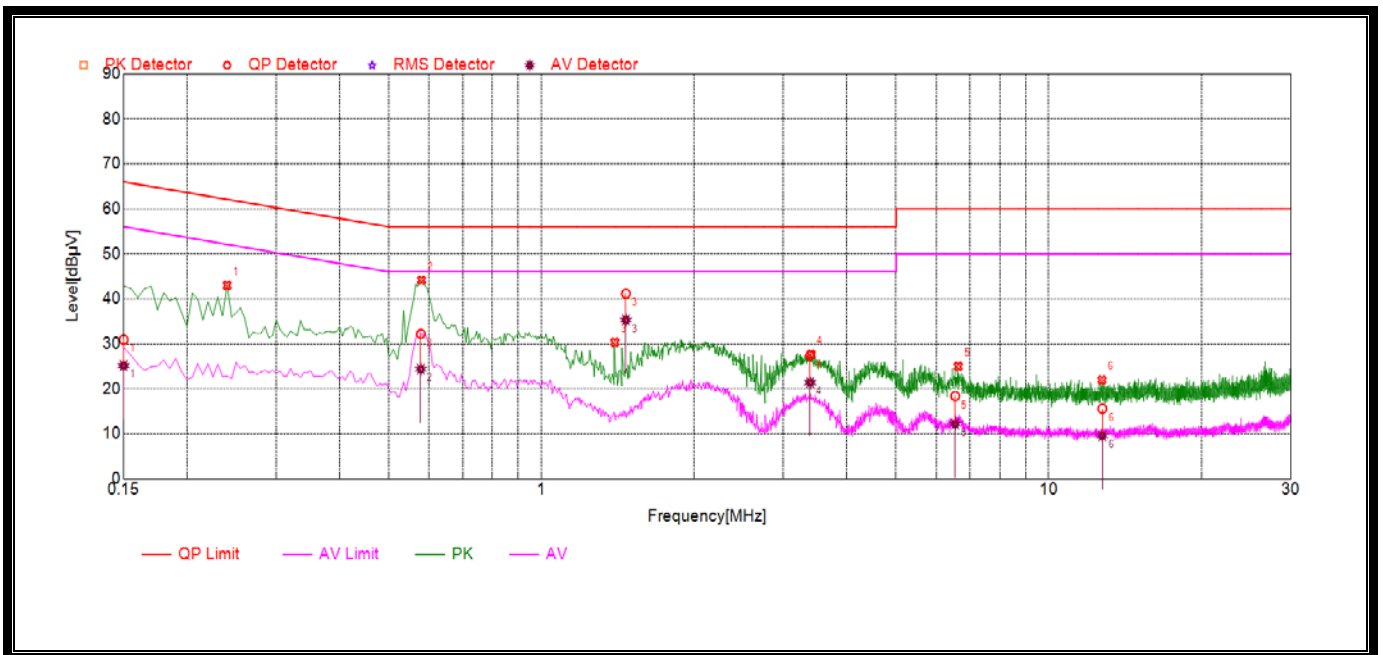

(Plot A: L Phase)

NO.	Fre. (MHz)	Emission Level (dBµV)		Limit (dBµV)		Power-line	Verdict
		Quai-peak	Average	Quai-peak	Average		
1	0.15	30.96	25.15	66.00	56.00	Line	PASS
2	0.5782	32.21	24.38	56.00	46.00		PASS
3	1.4668	41.16	35.30	56.00	46.00		PASS
4	3.386	27.41	21.40	56.00	46.00		PASS
5	6.54	18.41	12.17	60.00	50.00		PASS
6	12.7528	15.60	9.55	60.00	50.00		PASS



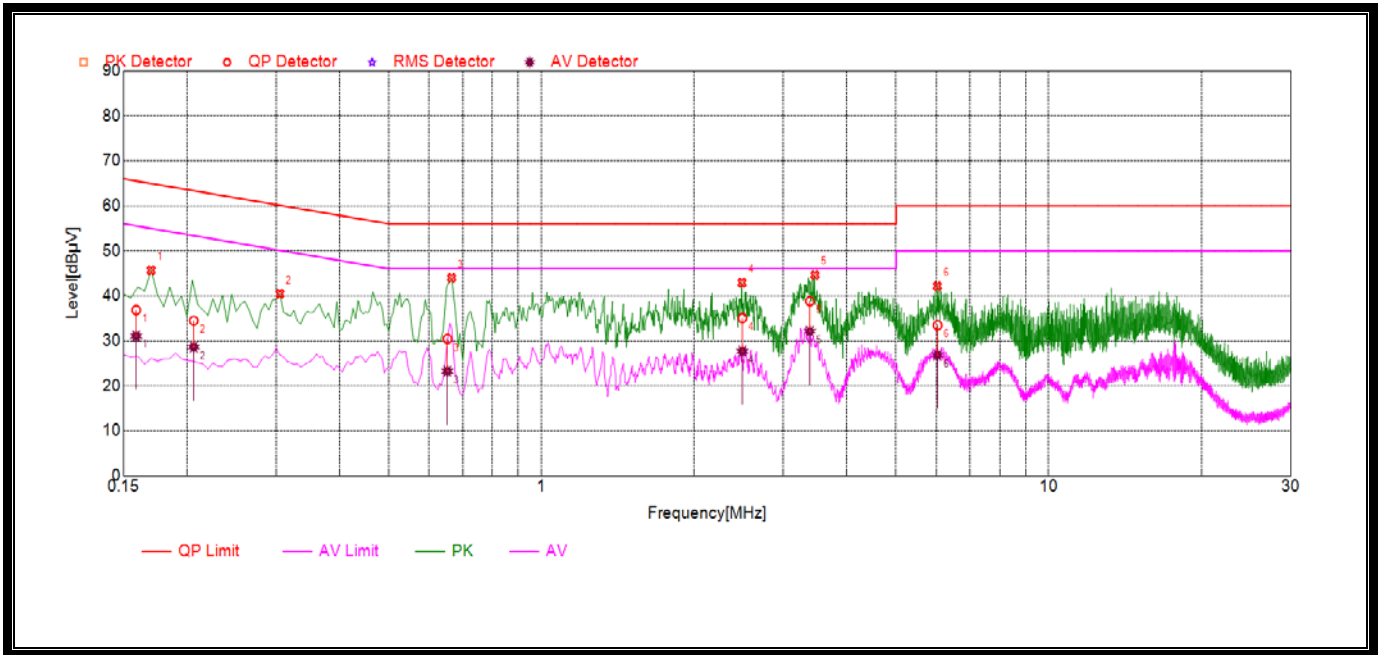

(Plot B: N Phase)

NO.	Fre. (MHz)	Emission Level (dBµV)		Limit (dBµV)		Power-line	Verdict
		Quai-peak	Average	Quai-peak	Average		
1	0.1588	36.84	31.07	65.53	55.53	Line	PASS
2	0.2062	34.50	28.61	63.36	53.36		PASS
3	0.6524	30.41	23.26	56.00	46.00		PASS
4	2.4888	35.07	27.70	56.00	46.00		PASS
5	3.3814	38.81	32.12	56.00	46.00		PASS
6	6.0378	33.47	26.85	60.00	50.00		PASS



## 2.10 Radiated Emission

### 2.10.1 Requirement

According to FCC section 15.247(d), radiated emission outside the frequency band attenuation below the general limits specified in FCC section 15.209(a) is not required. In addition, radiated emissions which fall in the restricted bands, as defined in FCC section 15.205(a), must also comply with the radiated emission limits specified in FCC section 15.209(a).

According to FCC section 15.209 (a), except as provided elsewhere in this subpart, the emissions from an intentional radiator shall not exceed the field strength levels specified in the following table:

Frequency (MHz)	Field Strength ( $\mu\text{V}/\text{m}$ )	Measurement Distance (m)
0.009 - 0.490	2400/F(kHz)	300
0.490 - 1.705	24000/F(kHz)	30
1.705 - 30.0	30	30
30 - 88	100	3
88 - 216	150	3
216 - 960	200	3
Above 960	500	3

**Note:**

1. For Above 1000MHz, the emission limit in this paragraph is based on measurement instrumentation employing an average detector, measurement using instrumentation with a peak detector function, corresponding to 20dB above the maximum permitted average limit.
2. For above 1000MHz, limit field strength of harmonics: 54dBuV/m@3m (AV) and 74dBuV/m@3m (PK)

In addition, radiated emissions which fall in the restricted bands, as defined in Section 15.205(a), also should comply with the radiated emission limits specified in Section 15.209(a)(above table)

### 2.10.2 Test Description

#### A. Test Setup:

- 1) For radiated emissions from 9kHz to 30MHz

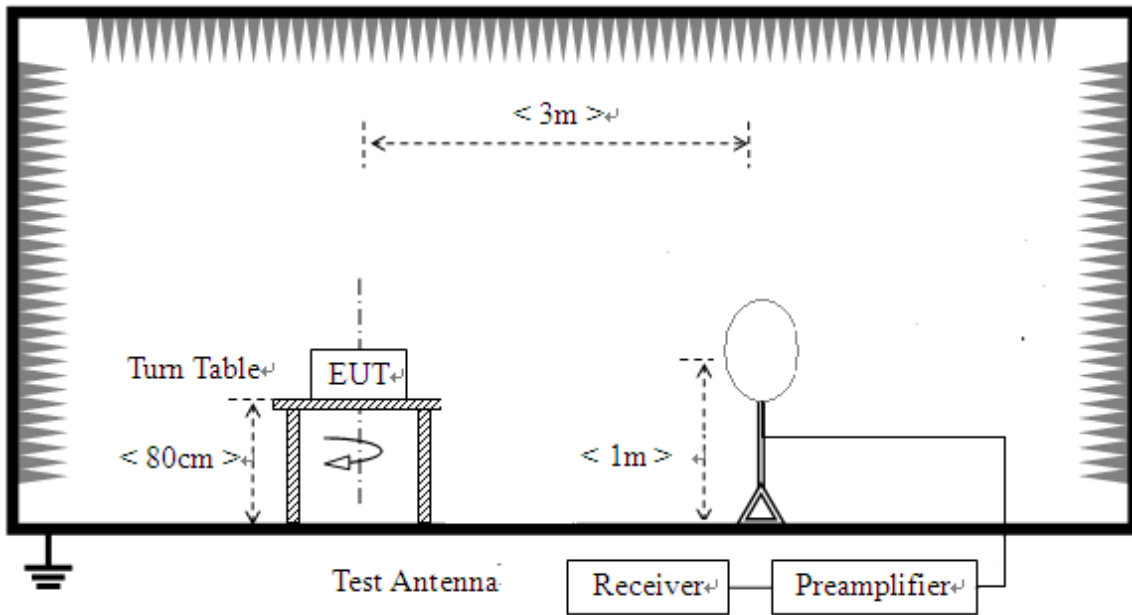

- 2) For radiated emissions from 30MHz to 1GHz

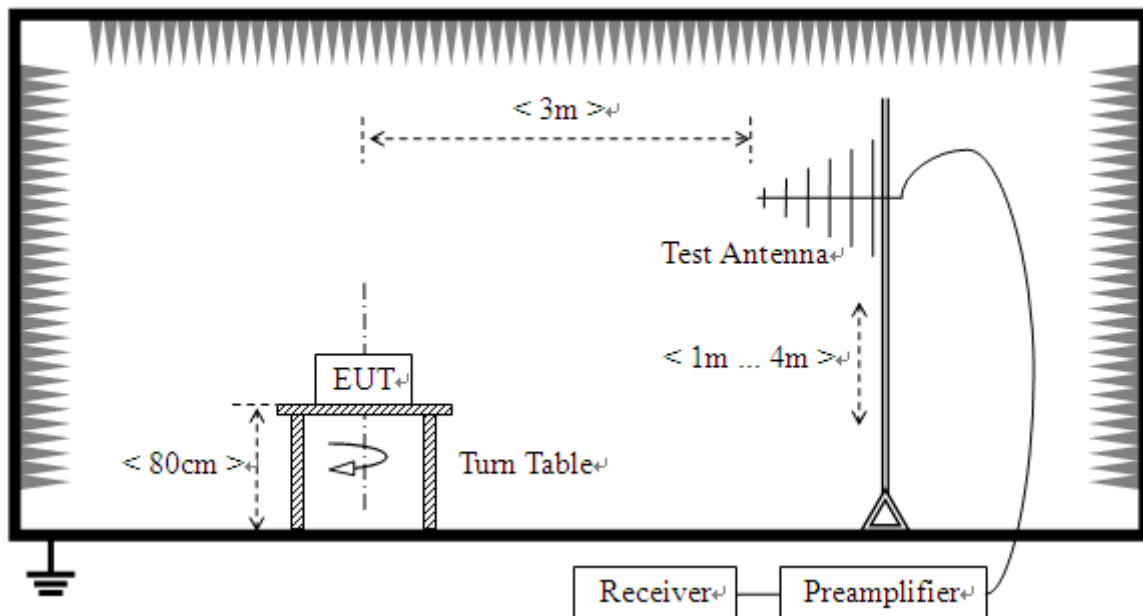

## 3) For radiated emissions above 1GHz

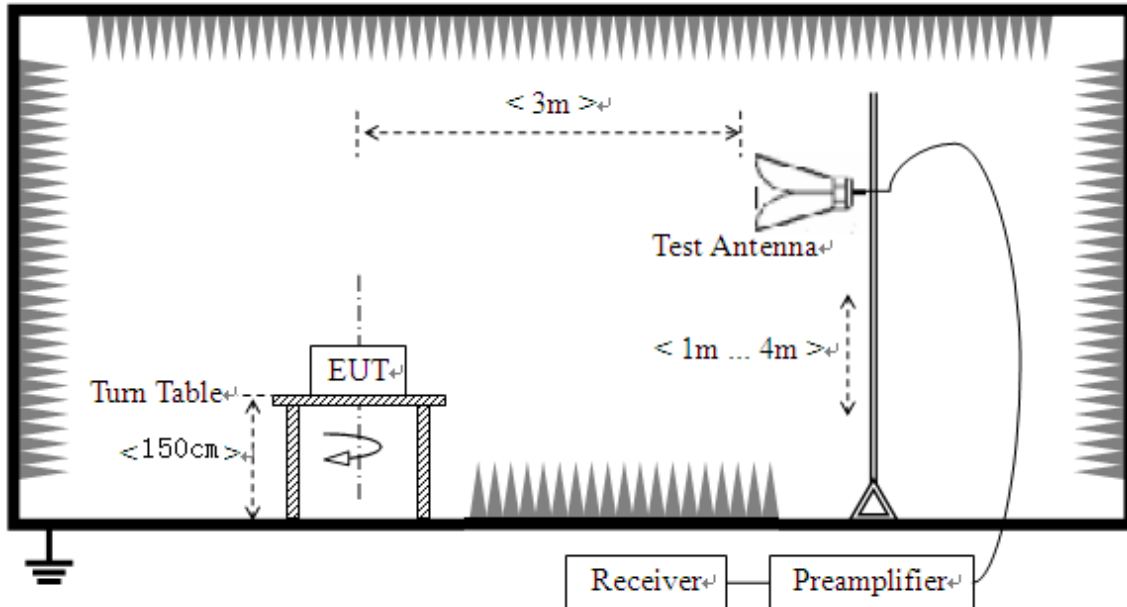

The RF absorbing material used on the reference ground plane and on the turntable have a maximum height (thickness) of 30 cm (12 in) and have a minimum-rated attenuation of 20 dB at all frequencies from 1 GHz to 18 GHz. Test site have a minimum area of the ground plane covered with RF absorbing material as specified in Figure 6 of ANSI C63.4: 2014.

The test site semi-anechoic chamber has met the requirement of NSA tolerance 4dB according to the standards: ANSI C63.10 (2013). For radiated emissions below or equal to 1GHz, the EUT was set-up on insulator 80cm above the Ground Plane, For radiated emissions above 1GHz, The EUT was set-up on insulator 150cm above the Ground Plane. The set-up and test methods were according to ANSI C63.10.

The EUT is located in a 3m Semi-Anechoic Chamber; the antenna factors, cable loss and so on of the site as factors are calculated to correct the reading.

For the Test Antenna:

- (a) In the frequency range of 9kHz to 30MHz, magnetic field is measured with Loop Test Antenna. The Test Antenna is positioned with its plane vertical at 1m distance from the EUT. The center of the Loop Test Antenna is 1m above the ground. During the measurement the Loop Test Antenna rotates about its vertical axis for maximum response at each azimuth about the EUT.
- (b) In the frequency range above 30MHz, Bi-Log Test Antenna (30MHz to 1GHz) and Horn Test Antenna (above 1GHz) are used. Place the test antenna at 3m away from area of the EUT, while keeping the test antenna aimed at the source of emissions at each frequency of significant



emissions, with polarization oriented for maximum response. The test antenna may have to be higher or lower than the EUT, depending on the radiation pattern of the emission and staying aimed at the emission source for receiving the maximum signal. The final test antenna elevation shall be that which maximizes the emissions. The test antenna elevation for maximum emissions shall be restricted to a range of heights of from 1 m to 4 m above the ground or reference ground plane. The emission levels at both horizontal and vertical polarizations should be tested.

## B. Equipments List:

Please reference ANNEX A(1.5).

### 2.10.3 Test Procedure

Use the following spectrum analyzer settings:

Span = wide enough to fully capture the emission being measured

RBW = 1 MHz for  $f \geq 1$  GHz, 100 kHz for  $f < 1$  GHz

VBW  $\geq$  RBW

Sweep = auto

Detector function = peak

Trace = max hold

### 2.10.4 Test Result

According to ANSI C63.10, because of peak detection will yield amplitudes equal to or greater than amplitudes measured with the quasi-peak (or average) detector, the measurement data from a spectrum analyzer peak detector will represent the worst-case results, if the peak measured value complies with the quasi-peak limit, it is unnecessary to perform an quasi-peak measurement.

The measurement results are obtained as below:

$$E \text{ [dB}\mu\text{V/m]} = U_R + A_T + A_{\text{Factor}} \text{ [dB]}; A_T = L_{\text{Cable loss}} \text{ [dB]} - G_{\text{preamp}} \text{ [dB]}$$

$A_T$ : Total correction Factor except Antenna

$U_R$ : Receiver Reading

$G_{\text{preamp}}$ : Preamplifier Gain

$A_{\text{Factor}}$ : Antenna Factor at 3m

During the test, the total correction Factor  $A_T$  and  $A_{\text{Factor}}$  were built in test software.

**Note:** All radiated emission tests were performed in X, Y, Z axis direction. And only the worst axis test condition was recorded in this test report.

The low frequency, which started from 9KHz to 30MHz, was pre-scanned and the result which was 20dB lower than the limit line per 15.31(o) was not reported.

2.10.4.1 GFSK Mode:

A. Test Plots for the Whole Measurement Frequency Range:

Plots for Channel = 0

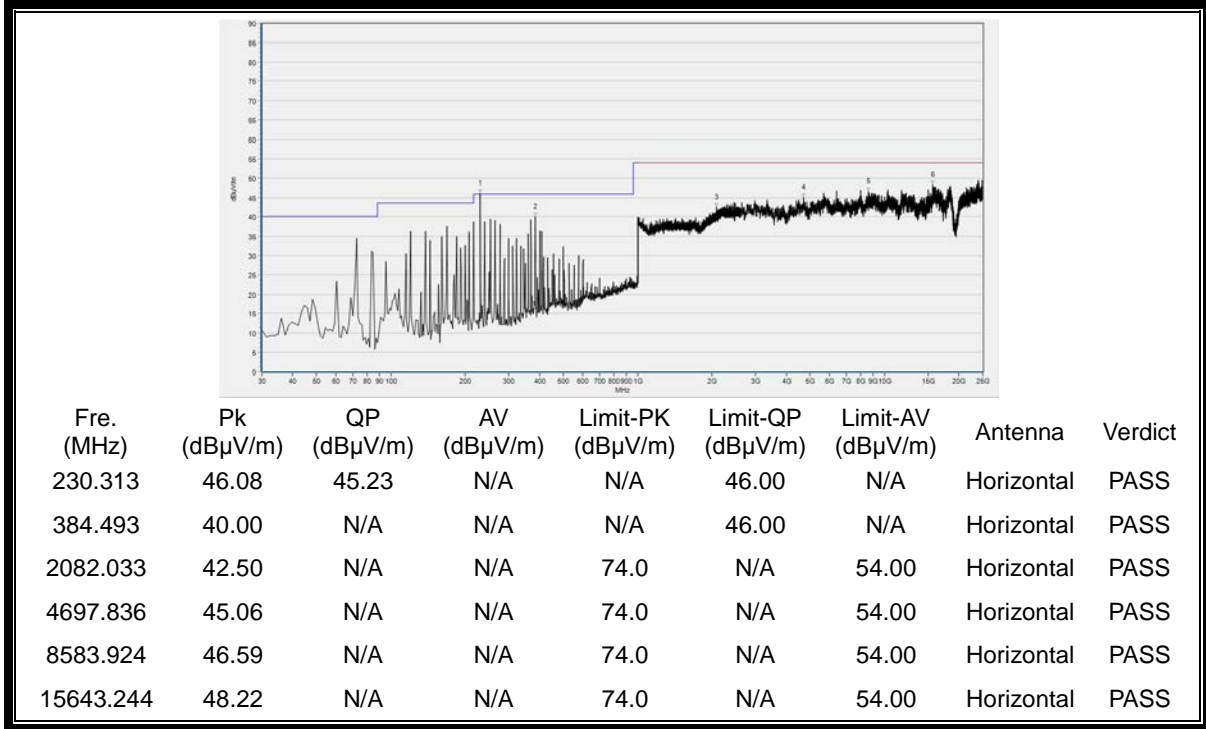

(30MHz to 25GHz, Antenna Horizontal @ GFSK, channel 0)

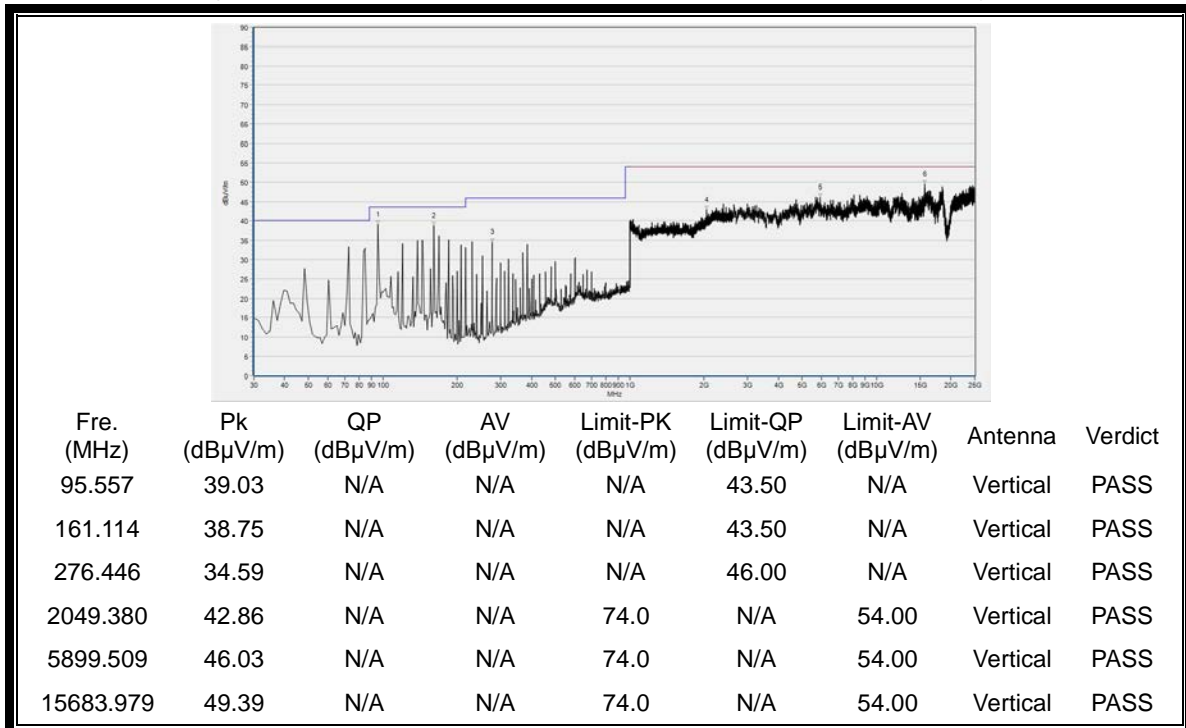

(30MHz to 25GHz, Antenna Vertical @ GFSK, channel 0)

Plot for Channel = 39

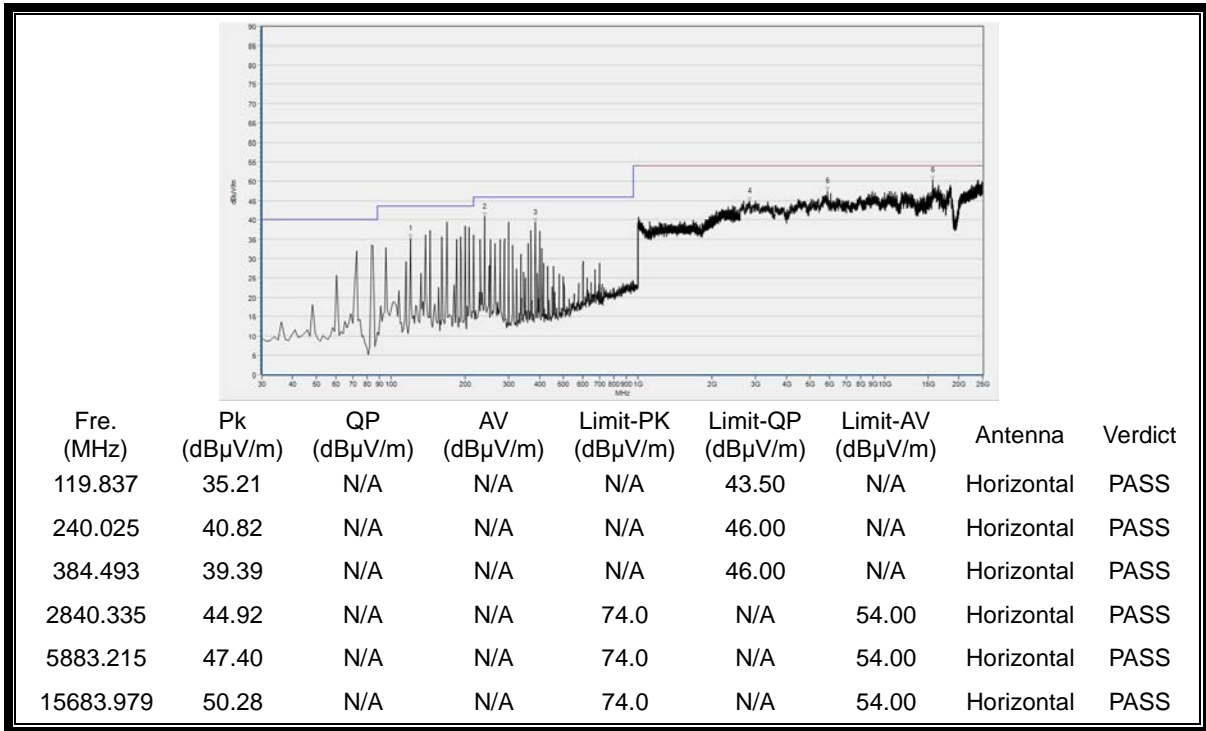

(30MHz to 25GHz, Antenna Horizontal @ GFSK, channel 39)

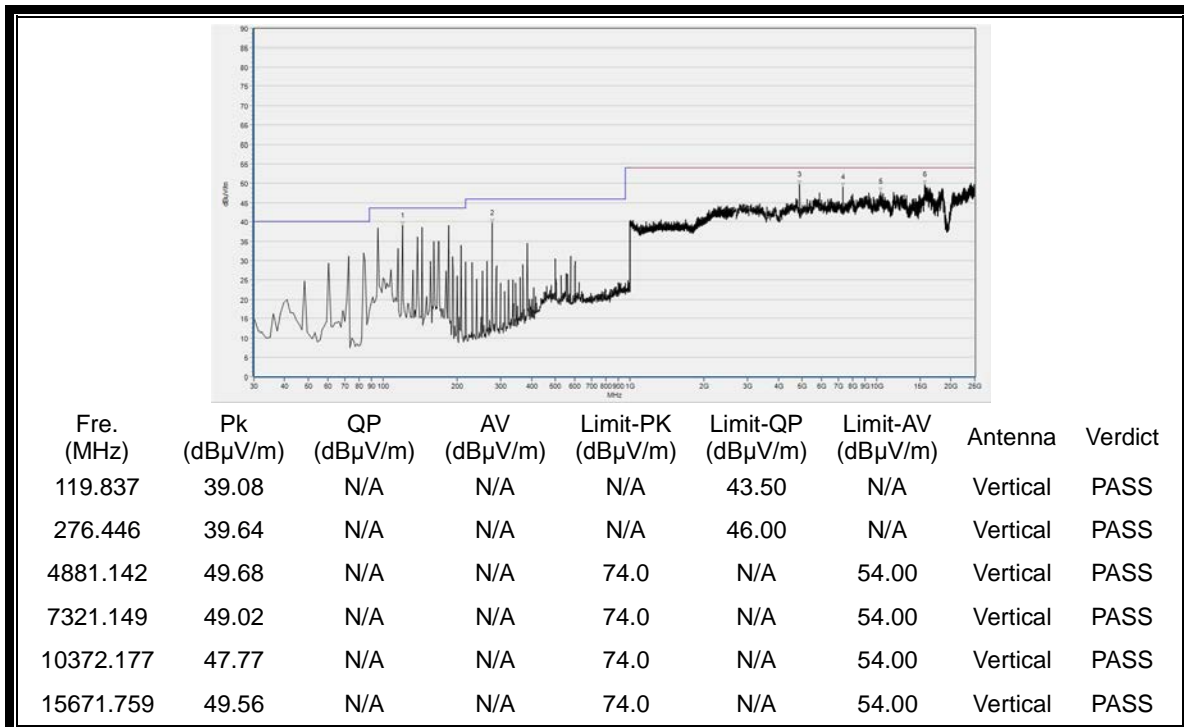

(30MHz to 25GHz, Antenna Vertical @ GFSK, channel 39)

Plot for Channel = 78

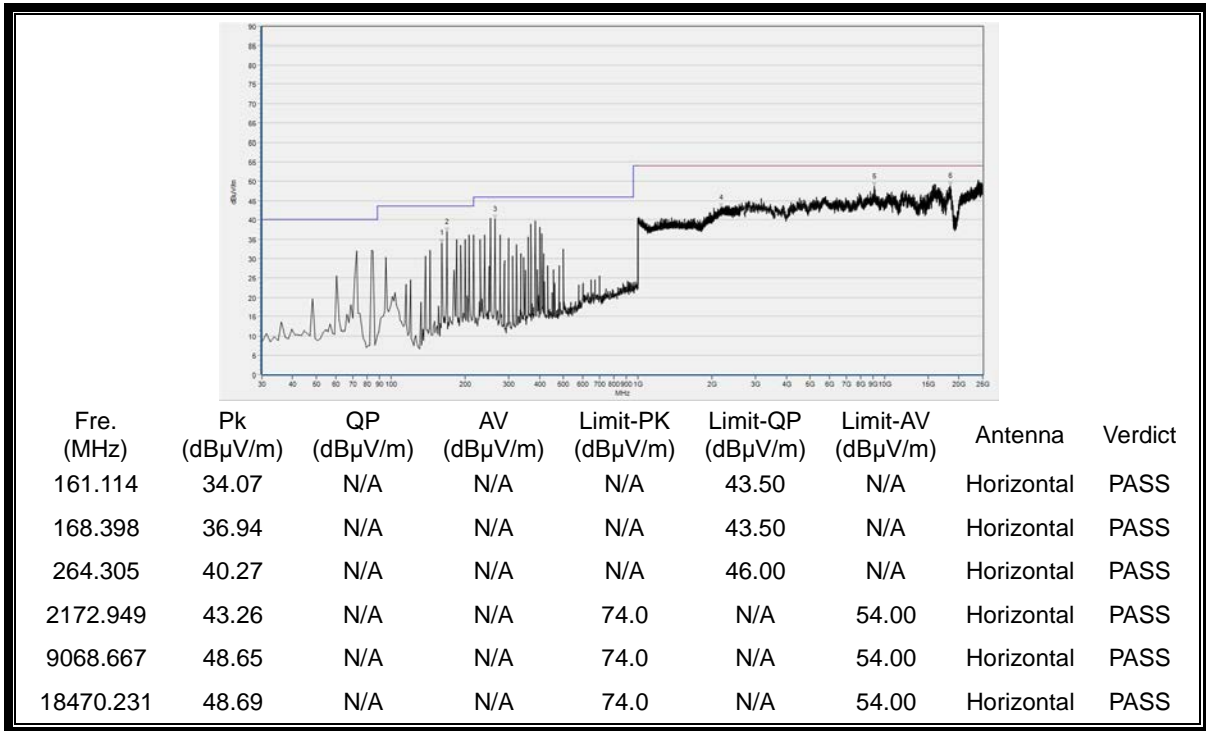

(30MHz to 25GHz, Antenna Horizontal @ GFSK, channel 78)

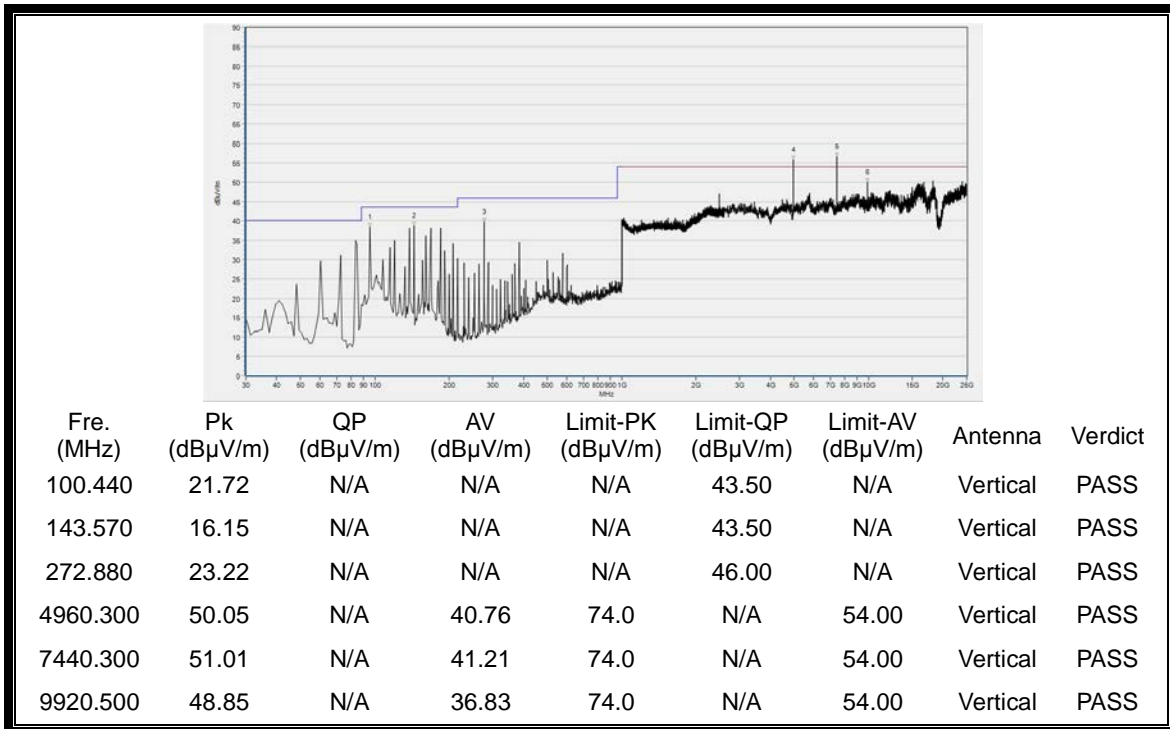

(30MHz to 25GHz, Antenna Vertical @ GFSK, channel 78)



2.10.4.2  $\pi/4$ -DQPSK Mode:

**B. Test Plots for the Whole Measurement Frequency Range:**

Plots for Channel = 0

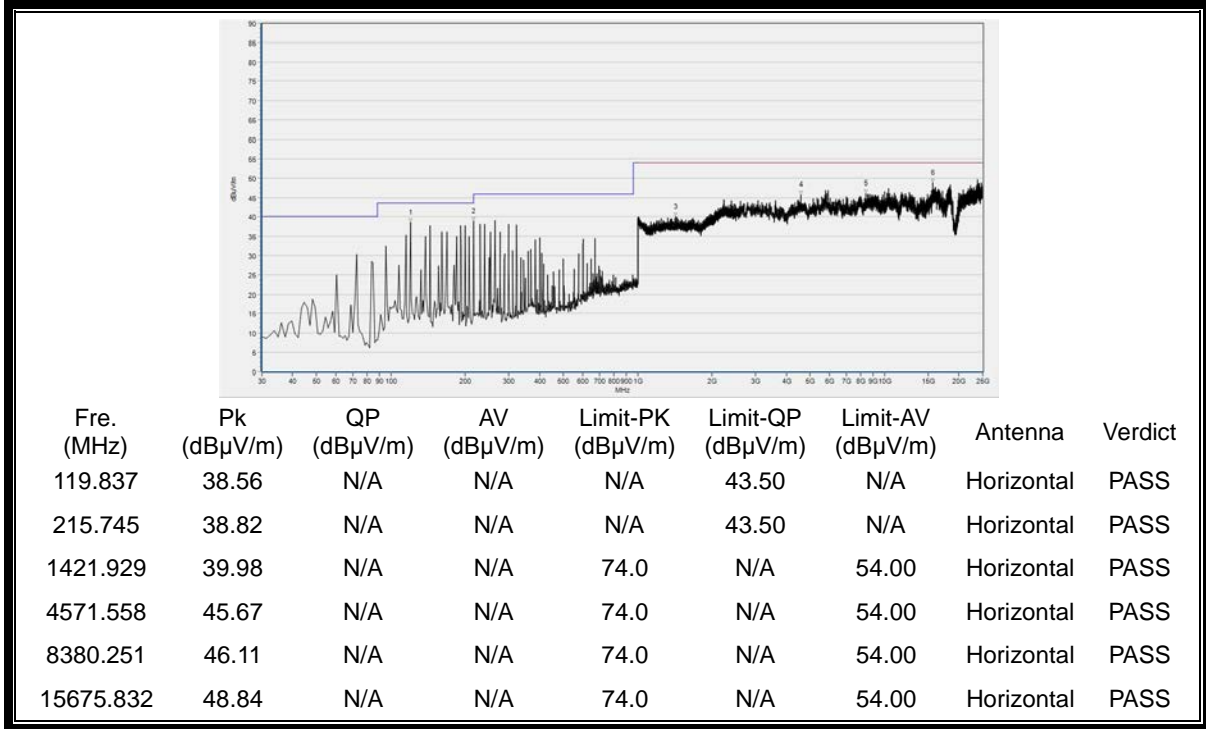

(30MHz to 25GHz, Antenna Horizontal @  $\pi/4$ -DQPSK, channel 0)

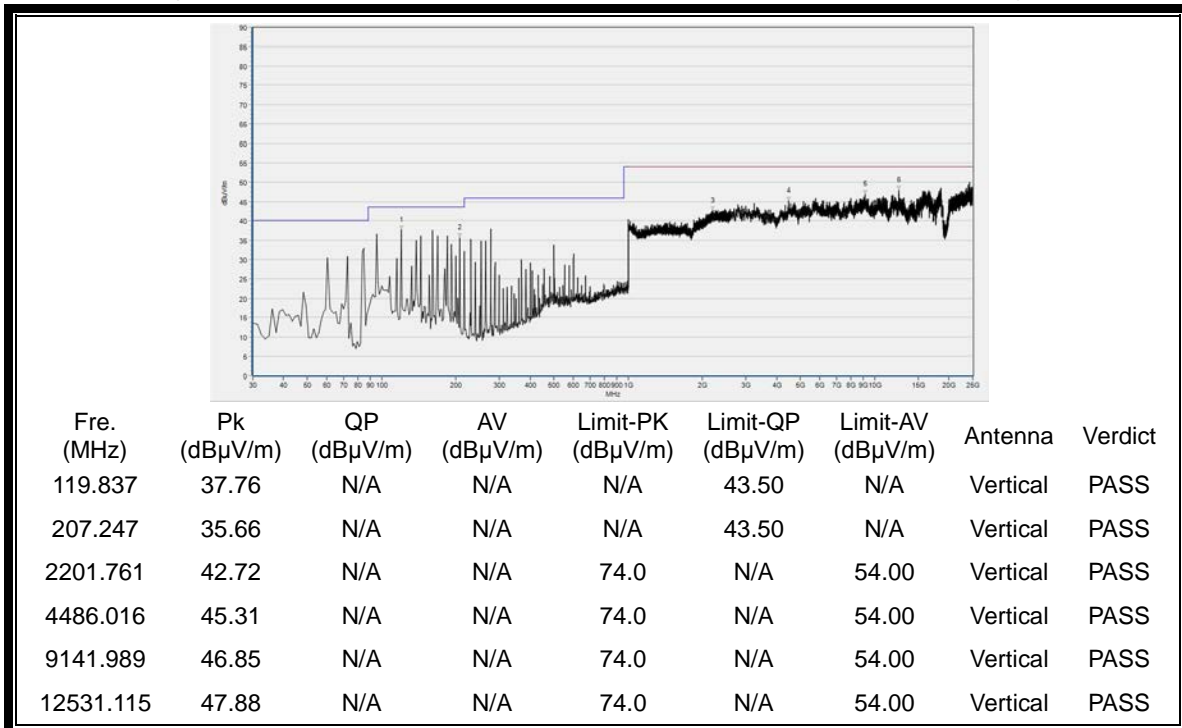

(30MHz to 25GHz, Antenna Vertical @  $\pi/4$ -DQPSK, channel 0)



Plot for Channel = 39

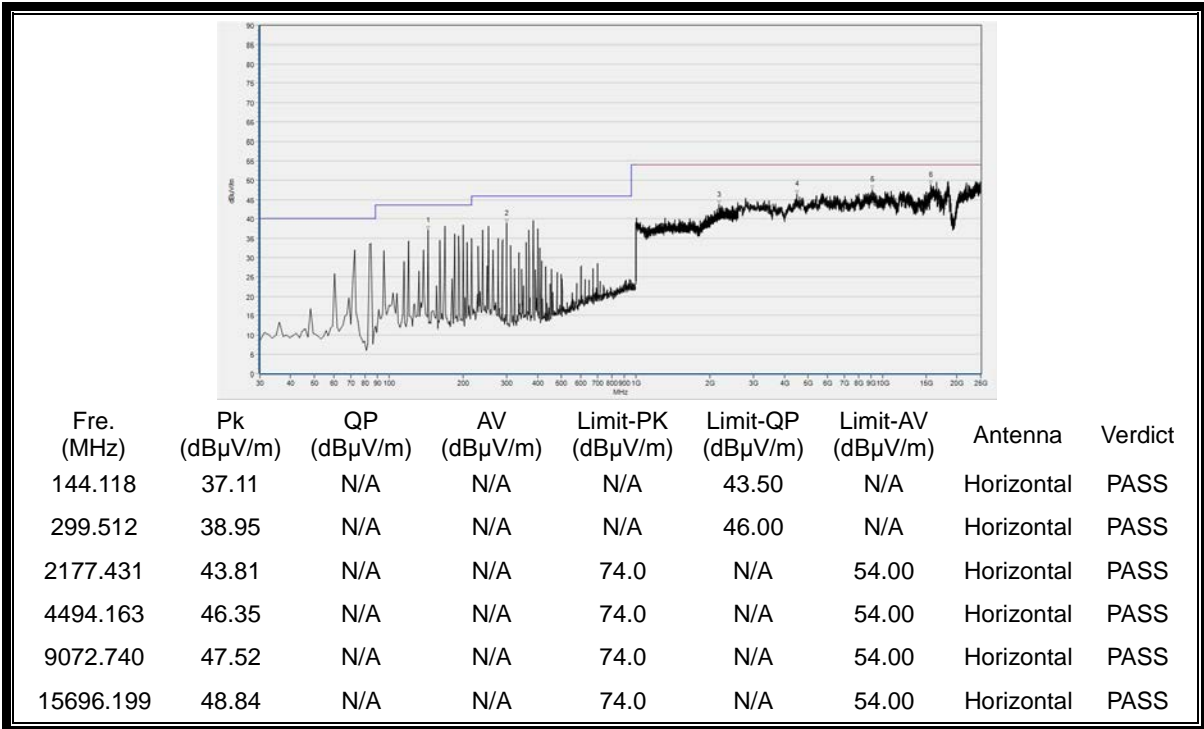

(30MHz to 25GHz, Antenna Horizontal @ π/4-DQPSK, channel 39)

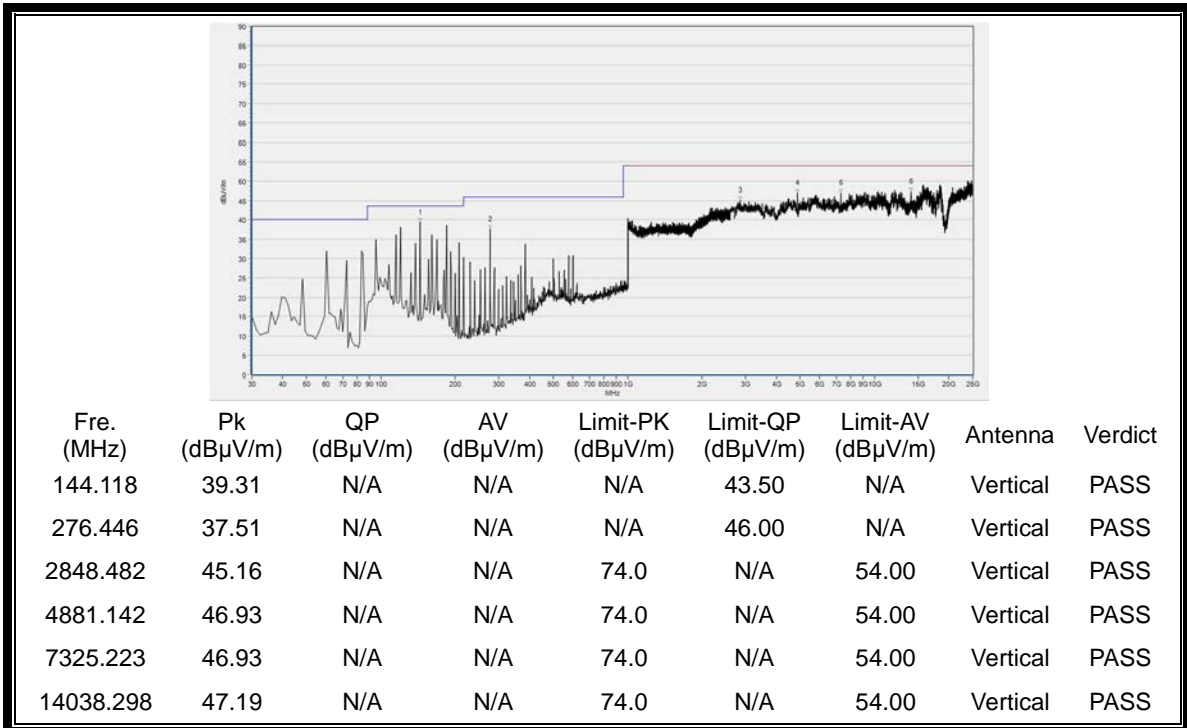

(30MHz to 25GHz, Antenna Vertical @ π/4-DQPSK, channel 39)



Plot for Channel = 78

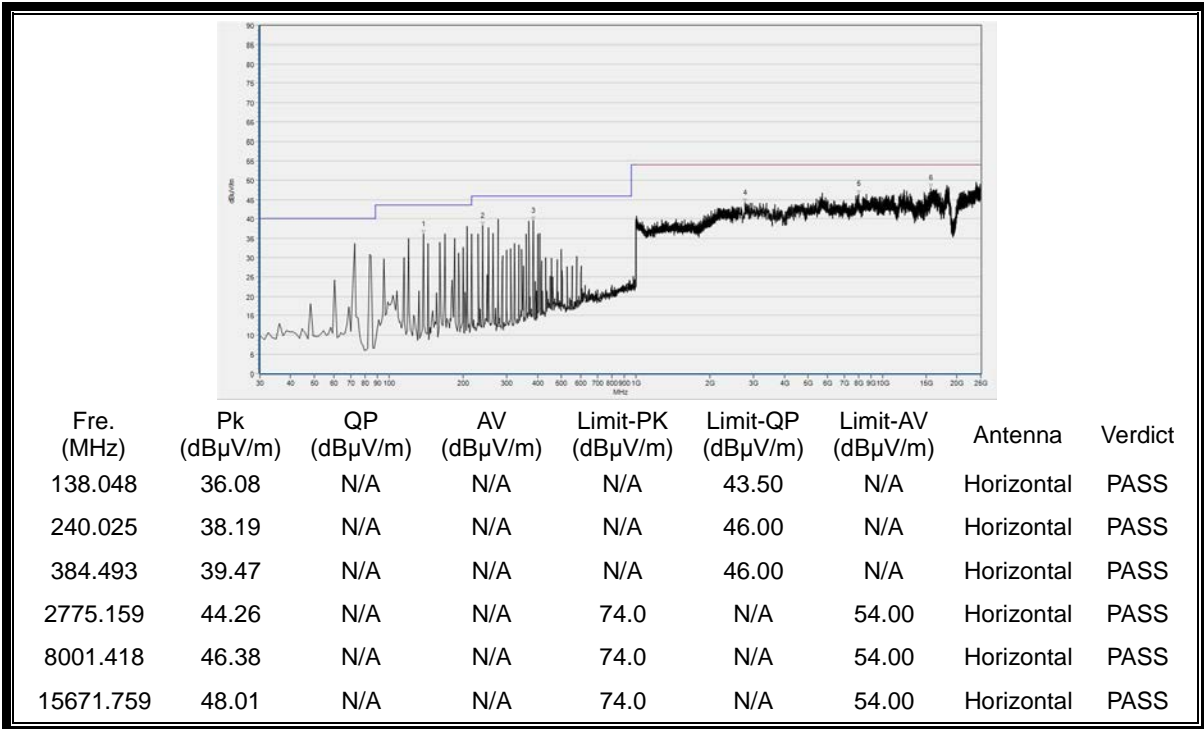

(30MHz to 25GHz, Antenna Horizontal @ π/4-DQPSK, channel 78)

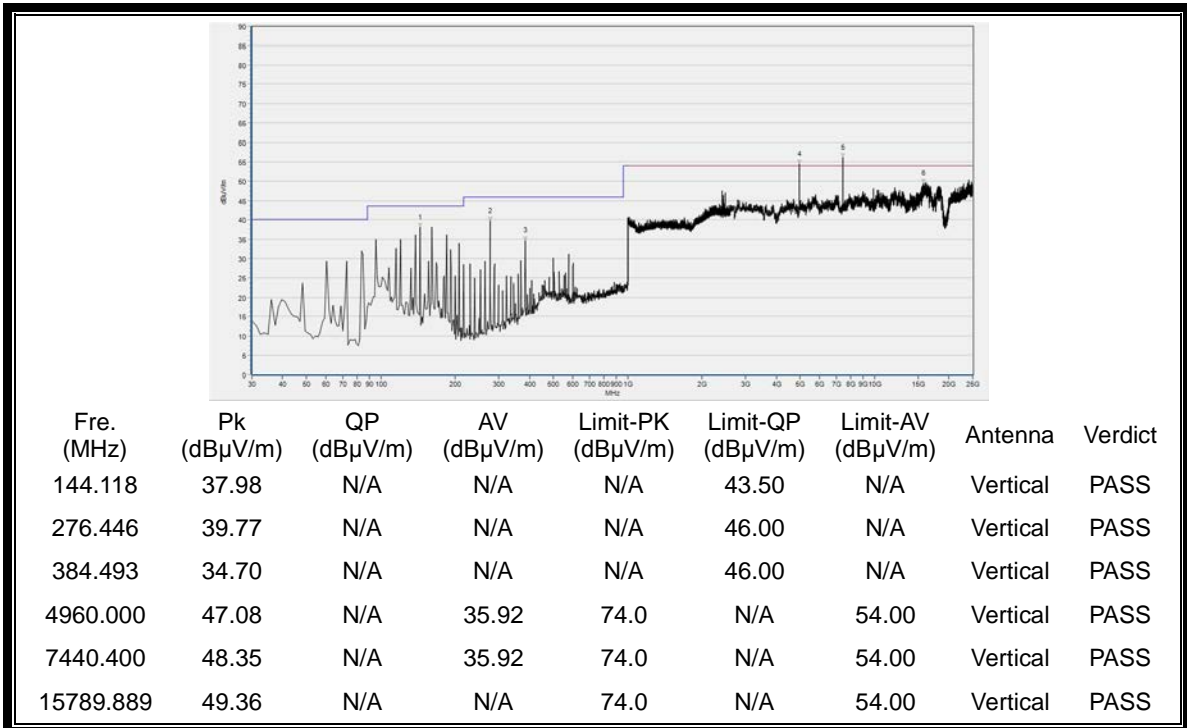

(30MHz to 25GHz, Antenna Vertical @ π/4-DQPSK, channel 78)

2.10.4.3 8-DPSK Mode:

C. Test Plots for the Whole Measurement Frequency Range:

Plots for Channel = 0

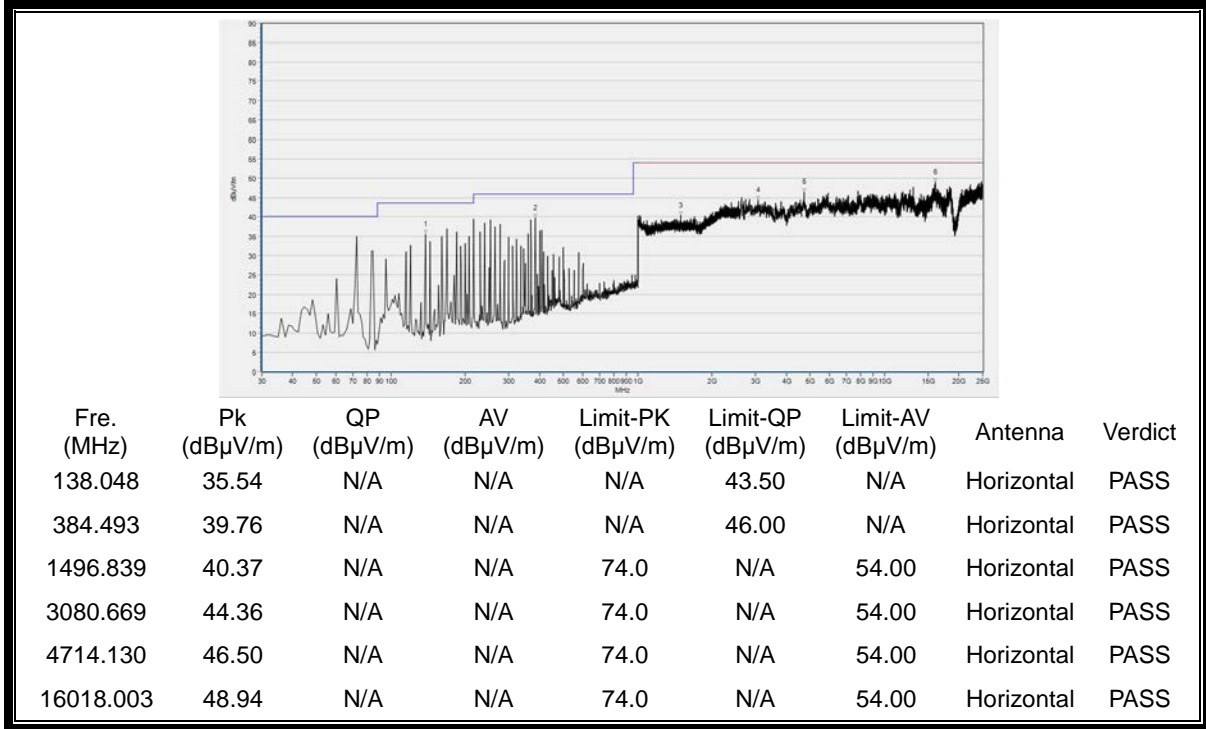

(30MHz to 25GHz, Antenna Horizontal @8-DPSK, channel 0)

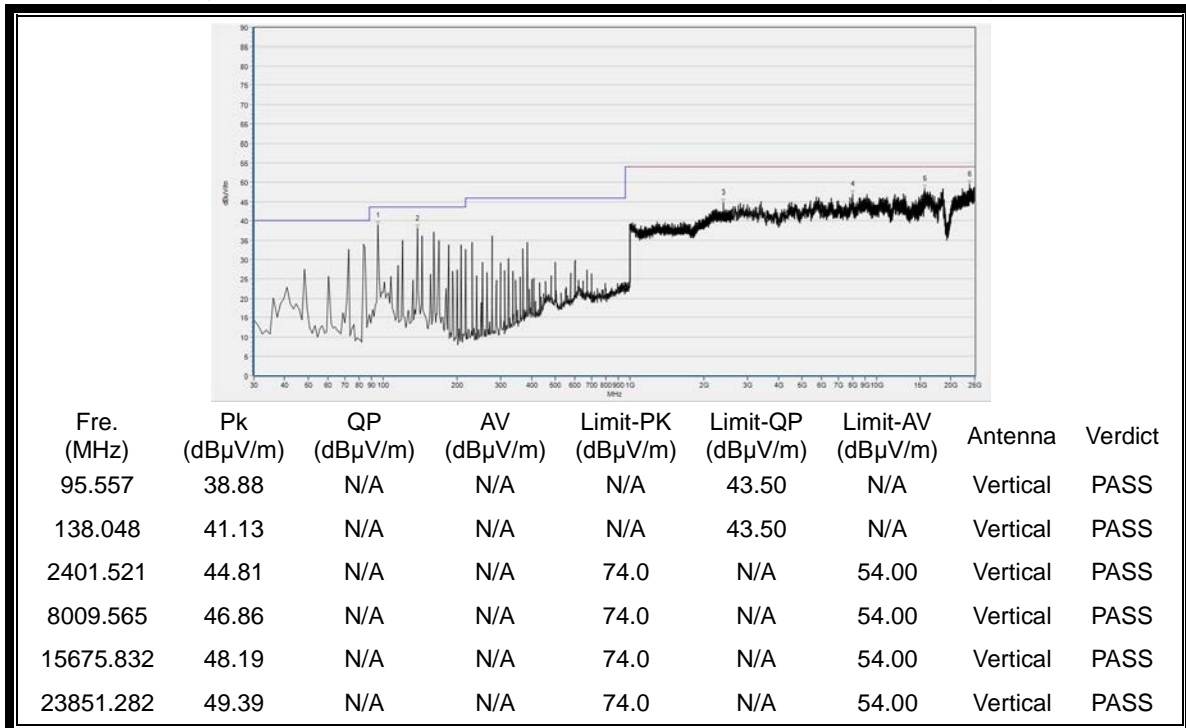

(30MHz to 25GHz, Antenna Vertical @8-DPSK, channel 0)



Plot for Channel = 39

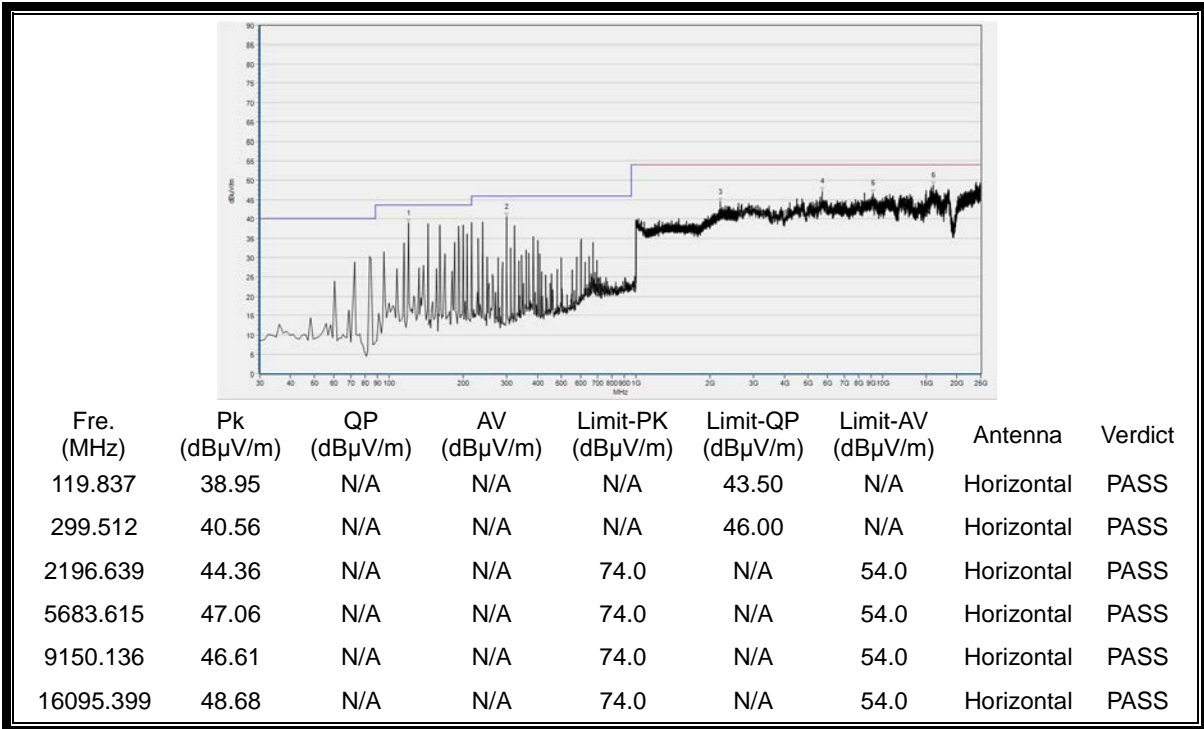

(30MHz to 25GHz, Antenna Horizontal @8-DPSK, channel 39)

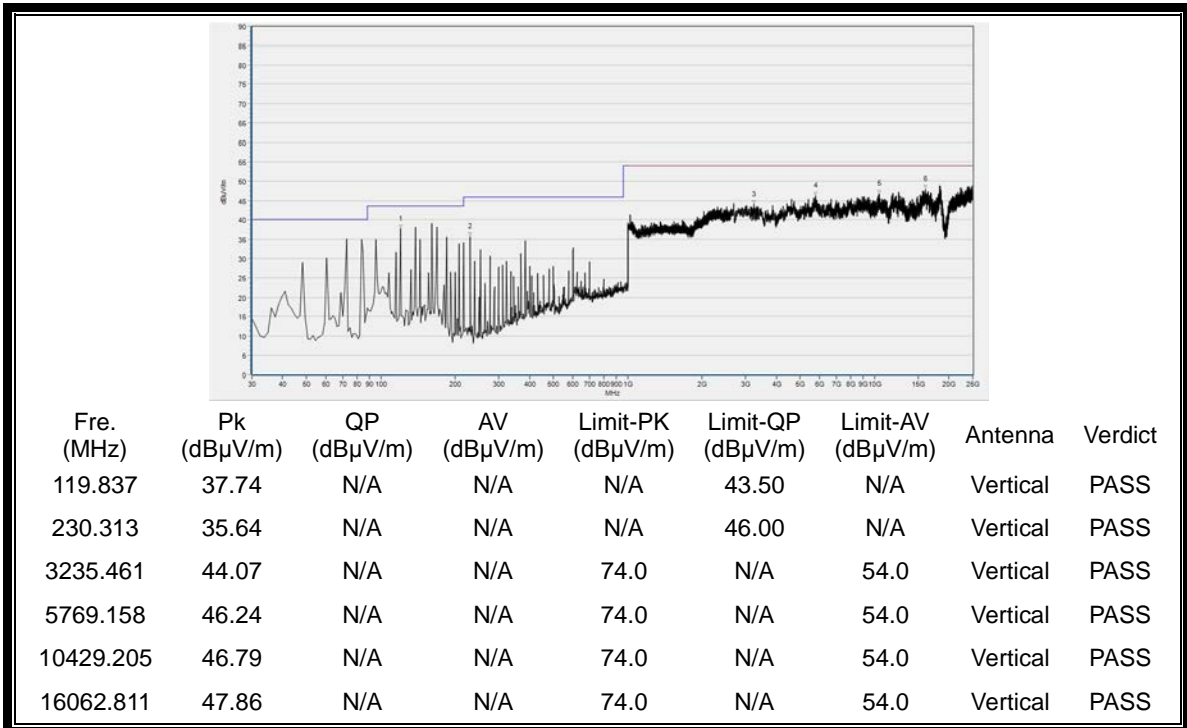

(30MHz to 25GHz, Antenna Vertical @8-DPSK, channel 39)



Plot for Channel = 78

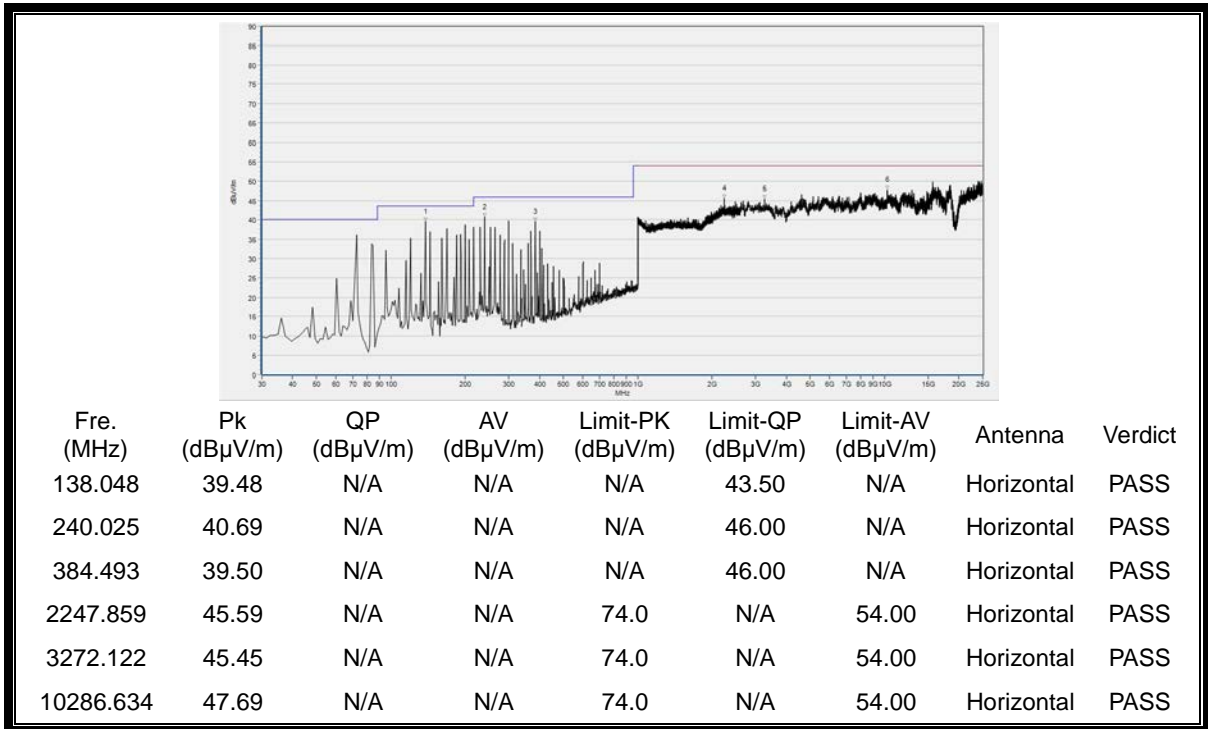

(30MHz to 25GHz, Antenna Horizontal @8-DPSK, channel 78)

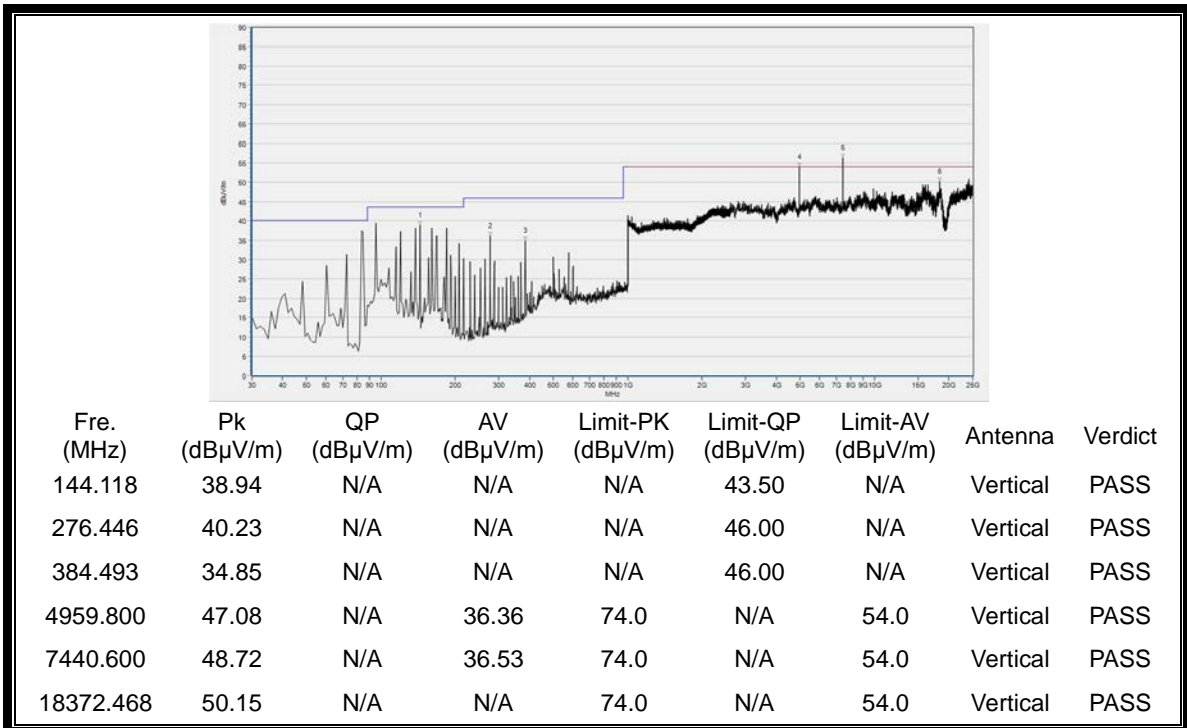

(30MHz to 25GHz, Antenna Vertical @8-DPSK, channel 78)



## ANNEX A GENERAL INFORMATION

### 1.1 Identification of the Responsible Testing Laboratory

Company Name:	Shenzhen Morlab Communications Technology Co., Ltd.
Department:	Morlab Laboratory
Address:	FL.3, Building A, FeiYang Science Park, No.8 LongChang Road, Block 67, BaoAn District, ShenZhen, GuangDong Province, P. R. China
Responsible Test Lab Manager:	Mr. Su Feng
Telephone:	+86 755 36698555
Facsimile:	+86 755 36698525

### 1.2 Identification of the Responsible Testing Location

Name:	Shenzhen Morlab Communications Technology Co., Ltd. Morlab Laboratory
Address:	FL.3, Building A, FeiYang Science Park, No.8 LongChang Road, Block 67, BaoAn District, ShenZhen, GuangDong Province, P. R. China

### 1.3 Facilities and Accreditations

Shenzhen Morlab Communications Technology Co., Ltd. Morlab Laboratory is a testing organization accredited by China National Accreditation Service for Conformity Assessment (CNAS) according to ISO/IEC 17025. The accreditation certificate number is L3572.

All measurement facilities used to collect the measurement data are located at FL.3, Building A, FeiYang Science Park, Block 67, BaoAn District, Shenzhen, 518101 P. R. China. The test site is constructed in conformance with the requirements of ANSI C63.10-2013 and CISPR Publication 22; the FCC designation number is CN1192.

### 1.4 Maximum measurement uncertainty

Where relevant, the following measurement uncertainty levels have been estimated for test performed on the EUT as specified in CISPR 16-1-2:

Test items	Uncertainty
Number of Hopping Frequency	±5%
Peak Output Power	±2.22dB
20dB Bandwidth	±5%
Carrier Frequency Separation	±5%
Time of Occupancy (Dwell time)	±5%
Conducted Spurious Emission	±2.77 dB
Restricted Frequency Bands	±5%





Radiated Emission	±2.95dB
Conducted Emission	±2.44dB

This uncertainty represent an expanded uncertainty expressed at approximately the 95% confidence level using a coverage factor of k=2

**1.5 Test Equipments Utilized**

**1.5.1 Conducted Test Equipments**

**Conducted Test Equipment**

No.	Equipment Name	Serial No.	Type	Manufacturer	Cal. Date	Cal. Due
1	Spectrum Analyzer	MY45101810	E4407B	Agilent	2017.05.24	2018.05.23
2	Power Splitter	NW521	1506A	Weinschel	2017.05.24	2018.05.23
3	Attenuator 1	(N/A.)	10dB	Resnet	2017.05.24	2018.05.23
4	Attenuator 2	(N/A.)	3dB	Resnet	2017.05.24	2018.05.23
5	EXA Signal Analyzer	MY53470836	N9010A	Agilent	2016.12.07	2017.12.06
6	Bluetooth Test Set	6K00006210	MT8852B	Anritsu	2017.05.24	2018.05.23
7	USB Wideband Power Sensor	MY54210011	U2021XA	Agilent	2017.05.24	2018.05.23
8	RF cable (30MHz-26GHz)	CB01	RF01	Morlab	N/A	N/A
9	Coaxial cable	CB02	RF02	Morlab	N/A	N/A
10	SMA connector	CN01	RF03	HUBER-SUHNER	N/A	N/A

**1.5.2 Conducted Emission Test Equipments**

**Conducted Emission Test Equipments**

No.	Equipment Name	Serial No.	Type	Manufacturer	Cal. Date	Cal. Due
1	Receiver	US44210471	E7405A	Agilent	2017.05.24	2018.05.23
2	LISN	812744	NSLK 8127	Schwarzbeck	2017.05.24	2018.05.23
3	Service Supplier	100448	CMU200	R&S	2017.05.24	2018.05.23
4	Pulse Limiter (20dB)	9391	VTSD 9561-D	Schwarzbeck	2017.05.24	2018.05.23
5	Coaxial cable(BNC) (30MHz-26GHz)	CB01	EMC01	Morlab	N/A	N/A

**1.5.3 Auxiliary Test Equipment**

**Auxiliary Test Equipment**

No.	Equipment Name	Model No.	Brand Name	Manufacturer	Cal.Date	Cal.Due Date
1	Computer	T430i	Think Pad	Lenovo	N/A	N/A



**1.5.4 Radiated Test Equipments**

Radiated Test Equipments						
No.	Equipment Name	Serial No.	Type	Manufacturer	Cal. Date	Cal.Due Date
1	System Simulator	GB45360846	8960-E5515C	Agilent	2017.05.17	2018.05.16
2	Receiver	MY54130016	N9038A	Agilent	2017.05.17	2018.05.16
3	Test Antenna - Bi-Log	N/A	VULB9163	Schwarzbeck	2016.12.09	2017.12.08
4	Test Antenna - Horn	9120C-384	BBHA 9120C	Schwarzbeck	2017.03.30	2018.03.29
5	Test Antenna - Loop	1519-022	FMZB1519	Schwarzbeck	2017.03.30	2018.03.29
6	Coaxial cable (N male) (9KHz-30MHz)	CB04	EMC04	Morlab	N/A	N/A
7	Coaxial cable (N male) (30MHz-26GHz)	CB02	EMC02	Morlab	N/A	N/A
8	Coaxial cable(N male) (30MHz-26GHz)	CB03	EMC03	Morlab	N/A	N/A
9	1-18GHz pre-Amplifier	MA02	TS-PR18	Rohde& Schwarz	2017.05.17	2018.05.16
10	18-26.5GHz pre-Amplifier	MA03	TS-PR18	Rohde& Schwarz	2017.05.17	2018.05.16

**1.5.5 Climate Chamber**

Climate Chamber						
No.	Equipment Name	Serial No.	Type	Manufacturer	Cal.Date	Cal.Due Date
1	Climate Chamber	2004012	HL4003T	Yinhe	2017.01.11	2018.01.10

**1.5.6 Vibration Table**

Vibration Table						
No.	Equipment Name	Serial No.	Type	Manufacturer	Cal.Date	Cal.Due Date
1	Vibration Table	N/A	ACT2000-S015L	CMI-COM	2017.01.11	2018.01.10

**1.5.7 Anechoic Chamber**

Anechoic Chamber						
No.	Equipment Name	Serial No.	Type	Manufacturer	Cal.Date	Cal.Due Date
1	Anechoic Chamber	N/A	9m*6m*6m	Changning	2017.01.11	2018.01.10

\*\*\*\*\* END OF REPORT \*\*\*\*\*