



Shenzhen GTI Technology Co., Ltd.

1F,2 Block, Jiaquan Building, Guanlan High-tech Park Baoan District,
Shenzhen, Guangdong, China.

Tel: +86-755-27559792

Fax: +86-755-86116468

Report No.: GTI20140490F-1

Page 1 of 60

TEST REPORT

Product Name: WCDMA Mobile Phone

Trademark: NUU

Model/Type reference: NU-3S

Listed Model(s): NU-3S series

Model difference: NU-3S other series model No. are all the same with main model NU-3S, except for body color, RAM and LOGO to meet different customer requirements

FCC ID.....: **2ADINNUUNU3S**

Test Standards: **FCC Part 22: PUBLIC MOBILE SERVICES**
FCC Part 24: PERSONAL COMMUNICATIONS SERVICES

Applicant: Sun Cupid Technology (HK) Ltd.

Address of Applicant.....: 16/F, CEO Tower, 77 Wing Hong St, Cheung Sha Wan,
Kowloon, Hong Kong

Date of Receipt: Oct.20, 2014

Date of Test Date.....: Oct.20, 2014 - Nov.13, 2014

Data of Issue.: Nov.14, 2014

Test result	Pass *
--------------------	---------------

* In the configuration tested, the EUT complied with the standards specified above

GENERAL DESCRIPTION OF EUT	
Equipment:	WCDMA Mobile Phone
Model Name:	NU-3S
Manufacturer:	Sun Cupid Technology (Shenzhen) Ltd.
Manufacturer Address:	10A, No.3 Bldg, China Academy of Sci & Tech Development, No.1 High-Tech South St. Nanshan district, Shenzhen, China.
Power Source:	DC 3.7V from 2050mAh Li-ion battery
Power Rating:	Input: 100-240VAC, 50/60Hz 0.2A MAX Output: 5V===1.0A

Compiled By:



(Allen Wang)

Reviewed By:

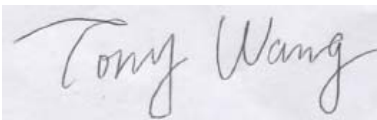

(Tony Wang)

Approved By:

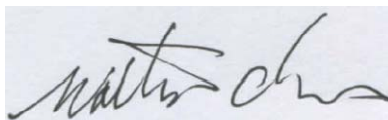

(Walter Chen)

This test report consists of 60 pages in total. It may be duplicated completely for legal use with the approval of the applicant. It should not be reproduced except in full, without the written approval of our laboratory. The client should not use it to claim product endorsement by GTI. The test results in the report only apply to the tested sample. The test report shall be invalid without all the signatures of testing engineers, reviewer and approver. Any objections must be raised to GTI within 15 days since the date when the report is received. It will not be taken into consideration beyond this limit.



Table of Contents

Page

1. SUMMARY.....	4
1.1. TEST STANDARDS.....	4
1.2. TEST DESCRIPTION.....	4
1.3. TEST FACILITY.....	5
1.4. MEASUREMENT UNCERTAINTY.....	5
2. GENERAL INFORMATION.....	6
2.1. ENVIRONMENTAL CONDITIONS.....	6
2.2. GENERAL DESCRIPTION OF EUT.....	6
2.3. DESCRIPTION OF TEST MODES AND TEST FREQUENCY.....	7
2.4. MEASUREMENT INSTRUMENTS LIST.....	7
3. TEST ITEM AND RESULTS.....	9
3.1. CONDUCTED EMISSIONS TEST.....	9
3.2. CONDUCTED OUTPUT POWER.....	12
3.3. OCCUPY BANDWIDTH.....	14
3.4. OUT OF BAND EMISSION AT ANTENNA TERMINALS.....	23
3.5. BAND EDGE COMPLIANCE.....	34
3.6. RADIATED POWER MEASUREMENT.....	39
3.7. RADIATED SPURIOUS EMISSION.....	43
3.8. FREQUENCY STABILITY.....	49
4. EUT TEST PHOTO.....	51
5. PHOTOGRAPHS OF EUT CONSTRUCTIONAL.....	52

1. SUMMARY

1.1. Test Standards

[FCC Part 22 \(10-1-13 Edition\)](#): PRIVATE LAND MOBILE RADIO SERVICES.

[FCC Part 24\(10-1-13 Edition\)](#): PUBLIC MOBILE SERVICES

[TIA/EIA 603 D June 2010](#): Land Mobile FM or PM Communications Equipment Measurement and Performance Standards.

[47 CFR FCC Part 15 Subpart B](#): - Unintentional Radiators

[FCC Part 2](#): FREQUENCY ALLOCATIONS AND RADIO TREATY MATTERS; GENERAL RULES AND REGULATIONS

[KDB971168 D01:2013-06-07](#) Procedures for Compliance Measurement of the Fundamental Emission Power of Licensed Wideband (> 1 MHz) Digital Transmission Systems

[ANSI C63.4:2009](#): Methods of Measurement of Radio-Noise Emissions from Low-Voltage Electrical and Electronic Equipment in the Range of 9 kHz to 40 GHz

1.2. Test Description

Test Item	Section in CFR 47	Result
AC Power Conducted Emission	Part 15.207	Pass
RF Output Power	Part 2.1046 Part 22.913 (a)(2) Part 24.232 (c)	Pass
Peak-to-Average Ratio	Part 24.232 (d)	Pass
Modulation Characteristics	Part 2.1047	Pass
99% & -26 dB Occupied Bandwidth	Part 2.1049 Part 22.917 Part 24.238	Pass
Spurious Emissions at Antenna Terminal	Part 2.1051 Part 22.917 (a) Part 24.238 (a)	Pass
Field Strength of Spurious Radiation	Part 2.1053 Part 22.917 (a) Part 24.238 (a)	Pass
Out of band emission, Band Edge	Part 22.917 (a) Part 24.238 (a)	Pass
Frequency stability vs. temperature	Part 2.1055(a)(1)(b)	Pass
Frequency stability vs. voltage	Part 2.1055(d)(1)(2)	Pass

Note:

1. The measurement uncertainty is not included in the test result.
2. This EUT owns two SIM cards, after we perform the pre-test for these two SIM cards; we found the SIM 1 is the worst case, so its result is recorded in this report.

1.3. Test Facility

1.3.1 Address of the test laboratory

Shenzhen General Testing & Inspection Technology Co., Ltd.

Add: 1F, 2 Block, Jiaquan Building, Guanlan High-tech Park Baoan District, Shenzhen, Guangdong, China

1.3.2 Laboratory accreditation

The test facility is recognized, certified, or accredited by the following organizations:

IC Registration No.: 9783A

The 3m alternate test site of Shenzhen GTI Technology Co., Ltd. EMC Laboratory has been registered by Certification and Engineer Bureau of Industry Canada for the performance of with Registration NO.: 9783A on Aug, 2011.

FCC-Registration No.: 214666

Shenzhen GTI Technology Co., Ltd. EMC Laboratory has been registered and fully described in a report filed with the (FCC) Federal Communications Commission. The acceptance letter from the FCC is maintained in our files. Registration 214666, Sep 19, 2011

1.4. Measurement Uncertainty

The data and results referenced in this document are true and accurate. The reader is cautioned that there may be errors within the calibration limits of the equipment and facilities. The measurement uncertainty was calculated for all measurements listed in this test report acc. to CISPR 16 - 4 Specification for radio disturbance and immunity measuring apparatus and methods – Part 4: Uncertainty in EMC Measurements and is documented in the Shenzhen General Testing & Inspection Technology Co., Ltd quality system acc. to DIN EN ISO/IEC 17025. Furthermore, component and process variability of devices similar to that tested may result in additional deviation. The manufacturer has the sole responsibility of continued compliance of the device.

Hereafter the best measurement capability for General Testing & Inspection laboratory is reported:

Test Items	Measurement Uncertainty	Notes
Frequency stability	25 Hz	(1)
Transmitter power conducted	0.57 dB	(1)
Transmitter power Radiated	2.20 dB	(1)
Conducted spurious emission 9KHz-12.75 GHz	1.60 dB	(1)
Conducted Emission 9KHz-30MHz	3.39 dB	(1)
Radiated Emission 30~1000MHz	4.24 dB	(1)
Radiated Emission 1~18GHz	5.16 dB	(1)
Radiated Emission 18-40GHz	5.54 dB	(1)
Occupied Bandwidth	-----	(1)
Emission Mask	-----	(1)
Modulation Characteristic	-----	(1)
Transmitter Frequency Behavior	-----	(1)

(1) This uncertainty represents an expanded uncertainty expressed at approximately the 95% confidence level using a coverage factor of k=1.96.

2. GENERAL INFORMATION

2.1. Environmental conditions

During the measurement the environmental conditions were within the listed ranges:

Normal Temperature:	25°C
Relative Humidity:	55 %
Air Pressure:	101 kPa

2.2. General Description of EUT

Product Name:	WCDMA Mobile Phone
Model/Type reference:	NU-3S
Power supply:	DC 3.7V from 2050mAh Li-ion battery
Adapter information:	Model: HNFG050100UU Input: 100-240VAC, 50/60Hz 0.2A MAX Output: 5V---1.0A
Hardware version:	UA1209 VER.A
Software version:	3S-US-01
2G	
Operation Band:	GSM850, PCS1900
Supported Type:	GSM/GPRS/EGPRS
Power Class:	GSM850:Power Class 4 PCS1900:Power Class 1
Modulation Type:	GMSK for GSM/GPRS GMSK/8PSK(only downlink) for EGPRS
GSM Release Version	R99
GPRS Multislot Class	12
EGPRS Multislot Class	12
WCDMA	
Operation Band:	FDD Band II & Band V
Power Class:	Power Class 3
Modulation Type:	QPSK for WCDMA/HSUPA/HSDPA
WCDMA Release Version:	R8
HSDPA Release Version:	Category 14
HSUPA Release Version:	Category 6
DC-HSUPA Release Version:	Not Supported

2.3. Description of Test Modes and Test Frequency

The EUT has been tested under typical operating condition. The CUM200 used to control the EUT staying in continuous transmitting and receiving mode for testing.

Test Frequency:

GSM 850		PCS1900	
Channel	Frequency (MHz)	Channel	Frequency (MHz)
128	824.20	512	1850.20
190	836.60	661	1880.00
251	848.80	810	1909.80

FDD Band II		FDD Band V	
Channel	Frequency (MHz)	Channel	Frequency (MHz)
9262	1852.4	4132	826.40
9400	1880.0	4182	836.60
9538	1907.6	4233	846.60

2.4. Measurement Instruments List

Output Power (Radiated) & Radiated Spurious Emission					
Item	Test Equipment	Manufacturer	Model No.	Serial No.	Calibrated until
1	EMI Test Receiver	R&S	ESCI	100967	Dec 27, 2014
2	High pass filter	Compliance Direction systems	BSU-6	34202	Oct 25,2015
3	Log-Bicon Antenna	Schwarzbeck	CBL6141A	4180	Dec 27, 2014
4	Log-Bicon Antenna	Schwarzbeck	CBL6141A	4181	Dec 27, 2014
5	Spectrum Analyzer	HP	8563E	02052	Dec 27, 2014
6	Horn Antenna	Schwarzbeck	BBHA 9120D	648	Dec 27, 2014
7	Horn Antenna	Schwarzbeck	BBHA 9120D	649	Dec 27, 2014
8	Ultra-Broadband Antenna	ShwarzBeck	BBHA9170	25841	Dec 27,2014
9	Ultra-Broadband Antenna	ShwarzBeck	BBHA9170	25842	Dec 27,2014
10	Pre-Amplifier	HP	8447D	1937A03050	Dec 26, 2014
11	Pre-Amplifier	EMCI	EMC051835	980075	Dec 27, 2014
12	Splitter	Mini-Circuit	ZAPD-4	400059	Dec. 26, 2014
13	Signal Generator	Agilent	N5182A	1019356	Dec. 26, 2014
14	UNIVERSAL RADIO COMMUNICATION	Rohde & Schwarz	CMU200	114694	March,15,2015
15	Antenna Mast	UC	UC3000	N/A	N/A
16	Turn Table	UC	UC3000	N/A	N/A
17	Cable	Schwarzbeck	Cable002	--	Dec. 26,2014
18	Cable	Schwarzbeck	Cable003	--	Dec. 26,2014

AC Power Conducted Emission					
Item	Test Equipment	Manufacturer	Model No.	Serial No.	Calibrated until
1	LISN	R&S	ENV216	101112	Dec. 26, 2014
2	LISN	R&S	ENV216	101113	Dec. 26, 2014
3	EMI Test Receiver	R&S	ESCI	100920	Dec. 26, 2014
4	UNIVERSAL RADIO COMMUNICATION	Rohde & Schwarz	CMU200	114694	March,15,2015
5	Cable	Schwarzbeck	Cable001	--	Dec. 26, 2014

Output Power(Conducted) & Occupied Bandwidth & Emission Bandwidth & Band Edge Compliance & Conducted Spurious Emission					
Item	Test Equipment	Manufacturer	Model No.	Serial No.	Calibrated until
1	Power Meter	Anritsu	ML2487B	110553	July 10,2015
2	Power Sensor	Anritsu	MA2411B	100345	July 10,2015
3	UNIVERSAL RADIO COMMUNICATION	Rohde & Schwarz	CMU200	114694	March,15,2015
4	Spectrum Analyzer	Rohde & Schwarz	FSU	100105	Dec. 27, 2014
5	Splitter	Mini-Circuit	ZAPD-4	400059	Dec. 26, 2014

Frequency Stability					
Item	Test Equipment	Manufacturer	Model No.	Serial No.	Calibrated until
1	UNIVERSAL RADIO COMMUNICATION	Rohde & Schwarz	CMU200	114694	March,15,2015
2	Spectrum Analyzer	Rohde & Schwarz	FSU	100105	Dec. 27, 2014
3	Splitter	Mini-Circuit	ZAPD-4	400059	Dec. 26, 2014
4	Climate Chamber	ESPEC	EL-10KA	05107008	Oct 25,2015

Note: 1. The Cal. Interval was one year.

2. The cable loss has calculated in test result which connection between each test instruments.

3. TEST ITEM AND RESULTS

3.1. Conducted Emissions Test

LIMIT:

Frequency of Emission (MHz)	Conducted Limit (dBuV)	
	Quasi-peak	Average
0.15-0.5	66 to 56 *	56 to 46 *
0.5-5	56	46
5-30	60	50

* Decreasing linearly with the logarithm of the frequency

TEST CONFIGURATION

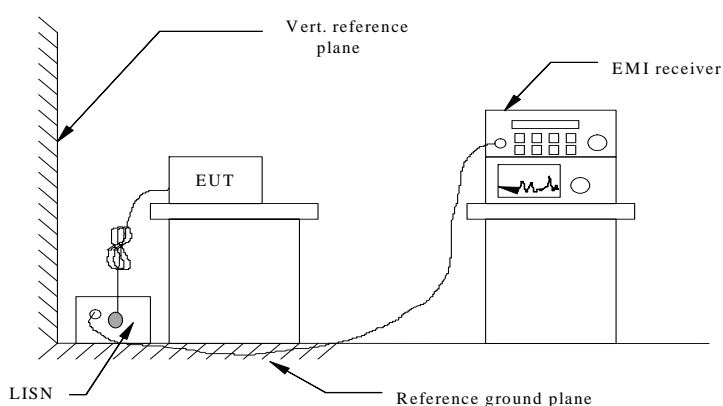

TEST PROCEDURE

- 1 The equipment was set up as per the test configuration to simulate typical actual usage per the user’s manual. The EUT is a tabletop system; a wooden table with a height of 0.8 meters is used and is placed on the ground plane as per ANSI C63.4-2009.
- 2 Support equipment, if needed, was placed as per ANSI C63.4-2009.
- 3 All I/O cables were positioned to simulate typical actual usage as per ANSI C63.4-2009.
- 4 If a EUT received DC power from the adapter, the adapter received AC120V/60Hz power through a Line Impedance Stabilization Network (LISN) which supplied power source and was grounded to the ground plane.
- 5 All support equipments received AC power from a second LISN, if any.
- 6 The EUT test program was started. Emissions were measured on each current carrying line of the EUT using a spectrum Analyzer / Receiver connected to the LISN powering the EUT. The LISN has two monitoring points: Line 1 (Hot Side) and Line 2 (Neutral Side). Two scans were taken: one with Line 1 connected to Analyzer / Receiver and Line 2 connected to a 50 ohm load; the second scan had Line 1 connected to a 50 ohm load and Line 2 connected to the Analyzer / Receiver.
- 7 Analyzer / Receiver scanned from 150 KHz to 30MHz for emissions in each of the test modes.
- 8 During the above scans, the emissions were maximized by cable manipulation.

TEST RESULTS

Note: We tested all modes and recorded the worst case at GSM850

Test mode:	GSM850	Polarization:	L
-------------------	--------	----------------------	---

SCAN TABLE: "Voltage (9K-30M) FIN1"
 Short Description: 150K-30M Voltage

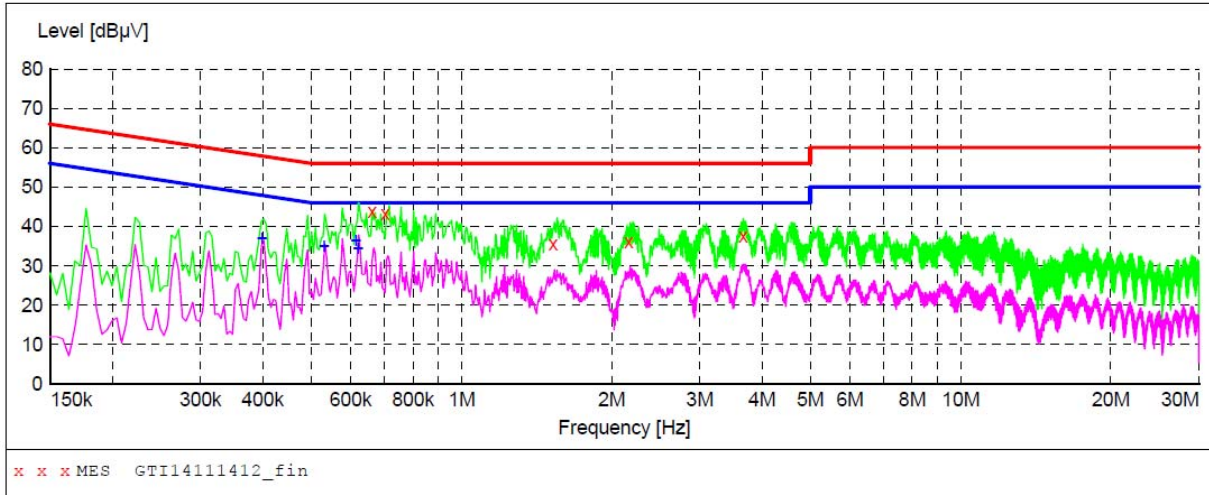

MEASUREMENT RESULT: "GTI14111412_fin"

11/14/2014 1:38PM

Frequency MHz	Level dBµV	Transd dB	Limit dBµV	Margin dB	Detector	Line	PE
0.662000	43.80	10.0	56	12.2	QP	L1	GND
0.704000	43.10	10.0	56	12.9	QP	L1	GND
1.526000	35.60	10.3	56	20.4	QP	L1	GND
2.162000	36.00	10.4	56	20.0	QP	L1	GND
3.668000	37.40	10.5	56	18.6	QP	L1	GND

MEASUREMENT RESULT: "GTI14111412_fin2"

11/14/2014 1:38PM

Frequency MHz	Level dBµV	Transd dB	Limit dBµV	Margin dB	Detector	Line	PE
0.398000	36.90	9.9	48	11.0	AV	L1	GND
0.530000	35.10	9.9	46	10.9	AV	L1	GND
0.614000	36.50	9.9	46	9.5	AV	L1	GND
0.620000	34.30	9.9	46	11.7	AV	L1	GND

Test mode:	GSM850	Polarization:	N
-------------------	---------------	----------------------	----------

SCAN TABLE: "Voltage (9K-30M) FIN1"
 Short Description: 150K-30M Voltage

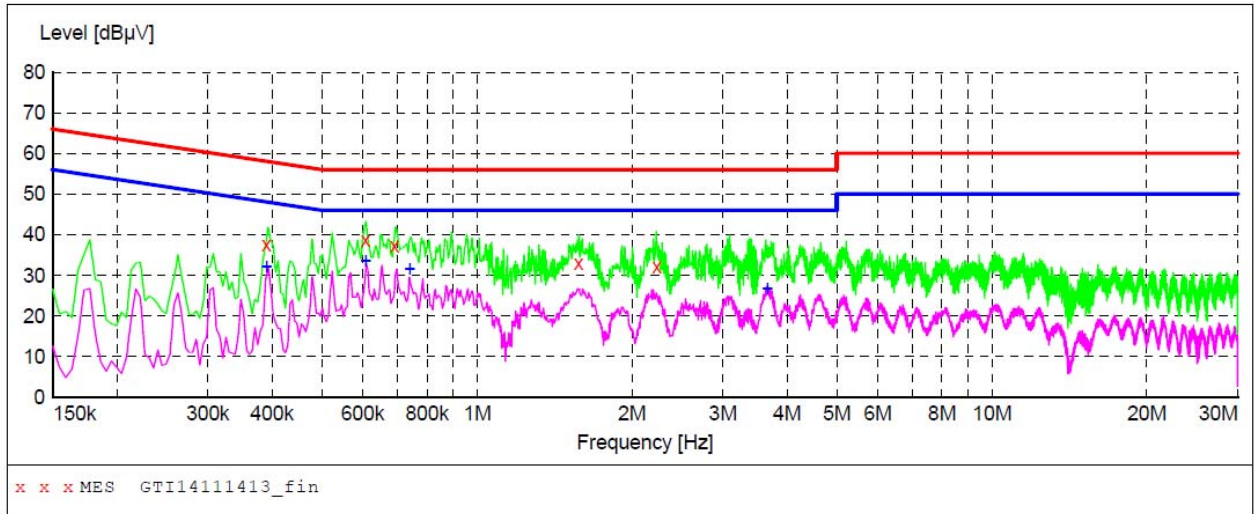

MEASUREMENT RESULT: "GTI14111413_fin"

11/14/2014 1:42PM

Frequency MHz	Level dBµV	Transd dB	Limit dBµV	Margin dB	Detector	Line	PE
0.390000	37.40	9.9	58	20.7	QP	N	GND
0.608000	38.80	9.9	56	17.2	QP	N	GND
0.692000	37.30	10.0	56	18.7	QP	N	GND
1.574000	33.10	10.3	56	22.9	QP	N	GND
2.234000	32.00	10.4	56	24.0	QP	N	GND

MEASUREMENT RESULT: "GTI14111413_fin2"

11/14/2014 1:42PM

Frequency MHz	Level dBµV	Transd dB	Limit dBµV	Margin dB	Detector	Line	PE
0.390000	32.10	9.9	48	16.0	AV	N	GND
0.608000	33.50	9.9	46	12.5	AV	N	GND
0.740000	31.60	10.0	46	14.4	AV	N	GND
3.662000	26.80	10.5	46	19.2	AV	N	GND

3.2. Conducted Output Power

LIMIT:

GSM850/WCDMA Band V: 7W

PCS1900/WCDMA Band II: 2W

The Peak-to-Average Ratio (PAR) of the transmission may not exceed 13 dB.

TEST CONFIGURATION

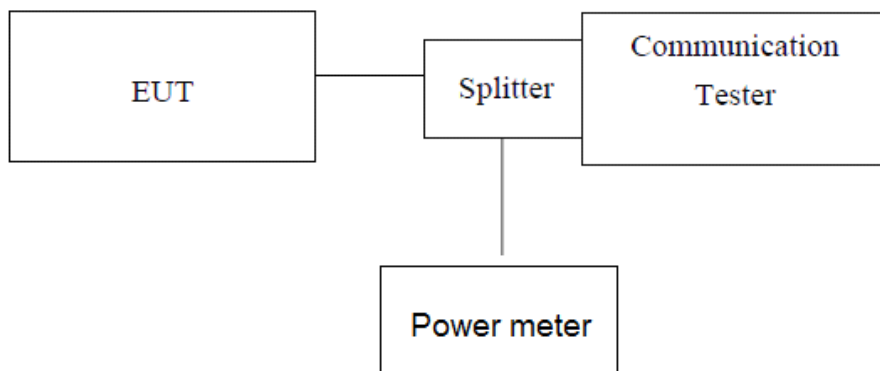

Note: Measurement setup for testing on Antenna connector

TEST PROCEDURE

1. The transmitter output port was connected to base station.
2. The RF output of EUT was connected to the power meter by RF cable and attenuator, the path loss was compensated to the results for each measurement.
3. Set EUT at maximum power through base station.
4. Select lowest, middle, and highest channels for each band and different modulation.
5. Measure the maximum PK burst power and maximum Avg. burst power.

TEST RESULTS

EUT Mode	Channel	Frequency (MHz)	Avg.Burst Power (dBm)	Peak-to-Average Ratio (dB)	Limit (dBm)	Result
GSM 850 (GMSK)	128	824.20	32.57	/	38.45	Pass
	190	836.60	32.41	/		
	251	848.80	32.39	/		
GPRS850 (GMSK,1Slot)	128	824.20	32.54	/	38.45	Pass
	190	836.60	32.29	/		
	251	848.80	32.25	/		
EGPRS850 (GMSK,1Slot)	128	824.20	32.36	/	38.45	Pass
	190	836.60	32.47	/		
	251	848.80	32.57	/		
PCS1900 (GMSK)	512	1850.20	30.23	0.34	33.01	Pass
	661	1880.00	30.47	0.37		
	810	1909.80	30.55	0.40		



GPRS1900 (GMSK, 1Slot)	512	1850.20	30.24	0.35	33.01	Pass
	661	1880.00	30.65	0.41		
	810	1909.80	30.31	0.36		
EGPRS1900 (GMSK, 1Slot)	512	1850.20	30.14	0.40	33.01	Pass
	661	1880.00	30.78	0.39		
	810	1909.80	30.25	0.42		
WCDMA Band II (QPSK)	9262	1852.40	23.54	3.27	33.01	Pass
	9400	1880.00	23.66	3.35		
	9538	1907.60	23.24	3.27		
WCDMA Band V (QPSK)	4132	826.40	23.23	/	38.45	Pass
	4183	836.60	23.47	/		
	4233	846.60	23.78	/		

Note: 1. Peak-to-Average Ratio= maximum PK burst power-maximum Avg. burst power.

3.3. Occupy Bandwidth

TEST CONFIGURATION

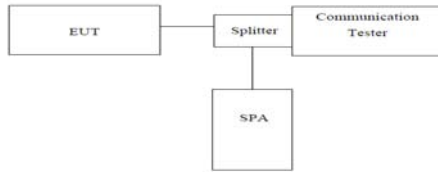

Note: Measurement setup for testing on Antenna connector

TEST PROCEDURE

1. The EUT's output RF connector was connected with a short cable to the spectrum analyzer
2. RBW was set to about 1% of emission BW, VBW ≥ 3 times RBW.
3. -26dBc display line was placed on the screen (or 99% bandwidth), the occupied bandwidth is the delta frequency between the two points where the display line intersects the signal trace.

TEST RESULTS

EUT Mode	Channel	Frequency (MHz)	99% Occupy bandwidth (KHz)	-26dB bandwidth (KHz)
GSM 850 (GMSK)	128	824.20	239.58	312.50
	190	836.60	241.19	311.70
	251	848.80	244.39	310.10
GPRS850 (GMSK,1Slot)	128	824.20	241.19	311.70
	190	836.60	242.79	310.90
	251	848.80	241.19	313.30
EGPRS850 (GMSK,1Slot)	128	824.20	241.19	312.50
	190	836.60	239.58	311.70
	251	848.80	241.99	311.70
PCS1900 (GMSK)	512	1850.20	246.80	316.51
	661	1880.00	249.20	313.30
	810	1909.80	245.99	312.50
GPRS1900 (GMSK,1Slot)	512	1850.20	245.19	318.11
	661	1880.00	245.99	315.71
	810	1909.80	245.99	318.11
EGPRS1900 (GMSK,1Slot)	512	1850.20	245.99	313.30
	661	1880.00	244.39	316.51
	810	1909.80	244.39	313.30
WCDMA Band II (QPSK)	9262	1852.4	4246.80	4855.77
	9400	1880.0	4166.67	4679.49
	9538	1907.6	4132.69	4695.51
WCDMA Band V (QPSK)	4132	826.4	4166.67	4695.51
	4183	836.6	4166.67	4695.51
	4233	846.6	4246.79	4775.64

Test plots as follow:

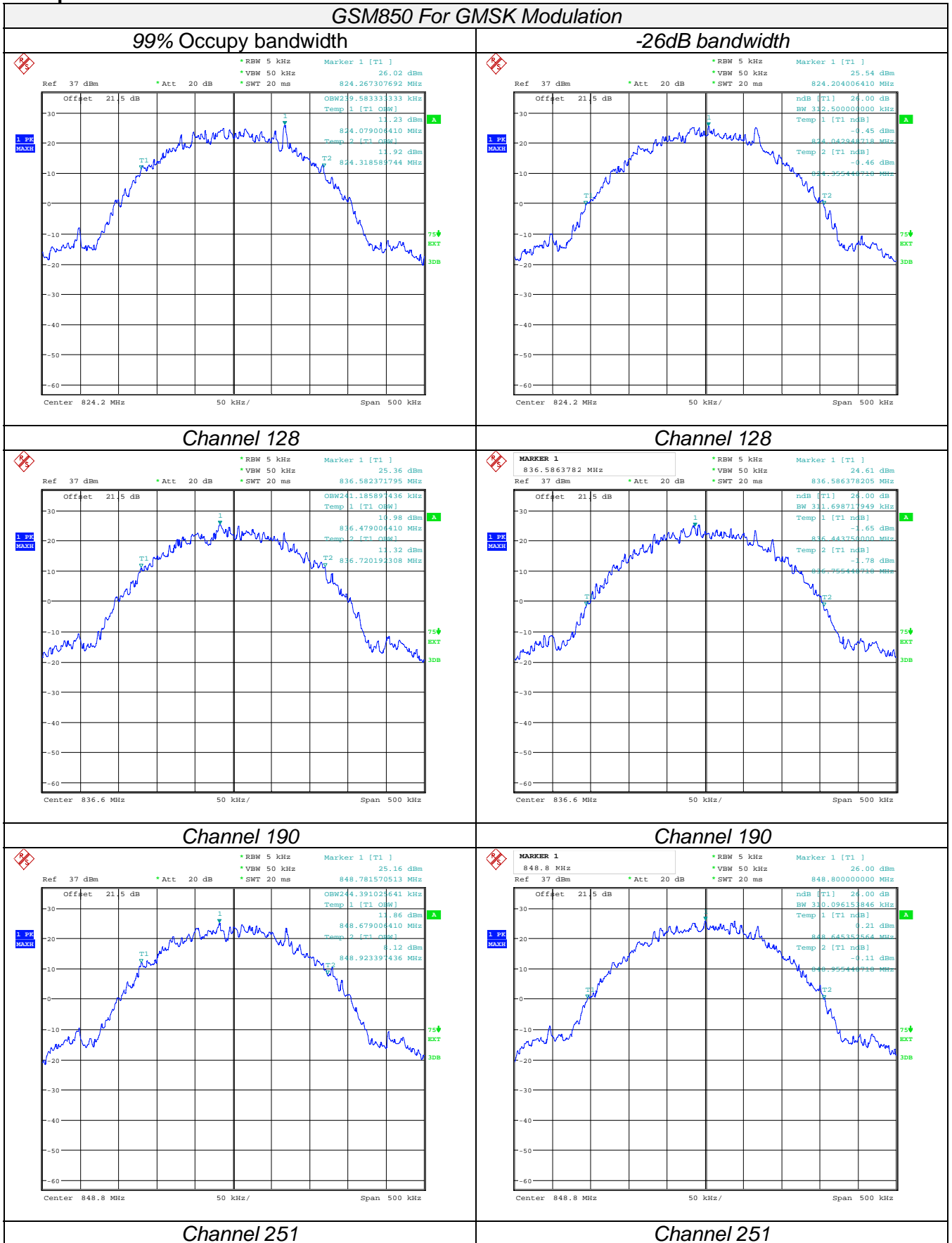

GPRS850 For GMSK Modulation

99% Occupancy bandwidth

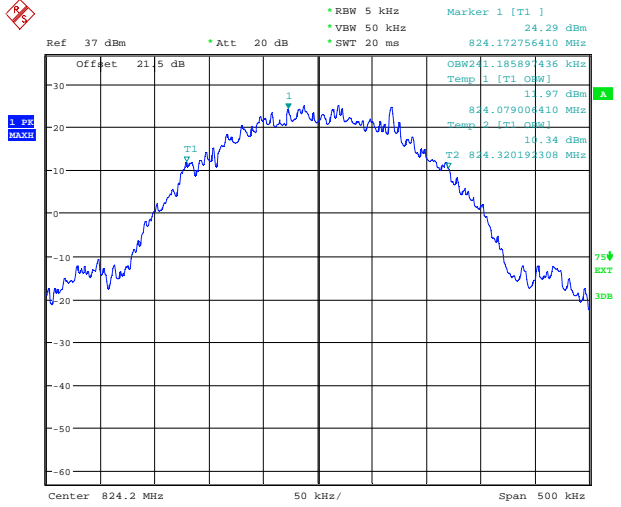

-26dB bandwidth

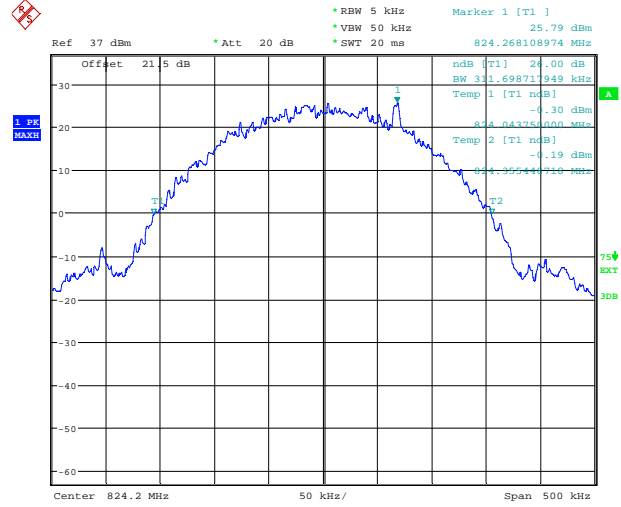

Channel 128

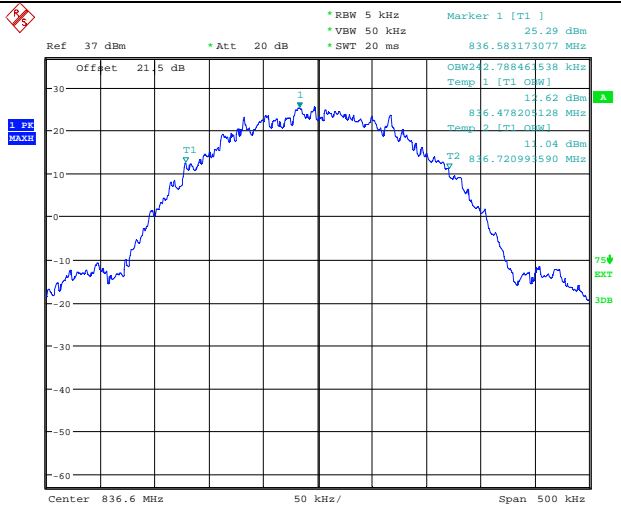

Channel 128

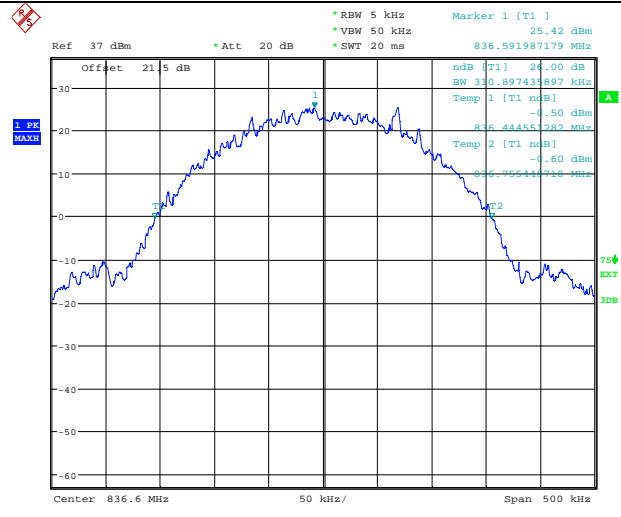

Channel 190

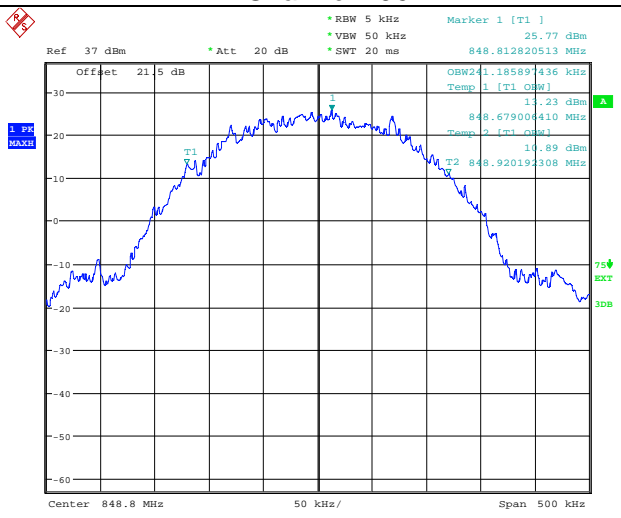

Channel 190

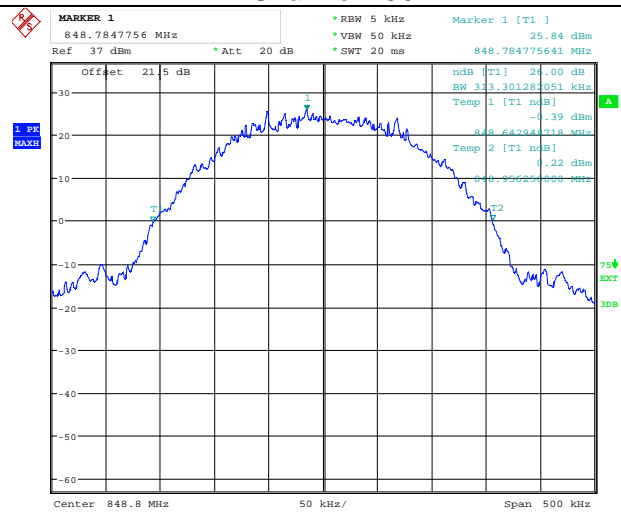

Channel 251

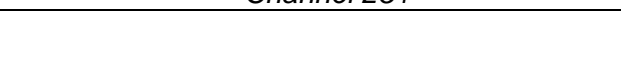

Channel 251

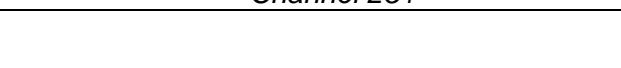

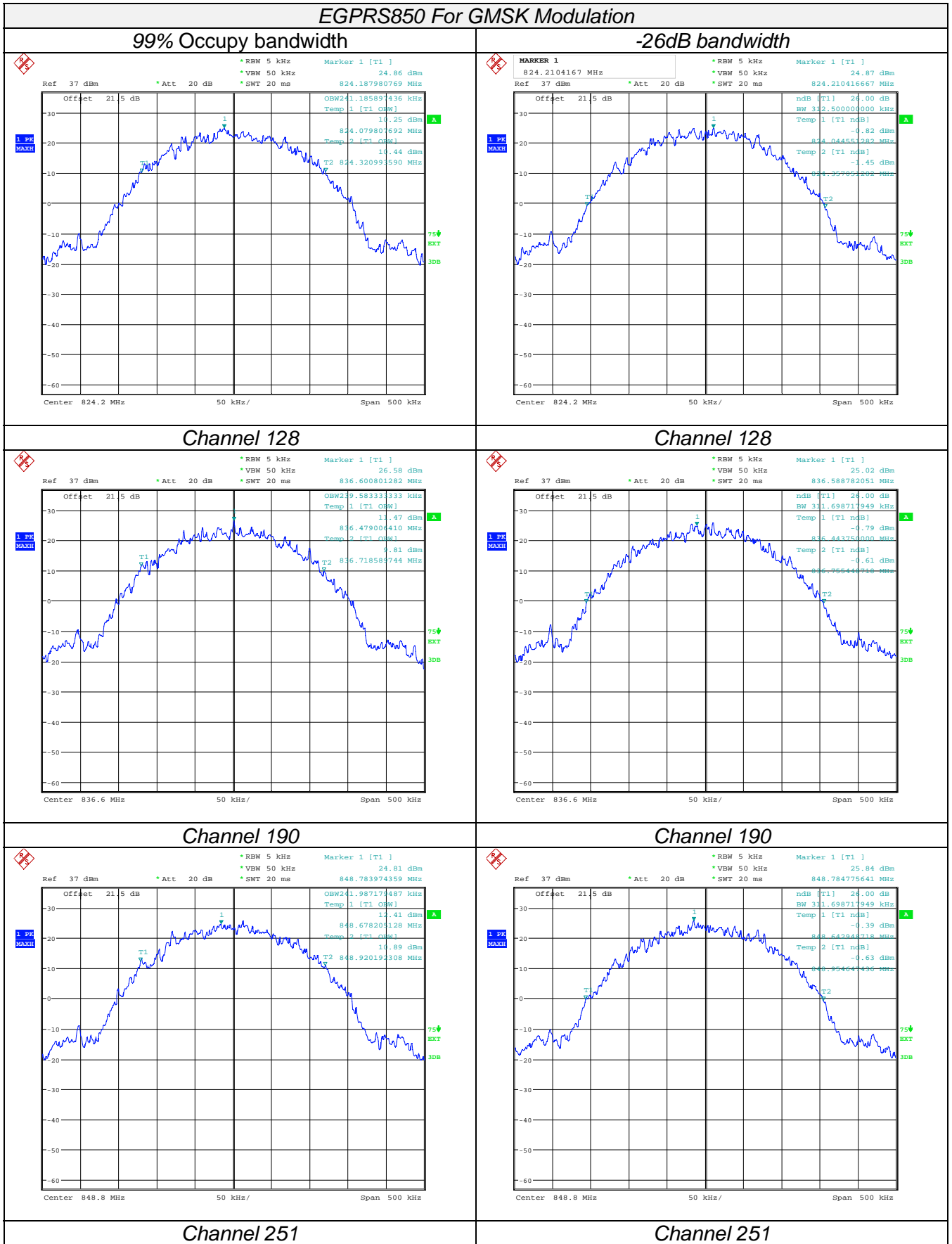

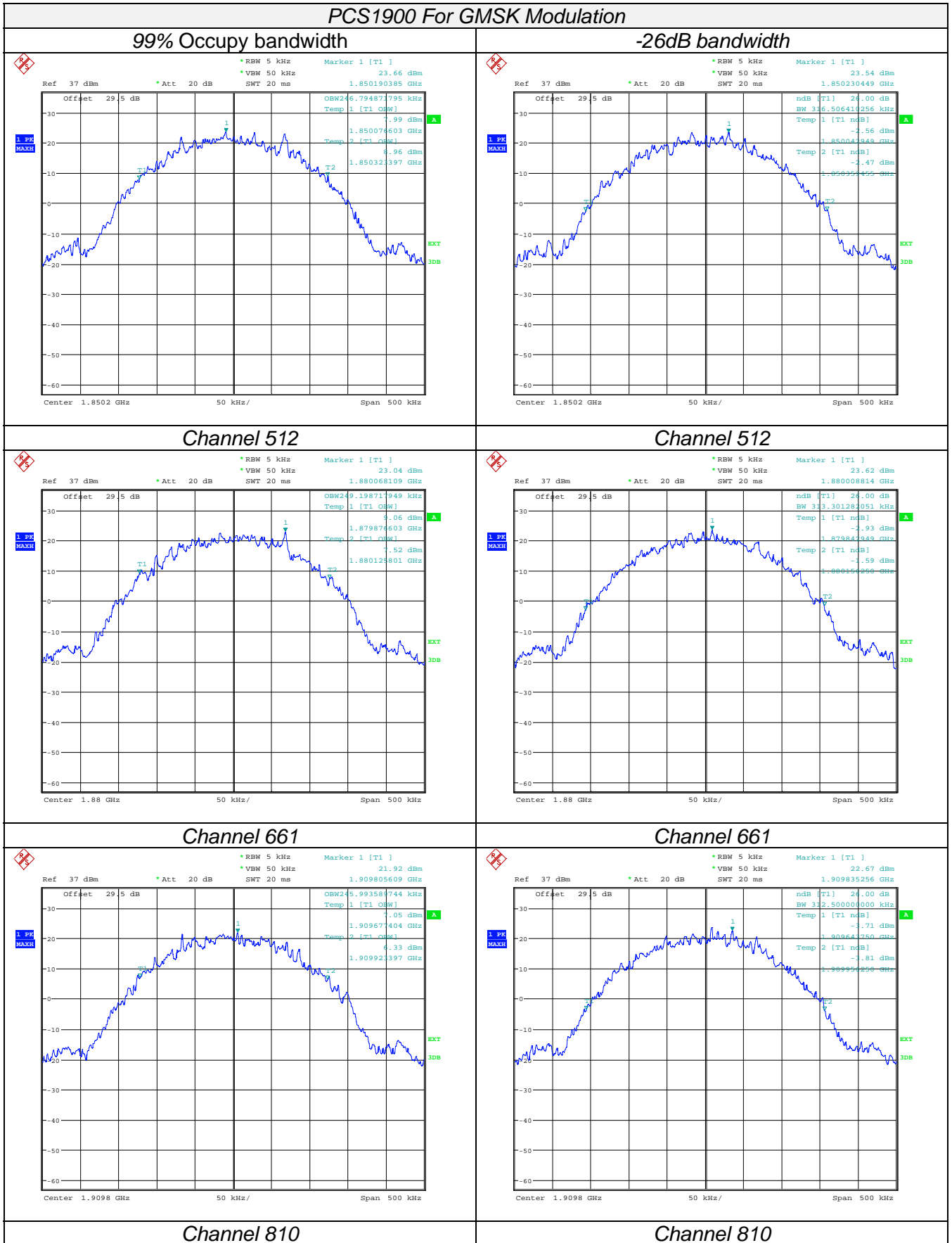

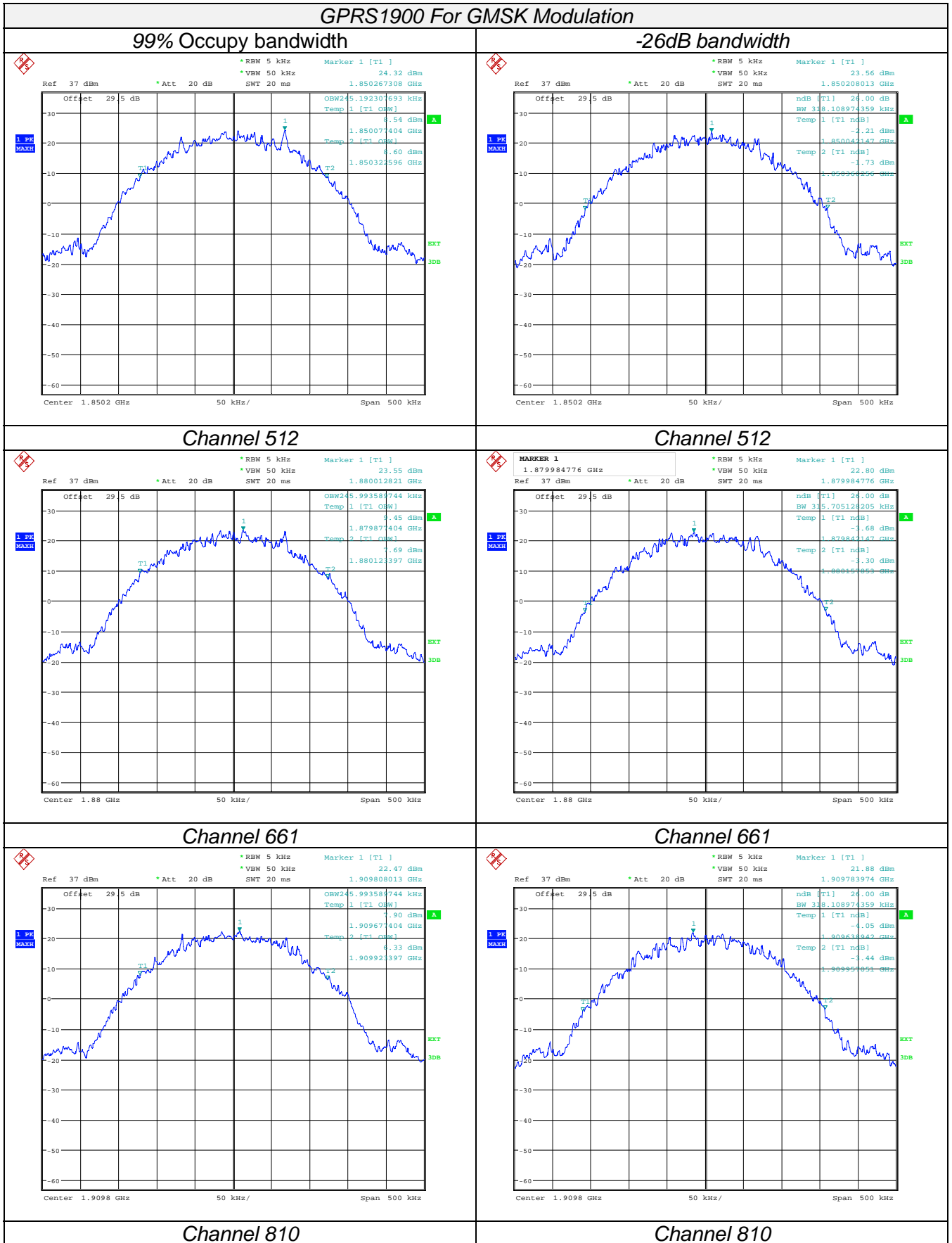

EGPRS1900 For GMSK Modulation

99% Occupancy bandwidth

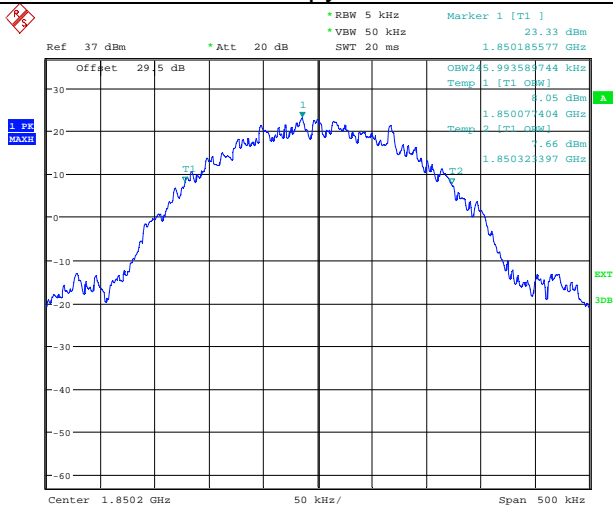

-26dB bandwidth

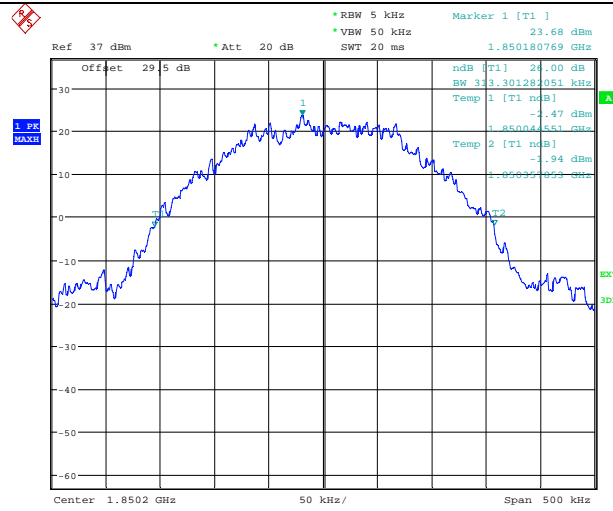

Channel 512

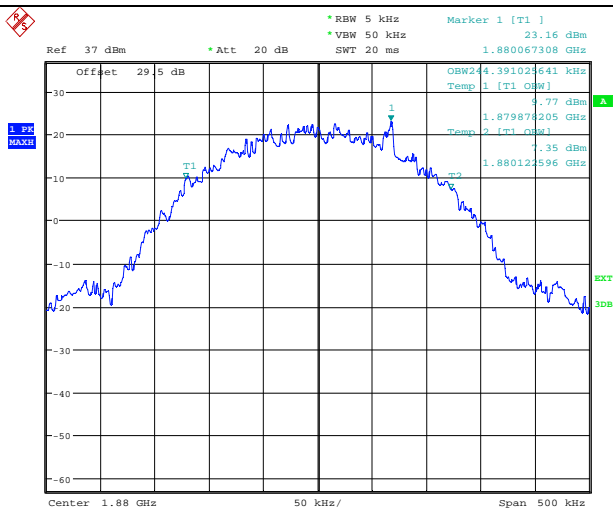

Channel 512

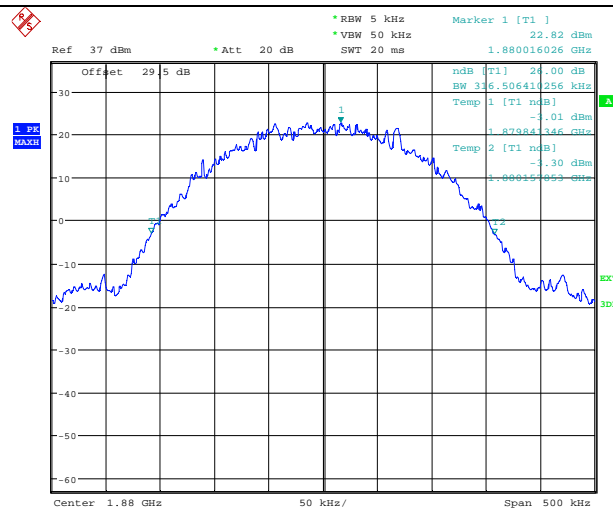

Channel 661

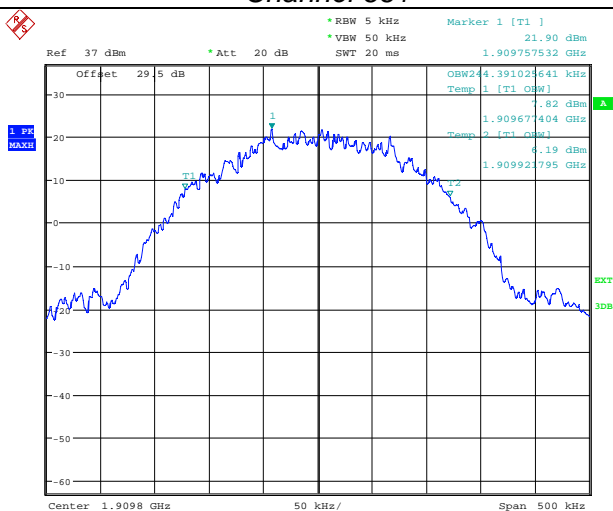

Channel 661

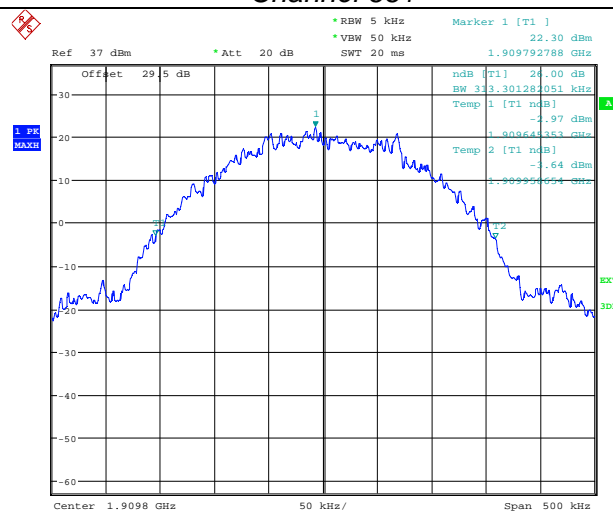

Channel 810



Channel 810



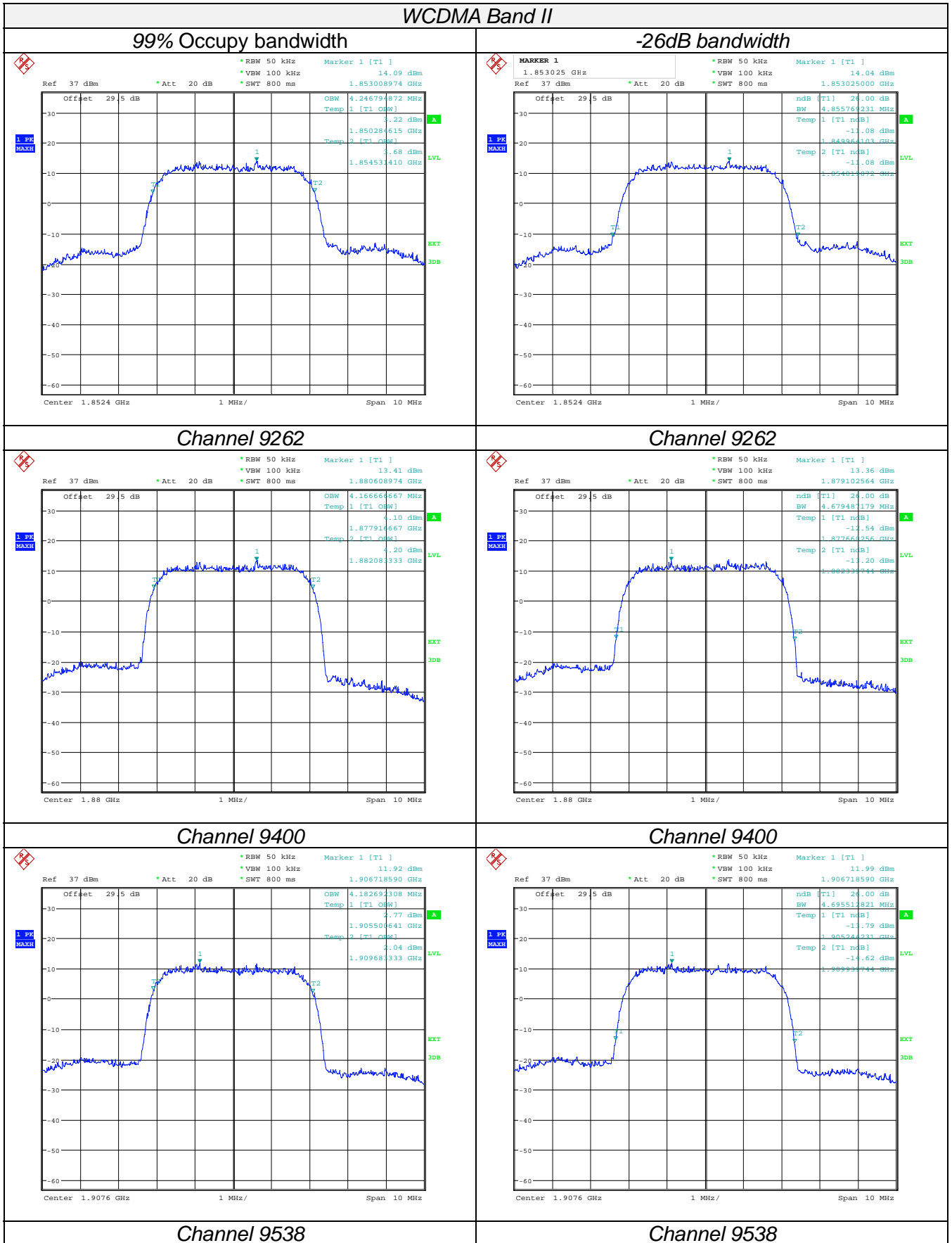

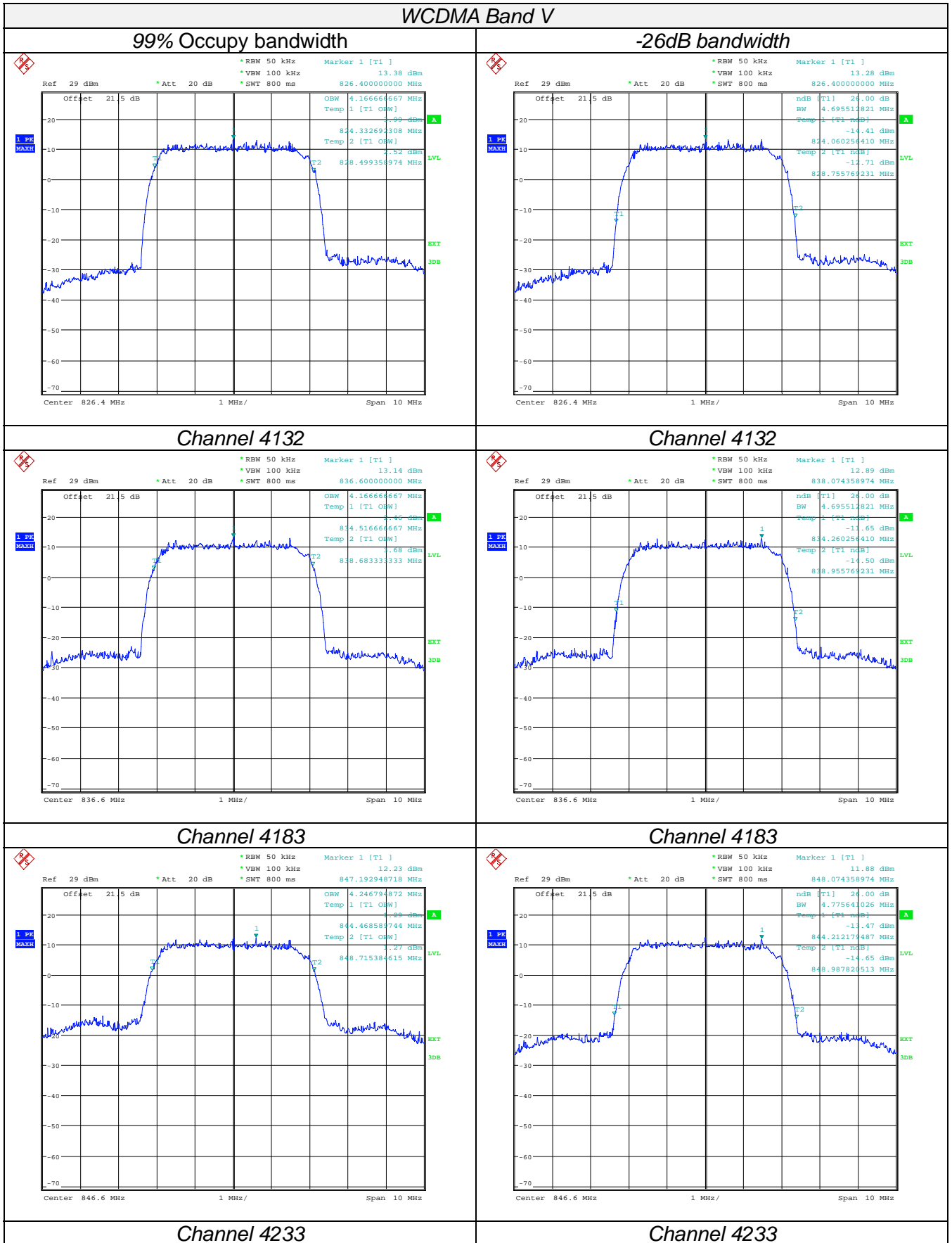

3.4. Out of band emission at antenna terminals

LIMIT

Part 24.238 and Part 22.917 specify that the power of any emission outside of the authorized operating frequency ranges must be attenuated below the transmitting power (P) by a factor of at least $43 + 10 \log(P)$ dB.

The specification that emissions shall be attenuated below the transmitter power (P) by at least $43 + 10 \log(P)$ dB, translates in the relevant power range (1 to 0.001 W) to -13 dBm. At 1 W the specified minimum attenuation becomes 43 dB and relative to a 30 dBm (1 W) carrier becomes a limit of -13 dBm. At 0.001 W (0 dBm) the minimum attenuation is 13 dB, which again yields a limit of -13 dBm. In this way a translation of the specification from relative to absolute terms is carried out.

TEST CONFIGURATION

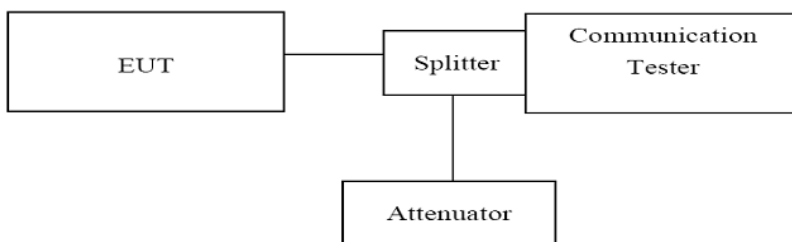

TEST PROCEDURE

1. The RF output of the transceiver was connected to a spectrum analyzer through appropriate attenuation.
2. The resolution bandwidth of the spectrum analyzer was set at 1MHz; sufficient scans were taken to show the out of band Emissions if any up to 10th harmonic.
3. For the out of band: Set the RBW = 1MHz VBW \geq 3 times RBW, Start=30MHz, Stop= 10th harmonic.

TEST RESULTS

Remark: we test all modulation type and record worst case at Voice mode.

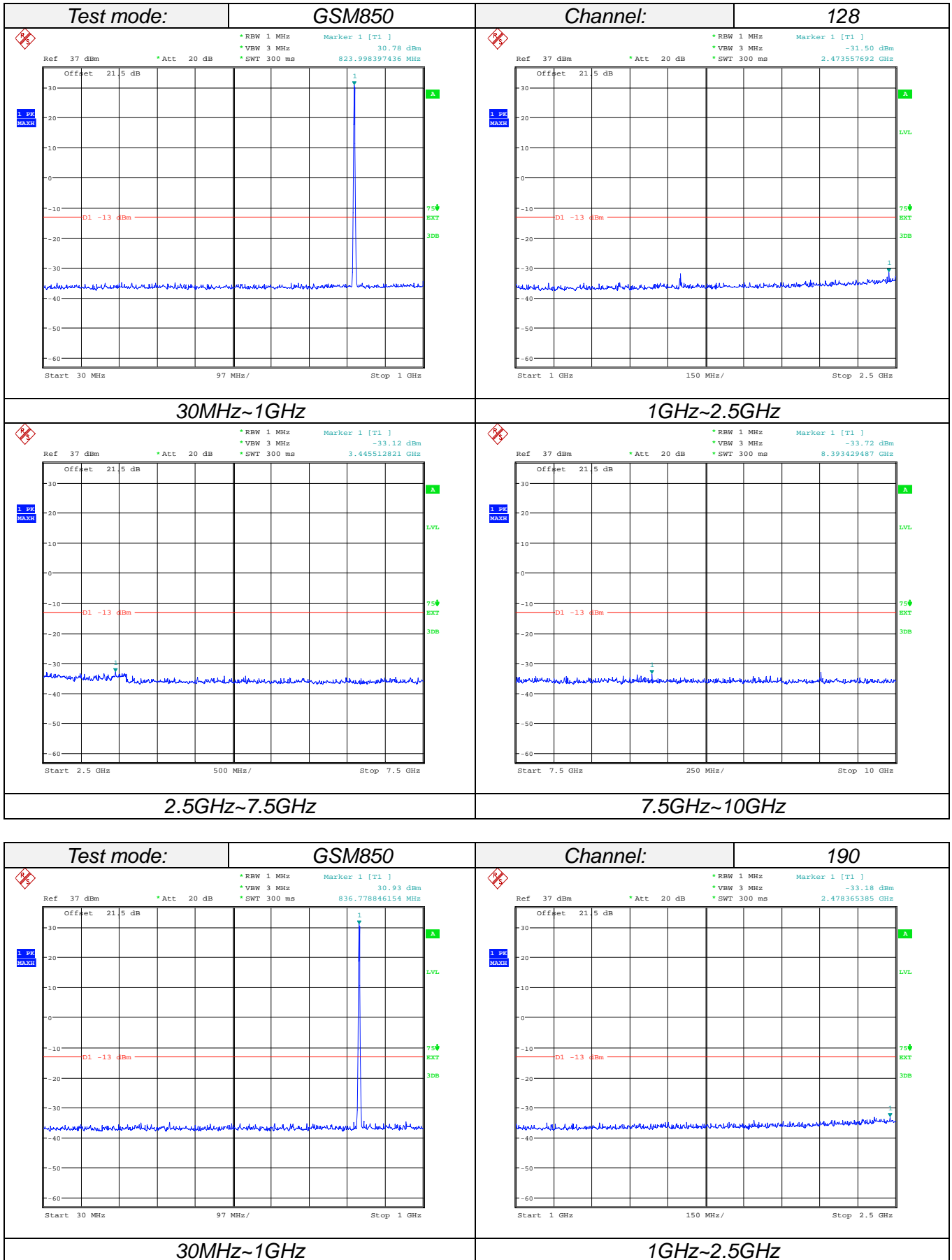

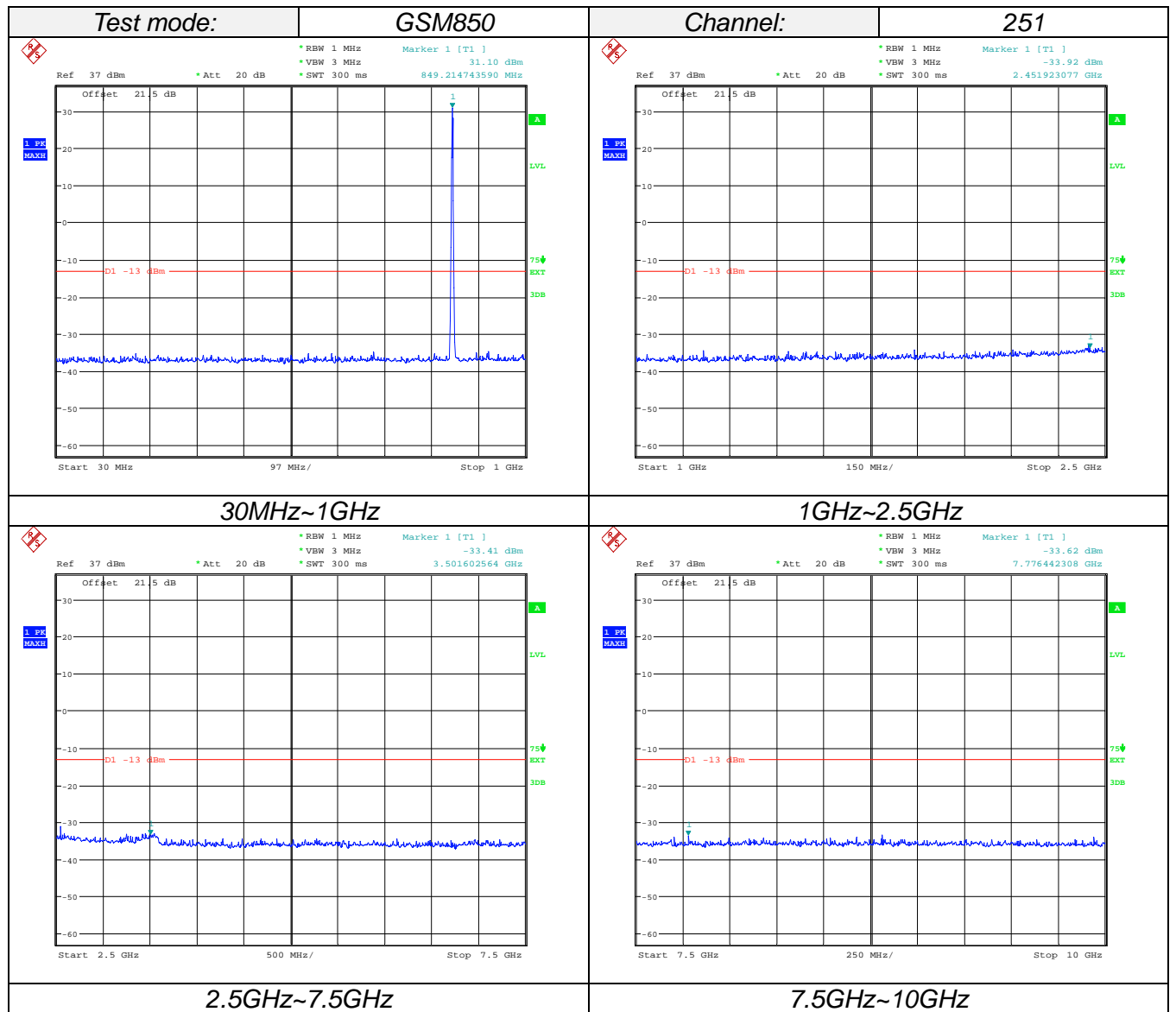
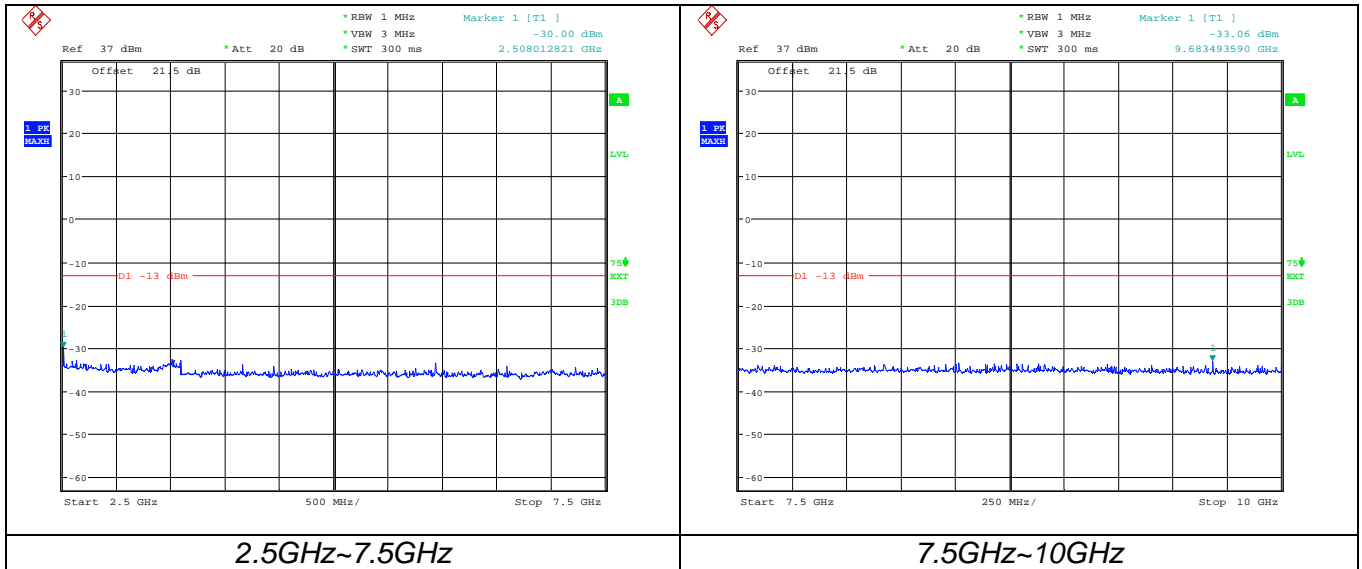

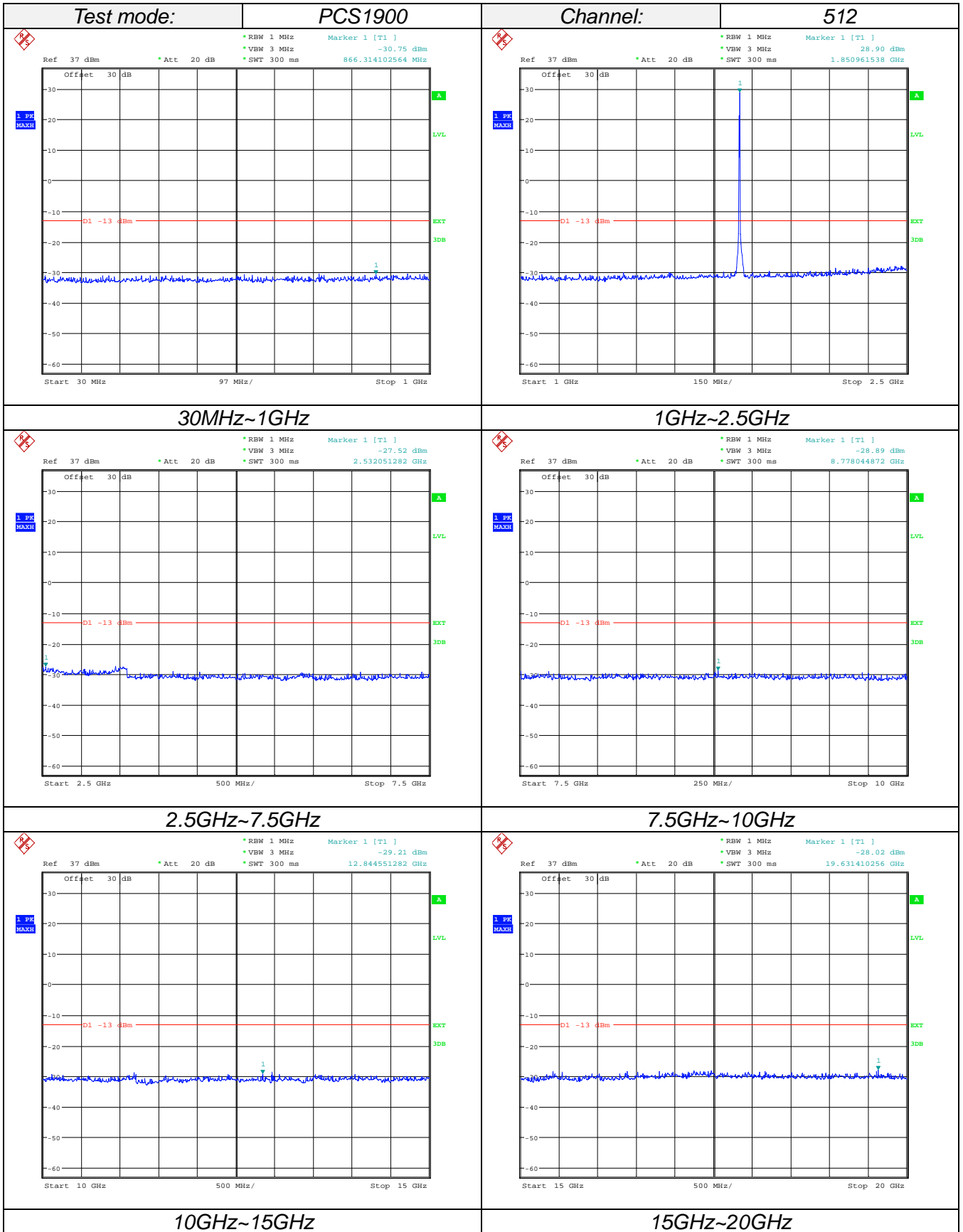

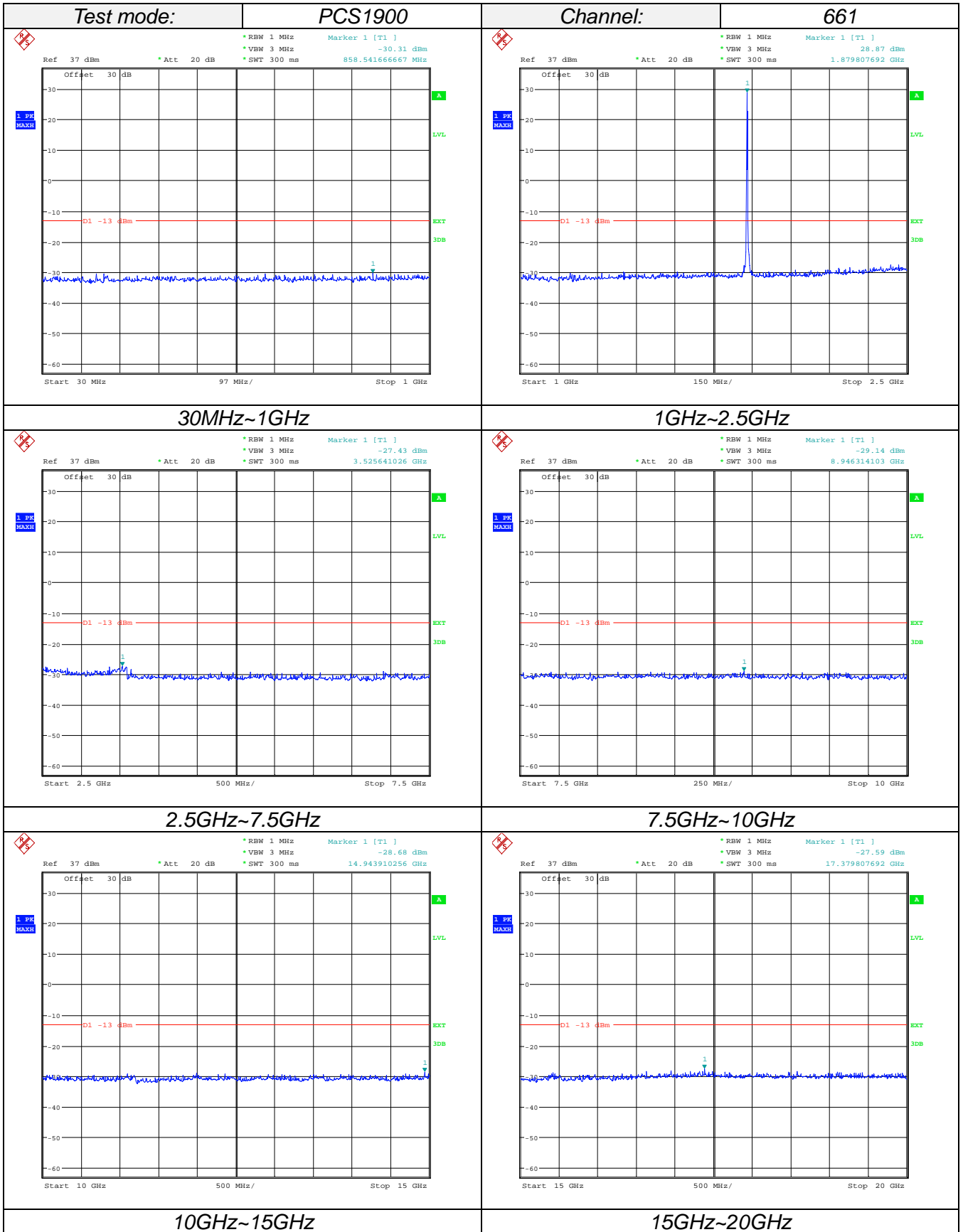

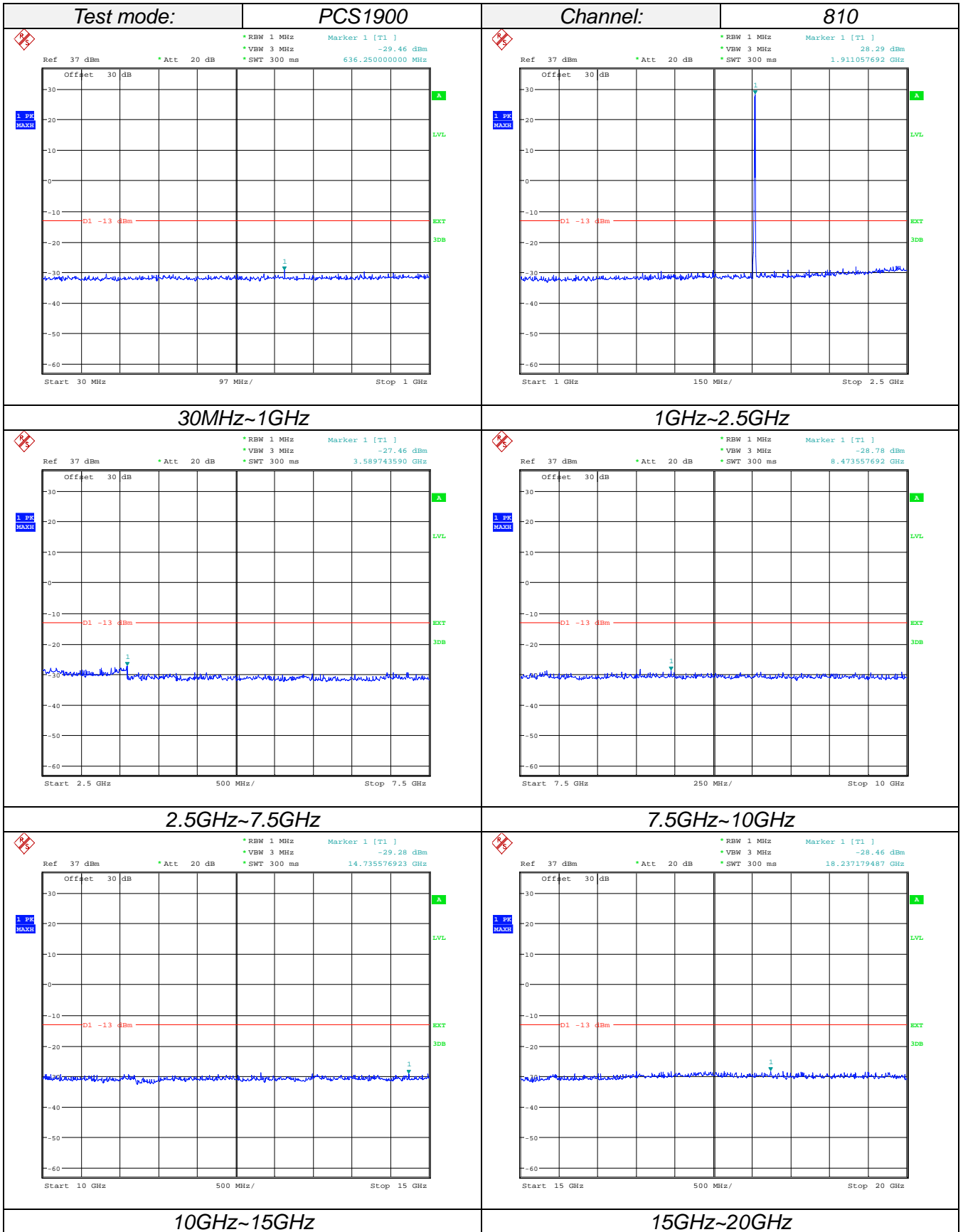

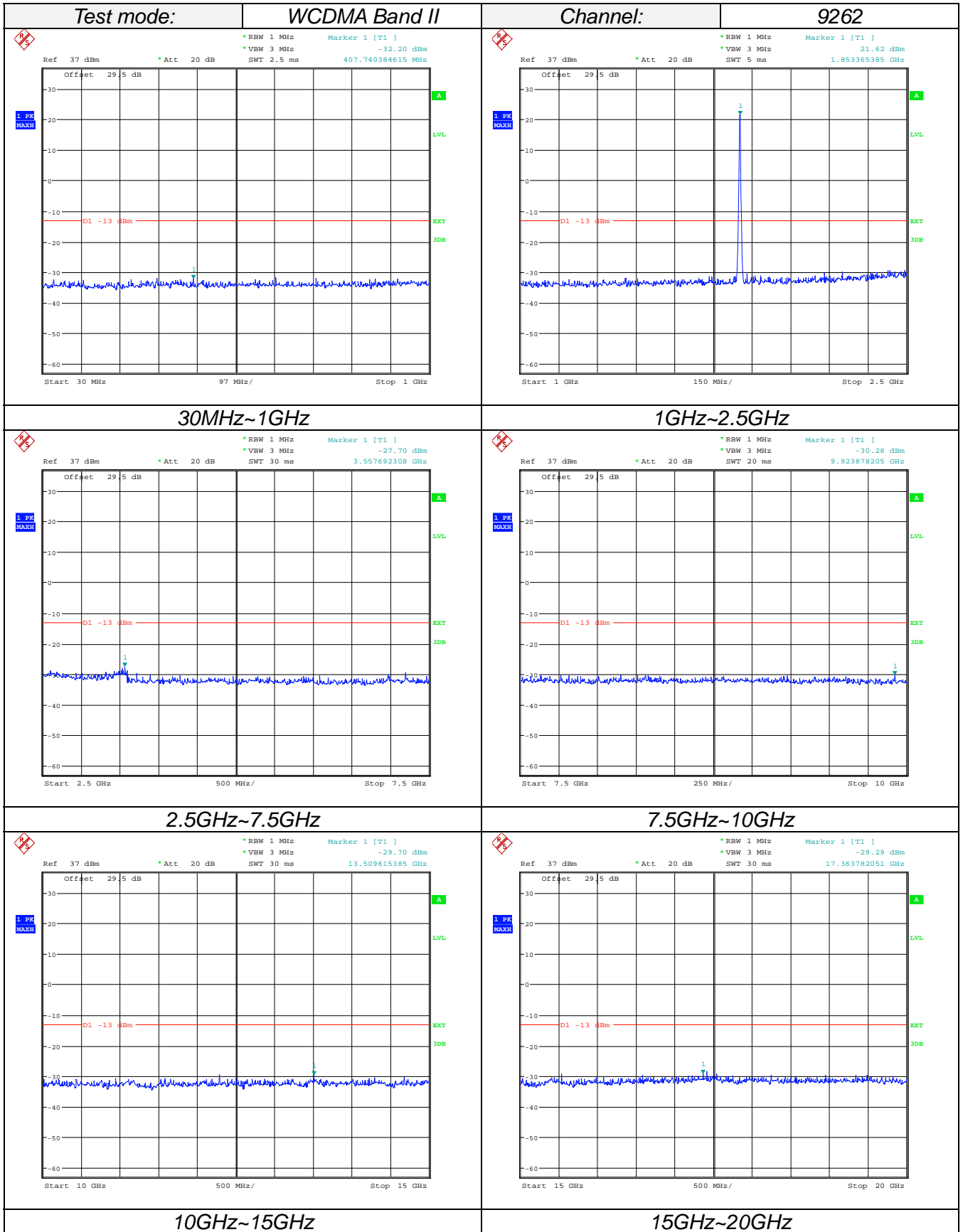

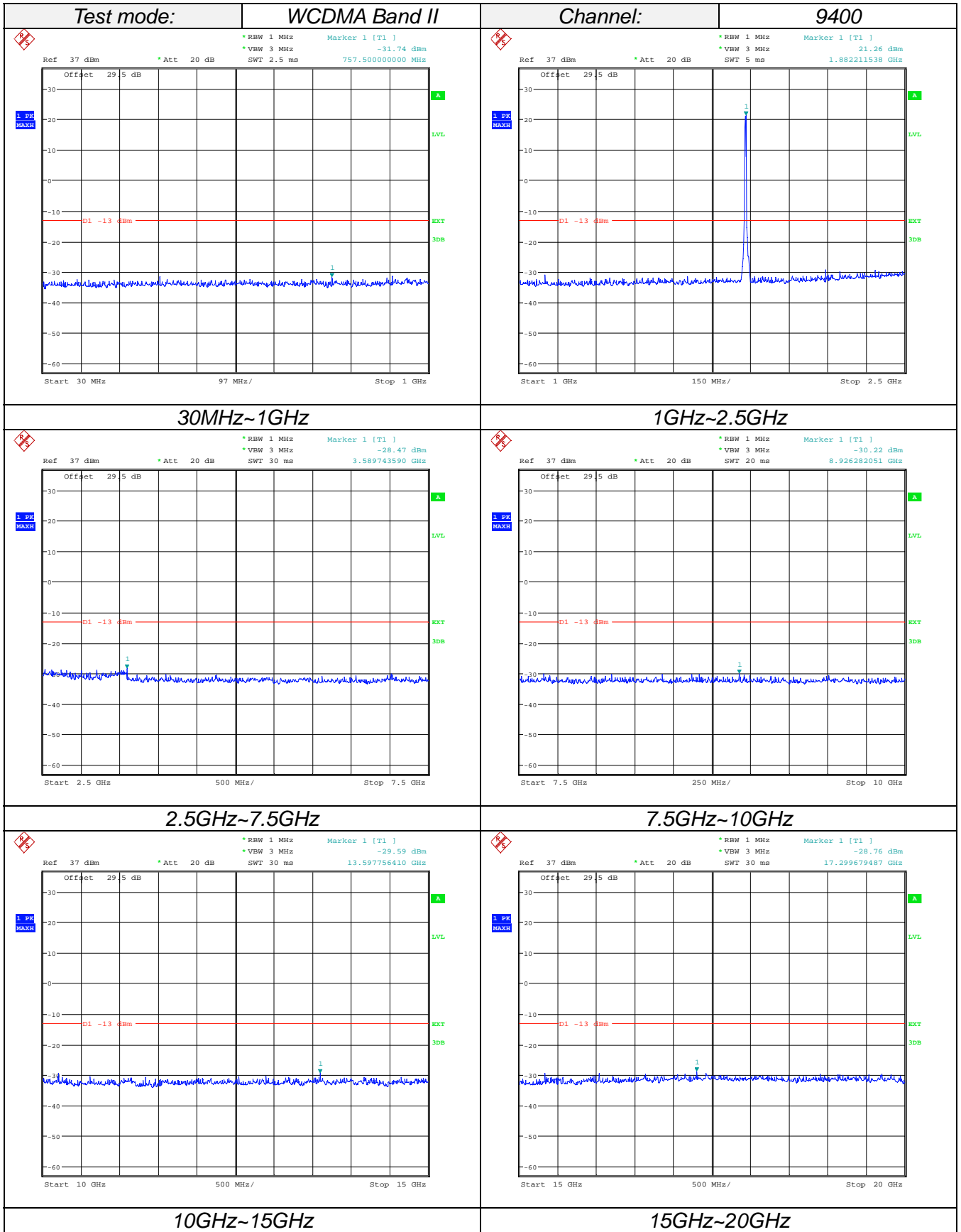

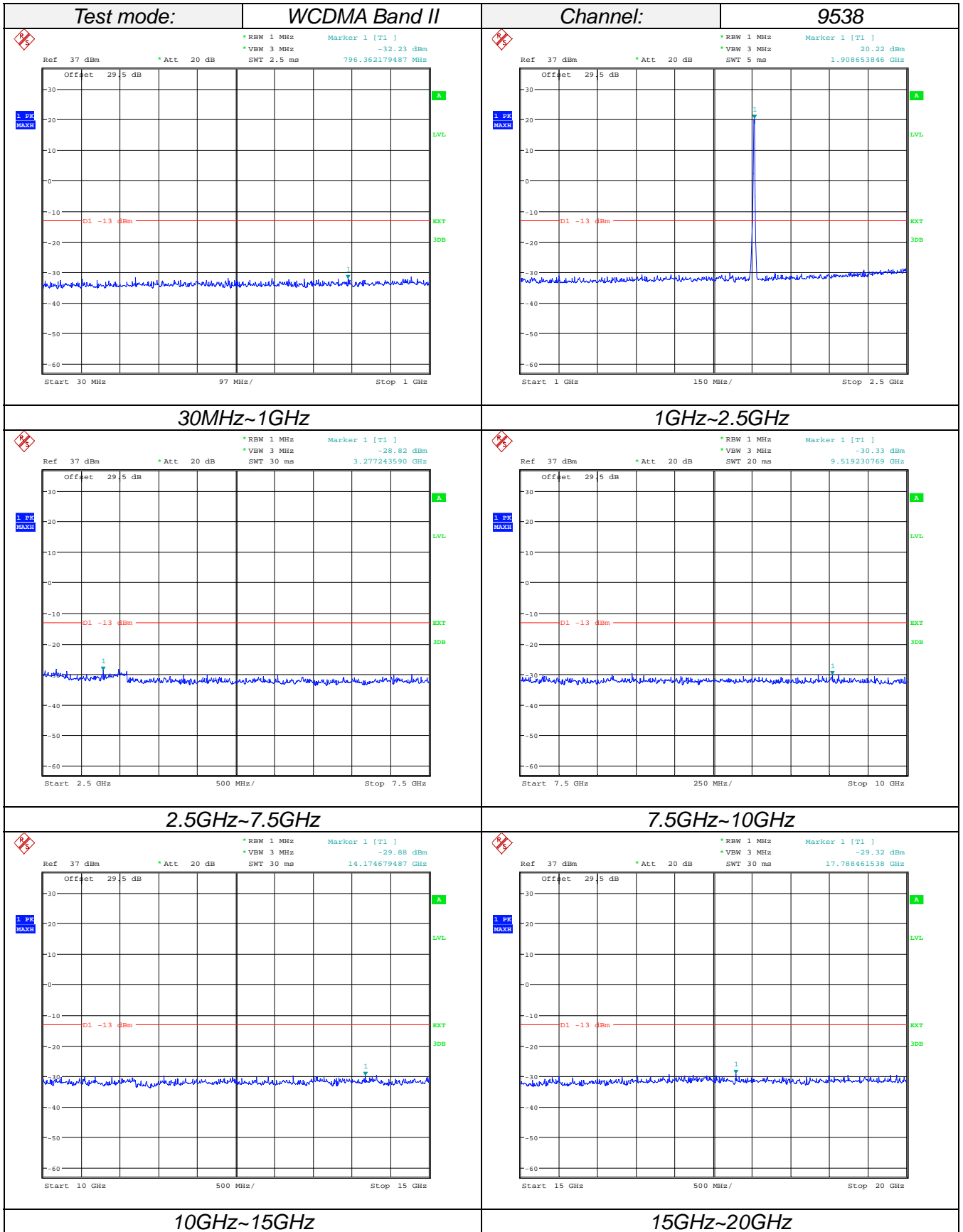

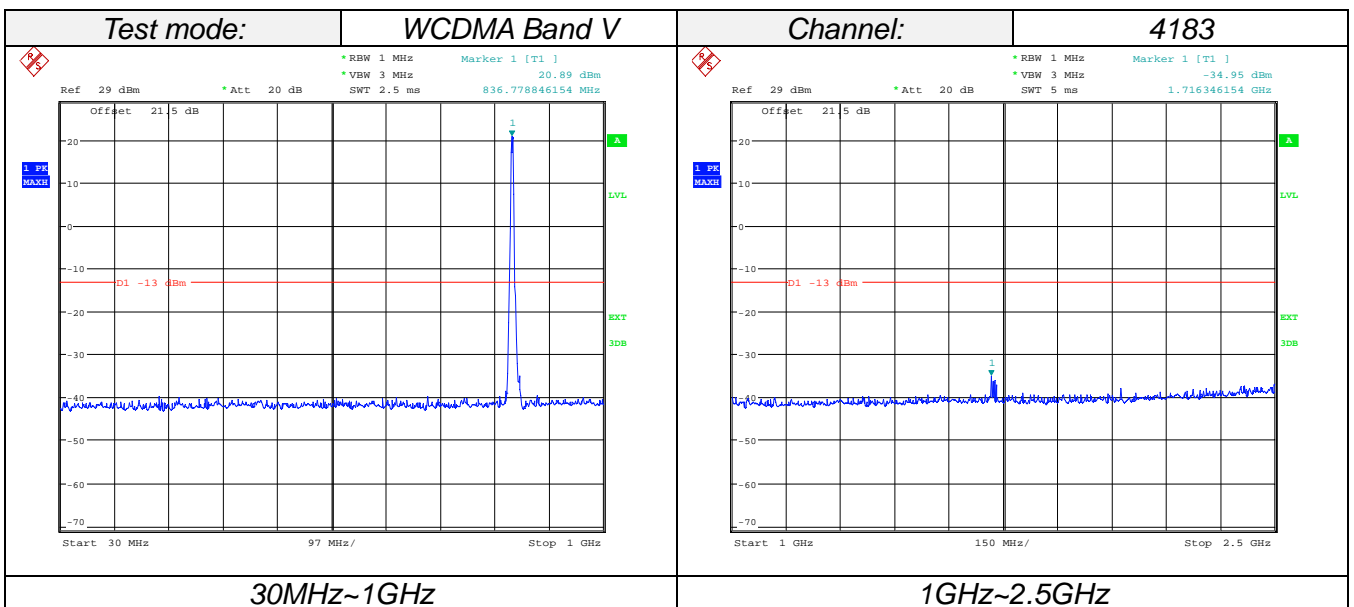
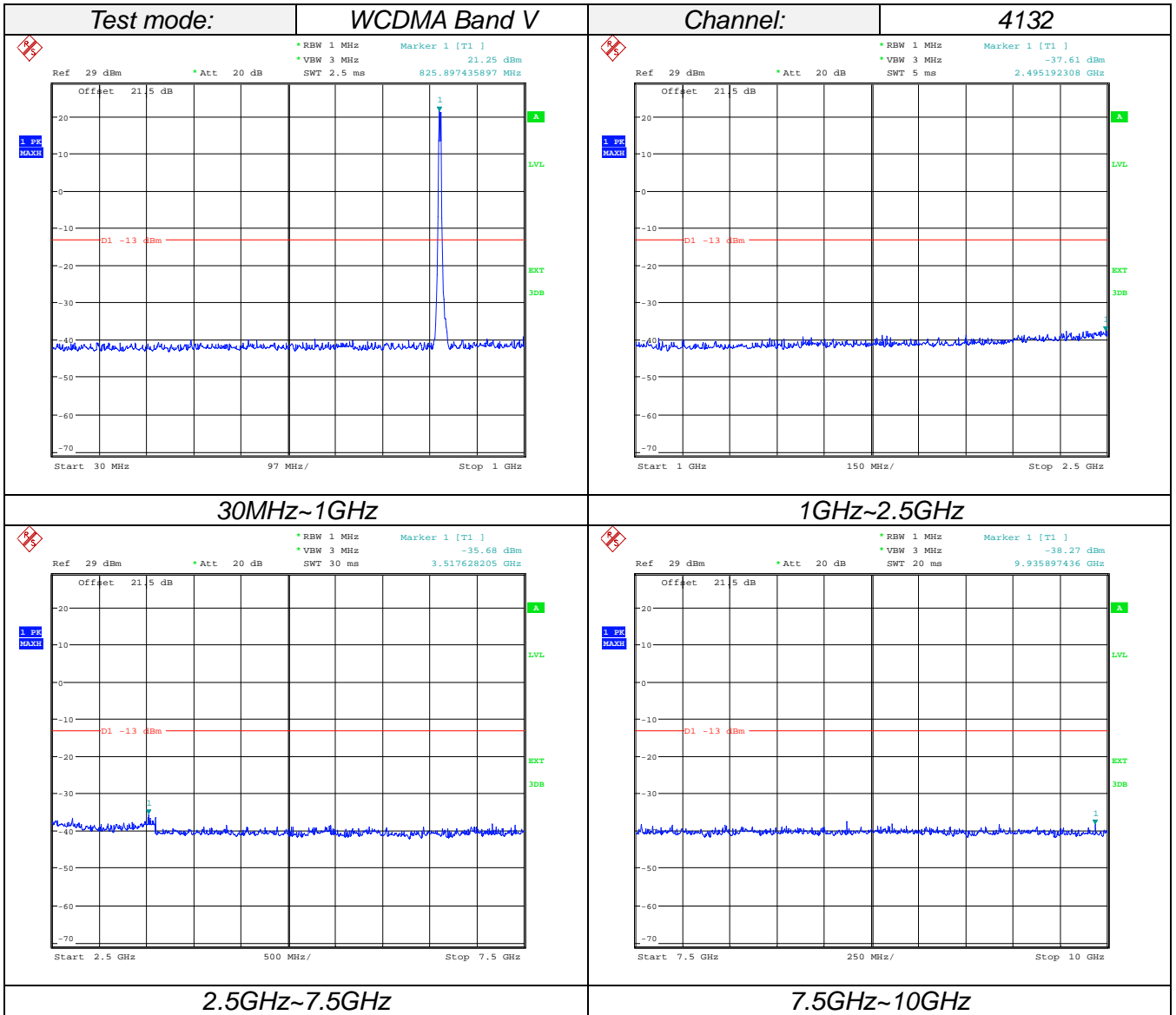

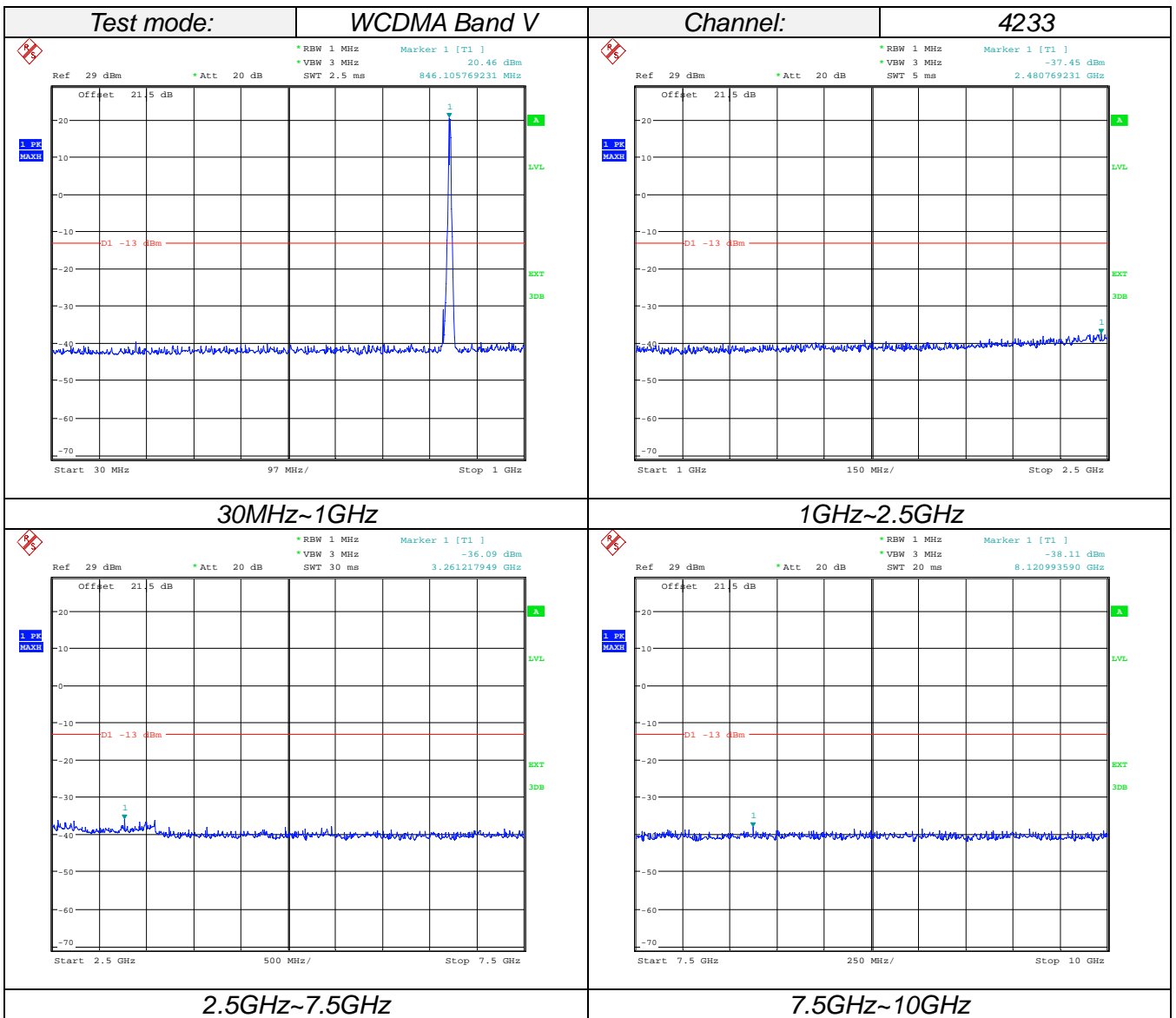
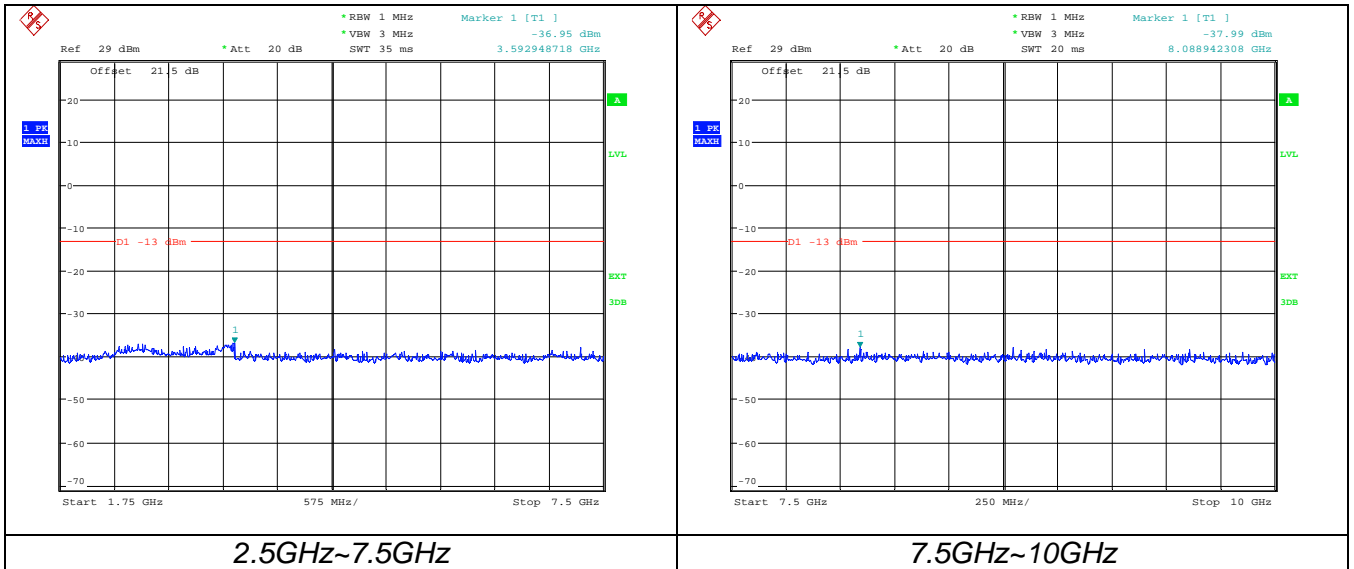

3.5. Band Edge compliance

LIMIT

Part 24.238 and Part 22.917 specify that the power of any emission outside of the authorized operating frequency ranges must be attenuated below the transmitting power (P) by a factor of at least $43 + 10 \log(P)$ dB.

The specification that emissions shall be attenuated below the transmitter power (P) by at least $43 + 10 \log(P)$ dB, translates in the relevant power range (1 to 0.001 W) to -13 dBm. At 1 W the specified minimum attenuation becomes 43 dB and relative to a 30 dBm (1 W) carrier becomes a limit of -13 dBm. At 0.001 W (0 dBm) the minimum attenuation is 13 dB, which again yields a limit of -13 dBm. In this way a translation of the specification from relative to absolute terms is carried out.

TEST CONFIGURATION

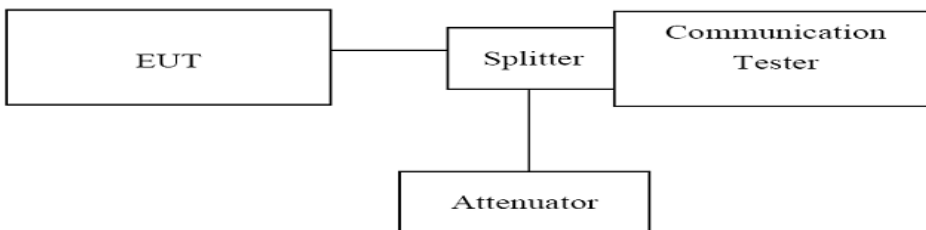

TEST PROCEDURE

1. The RF output of the transceiver was connected to a spectrum analyzer through appropriate attenuation.
2. Set the RBW=5 KHz, VBW = 50KHz, Span=1MHz Sweep time= Auto for 2G system measurement.
3. Set the RBW=5 KHz, VBW = 50KHz, Span=1MHz Sweep time= Auto for 3G system measurement.

TEST RESULTS

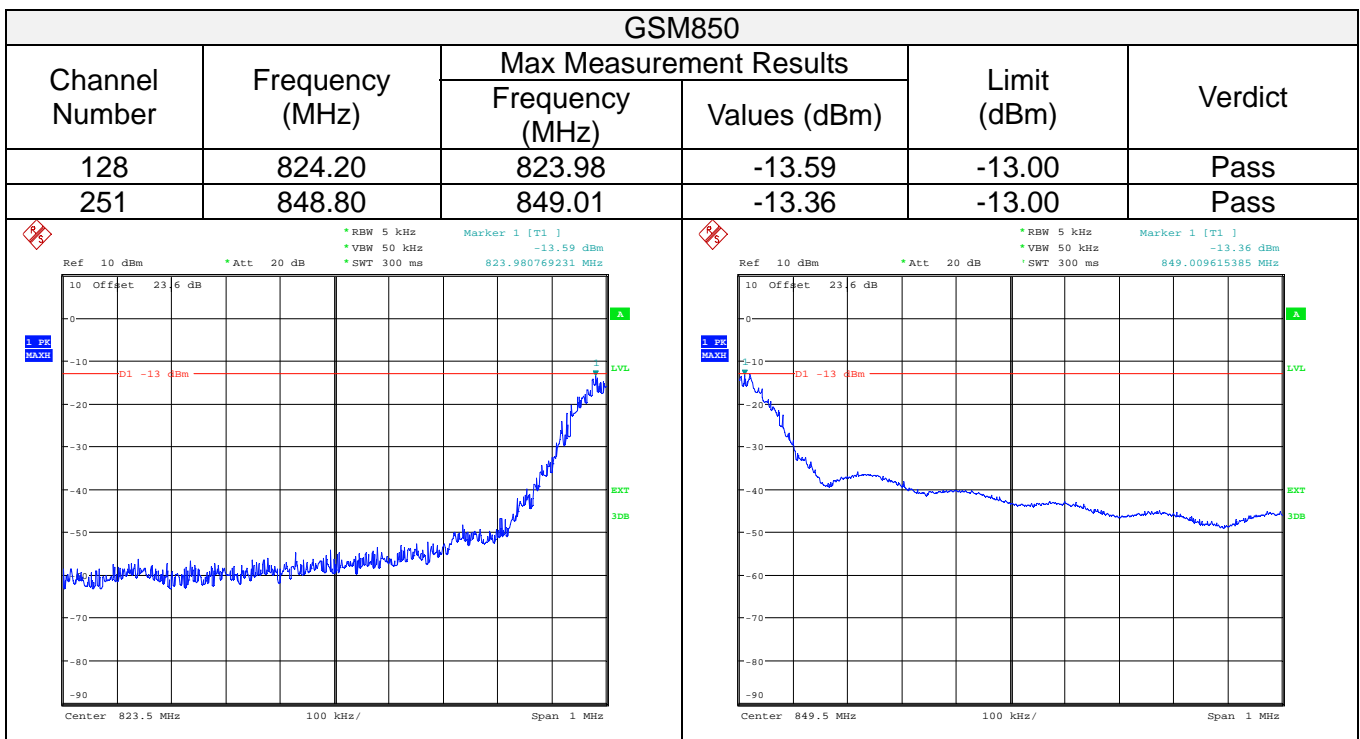

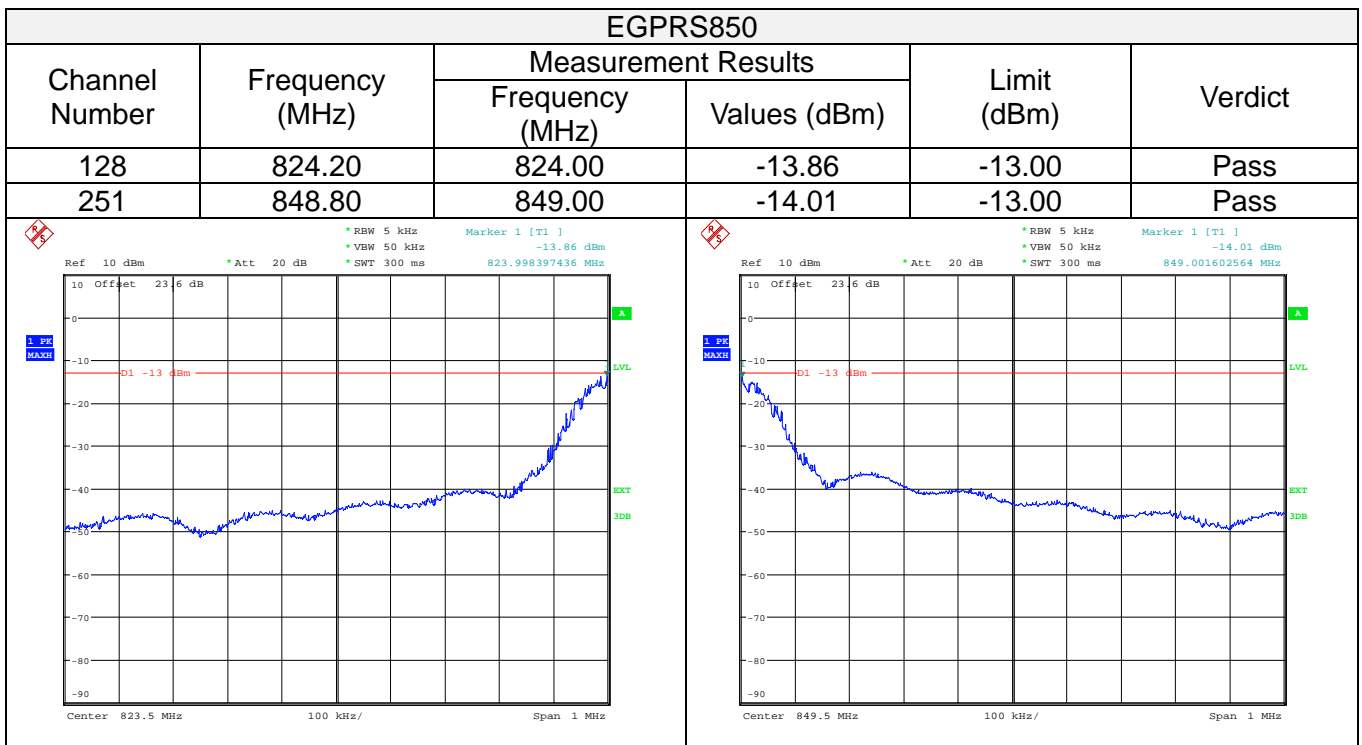
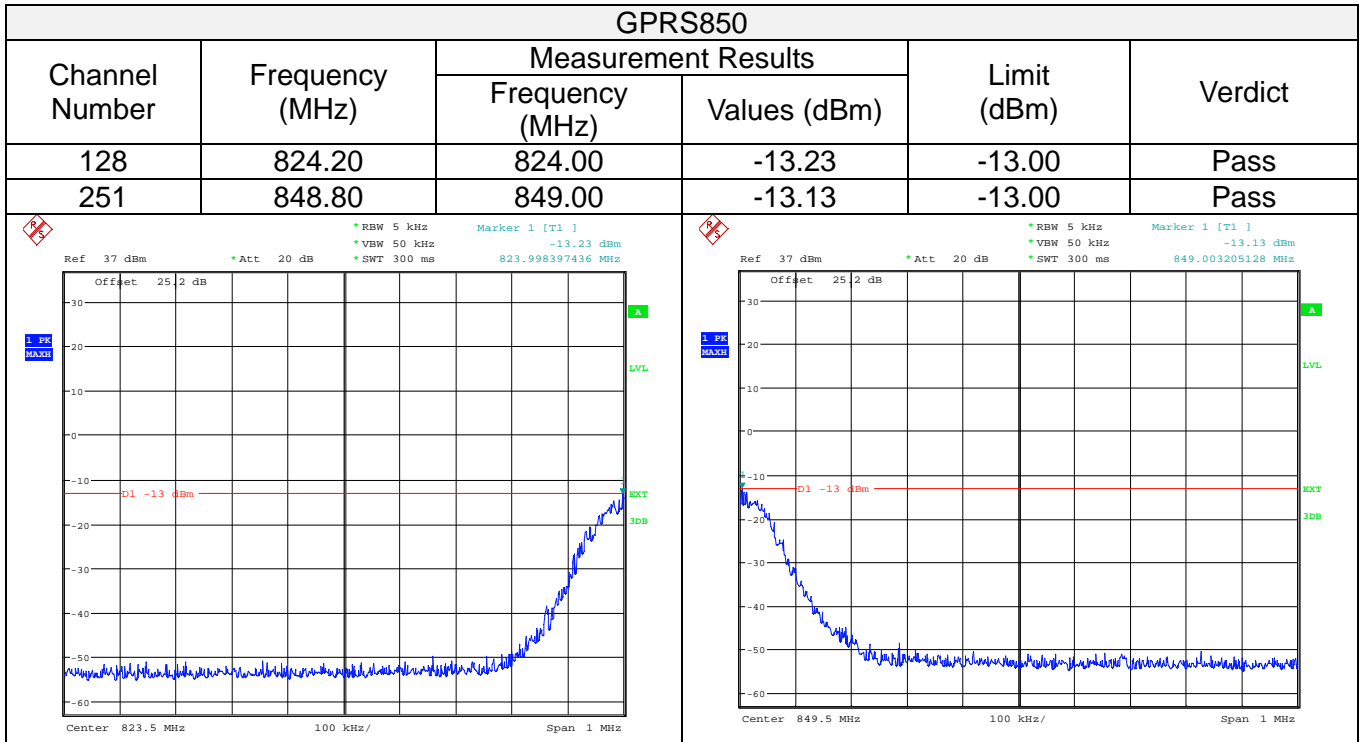

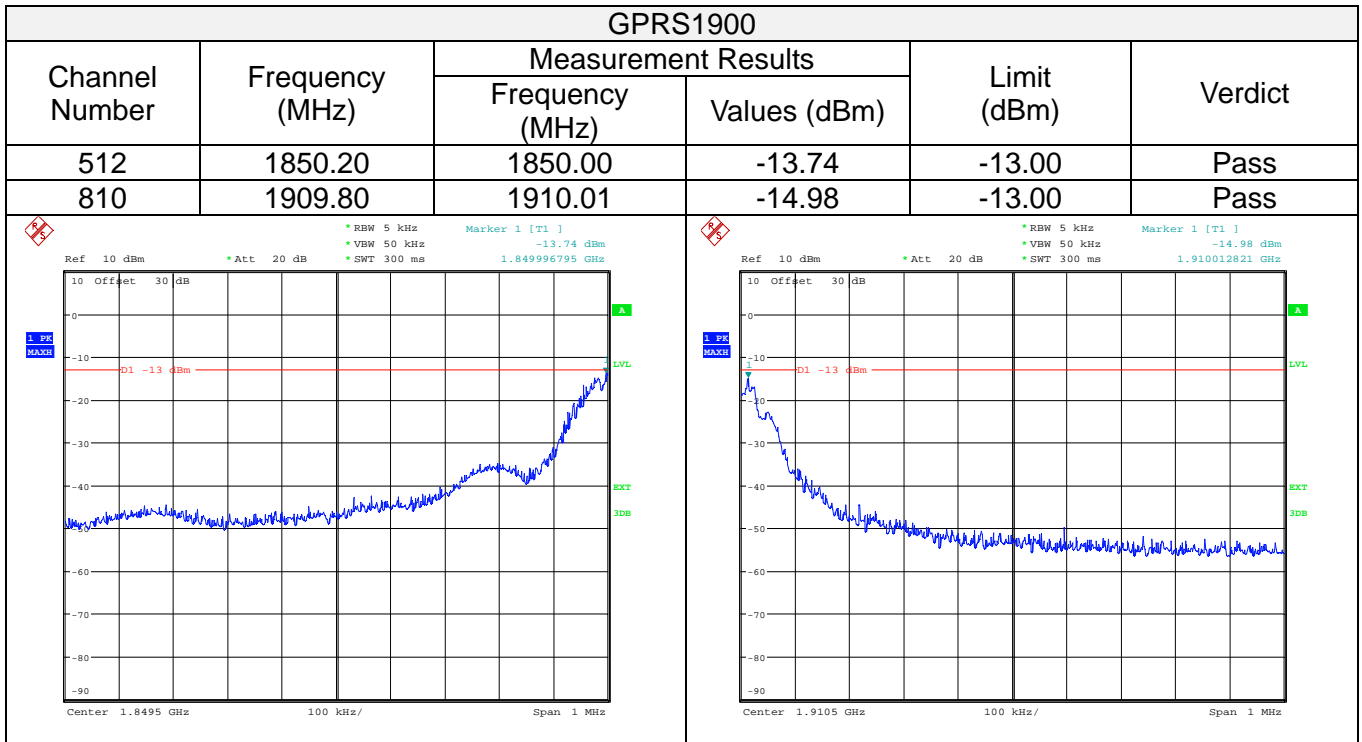
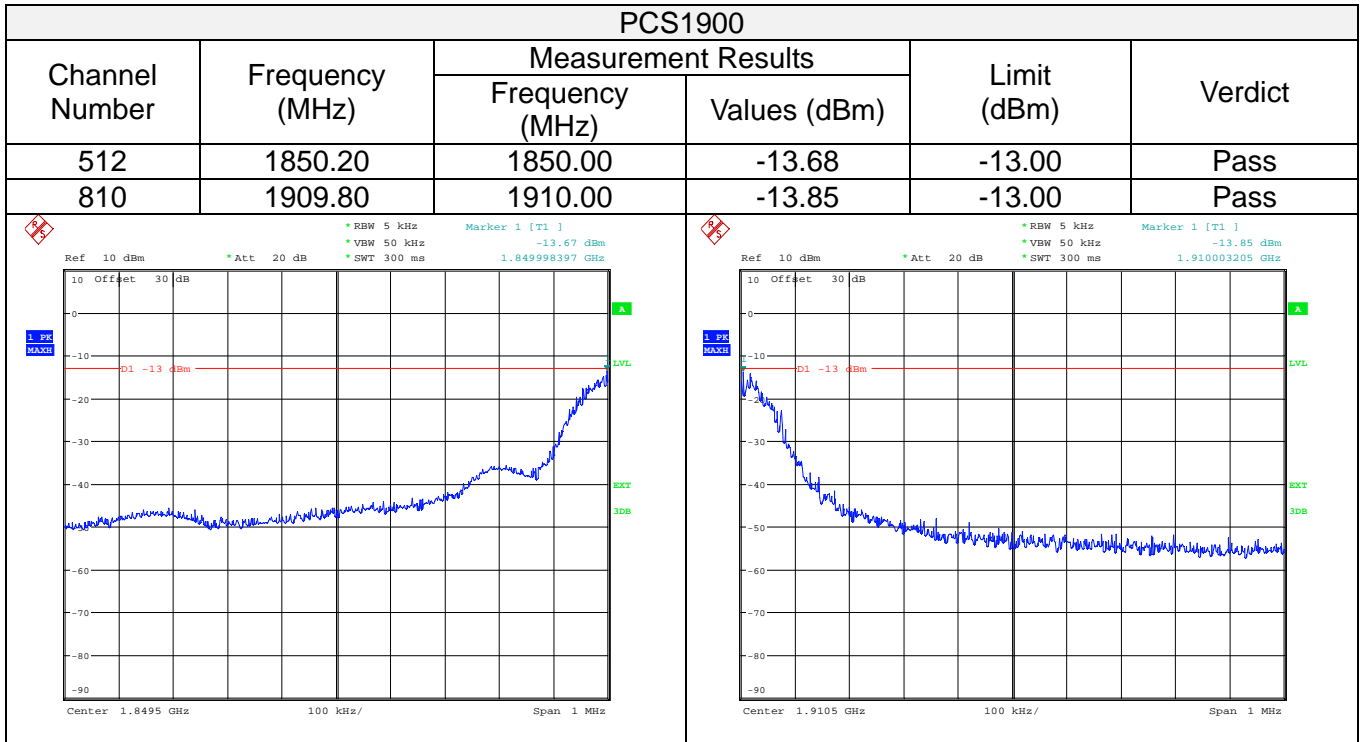

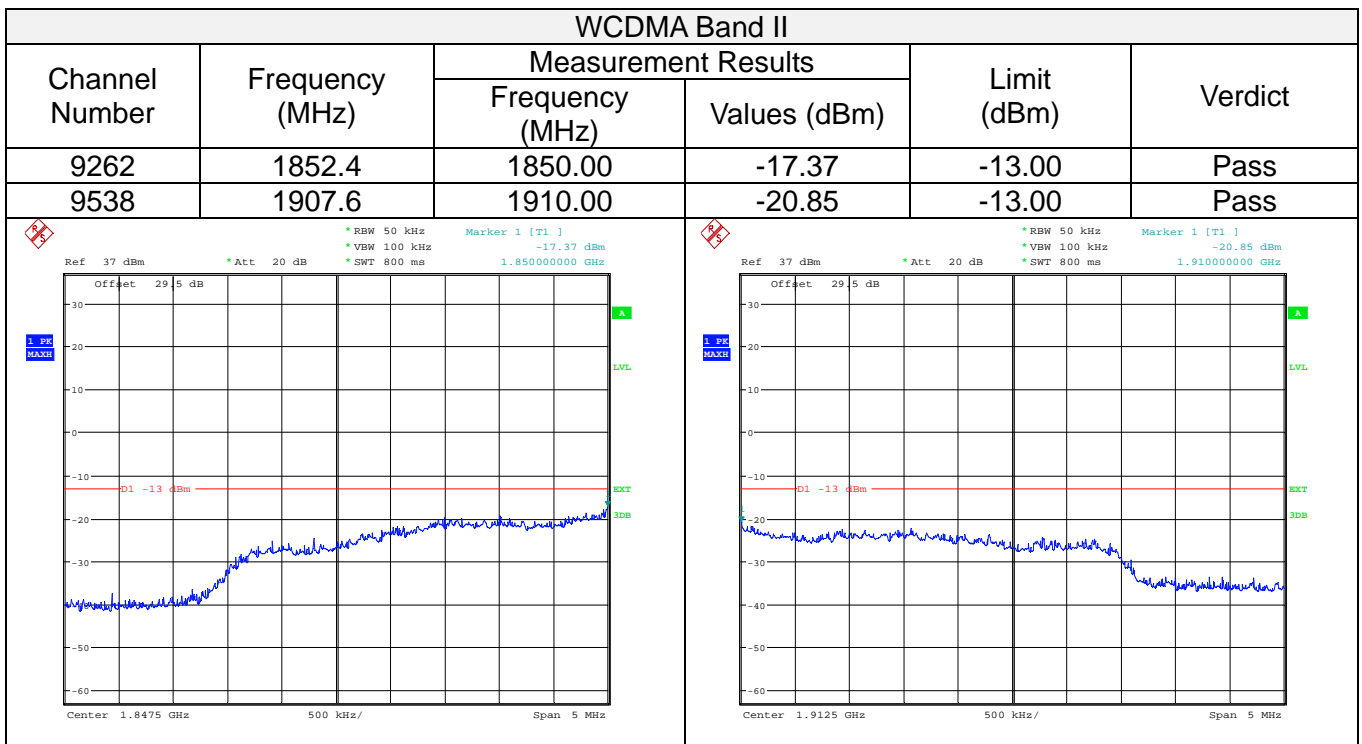
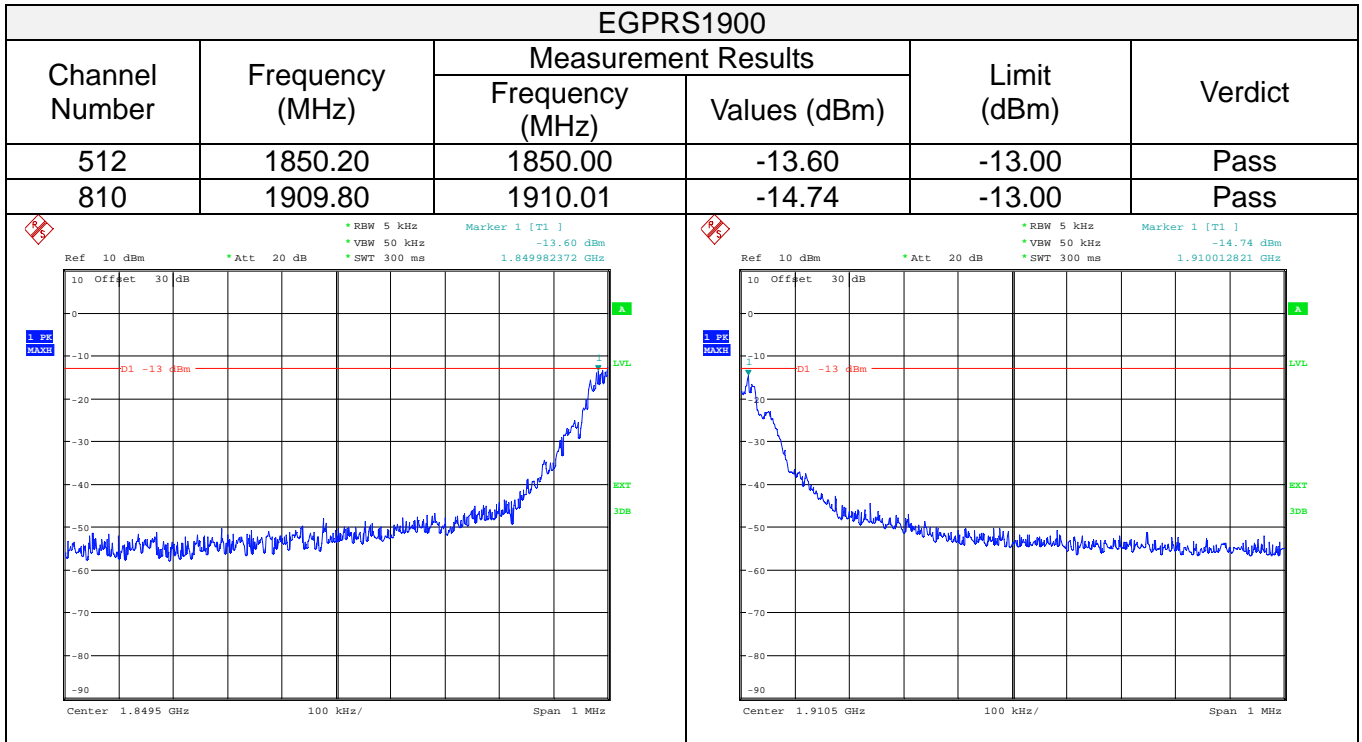

WCDMA Band V					
Channel Number	Frequency (MHz)	Measurement Results		Limit (dBm)	Verdict
		Frequency (MHz)	Values (dBm)		
4132	826.4	823.99	-22.23	-13.00	Pass
4233	846.6	849.00	-17.51	-13.00	Pass

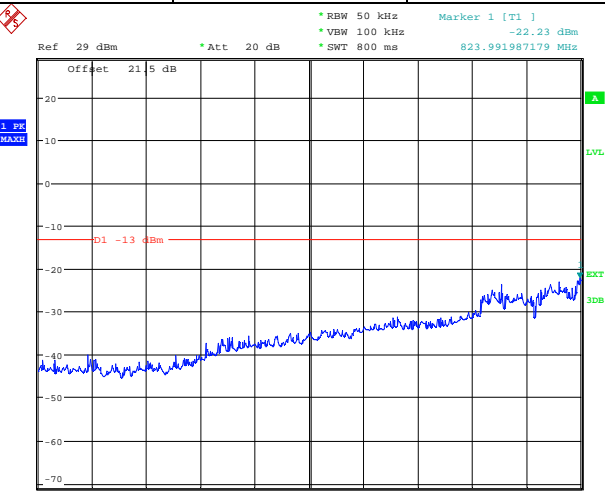

Ref 29 dBm *Att 20 dB *RBW 50 kHz *VBW 100 kHz *SWT 800 ms
 Marker 1 [T1] -22.23 dBm
 823.991987179 MHz
 Offset 21.5 dB
 D1 -13 dBm
 Center 821.5 MHz 500 kHz/ Span 5 MHz

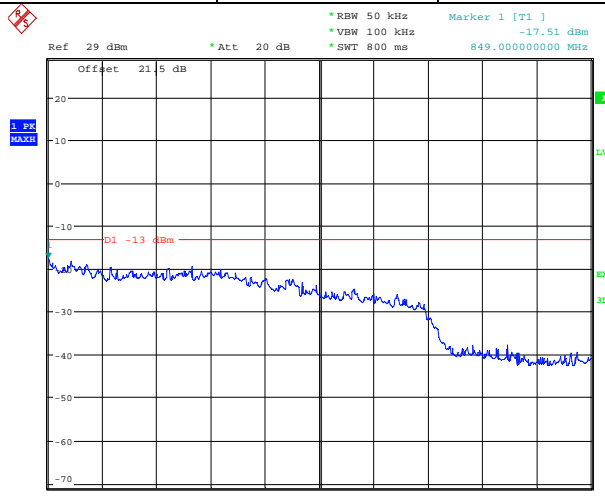

Ref 29 dBm *Att 20 dB *RBW 50 kHz *VBW 100 kHz *SWT 800 ms
 Marker 1 [T1] -17.51 dBm
 849.000000000 MHz
 Offset 21.5 dB
 D1 -13 dBm
 Center 851.5 MHz 500 kHz/ Span 5 MHz

3.6. Radiated Power Measurement

LIMIT

GSM850/WCDMA Band V: 7W ERP

PCS1900/WCDMA Band II: 2W EIRP

TEST CONFIGURATION

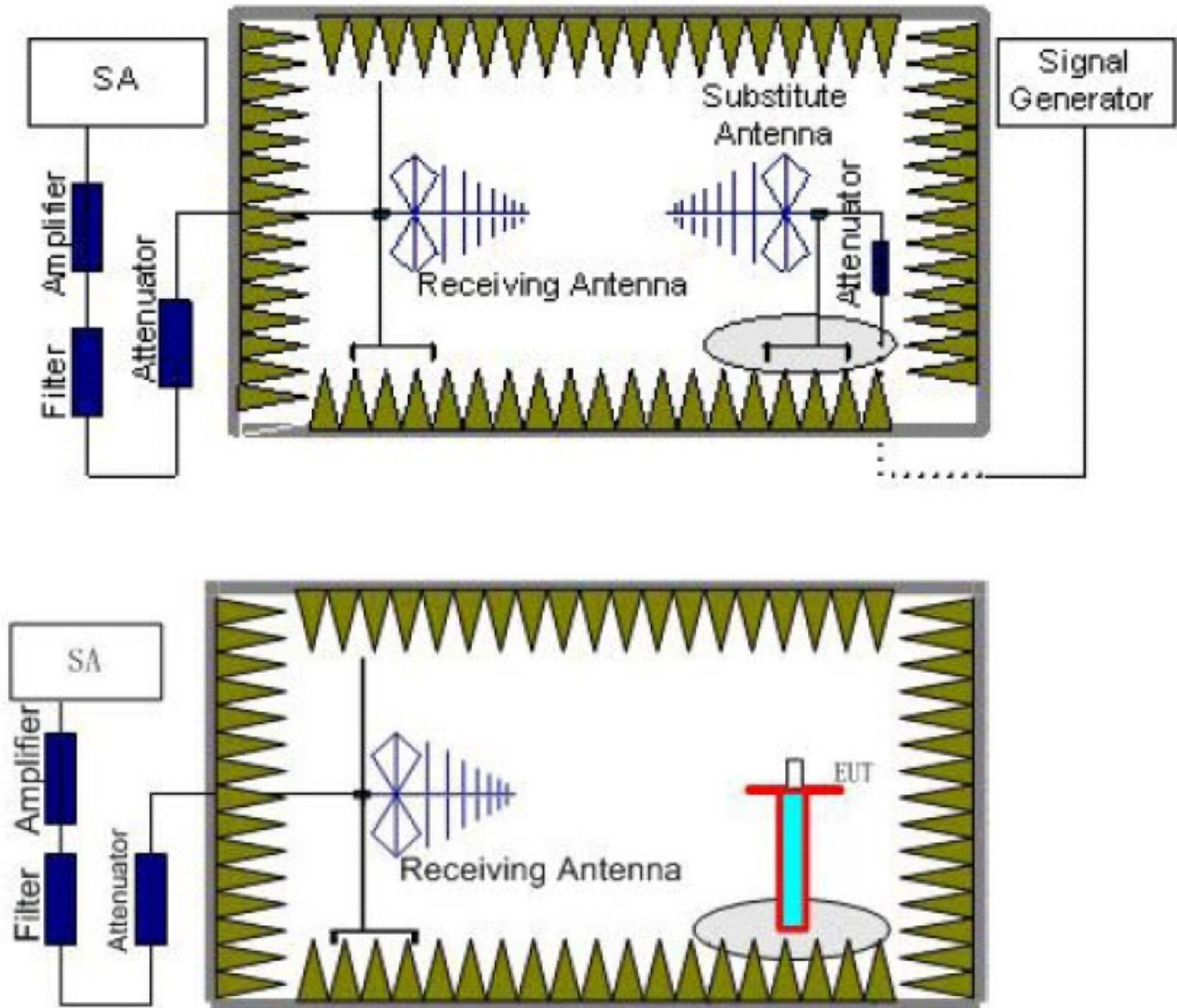

TEST PROCEDURE

1. EUT was placed on a 1.50 meter high non-conductive stand at a 3 meter test distance from the receive antenna. A receiving antenna was placed on the antenna mast 3 meters from the EUT for emission measurements. The height of receiving antenna is 1.50m. Detected emissions were maximized at each frequency by rotating the EUT through 360° and adjusting the receiving antenna polarization. The radiated emission measurements of all transmit frequencies in three channels (High, Middle, Low) were measured with peak detector.
2. A log-periodic antenna or double-ridged waveguide horn antenna shall be substituted in place of the EUT. The log-periodic antenna will be driven by a signal generator and the level will be

adjusted till the same power value on the spectrum analyzer or receiver. The level of the spurious emissions can be calculated through the level of the signal generator, cable loss, the gain of the substitution antenna and the reading of the spectrum analyzer or receiver.

3. The EUT is then put into continuously transmitting mode at its maximum power level during the test. Set Test Receiver or Spectrum RBW=1MHz, VBW=3MHz, and the maximum value of the receiver should be recorded as (Pr).
4. The EUT shall be replaced by a substitution antenna. In the chamber, an substitution antenna for the frequency band of interest is placed at the reference point of the chamber. An RF Signal source for the frequency band of interest is connected to the substitution antenna with a cable that has been constructed to not interfere with the radiation pattern of the antenna. A power (PMea) is applied to the input of the substitution antenna, and adjusts the level of the signal generator output until the value of the receiver reach the previously recorded (Pr). The power of signal source (PMea) is recorded. The test should be performed by rotating the test item and adjusting the receiving antenna polarization.
5. An amplifier should be connected to the Signal Source output port. And the cable should be connecting between the Amplifier and the Substitution Antenna. The cable loss (Pcl), the Substitution Antenna Gain (Ga) and the Amplifier Gain (PAg) should be recorded after test.
6. The measurement results are obtained as described below:
Power(EIRP)=PMea- PAg - Pcl + Ga
We used N5182A microwave signal generator which signal level can up to 33dBm,so we not used power Amplifier for substitution test; The measurement results are amend as described below:
Power(EIRP)=PMea- Pcl + Ga
7. This value is EIRP since the measurement is calibrated using an antenna of known gain (2.15 dBi) and known input power.
ERP can be calculated from EIRP by subtracting the gain of the dipole, ERP = EIRP-2.15dBi.

TEST RESULTS



GSM:

Mode	Channel	Antenna Pol.	ERP	Limit (dBm)	Result
GSM850 (GMSK)	128	V	32.55	38.45	Pass
		H	30.21		
	190	V	32.25		
		H	28.98		
	251	V	32.48		
		H	28.69		
GPRS850 (GMSK)	128	V	32.33	38.45	Pass
		H	28.69		
	190	V	32.47		
		H	28.52		
	251	V	32.36		
		H	28.21		
EGPRS850 (GMSK)	128	V	32.25	38.45	Pass
		H	28.22		
	190	V	32.54		
		H	28.32		
	251	V	32.54		
		H	28.24		

Mode	Channel	Antenna Pol.	EIRP	Limit (dBm)	Result
PCS1900 (GMSK)	512	V	29.95	33.01	Pass
		H	26.54		
	661	V	29.36		
		H	26.55		
	810	V	29.36		
		H	26.48		
GPRS1900 (GMSK)	512	V	29.32	33.01	Pass
		H	27.45		
	661	V	29.68		
		H	26.44		
	810	V	29.59		
		H	26.65		
EGPRS 1900 (GMSK)	512	V	29.55	33.01	Pass
		H	25.14		
	661	V	30.26		
		H	27.69		
	810	V	30.66		
		H	26.48		

WCDMA:

Mode	Channel	Antenna Pol.	EIRP	Limit (dBm)	Result
WCDMA Band II (QPSK)	9262	V	23.57	33.01	Pass
		H	19.36		
	9400	V	23.26		
		H	18.45		
	9538	V	23.61		
		H	19.30		

Mode	Channel	Antenna Pol.	ERP	Limit (dBm)	Result
WCDMA Band V (QPSK)	4132	V	23.65	38.45	Pass
		H	18.48		
	4182	V	23.26		
		H	18.25		
	4233	V	23.69		
		H	18.48		

3.7. Radiated Spurious Emission

LIMIT

-13dBm

TEST CONFIGURATION

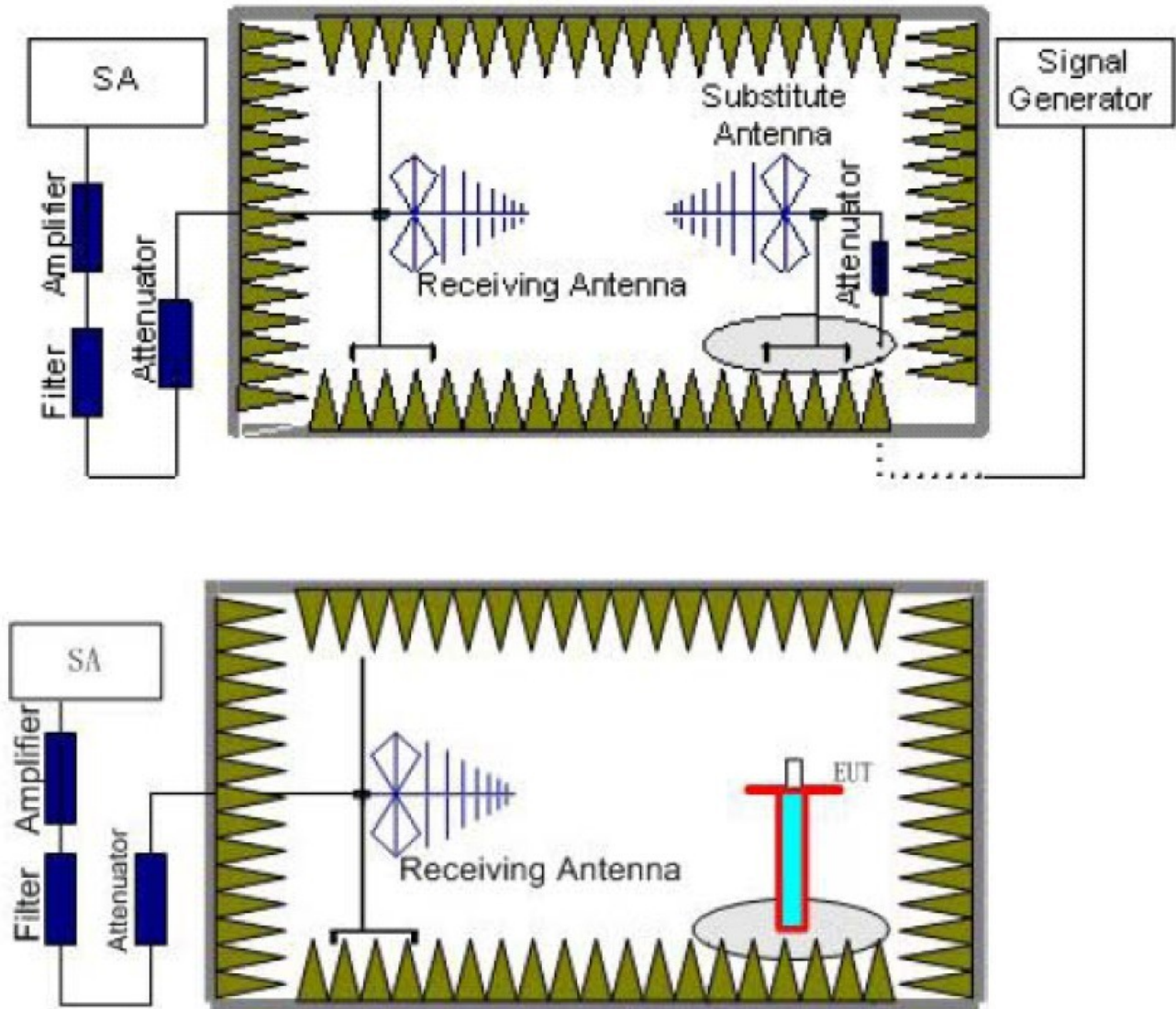

TEST RESULTS

1. EUT was placed on a 1.50 meter high non-conductive stand at a 3 meter test distance from the receive antenna. A receiving antenna was placed on the antenna mast 3 meters from the EUT for emission measurements. The height of receiving antenna is 1.50m. Detected emissions were maximized at each frequency by rotating the EUT through 360° and adjusting the receiving antenna polarization. The radiated emission measurements of all transmit frequencies in three channels (High, Middle, Low) were measured with peak detector.
2. A log-periodic antenna or double-ridged waveguide horn antenna shall be substituted in place of the EUT. The log-periodic antenna will be driven by a signal generator and the level will be adjusted till the same power value on the spectrum analyzer or receiver. The level of the spurious emissions can be calculated through the level of the signal generator, cable loss, the gain of the substitution antenna and the reading of the spectrum analyzer or receiver.

3. The EUT is then put into continuously transmitting mode at its maximum power level during the test. Set Test Receiver or Spectrum RBW=1MHz, VBW=3MHz, and the maximum value of the receiver should be recorded as (Pr).
4. The EUT shall be replaced by a substitution antenna. In the chamber, an substitution antenna for the frequency band of interest is placed at the reference point of the chamber. An RF Signal source for the frequency band of interest is connected to the substitution antenna with a cable that has been constructed to not interfere with the radiation pattern of the antenna. A power (PMea) is applied to the input of the substitution antenna, and adjusts the level of the signal generator output until the value of the receiver reach the previously recorded (Pr). The power of signal source (PMea) is recorded. The test should be performed by rotating the test item and adjusting the receiving antenna polarization.
5. An amplifier should be connected to the Signal Source output port. And the cable should be connecting between the Amplifier and the Substitution Antenna. The cable loss (Pcl) ,the Substitution Antenna Gain (Ga) and the Amplifier Gain (PAg) should be recorded after test.
6. The measurement results are obtained as described below:
Power(EIRP)=PMea- PAg - Pcl + Ga
We used SMF100A microwave signal generator which signal level can up to 33dBm,so we not used power Amplifier for substitution test; The measurement results are amend as described below:
Power(EIRP)=PMea- Pcl + Ga
7. This value is EIRP since the measurement is calibrated using an antenna of known gain (2.15 dBi) and known input power.
ERP can be calculated from EIRP by subtracting the gain of the dipole, ERP = EIRP-2.15dBi.

TEST RESULTS

Remark: we test all modulation type and record worst case at Voice mode.

GSM850					
Channel	Frequency (MHz)	Spurious Emission		Limit (dBm)	Result
		Polarization	Level (dBm)		
128	1648.40	Vertical	-23.56	-13.00	Pass
	2472.60	Vertical	-35.47		
	3296.80	Vertical	-44.36		
	4121.00	Vertical	-48.66		
	4945.20	Vertical	---		
	1648.40	Horizontal	-29.66	-13.00	Pass
	2472.60	Horizontal	-37.61		
	3296.80	Horizontal	-41.65		
	4121.00	Horizontal	-46.98		
	4945.20	Horizontal	---		
190	1673.20	Vertical	-24.58	-13.00	Pass
	2509.80	Vertical	-36.39		
	3346.40	Vertical	-46.99		
	4183.00	Vertical	-48.47		
	5019.60	Vertical	---		
	1673.20	Vertical	-29.69	-13.00	Pass
	2509.80	Horizontal	-36.47		
	3346.40	Horizontal	-44.23		
	4183.00	Horizontal	-46.78		
	5019.60	Horizontal	---		
251	1697.60	Vertical	-24.15	-13.00	Pass
	2546.40	Vertical	-36.35		
	3395.20	Vertical	-46.44		
	4244.00	Vertical	-48.74		
	5092.80	Vertical	---		
	1697.60	Horizontal	-30.23	-13.00	Pass
	2546.40	Horizontal	-35.64		
	3395.20	Horizontal	-47.57		
	4244.00	Horizontal	-46.69		
	5092.80	Horizontal	---		

Remark :

1. The emission behavior belongs to narrowband spurious emission.
2. Remark"---" means that the emission level is too low to be measured
3. The emission levels of below 1 GHz are very lower than the limit and not show in test report.

PCS1900					
Channel	Frequency (MHz)	Spurious Emission		Limit (dBm)	Result
		Polarization	Level (dBm)		
512	3700.40	Vertical	-25.26	-13.00	Pass
	5550.60	Vertical	-34.15		
	7400.80	Vertical	-43.55		
	9251.00	Vertical	-47.10		
	11101.20	Vertical	---		
	3700.40	Horizontal	-30.26	-13.00	Pass
	5550.60	Horizontal	-35.47		
	7400.80	Horizontal	-43.72		
	9251.00	Horizontal	-45.86		
	11101.20	Horizontal	---		
661	3760.00	Vertical	-23.26	-13.00	Pass
	5640.00	Vertical	-35.41		
	7520.00	Vertical	-45.78		
	9400.00	Vertical	-47.69		
	11280.00	Vertical	---		
	3760.00	Horizontal	-29.63	-13.00	Pass
	5640.00	Horizontal	-36.25		
	7520.00	Horizontal	-44.11		
	9400.00	Horizontal	-46.38		
	11280.00	Horizontal	---		
810	3819.60	Vertical	-24.15	-13.00	Pass
	5729.40	Vertical	-36.35		
	7639.20	Vertical	-46.44		
	9549.00	Vertical	-48.74		
	11458.80	Vertical	---		
	3819.60	Horizontal	-30.25	-13.00	Pass
	5729.40	Horizontal	-35.36		
	7639.20	Horizontal	-47.25		
	9549.00	Horizontal	-46.25		
	11458.80	Horizontal	---		

Remark :

1. The emission behavior belongs to narrowband spurious emission.
2. Remark"---" means that the emission level is too low to be measured
3. The emission levels of below 1 GHz are very lower than the limit and not show in test report.

WCDMA Band II					
Channel	Frequency (MHz)	Spurious Emission		Limit (dBm)	Result
		Polarization	Level (dBm)		
4132	1652.80	Vertical	-25.26	-13.00	Pass
	2479.20	Vertical	-34.15		
	2479.20	Vertical	-43.55		
	3305.60	Vertical	-47.10		
	4132.00	Vertical	---		
	1652.80	Horizontal	-30.26	-13.00	Pass
	2479.20	Horizontal	-35.47		
	2479.20	Horizontal	-43.72		
	3305.60	Horizontal	-45.86		
	4132.00	Horizontal	---		
4182	1673.20	Vertical	-23.26	-13.00	Pass
	2509.80	Vertical	-35.41		
	2509.80	Vertical	-45.78		
	3346.40	Vertical	-47.69		
	4183.00	Vertical	---		
	1673.20	Horizontal	-29.63	-13.00	Pass
	2509.80	Horizontal	-36.25		
	2509.80	Horizontal	-44.11		
	3346.40	Horizontal	-46.38		
	4183.00	Horizontal	---		
4233	1693.20	Vertical	-24.15	-13.00	Pass
	2539.80	Vertical	-36.35		
	2539.80	Vertical	-46.44		
	3386.40	Vertical	-48.74		
	4233.00	Vertical	---		
	1693.20	Horizontal	-30.25	-13.00	Pass
	2539.80	Horizontal	-35.36		
	2539.80	Horizontal	-47.25		
	3386.40	Horizontal	-46.25		
	4233.00	Horizontal	---		

Remark :

1. The emission behavior belongs to narrowband spurious emission.
2. Remark"---" means that the emission level is too low to be measured
3. The emission levels of below 1 GHz are very lower than the limit and not show in test report.

WCDMA Band V					
Channel	Frequency (MHz)	Spurious Emission		Limit (dBm)	Result
		Polarization	Level (dBm)		
4132	1652.80	Vertical	-28.25	-13.00	Pass
	2479.20	Vertical	-35.26		
	2479.20	Vertical	-43.64		
	3305.60	Vertical	-47.22		
	4132.00	Vertical	---		
	1652.80	Horizontal	-30.36	-13.00	Pass
	2479.20	Horizontal	-34.78		
	2479.20	Horizontal	-44.66		
	3305.60	Horizontal	-46.98		
	4132.00	Horizontal	---		
4182	1673.20	Vertical	-24.23	-13.00	Pass
	2509.80	Vertical	-36.36		
	2509.80	Vertical	-45.87		
	3346.40	Vertical	-47.63		
	4183.00	Vertical	---		
	1673.20	Horizontal	-28.65	-13.00	Pass
	2509.80	Horizontal	-36.36		
	2509.80	Horizontal	-44.25		
	3346.40	Horizontal	-46.45		
	4183.00	Horizontal	---		
4233	1693.20	Vertical	-25.48	-13.00	Pass
	2539.80	Vertical	-37.26		
	2539.80	Vertical	-47.59		
	3386.40	Vertical	-49.62		
	4233.00	Vertical	---		
	1693.20	Horizontal	-29.37	-13.00	Pass
	2539.80	Horizontal	-35.66		
	2539.80	Horizontal	-47.58		
	3386.40	Horizontal	-46.48		
	4233.00	Horizontal	---		

Remark :

4. The emission behavior belongs to narrowband spurious emission.
1. Remark"---" means that the emission level is too low to be measured
2. The emission levels of below 1 GHz are very lower than the limit and not show in test report.

3.8. Frequency stability

LIMIT

2.5ppm

TEST CONFIGURATION

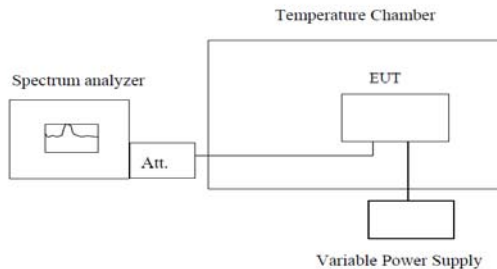

Note : Measurement setup for testing on Antenna connector

TEST PROCEDURE

1. The equipment under test was connected to an external DC power supply and input rated voltage.
2. RF output was connected to a frequency counter or spectrum analyzer via feed through attenuators.
3. The EUT was placed inside the temperature chamber.
4. Set the spectrum analyzer RBW low enough to obtain the desired frequency resolution and measure EUT 25°C operating frequency as reference frequency.
5. Turn EUT off and set the chamber temperature to -30°C. After the temperature stabilized for approximately 30 minutes recorded the frequency.
6. Repeat step measure with 10°C increased per stage until the highest temperature of +50°C reached.
7. Reduce the input voltage to specified extreme voltage variation (+/- 15%) and endpoint, record the maximum frequency change.

TEST RESULTS

Remark: we test all modulation type and record worst case at Voice mode.

Reference Frequency: GSM850 Middle channel=190 channel=836.6MHz					
Voltage (V)	Temperature (°C)	Frequency error		Limit (ppm)	Result
		Hz	ppm		
3.70	-30	57	0.068	2.5	Pass
	-20	48	0.057		
	-10	52	0.062		
	0	48	0.057		
	10	39	0.047		
	20	44	0.053		
	30	51	0.061		
	40	53	0.063		
	50	49	0.059		
4.25	25	55	0.066		
End point 3.40	25	35	0.042		

Reference Frequency: PCS1900 Middle channel=661 channel=1880MHz					
Voltage (V)	Temperature (°C)	Frequency error		Limit (ppm)	Result
		Hz	ppm		
3.70	-30	69	0.037	2.5	Pass
	-20	55	0.029		
	-10	48	0.026		
	0	57	0.030		
	10	50	0.027		
	20	54	0.029		
	30	41	0.022		
	40	45	0.024		
4.25	25	52	0.028		
End point 3.40	25	49	0.026		

Reference Frequency: WCDMA Band II Middle channel=9400 channel=1880MHz					
Voltage (V)	Temperature (°C)	Frequency error		Limit (ppm)	Result
		Hz	ppm		
3.70	-30	55	0.029	2.5	Pass
	-20	54	0.029		
	-10	55	0.029		
	0	48	0.026		
	10	50	0.027		
	20	51	0.027		
	30	54	0.029		
	40	56	0.030		
4.25	25	48	0.026		
End point 3.40	25	52	0.028		

Reference Frequency: WCDMA Band V Middle channel=4182 channel=836.6MHz					
Voltage (V)	Temperature (°C)	Frequency error		Limit (ppm)	Result
		Hz	ppm		
3.70	-30	50	0.060	2.5	Pass
	-20	47	0.056		
	-10	49	0.059		
	0	55	0.066		
	10	48	0.057		
	20	49	0.059		
	30	51	0.061		
	40	50	0.060		
4.25	25	47	0.056		
End point 3.40	25	48	0.057		

4. EUT TEST PHOTO

Conducted Emission



Radiated Emission

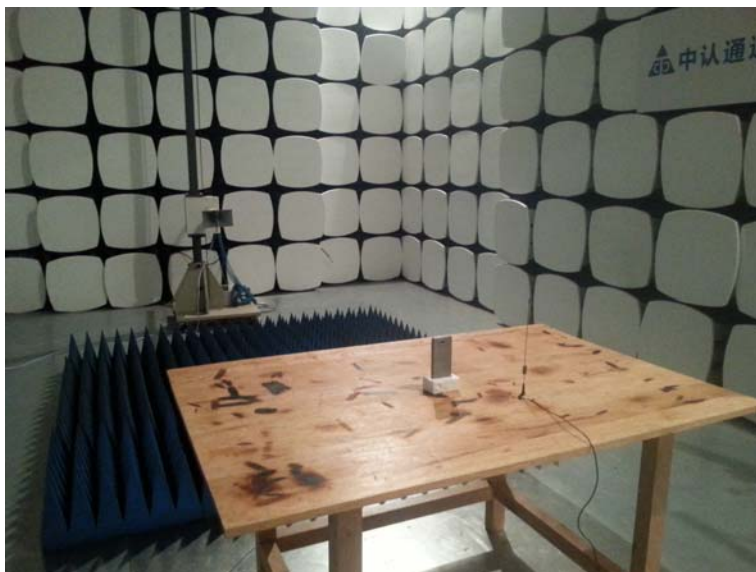
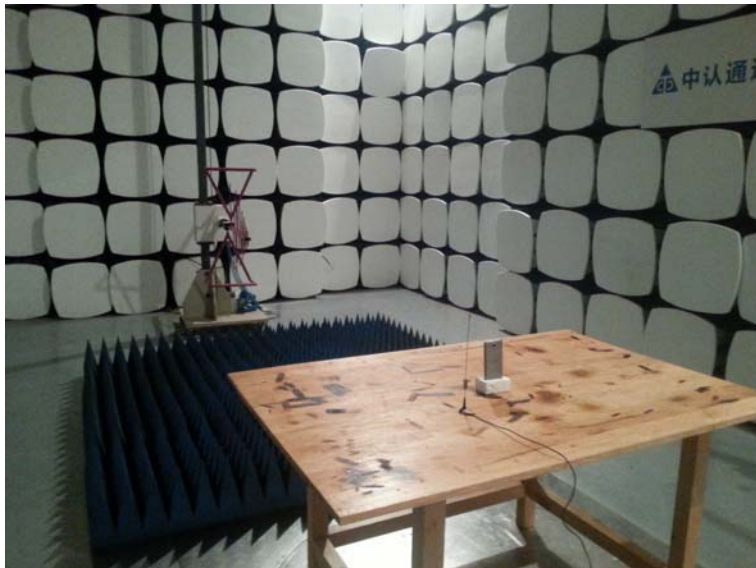

5. PHOTOGRAPHS OF EUT CONSTRUCTIONAL

External Photos of EUT











Internal Photos of EUT



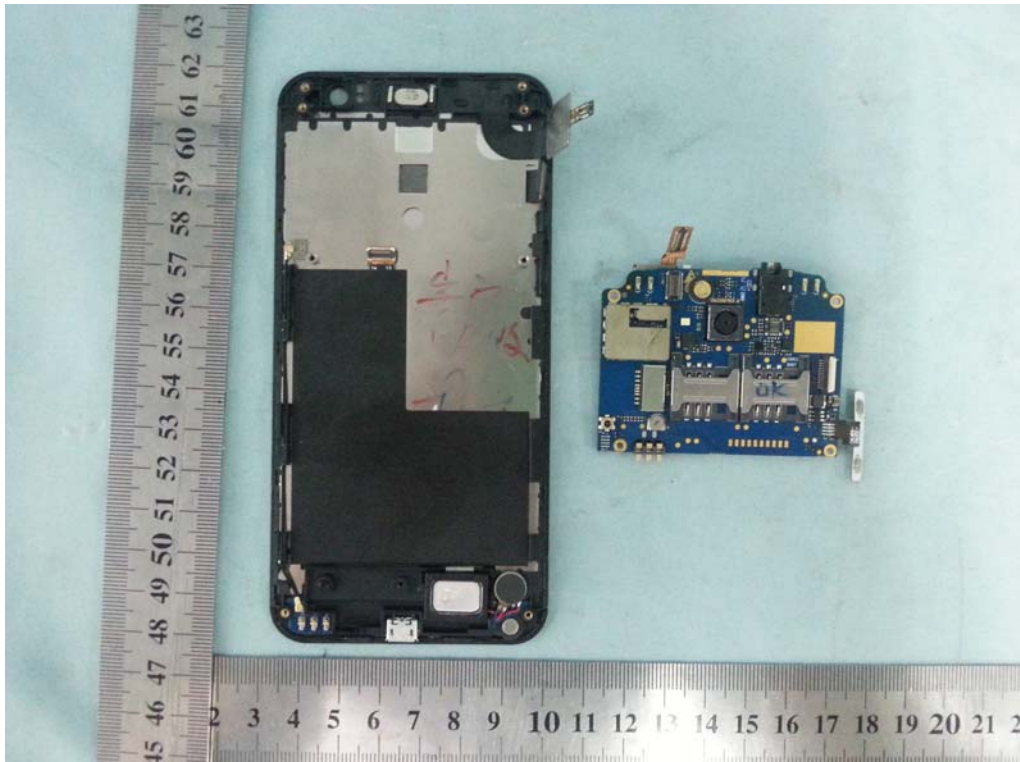

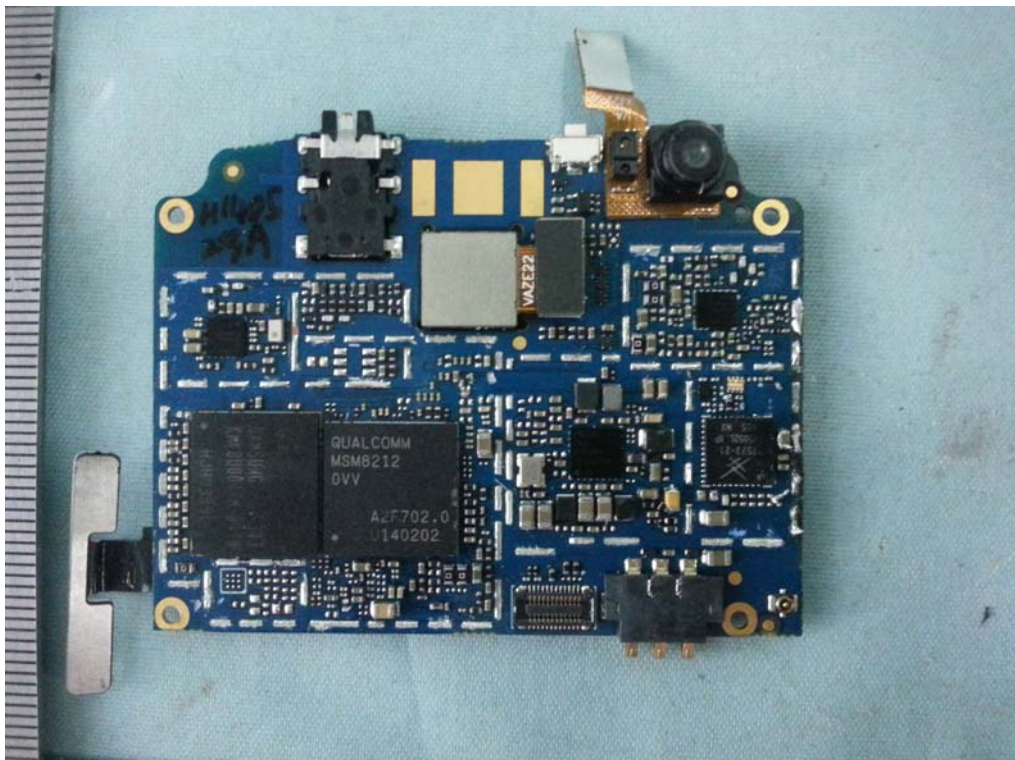
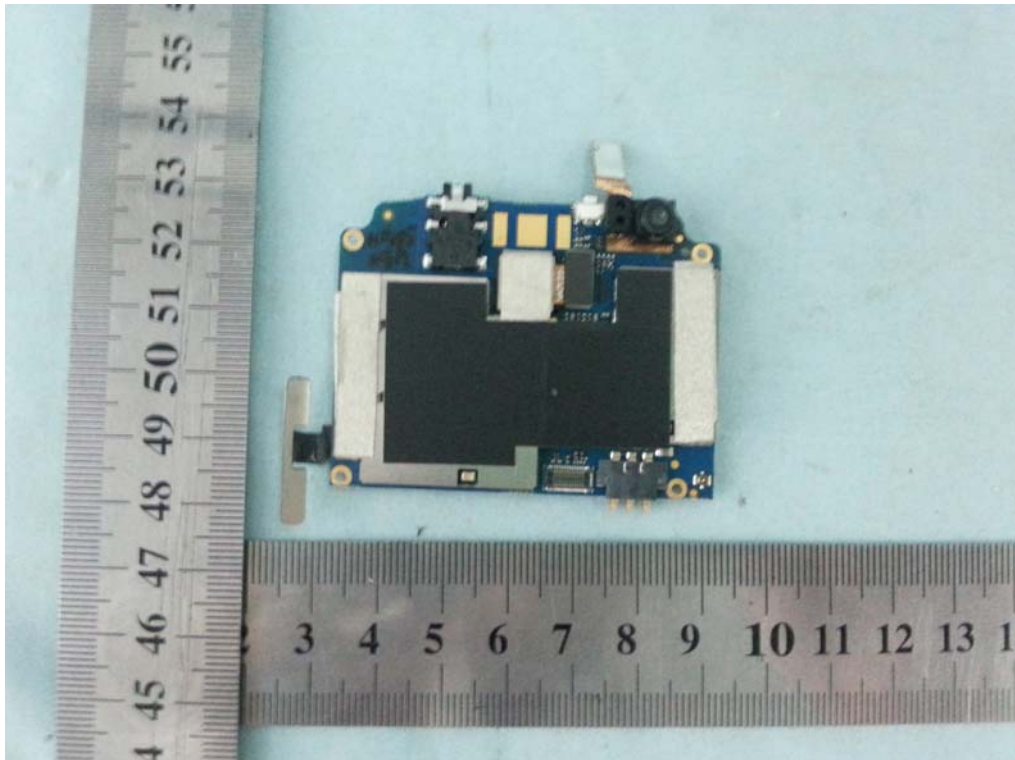

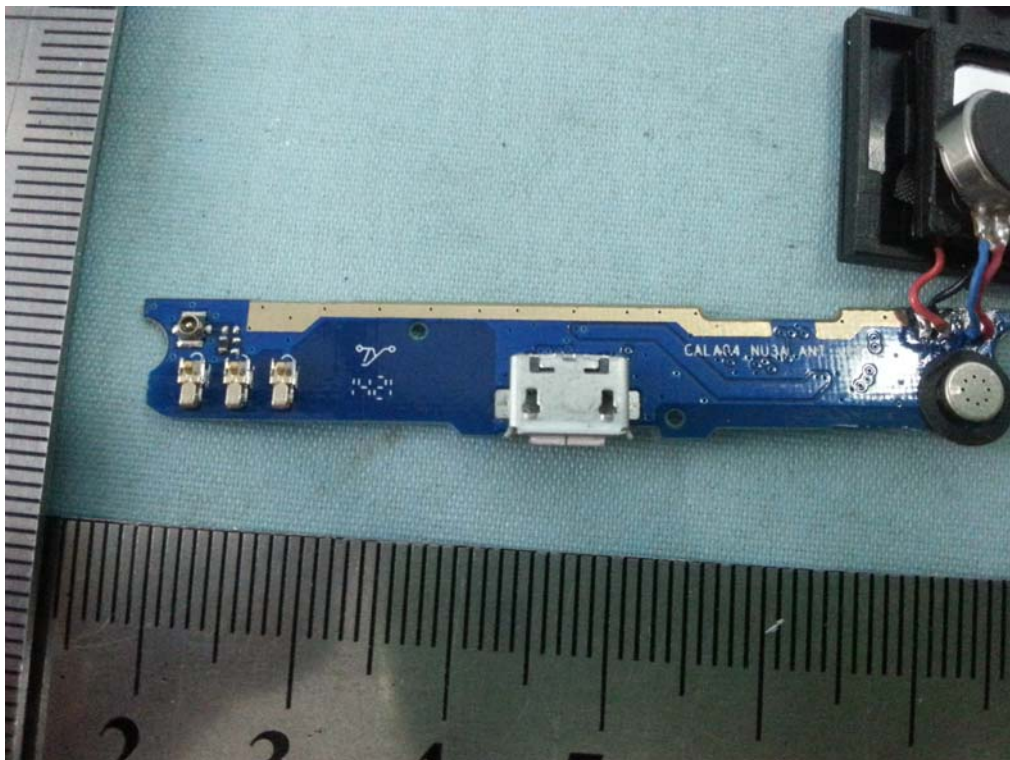

*****THE END*****