

# RF TEST REPORT



Report No.: 15071019-FCC-R2

Supersede Report No.: N/A

Applicant	Sun Cupid Technology (HK) Ltd.	
Product Name	LTE Mobile phone	
Model No.	N4L	
Serial No.	N/A	
Test Standard	FCC Part 15.247: 2014, ANSI C63.10: 2013	
Test Date	July 30 to August 13, 2015	
Issue Date	November 05, 2015	
Test Result	<input checked="" type="checkbox"/> Pass <input type="checkbox"/> Fail	
Equipment complied with the specification	<input checked="" type="checkbox"/>	
Equipment did not comply with the specification	<input type="checkbox"/>	
<i>Winnie Zhang</i>	<i>David Huang</i>	
Winnie Zhang Test Engineer	David Huang Checked By	
This test report may be reproduced in full only Test result presented in this test report is applicable to the tested sample only		

Issued by:

**SIEMIC (SHENZHEN-CHINA) LABORATORIES**

Zone A, Floor 1, Building 2 Wan Ye Long Technology Park

South Side of Zhoushi Road, Bao'an District, Shenzhen, Guangdong China 518108

Phone: +86 0755 2601 4629801 Email: [China@siemic.com.cn](mailto:China@siemic.com.cn)

## Laboratories Introduction

SIEMIC, headquartered in the heart of Silicon Valley, with superior facilities in US and Asia, is one of the leading independent testing and certification facilities providing customers with one-stop shop services for Compliance Testing and Global Certifications.



In addition to testing and certification, SIEMIC provides initial design reviews and compliance management throughout a project. Our extensive experience with China, Asia Pacific, North America, European, and International compliance requirements, assures the fastest, most cost effective way to attain regulatory compliance for the global markets.

### Accreditations for Conformity Assessment

Country/Region	Scope
USA	EMC, RF/Wireless, SAR, Telecom
Canada	EMC, RF/Wireless, SAR, Telecom
Taiwan	EMC, RF, Telecom, SAR, Safety
Hong Kong	RF/Wireless, SAR, Telecom
Australia	EMC, RF, Telecom, SAR, Safety
Korea	EMI, EMS, RF, SAR, Telecom, Safety
Japan	EMI, RF/Wireless, SAR, Telecom
Singapore	EMC, RF, SAR, Telecom
Europe	EMC, RF, SAR, Telecom, Safety

Test Report	15071019-FCC-R2
Page	3 of 60

This page has been left blank intentionally.

# CONTENTS

1. REPORT REVISION HISTORY .....	5
2. CUSTOMER INFORMATION .....	5
3. TEST SITE INFORMATION.....	5
4. EQUIPMENT UNDER TEST (EUT) INFORMATION.....	6
5. TEST SUMMARY .....	9
6. MEASUREMENTS, EXAMINATION AND DERIVED RESULTS .....	10
6.1 ANTENNA REQUIREMENT.....	10
6.2 CHANNEL SEPARATION .....	11
6.3 20DB BANDWIDTH.....	15
6.4 PEAK OUTPUT POWER.....	19
6.5 NUMBER OF HOPPING CHANNEL.....	23
6.6 TIME OF OCCUPANCY (DWELL TIME) .....	25
6.7 BAND EDGE.....	29
6.8 AC POWER LINE CONDUCTED EMISSIONS.....	37
6.9 RADIATED SPURIOUS EMISSIONS.....	43
ANNEX A. TEST INSTRUMENT.....	48
ANNEX B. EUT AND TEST SETUP PHOTOGRAPHS.....	49
ANNEX C. TEST SETUP AND SUPPORTING EQUIPMENT.....	55
ANNEX D. USER MANUAL / BLOCK DIAGRAM / SCHEMATICS / PARTLIST.....	59
ANNEX E. DECLARATION OF SIMILARITY.....	60

## 1. Report Revision History

Report No.	Report Version	Description	Issue Date
15071019-FCC-R2	NONE	Original	November 05, 2015

## 2. Customer information

Applicant Name	Sun Cupid Technology (HK) Ltd.
Applicant Add	16/F, CEO Tower, 77 Wing Hong St, Cheung Sha Wan, Kowloon
Manufacturer	SUNCUPID (SHENZHEN) ELECTRONIC LTD
Manufacturer Add	Baolong Industrial City, Longgang District, Shenzhen Hi-Tech Road, Building 1, A 7

## 3. Test site information

Lab performing tests	SIEMIC (Shenzhen-China) LABORATORIES
Lab Address	Zone A, Floor 1, Building 2 Wan Ye Long Technology Park South Side of Zhoushi Road, Bao' an District, Shenzhen, Guangdong China 518108
FCC Test Site No.	718246
IC Test Site No.	4842E-1
Test Software	Radiated Emission Program-To Shenzhen v2.0

## 4. Equipment under Test (EUT) Information

Description of EUT:	LTE Moblie phone
Main Model:	N4L
Serial Model:	N/A
Date EUT received:	July 29, 2015
Test Date(s):	July 30 to August 13, 2015
Equipment Category :	DSS
Antenna Gain:	<p>GSM850: 0.08 dBi  PCS1900: 0.8 dBi  UMTS-FDD Band V: 0.08 dBi  UMTS-FDD Band IV: 0.73 dBi  UMTS-FDD Band II: 0.89 dBi  Bluetooth/BLE: 0.93 dBi  WIFI(2.4G): 0.93 dBi  WIFI(5G): 1.82 dBi  LTE Band 2: 0.88 dBi  LTE Band 4: 0.75 dBi  LTE Band 5: 0.07 dBi  LTE Band 12: -1.73 dBi  LTE Band 17: -1.73 dBi  GPS:-0.32dBi</p>
Type of Modulation:	<p>GSM / GPRS: GMSK  EGPRS: GMSK, 8PSK  UMTS-FDD: QPSK, 16QAM  802.11a/b/g/n: DSSS, OFDM  Bluetooth: GFSK, <math>\pi</math> /4DQPSK, 8DPSK  BLE: GFSK  LTE Band: QPSK, 16QAM  GPS:BPSK</p>

	<p>GSM850 TX: 824.2 ~ 848.8 MHz; RX: 869.2 ~ 893.8 MHz</p> <p>PCS1900 TX: 1850.2 ~ 1909.8 MHz; RX: 1930.2 ~ 1989.8 MHz</p> <p>UMTS-FDD Band V TX: 826.4 ~ 846.6 MHz; RX: 871.4 ~ 891.6 MHz</p> <p>UMTS-FDD Band IV TX:1712.4 ~ 1752.6 MHz; RX : 2112.4 ~ 2152.6 MHz</p> <p>UMTS-FDD Band II TX:1852.4 ~ 1907.6 MHz; RX: 1932.4 ~ 1987.6 MHz</p> <p>WiFi:802.11b/g/n(20M): 2412-2462 MHz</p> <p>WiFi:802.11n(40M): 2422-2452 MHz</p> <p>WiFi:802.11a,n(20,40M): 5150-5250 MH</p> <p>Bluetooth&amp; BLE: 2402-2480 MHz</p> <p>LTE Band 2 TX: 1852.5 ~ 1907.5 MHz; RX : 1932.5 ~ 1987.5 MHz</p> <p>LTE Band 4 TX: 1712.5 ~ 1752.5 MHz; RX : 2112.5 ~ 2152.5 MHz</p> <p>LTE Band 5 TX: 826.5 ~ 846.5 MHz; RX : 871.5 ~ 891.5 MHz</p> <p>LTE Band 12 TX:699.7 ~ 715.3 MHz; RX : 729.7~ 745.3MHz</p> <p>LTE Band 17 TX: 706.5 ~ 713.5 MHz; RX : 736.5 ~ 743.5 MHz</p> <p>GPS RX:1575.42 MHz</p>
RF Operating Frequency (ies):	
Max. Output Power:	8.055dBm
Number of Channels:	<p>GSM 850: 124CH</p> <p>PCS1900: 299CH</p> <p>UMTS-FDD Band V : 102CH</p> <p>UMTS-FDD Band IV: 202CH</p> <p>UMTS-FDD Band II : 277CH</p> <p>WiFi :802.11b/g/n(20M): 11CH</p> <p>WiFi :802.11n(40M): 7CH</p> <p>Bluetooth: 79CH</p> <p>BLE: 40CH</p> <p>GPS:1CH</p>
Port:	Power Port, Earphone Port, USB Port
Input Power:	<p>Battery:</p> <p>Model:NUBN4</p> <p>Spec: 3.8V,2150mAh,10.0Wh</p> <p>Adapter:</p> <p>Model:KNC005N-050100U</p> <p>Input: AC100-240V; 50/60Hz; 0.2A Max</p>

Test Report	15071019-FCC-R2
Page	8 of 60

---

Output: DC 5.0V,1A

Trade Name : NUU

GPRS/EGPRS Multi-slot class 8/10/12

FCC ID: 2ADINNUUN4L



## 5. Test Summary

The product was tested in accordance with the following specifications.

All testing has been performed according to below product classification:

FCC Rules	Description of Test	Result
§15.203	Antenna Requirement	Compliance
§15.247(a)(1)	Channel Separation	Compliance
§15.247(a)(1)	20 dB Bandwidth	Compliance
§15.247(b)(1)	Peak Output Power	Compliance
§15.247(a)(1)(iii)	Number of Hopping Channel	Compliance
§15.247(a)(1)(iii)	Time of Occupancy (Dwell Time)	Compliance
§15.247(d)	Band Edge	Compliance
§15.207(a)	AC Line Conducted Emissions	Compliance
§15.205, §15.209, §15.247(d)	Radiated Emissions	Compliance

### Measurement Uncertainty

Emissions		
Test Item	Description	Uncertainty
Band Edge and Radiated Spurious Emissions	Confidence level of approximately 95% (in the case where distributions are normal), with a coverage factor of 2 (for EUTs < 0.5m X 0.5m X 0.5m)	+5.6dB/-4.5dB
-	-	-

## 6. Measurements, Examination And Derived Results

### 6.1 Antenna Requirement

#### **Applicable Standard**

According to § 15.203, an intentional radiator shall be designed to ensure that no antenna other than that furnished by the responsible party shall be used with the device. The use of a permanently attached antenna or of an antenna that uses a unique coupling to the intentional radiator shall be considered sufficient to comply with the provisions of this section. The manufacturer may design the unit so that a broken antenna can be replaced by the user, but the user of a standard antenna jack or electrical connector is prohibited. The structure and application of the EUT were analyzed to determine compliance with section §15.203 of the rules. §15.203 state that the subject device must meet the following criteria:

- a. Antenna must be permanently attached to the unit.
- b. Antenna must use a unique type of connector to attach to the EUT.

Unit must be professionally installed, and installer shall be responsible for verifying that the correct antenna is employed with the unit.

And according to FCC 47 CFR section 15.247 (b), if the transmitting antennas of directional gain greater than 6dBi are used, the power shall be reduced by the amount in dB that the directional gain of the antenna exceeds 6 dBi.

#### **Antenna Connector Construction**

The EUT has 3 antennas:

A permanently attached PIFA antenna for Bluetooth/BLE/WIFI, the gain is 0.93dBi for Bluetooth/BLE/WIFI.

A permanently attached PIFA antenna for GSM/PCS/LTE and UMTS, the gain is 0.08dBi for GSM850, 0.8dBi for PCS1900,0.08dBi for UMTS-FDD Band V, 0.73dBi for UMTS-FDD Band IV,0.89dBi for UMTS-FDD Band II,0.88dBi for LTE Band 2,0.75dBi for LTE Band 4, 0.07dBi for LTE Band5,-1.73dBi for LTE Band 12, -1.73dBi for LTE Band 17.

A permanently attached PIFA antenna for GPS, the gain is -0.32dBi for GPS.

**The antenna meets up with the ANTENNA REQUIREMENT.**

**Result:** Compliance.

## 6.2 Channel Separation

Temperature	23°C
Relative Humidity	58%
Atmospheric Pressure	1006mbar
Test date :	August 06, 2015
Tested By :	Winnie Zhang

### Requirement(s):

Spec	Item	Requirement	Applicable
§ 15.247(a)(1)	a)	Channel Separation < 20dB BW and 20dB BW < 25KHz ; Channel Separation Limit=25KHz Chanel Separation < 20dB BW and 20dB BW > 25kHz ; Channel Separation Limit=2/3 20dB BW	<input checked="" type="checkbox"/>

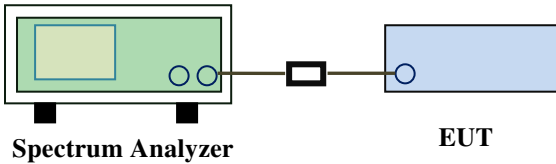
Test Setup	 <p>The diagram shows a green Spectrum Analyzer on the left connected by a black cable to a blue EUT on the right. The Spectrum Analyzer has two small circles on its front panel, and the EUT has one small circle on its front panel.</p>
------------	---

Test Procedure	<p>The test follows FCC Public Notice DA 00-705 Measurement Guidelines. Use the following spectrum analyzer settings:</p> <ul style="list-style-type: none"> <li>- The EUT must have its hopping function enabled</li> <li>- Span = wide enough to capture the peaks of two adjacent channels</li> <li>- Resolution (or IF) Bandwidth (RBW) ≥ 1% of the span</li> <li>- Video (or Average) Bandwidth (VBW) ≥ RBW</li> <li>- Sweep = auto</li> <li>- Detector function = peak</li> <li>- Trace = max hold</li> <li>- Allow the trace to stabilize. Use the marker-delta function to determine the separation between the peaks of the adjacent channels. The limit is specified in one of the subparagraphs of this Section. Submit this plot.</li> </ul>
----------------	--

Remark	
Result	<input checked="" type="checkbox"/> Pass <input type="checkbox"/> Fail

Test Data  Yes  N/A

Test Plot  Yes (See below)  N/A

### Channel Separation measurement result

Type/ Modulation	CH	CH Freq (MHz)	CH Separation (MHz)	Limit (MHz)	Result
CH Separation GFSK	Low Channel	2402	1.005	0.689	Pass
	Adjacency Channel	2403			
	Mid Channel	2440	1.005	0.691	Pass
	Adjacency Channel	2441			
	High Channel	2480	1.005	0.692	Pass
	Adjacency Channel	2479			
CH Separation $\pi/4$ DQPSK	Low Channel	2402	1.005	0.873	Pass
	Adjacency Channel	2403			
	Mid Channel	2440	1.005	0.881	Pass
	Adjacency Channel	2441			
	High Channel	2480	1.005	0.872	Pass
	Adjacency Channel	2479			
CH Separation 8DPSK	Low Channel	2402	1.005	0.875	Pass
	Adjacency Channel	2403			
	Mid Channel	2440	1.005	0.879	Pass
	Adjacency Channel	2441			
	High Channel	2480	1.005	0.875	Pass
	Adjacency Channel	2479			

## Test Plots

### Channel Separation measurement result

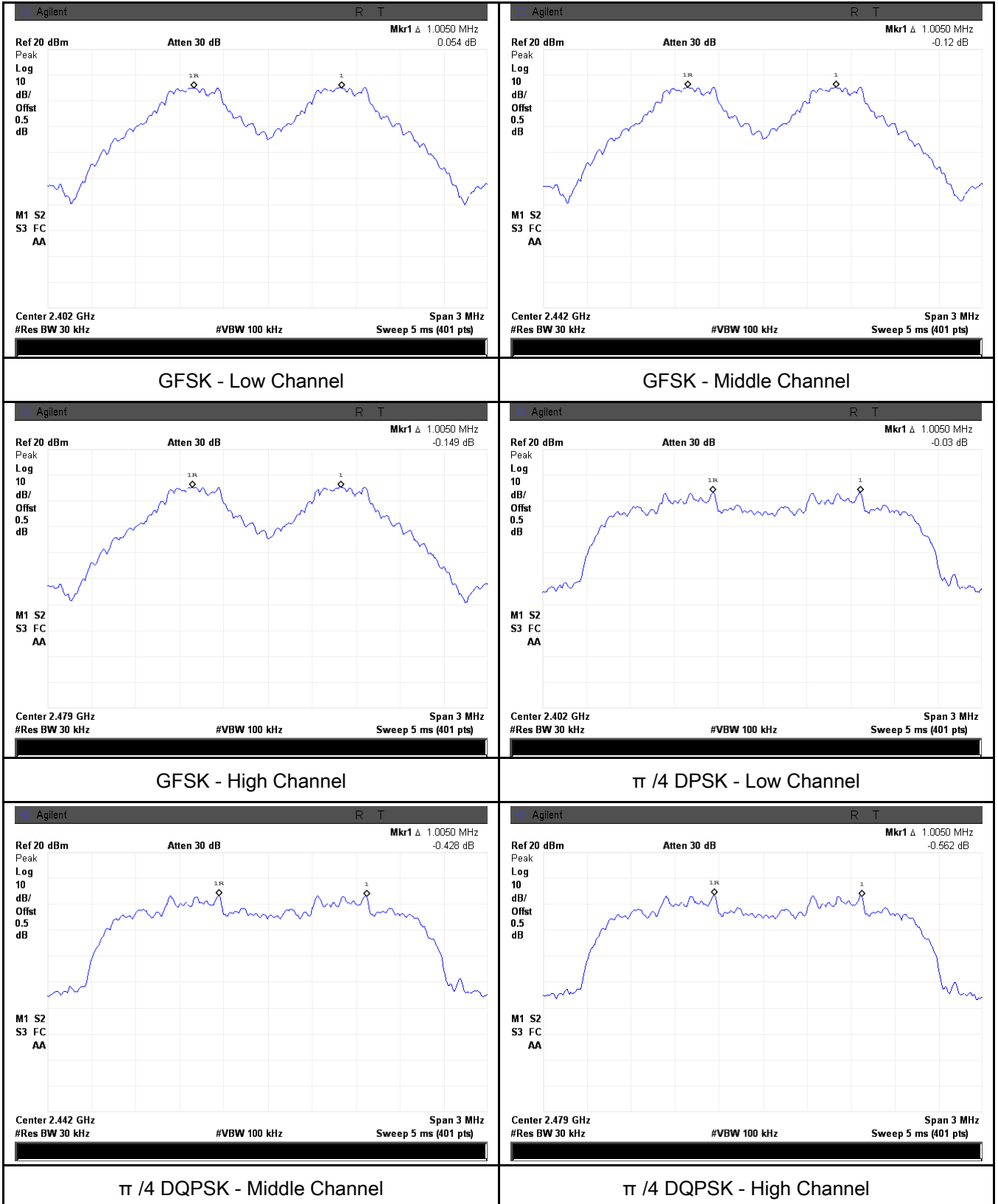

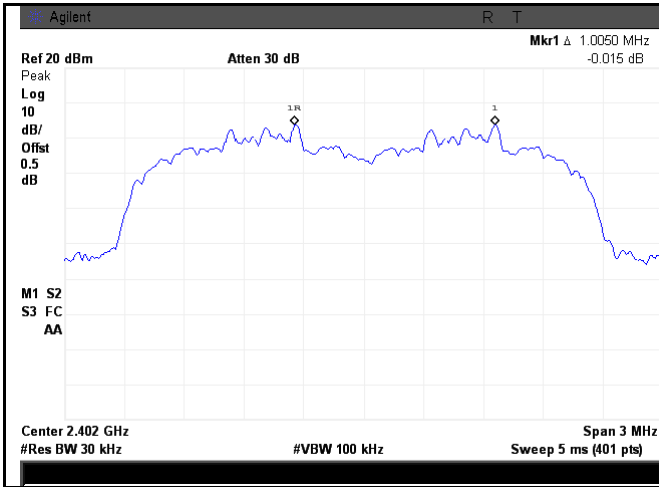

8DPSK - Low Channel

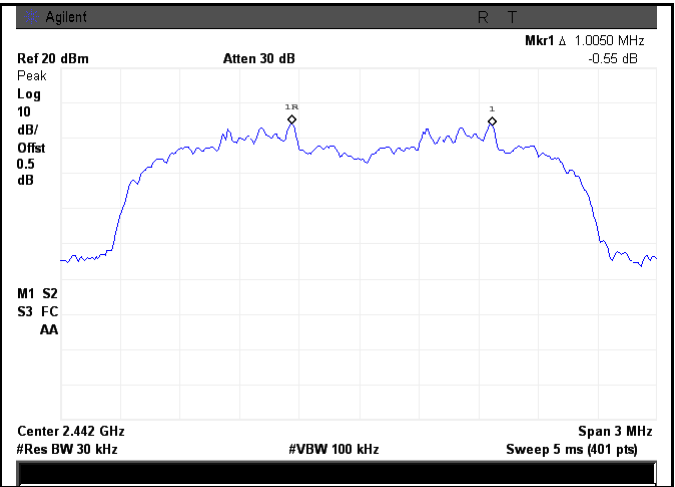

8DPSK - Middle Channel

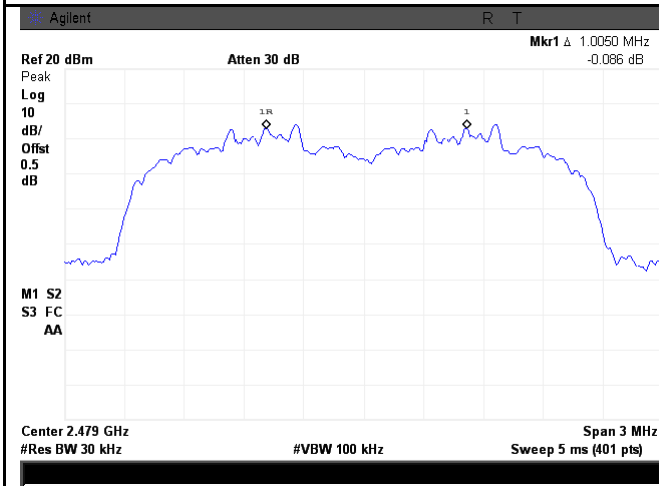

8DPSK - High Channel

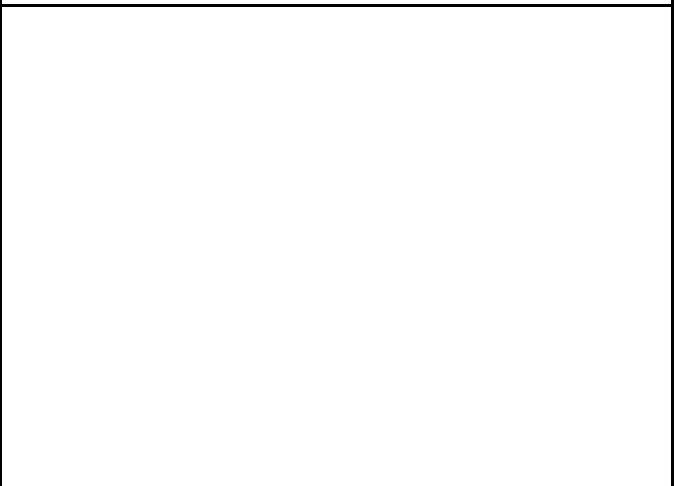

### 6.3 20dB Bandwidth

Temperature	23°C
Relative Humidity	58%
Atmospheric Pressure	1006mbar
Test date :	August 06, 2015
Tested By :	Winnie Zhang

#### Requirement(s):

Spec	Item	Requirement	Applicable
§15.247(a) (1)	a)	Frequency hopping systems shall have hopping channel carrier frequencies separated by a minimum of 25 kHz or the 20 dB bandwidth of the hopping channel, whichever is greater.	<input checked="" type="checkbox"/>

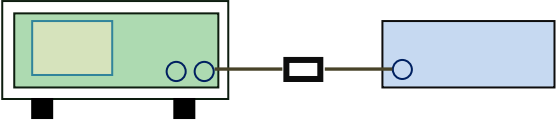
Test Setup	 <p style="text-align: center;">Spectrum Analyzer                      EUT</p>
------------	--

Test Procedure	<p>The test follows FCC Public Notice DA 00-705 Measurement Guidelines. Use the following spectrum analyzer settings:</p> <ul style="list-style-type: none"> <li>- Span = approximately 2 to 3 times the 20 dB bandwidth, centered on a hopping channel</li> <li>- RBW <math>\geq</math> 1% of the 20 dB bandwidth</li> <li>- VBW <math>\geq</math> RBW</li> <li>- Sweep = auto</li> <li>- Detector function = peak</li> <li>- Trace = max hold.</li> <li>- The EUT should be transmitting at its maximum data rate. Allow the trace to stabilize. Use the marker-to-peak function to set the marker to the peak of the emission. Use the marker-delta function to measure 20 dB down one side of the emission. Reset the marker-delta function, and move the marker to the other side of the emission, until it is (as close as possible to) even with the reference</li> </ul>
----------------	--

	marker level. The marker-delta reading at this point is the 20 dB bandwidth of the emission. If this value varies with different modes of operation (e.g., data rate, modulation format, etc.), repeat this test for each variation. The limit is specified in one of the subparagraphs of this Section. Submit this plot(s).
Remark	
Result	<input checked="" type="checkbox"/> Pass <input type="checkbox"/> Fail

Test Data  Yes  N/A

Test Plot  Yes (See below)  N/A

#### Measurement result

Modulation	CH	CH Freq (MHz)	20dB Bandwidth (MHz)	99% Occupied Bandwidth (MHz)
GFSK	Low	2402	1.034	0.8956
	Mid	2441	1.037	0.9039
	High	2480	1.038	0.9093
$\pi/4$ DQPSK	Low	2402	1.309	1.1763
	Mid	2441	1.321	1.1785
	High	2480	1.308	1.1812
8-DPSK	Low	2402	1.312	1.1964
	Mid	2441	1.318	1.2030
	High	2480	1.312	1.1951



## Test Plots

### 20dB Bandwidth measurement result

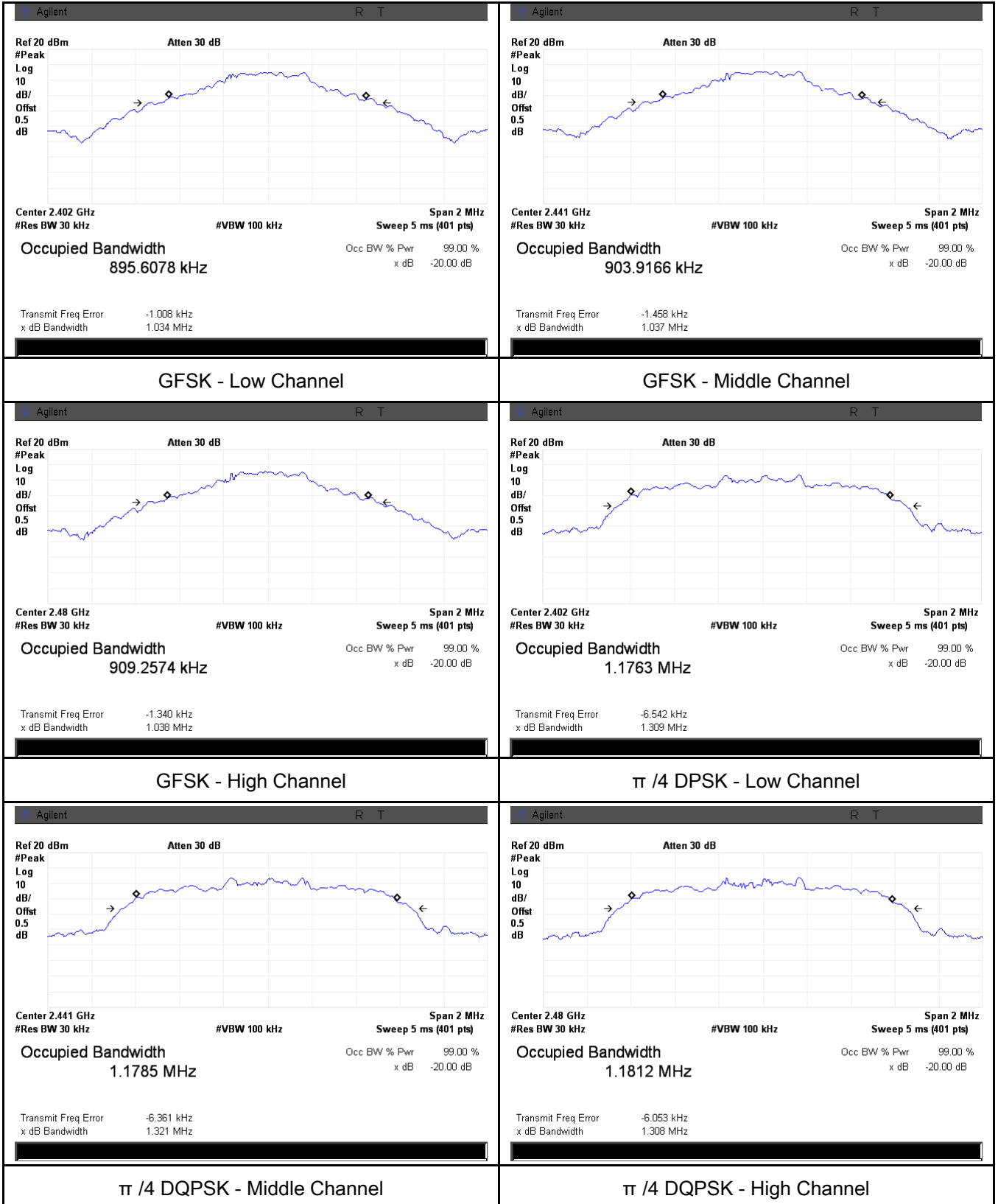

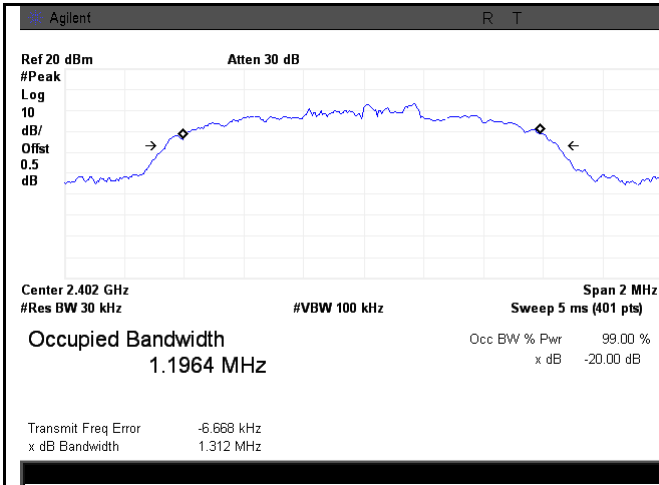

8DPSK - Low Channel

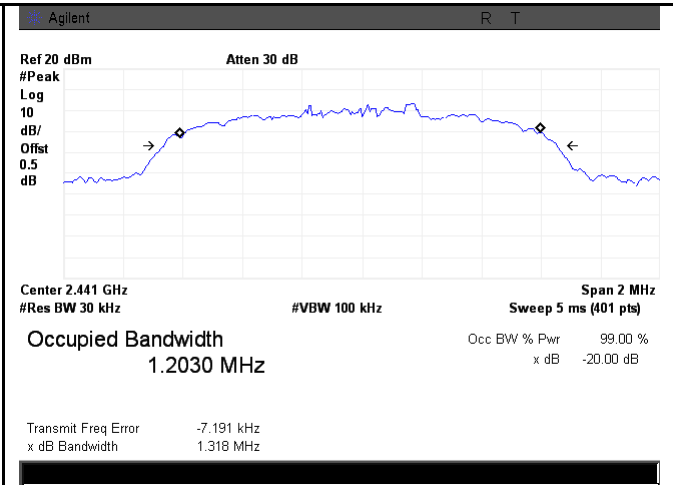

8DPSK - Middle Channel

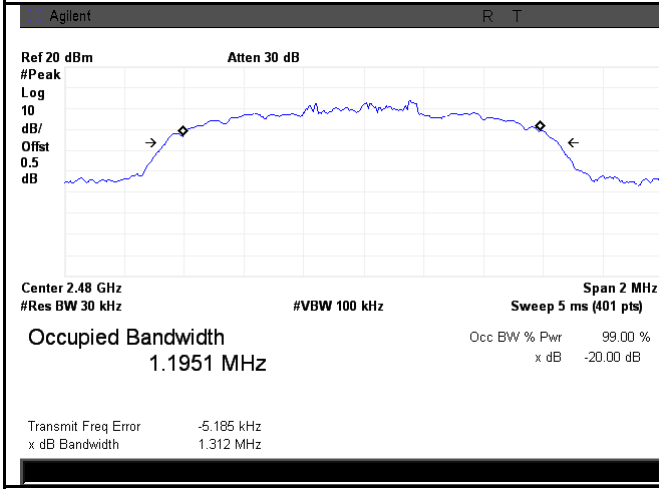

8DPSK - High Channel

## 6.4 Peak Output Power

Temperature	23°C
Relative Humidity	58%
Atmospheric Pressure	1006mbar
Test date :	August 06, 2015
Tested By :	Winnie Zhang

### Requirement(s):

Spec	Item	Requirement	Applicable
§15.247(b) (2)	a)	FHSS in 2400-2483.5MHz with $\geq 75$ channels: $\leq 1$ Watt	<input checked="" type="checkbox"/>
	b)	FHSS in 5725-5850MHz: $\leq 1$ Watt	<input type="checkbox"/>
	c)	For all other FHSS in the 2400-2483.5MHz band: $\leq 0.125$ Watt.	<input checked="" type="checkbox"/>
	d)	FHSS in 902-928MHz with $\geq 50$ channels: $\leq 1$ Watt	<input type="checkbox"/>
	e)	FHSS in 902-928MHz with $\geq 25$ & $< 50$ channels: $\leq 0.25$ Watt	<input type="checkbox"/>
	f)	DSSS in 902-928MHz, 2400-2483.5MHz, 5725-5850MHz: $\leq 1$ Watt	<input type="checkbox"/>

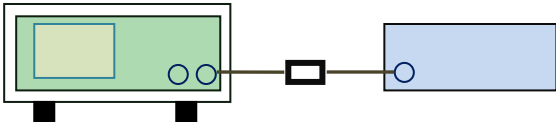
Test Setup	 <p style="text-align: center;">Spectrum Analyzer                      EUT</p>
------------	--

Test Procedure	<p>The test follows FCC Public Notice DA 00-705 Measurement Guidelines. Use the following spectrum analyzer settings:</p> <ul style="list-style-type: none"> <li>- Span = approximately 5 times the 20 dB bandwidth, centered on a hopping channel</li> <li>- RBW &gt; the 20 dB bandwidth of the emission being measured</li> <li>- VBW <math>\geq</math> RBW</li> <li>- Sweep = auto</li> <li>- Detector function = peak</li> <li>- Trace = max hold</li> </ul>
----------------	---

	<ul style="list-style-type: none"> <li>- Allow the trace to stabilize.</li> <li>- Use the marker-to-peak function to set the marker to the peak of the emission. The indicated level is the peak output power (see the note above regarding external attenuation and cable loss). The limit is specified in one of the subparagraphs of this Section. Submit this plot. A peak responding power meter may be used instead of a spectrum analyzer.</li> </ul>
Remark	
Result	<input checked="" type="checkbox"/> Pass <input type="checkbox"/> Fail

Test Data  Yes  N/A  
 Test Plot  Yes (See below)  N/A

**Peak Output Power measurement result**

Type	Modulation	CH	Freq (MHz)	Conducted Power (dBm)	Limit (mW)	Result
Output power	GFSK	Low	2402	7.429	125	Pass
		Mid	2441	7.732	125	Pass
		High	2480	<b>8.055</b>	125	Pass
	$\pi/4$ DQPSK	Low	2402	6.679	125	Pass
		Mid	2441	6.969	125	Pass
		High	2480	7.274	125	Pass
	8-DPSK	Low	2402	6.844	125	Pass
		Mid	2441	7.170	125	Pass
		High	2480	7.470	125	Pass

**Test Plots**

**Output Power measurement result**

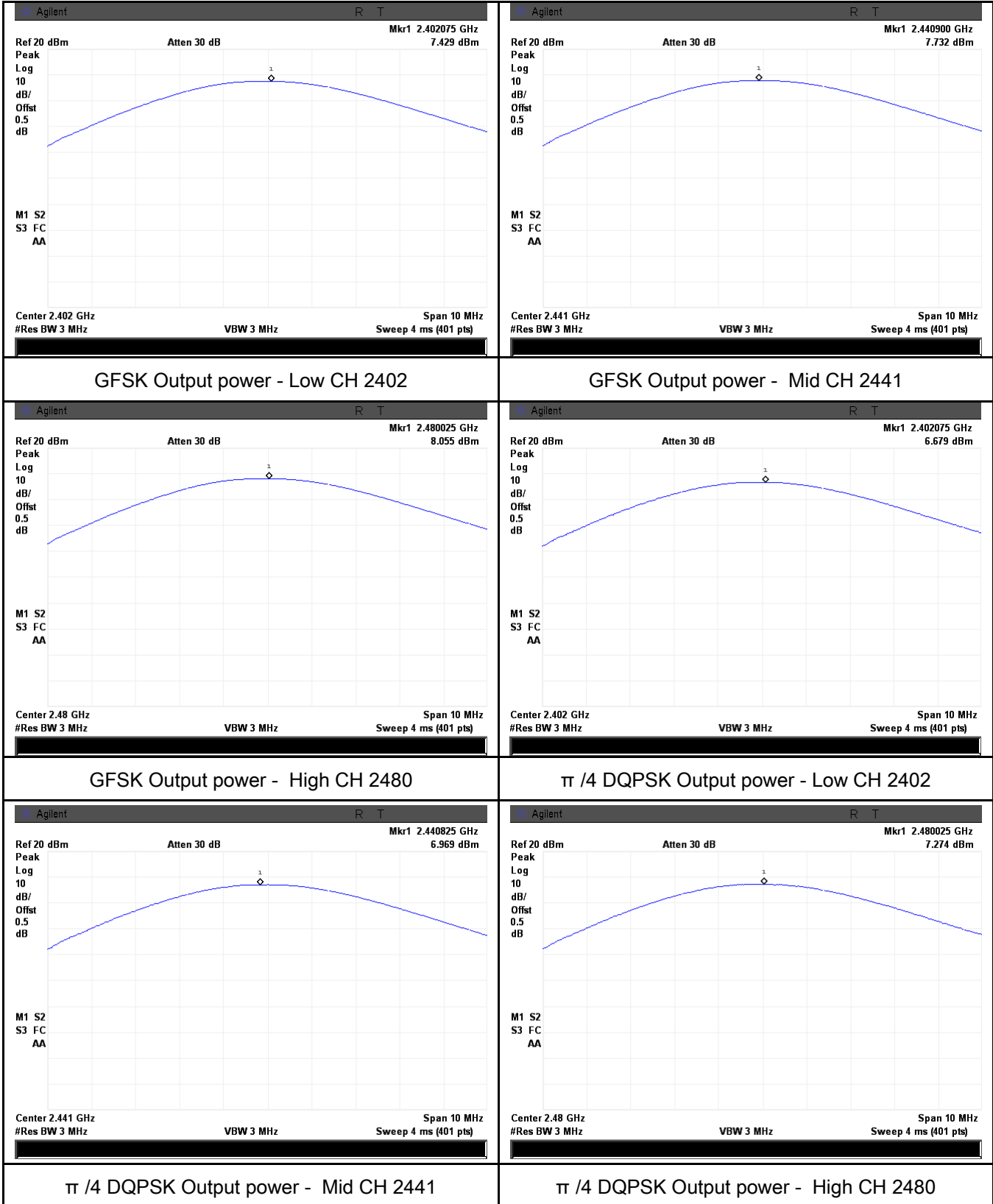

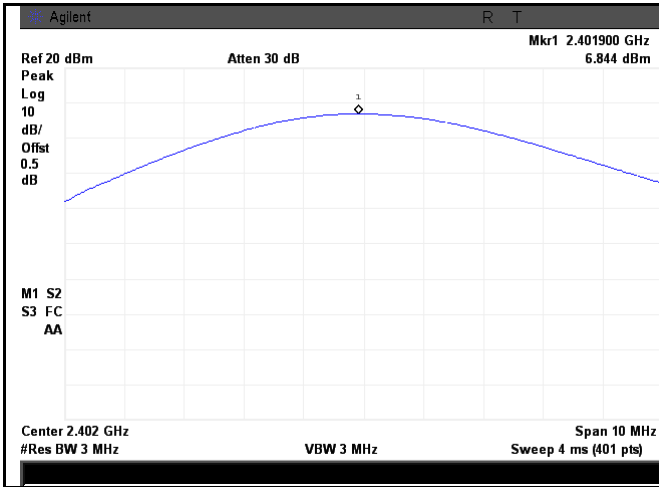

8DPSK Output power - Low CH 2402

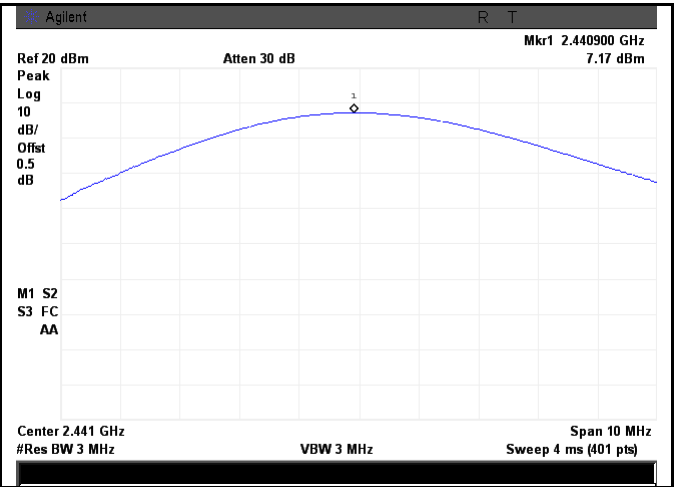

8DPSK Output power - Mid CH 2441

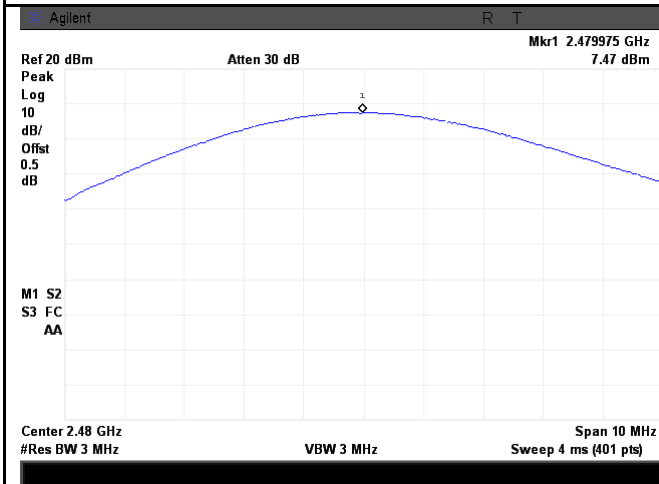

8DPSK Output power - High CH 2480

### 6.5 Number of Hopping Channel

Temperature	24°C
Relative Humidity	59%
Atmospheric Pressure	1007mbar
Test date :	August 07, 2015
Tested By :	Winnie Zhang

#### Requirement(s):

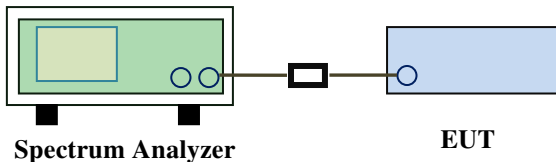
Spec	Item	Requirement	Applicable
§15.247(a) (1)(iii)	a)	FHSS in 2400-2483.5MHz ≥ 15 channels	<input checked="" type="checkbox"/>
Test Setup	 <p style="text-align: center;">Spectrum Analyzer                      EUT</p>		
Test Procedure	<p>The test follows FCC Public Notice DA 00-705 Measurement Guidelines.  <u>Use the following spectrum analyzer settings:</u>            The EUT must have its hopping function enabled.</p> <ul style="list-style-type: none"> <li>- Span = the frequency band of operation</li> <li>- RBW ≥ 1% of the span</li> <li>- VBW ≥ RBW</li> <li>- Sweep = auto</li> <li>- Detector function = peak</li> <li>- Trace = max hold</li> <li>- Allow trace to fully stabilize.</li> <li>- It may prove necessary to break the span up to sections, in order to clearly show all of the hopping frequencies. The limit is specified in one of the subparagraphs of this Section. Submit this plot(s).</li> </ul>		
Remark			
Result	<input checked="" type="checkbox"/> Pass <input type="checkbox"/> Fail		

Test Data     Yes                       N/A  
 Test Plot     Yes (See below)                       N/A

### Number of Hopping Channel measurement result

Type	Modulation	Frequency Range	Number of Hopping Channel	Limit
Number of Hopping Channel	GFSK	2400-2483.5	79	15
	$\pi/4$ DQPSK	2400-2483.5	79	15
	8-DPSK	2400-2483.5	79	15

### Test Plots

#### Number of Hopping Channels measurement result

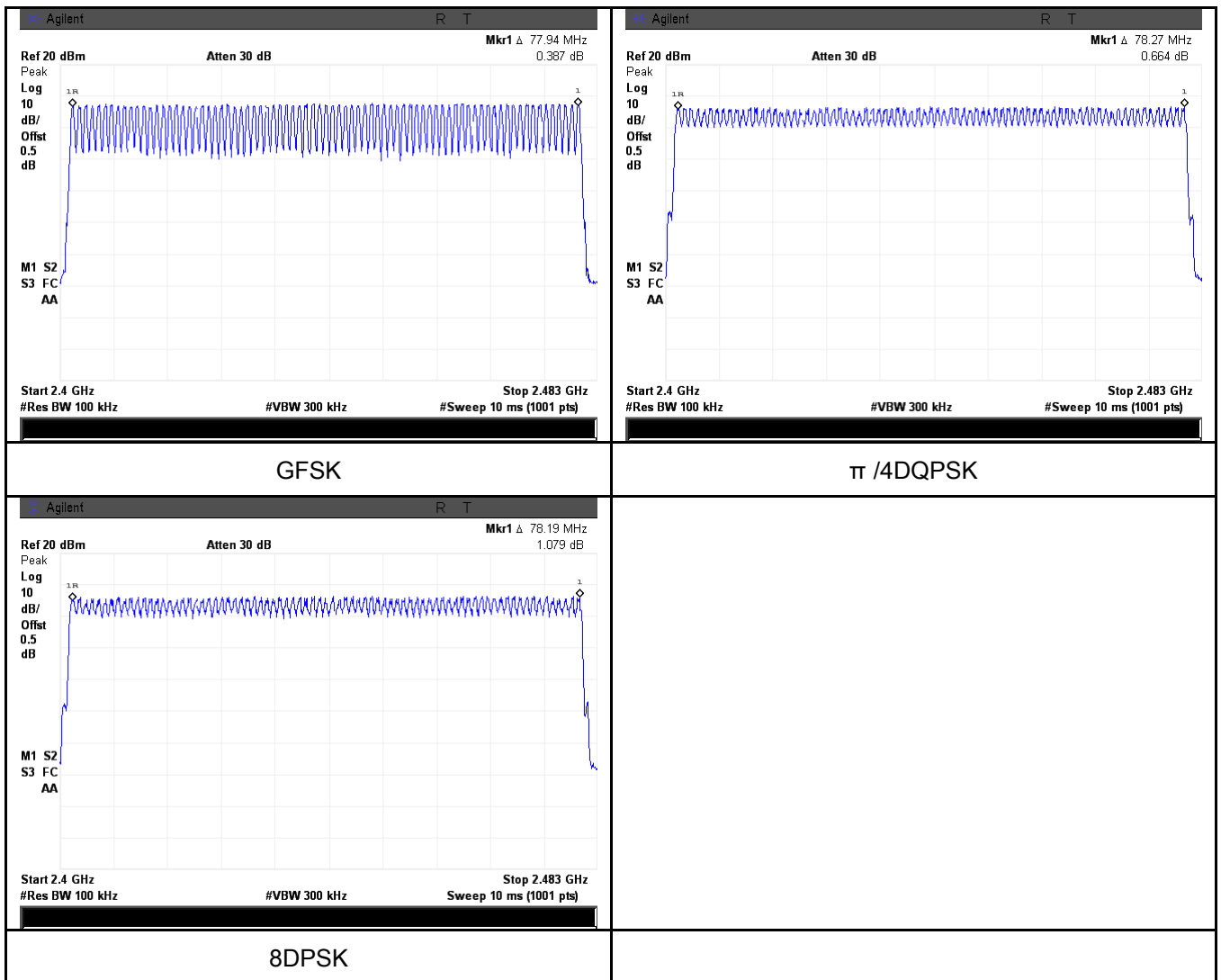



## 6.6 Time of Occupancy (Dwell Time)

Temperature	23°C
Relative Humidity	58%
Atmospheric Pressure	1006mbar
Test date :	August 06, 2015
Tested By :	Winnie Zhang

### Requirement(s):

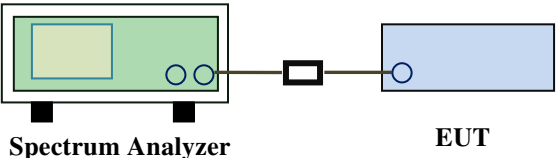
Spec	Item	Requirement	Applicable
§15.247(a) (1)(iii)	a)	Dwell Time < 0.4s	<input checked="" type="checkbox"/>
Test Setup	 <p style="text-align: center;">Spectrum Analyzer                      EUT</p>		
Test Procedure	<p>The test follows FCC Public Notice DA 00-705 Measurement Guidelines. <u>Use the following spectrum analyzer</u></p> <ul style="list-style-type: none"> <li>- Span = zero span, centered on a hopping channel</li> <li>- RBW = 1 MHz</li> <li>- VBW ≥ RBW</li> <li>- Sweep = as necessary to capture the entire dwell time per hopping channel</li> <li>- Detector function = peak</li> <li>- Trace = max hold</li> <li>- use the marker-delta function to determine the dwell time</li> </ul>		
Remark			
Result	<input checked="" type="checkbox"/> Pass <input type="checkbox"/> Fail		

Test Data     Yes                       N/A

Test Plot     Yes (See below)                       N/A

**Dwell Time measurement result**

Type	Modulation	CH	Pulse Width (ms)	Dwell Time (ms)	Limit (ms)	Result
Dwell Time	GFSK	Low	2.90	309.333	400	Pass
		Mid	2.89	308.267	400	Pass
		High	2.90	309.333	400	Pass
	π /4 DQPSK	Low	2.91	310.400	400	Pass
		Mid	2.90	309.333	400	Pass
		High	2.90	309.333	400	Pass
	8-DPSK	Low	2.90	309.333	400	Pass
		Mid	2.91	310.400	400	Pass
		High	2.90	309.333	400	Pass

Note: Dwell time=Pulse Time (ms) × (1600 ÷ 6 ÷ 79) ×31.6

**Test Plots**

**Dwell Time measurement result**

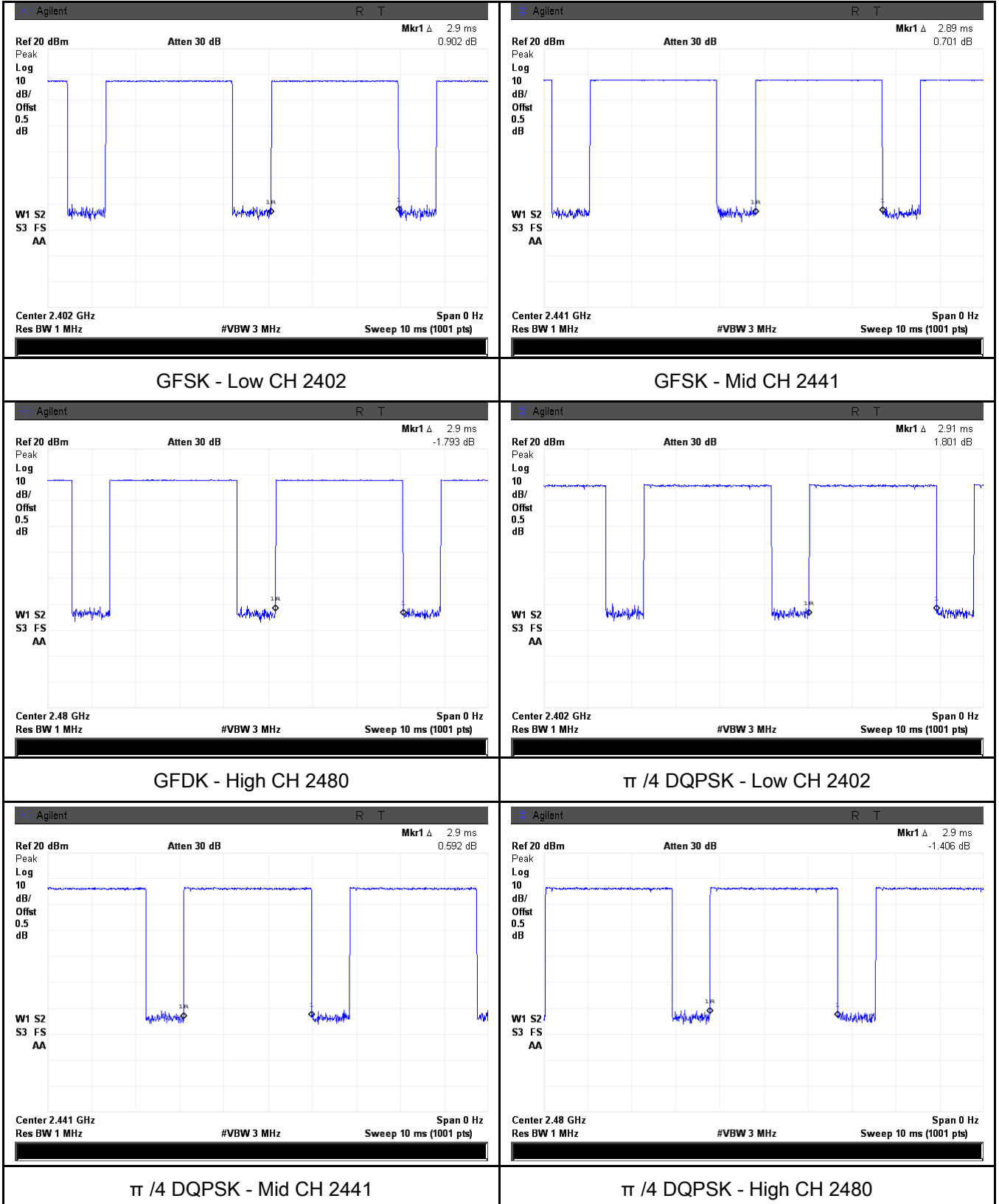

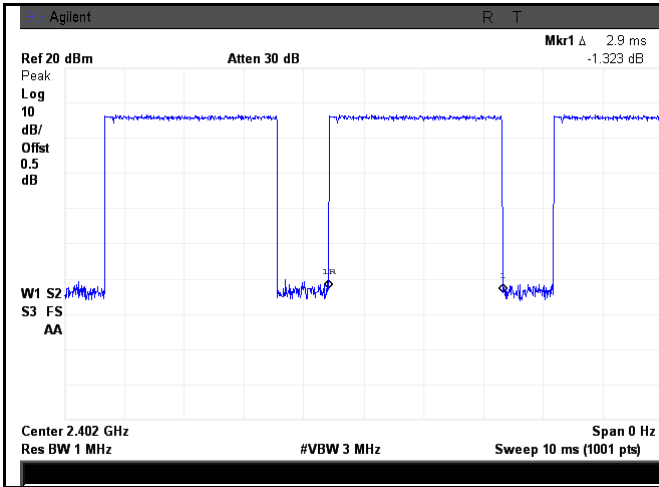

8DPSK - Low CH 2402

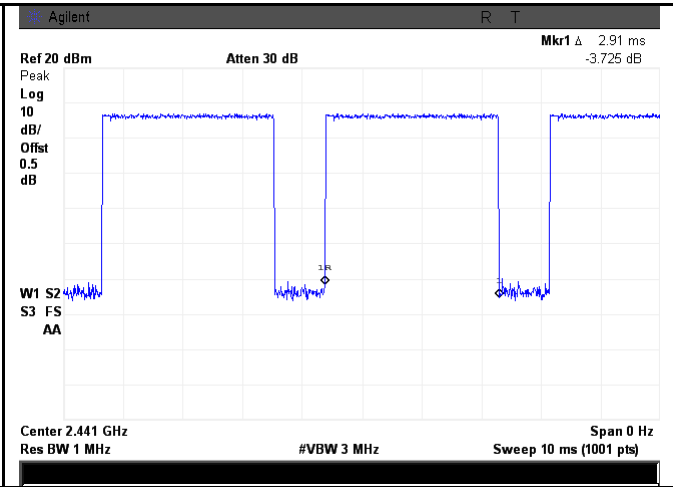

8DPSK - Mid CH 2441

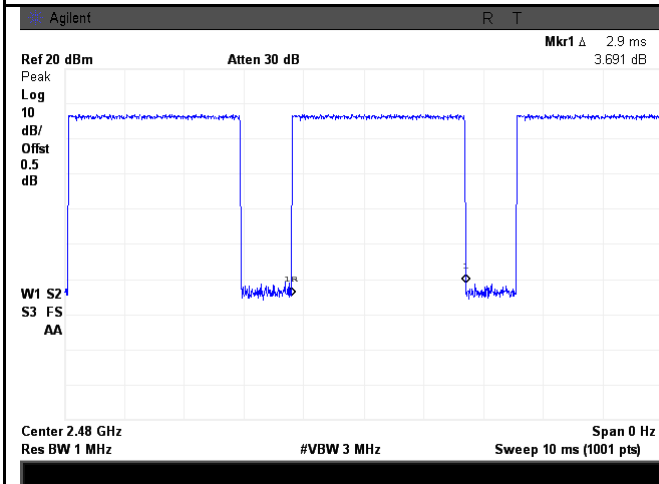

8DPSK - High CH 2480

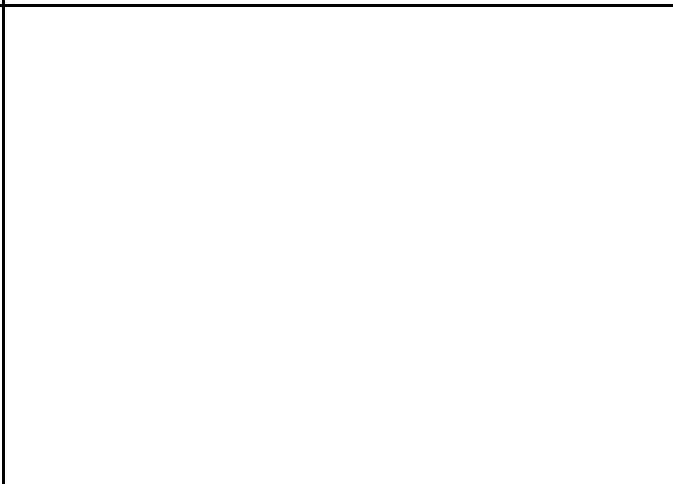

## 6.7 Band Edge

Temperature	23°C
Relative Humidity	54%
Atmospheric Pressure	1030mbar
Test date :	July 30, 2015
Tested By :	Winnie Zhang

### Requirement(s):

Spec	Item	Requirement	Applicable
§15.247(a) (1)(iii)	a)	In any 100 kHz bandwidth outside the frequency band in which the spread spectrum or digitally modulated intentional radiator is operating, the radio frequency power that is produced by the intentional radiator shall be at least 20 dB below that in the 100 kHz bandwidth within the band that contains the highest level of the desired power, based on either an RF conducted or a radiated measurement, provided the transmitter demonstrates compliance with the peak conducted power limits.	<input checked="" type="checkbox"/>

Test Setup	
------------	--

Test Procedure	<p>The test follows FCC Public Notice DA 00-705 Measurement Guidelines. Radiated Method Only</p> <ul style="list-style-type: none"> <li>- 1. Check the calibration of the measuring instrument using either an internal calibrator or a known signal from an external generator.</li> <li>- 2. Position the EUT without connection to measurement instrument. Put it on the Rotated table and turn on the EUT and make it operate in transmitting mode. Then set it to Low Channel and High Channel within its operating range,</li> </ul>
----------------	--

Test Report	15071019-FCC-R2
Page	30 of 60

	<p>and make sure the instrument is operated in its linear range.</p> <ul style="list-style-type: none"> <li>- 3. First, set both RBW and VBW of spectrum analyzer to 100 kHz with a convenient frequency span including 100kHz bandwidth from band edge, check the emission of EUT, if pass then set Spectrum Analyzer as below:           <ul style="list-style-type: none"> <li>a. The resolution bandwidth and video bandwidth of test receiver/spectrum analyzer is 120 kHz for Quasiy Peak detection at frequency below 1GHz.</li> <li>b. The resolution bandwidth of test receiver/spectrum analyzer is 1MHz and video bandwidth is 3MHz with Peak detection for Peak measurement at frequency above 1GHz.</li> <li>c. The resolution bandwidth of test receiver/spectrum analyzer is 1MHz and the video bandwidth is 10Hz with Peak detection for Average Measurement as below at frequency above 1GHz.</li> </ul> </li> <li>- 4. Measure the highest amplitude appearing on spectral display and set it as a reference level. Plot the graph with marking the highest point and edge frequency.</li> <li>- 5. Repeat above procedures until all measured frequencies were complete.</li> </ul>
Remark	
Result	<input checked="" type="checkbox"/> Pass <input type="checkbox"/> Fail

Test Data     Yes                       N/A  
 Test Plot     Yes (See below)       N/A

**Test Plots**

**GFSK Mode:**

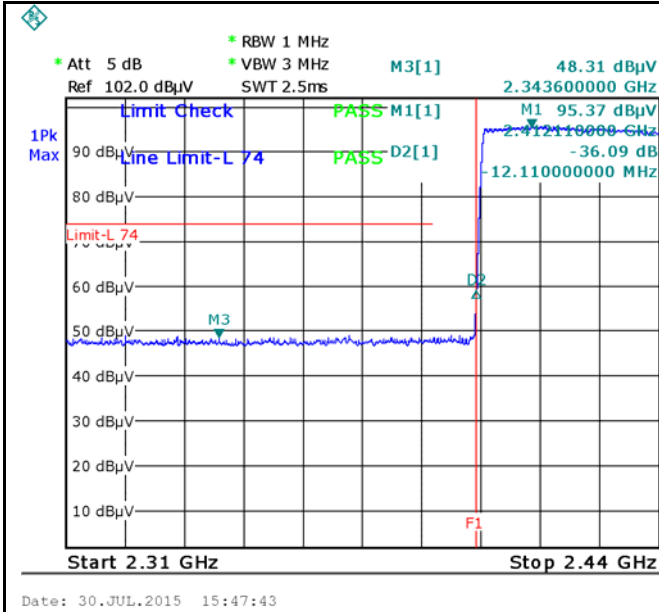

GFSK-Hopping Left Side-PK

Note: F1 is frequency 2400MHz

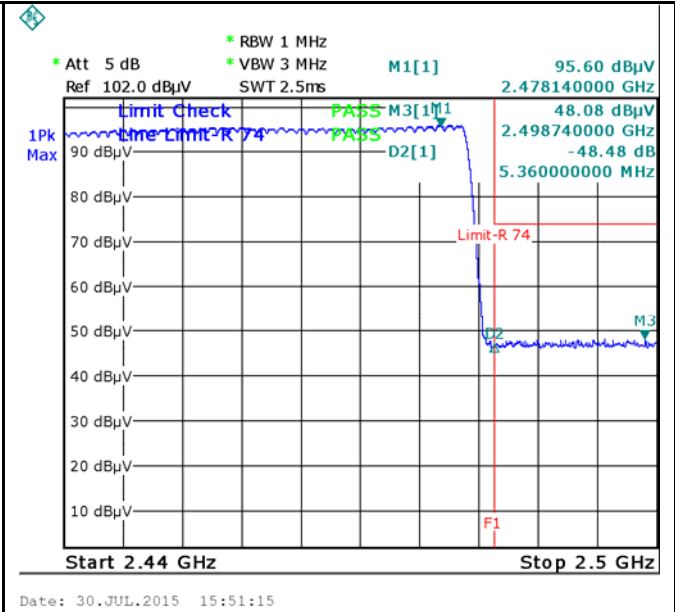

GFSK-Hopping Right Side-PK

Note: F1 is frequency 2483.5MHz

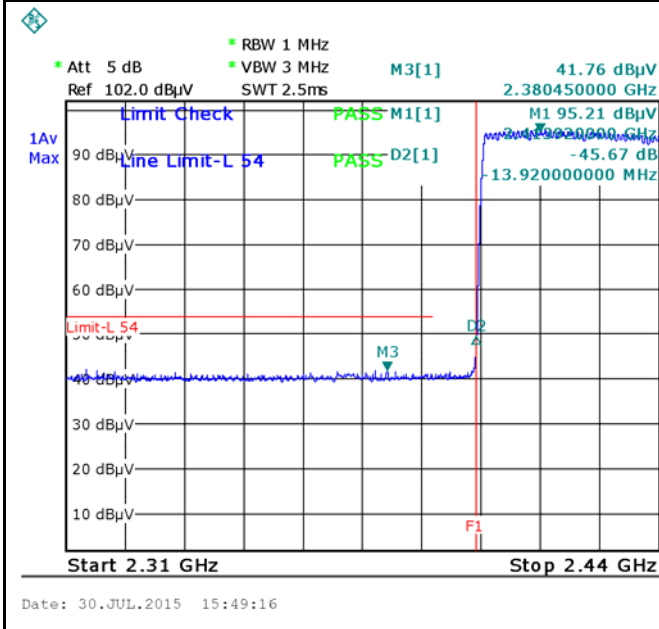

GFSK-Hopping Left Side-AV

Note: (no need if PK value less than the AV limit)

GFSK-Hopping Right Side-AV

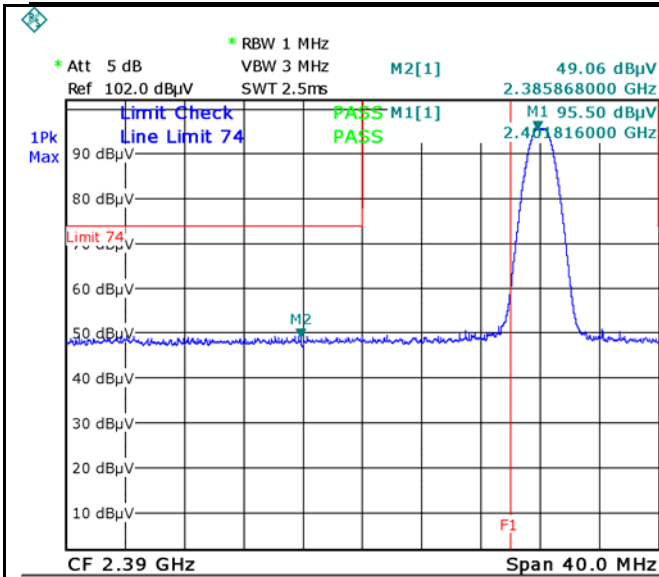

Date: 30.JUL.2015 15:18:28

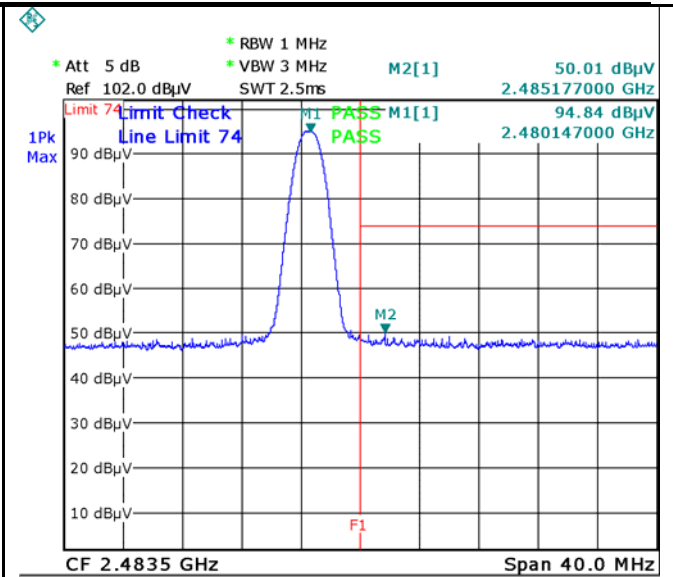

Date: 30.JUL.2015 15:40:32

GFSK-Left Side-PK

Note: F1 is frequency 2400MHz

GFSK-Right Side-PK

Note: F1 is frequency 2483.5MHz

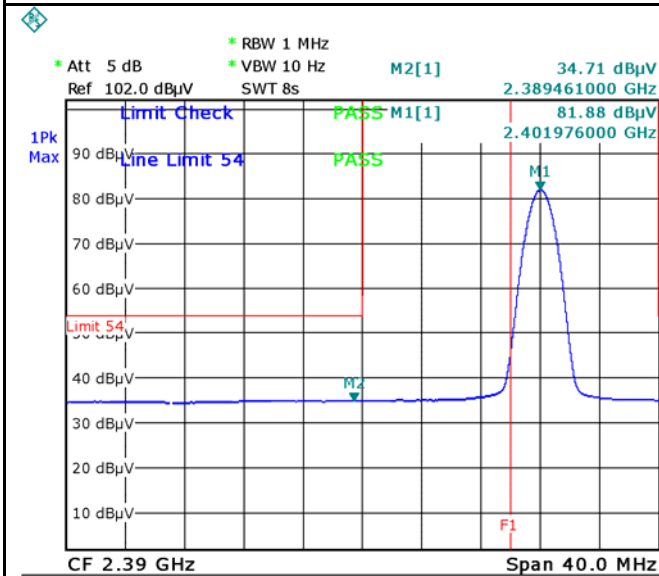

Date: 30.JUL.2015 15:19:37

Note: (no need if PK value less than the AV limit)

GFSK-Left Side-AV

GFSK-Right Side-AV





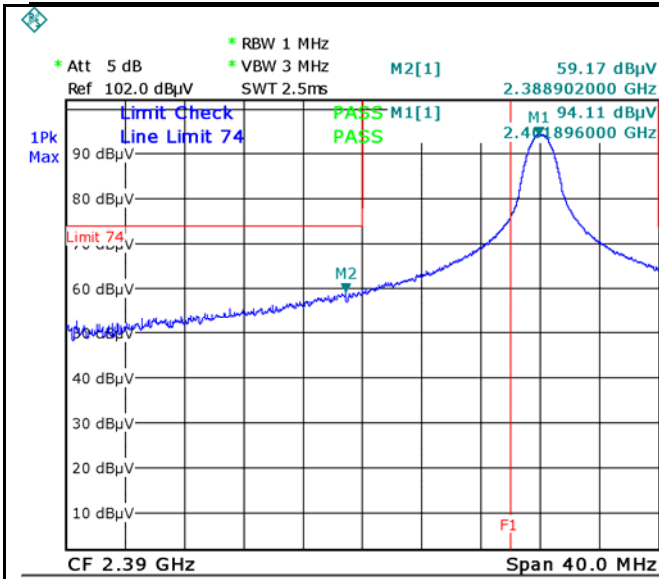

Date: 30.JUL.2015 15:24:06

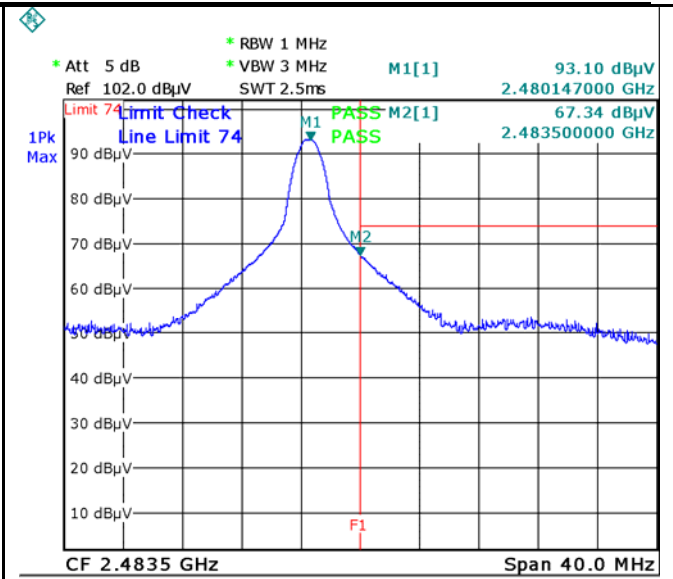

Date: 30.JUL.2015 15:37:27

$\pi$  / 4 DQPSK-Left Side-PK

Note: F1 is frequency 2400MHz

$\pi$  / 4 DQPSK-Right Side-PK

Note: F1 is frequency 2483.5MHz

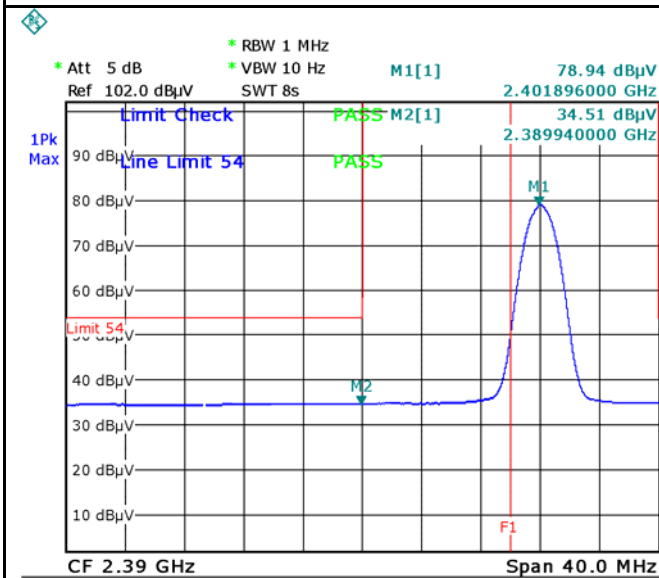

Date: 30.JUL.2015 15:24:55

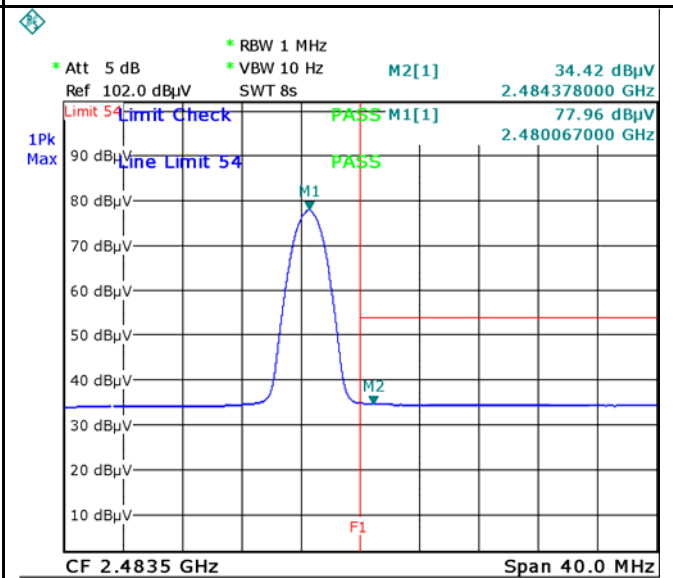

Date: 30.JUL.2015 15:38:14

$\pi$  / 4 DQPSK-Left Side-AV

$\pi$  / 4 DQPSK-Right Side-AV

**8-DPSK Mode:**

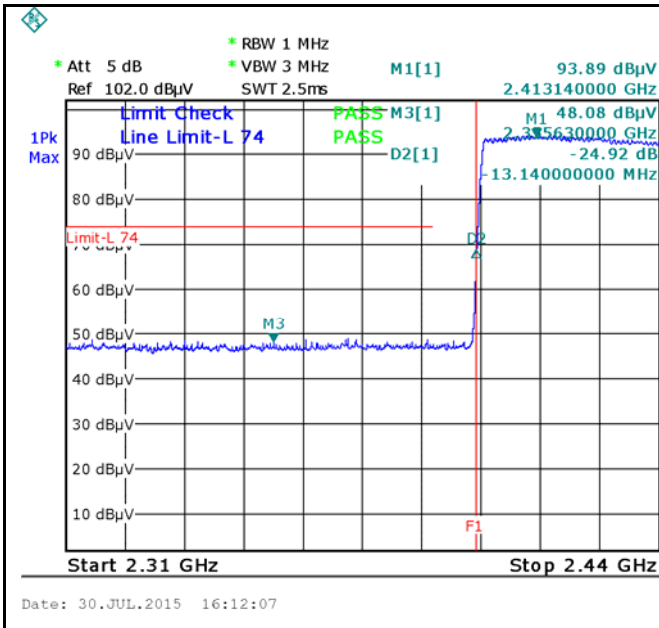

8DPSK-Hopping Left Side-PK

Note: F1 is frequency 2400MHz

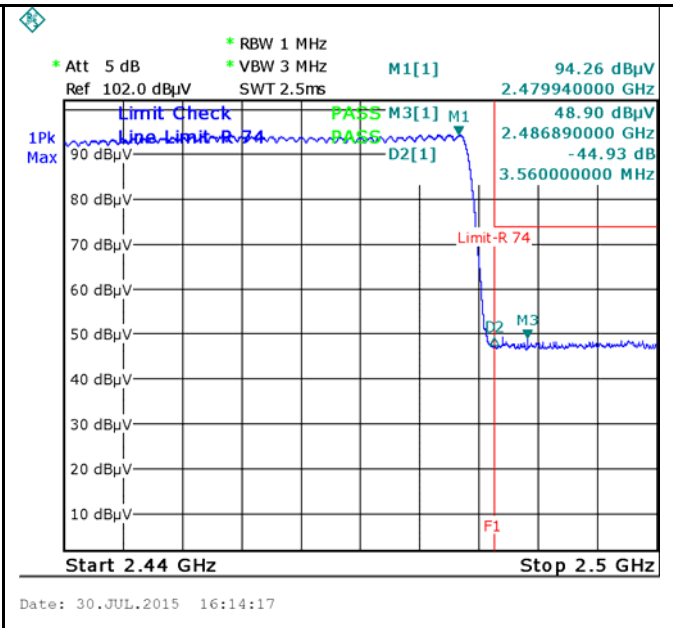

8DPSK-Hopping Right Side-PK

Note: F1 is frequency 2483.5MHz

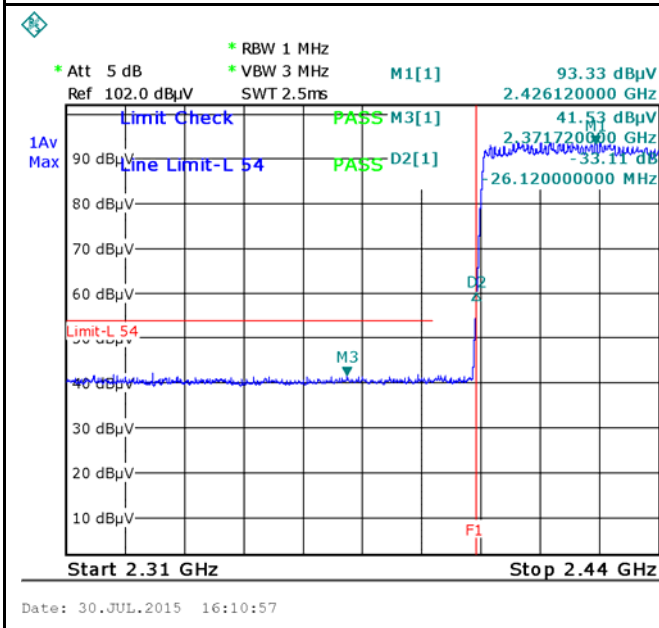

8DPSK-Hopping Left-AV

Note: (no need if PK value less than the AV limit)

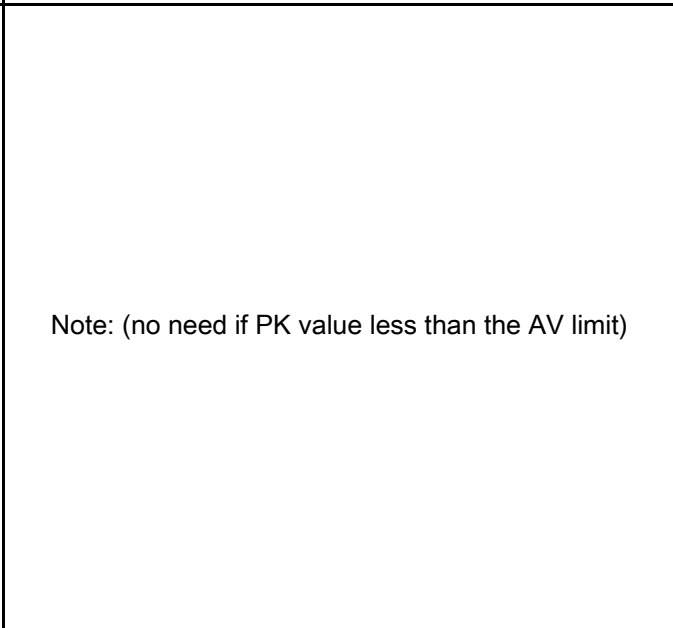

8DPSK-Hopping Right-AV

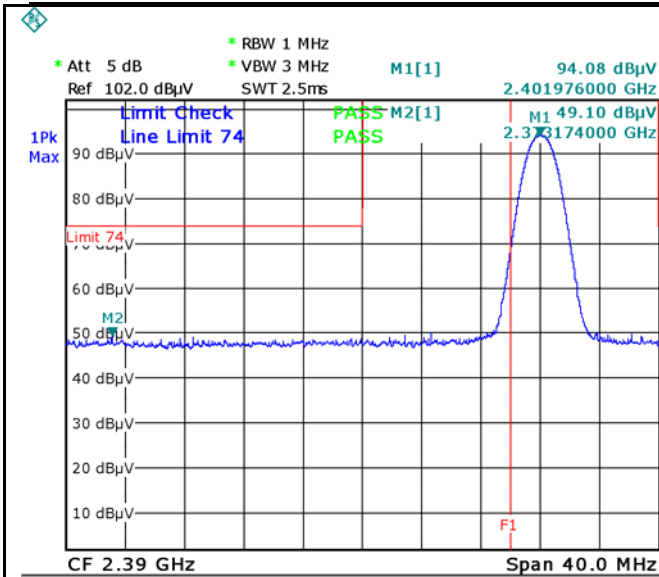

Date: 30.JUL.2015 15:28:42

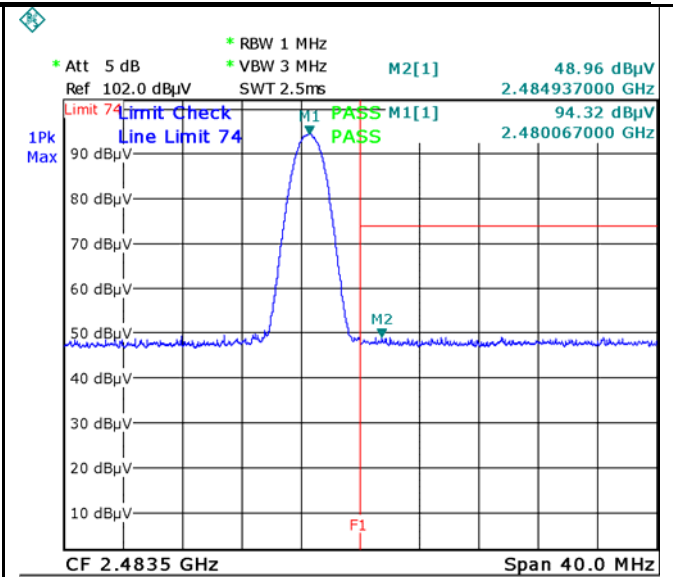

Date: 30.JUL.2015 15:34:19

8DPSK-Left Side-PK

Note: F1 is frequency 2400MHz

8DPSK-Right Side-PK

Note: F1 is frequency 2483.5MHz

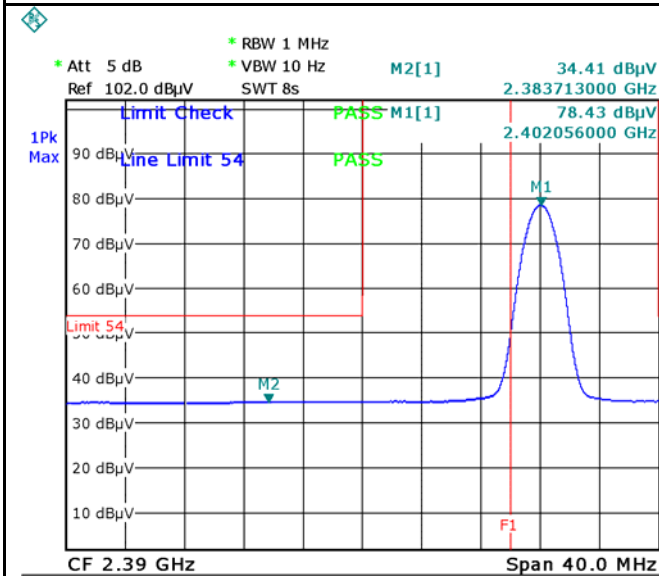

Date: 30.JUL.2015 15:29:37

Note: (no need if PK value less than the AV limit)

8DPSK-Left Side-AV

8DPSK-Right Side-AV

## 6.8 AC Power Line Conducted Emissions

Temperature	25°C
Relative Humidity	50%
Atmospheric Pressure	1008mbar
Test date :	August 08, 2015
Tested By :	Winnie Zhang

### Requirement(s):

Spec	Item	Requirement	Applicable														
47CFR§15.207, RSS210 (A8.1)	a)	For Low-power radio-frequency devices that is designed to be connected to the public utility (AC) power line, the radio frequency voltage that is conducted back onto the AC power line on any frequency or frequencies, within the band 150 kHz to 30 MHz, shall not exceed the limits in the following table, as measured using a 50 [μ]H/50 ohms line impedance stabilization network (LISN). The lower limit applies at the boundary between the frequencies ranges.	<input checked="" type="checkbox"/>														
		<table border="1"> <thead> <tr> <th rowspan="2">Frequency ranges (MHz)</th> <th colspan="2">Limit (dBμV)</th> </tr> <tr> <th>QP</th> <th>Average</th> </tr> </thead> <tbody> <tr> <td>0.15 ~ 0.5</td> <td>66 – 56</td> <td>56 – 46</td> </tr> <tr> <td>0.5 ~ 5</td> <td>56</td> <td>46</td> </tr> <tr> <td>5 ~ 30</td> <td>60</td> <td>50</td> </tr> </tbody> </table>		Frequency ranges (MHz)	Limit (dBμV)		QP	Average	0.15 ~ 0.5	66 – 56	56 – 46	0.5 ~ 5	56	46	5 ~ 30	60	50
		Frequency ranges (MHz)			Limit (dBμV)												
				QP	Average												
0.15 ~ 0.5	66 – 56	56 – 46															
0.5 ~ 5	56	46															
5 ~ 30	60	50															

Test Setup	<p>Note: 1.Support units were connected to second LISN. 2.Both of LISNs (AMN) are 80cm from EUT and at least 80cm from other units and other metal planes support units.</p>
------------	--

Procedure	<ol style="list-style-type: none"> <li>The EUT and supporting equipment were set up in accordance with the requirements of the standard on top of a 1.5m x 1m x 0.8m high, non-metallic table.</li> <li>The power supply for the EUT was fed through a 50W/50mH EUT LISN, connected to filtered mains.</li> <li>The RF OUT of the EUT LISN was connected to the EMI test receiver via a low-loss</li> </ol>
-----------	---

Test Report	15071019-FCC-R2
Page	38 of 60

	<p>coaxial cable.</p> <ol style="list-style-type: none"> <li>4. All other supporting equipment were powered separately from another main supply.</li> <li>5. The EUT was switched on and allowed to warm up to its normal operating condition.</li> <li>6. A scan was made on the NEUTRAL line (for AC mains) or Earth line (for DC power) over the required frequency range using an EMI test receiver.</li> <li>7. High peaks, relative to the limit line, The EMI test receiver was then tuned to the selected frequencies and the necessary measurements made with a receiver bandwidth setting of 10 kHz.</li> <li>8. Step 7 was then repeated for the LIVE line (for AC mains) or DC line (for DC power).</li> </ol>
Remark	
Result	<input checked="" type="checkbox"/> Pass <input type="checkbox"/> Fail

Test Data     Yes                       N/A

Test Plot     Yes (See below)             N/A

**Test Mode:** Bluetooth Mode

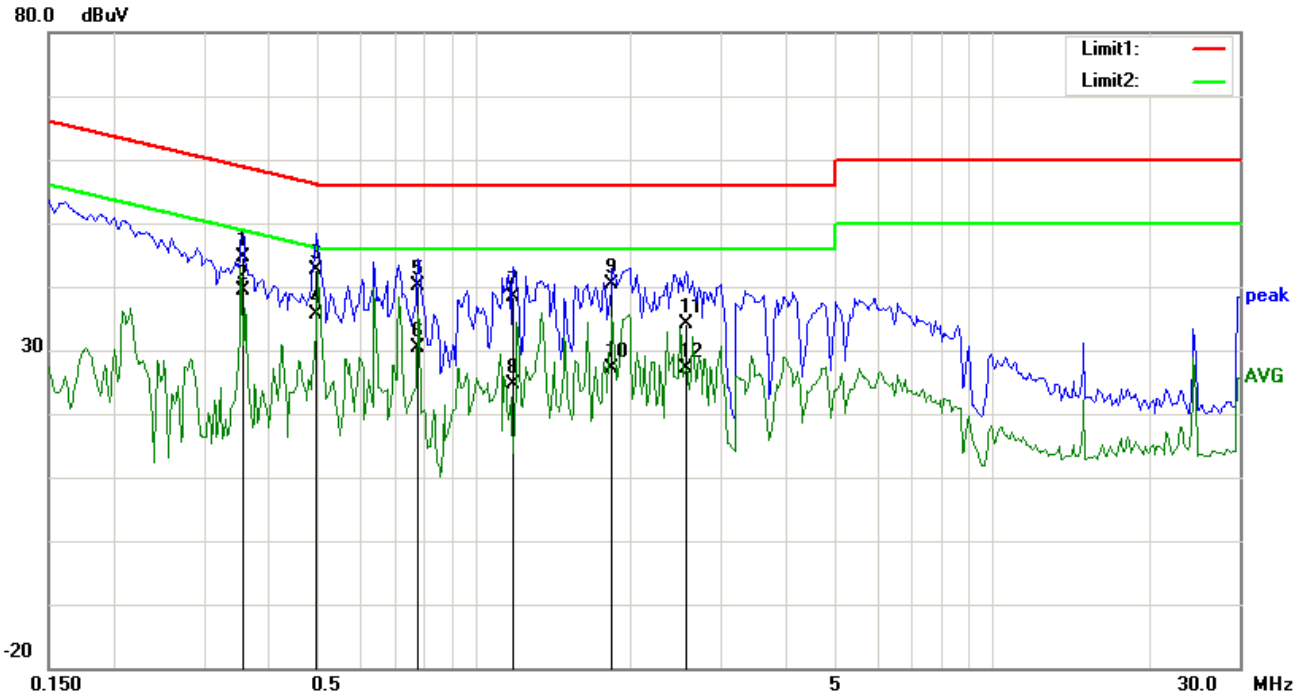

**Test Data**

**Phase Line Plot at 120Vac, 60Hz**

No.	P/L	Frequency	Reading	Detector	Corrected	Result	Limit	Margin
		(MHz)	(dBuV)		(dB}	(dBuV)	(dBuV)	(dB)
1	L1	0.3570	34.72	QP	10.03	44.75	58.80	-14.05
2	L1	0.3570	29.27	AVG	10.03	39.30	48.80	-9.50
3	L1	0.4938	32.70	QP	10.03	42.73	56.10	-13.37
4	L1	0.4938	25.69	AVG	10.03	35.72	46.10	-10.38
5	L1	0.7789	30.02	QP	10.03	40.05	56.00	-15.95
6	L1	0.7789	20.41	AVG	10.03	30.44	46.00	-15.56
7	L1	1.1852	28.43	QP	10.03	38.46	56.00	-17.54
8	L1	1.1852	14.53	AVG	10.03	24.56	46.00	-21.44
9	L1	1.8453	30.25	QP	10.04	40.29	56.00	-15.71
10	L1	1.8453	17.05	AVG	10.04	27.09	46.00	-18.91
11	L1	2.5602	23.99	QP	10.05	34.04	56.00	-21.96
12	L1	2.5602	17.12	AVG	10.05	27.17	46.00	-18.83

<b>Test Mode:</b>	<b>Bluetooth Mode</b>
-------------------	-----------------------

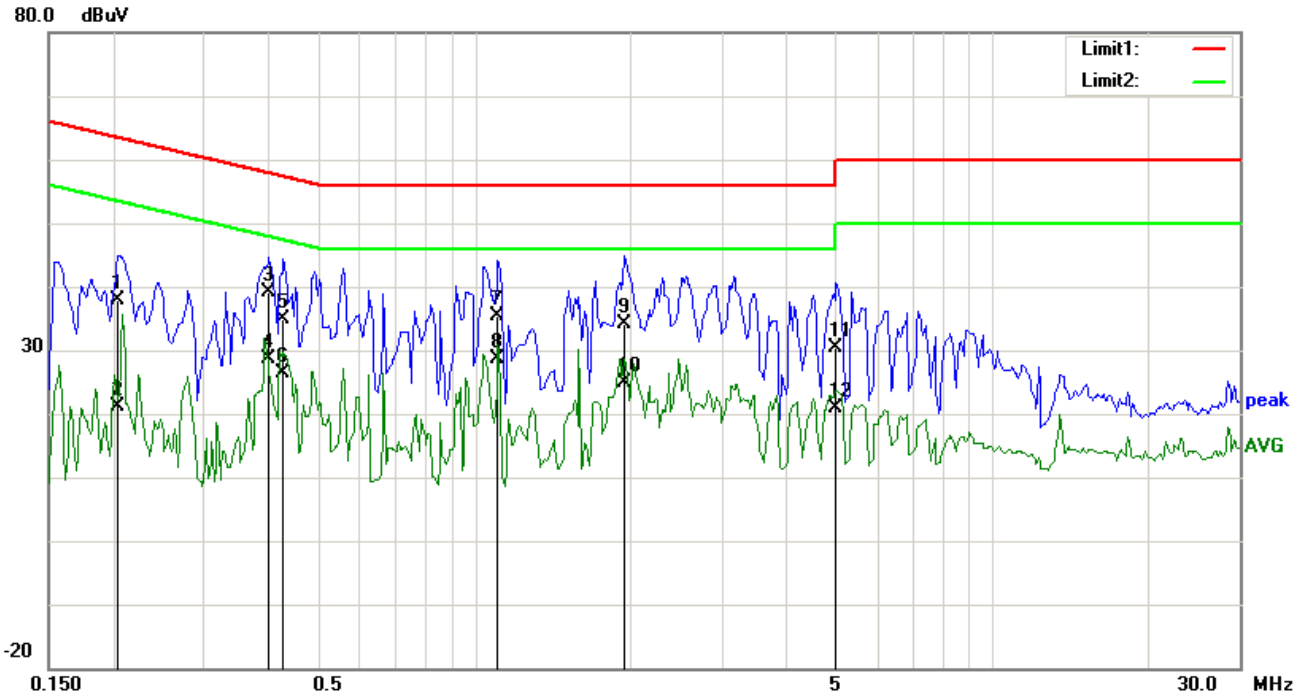

**Test Data**

**Phase Neutral Plot at 120Vac, 60Hz**

No.	P/L	Frequency	Reading	Detector	Corrected	Result	Limit	Margin
		(MHz)	(dBuV)		(dB}	(dBuV)	(dBuV)	(dB)
1	N	0.2047	27.75	QP	10.02	37.77	63.42	-25.65
2	N	0.2047	11.13	AVG	10.02	21.15	53.42	-32.27
3	N	0.4000	29.13	QP	10.02	39.15	57.85	-18.70
4	N	0.4000	18.62	AVG	10.02	28.64	47.85	-19.21
5	N	0.4273	24.76	QP	10.02	34.78	57.31	-22.53
6	N	0.4273	16.35	AVG	10.02	26.37	47.31	-20.94
7	N	1.1109	25.23	QP	10.03	35.26	56.00	-20.74
8	N	1.1109	18.71	AVG	10.03	28.74	46.00	-17.26
9	N	1.9430	24.01	QP	10.04	34.05	56.00	-21.95
10	N	1.9430	14.75	AVG	10.04	24.79	46.00	-21.21
11	N	5.0000	20.32	QP	10.07	30.39	56.00	-25.61
12	N	5.0000	10.77	AVG	10.07	20.84	46.00	-25.16



<b>Test Mode:</b>	<b>Bluetooth Mode</b>
-------------------	-----------------------

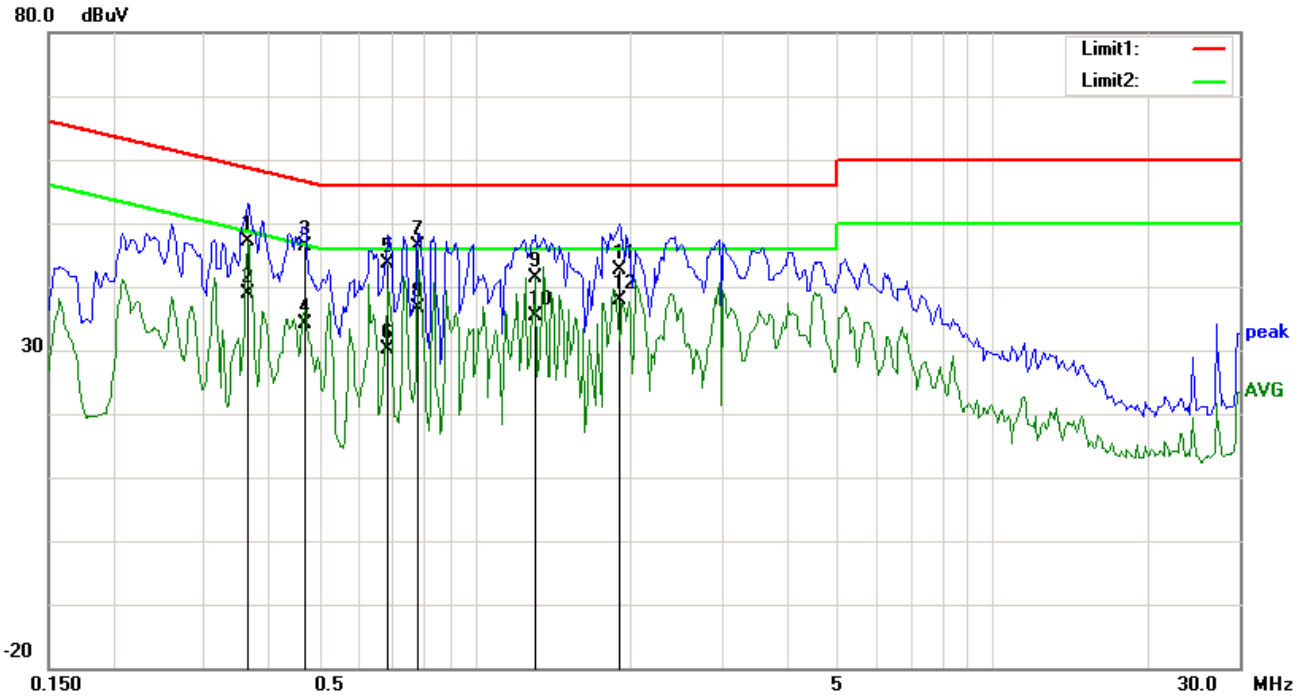

**Test Data**

**Phase Line Plot at 240Vac, 60Hz**

No.	P/L	Frequency (MHz)	Reading (dBuV)	Detector	Corrected (dB}	Result (dBuV)	Limit (dBuV)	Margin (dB)
1	L1	0.3648	36.98	QP	10.03	47.01	58.62	-11.61
2	L1	0.3648	28.86	AVG	10.03	38.89	48.62	-9.73
3	L1	0.4703	36.23	QP	10.03	46.26	56.51	-10.25
4	L1	0.4703	23.99	AVG	10.03	34.02	46.51	-12.49
5	L1	0.6813	33.51	QP	10.03	43.54	56.00	-12.46
6	L1	0.6813	20.22	AVG	10.03	30.25	46.00	-15.75
7	L1	0.7789	36.43	QP	10.03	46.46	56.00	-9.54
8	L1	0.7789	26.63	AVG	10.03	36.66	46.00	-9.34
9	L1	1.3141	31.24	QP	10.03	41.27	56.00	-14.73
10	L1	1.3141	25.33	AVG	10.03	35.36	46.00	-10.64
11	L1	1.9000	32.59	QP	10.04	42.63	56.00	-13.37
12	L1	1.9000	27.80	AVG	10.04	37.84	46.00	-8.16

**Test Mode: Bluetooth Mode**

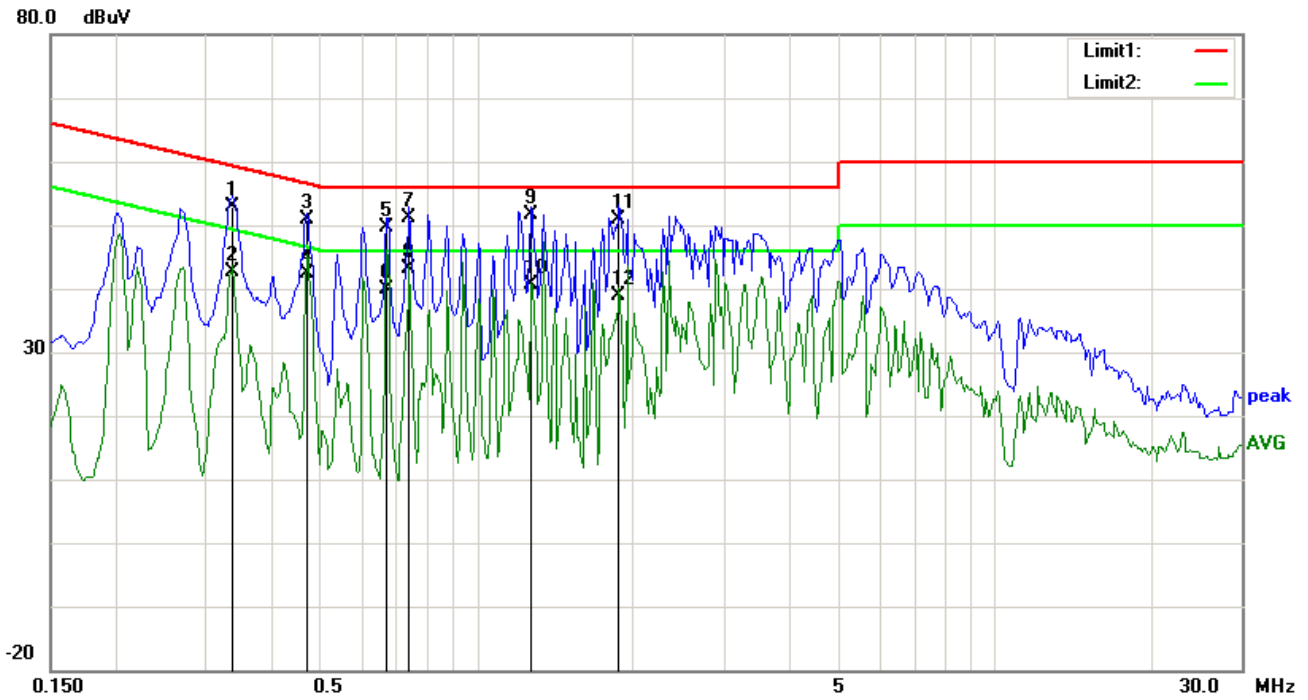

**Test Data**

**Phase Neutral Plot at 240Vac, 60Hz**

No.	P/L	Frequency	Reading	Detector	Corrected	Result	Limit	Margin
		(MHz)	(dBuV)		(dB)	(dBuV)	(dBuV)	(dB)
1	N	0.3375	42.82	QP	10.02	52.84	59.26	-6.42
2	N	0.3375	32.54	AVG	10.02	42.56	49.26	-6.70
3	N	0.4703	40.90	QP	10.02	50.92	56.51	-5.59
4	N	0.4703	32.41	AVG	10.02	42.43	46.51	-4.08
5	N	0.6695	39.72	QP	10.02	49.74	56.00	-6.26
6	N	0.6695	29.91	AVG	10.02	39.93	46.00	-6.07
7	N	0.7398	41.15	QP	10.02	51.17	56.00	-4.83
8	N	0.7398	33.13	AVG	10.02	43.15	46.00	-2.85
9	N	1.2750	41.58	QP	10.03	51.61	56.00	-4.39
10	N	1.2750	30.49	AVG	10.03	40.52	46.00	-5.48
11	N	1.8844	40.92	QP	10.04	50.96	56.00	-5.04
12	N	1.8844	28.83	AVG	10.04	38.87	46.00	-7.13

## 6.9 Radiated Spurious Emissions

Temperature	23°C
Relative Humidity	55%
Atmospheric Pressure	1031mbar
Test date :	July 31, 2015
Tested By :	Winnie Zhang

### Requirement(s):

Spec	Item	Requirement	Applicable										
47CFR§15.205, §15.209, §15.247(d)	a)	<p>Except higher limit as specified elsewhere in other section, the emissions from the low-power radio-frequency devices shall not exceed the field strength levels specified in the following table and the level of any unwanted emissions shall not exceed the level of the fundamental emission. The tighter limit applies at the band edges</p> <table border="1"> <thead> <tr> <th>Frequency range (MHz)</th> <th>Field Strength (<math>\mu\text{V}/\text{m}</math>)</th> </tr> </thead> <tbody> <tr> <td>30 – 88</td> <td>100</td> </tr> <tr> <td>88 – 216</td> <td>150</td> </tr> <tr> <td>216 960</td> <td>200</td> </tr> <tr> <td>Above 960</td> <td>500</td> </tr> </tbody> </table>	Frequency range (MHz)	Field Strength ( $\mu\text{V}/\text{m}$ )	30 – 88	100	88 – 216	150	216 960	200	Above 960	500	<input checked="" type="checkbox"/>
Frequency range (MHz)	Field Strength ( $\mu\text{V}/\text{m}$ )												
30 – 88	100												
88 – 216	150												
216 960	200												
Above 960	500												

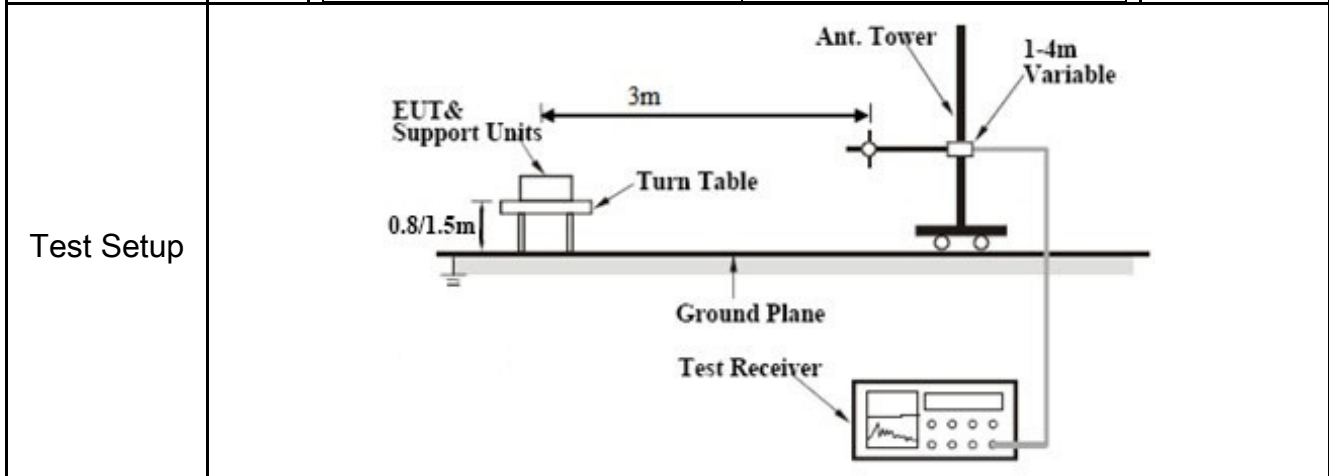

Procedure	<ol style="list-style-type: none"> <li>The EUT was switched on and allowed to warm up to its normal operating condition.</li> <li>The test was carried out at the selected frequency points obtained from the EUT characterization. Maximization of the emissions, was carried out by rotating the EUT, changing the antenna polarization, and adjusting the antenna height in the following manner:</li> </ol>
-----------	---

Test Report	15071019-FCC-R2
Page	44 of 60

	<p>a. Vertical or horizontal polarization (whichever gave the higher emission level over a full rotation of the EUT) was chosen.</p> <p>b. The EUT was then rotated to the direction that gave the maximum emission.</p> <p>c. Finally, the antenna height was adjusted to the height that gave the maximum emission.</p> <p>3. The resolution bandwidth and video bandwidth of test receiver/spectrum analyzer is 120 kHz for Quasiy Peak detection at frequency below 1GHz.</p> <p>4. The resolution bandwidth of test receiver/spectrum analyzer is 1MHz and video bandwidth is 3MHz with Peak detection for Peak measurement at frequency above 1GHz.          The resolution bandwidth of test receiver/spectrum analyzer is 1MHz and the video bandwidth is 10Hz with Peak detection for Average Measurement as below at frequency above 1GHz.</p> <p>5. Steps 2 and 3 were repeated for the next frequency point, until all selected frequency points were measured.</p>
Remark	
Result	<input checked="" type="checkbox"/> Pass <input type="checkbox"/> Fail

Test Data  Yes  N/A

Test Plot  Yes (See below)  N/A

**Test Mode:** Bluetooth Mode

**Below 1GHz**

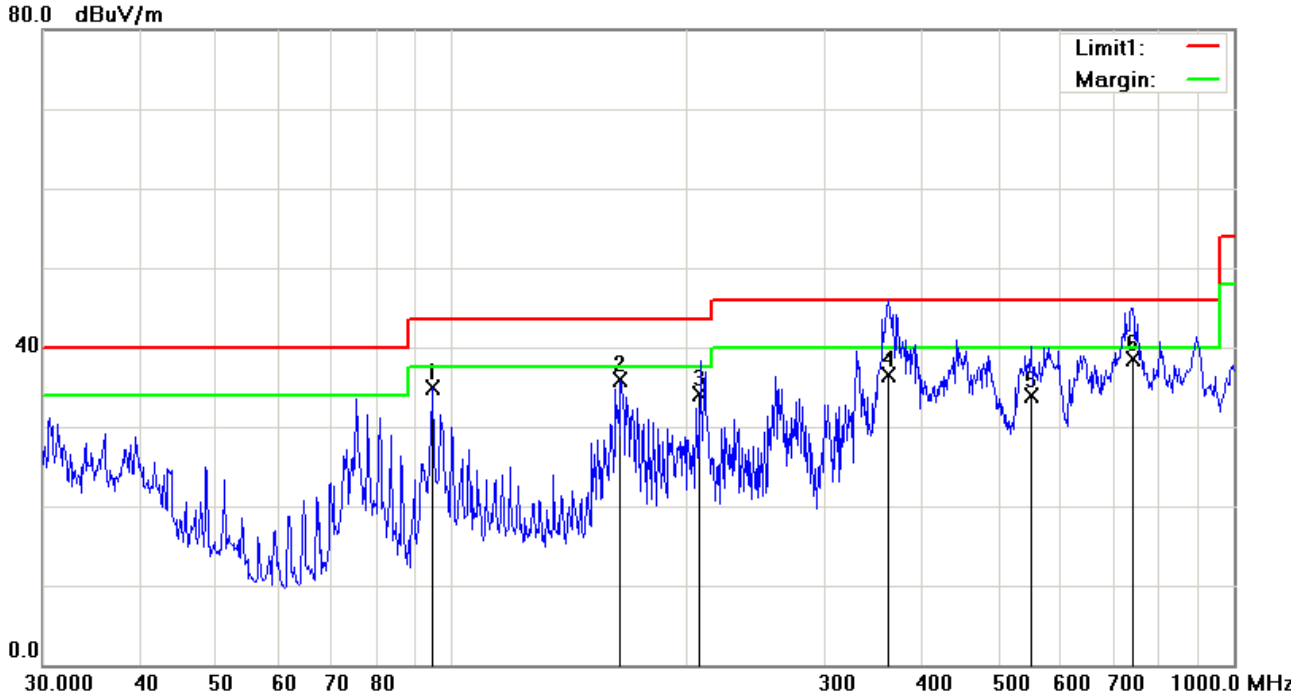

**Test Data**

**Horizontal Polarity Plot @3m**

No.	P/L	Frequency (MHz)	Reading (dBuV/m)	Detector	Corrected (dB/m)	Result (dBuV/m)	Limit (dBuV/m)	Margin (dB)	Height (cm)	Degree ( )
1	H	94.4284	47.13	peak	-12.27	34.86	43.50	-8.64	196	360
2	H	164.3302	44.53	peak	-8.64	35.89	43.50	-7.61	196	360
3	H	207.0189	42.90	QP	-8.81	34.09	43.50	-9.41	167	360
4	H	362.0476	41.76	QP	-5.19	36.57	46.00	-9.43	100	261
5	H	550.3466	34.66	QP	-0.81	33.85	46.00	-12.15	200	154
6	H	741.5334	36.30	QP	2.24	38.54	46.00	-7.46	200	312

**Below 1GHz**

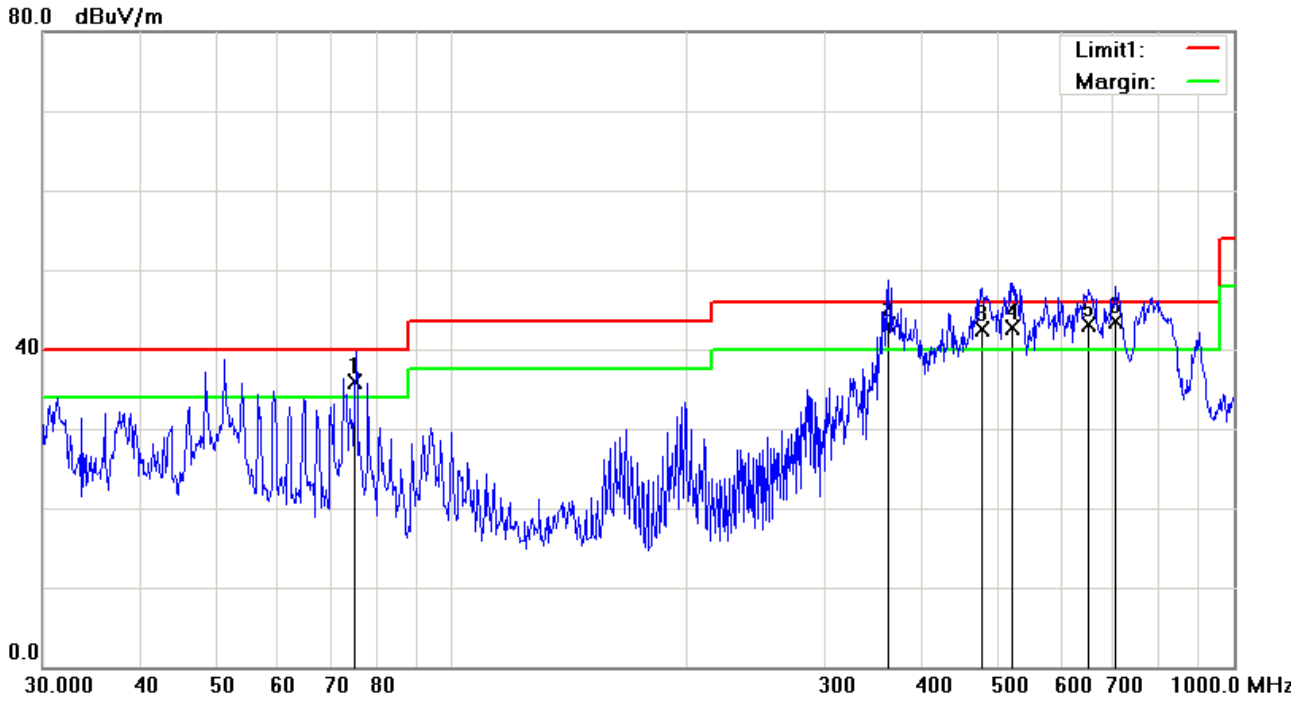

**Test Data**

**Vertical Polarity Plot @3m**

No.	P/L	Frequency (MHz)	Reading (dBuV/m)	Detector	Corrected (dB/m)	Result (dBuV/m)	Limit (dBuV/m)	Margin (dB)	Height (cm)	Degree ( )
1	V	75.1512	49.64	QP	-13.74	35.90	40.00	-4.10	167	360
2	V	361.0466	48.40	QP	-5.21	43.19	46.00	-2.81	100	301
3	V	476.9616	44.80	QP	-2.33	42.47	46.00	-3.53	100	301
4	V	519.9551	44.06	QP	-1.34	42.72	46.00	-3.28	100	301
5	V	650.9527	42.26	QP	0.82	43.08	46.00	-2.92	100	301
6	V	704.4199	41.97	QP	1.47	43.44	46.00	-2.56	100	222

<b>Test Mode:</b>	<b>Transmitting Mode</b>
-------------------	--------------------------

Mode: GFSK (Worst Case)

**Low Channel (2402 MHz)**

Frequency (MHz)	S.A. Reading (dB $\mu$ V)	Detector (PK/AV)	Polarity (H/V)	Ant. Factor (dB/m)	Cable Loss (dB)	Pre-Amp. Gain (dB)	Cord. Amp. (dB $\mu$ V/m)	Limit (dB $\mu$ V/m)	Margin (dB)
4804	41.05	AV	V	33.83	6.86	31.72	50.02	54	-3.98
4804	40.59	AV	H	33.83	6.86	31.72	49.56	54	-4.44
4804	47.13	PK	V	33.83	6.86	31.72	56.10	74	-17.90
4804	45.75	PK	H	33.83	6.86	31.72	54.72	74	-19.28

**Middle Channel (2441 MHz)**

Frequency (MHz)	S.A. Reading (dB $\mu$ V)	Detector (PK/AV)	Polarity (H/V)	Ant. Factor (dB/m)	Cable Loss (dB)	Pre-Amp. Gain (dB)	Cord. Amp. (dB $\mu$ V/m)	Limit (dB $\mu$ V/m)	Margin (dB)
4882	40.68	AV	V	33.86	6.82	31.82	49.54	54	-4.46
4882	39.97	AV	H	33.86	6.82	31.82	48.83	54	-5.17
4882	47.38	PK	V	33.86	6.82	31.82	56.24	74	-17.76
4882	46.02	PK	H	33.86	6.82	31.82	54.88	74	-19.12

**High Channel (2480 MHz)**

Frequency (MHz)	S.A. Reading (dB $\mu$ V)	Detector (PK/AV)	Polarity (H/V)	Ant. Factor (dB/m)	Cable Loss (dB)	Pre-Amp. Gain (dB)	Cord. Amp. (dB $\mu$ V/m)	Limit (dB $\mu$ V/m)	Margin (dB)
4960	41.31	AV	V	33.9	6.76	31.92	50.05	54	-3.95
4960	40.02	AV	H	33.9	6.76	31.92	48.76	54	-5.24
4960	48.30	PK	V	33.9	6.76	31.92	57.04	74	-16.96
4960	46.07	PK	H	33.9	6.76	31.92	54.81	74	-19.19

## Annex A. TEST INSTRUMENT

Instrument	Model	Serial #	Cal Date	Cal Due	In use
<b>AC Line Conducted</b>					
EMI test receiver	ESCS30	8471241027	09/18/2014	09/17/2015	<input checked="" type="checkbox"/>
Line Impedance	LI-125A	191106	09/26/2014	09/25/2015	<input checked="" type="checkbox"/>
Line Impedance	LI-125A	191107	09/26/2014	09/25/2015	<input checked="" type="checkbox"/>
LISN	ISN T800	34373	09/26/2014	09/25/2015	<input checked="" type="checkbox"/>
Double Ridge Horn Antenna (1 ~18GHz)	AH-118	71283	09/25/2014	09/24/2015	<input checked="" type="checkbox"/>
Transient Limiter	LIT-153	531118	09/02/2014	09/01/2015	<input checked="" type="checkbox"/>
<b>RF conducted test</b>					
Agilent ESA-E SERIES	E4407B	MY45108319	09/18/2014	09/17/2015	<input checked="" type="checkbox"/>
Power Splitter	1#	1#	09/02/2014	09/01/2015	<input checked="" type="checkbox"/>
DC Power Supply	E3640A	MY40004013	09/18/2014	09/17/2015	<input checked="" type="checkbox"/>
<b>Radiated Emissions</b>					
EMI test receiver	ESL6	100262	09/18/2014	09/17/2015	<input checked="" type="checkbox"/>
Positioning Controller	UC3000	MF780208282	11/20/2014	11/19/2015	<input checked="" type="checkbox"/>
OPT 010 AMPLIFIER (0.1-1300MHz)	8447E	2727A02430	09/02/2014	09/01/2015	<input checked="" type="checkbox"/>
Microwave Preamplifier (1 ~ 26.5GHz)	8449B	3008A02402	03/25/2015	03/24/2016	<input checked="" type="checkbox"/>
Bilog Antenna (30MHz~6GHz)	JB6	A110712	09/22/2014	09/21/2015	<input checked="" type="checkbox"/>
Double Ridge Horn Antenna (1 ~18GHz)	AH-118	71283	09/25/2014	09/24/2015	<input checked="" type="checkbox"/>
Universal Radio Communication Tester	CMU200	121393	09/26/2014	09/25/2015	<input checked="" type="checkbox"/>



**Annex B. EUT And Test Setup Photographs**

**Annex B.i. Photograph: EUT External Photo**

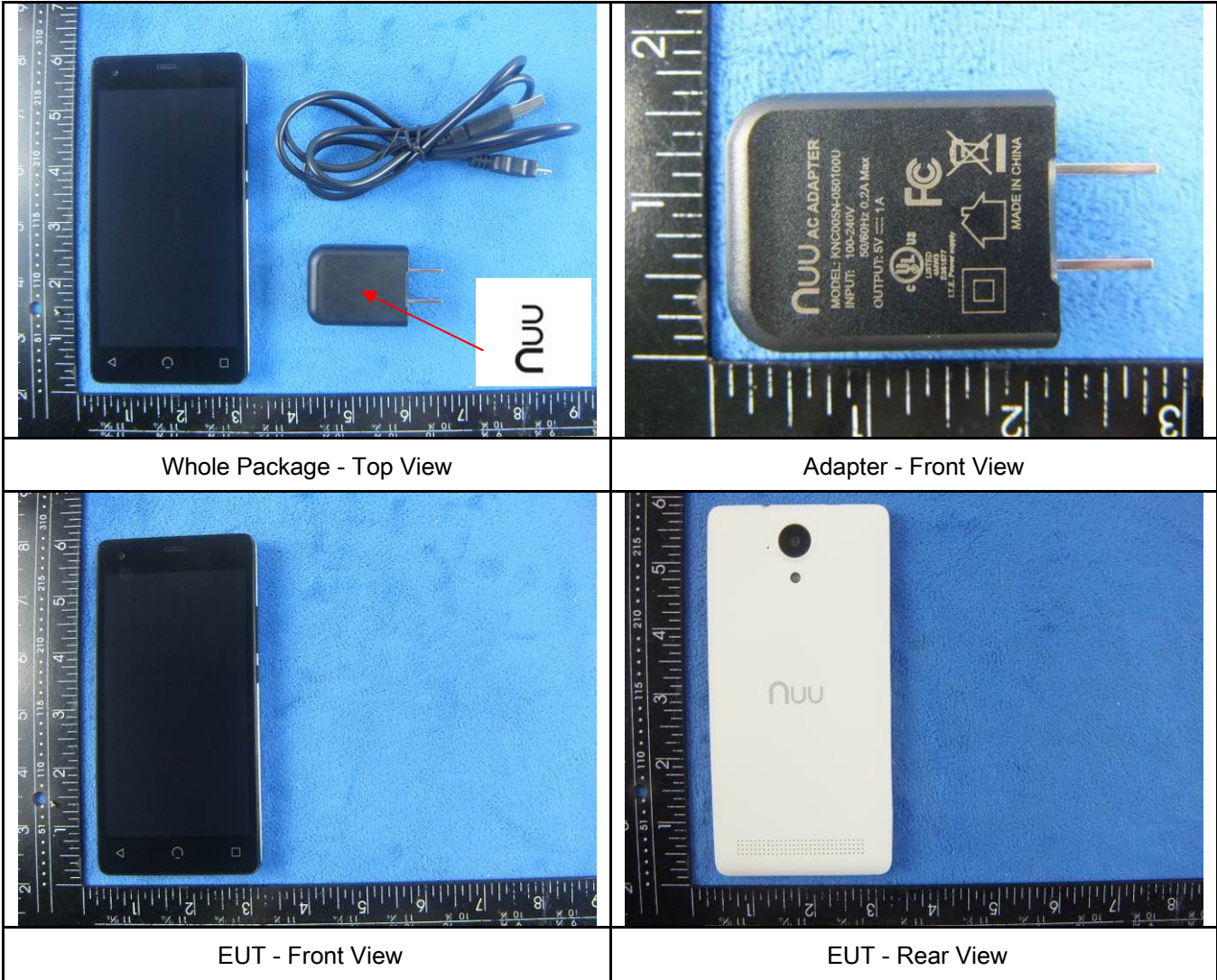

Whole Package - Top View

Adapter - Front View

EUT - Front View

EUT - Rear View

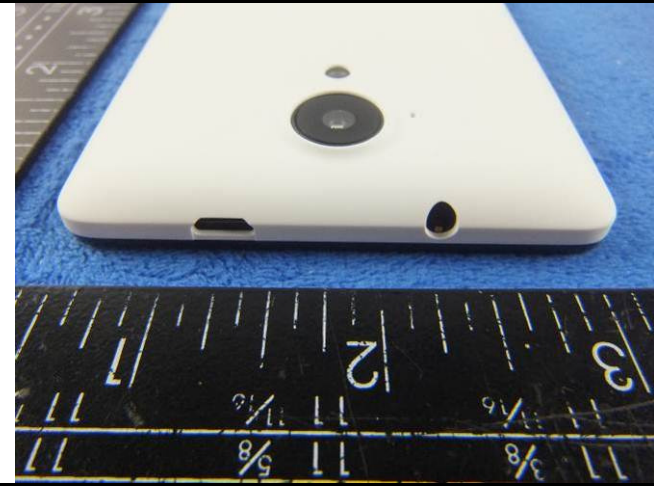

EUT - Top View

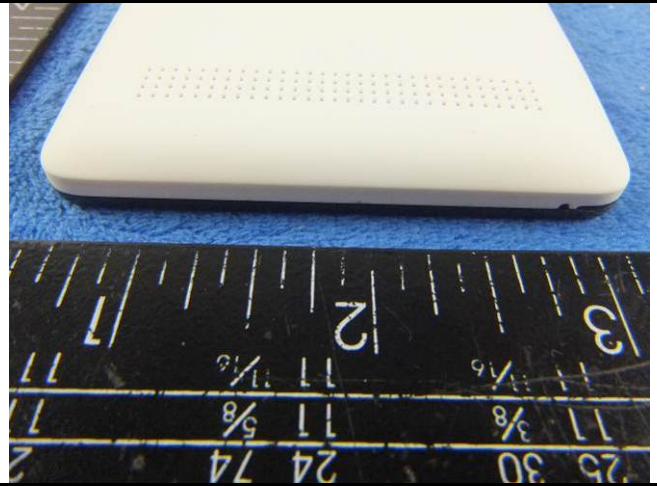

EUT - Bottom View



EUT - Left View



EUT - Right View



**Annex B.ii. Photograph: EUT Internal Photo**



Cover Off - Top View 1



Cover Off - Top View 2



Battery - Front View



Battery - Rear View

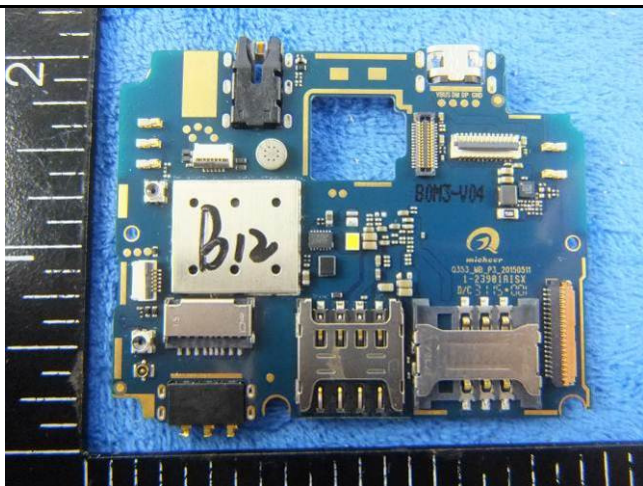

Mainboard with Shielding - Front View



Mainboard without shielding - Front View





Mainboard with Shielding - Rear View

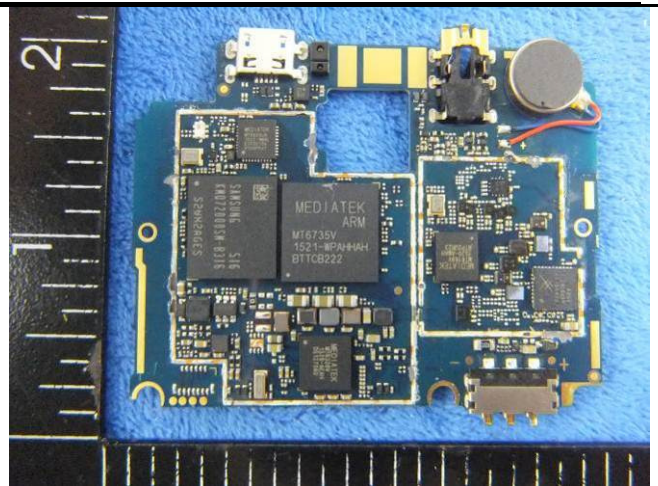

Mainboard without Shielding - Rear View

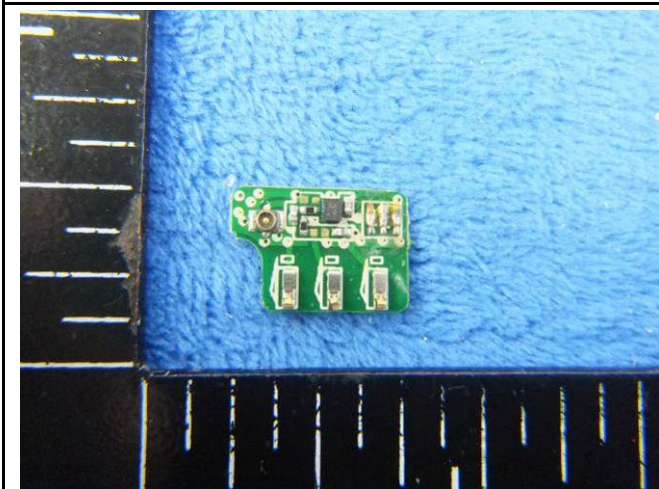

Mini Mainboard - Front View

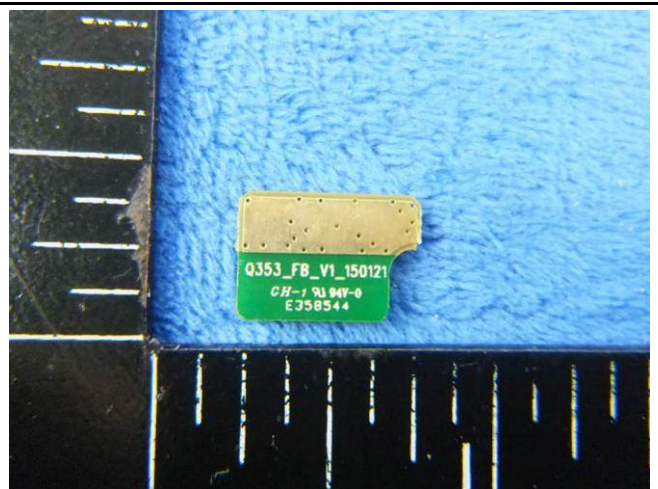

Mini Mainboard - Rear View



LCD - Front View



LCD - Rear View





GSM/PCS/UMTS-FDD/LTE Antenna View



WIFI/BT/BLE - Antenna View



GPS - Antenna View

**Annex B.iii. Photograph: Test Setup Photo**



Conducted Emissions Test Setup Front View



Conducted Emissions Test Setup Side View



Radiated Spurious Emissions Test Setup Below 1GHz

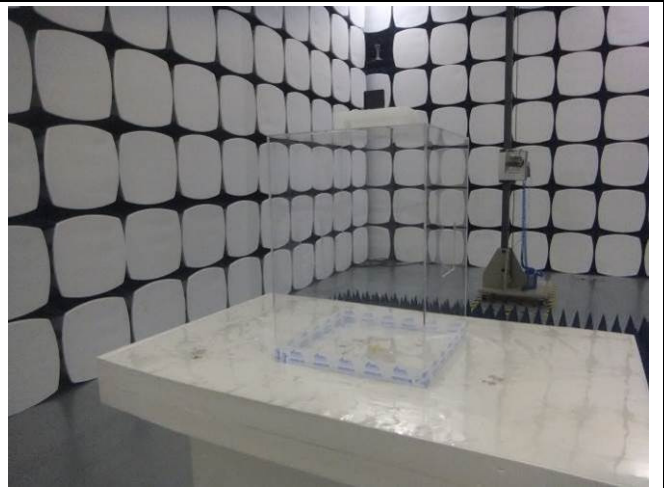

Radiated Spurious Emissions Test Setup Above 1GHz

## Annex C. TEST SETUP AND SUPPORTING EQUIPMENT

### Annex C.ii. TEST SET UP BLOCK

#### Block Configuration Diagram for AC Line Conducted Emissions

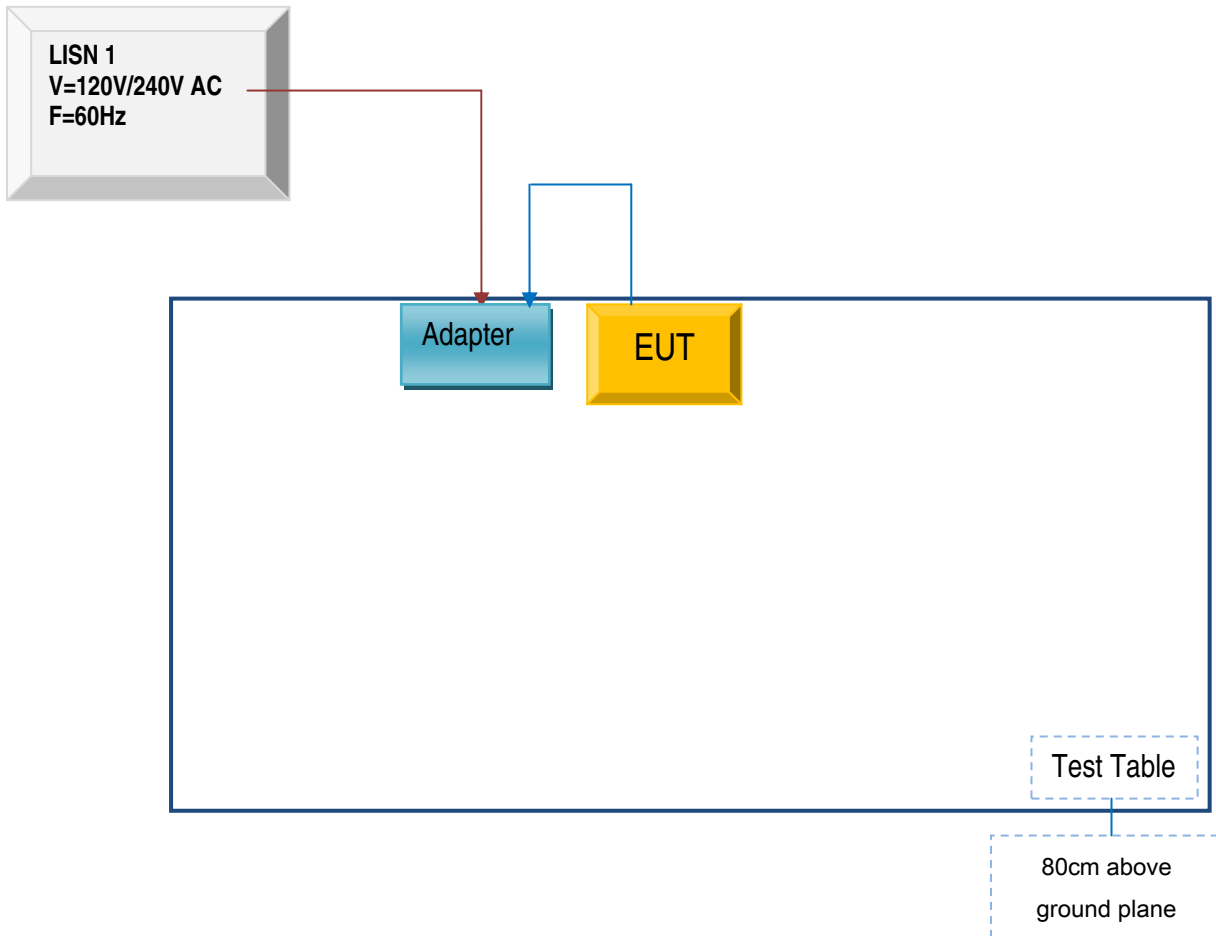

**Block Configuration Diagram for Radiated Emissions ( Below 1GHz ) .**

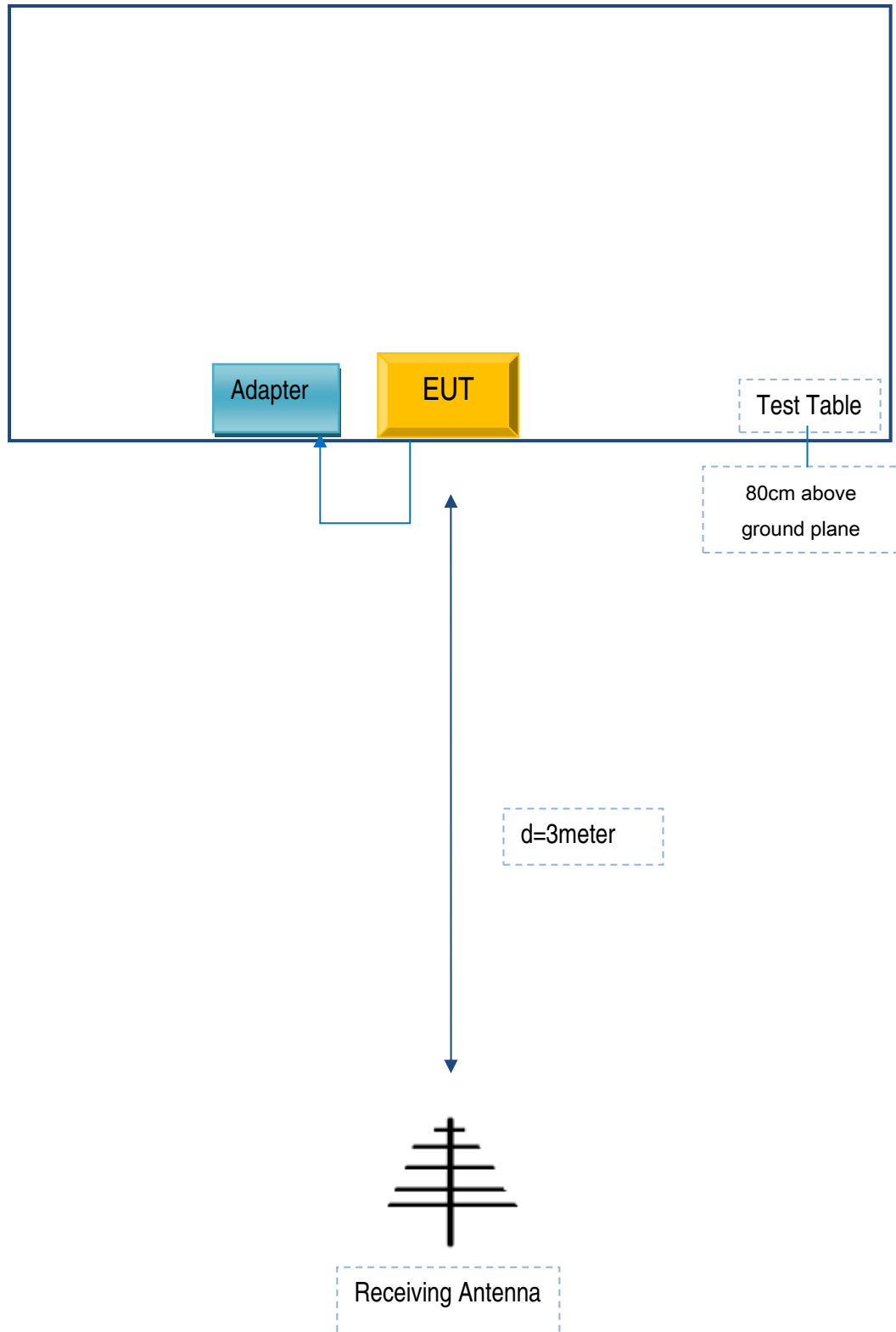



**Block Configuration Diagram for Radiated Emissions ( Above 1GHz ) .**

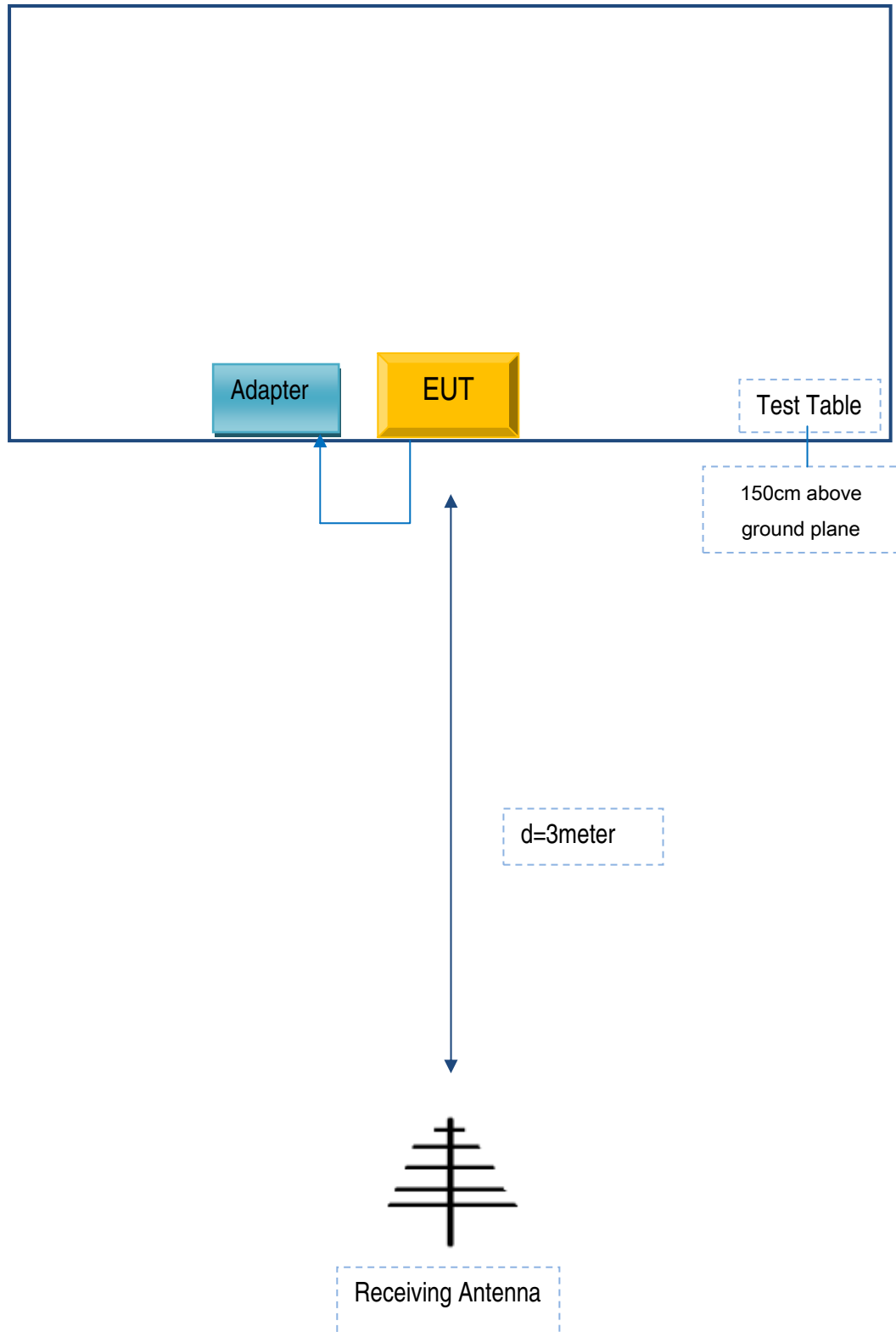

**Annex C. ii. SUPPORTING EQUIPMENT DESCRIPTION**

The following is a description of supporting equipment and details of cables used with the EUT.

Manufacturer	Equipment Description	Model	Calibration Date	Calibration Due Date
N/A	N/A	N/A	N/A	N/A

Test Report	15071019-FCC-R2
Page	59 of 60

**Annex D. User Manual / Block Diagram / Schematics / Partlist**

Please see attachment

Test Report	15071019-FCC-R2
Page	60 of 60

## Annex E. DECLARATION OF SIMILARITY

N/A