

RF TEST REPORT



Report No.: 15071019-FCC-R5

Supersede Report No.: N/A

Applicant	Sun Cupid Technology (HK) Ltd.	
Product Name	LTE Moblie phone	
Model No.	N4L	
Serial No.	N/A	
Test Standard	FCC Part 22(H) : 2014, FCC Part 24(E) : 2014, FCC Part 27: 2014; ANSI/TIA C603 D: 2010	
Test Date	July 30 to August 13 and November 04, 2015	
Issue Date	December 14, 2015	
Test Result	<input checked="" type="checkbox"/> Pass <input type="checkbox"/> Fail	
Equipment complied with the specification	<input checked="" type="checkbox"/>	
Equipment did not comply with the specification	<input type="checkbox"/>	
<i>Winnie Zhang</i>	<i>David Huang</i>	
Winnie Zhang Test Engineer	David Huang Checked By	
This test report may be reproduced in full only Test result presented in this test report is applicable to the tested sample only		

Issued by:

SIEMIC (SHENZHEN-CHINA) LABORATORIES

Zone A, Floor 1, Building 2 Wan Ye Long Technology Park

South Side of Zhoushi Road, Bao' an District, Shenzhen, Guangdong China 518108

Phone: +86 0755 2601 4629801 Email: China@siemic.com.cn

Laboratories Introduction

SIEMIC, headquartered in the heart of Silicon Valley, with superior facilities in US and Asia, is one of the leading independent testing and certification facilities providing customers with one-stop shop services for Compliance Testing and Global Certifications.



In addition to testing and certification, SIEMIC provides initial design reviews and compliance management throughout a project. Our extensive experience with China, Asia Pacific, North America, European, and International compliance requirements, assures the fastest, most cost effective way to attain regulatory compliance for the global markets.

Accreditations for Conformity Assessment

Country/Region	Scope
USA	EMC, RF/Wireless, SAR, Telecom
Canada	EMC, RF/Wireless, SAR, Telecom
Taiwan	EMC, RF, Telecom, SAR, Safety
Hong Kong	RF/Wireless, SAR, Telecom
Australia	EMC, RF, Telecom, SAR, Safety
Korea	EMI, EMS, RF, SAR, Telecom, Safety
Japan	EMI, RF/Wireless, SAR, Telecom
Singapore	EMC, RF, SAR, Telecom
Europe	EMC, RF, SAR, Telecom, Safety

Test Report	15071019-FCC-R5
Page	3 of 132

This page has been left blank intentionally.

CONTENTS

1. REPORT REVISION HISTORY	5
2. CUSTOMER INFORMATION	5
3. TEST SITE INFORMATION.....	5
4. EQUIPMENT UNDER TEST (EUT) INFORMATION.....	6
5. TEST SUMMARY	9
6. MEASUREMENTS, EXAMINATION AND DERIVED RESULTS	10
6.1 RF EXPOSURE (SAR).....	10
6.2 RF OUTPUT POWER.....	11
6.3 PEAK-AVERAGE RATIO.....	46
6.4 MODULATION CHARACTERISTIC.....	49
6.5 OCCUPIED BANDWIDTH.....	50
6.6 SPURIOUS EMISSIONS AT ANTENNA TERMINALS.....	78
6.7 SPURIOUS RADIATED EMISSIONS.....	84
6.8 BAND EDGE.....	90
6.9 BAND EDGE 27.53(M).....	114
6.10 FREQUENCY STABILITY.....	115
ANNEX A. TEST INSTRUMENT.....	120
ANNEX B. EUT AND TEST SETUP PHOTOGRAPHS.....	122
ANNEX C. TEST SETUP AND SUPPORTING EQUIPMENT.....	128
ANNEX C.II. EUT OPERATING CONKITIONS	130
ANNEX D. USER MANUAL / BLOCK DIAGRAM / SCHEMATICS / PARTLIST.....	131
ANNEX E. DECLARATION OF SIMILARITY.....	132

1. Report Revision History

Report No.	Report Version	Description	Issue Date
15071019-FCC-R5	NONE	Original	November 05, 2015
15071019-FCC-R5	V1	Change test photos	December 14, 2015

2. Customer information

Applicant Name	Sun Cupid Technology (HK) Ltd.
Applicant Add	16/F, CEO Tower, 77 Wing Hong St, Cheung Sha Wan, Kowloon
Manufacturer	SUNCUPID (SHENZHEN) ELECTRONIC LTD
Manufacturer Add	Baolong Industrial City, Longgang District, Shenzhen Hi-Tech Road, Building 1, A 7

3. Test site information

Lab performing tests	SIEMIC (Shenzhen-China) LABORATORIES
Lab Address	Zone A, Floor 1, Building 2 Wan Ye Long Technology Park South Side of Zhoushi Road, Bao' an District, Shenzhen, Guangdong China 518108
FCC Test Site No.	718246
IC Test Site No.	4842E-1
Test Software	Radiated Emission Program-To Shenzhen v2.0

4. Equipment under Test (EUT) Information

Description of EUT:	LTE Moblie phone
Main Model:	N4L
Serial Model:	N/A
Date EUT received:	July 29, 2015
Test Date(s):	July 30 to August 13 and November 04, 2015
Equipment Category :	PCE
Antenna Gain:	<p>GSM850: 0.08 dBi PCS1900: 0.8 dBi UMTS-FDD Band V: 0.08 dBi UMTS-FDD Band IV: 0.73 dBi UMTS-FDD Band II: 0.89 dBi Bluetooth/BLE: 0.93 dBi WIFI(2.4G): 0.93 dBi WIFI(5G): 1.82 dBi LTE Band 2: 0.88 dBi LTE Band 4: 0.75 dBi LTE Band 5: 0.07 dBi LTE Band 12: -1.73 dBi LTE Band 17: -1.73 dBi GPS:-0.32dBi</p>
Type of Modulation:	<p>GSM / GPRS: GMSK EGPRS: GMSK, 8PSK UMTS-FDD: QPSK, 16QAM 802.11a/b/g/n: DSSS, OFDM Bluetooth: GFSK, π /4DQPSK, 8DPSK BLE: GFSK LTE Band: QPSK, 16QAM GPS:BPSK</p>

Test Report	15071019-FCC-R5
Page	8 of 132

Trade Name : NUU

GPRS/EGPRS Multi-slot class 8/10/12

FCC ID: 2ADINNUUN4L

5. Test Summary

The product was tested in accordance with the following specifications.

All testing has been performed according to below product classification:

FCC Rules	Description of Test	Result
§ 1.1307; § 2.1093	RF Exposure (SAR)	Compliance
§2.1046; § 22.913(a); § 24.232(c); § 27.50(c.10); § 27.50(d.4)	RF Output Power	Compliance
§ 24.232 (d); § 27.50(d)	Peak-Average Ratio	Compliance
§ 2.1047	Modulation Characteristics	Compliance
§ 2.1049; § 22.905; § 22.917; § 24.238; § 27.53(a.5)	99% & -26 dB Occupied Bandwidth	Compliance
§ 2.1051; § 22.917(a); § 24.238(a); § 27.53(h)	Spurious Emissions at Antenna Terminal	Compliance
§ 2.1053; § 22.917(a); § 24.238(a); § 27.53(h)	Field Strength of Spurious Radiation	Compliance
§ 22.917(a); § 24.238(a);	Out of band emission, Band Edge	Compliance
§ 27.53(m)	Band Edge 27.53(m)	Compliance
§ 2.1055; § 22.355; § 24.235; § 27.5(h); § 27.54	Frequency stability vs. temperature Frequency stability vs. voltage	Compliance

Note: Testing was performed by configuring EUT to maximum output power status, the declared output power class for different

Measurement Uncertainty

Emissions		
Test Item	Description	Uncertainty
Band Edge and Radiated Spurious Emissions	Confidence level of approximately 95% (in the case where distributions are normal), with a coverage factor of 2 (for EUTs < 0.5m X 0.5m X 0.5m)	+5.6dB/-4.5dB
-	-	-

6. MEASUREMENTS, EXAMINATION AND DERIVED RESULTS

6.1 RF Exposure (SAR)

Test Result: Pass

The EUT is a portable device, thus requires SAR evaluation;

Please refer to RF Exposure Evaluation Report: 15071019-FCC-H.

6.2 RF Output Power

Temperature	24°C
Relative Humidity	59%
Atmospheric Pressure	1007mbar
Test date :	August 07, 2015 and November 04, 2015
Tested By :	Winnie Zhang

Requirement(s):

Spec	Item	Requirement	Applicable
§22.913 (a)	a)	ERP:38.45dBm	<input checked="" type="checkbox"/>
§24.232 (c)	b)	EIRP:33dBm	<input checked="" type="checkbox"/>
§27.50 (c)	c)	EIRP: 30dBm	<input checked="" type="checkbox"/>

Test Setup

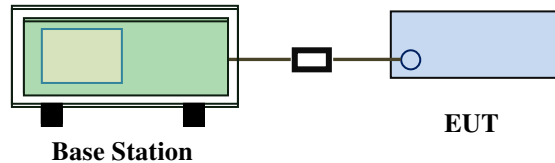

Test Procedure

For Conducted Power:

- The transmitter output port was connected to base station.
- Set EUT at maximum power through base station.
- Select lowest, middle, and highest channels for each band and different test mode.

For ERP/EIRP:

- The transmitter was placed on a wooden turntable, and it was transmitting into a non-radiating load which was also placed on the turntable.
- The measurement antenna was placed at a distance of 3 meters from the EUT. During the tests, the antenna height and polarization as well as EUT azimuth were varied in order to identify the maximum level of emissions from the EUT. The test was performed by placing the EUT on 3-orthogonal axis.
- The frequency range up to tenth harmonic of the fundamental frequency was investigated.

Test Report	15071019-FCC-R5
Page	12 of 132

	<ul style="list-style-type: none"> - Remove the EUT and replace it with substitution antenna. A signal generator was connected to the substitution antenna by a non-radiating cable. The absolute levels of the spurious emissions were measured by the substitution. - Spurious emissions in dB = 10 log (TX power in Watts/0.001) – the absolute level - Spurious attenuation limit in dB = 43 + 10 Log10 (power out in Watts).
Remark	
Result	<input checked="" type="checkbox"/> Pass <input type="checkbox"/> Fail

Test Data Yes N/A
Test Plot Yes (See below) N/A

Conducted Power

LTE Band 2:

BW (MHz)	Ch	Freq. (MHz)	Mode	UL RB Allocation	UL RB Offset	MPR	Average power (dBm)	Tune up Power tolerant
20MHz	18700	1860.0	QPSK	1	0	0	22.63	22±1
				1	49	0	22.66	22±1
				1	99	0	22.62	22±1
				50	0	1	21.62	22±1
				50	24	1	21.60	22±1
				50	49	1	21.62	22±1
			100	0	1	21.61	22±1	
			16QAM	1	0	1	21.93	21.3±1
				1	49	1	21.99	21.3±1
				1	99	1	21.94	21.3±1
				50	0	2	21.85	21.3±1
				50	24	2	21.76	21.3±1
				50	49	2	21.86	21.3±1
				100	0	2	20.63	21.3±1
	18900	1880.0		QPSK	1	0	0	22.63
			1		49	0	22.45	22±1
			1		99	0	22.53	22±1
			50		0	1	21.86	22±1
			50		24	1	21.69	22±1
			50		49	1	21.66	22±1
			100	0	1	21.06	22±1	
			16QAM	1	0	1	21.86	21.3±1
				1	49	1	21.91	21.3±1
				1	99	1	21.88	21.3±1
				50	0	2	21.45	21.3±1
				50	24	2	21.46	21.3±1
				50	49	2	21.38	21.3±1
				100	0	2	20.42	21.3±1
	19100	1900.0		QPSK	1	0	0	22.47
			1		49	0	22.52	22±1
1			99		0	22.41	22±1	
50			0		1	21.51	22±1	
50			24		1	21.55	22±1	
50			49		1	21.45	22±1	
100			0	1	21.39	22±1		
16QAM			1	0	1	21.51	21.3±1	
			1	49	1	21.43	21.3±1	
			1	99	1	21.38	21.3±1	
			50	0	2	21.32	21.3±1	
			50	24	2	21.26	21.3±1	
			50	49	2	21.33	21.3±1	
			100	0	2	20.44	21.3±1	

BW (MHz)	Ch	Freq. (MHz)	Mode	UL RB Allocation	UL RB Offset	MPR	Average power (dBm)	Tune up Power tolerant
15MHz	18675	1857.5	QPSK	1	0	0	22.53	22±1
				1	37	0	22.45	22±1
				1	74	0	22.51	22±1
				36	0	1	21.67	22±1
				36	16	1	21.68	22±1
				36	35	1	21.61	22±1
				75	0	1	21.26	22±1
			16QAM	1	0	1	21.86	21.3±1
				1	37	1	21.92	21.3±1
				1	74	1	21.93	21.3±1
				36	0	2	21.43	21.3±1
				36	16	2	21.51	21.3±1
				36	35	2	21.43	21.3±1
				75	0	2	20.42	21.3±1
	18900	1880.0	QPSK	1	0	0	22.44	22±1
				1	37	0	22.51	22±1
				1	74	0	22.41	22±1
				36	0	1	21.93	22±1
				36	16	1	21.95	22±1
				36	35	1	21.88	22±1
				75	0	1	21.15	22±1
			16QAM	1	0	1	21.86	21.3±1
				1	37	1	21.89	21.3±1
				1	74	1	21.93	21.3±1
				36	0	2	21.43	21.3±1
				36	16	2	21.52	21.3±1
				36	35	2	21.55	21.3±1
				75	0	2	20.52	21.3±1
	19125	1902.5	QPSK	1	0	0	22.41	22±1
				1	37	0	22.25	22±1
				1	74	0	22.21	22±1
				36	0	1	22.02	22±1
				36	16	1	21.91	22±1
				36	35	1	21.89	22±1
				75	0	1	21.11	22±1
			16QAM	1	0	1	21.86	21.3±1
1				37	1	21.87	21.3±1	
1				74	1	21.94	21.3±1	
36				0	2	21.44	21.3±1	
36				16	2	21.36	21.3±1	
36				35	2	21.38	21.3±1	
75				0	2	20.56	21.3±1	

BW (MHz)	Ch	Freq. (MHz)	Mode	UL RB Allocation	UL RB Offset	MPR	Average power (dBm)	Tune up Power tolerant
10MHz	18650	1855	QPSK	1	0	0	22.44	22±1
				1	24	0	22.35	22±1
				1	49	0	22.48	22±1
				25	0	1	21.86	22±1
				25	12	1	21.56	22±1
				25	24	1	21.55	22±1
				50	0	1	21.26	22±1
			16QAM	1	0	1	21.96	21.3±1
				1	24	1	21.93	21.3±1
				1	49	1	21.86	21.3±1
				25	0	2	21.34	21.3±1
				25	12	2	21.38	21.3±1
				25	24	2	21.45	21.3±1
				50	0	2	20.62	21.3±1
	18900	1880.0	QPSK	1	0	0	22.35	22±1
				1	24	0	22.16	22±1
				1	49	0	22.28	22±1
				25	0	1	21.85	22±1
				25	12	1	21.88	22±1
				25	24	1	21.91	22±1
				50	0	1	21.33	22±1
			16QAM	1	0	1	21.89	21.3±1
				1	24	1	21.95	21.3±1
				1	49	1	21.75	21.3±1
				25	0	2	21.37	21.3±1
				25	12	2	21.28	21.3±1
				25	24	2	21.41	21.3±1
				50	0	2	20.75	21.3±1
	19150	1905	QPSK	1	0	0	22.16	22±1
				1	24	0	22.23	22±1
1				49	0	22.39	22±1	
25				0	1	21.45	22±1	
25				12	1	21.51	22±1	
25				24	1	21.15	22±1	
50				0	1	21.13	22±1	
16QAM			1	0	1	21.26	21.3±1	
			1	24	1	21.35	21.3±1	
			1	49	1	21.26	21.3±1	
			25	0	2	21.15	21.3±1	
			25	12	2	21.11	21.3±1	
			25	24	2	21.09	21.3±1	
			50	0	2	20.46	21.3±1	

BW (MHz)	Ch	Freq. (MHz)	Mode	UL RB Allocation	UL RB Offset	MPR	Average power (dBm)	Tune up Power tolerant
5MHz	18625	1852.5	QPSK	1	0	0	22.35	22±1
				1	12	0	22.16	22±1
				1	24	0	22.15	22±1
				12	0	1	21.75	22±1
				12	6	1	21.65	22±1
				12	11	1	21.35	22±1
				25	0	1	21.11	22±1
			16QAM	1	0	1	21.25	21.3±1
				1	12	1	21.34	21.3±1
				1	24	1	21.63	21.3±1
				12	0	2	21.09	21.3±1
				12	6	2	20.96	21.3±1
				12	11	2	21.30	21.3±1
				25	0	2	20.53	21.3±1
	18900	1880.0	QPSK	1	0	0	22.43	22±1
				1	12	0	22.35	22±1
				1	24	0	22.38	22±1
				12	0	1	21.85	22±1
				12	6	1	21.76	22±1
				12	11	1	21.88	22±1
				25	0	1	21.13	22±1
			16QAM	1	0	1	21.36	21.3±1
				1	12	1	21.23	21.3±1
				1	24	1	21.29	21.3±1
				12	0	2	21.05	21.3±1
				12	6	2	21.06	21.3±1
				12	11	2	21.15	21.3±1
				25	0	2	20.62	21.3±1
	19175	1907.5	QPSK	1	0	0	22.53	22±1
				1	12	0	22.41	22±1
1				24	0	22.39	22±1	
12				0	1	21.88	22±1	
12				6	1	21.89	22±1	
12				11	1	21.78	22±1	
25				0	1	21.26	22±1	
16QAM			1	0	1	21.33	21.3±1	
			1	12	1	21.21	21.3±1	
			1	24	1	21.20	21.3±1	
			12	0	2	21.13	21.3±1	
			12	6	2	21.10	21.3±1	
			12	11	2	21.09	21.3±1	
			25	0	2	20.56	21.3±1	

BW (MHz)	Ch	Freq. (MHz)	Mode	UL RB Allocation	UL RB Offset	MPR	Average power (dBm)	Tune up Power tolerant
3MHz	18625	1852.5	QPSK	1	0	0	22.13	22±1
				1	7	0	22.21	22±1
				1	14	0	22.18	22±1
				8	0	1	21.86	22±1
				8	4	1	21.72	22±1
				8	7	1	21.85	22±1
				15	0	1	21.15	22±1
			16QAM	1	0	1	21.06	21.3±1
				1	7	1	21.11	21.3±1
				1	14	1	21.09	21.3±1
				8	0	2	20.86	21.3±1
				8	4	2	20.96	21.3±1
				8	7	2	20.99	21.3±1
				15	0	2	20.51	21.3±1
	18900	1880.0	QPSK	1	0	0	22.16	22±1
				1	7	0	22.34	22±1
				1	14	0	22.28	22±1
				8	0	1	21.76	22±1
				8	4	1	21.83	22±1
				8	7	1	21.85	22±1
				15	0	1	21.35	22±1
			16QAM	1	0	1	21.12	21.3±1
				1	7	1	21.09	21.3±1
				1	14	1	21.24	21.3±1
				8	0	2	21.05	21.3±1
				8	4	2	21.01	21.3±1
				8	7	2	20.88	21.3±1
				15	0	2	20.53	21.3±1
	19175	1907.5	QPSK	1	0	0	22.34	22±1
				1	7	0	22.16	22±1
1				14	0	22.25	22±1	
8				0	1	21.84	22±1	
8				4	1	22.01	22±1	
8				7	1	21.77	22±1	
15				0	1	21.13	22±1	
16QAM			1	0	1	21.11	21.3±1	
			1	7	1	21.08	21.3±1	
			1	14	1	21.12	21.3±1	
			8	0	2	20.95	21.3±1	
			8	4	2	20.99	21.3±1	
			8	7	2	20.98	21.3±1	
			15	0	2	20.53	21.3±1	

BW (MHz)	Ch	Freq. (MHz)	Mode	UL RB Allocation	UL RB Offset	MPR	Average power (dBm)	Tune up Power tolerant
1.4MHz	18607	1850.7	QPSK	1	0	0	22.44	22±1
				1	2	0	22.45	22±1
				1	5	0	22.48	22±1
				3	0	0	22.50	22±1
				3	1	0	22.41	22±1
				3	2	0	22.50	22±1
			6	0	1	21.49	22±1	
			16QAM	1	0	1	21.09	21.3±1
				1	2	1	21.11	21.3±1
				1	5	1	21.12	21.3±1
				3	0	1	21.15	21.3±1
				3	1	1	21.11	21.3±1
	3	2		1	21.09	21.3±1		
	6	0	2	20.37	21.3±1			
	18900	1880.0	QPSK	1	0	0	22.41	22±1
				1	2	0	22.41	22±1
				1	5	0	22.38	22±1
				3	0	0	21.72	22±1
				3	1	0	21.83	21±1
				3	2	0	22.03	22±1
			6	0	1	21.13	22±1	
			16QAM	1	0	1	21.23	21.3±1
				1	2	1	21.15	21.3±1
				1	5	1	21.34	21.3±1
				3	0	1	21.06	21.3±1
				3	1	1	21.05	21.3±1
	3	2		1	21.15	21.3±1		
6	0	2	20.73	21.3±1				
19193	1909.3	QPSK	1	0	0	22.13	22±1	
			1	2	0	22.23	22±1	
			1	5	0	22.14	22±1	
			3	0	0	21.75	22±1	
			3	1	0	21.69	22±1	
			3	2	0	21.77	22±1	
		6	0	1	21.16	22±1		
		16QAM	1	0	1	21.33	21.3±1	
			1	2	1	21.11	21.3±1	
			1	5	1	21.21	21.3±1	
			3	0	1	21.10	21.3±1	
			3	1	1	21.08	21.3±1	
3	2		1	21.05	21.3±1			
6	0	2	20.65	21.3±1				

LTE Band 4:

BW (MHz)	Ch	Freq. (MHz)	Mode	UL RB Allocation	UL RB Offset	MPR	Average power (dBm)	Tune up Power tolerant
20MHz	20050	1720.0	QPSK	1	0	0	21.82	21.3±1
				1	49	0	21.79	21.3±1
				1	99	0	21.77	21.3±1
				50	0	1	20.90	21.3±1
				50	24	1	20.93	21.3±1
				50	49	1	20.81	21.3±1
				100	0	1	20.82	21.3±1
			16QAM	1	0	1	21.21	21.3±1
				1	49	1	21.22	21.3±1
				1	99	1	21.19	21.3±1
				50	0	2	20.96	21.3±1
				50	24	2	20.94	21.3±1
				50	49	2	20.89	21.3±1
				100	0	2	20.46	21.3±1
	20175	1732.5	QPSK	1	0	0	21.86	21.3±1
				1	49	0	21.95	21.3±1
				1	99	0	21.88	21.3±1
				50	0	1	21.03	21.3±1
				50	24	1	20.89	21.3±1
				50	49	1	20.93	21.3±1
				100	0	1	20.89	21.3±1
			16QAM	1	0	1	21.35	21.3±1
				1	49	1	21.26	21.3±1
				1	99	1	21.29	21.3±1
				50	0	2	20.92	21.3±1
				50	24	2	20.95	21.3±1
				50	49	2	20.95	21.3±1
100				0	2	20.49	21.3±1	
20300	1745.0	QPSK	1	0	0	21.86	21.3±1	
			1	49	0	21.76	21.3±1	
			1	99	0	21.95	21.3±1	
			50	0	1	21.05	21.3±1	
			50	24	1	21.12	21.3±1	
			50	49	1	21.14	21.3±1	
			100	0	1	20.90	21.3±1	
		16QAM	1	0	1	21.35	21.3±1	
			1	49	1	21.29	21.3±1	
			1	99	1	21.21	21.3±1	
			50	0	2	20.96	21.3±1	
			50	24	2	21.06	21.3±1	
			50	49	2	21.08	21.3±1	
			100	0	2	20.45	21.3±1	

BW (MHz)	Ch	Freq. (MHz)	Mode	UL RB Allocation	UL RB Offset	MPR	Average power (dBm)	Tune up Power tolerant
15MHz	20025	1717.5	QPSK	1	0	0	21.86	21.3±1
				1	37	0	21.76	21.3±1
				1	74	0	21.92	21.3±1
				36	0	1	21.24	21.3±1
				36	16	1	21.16	21.3±1
				36	35	1	21.11	21.3±1
				75	0	1	20.96	21.3±1
			16QAM	1	0	1	21.35	21.3±1
				1	37	1	21.22	21.3±1
				1	74	1	21.13	21.3±1
				36	0	2	21.06	21.3±1
				36	16	2	21.08	21.3±1
				36	35	2	20.99	21.3±1
				75	0	2	20.53	21.3±1
	20175	1732.5	QPSK	1	0	0	21.86	22±1
				1	37	0	21.95	22±1
				1	74	0	21.94	22±1
				36	0	1	21.25	22±1
				36	16	1	21.16	22±1
				36	35	1	21.38	22±1
				75	0	1	21.15	22±1
			16QAM	1	0	1	21.33	21.3±1
				1	37	1	21.26	21.3±1
				1	74	1	21.29	21.3±1
				36	0	2	21.12	21.3±1
				36	16	2	21.13	21.3±1
				36	35	2	21.04	21.3±1
				75	0	2	20.47	21.3±1
20325	1747.5	QPSK	1	0	0	21.88	22±1	
			1	37	0	21.96	22±1	
			1	74	0	21.95	22±1	
			36	0	1	21.25	22±1	
			36	16	1	21.29	22±1	
			36	35	1	21.31	22±1	
			75	0	1	21.14	22±1	
		16QAM	1	0	1	21.23	21.3±1	
			1	37	1	21.28	21.3±1	
			1	74	1	21.22	21.3±1	
			36	0	2	21.12	21.3±1	
			36	16	2	20.94	21.3±1	
			36	35	2	20.99	21.3±1	
			75	0	2	20.51	21.3±1	

BW (MHz)	Ch	Freq. (MHz)	Mode	UL RB Allocation	UL RB Offset	MPR	Average power (dBm)	Tune up Power tolerant
10MHz	20000	1715.0	QPSK	1	0	0	21.91	22±1
				1	24	0	22.05	22±1
				1	49	0	21.89	22±1
				25	0	1	21.24	22±1
				25	12	1	21.38	22±1
				25	24	1	21.35	22±1
				50	0	1	21.19	22±1
			16QAM	1	0	1	21.26	21.3±1
				1	24	1	21.22	21.3±1
				1	49	1	21.23	21.3±1
				25	0	2	21.05	21.3±1
				25	12	2	21.11	21.3±1
				25	24	2	20.97	21.3±1
				50	0	2	20.53	21.3±1
	20175	1732.5	QPSK	1	0	0	21.86	22±1
				1	24	0	21.95	22±1
				1	49	0	22.08	22±1
				25	0	1	21.53	22±1
				25	12	1	21.43	22±1
				25	24	1	21.29	22±1
				50	0	1	21.19	22±1
			16QAM	1	0	1	21.35	21.3±1
				1	24	1	21.42	21.3±1
				1	49	1	21.36	21.3±1
				25	0	2	21.20	21.3±1
				25	12	2	21.10	21.3±1
				25	24	2	21.16	21.3±1
				50	0	2	20.55	21.3±1
	20350	1750.0	QPSK	1	0	0	21.95	22±1
				1	24	0	21.93	22±1
1				49	0	21.88	22±1	
25				0	1	21.56	22±1	
25				12	1	21.42	22±1	
25				24	1	21.33	22±1	
50				0	1	21.24	22±1	
16QAM			1	0	1	21.34	21.3±1	
			1	24	1	21.52	21.3±1	
			1	49	1	21.36	21.3±1	
			25	0	2	21.12	21.3±1	
			25	12	2	21.19	21.3±1	
			25	24	2	21.34	21.3±1	
			50	0	2	20.61	21.3±1	

BW (MHz)	Ch	Freq. (MHz)	Mode	UL RB Allocation	UL RB Offset	MPR	Average power (dBm)	Tune up Power tolerant
5MHz	20000	1715.0	QPSK	1	0	0	21.96	22±1
				1	12	0	21.89	22±1
				1	24	0	21.83	22±1
				12	0	1	21.42	22±1
				12	6	1	21.45	22±1
				12	11	1	21.51	22±1
			25	0	1	21.21	22±1	
			16QAM	1	0	1	21.33	21.3±1
				1	12	1	21.34	21.3±1
				1	24	1	21.28	21.3±1
				12	0	2	21.13	21.3±1
				12	6	2	21.11	21.3±1
	12	11		2	20.86	21.3±1		
	25	0	2	20.44	21.3±1			
	20175	1732.5	QPSK	1	0	0	21.86	22±1
				1	12	0	21.88	22±1
				1	24	0	21.92	22±1
				12	0	1	21.36	22±1
				12	6	1	21.29	22±1
				12	11	1	21.45	22±1
			25	0	1	21.11	22±1	
			16QAM	1	0	1	21.26	21.3±1
				1	12	1	21.22	21.3±1
				1	24	1	21.42	21.3±1
12				0	2	21.06	21.3±1	
12				6	2	21.08	21.3±1	
12	11	2		20.91	21.3±1			
25	0	2	20.51	21.3±1				
20350	1750.0	QPSK	1	0	0	22.06	22±1	
			1	12	0	22.01	22±1	
			1	24	0	21.89	22±1	
			12	0	1	21.43	22±1	
			12	6	1	21.38	22±1	
			12	11	1	21.44	22±1	
		25	0	1	21.21	22±1		
		16QAM	1	0	1	21.23	21.3±1	
			1	12	1	21.28	21.3±1	
			1	24	1	21.22	21.3±1	
			12	0	2	20.96	21.3±1	
			12	6	2	20.91	21.3±1	
12	11		2	20.95	21.3±1			
25	0	2	20.42	21.3±1				

BW (MHz)	Ch	Freq. (MHz)	Mode	UL RB Allocation	UL RB Offset	MPR	Average power (dBm)	Tune up Power tolerant
3MHz	19965	1711.5	QPSK	1	0	0	21.57	21.3±1
				1	7	0	21.55	21.3±1
				1	14	0	21.29	21.3±1
				8	0	1	20.75	21.3±1
				8	4	1	20.69	21.3±1
				8	7	1	20.76	21.3±1
				15	0	1	20.76	21.3±1
			16QAM	1	0	1	21.14	21.3±1
				1	7	1	21.25	21.3±1
				1	14	1	21.16	21.3±1
				8	0	2	20.56	21.3±1
				8	4	2	20.53	21.3±1
				8	7	2	20.75	21.3±1
				15	0	2	20.41	21.3±1
	20175	1732.5	QPSK	1	0	0	21.65	21.3±1
				1	7	0	21.75	21.3±1
				1	14	0	21.49	21.3±1
				8	0	1	20.85	21.3±1
				8	4	1	20.88	21.3±1
				8	7	1	20.91	21.3±1
				15	0	1	20.75	21.3±1
			16QAM	1	0	1	21.24	21.3±1
				1	7	1	21.13	21.3±1
				1	14	1	21.26	21.3±1
				8	0	2	20.96	21.3±1
				8	4	2	20.86	21.3±1
				8	7	2	20.99	21.3±1
				15	0	2	20.43	21.3±1
	20385	1753.5	QPSK	1	0	0	21.76	21.3±1
				1	7	0	21.77	21.3±1
1				14	0	21.82	21.3±1	
8				0	1	21.03	21.3±1	
8				4	1	21.08	21.3±1	
8				7	1	20.86	21.3±1	
15				0	1	20.89	21.3±1	
16QAM			1	0	1	21.15	21.3±1	
			1	7	1	21.13	21.3±1	
			1	14	1	21.12	21.3±1	
			8	0	2	20.96	21.3±1	
			8	4	2	20.89	21.3±1	
			8	7	2	20.78	21.3±1	
			15	0	2	20.50	21.3±1	

BW (MHz)	Ch	Freq. (MHz)	Mode	UL RB Allocation	UL RB Offset	MPR	Average power (dBm)	Tune up Power tolerant
1.4MHz	19957	1710.7	QPSK	1	0	0	21.76	21.3±1
				1	2	0	21.84	21.3±1
				1	5	0	21.78	21.3±1
				3	0	0	21.84	21.3±1
				3	1	0	21.83	21.3±1
				3	2	0	21.82	21.3±1
			16QAM	6	0	1	20.74	21.3±1
				1	0	1	20.60	21.3±1
				1	2	1	20.67	21.3±1
				1	5	1	20.58	21.3±1
				3	0	1	21.37	21.3±1
				3	1	1	21.36	21.3±1
	20175	1732.5	QPSK	3	2	1	21.38	21.3±1
				6	0	2	20.45	21.3±1
				1	0	0	21.70	21.3±1
				1	2	0	21.68	21.3±1
				1	5	0	21.73	21.3±1
				3	0	0	21.77	21.3±1
			16QAM	3	1	0	21.65	21.3±1
				3	2	0	21.68	21.3±1
				6	0	1	20.68	21.3±1
				1	0	1	20.70	21.3±1
				1	2	1	20.96	21.3±1
				1	5	1	20.89	21.3±1
	20393	1754.3	QPSK	3	0	1	20.68	21.3±1
				3	1	1	20.75	21.3±1
				3	2	1	20.71	21.3±1
				6	0	2	20.36	21.3±1
				1	0	0	21.42	21.3±1
				1	2	0	21.35	21.3±1
16QAM			1	5	0	21.42	21.3±1	
			3	0	0	21.55	21.3±1	
			3	1	0	21.46	21.3±1	
			3	2	0	21.38	21.3±1	
			6	0	1	20.50	21.3±1	
			1	0	1	20.69	21.3±1	
16QAM	1	2	1	20.86	21.3±1			
	1	5	1	20.73	21.3±1			
	3	0	1	20.64	21.3±1			
	3	1	1	20.71	21.3±1			
	3	2	1	20.62	21.3±1			
	6	0	2	20.33	21.3±1			

LTE Band 5:

BW (MHz)	Ch	Freq. (MHz)	Mode	UL RB Allocation	UL RB Offset	MPR	Average power (dBm)	Tune up Power tolerant
10MHz	20450	829	QPSK	1	0	0	22.03	22±1
				1	24	0	22.01	22±1
				1	49	0	21.99	22±1
				25	0	1	21.13	22±1
				25	12	1	21.23	22±1
				25	24	1	21.09	22±1
				50	0	1	21.10	22±1
			16QAM	1	0	1	21.76	21.3±1
				1	24	1	21.77	21.3±1
				1	49	1	21.68	21.3±1
				25	0	2	21.13	21.3±1
				25	12	2	21.08	21.3±1
				25	24	2	21.05	21.3±1
				50	0	2	20.53	21.3±1
	20525	836.5	QPSK	1	0	0	22.01	22±1
				1	24	0	21.98	22±1
				1	49	0	22.06	22±1
				25	0	1	21.76	22±1
				25	12	1	21.75	22±1
				25	24	1	21.82	22±1
				50	0	1	21.15	22±1
			16QAM	1	0	1	21.74	21.3±1
				1	24	1	21.78	21.3±1
				1	49	1	21.81	21.3±1
				25	0	2	21.16	21.3±1
				25	12	2	21.24	21.3±1
				25	24	2	21.22	21.3±1
				50	0	2	20.42	21.3±1
	20600	844	QPSK	1	0	0	22.05	22±1
				1	24	0	22.09	22±1
1				49	0	22.04	22±1	
25				0	1	21.76	22±1	
25				12	1	21.68	22±1	
25				24	1	21.66	22±1	
50				0	1	21.34	22±1	
16QAM			1	0	1	21.68	21.3±1	
			1	24	1	21.69	21.3±1	
			1	49	1	21.76	21.3±1	
			25	0	2	20.86	21.3±1	
			25	12	2	20.92	21.3±1	
			25	24	2	20.88	21.3±1	
			50	0	2	20.39	21.3±1	

BW (MHz)	Ch	Freq. (MHz)	Mode	UL RB Allocation	UL RB Offset	MPR	Average power (dBm)	Tune up Power tolerant
5MHz	20425	826.5	QPSK	1	0	0	22.01	22±1
				1	12	0	22.10	22±1
				1	24	0	22.08	22±1
				12	0	1	21.26	22±1
				12	6	1	21.35	22±1
				12	11	1	21.21	22±1
				25	0	1	21.12	22±1
			16QAM	1	0	1	21.68	21.3±1
				1	12	1	21.69	21.3±1
				1	24	1	21.83	21.3±1
				12	0	2	21.15	21.3±1
				12	6	2	21.16	21.3±1
				12	11	2	21.11	21.3±1
				25	0	2	20.55	21.3±1
	20525	836.5	QPSK	1	0	0	22.12	22±1
				1	12	0	22.06	22±1
				1	24	0	22.07	22±1
				12	0	1	21.24	22±1
				12	6	1	21.23	22±1
				12	11	1	21.19	22±1
				25	0	1	21.11	22±1
			16QAM	1	0	1	21.69	21.3±1
				1	12	1	21.72	21.3±1
				1	24	1	21.74	21.3±1
				12	0	2	21.31	21.3±1
				12	6	2	21.22	21.3±1
				12	11	2	21.25	21.3±1
				25	0	2	20.61	21.3±1
	20625	846.5	QPSK	1	0	0	22.03	22±1
				1	12	0	22.13	22±1
1				24	0	22.04	22±1	
12				0	1	21.36	22±1	
12				6	1	21.28	22±1	
12				11	1	21.35	22±1	
25				0	1	21.21	22±1	
16QAM			1	0	1	21.75	21.3±1	
			1	12	1	21.83	21.3±1	
			1	24	1	21.84	21.3±1	
			12	0	2	20.94	21.3±1	
			12	6	2	21.14	21.3±1	
			12	11	2	20.95	21.3±1	
			25	0	2	20.45	21.3±1	

BW (MHz)	Ch	Freq. (MHz)	Mode	UL RB Allocation	UL RB Offset	MPR	Average power (dBm)	Tune up Power tolerant
3MHz	20415	825.5	QPSK	1	0	0	22.12	22±1
				1	7	0	22.13	22±1
				1	14	0	22.11	22±1
				8	0	1	22.05	22±1
				8	4	1	22.09	22±1
				8	7	1	21.88	22±1
				15	0	1	21.13	22±1
			16QAM	1	0	1	21.05	21.3±1
				1	7	1	21.10	21.3±1
				1	14	1	21.08	21.3±1
				8	0	2	21.03	21.3±1
				8	4	2	20.89	21.3±1
				8	7	2	20.93	21.3±1
				15	0	2	20.45	21.3±1
	20525	836.5	QPSK	1	0	0	22.16	22±1
				1	7	0	22.12	22±1
				1	14	0	22.10	22±1
				8	0	1	21.76	22±1
				8	4	1	21.83	22±1
				8	7	1	21.85	22±1
				15	0	1	21.16	22±1
			16QAM	1	0	1	21.45	21.3±1
				1	7	1	21.56	21.3±1
				1	14	1	21.59	21.3±1
				8	0	2	20.86	21.3±1
				8	4	2	20.88	21.3±1
				8	7	2	20.89	21.3±1
				15	0	2	20.41	21.3±1
	20635	847.5	QPSK	1	0	0	22.04	22±1
				1	7	0	22.10	22±1
1				14	0	22.06	22±1	
8				0	1	22.01	22±1	
8				4	1	21.85	22±1	
8				7	1	21.92	22±1	
15				0	1	21.31	22±1	
16QAM			1	0	1	21.86	21.3±1	
			1	7	1	21.56	21.3±1	
			1	14	1	21.52	21.3±1	
			8	0	2	21.03	21.3±1	
			8	4	2	21.08	21.3±1	
			8	7	2	21.11	21.3±1	
			15	0	2	20.46	21.3±1	

BW (MHz)	Ch	Freq. (MHz)	Mode	UL RB Allocation	UL RB Offset	MPR	Average power (dBm)	Tune up Power tolerant
1.4MHz	20407	824.7	QPSK	1	0	0	22.14	22±1
				1	2	0	22.11	22±1
				1	5	0	22.11	22±1
				3	0	0	22.19	22±1
				3	1	0	22.11	22±1
				3	2	0	22.14	22±1
				6	0	1	21.05	22±1
			16QAM	1	0	1	20.93	21.3±1
				1	2	1	20.90	21.3±1
				1	5	1	20.89	21.3±1
				3	0	1	20.56	21.3±1
				3	1	1	20.59	21.3±1
				3	2	1	20.58	21.3±1
				6	0	2	20.43	21.3±1
	20525	836.5	QPSK	1	0	0	22.16	22±1
				1	2	0	22.08	22±1
				1	5	0	22.13	22±1
				3	0	0	21.45	22±1
				3	1	0	21.34	22±1
				3	2	0	21.52	22±1
				6	0	1	21.12	22±1
			16QAM	1	0	1	21.13	21.3±1
				1	2	1	21.15	21.3±1
				1	5	1	21.11	21.3±1
				3	0	1	20.86	21.3±1
				3	1	1	20.95	21.3±1
				3	2	1	20.93	21.3±1
				6	0	2	20.41	21.3±1
	20643	848.3	QPSK	1	0	0	22.13	22±1
				1	2	0	22.08	22±1
				1	5	0	22.17	22±1
				3	0	0	21.69	22±1
				3	1	0	21.68	22±1
				3	2	0	21.53	22±1
				6	0	1	21.26	22±1
			16QAM	1	0	1	21.35	21.3±1
1				2	1	21.24	21.3±1	
1				5	1	21.22	21.3±1	
3				0	1	21.06	21.3±1	
3				1	1	21.07	21.3±1	
3				2	1	20.94	21.3±1	
6				0	2	20.43	21.3±1	

LTE Band 12:

BW (MHz)	Ch	Freq. (MHz)	Mode	UL RB Allocation	UL RB Offset	MPR	Average power (dBm)	Tune up Power tolerant
10MHz	23060	704	QPSK	1	0	0	23.25	23±1
				1	24	0	23.15	23±1
				1	49	0	23.28	23±1
				25	0	1	23.46	23±1
				25	12	1	23.42	23±1
				25	24	1	23.48	23±1
				50	0	1	23.46	23±1
			16QAM	1	0	1	23.85	23±1
				1	24	1	23.82	23±1
				1	49	1	23.86	23±1
				25	0	2	23.26	23±1
				25	12	2	23.25	23±1
				25	24	2	23.26	23±1
				50	0	2	23.47	23±1
	23095	707.5	QPSK	1	0	0	23.27	23±1
				1	24	0	23.16	23±1
				1	49	0	23.22	23±1
				25	0	1	23.33	23±1
				25	12	1	23.38	23±1
				25	24	1	23.31	23±1
				50	0	1	23.41	23±1
			16QAM	1	0	1	23.68	23±1
				1	24	1	23.61	23±1
				1	49	1	23.65	23±1
				25	0	2	23.52	23±1
				25	12	2	23.51	23±1
				25	24	2	23.59	23±1
				50	0	2	23.45	23±1
	23130	711	QPSK	1	0	0	23.48	23±1
				1	24	0	23.44	23±1
1				49	0	23.41	23±1	
25				0	1	23.39	23±1	
25				12	1	23.33	23±1	
25				24	1	23.36	23±1	
50				0	1	23.40	23±1	
16QAM			1	0	1	23.24	23±1	
			1	24	1	23.29	23±1	
			1	49	1	23.22	23±1	
			25	0	2	23.16	23±1	
			25	12	2	23.15	23±1	
			25	24	2	23.19	23±1	
			50	0	2	23.35	23±1	

BW (MHz)	Ch	Freq. (MHz)	Mode	UL RB Allocation	UL RB Offset	MPR	Average power (dBm)	Tune up Power tolerant
5MHz	23035	701.5	QPSK	1	0	0	23.36	23±1
				1	12	0	23.32	23±1
				1	24	0	23.38	23±1
				12	0	1	23.51	23±1
				12	6	1	23.53	23±1
				12	11	1	23.54	23±1
			16QAM	25	0	1	23.44	23±1
				1	0	1	23.31	23±1
				1	12	1	23.35	23±1
				1	24	1	23.33	23±1
				12	0	2	23.36	23±1
				12	6	2	23.35	23±1
	23095	707.5	QPSK	12	11	2	23.39	23±1
				12	11	2	23.39	23±1
				25	0	2	23.41	23±1
				1	0	0	23.27	23±1
				1	12	0	23.26	23±1
				1	24	0	23.21	23±1
			16QAM	12	0	1	23.39	23±1
				12	6	1	23.33	23±1
				12	11	1	23.35	23±1
				25	0	1	23.41	23±1
				1	0	1	23.59	23±1
				1	12	1	23.53	23±1
	23155	713.5	QPSK	1	24	1	23.46	23±1
				12	0	2	23.43	23±1
				12	6	2	23.45	23±1
				12	11	2	23.48	23±1
				25	0	2	23.40	23±1
				1	0	0	23.32	23±1
16QAM			1	12	0	23.31	23±1	
			1	24	0	23.36	23±1	
			12	0	1	23.42	23±1	
			12	6	1	23.45	23±1	
			12	11	1	23.41	23±1	
			25	0	1	23.32	23±1	
1	0	1	23.33	23±1				
1	12	1	23.31	23±1				
1	24	1	23.35	23±1				
12	0	2	23.26	23±1				
12	6	2	23.25	23±1				
12	11	2	23.23	23±1				
25	0	2	23.29	23±1				

BW (MHz)	Ch	Freq. (MHz)	Mode	UL RB Allocation	UL RB Offset	MPR	Average power (dBm)	Tune up Power tolerant
3MHz	23025	700.5	QPSK	1	0	0	23.33	23±1
				1	7	0	23.31	23±1
				1	14	0	23.36	23±1
				8	0	1	23.44	23±1
				8	4	1	23.45	23±1
				8	7	1	23.42	23±1
				15	0	1	23.45	23±1
			16QAM	1	0	1	23.69	23±1
				1	7	1	23.62	23±1
				1	14	1	23.65	23±1
				8	0	2	23.32	23±1
				8	4	2	23.35	23±1
				8	7	2	23.34	23±1
				15	0	2	23.43	23±1
	23095	707.5	QPSK	1	0	0	23.29	23±1
				1	7	0	23.26	23±1
				1	14	0	23.21	23±1
				8	0	1	23.44	23±1
				8	4	1	23.45	23±1
				8	7	1	23.41	23±1
				15	0	1	23.45	23±1
			16QAM	1	0	1	23.69	23±1
				1	7	1	23.62	23±1
				1	14	1	23.68	23±1
				8	0	2	23.32	23±1
				8	4	2	23.35	23±1
				8	7	2	23.36	23±1
				15	0	2	23.43	23±1
	23025	714.5	QPSK	1	0	0	23.37	23±1
				1	7	0	23.35	23±1
1				14	0	23.33	23±1	
8				0	1	23.38	23±1	
8				4	1	23.36	23±1	
8				7	1	23.34	23±1	
15				0	1	23.37	23±1	
16QAM			1	0	1	23.14	23±1	
			1	7	1	23.16	23±1	
			1	14	1	23.18	23±1	
			8	0	2	23.28	23±1	
			8	4	2	23.26	23±1	
			8	7	2	23.22	23±1	
			15	0	2	23.25	23±1	

BW (MHz)	Ch	Freq. (MHz)	Mode	UL RB Allocation	UL RB Offset	MPR	Average power (dBm)	Tune up Power tolerant
1.4MHz	23017	699.7	QPSK	1	0	0	23.37	23±1
				1	2	0	23.35	23±1
				1	5	0	23.31	23±1
				3	0	0	23.46	23±1
				3	1	0	23.43	23±1
				3	2	0	23.49	23±1
			6	0	1	23.41	23±1	
			16QAM	1	0	1	23.03	23±1
				1	2	1	23.04	23±1
				1	5	1	23.06	23±1
				3	0	1	23.12	23±1
				3	1	1	23.16	23±1
	3	2		1	23.14	23±1		
	6	0	2	23.24	23±1			
	23095	707.5	QPSK	1	0	0	23.34	23±1
				1	2	0	23.35	23±1
				1	5	0	23.33	23±1
				3	0	0	23.48	23±1
				3	1	0	23.46	23±1
				3	2	0	23.41	23±1
			6	0	1	23.25	23±1	
			16QAM	1	0	1	23.18	23±1
				1	2	1	23.12	23±1
				1	5	1	23.14	23±1
				3	0	1	23.20	23±1
				3	1	1	23.21	23±1
	3	2		1	23.21	23±1		
	6	0	2	23.26	23±1			
	23173	715.3	QPSK	1	0	0	23.39	23±1
				1	2	0	23.36	23±1
1				5	0	23.35	23±1	
3				0	0	23.46	23±1	
3				1	0	23.42	23±1	
3				2	0	23.48	23±1	
6			0	1	23.33	23±1		
16QAM			1	0	1	23.28	23±1	
			1	2	1	23.26	23±1	
			1	5	1	23.27	23±1	
			3	0	1	23.24	23±1	
			3	1	1	23.22	23±1	
	3	2	1	23.21	23±1			
6	0	2	23.14	23±1				

LTE Band 17:

BW (MHz)	Ch	Freq. (MHz)	Mode	UL RB Allocation	UL RB Offset	MPR	Average power (dBm)	Tune up Power tolerant
10MHz	23780	709.0	QPSK	1	0	0	22.89	22±1
				1	24	0	22.93	22±1
				1	49	0	22.82	22±1
				25	0	1	22.03	22±1
				25	12	1	22.01	22±1
				25	24	1	22.08	22±1
				50	0	1	22.02	22±1
			16QAM	1	0	1	22.59	22±1
				1	24	1	22.60	22±1
				1	49	1	22.63	22±1
				25	0	2	22.15	22±1
				25	12	2	22.13	22±1
				25	24	2	22.15	22±1
				50	0	2	21.14	22±1
	23790	701.0	QPSK	1	0	0	22.13	22±1
				1	24	0	22.19	22±1
				1	49	0	22.05	22±1
				25	0	1	21.56	22±1
				25	12	1	21.75	22±1
				25	24	1	21.68	22±1
				50	0	1	21.31	22±1
			16QAM	1	0	1	21.85	21.3±1
				1	24	1	21.86	21.3±1
				1	49	1	21.80	21.3±1
				25	0	2	21.15	21.3±1
				25	12	2	21.26	21.3±1
				25	24	2	21.27	21.3±1
				50	0	2	20.53	21.3±1
	23800	711.0	QPSK	1	0	0	22.03	22±1
				1	24	0	22.01	22±1
1				49	0	22.06	22±1	
25				0	1	21.86	22±1	
25				12	1	21.88	22±1	
25				24	1	21.91	22±1	
50				0	1	21.23	22±1	
16QAM			1	0	1	21.86	21.3±1	
			1	24	1	21.91	21.3±1	
			1	49	1	21.88	21.3±1	
			25	0	2	21.12	21.3±1	
			25	12	2	21.05	21.3±1	
			25	24	2	20.89	21.3±1	
			50	0	2	20.51	21.3±1	

BW (MHz)	Ch	Freq. (MHz)	Mode	UL RB Allocation	UL RB Offset	MPR	Average power (dBm)	Tune up Power tolerant
5MHz	23755	706.5	QPSK	1	0	0	23.03	22.3±1
				1	12	0	22.79	22.3±1
				1	24	0	22.99	22.3±1
				12	0	1	22.05	22.3±1
				12	6	1	21.96	22.3±1
				12	11	1	21.95	22.3±1
			25	0	1	22.00	22.3±1	
			16QAM	1	0	1	22.03	21.3±1
				1	12	1	21.91	21.3±1
				1	24	1	21.97	21.3±1
				12	0	2	21.64	21.3±1
				12	6	2	21.65	21.3±1
	12	11		2	21.64	21.3±1		
	25	0	2	20.85	21.3±1			
	23790	710.0	QPSK	1	0	0	22.46	22±1
				1	12	0	22.35	22±1
				1	24	0	22.38	22±1
				12	0	1	21.84	22±1
				12	6	1	21.88	22±1
				12	11	1	21.82	22±1
			25	0	1	21.76	22±1	
			16QAM	1	0	1	22.04	21.3±1
				1	12	1	21.96	21.3±1
				1	24	1	21.91	21.3±1
				12	0	2	21.58	21.3±1
				12	6	2	21.62	21.3±1
	12	11		2	21.64	21.3±1		
	25	0	2	20.68	21.3±1			
	23825	713.5	QPSK	1	0	0	22.26	21.3±1
				1	12	0	22.21	21.3±1
1				24	0	22.19	21.3±1	
12				0	1	21.89	21.3±1	
12				6	1	21.95	21.3±1	
12				11	1	21.96	21.3±1	
25			0	1	21.43	21.3±1		
16QAM			1	0	1	21.88	21.3±1	
			1	12	1	21.92	21.3±1	
			1	24	1	21.95	21.3±1	
			12	0	2	21.76	21.3±1	
			12	6	2	21.77	21.3±1	
	12	11	2	21.73	21.3±1			
25	0	2	20.89	21.3±1				

ERP & EIRP

EIRP for LTE Band 2 (Part 24E)

Frequency (MHz)	BW (MHz)	Modulation	RB Size/Offset	Substituted level (dBm)	Antenna Polarization	Antenna Gain correction (dBi)	Cable Loss (dB)	Absolute Level (dBm)	Limit (dBm)
1850.7	1.4	QPSK	1/0	9.83	V	7.88	0.85	16.86	33.01
1880	1.4	QPSK	1/0	9.91	V	7.88	0.85	16.94	33.01
1909.3	1.4	QPSK	1/0	9.86	V	7.88	0.85	16.89	33.01
1850.7	1.4	QPSK	1/0	8.24	H	7.88	0.85	15.27	33.01
1880	1.4	QPSK	1/0	8.17	H	7.88	0.85	15.20	33.01
1909.3	1.4	QPSK	1/0	8.29	H	7.88	0.85	15.32	33.01
1850.7	1.4	16-QAM	1/0	9.13	V	7.88	0.85	16.16	33.01
1880	1.4	16-QAM	1/0	9.08	V	7.88	0.85	16.11	33.01
1909.3	1.4	16-QAM	1/0	9.15	V	7.88	0.85	16.18	33.01
1850.7	1.4	16-QAM	1/0	7.58	H	7.88	0.85	14.61	33.01
1880	1.4	16-QAM	1/0	7.61	H	7.88	0.85	14.64	33.01
1909.3	1.4	16-QAM	1/0	7.44	H	7.88	0.85	14.47	33.01
1851.5	3	QPSK	1/0	9.95	V	7.88	0.85	16.98	33.01
1880	3	QPSK	1/0	9.88	V	7.88	0.85	16.91	33.01
1908.5	3	QPSK	1/0	9.91	V	7.88	0.85	16.94	33.01
1851.5	3	QPSK	1/0	8.44	H	7.88	0.85	15.47	33.01
1880	3	QPSK	1/0	8.37	H	7.88	0.85	15.40	33.01
1908.5	3	QPSK	1/0	8.25	H	7.88	0.85	15.28	33.01
1851.5	3	16-QAM	1/0	9.11	V	7.88	0.85	16.14	33.01
1880	3	16-QAM	1/0	9.08	V	7.88	0.85	16.11	33.01
1908.5	3	16-QAM	1/0	9.14	V	7.88	0.85	16.17	33.01
1851.5	3	16-QAM	1/0	7.63	H	7.88	0.85	14.66	33.01
1880	3	16-QAM	1/0	7.85	H	7.88	0.85	14.88	33.01
1908.5	3	16-QAM	1/0	7.59	H	7.88	0.85	14.62	33.01
1852.5	5	QPSK	1/24	10.02	V	7.88	0.85	17.05	33.01
1880	5	QPSK	1/0	9.98	V	7.88	0.85	17.01	33.01
1907.5	5	QPSK	1/24	9.95	V	7.88	0.85	16.98	33.01
1852.5	5	QPSK	1/24	8.34	H	7.88	0.85	15.37	33.01
1880	5	QPSK	1/0	8.59	H	7.88	0.85	15.62	33.01
1907.5	5	QPSK	1/24	8.61	H	7.88	0.85	15.64	33.01
1852.5	5	16-QAM	1/24	9.24	V	7.88	0.85	16.27	33.01
1880	5	16-QAM	1/0	9.18	V	7.88	0.85	16.21	33.01

1907.5	5	16-QAM	1/24	9.26	V	7.88	0.85	16.29	33.01
1852.5	5	16-QAM	1/24	7.81	H	7.88	0.85	14.84	33.01
1880	5	16-QAM	1/0	7.75	H	7.88	0.85	14.78	33.01
1907.5	5	16-QAM	1/24	7.68	H	7.88	0.85	14.71	33.01
1855	10	QPSK	1/0	9.94	V	7.88	0.85	16.97	33.01
1880	10	QPSK	1/0	9.89	V	7.88	0.85	16.92	33.01
1905	10	QPSK	1/49	9.93	V	7.88	0.85	16.96	33.01
1855	10	QPSK	1/0	8.66	H	7.88	0.85	15.69	33.01
1880	10	QPSK	1/0	8.57	H	7.88	0.85	15.60	33.01
1905	10	QPSK	1/49	8.51	H	7.88	0.85	15.54	33.01
1855	10	16-QAM	1/0	9.26	V	7.88	0.85	16.29	33.01
1880	10	16-QAM	1/0	9.13	V	7.88	0.85	16.16	33.01
1905	10	16-QAM	1/49	9.27	V	7.88	0.85	16.30	33.01
1855	10	16-QAM	1/0	8.01	H	7.88	0.85	15.04	33.01
1880	10	16-QAM	1/0	7.96	H	7.88	0.85	14.99	33.01
1905	10	16-QAM	1/49	7.99	H	7.88	0.85	15.02	33.01
1857.5	15	QPSK	1/0	9.97	V	7.88	0.85	17.00	33.01
1880	15	QPSK	1/0	9.88	V	7.88	0.85	16.91	33.01
1902.5	15	QPSK	1/0	9.95	V	7.88	0.85	16.98	33.01
1857.5	15	QPSK	1/0	8.61	H	7.88	0.85	15.64	33.01
1880	15	QPSK	1/0	8.75	H	7.88	0.85	15.78	33.01
1902.5	15	QPSK	1/0	8.69	H	7.88	0.85	15.72	33.01
1857.5	15	16-QAM	1/0	9.03	V	7.88	0.85	16.06	33.01
1880	15	16-QAM	1/0	9.12	V	7.88	0.85	16.15	33.01
1902.5	15	16-QAM	1/0	9.16	V	7.88	0.85	16.19	33.01
1857.5	15	16-QAM	1/0	7.95	H	7.88	0.85	14.98	33.01
1880	15	16-QAM	1/0	8.11	H	7.88	0.85	15.14	33.01
1902.5	15	16-QAM	1/0	8.06	H	7.88	0.85	15.09	33.01
1860	20	QPSK	1/0	10.13	V	7.88	0.85	17.16	33.01
1880	20	QPSK	1/0	10.15	V	7.88	0.85	17.18	33.01
1900	20	QPSK	1/0	10.09	V	7.88	0.85	17.12	33.01
1860	20	QPSK	1/0	8.94	H	7.88	0.85	15.97	33.01
1880	20	QPSK	1/0	8.79	H	7.88	0.85	15.82	33.01
1900	20	QPSK	1/0	8.96	H	7.88	0.85	15.99	33.01
1860	20	16-QAM	1/0	9.35	V	7.88	0.85	16.38	33.01
1880	20	16-QAM	1/0	9.47	V	7.88	0.85	16.50	33.01
1900	20	16-QAM	1/0	9.38	V	7.88	0.85	16.41	33.01
1860	20	16-QAM	1/0	8.26	H	7.88	0.85	15.29	33.01

Test Report	15071019-FCC-R5
Page	37 of 132

1880	20	16-QAM	1/0	8.17	H	7.88	0.85	15.20	33.01
1900	20	16-QAM	1/0	8.14	H	7.88	0.85	15.17	33.01

EIRP for LTE Band 4 (Part 27)

Frequency (MHz)	BW (MHz)	Modulation	RB Size/Offset	Substituted level (dBm)	Antenna Polarization	Antenna Gain correction (dBi)	Cable Loss (dB)	Absolute Level (dBm)	Limit (dBm)
1710.7	1.4	QPSK	1/0	10.52	V	7.95	0.79	17.68	30
1732.5	1.4	QPSK	1/0	10.66	V	7.95	0.79	17.82	30
1754.3	1.4	QPSK	1/0	10.74	V	7.95	0.79	17.90	30
1710.7	1.4	QPSK	1/0	9.83	H	7.95	0.79	16.99	30
1732.5	1.4	QPSK	1/0	9.96	H	7.95	0.79	17.12	30
1754.3	1.4	QPSK	1/0	9.41	H	7.95	0.79	16.57	30
1710.7	1.4	16-QAM	1/5	9.75	V	7.95	0.79	16.91	30
1732.5	1.4	16-QAM	1/0	9.82	V	7.95	0.79	16.98	30
1754.3	1.4	16-QAM	1/0	9.88	V	7.95	0.79	17.04	30
1710.7	1.4	16-QAM	1/5	9.27	H	7.95	0.79	16.43	30
1732.5	1.4	16-QAM	1/0	9.11	H	7.95	0.79	16.27	30
1754.3	1.4	16-QAM	1/0	9.35	H	7.95	0.79	16.51	30
1711.5	3	QPSK	1/0	10.26	V	7.95	0.79	17.42	30
1732.5	3	QPSK	1/0	10.13	V	7.95	0.79	17.29	30
1753.5	3	QPSK	1/0	10.25	V	7.95	0.79	17.41	30
1711.5	3	QPSK	1/0	9.55	H	7.95	0.79	16.71	30
1732.5	3	QPSK	1/0	9.48	H	7.95	0.79	16.64	30
1753.5	3	QPSK	1/0	9.53	H	7.95	0.79	16.69	30
1711.5	3	16-QAM	1/0	9.37	V	7.95	0.79	16.53	30
1732.5	3	16-QAM	1/0	9.42	V	7.95	0.79	16.58	30
1753.5	3	16-QAM	1/0	9.56	V	7.95	0.79	16.72	30
1711.5	3	16-QAM	1/0	8.89	H	7.95	0.79	16.05	30
1732.5	3	16-QAM	1/0	8.95	H	7.95	0.79	16.11	30
1753.5	3	16-QAM	1/0	8.86	H	7.95	0.79	16.02	30
1712.5	5	QPSK	1/0	10.44	V	7.95	0.79	17.60	30
1732.5	5	QPSK	1/0	10.51	V	7.95	0.79	17.67	30
1752.5	5	QPSK	1/24	10.28	V	7.95	0.79	17.44	30
1712.5	5	QPSK	1/0	9.78	H	7.95	0.79	16.94	30
1732.5	5	QPSK	1/0	9.84	H	7.95	0.79	17.00	30
1752.5	5	QPSK	1/24	9.52	H	7.95	0.79	16.68	30
1712.5	5	16-QAM	1/0	9.67	V	7.95	0.79	16.83	30
1732.5	5	16-QAM	1/0	9.83	V	7.95	0.79	16.99	30
1752.5	5	16-QAM	1/24	9.69	V	7.95	0.79	16.85	30

1712.5	5	16-QAM	1/0	8.92	H	7.95	0.79	16.08	30
1732.5	5	16-QAM	1/0	8.85	H	7.95	0.79	16.01	30
1752.5	5	16-QAM	1/24	8.89	H	7.95	0.79	16.05	30
1715	10	QPSK	1/0	10.19	V	7.95	0.79	17.35	30
1732.5	10	QPSK	1/49	10.24	V	7.95	0.79	17.40	30
1750	10	QPSK	1/0	10.29	V	7.95	0.79	17.45	30
1715	10	QPSK	1/0	9.46	H	7.95	0.79	16.62	30
1732.5	10	QPSK	1/49	9.44	H	7.95	0.79	16.60	30
1750	10	QPSK	1/0	9.38	H	7.95	0.79	16.54	30
1715	10	16-QAM	1/0	9.37	V	7.95	0.79	16.53	30
1732.5	10	16-QAM	1/49	9.68	V	7.95	0.79	16.84	30
1750	10	16-QAM	1/0	9.55	V	7.95	0.79	16.71	30
1715	10	16-QAM	1/0	8.49	H	7.95	0.79	15.65	30
1732.5	10	16-QAM	1/49	8.33	H	7.95	0.79	15.49	30
1750	10	16-QAM	1/0	8.56	H	7.95	0.79	15.72	30
1717.5	15	QPSK	1/0	10.11	V	7.95	0.79	17.27	30
1732.5	15	QPSK	1/74	10.27	V	7.95	0.79	17.43	30
1747.5	15	QPSK	1/0	10.34	V	7.95	0.79	17.50	30
1717.5	15	QPSK	1/0	9.59	H	7.95	0.79	16.75	30
1732.5	15	QPSK	1/74	9.34	H	7.95	0.79	16.50	30
1747.5	15	QPSK	1/0	9.71	H	7.95	0.79	16.87	30
1717.5	15	16-QAM	1/0	9.85	V	7.95	0.79	17.01	30
1732.5	15	16-QAM	1/74	9.63	V	7.95	0.79	16.79	30
1747.5	15	16-QAM	1/0	9.74	V	7.95	0.79	16.90	30
1717.5	15	16-QAM	1/0	8.59	H	7.95	0.79	15.75	30
1732.5	15	16-QAM	1/74	8.64	H	7.95	0.79	15.80	30
1747.5	15	16-QAM	1/0	8.71	H	7.95	0.79	15.87	30
1720	20	QPSK	1/99	10.66	V	7.95	0.79	17.82	30
1732.5	20	QPSK	1/99	10.52	V	7.95	0.79	17.68	30
1745	20	QPSK	1/0	10.64	V	7.95	0.79	17.80	30
1720	20	QPSK	1/99	9.83	H	7.95	0.79	16.99	30
1732.5	20	QPSK	1/99	9.91	H	7.95	0.79	17.07	30
1745	20	QPSK	1/0	9.95	H	7.95	0.79	17.11	30
1720	20	16-QAM	1/99	9.62	V	7.95	0.79	16.78	30
1732.5	20	16-QAM	1/99	9.74	V	7.95	0.79	16.90	30
1745	20	16-QAM	1/0	9.83	V	7.95	0.79	16.99	30
1720	20	16-QAM	1/99	8.45	H	7.95	0.79	15.61	30
1732.5	20	16-QAM	1/99	8.41	H	7.95	0.79	15.57	30

Test Report	15071019-FCC-R5
Page	40 of 132

1745	20	16-QAM	1/0	8.47	H	7.95	0.79	15.63	30
------	----	--------	-----	------	---	------	------	-------	----

EIRP for LTE Band 5 (Part 22)

Frequency (MHz)	BW (MHz)	Modulation	RB Size/Offset	Substituted level (dBm)	Antenna Polarization	Antenna Gain correction (dBi)	Cable Loss (dB)	Absolute Level (dBm)	Limit (dBm)
824.7	1.4	QPSK	1/5	11.84	V	6.8	0.44	18.20	34.77
836.5	1.4	QPSK	1/5	11.91	V	6.8	0.44	18.27	34.77
848.3	1.4	QPSK	1/5	11.87	V	6.9	0.44	18.33	34.77
824.7	1.4	QPSK	1/5	10.13	H	6.8	0.44	16.49	34.77
836.5	1.4	QPSK	1/5	10.05	H	6.8	0.44	16.41	34.77
848.3	1.4	QPSK	1/5	10.12	H	6.9	0.44	16.58	34.77
824.7	1.4	16-QAM	1/5	11.52	V	6.8	0.44	17.88	34.77
836.5	1.4	16-QAM	1/5	11.48	V	6.8	0.44	17.84	34.77
848.3	1.4	16-QAM	1/5	11.63	V	6.9	0.44	18.09	34.77
824.7	1.4	16-QAM	1/5	9.48	H	6.8	0.44	15.84	34.77
836.5	1.4	16-QAM	1/5	9.32	H	6.8	0.44	15.68	34.77
848.3	1.4	16-QAM	1/5	9.44	H	6.9	0.44	15.90	34.77
825.5	3	QPSK	1/14	11.66	V	6.8	0.44	18.02	34.77
836.5	3	QPSK	1/0	11.75	V	6.8	0.44	18.11	34.77
847.5	3	QPSK	1/14	11.49	V	6.9	0.44	17.95	34.77
825.5	3	QPSK	1/14	9.82	H	6.8	0.44	16.18	34.77
836.5	3	QPSK	1/0	9.87	H	6.8	0.44	16.23	34.77
847.5	3	QPSK	1/14	9.69	H	6.9	0.44	16.15	34.77
825.5	3	16-QAM	1/14	11.41	V	6.8	0.44	17.77	34.77
836.5	3	16-QAM	1/0	11.68	V	6.8	0.44	18.04	34.77
847.5	3	16-QAM	1/14	11.52	V	6.9	0.44	17.98	34.77
825.5	3	16-QAM	1/14	9.63	H	6.8	0.44	15.99	34.77
836.5	3	16-QAM	1/0	9.58	H	6.8	0.44	15.94	34.77
847.5	3	16-QAM	1/14	9.71	H	6.9	0.44	16.17	34.77
826.5	5	QPSK	1/24	11.64	V	6.8	0.44	18.00	34.77
836.5	5	QPSK	1/24	11.78	V	6.8	0.44	18.14	34.77
846.5	5	QPSK	1/24	11.55	V	6.8	0.44	17.91	34.77
826.5	5	QPSK	1/24	9.86	H	6.8	0.44	16.22	34.77
836.5	5	QPSK	1/24	9.92	H	6.8	0.44	16.28	34.77
846.5	5	QPSK	1/24	9.95	H	6.8	0.44	16.31	34.77
826.5	5	16-QAM	1/24	11.18	V	6.8	0.44	17.54	34.77
836.5	5	16-QAM	1/24	11.21	V	6.8	0.44	17.57	34.77
846.5	5	16-QAM	1/24	11.34	V	6.8	0.44	17.70	34.77

826.5	5	16-QAM	1/24	9.38	H	6.8	0.44	15.74	34.77
836.5	5	16-QAM	1/24	9.45	H	6.8	0.44	15.81	34.77
846.5	5	16-QAM	1/24	9.41	H	6.8	0.44	15.77	34.77
829	10	QPSK	1/49	11.64	V	6.8	0.44	18.00	34.77
836.5	10	QPSK	1/49	11.72	V	6.8	0.44	18.08	34.77
844	10	QPSK	1/49	11.79	V	6.8	0.44	18.15	34.77
829	10	QPSK	1/49	9.25	H	6.8	0.44	15.61	34.77
836.5	10	QPSK	1/49	9.33	H	6.8	0.44	15.69	34.77
844	10	QPSK	1/49	9.29	H	6.8	0.44	15.65	34.77
829	10	16-QAM	1/49	11.34	V	6.8	0.44	17.70	34.77
836.5	10	16-QAM	1/49	11.19	V	6.8	0.44	17.55	34.77
844	10	16-QAM	1/49	11.25	V	6.8	0.44	17.61	34.77
829	10	16-QAM	1/49	9.38	H	6.8	0.44	15.74	34.77
836.5	10	16-QAM	1/49	9.25	H	6.8	0.44	15.61	34.77
844	10	16-QAM	1/49	9.22	H	6.8	0.44	15.58	34.77

ERP for LTE Band 12 (Part 27)

Frequency (MHz)	BW (MHz)	Modulation	RB Size/Offset	Substituted level (dBm)	Antenna Polarization	Antenna Gain correction (dBi)	Cable Loss (dB)	Absolute Level (dBm)	Limit (dBm)
699.7	1.4	QPSK	1/5	11.83	V	6.9	0.42	18.31	34.77
707.5	1.4	QPSK	1/5	11.78	V	6.8	0.42	18.16	34.77
715.3	1.4	QPSK	1/5	11.81	V	6.8	0.42	18.19	34.77
699.7	1.4	QPSK	1/5	10.93	H	6.9	0.42	17.41	34.77
707.5	1.4	QPSK	1/5	10.89	H	6.8	0.42	17.27	34.77
715.3	1.4	QPSK	1/5	10.95	H	6.8	0.42	17.33	34.77
699.7	1.4	16-QAM	1/5	11.68	V	6.9	0.42	18.16	34.77
707.5	1.4	16-QAM	1/5	11.61	V	6.8	0.42	17.99	34.77
715.3	1.4	16-QAM	1/5	11.74	V	6.8	0.42	18.12	34.77
699.7	1.4	16-QAM	1/5	10.49	H	6.9	0.42	16.97	34.77
707.5	1.4	16-QAM	1/5	10.51	H	6.8	0.42	16.89	34.77
715.3	1.4	16-QAM	1/5	10.48	H	6.8	0.42	16.86	34.77
700.5	3	QPSK	1/14	11.82	V	6.9	0.42	18.30	34.77
707.5	3	QPSK	1/0	11.85	V	6.8	0.42	18.23	34.77
714.5	3	QPSK	1/14	11.81	V	6.8	0.42	18.19	34.77
700.5	3	QPSK	1/14	10.75	H	6.9	0.42	17.23	34.77
707.5	3	QPSK	1/0	10.71	H	6.8	0.42	17.09	34.77
714.5	3	QPSK	1/14	10.69	H	6.8	0.42	17.07	34.77
700.5	3	16-QAM	1/14	11.63	V	6.9	0.42	18.11	34.77
707.5	3	16-QAM	1/0	11.58	V	6.8	0.42	17.96	34.77
714.5	3	16-QAM	1/14	11.61	V	6.8	0.42	17.99	34.77
700.5	3	16-QAM	1/14	10.85	H	6.9	0.42	17.33	34.77
707.5	3	16-QAM	1/0	10.81	H	6.8	0.42	17.19	34.77
714.5	3	16-QAM	1/14	10.86	H	6.8	0.42	17.24	34.77
701.5	5	QPSK	1/24	11.79	V	6.9	0.42	18.27	34.77
707.5	5	QPSK	1/24	11.82	V	6.8	0.42	18.20	34.77
713.5	5	QPSK	1/24	11.73	V	6.8	0.42	18.11	34.77
701.5	5	QPSK	1/24	10.62	H	6.9	0.42	17.10	34.77
707.5	5	QPSK	1/24	10.68	H	6.8	0.42	17.06	34.77
713.5	5	QPSK	1/24	10.63	H	6.8	0.42	17.01	34.77
701.5	5	16-QAM	1/24	11.73	V	6.9	0.42	18.21	34.77
707.5	5	16-QAM	1/24	11.69	V	6.8	0.42	18.07	34.77
713.5	5	16-QAM	1/24	11.75	V	6.8	0.42	18.13	34.77

701.5	5	16-QAM	1/24	10.86	H	6.9	0.42	17.34	34.77
707.5	5	16-QAM	1/24	10.91	H	6.8	0.42	17.29	34.77
713.5	5	16-QAM	1/24	10.89	H	6.8	0.42	17.27	34.77
704	10	QPSK	1/49	11.76	V	6.8	0.42	18.14	34.77
707.5	10	QPSK	1/49	11.82	V	6.8	0.42	18.20	34.77
711	10	QPSK	1/49	11.84	V	6.8	0.42	18.22	34.77
704	10	QPSK	1/49	10.95	H	6.8	0.42	17.33	34.77
707.5	10	QPSK	1/49	10.87	H	6.8	0.42	17.25	34.77
711	10	QPSK	1/49	10.83	H	6.8	0.42	17.21	34.77
704	10	16-QAM	1/49	11.56	V	6.8	0.42	17.94	34.77
707.5	10	16-QAM	1/49	11.62	V	6.8	0.42	18.00	34.77
711	10	16-QAM	1/49	11.59	V	6.8	0.42	17.97	34.77
704	10	16-QAM	1/49	10.67	H	6.8	0.42	17.05	34.77
707.5	10	16-QAM	1/49	10.68	H	6.8	0.42	17.06	34.77
711	10	16-QAM	1/49	10.73	H	6.8	0.42	17.11	34.77

ERP for LTE Band 17 (Part 27)

Frequency (MHz)	BW (MHz)	Modulation	RB Size/Offset	Substituted level (dBm)	Antenna Polarization	Antenna Gain correction (dBi)	Cable Loss (dB)	Absolute Level (dBm)	Limit (dBm)
706.5	5	QPSK	1/0	11.29	V	6.8	0.42	17.67	34.77
710	5	QPSK	1/0	11.25	V	6.8	0.42	17.63	34.77
713.5	5	QPSK	1/0	11.31	V	6.8	0.42	17.69	34.77
706.5	5	QPSK	1/0	10.67	H	6.8	0.42	17.05	34.77
710	5	QPSK	1/0	10.81	H	6.8	0.42	17.19	34.77
713.5	5	QPSK	1/0	10.75	H	6.8	0.42	17.13	34.77
706.5	5	16-QAM	1/0	10.86	V	6.8	0.42	17.24	34.77
710	5	16-QAM	1/0	10.79	V	6.8	0.42	17.17	34.77
713.5	5	16-QAM	1/0	10.81	V	6.8	0.42	17.19	34.77
706.5	5	16-QAM	1/0	9.64	H	6.8	0.42	16.02	34.77
710	5	16-QAM	1/0	9.72	H	6.8	0.42	16.10	34.77
713.5	5	16-QAM	1/0	9.67	H	6.8	0.42	16.05	34.77
709	10	QPSK	1/0	11.49	V	6.8	0.42	17.87	34.77
710	10	QPSK	1/0	11.42	V	6.8	0.42	17.80	34.77
711	10	QPSK	1/0	11.37	V	6.8	0.42	17.75	34.77
709	10	QPSK	1/0	10.59	H	6.8	0.42	16.97	34.77
710	10	QPSK	1/0	10.52	H	6.8	0.42	16.90	34.77
711	10	QPSK	1/0	10.64	H	6.8	0.42	17.02	34.77
709	10	16-QAM	1/0	10.74	V	6.8	0.42	17.12	34.77
710	10	16-QAM	1/0	10.82	V	6.8	0.42	17.20	34.77
711	10	16-QAM	1/0	10.75	V	6.8	0.42	17.13	34.77
709	10	16-QAM	1/0	9.53	H	6.8	0.42	15.91	34.77
710	10	16-QAM	1/0	9.68	H	6.8	0.42	16.06	34.77
711	10	16-QAM	1/0	9.72	H	6.8	0.42	16.10	34.77

6.3 Peak-Average Ratio

Temperature	24°C
Relative Humidity	59%
Atmospheric Pressure	1007mbar
Test date :	August 07, 2015 and November 04, 2015
Tested By :	Winnie Zhang

Requirement(s):

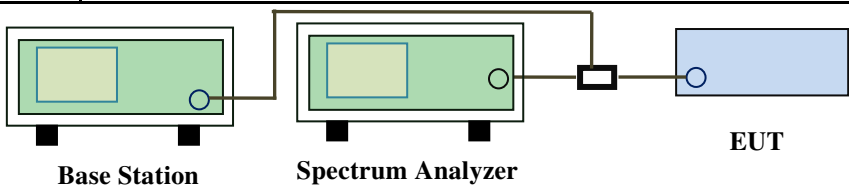
Spec	Item	Requirement	Applicable
§24.232(d) § 27.50(d)	a)	The peak-to-average ratio (PAR) of the transmission may not exceed 13 dB.	<input checked="" type="checkbox"/>
Test Setup	 <p style="text-align: center;">Base Station Spectrum Analyzer EUT</p>		
Test Procedure	<p>According with KDB 971168</p> <ol style="list-style-type: none"> 1. The signal analyzer' s CCDF measurement profile is enabled 2. Frequency = carrier center frequency 3. Measurement BW > Emission bandwidth of signal 4. The signal analyzer was set to collect one million samples to generate the CCDF curve 5. The measurement interval was set depending on the type of signal analyzed. For continuous signals (>98% duty cycle), the measurement interval was set to 1ms. For burst transmissions, the spectrum analyzer is set to use an internal “ RF Burst” trigger that is synced with an incoming pulse and the measurement interval is set to less than the duration of the “ on time” of one burst to ensure that energy is only captured during a time in which the transmitter is operating at maximum power 		
Remark			
Result	<input checked="" type="checkbox"/> Pass <input type="checkbox"/> Fail		

Test Data Yes N/A
 Test Plot Yes (See below) N/A

LTE Band 2 (part 24E)

BW(MHz)	Frequency (MHz)	Mode	Modulation	Conducted Power (dBm)		Peak-Average Ratio (PAR)
				Peak	Average	
1.4	1880	RB 1/0	QPSK	25.36	22.41	2.95
			16QAM	25.34	21.23	4.11
3	1880	RB 1/0	QPSK	25.19	22.16	3.03
			16QAM	25.34	21.12	4.22
5	1880	RB 1/0	QPSK	25.38	22.43	2.95
			16QAM	25.26	21.36	3.9
10	1880	RB 1/0	QPSK	25.39	22.35	3.04
			16QAM	25.31	21.89	3.42
15	1880	RB 1/0	QPSK	25.29	22.44	2.85
			16QAM	25.34	21.86	3.48
20	1880	RB 1/0	QPSK	25.24	22.63	2.61
			16QAM	25.23	21.86	3.37

LTE Band 4 (part 27)

BW(MHz)	Frequency (MHz)	Mode	Modulation	Conducted Power (dBm)		Peak-Average Ratio (PAR)
				Peak	Average	
1.4	1732.5	RB 1/0	QPSK	25.13	21.7	3.43
			16QAM	25.06	20.7	4.36
3	1732.5	RB 1/0	QPSK	25.28	21.65	3.63
			16QAM	25.16	21.24	3.92
5	1732.5	RB 1/0	QPSK	25.05	21.86	3.19
			16QAM	25.01	21.26	3.75
10	1732.5	RB 1/0	QPSK	24.98	21.86	3.12
			16QAM	24.96	21.35	3.61
15	1732.5	RB 1/0	QPSK	25.04	21.86	3.18
			16QAM	24.89	21.33	3.56
20	1732.5	RB 1/0	QPSK	25	21.86	3.14
			16QAM	24.96	21.35	3.61

LTE Band 5 (part 22H)

BW(MHz)	Frequency (MHz)	Mode	Modulation	Conducted Power (dBm)		Peak-Average Ratio (PAR)
				Peak	Average	
1.4	836.5	RB 1/0	QPSK	25.13	22.16	2.97
			16QAM	25.15	21.13	4.02
3	836.5	RB 1/0	QPSK	25.19	22.16	3.03
			16QAM	25.21	21.45	3.76
5	836.5	RB 1/0	QPSK	25.13	22.12	3.01
			16QAM	25.19	21.69	3.5
10	836.5	RB 1/0	QPSK	25.22	22.01	3.21
			16QAM	25.21	21.74	3.47

LTE Band 12 (part 27)

BW(MHz)	Frequency (MHz)	Mode	Modulation	Conducted Power (dBm)		Peak-Average Ratio (PAR)
				Peak	Average	
1.4	1732.5	RB 1/0	QPSK	25.56	23.34	2.22
			16QAM	25.56	23.18	2.38
3	1732.5	RB 1/0	QPSK	25.68	23.29	2.39
			16QAM	25.69	23.69	2
5	1732.5	RB 1/0	QPSK	25.77	23.27	2.5
			16QAM	25.72	23.59	2.13
10	1732.5	RB 1/0	QPSK	25.73	23.27	2.46
			16QAM	25.46	23.68	1.78

LTE Band 17 (part 27)

BW(MHz)	Frequency (MHz)	Mode	Modulation	Conducted Power (dBm)		Peak-Average Ratio (PAR)
				Peak	Average	
5	710	RB 1/0	QPSK	25.16	22.46	2.7
			16QAM	25.24	22.04	3.2
10	710	RB 1/0	QPSK	25.63	22.13	3.5
			16QAM	25.56	21.85	3.71

Test Report	15071019-FCC-R5
Page	49 of 132

6.4 Modulation Characteristic

According to FCC § 2.1047(d), Part 22H&24E& Part 27 there is no specific requirement for digital modulation, therefore modulation characteristic is not presented.

6.5 Occupied Bandwidth

Temperature	24°C
Relative Humidity	59%
Atmospheric Pressure	1007mbar
Test date :	August 07, 2015 and November 04, 2015
Tested By :	Winnie Zhang

Requirement(s):

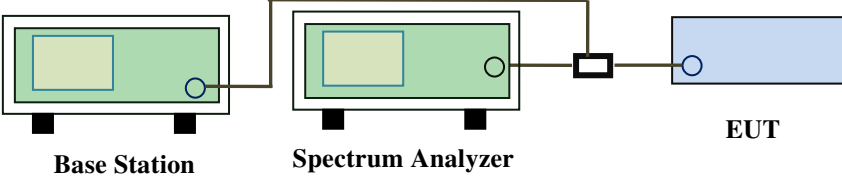
Spec	Item	Requirement	Applicable
§2.1049, §22.917, §22.905 §24.238 §27.53(a)	a)	99% Occupied Bandwidth(kHz)	<input checked="" type="checkbox"/>
	b)	26 dB Bandwidth(kHz)	<input checked="" type="checkbox"/>
Test Setup	 <p style="text-align: center;">Base Station Spectrum Analyzer EUT</p>		
Test Procedure	<ul style="list-style-type: none"> - The EUT was connected to Spectrum Analyzer and Base Station via power divider. - The 99% and 26 dB occupied bandwidth (BW) of the middle channel for the highest RF powers. 		
Remark			
Result	<input checked="" type="checkbox"/> Pass <input type="checkbox"/> Fail		

Test Data Yes N/A

Test Plot Yes (See below) N/A

LTE Band 2 (Part 24E)

BW(MHz)	Channel	Frequency (MHz)	Modulation	99% Occupied Bandwidth (MHz)	26 dB Bandwidth (MHz)
1.4	18607	1850.7	16QAM	1.1017	1.276
			QPSK	1.0914	1.277
1.4	18900	1880	16QAM	1.0903	1.270
			QPSK	1.0974	1.303
1.4	19193	1909.3	16QAM	1.0946	1.274
			QPSK	1.0983	1.282
3	18615	1851.5	16QAM	2.7433	3.070
			QPSK	2.7346	3.102
3	18900	1880	16QAM	2.7405	3.074
			QPSK	2.7359	3.066
3	19185	1908.5	16QAM	2.7408	3.061
			QPSK	2.7316	3.076
5	18625	1852.5	16QAM	4.5195	5.017
			QPSK	4.523	5.085
5	18900	1880	16QAM	4.5210	5.050
			QPSK	4.5286	5.004
5	19175	1907.5	16QAM	4.5375	5.087
			QPSK	4.5163	5.097
10	18650	1855	16QAM	9.0582	10.193
			QPSK	9.0707	9.990
10	18900	1880	16QAM	9.0605	10.249
			QPSK	9.1061	10.084
10	19150	1905	16QAM	9.0805	10.081
			QPSK	9.0594	10.145
15	18675	1857.5	16QAM	13.4946	14.910
			QPSK	13.4795	14.852
15	18900	1880	16QAM	13.449	14.925
			QPSK	13.4581	14.908
15	19125	1902.5	16QAM	13.4796	14.822
			QPSK	13.4737	14.770

20	18700	1860	16QAM	17.9006	19.375
			QPSK	17.9143	19.351
20	18900	1880	16QAM	17.9410	19.278
			QPSK	17.9800	19.473
20	19100	1900	16QAM	17.8842	19.067
			QPSK	17.8581	19.214

LTE Band 4 (Part 27)

BW(MHz)	Channel	Frequency (MHz)	Modulation	99% Occupied Bandwidth (MHz)	26 dB Bandwidth (MHz)
1.4	19957	1710.7	16QAM	1.1104	1.306
			QPSK	1.1078	1.297
1.4	20175	1732.5	16QAM	1.0929	1.279
			QPSK	1.0977	1.265
1.4	20393	1754.3	16QAM	1.0958	1.285
			QPSK	1.1023	1.269
3	19965	1711.5	16QAM	2.7228	3.038
			QPSK	2.7436	3.079
3	20175	1732.5	16QAM	2.7309	3.037
			QPSK	2.7322	3.088
3	20385	1753.5	16QAM	2.7412	3.063
			QPSK	2.7402	3.063
5	19975	1712.5	16QAM	4.5140	5.028
			QPSK	4.5076	4.979
5	20175	1732.5	16QAM	4.5115	5.098
			QPSK	4.5153	5.117
5	20375	1752.5	16QAM	4.5091	5.038
			QPSK	4.5133	5.066
10	20000	1715	16QAM	9.0862	10.024
			QPSK	9.0437	9.972
10	20175	1732.5	16QAM	9.0370	10.041
			QPSK	9.0362	10.004
10	20350	1750	16QAM	9.0418	10.146
			QPSK	9.0565	10.063

15	20025	1717.5	16QAM	13.5011	14.993
			QPSK	13.4612	14.716
15	20175	1732.5	16QAM	13.4548	14.739
			QPSK	13.4983	14.950
15	20325	1747.5	16QAM	13.4621	14.793
			QPSK	13.4525	14.634
20	20050	1720	16QAM	17.9078	19.095
			QPSK	17.8859	19.341
20	20175	1732.5	16QAM	17.8912	19.137
			QPSK	17.9043	19.190
20	20300	1745	16QAM	17.8998	19.370
			QPSK	17.9048	19.304

LTE Band 5 (Part 22H)

BW(MHz)	Channel	Frequency (MHz)	Modulation	99% Occupied Bandwidth (MHz)	26 dB Bandwidth (MHz)
1.4	20407	824.7	16QAM	1.0962	1.276
			QPSK	1.0897	1.289
1.4	20525	936.5	16QAM	1.0949	1.273
			QPSK	1.0958	1.264
1.4	20643	949.3	16QAM	1.0906	1.267
			QPSK	1.0947	1.257
3	20415	825.5	16QAM	2.7402	3.104
			QPSK	2.7308	3.102
3	20525	936.5	16QAM	2.7313	3.061
			QPSK	2.7423	3.058
3	20635	847.5	16QAM	2.7370	3.073
			QPSK	2.7425	3.087
5	20425	826.5	16QAM	4.5212	5.046
			QPSK	4.5230	5.024
5	20525	936.5	16QAM	4.5035	5.030
			QPSK	4.5045	5.044
5	20625	846.5	16QAM	4.5067	5.063
			QPSK	4.5106	5.052

10	20450	829	16QAM	9.1104	10.100
			QPSK	9.1043	10.176
10	20525	936.5	16QAM	9.0513	9.991
			QPSK	9.0606	10.152
10	20800	844	16QAM	9.0923	10.017
			QPSK	9.1049	10.193

LTE Band 12 (Part 27)

BW(MHz)	Channel	Frequency (MHz)	Modulation	99% Occupied Bandwidth (MHz)	26 dB Bandwidth (MHz)
1.4	23017	699.7	16QAM	1.1137	1.319
			QPSK	1.0937	1.281
1.4	23095	707.5	16QAM	1.0930	1.279
			QPSK	1.1007	1.263
1.4	23173	715.3	16QAM	1.1097	1.356
			QPSK	1.0973	1.268
3	23025	700.5	16QAM	2.7466	3.071
			QPSK	2.7638	3.126
3	23095	707.5	16QAM	2.7406	3.079
			QPSK	2.7413	3.080
3	23165	714.5	16QAM	2.7526	3.189
			QPSK	2.7480	3.057
5	23035	701.5	16QAM	4.5422	6.031
			QPSK	4.5516	5.546
5	23095	707.5	16QAM	4.5210	5.028
			QPSK	4.5267	5.054
5	23055	713.5	16QAM	4.5318	5.011
			QPSK	4.5477	5.514
10	23060	704	16QAM	9.1653	10.251
			QPSK	9.1862	11.558
10	23095	707.5	16QAM	9.0603	10.099
			QPSK	9.0703	10.091
10	23130	711	16QAM	9.0024	9.990
			QPSK	9.0179	10.017

LTE Band 17 (Part 27)

BW(MHz)	Channel	Frequency (MHz)	Modulation	99% Occupied Bandwidth (MHz)	26 dB Bandwidth (MHz)
5	23755	706.5	16QAM	4.5057	5.018
			QPSK	4.5110	5.017
5	23790	710	16QAM	4.5273	5.052
			QPSK	4.5322	5.010
5	23825	713.5	16QAM	4.5423	5.053
			QPSK	4.5152	5.041
10	23780	709	16QAM	9.1036	10.142
			QPSK	9.0948	10.189
10	23790	710	16QAM	9.1228	10.156
			QPSK	9.1033	10.069
10	23800	711	16QAM	9.1233	10.157
			QPSK	9.1068	10.093

Test Plots

LTE Band 2 (Part 24E)

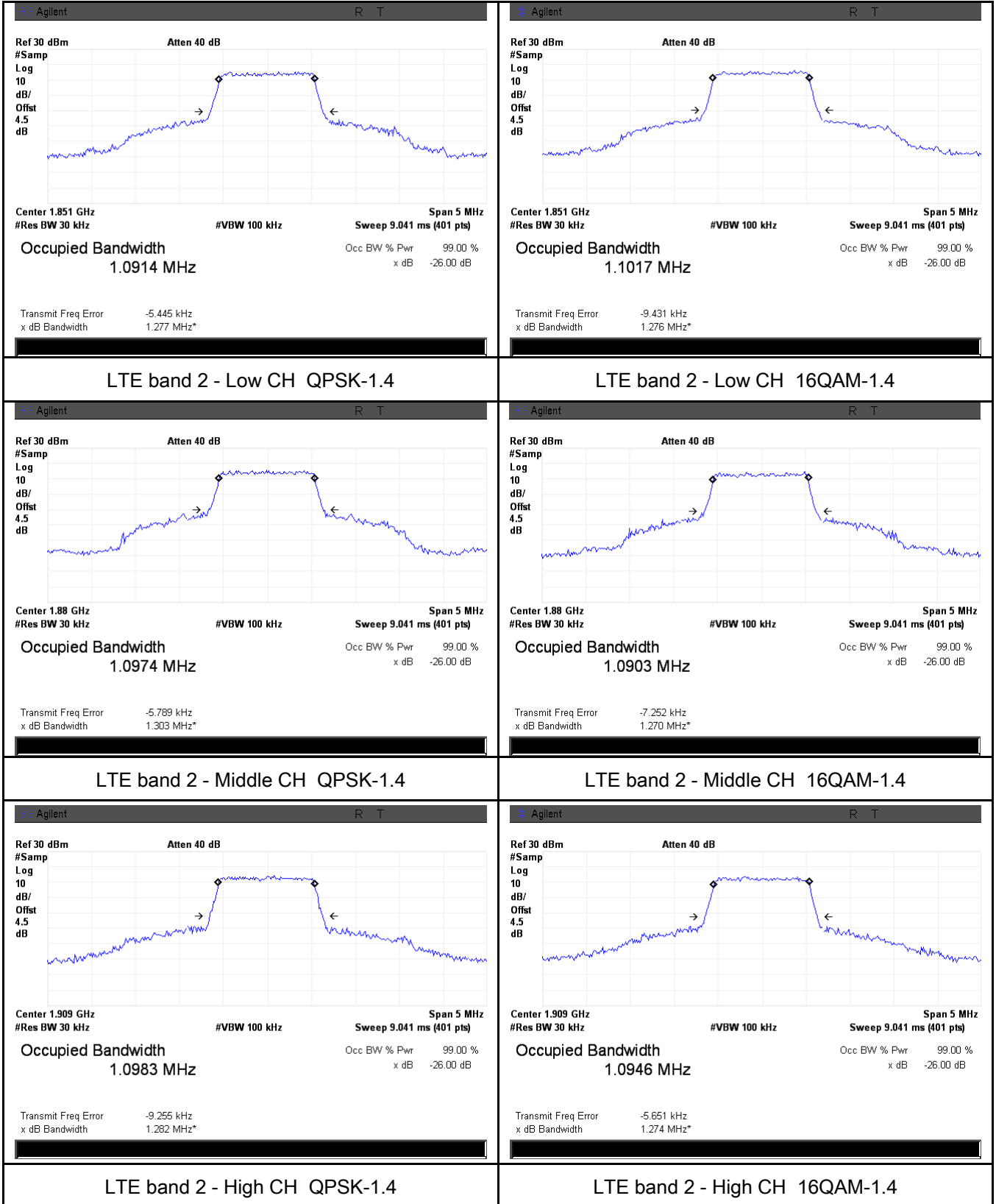

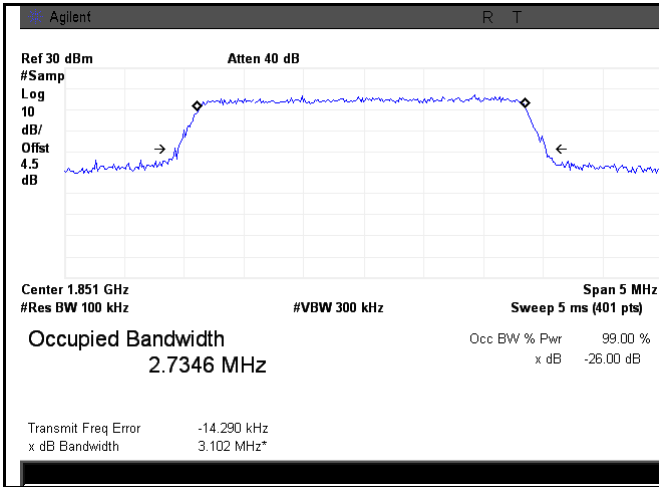

LTE band 2 - Low CH QPSK-3

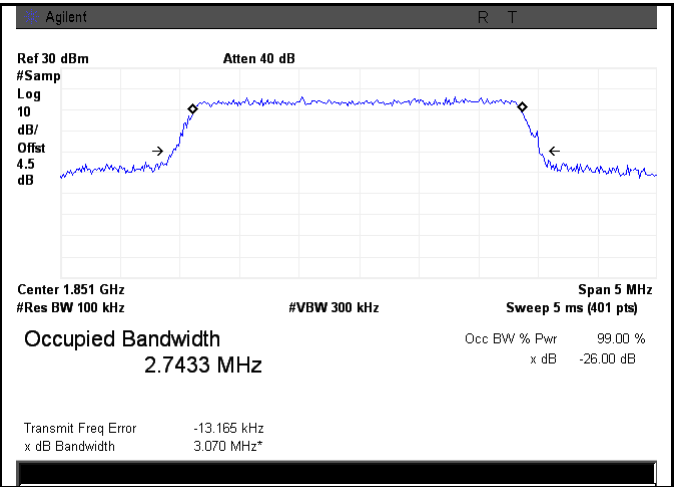

LTE band 2 - Low CH 16QAM-3

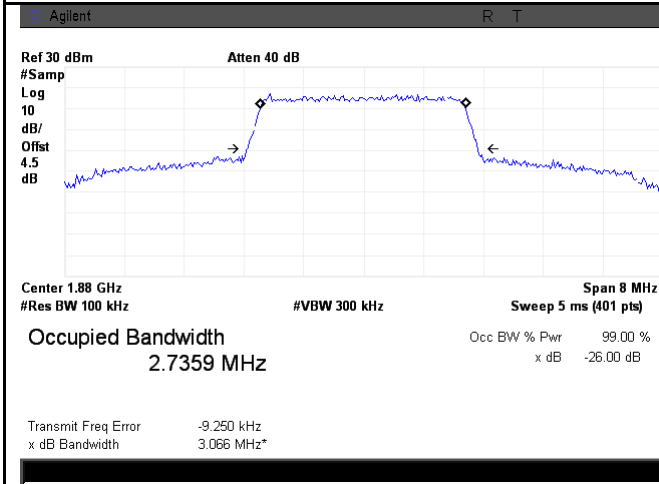

LTE band 2 - Middle CH QPSK-3

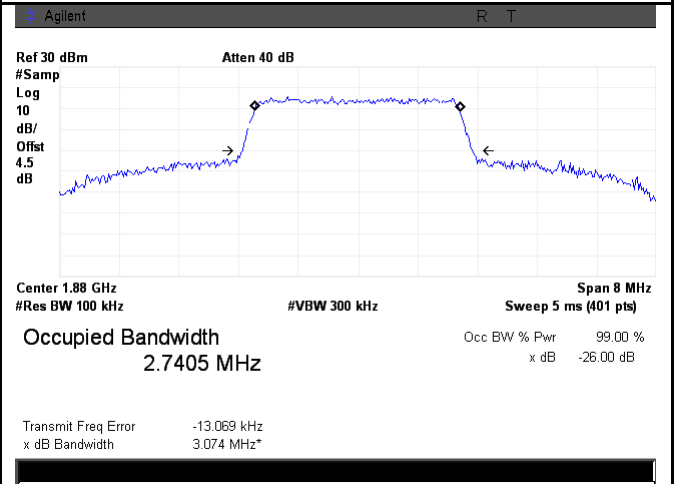

LTE band 2 - Middle CH 16QAM-3

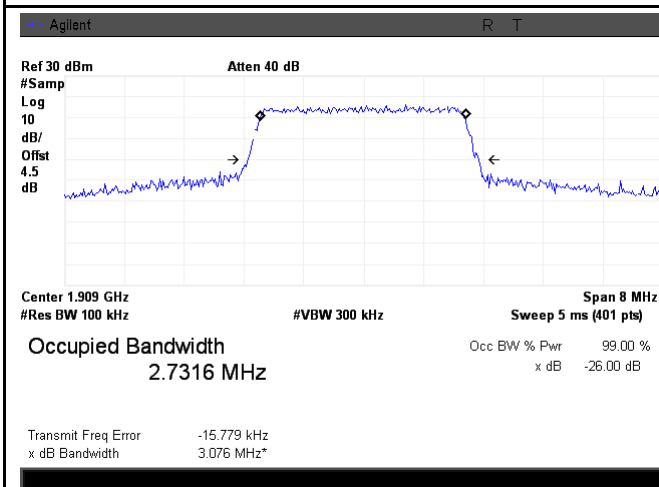

LTE band 2 - High CH QPSK-3

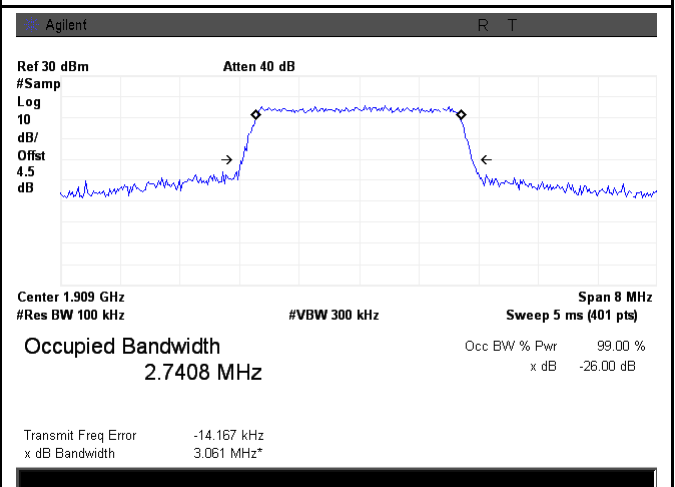

LTE band 2 - High CH 16QAM-3

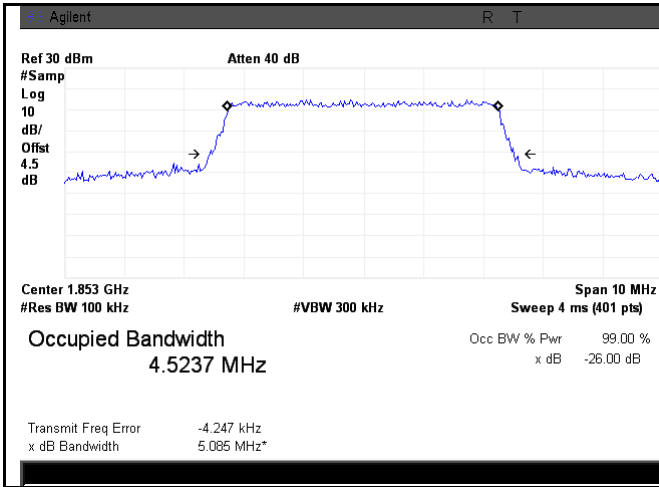

LTE band 2 - Low CH QPSK-5

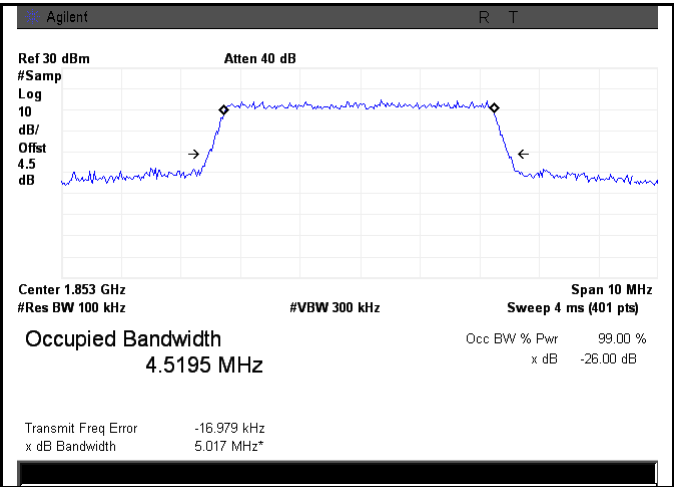

LTE band 2 - Low CH 16QAM-5

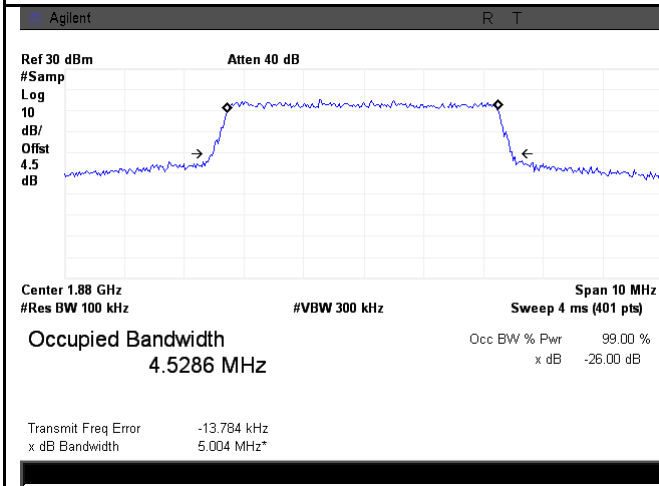

LTE band 2 - Middle CH QPSK-5

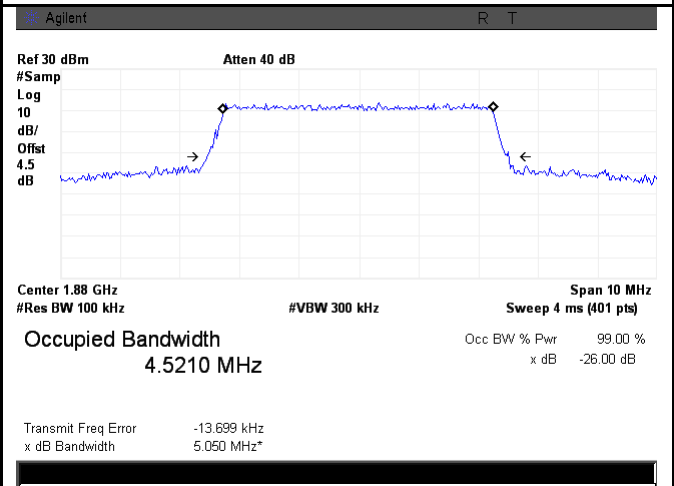

LTE band 2 - Middle CH 16QAM-5

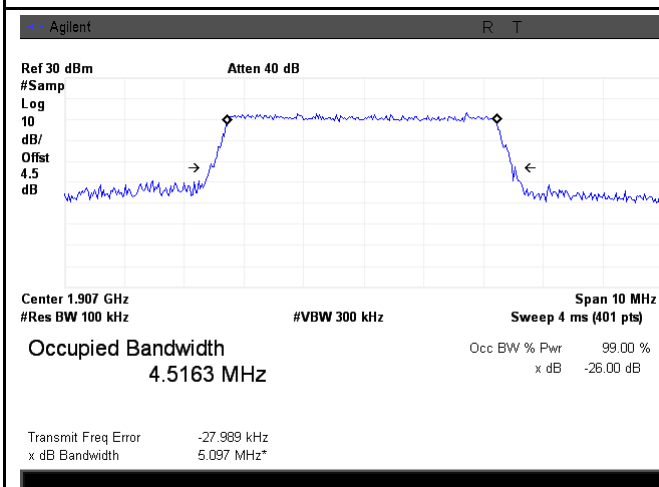

LTE band 2 - High CH QPSK-5

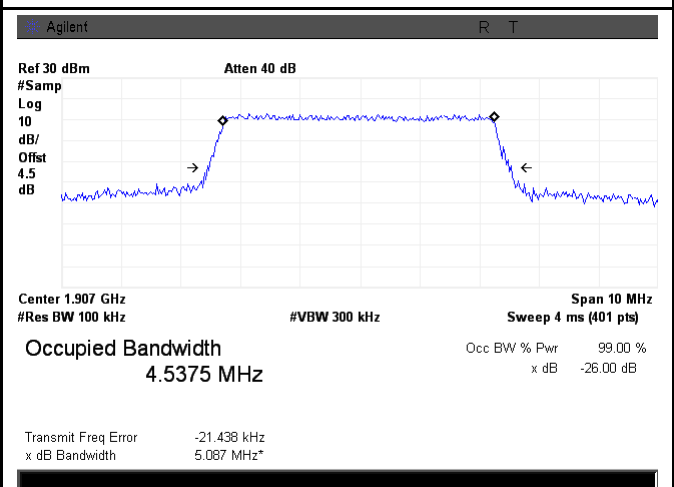

LTE band 2 - High CH 16QAM-5

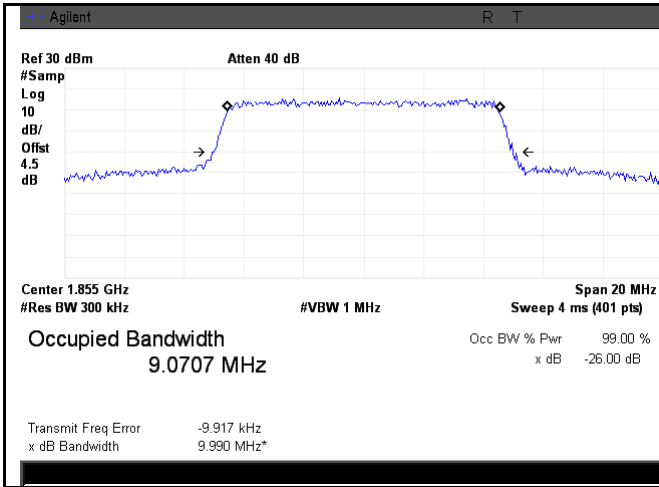

LTE band 2 - Low CH QPSK-10

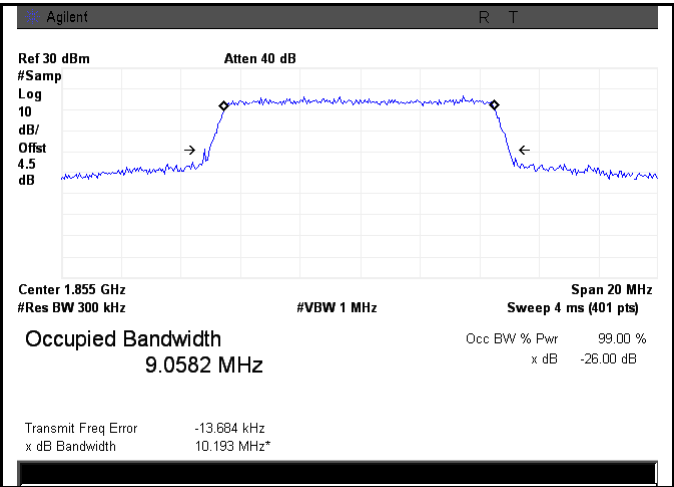

LTE band 2 - Low CH 16QAM-10

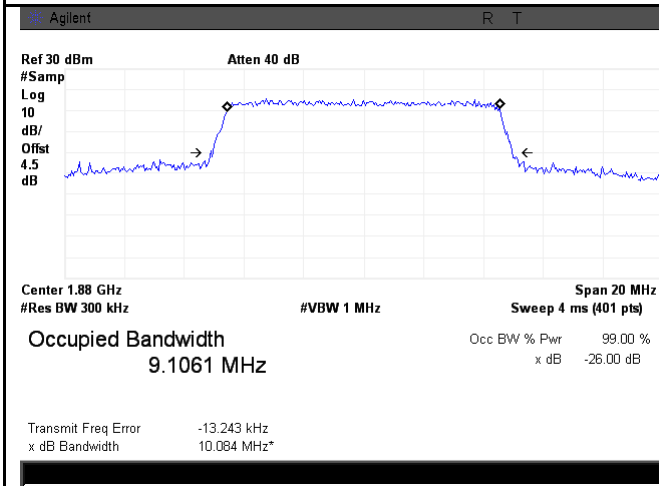

LTE band 2 - Middle CH QPSK-10

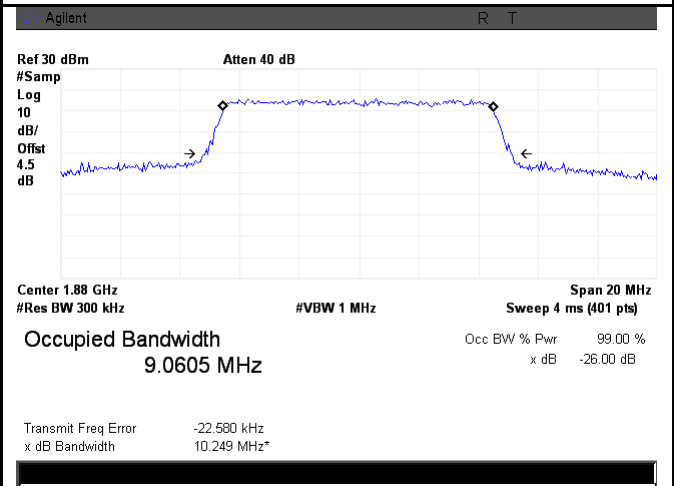

LTE band 2 - Middle CH 16QAM-10

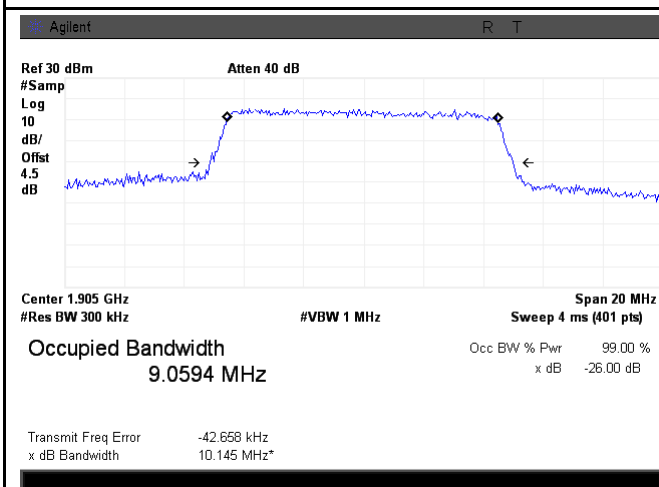

LTE band 2 - High CH QPSK-10

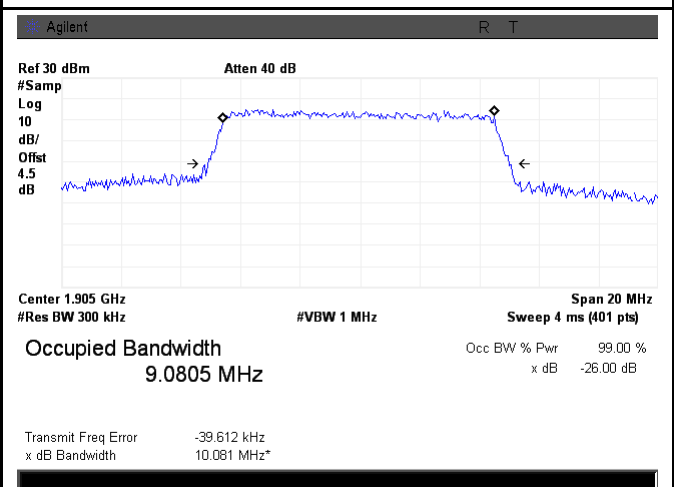

LTE band 2 - High CH 16QAM-10

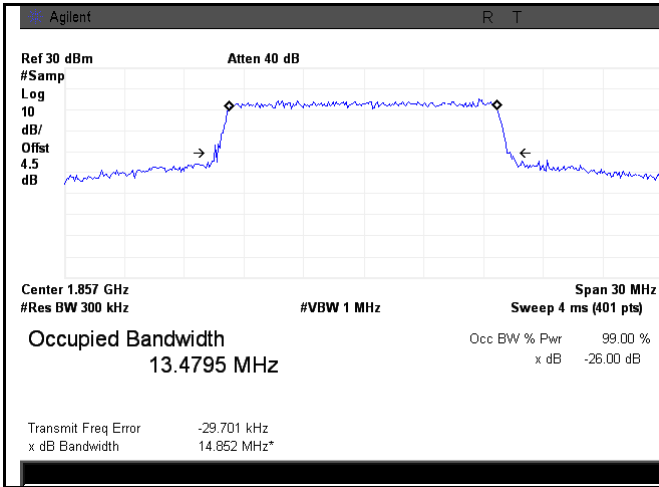

LTE band 2 - Low CH QPSK-15

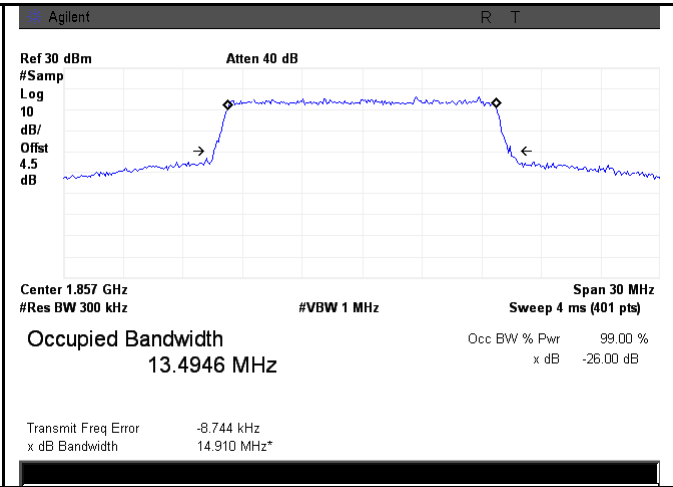

LTE band 2 - Low CH 16QAM-15

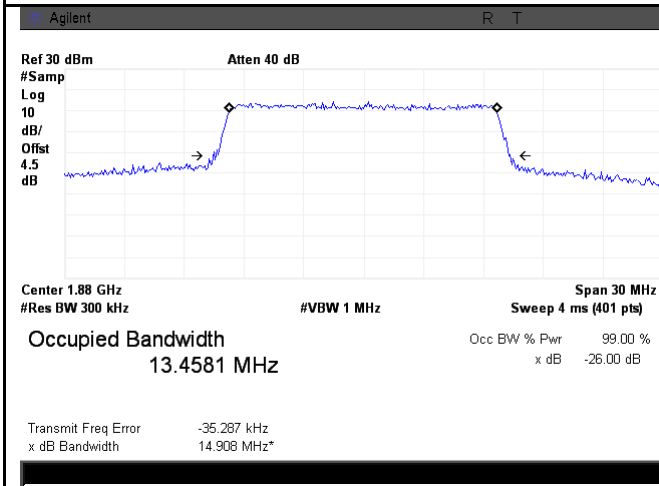

LTE band 2 - Middle CH QPSK-15

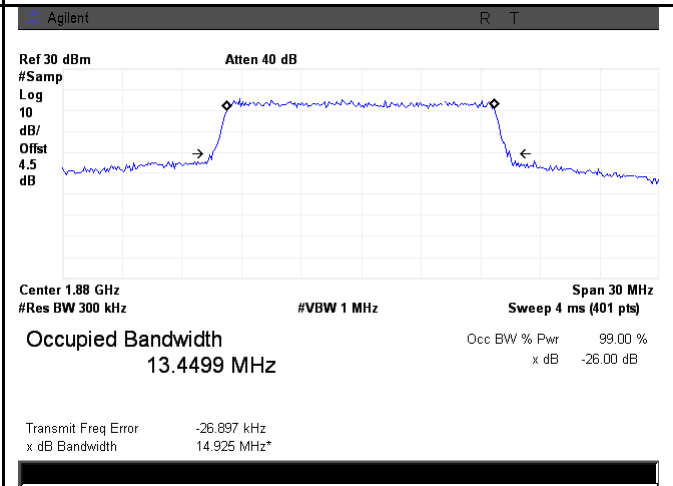

LTE band 2 - Middle CH 16QAM-15

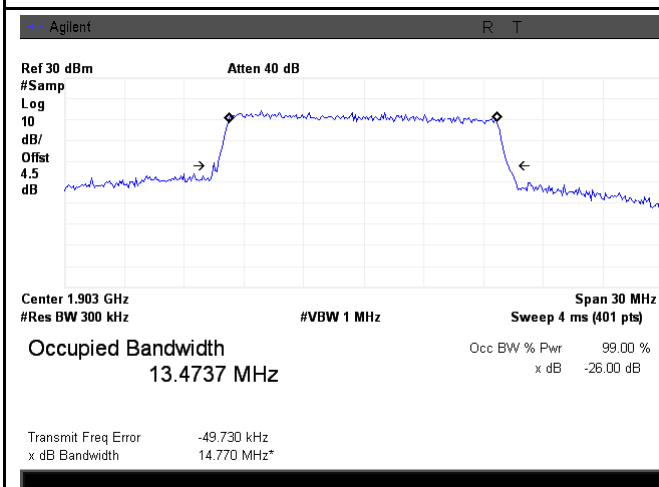

LTE band 2 - High CH QPSK-15

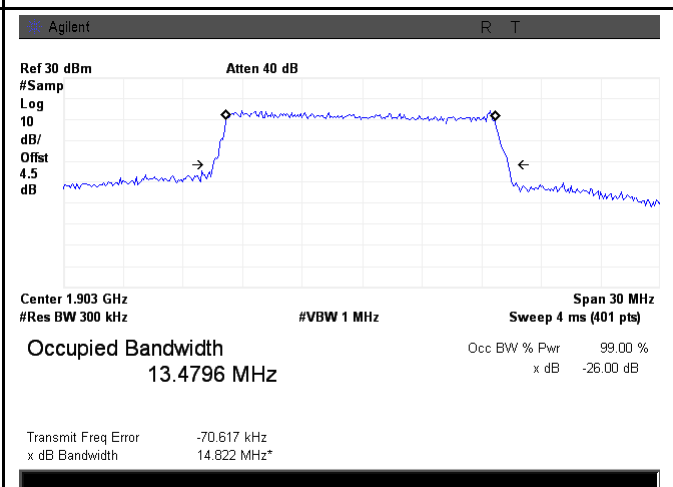

LTE band 2 - High CH 16QAM-15

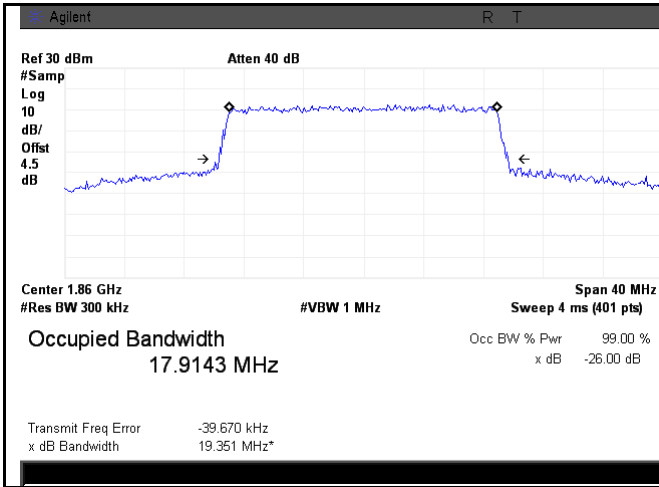

LTE band 2 - Low CH QPSK-20

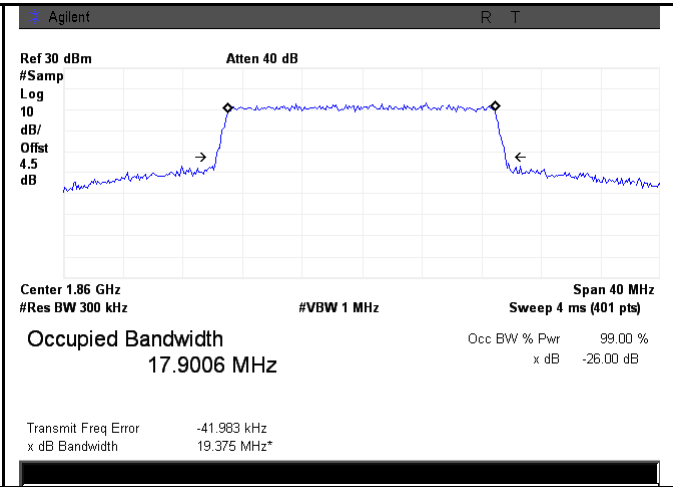

LTE band 2 - Low CH 16QAM-20

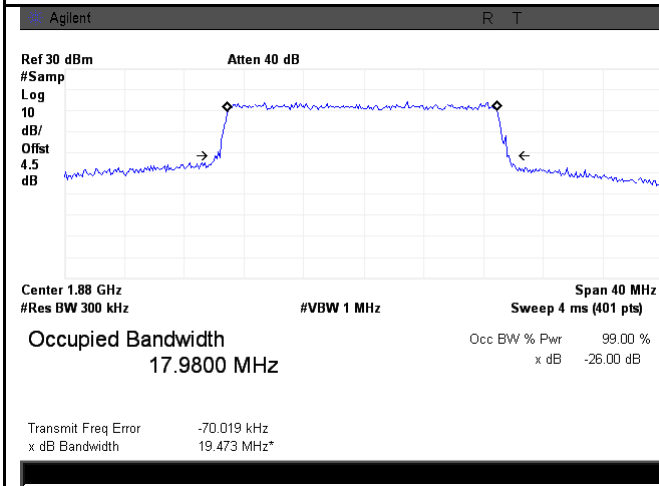

LTE band 2 - Middle CH QPSK-20

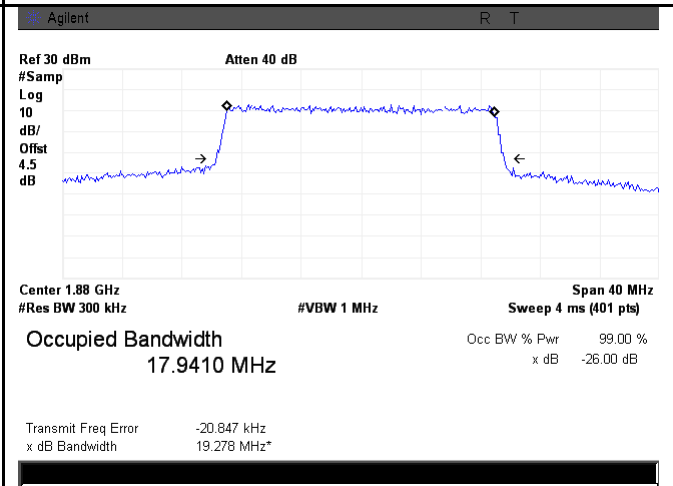

LTE band 2 - Middle CH 16QAM-20

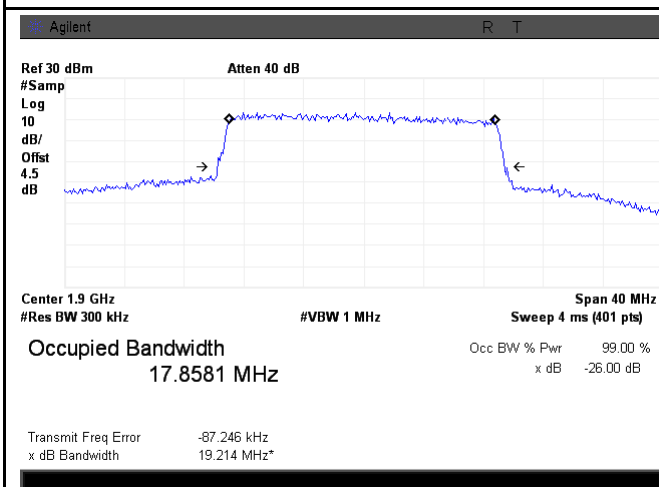

LTE band 2 - High CH QPSK-20

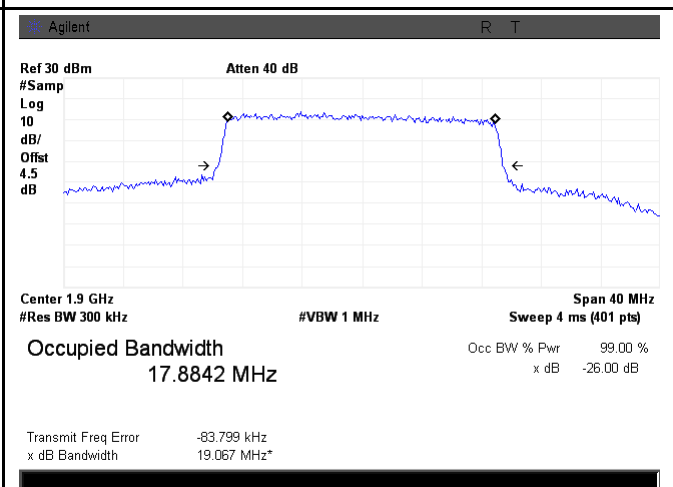

LTE band 2 - High CH 16QAM-20

LTE Band 4 (Part 27)

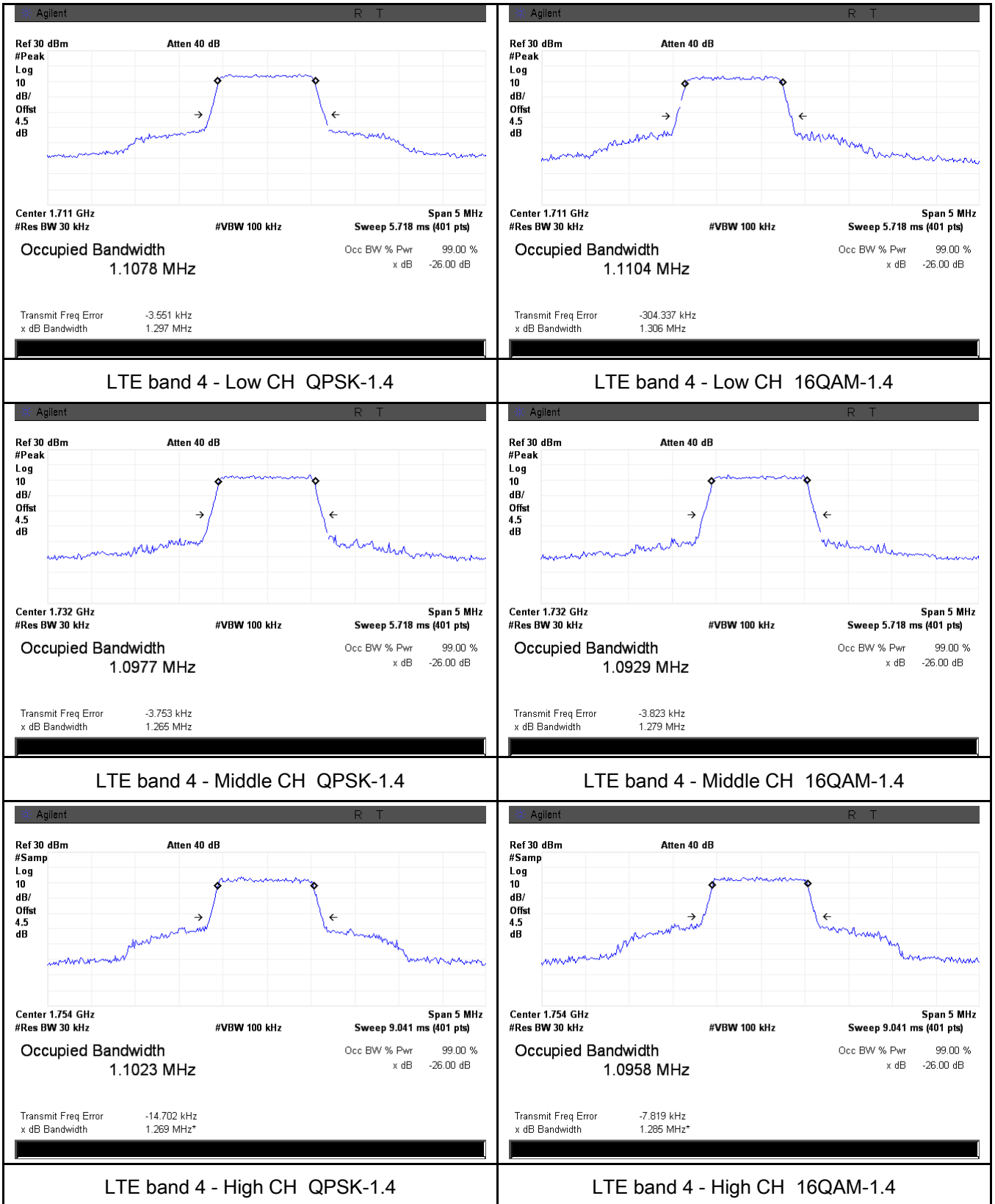

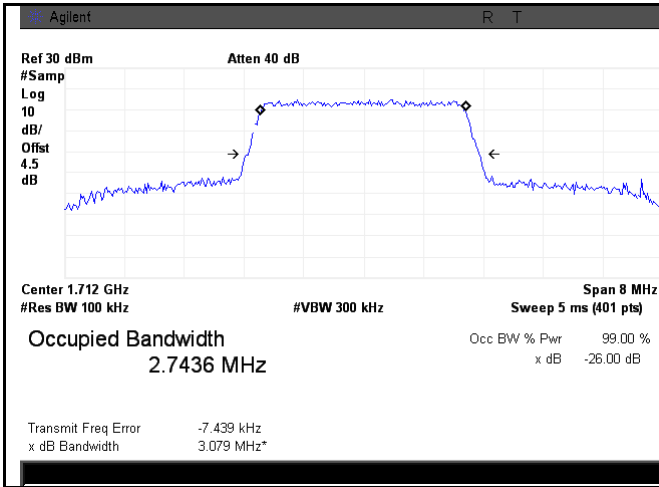

LTE band 4 - Low CH QPSK-3

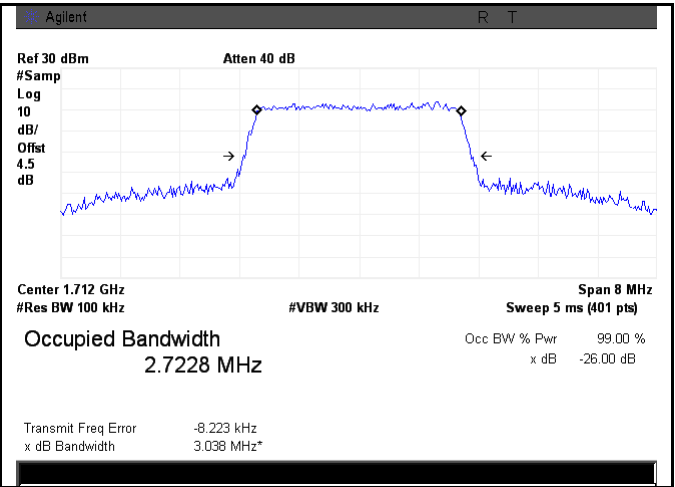

LTE band 4 - Low CH 16QAM-3

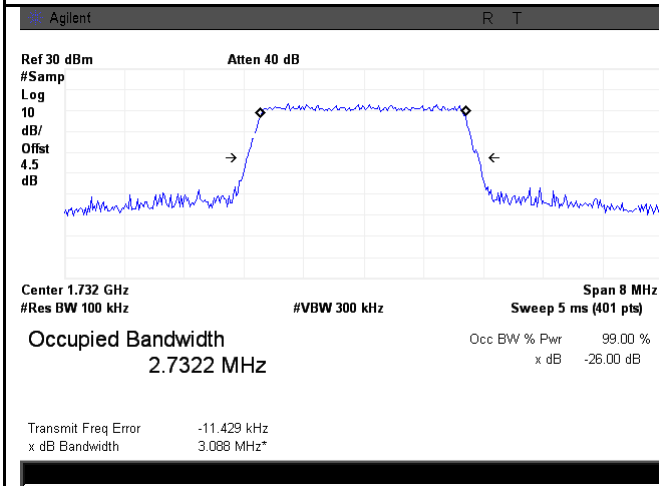

LTE band 4 - Middle CH QPSK-3

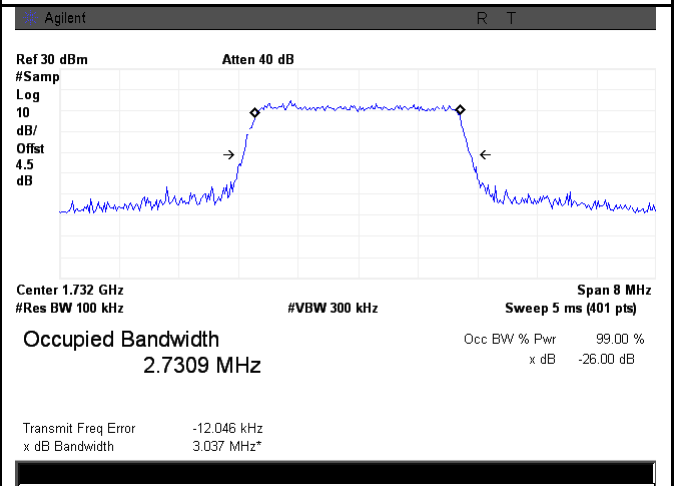

LTE band 4 - Middle CH 16QAM-3

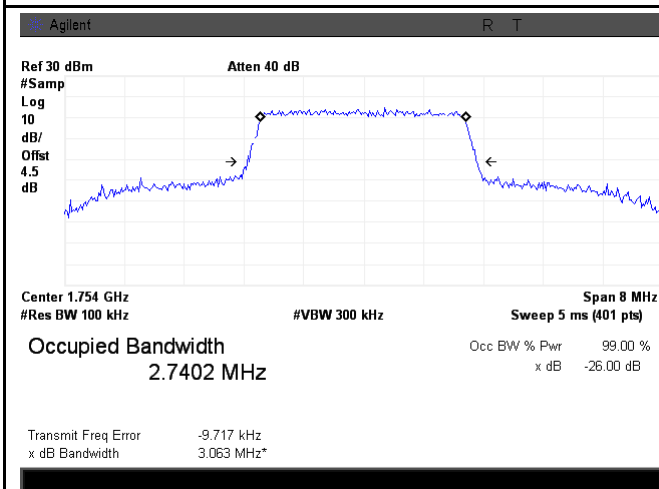

LTE band 4 - High CH QPSK-3

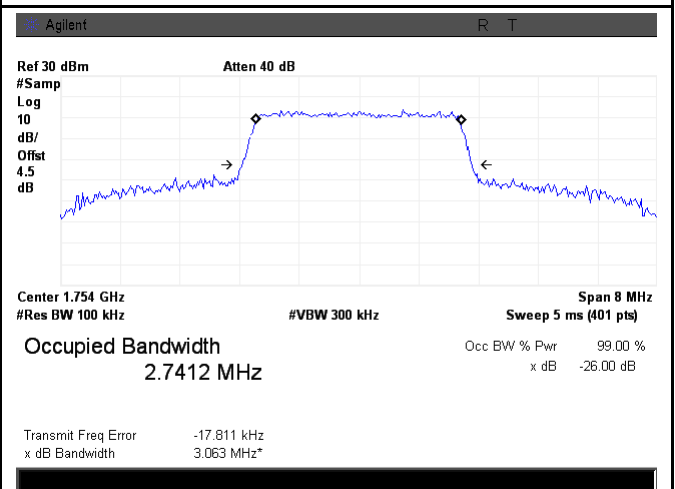

LTE band 4 - High CH 16QAM-3

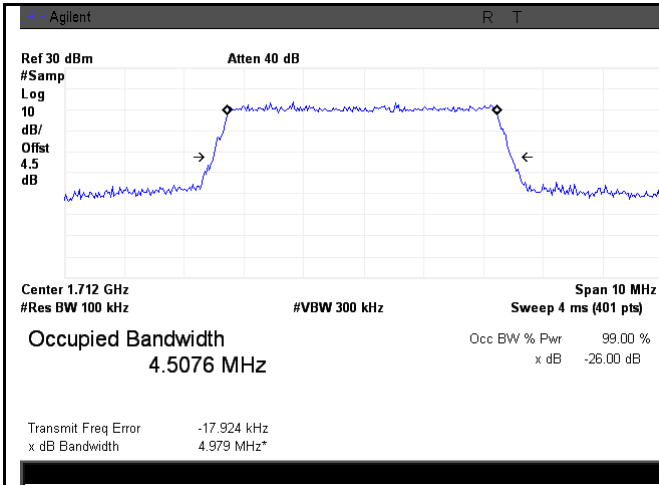

LTE band 4 - Low CH QPSK-5

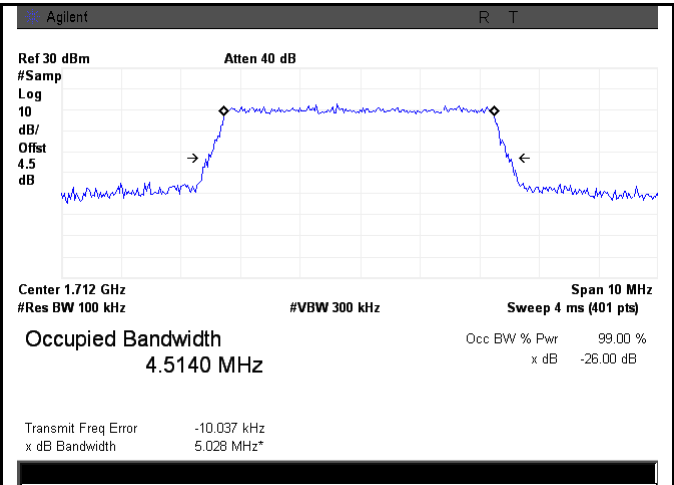

LTE band 4 - Low CH 16QAM-5

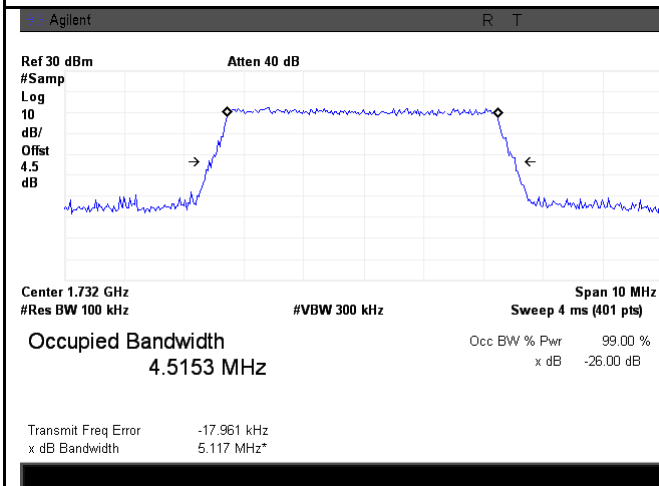

LTE band 4 - Middle CH QPSK-5

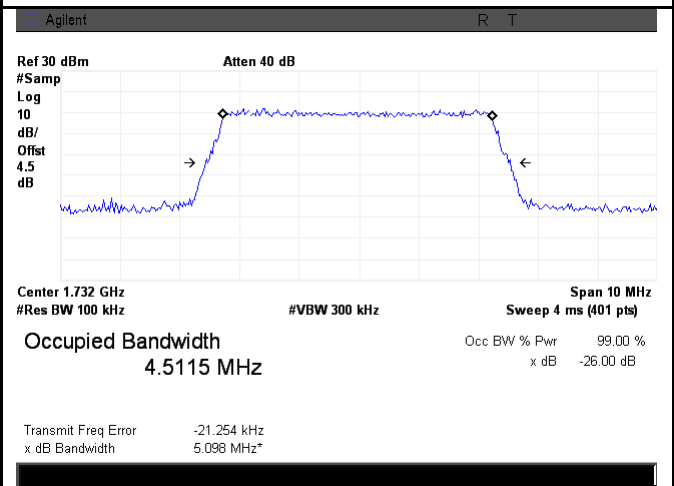

LTE band 4 - Middle CH 16QAM-5

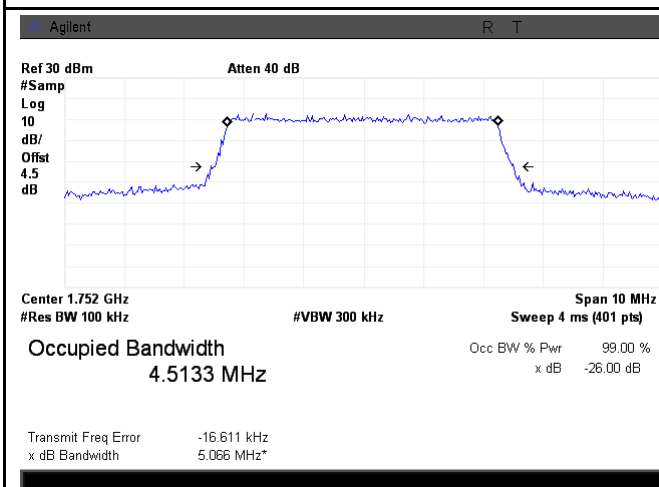

LTE band 4 - High CH QPSK-5

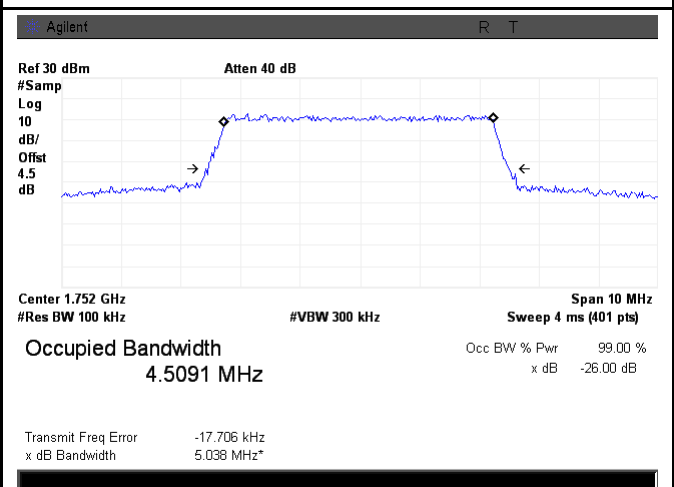

LTE band 4 - High CH 16QAM-5

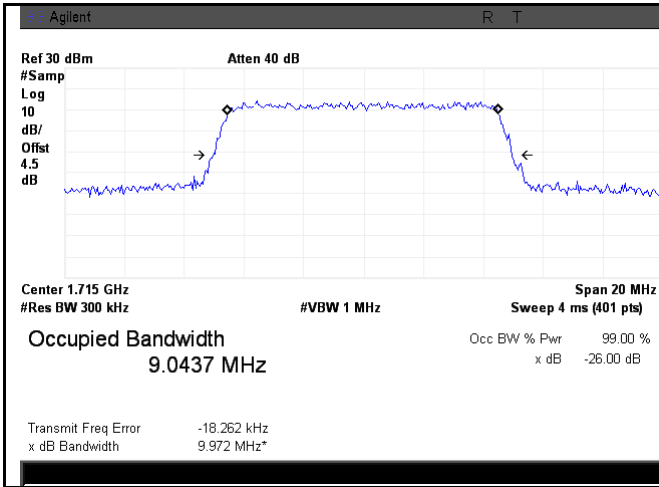

LTE band 4 - Low CH QPSK-10

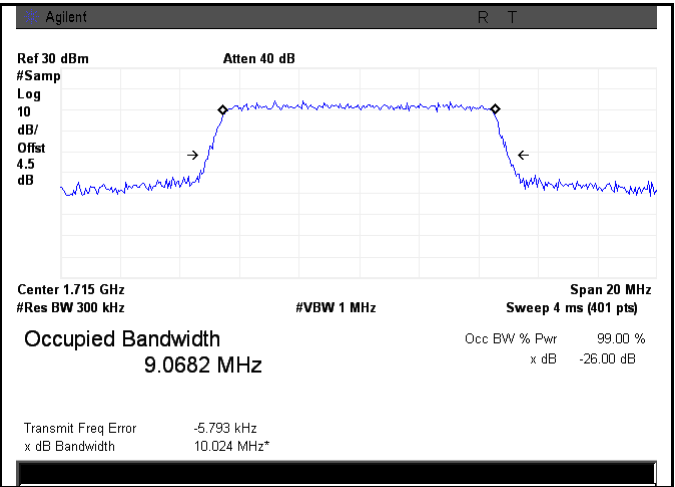

LTE band 4 - Low CH 16QAM-10

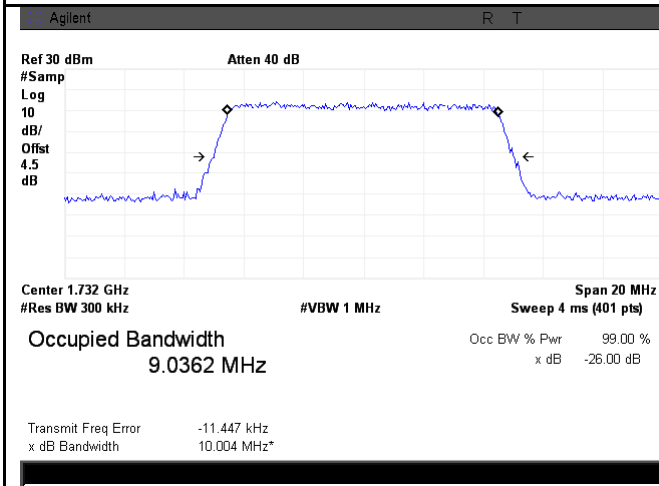

LTE band 4 - Middle CH QPSK-10

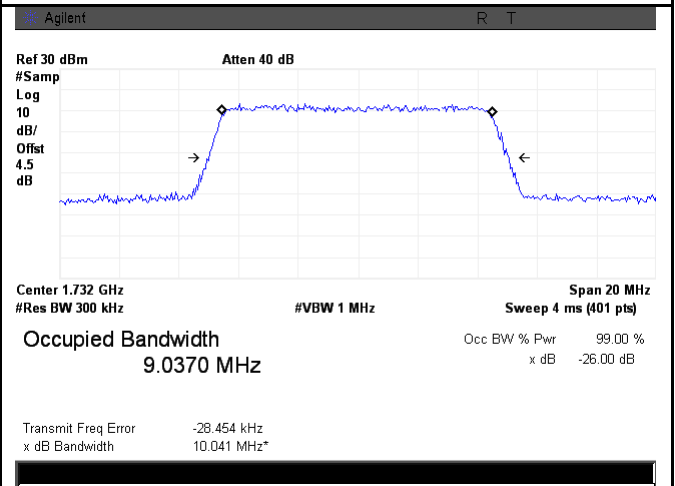

LTE band 4 - Middle CH 16QAM-10

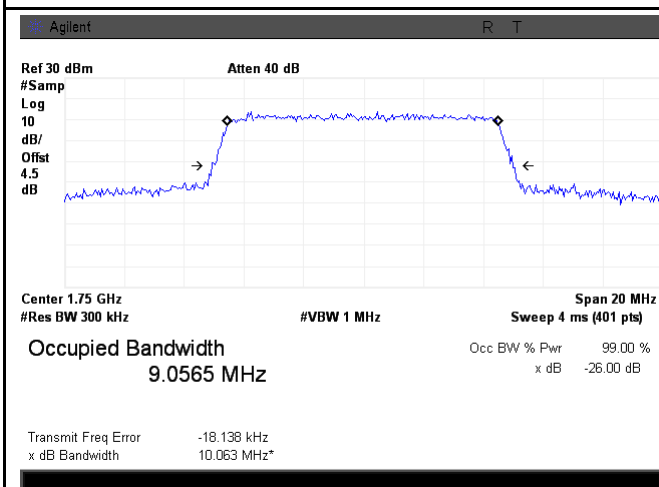

LTE band 4 - High CH QPSK-10

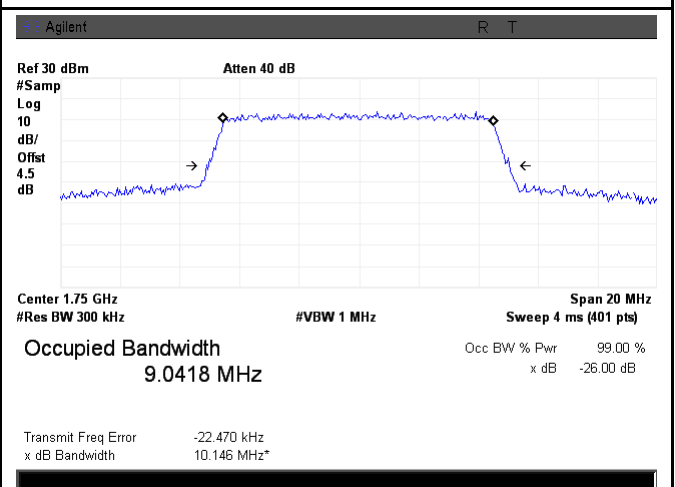

LTE band 4 - High CH 16QAM-10

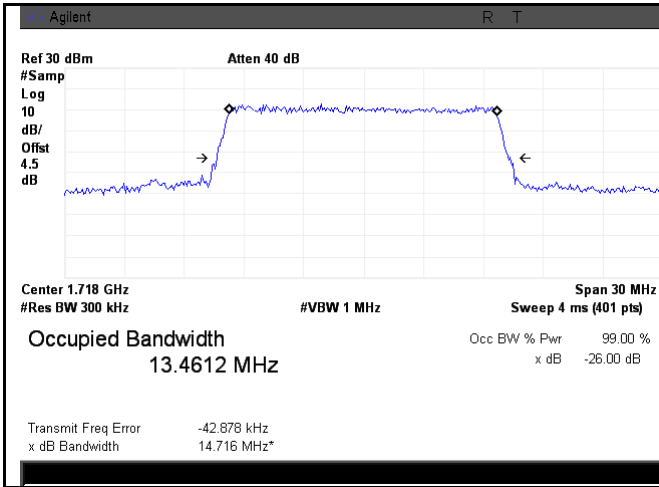

LTE band 4 - Low CH QPSK-15

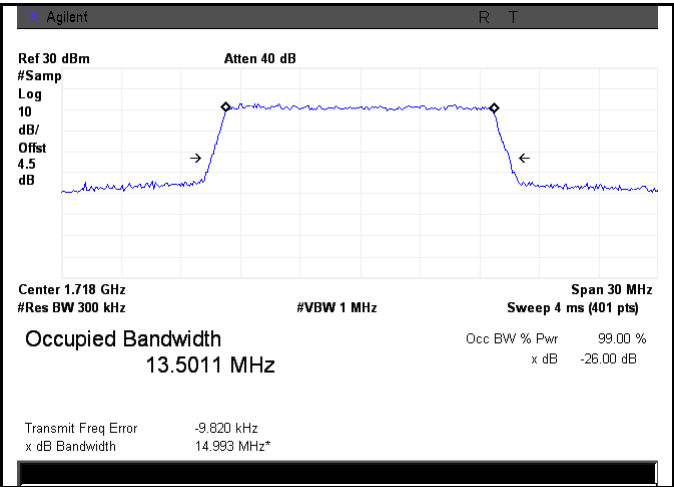

LTE band 4 - Low CH 16QAM-15

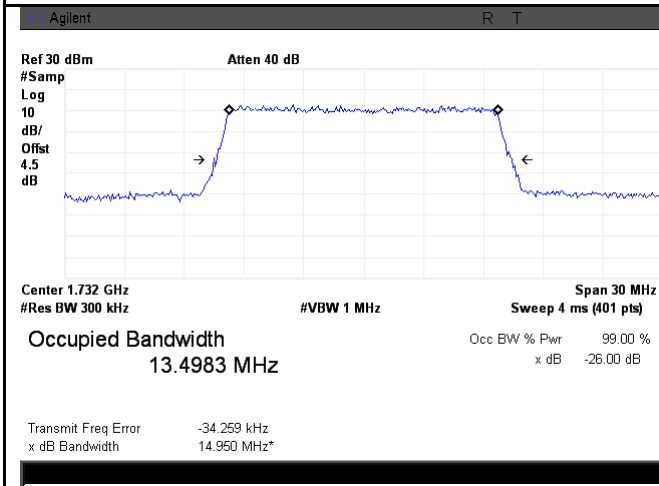

LTE band 4 - Middle CH QPSK-15

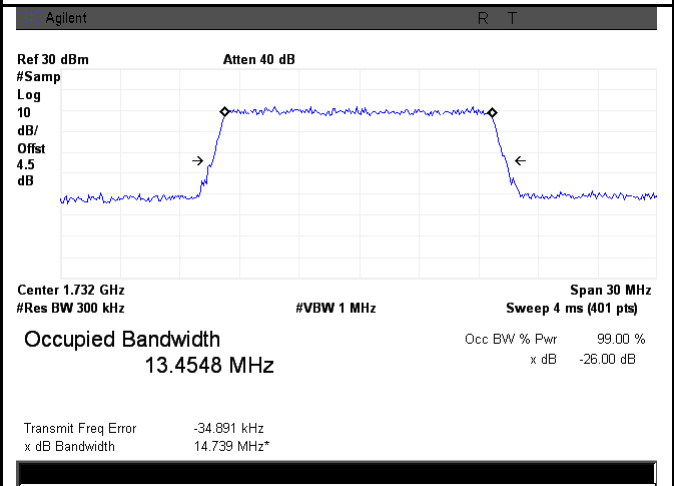

LTE band 4 - Middle CH 16QAM-15

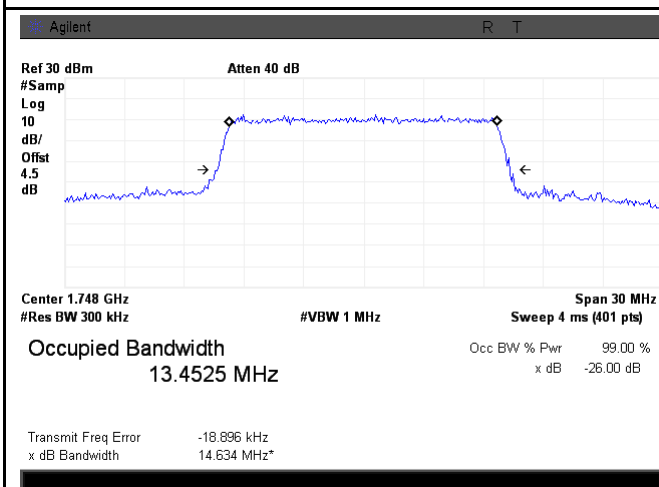

LTE band 4 - High CH QPSK-15

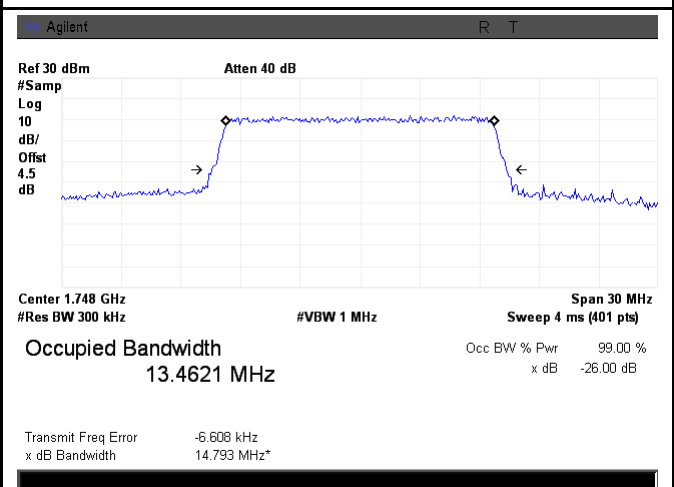

LTE band 4 - High CH 16QAM-15

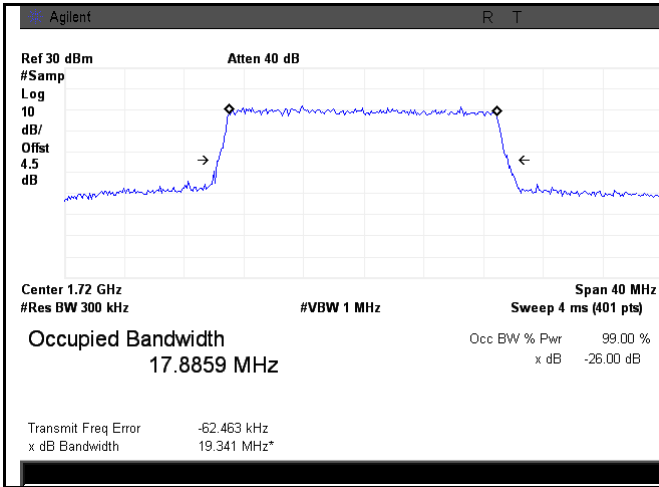

LTE band 4 - Low CH QPSK-20

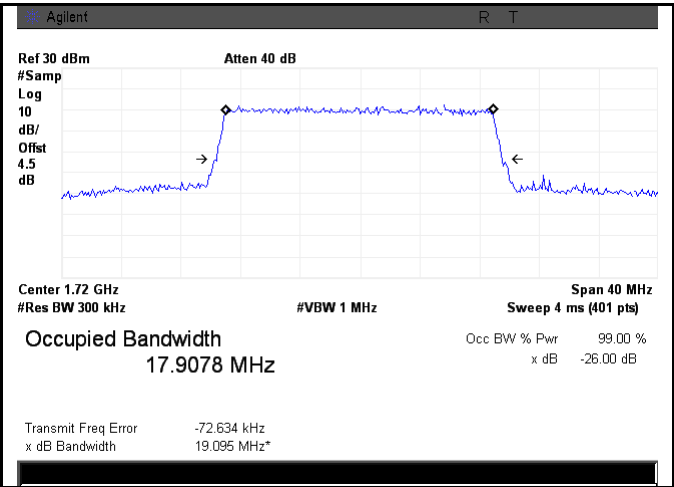

LTE band 4 - Low CH 16QAM-20

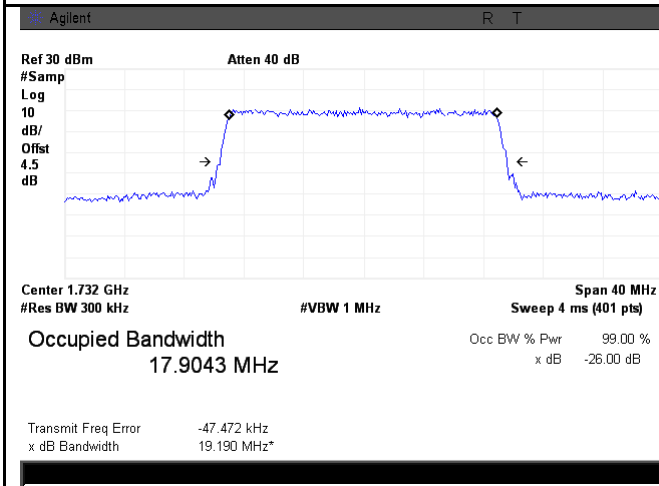

LTE band 4 - Middle CH QPSK-20

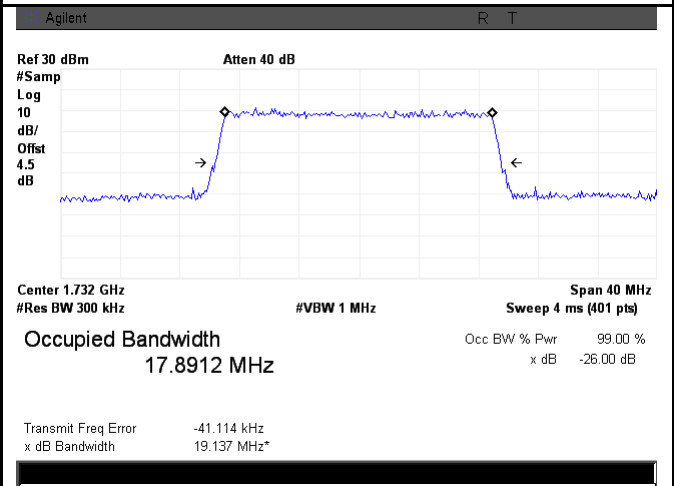

LTE band 4 - Middle CH 16QAM-20

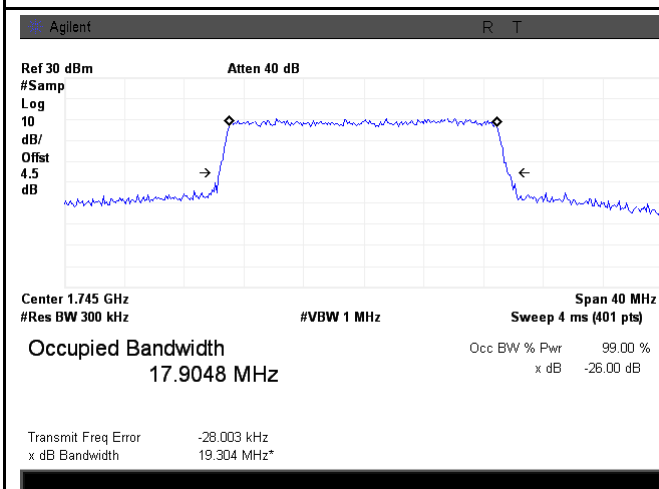

LTE band 4 - High CH QPSK-20

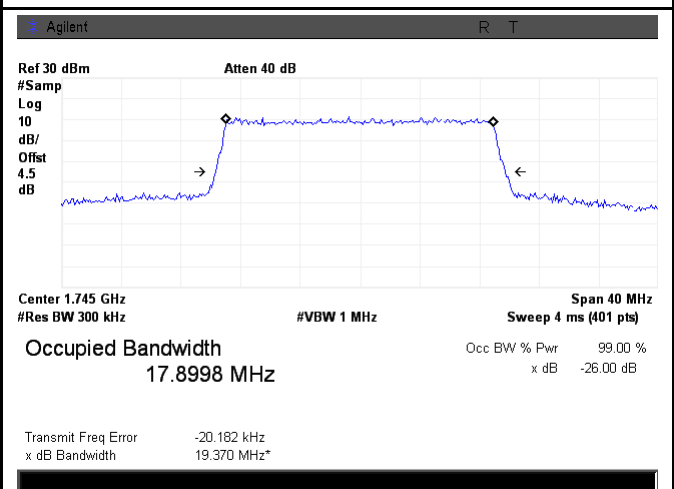

LTE band 4 - High CH 16QAM-20

LTE Band 5 (Part 22H)

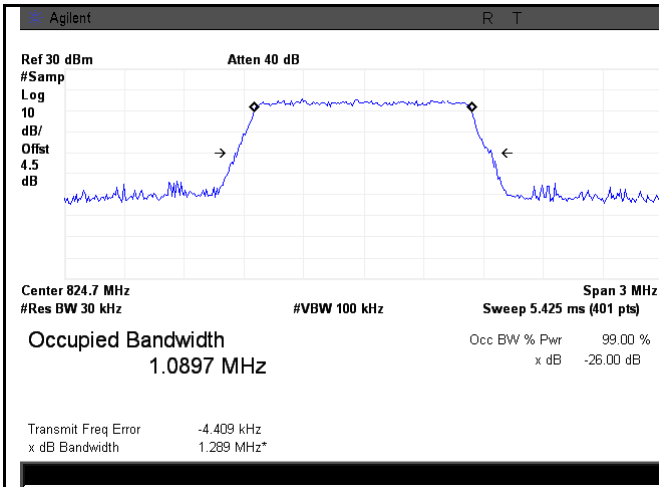

LTE band 5 - Low CH QPSK-1.4

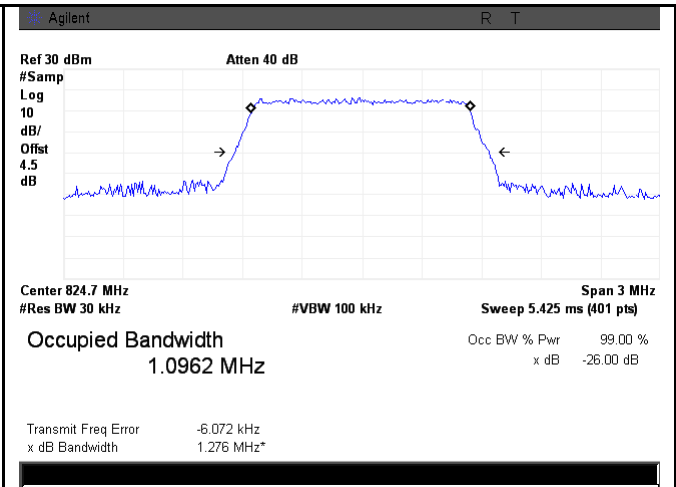

LTE band 5 - Low CH 16QAM-1.4

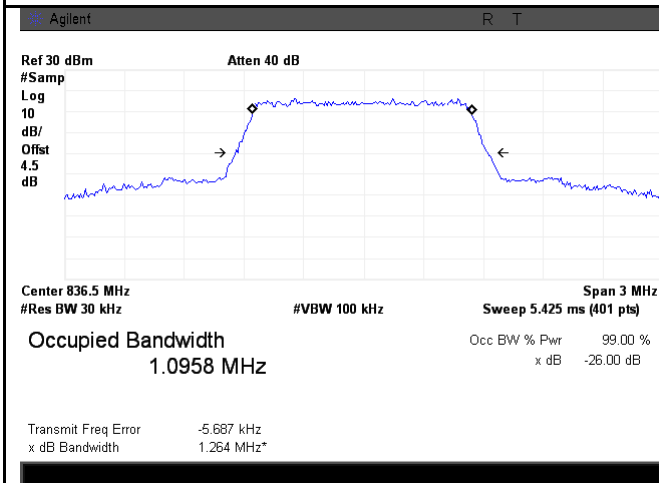

LTE band 5 - Middle CH QPSK-1.4

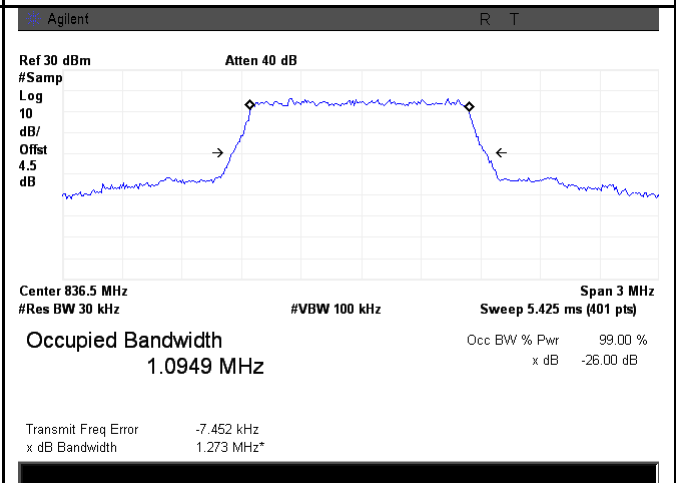

LTE band 5 - Middle CH 16QAM-1.4

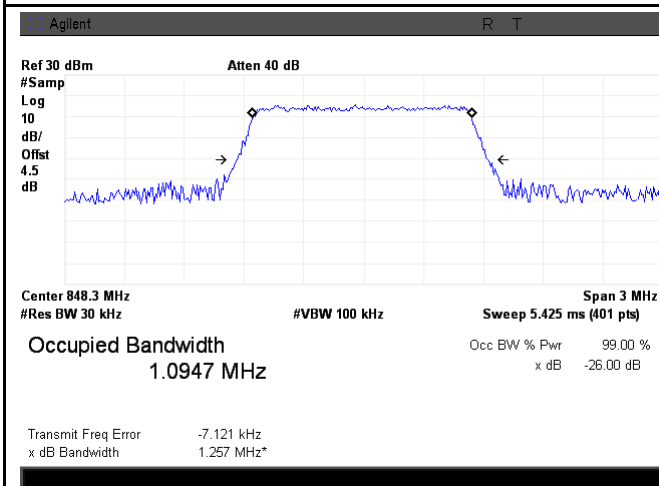

LTE band 5 - High CH QPSK-1.4

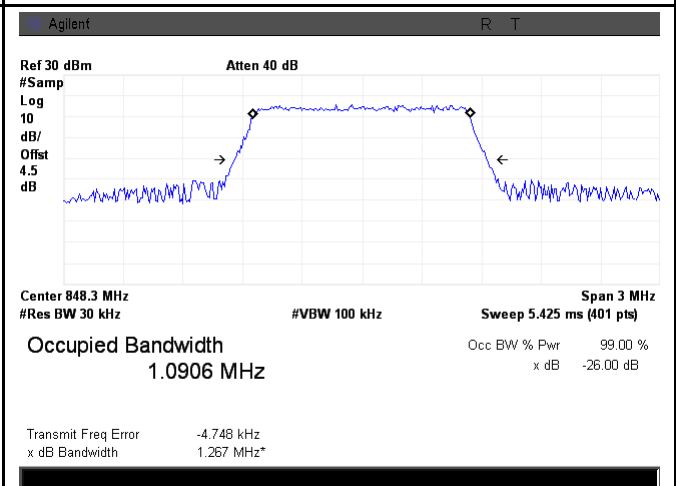

LTE band 5 - High CH 16QAM-1.4

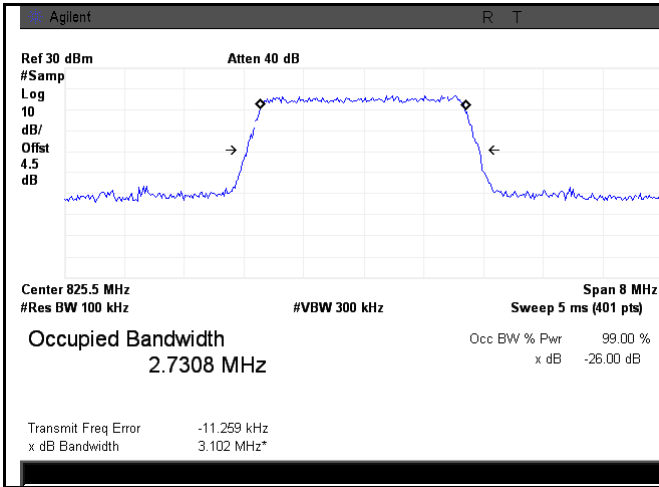

LTE band 5 - Low CH QPSK-3

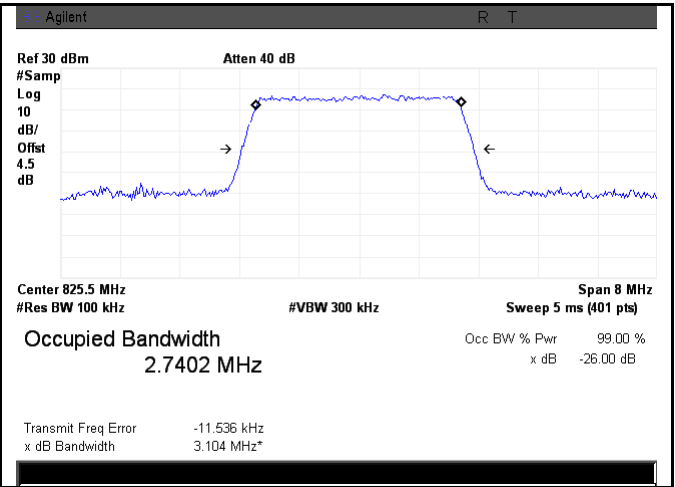

LTE band 5 - Low CH 16QAM-3

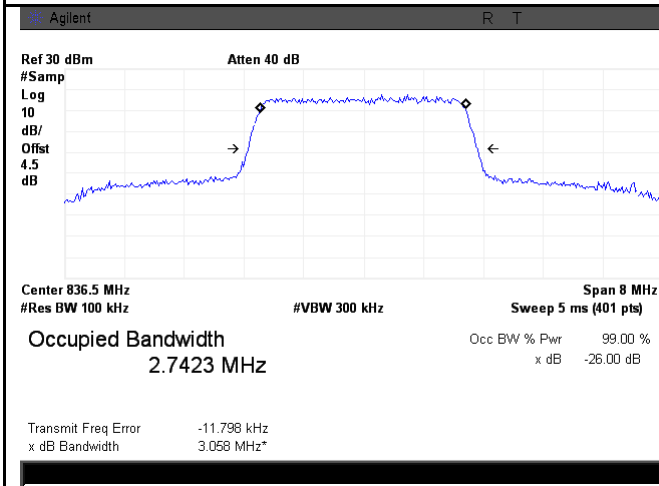

LTE band 5 - Middle CH QPSK-3

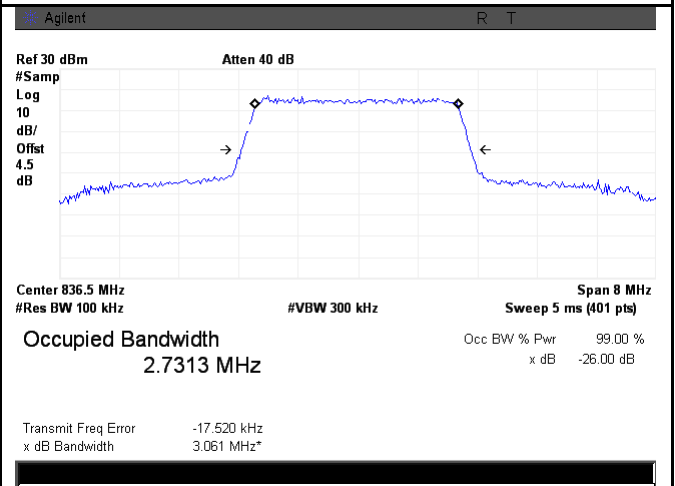

LTE band 5 - Middle CH 16QAM-3

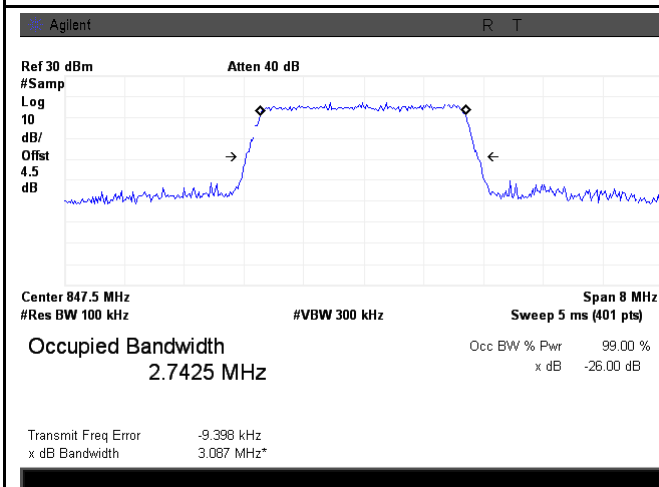

LTE band 5 - High CH QPSK-3

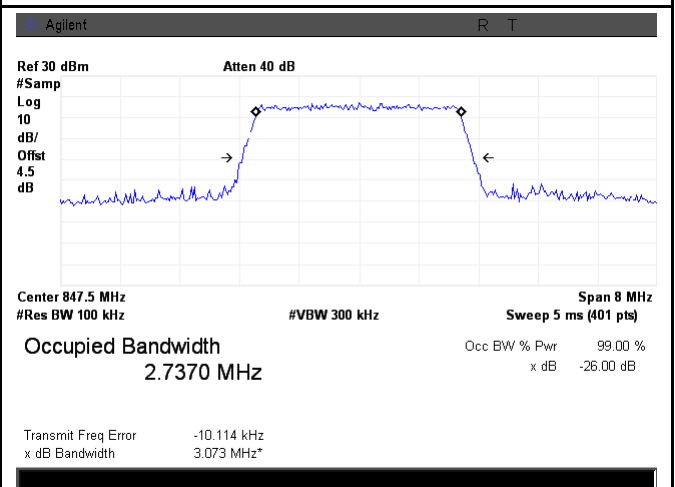

LTE band 5 - High CH 16QAM-3

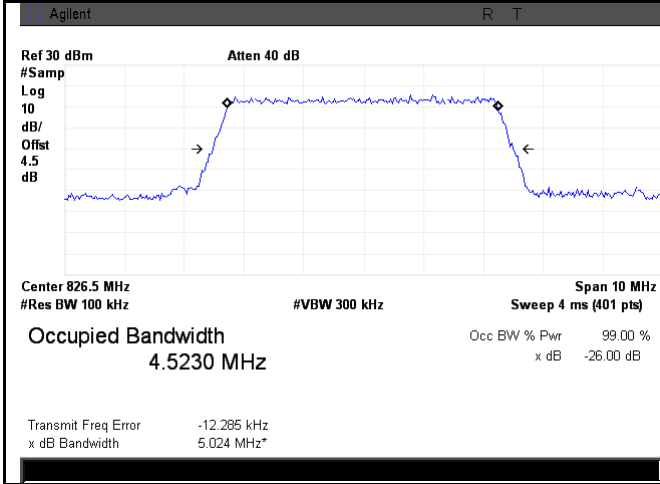

LTE band 5 - Low CH QPSK-5

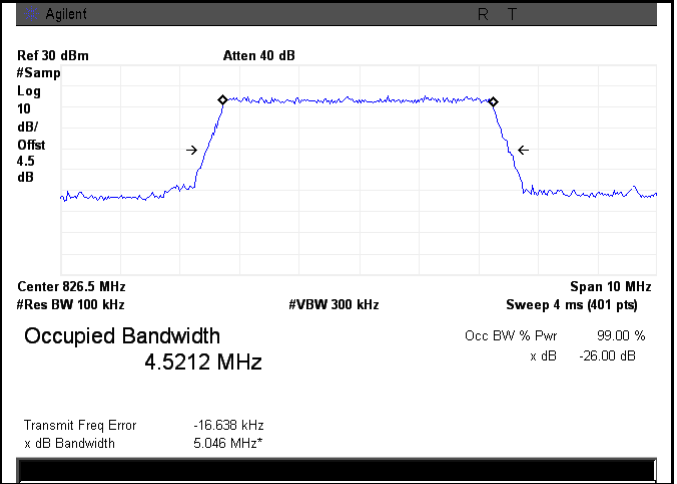

LTE band 5 - Low CH 16QAM-5

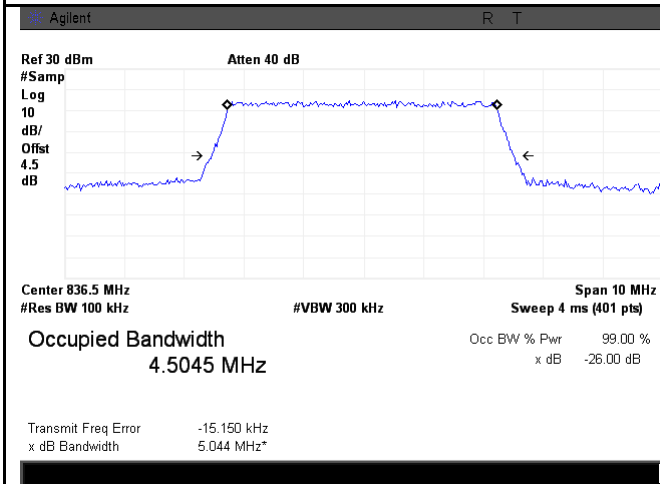

LTE band 5 - Middle CH QPSK-5

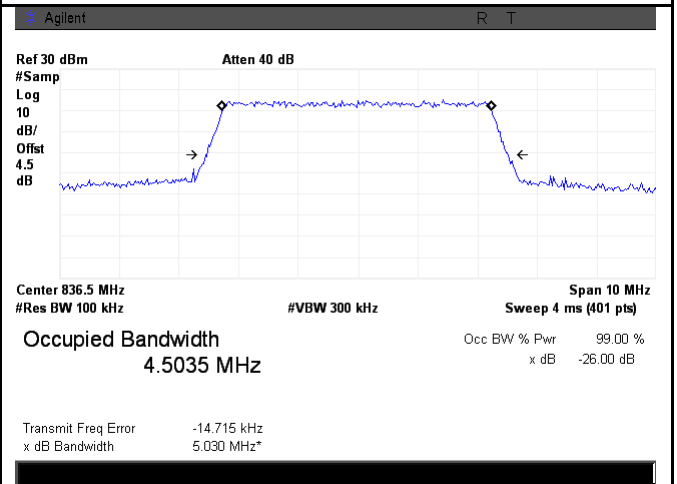

LTE band 5 - Middle CH 16QAM-5

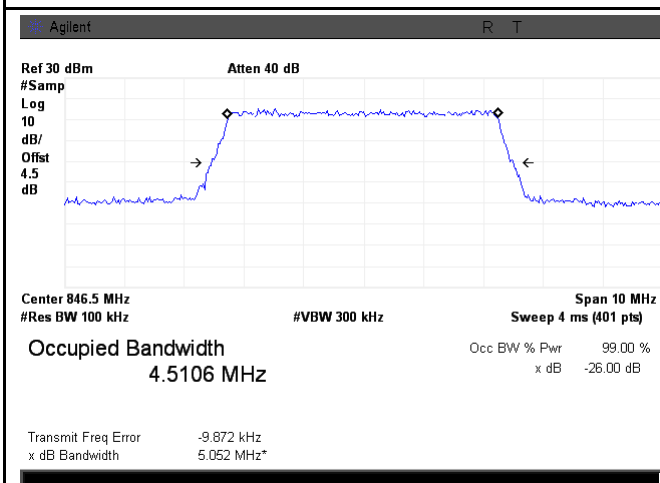

LTE band 5 - High CH QPSK-5

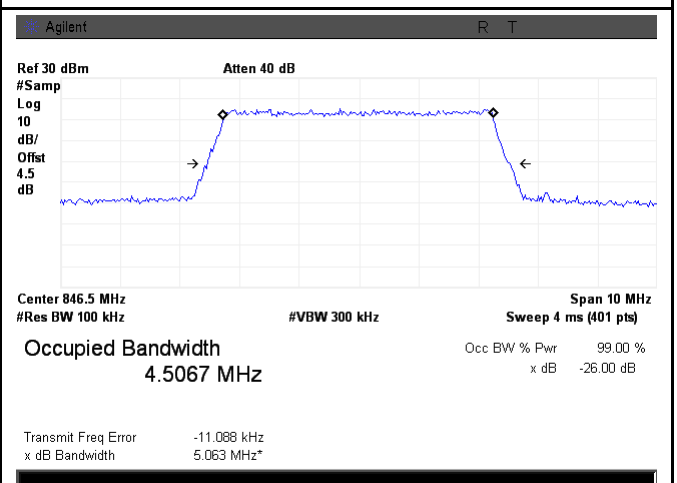

LTE band 5 - High CH 16QAM-5

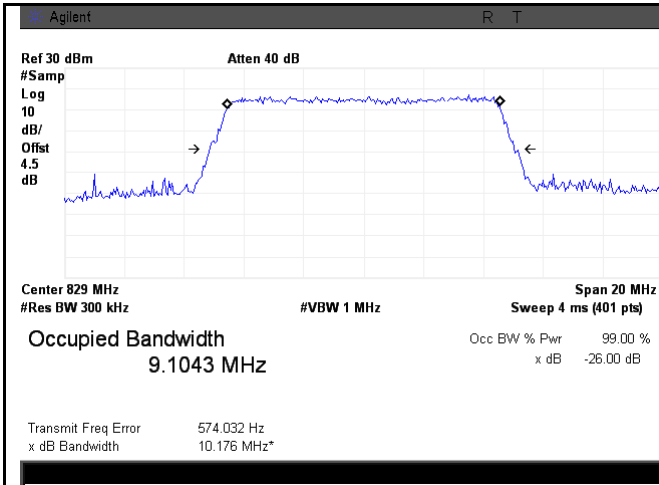

LTE band 5 - Low CH QPSK-10

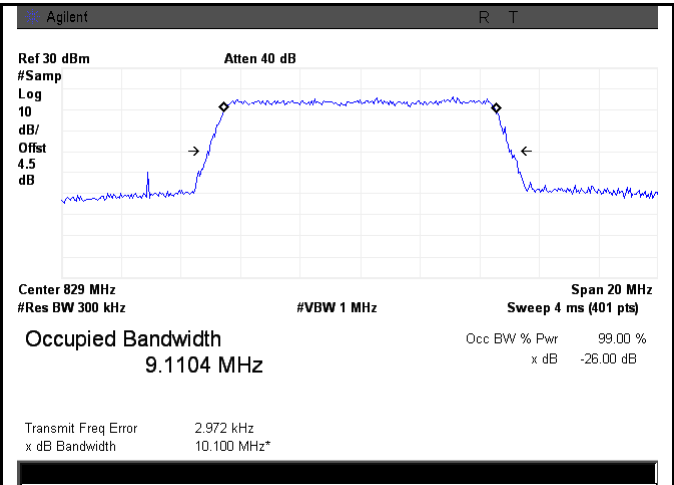

LTE band 5 - Low CH 16QAM-10

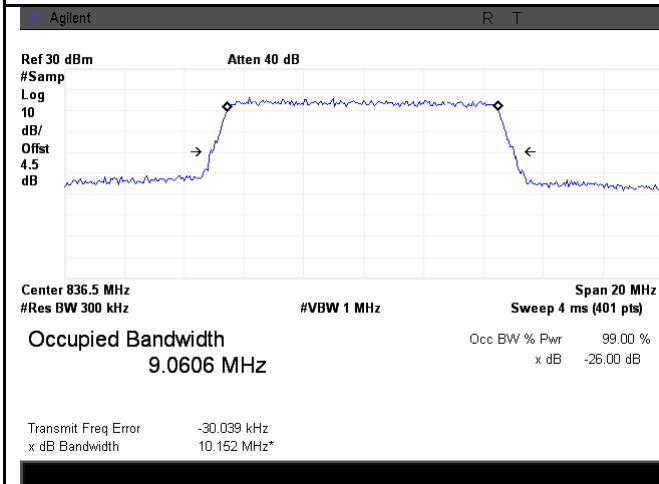

LTE band 5 - Middle CH QPSK-10

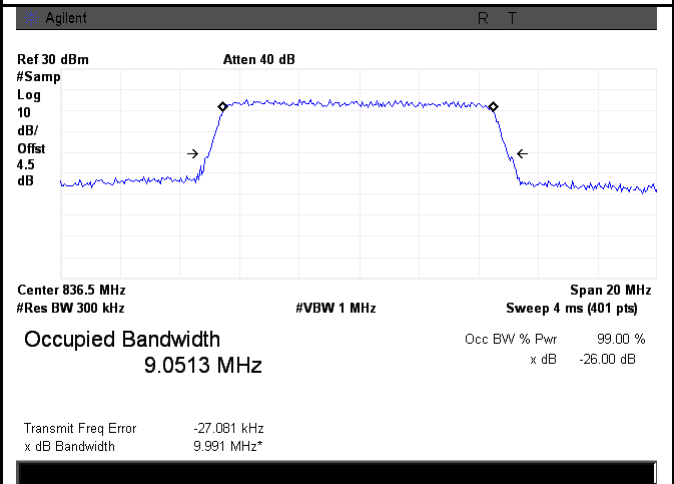

LTE band 5 - Middle CH 16QAM-10

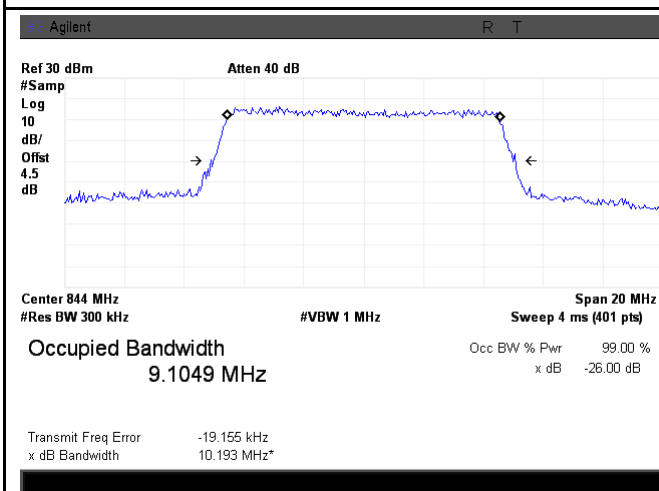

LTE band 5 - High CH QPSK-10

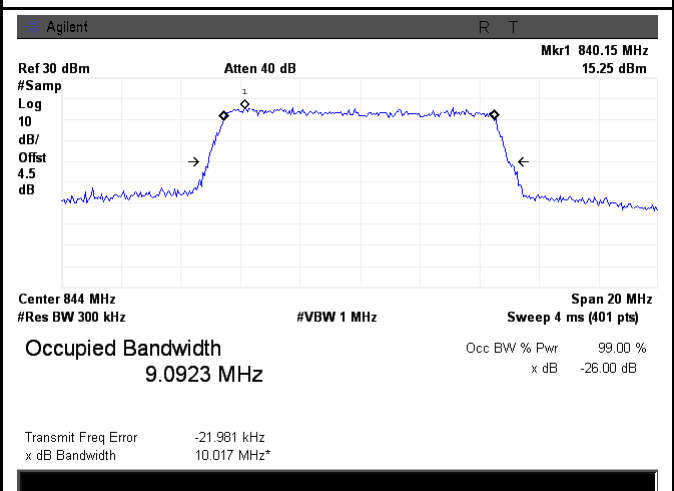

LTE band 5 - High CH 16QAM-10

LTE Band 12 (Part 27)

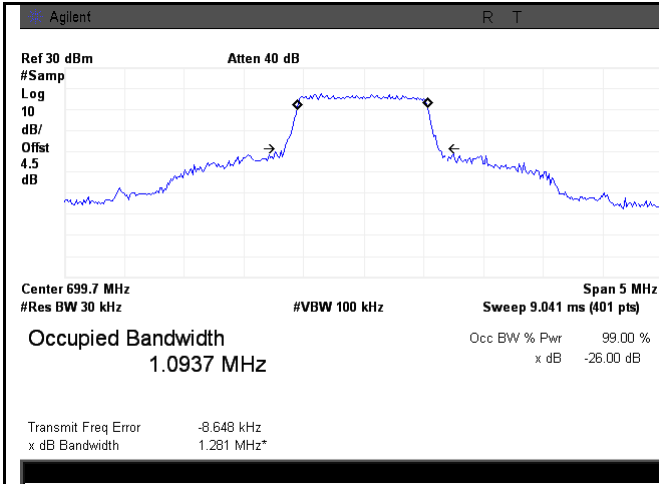

LTE band 12 - Low CH QPSK-1.4

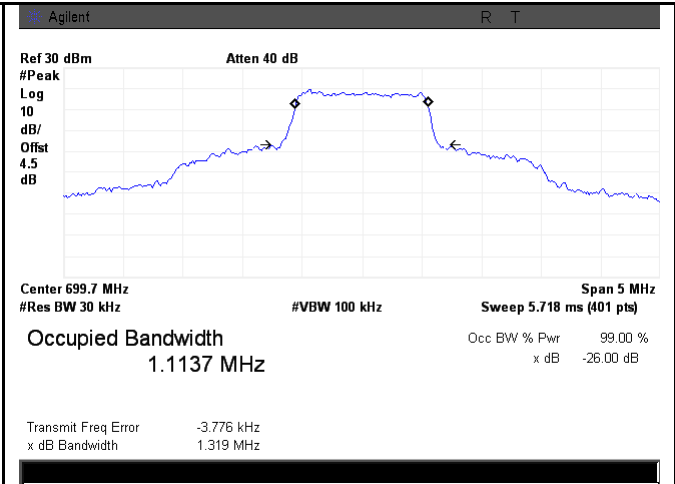

LTE band 12 - Low CH 16QAM-1.4

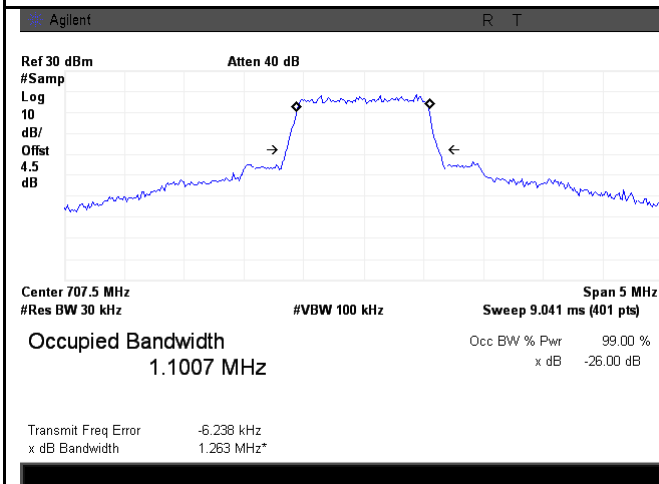

LTE band 12 - Middle CH QPSK-1.4

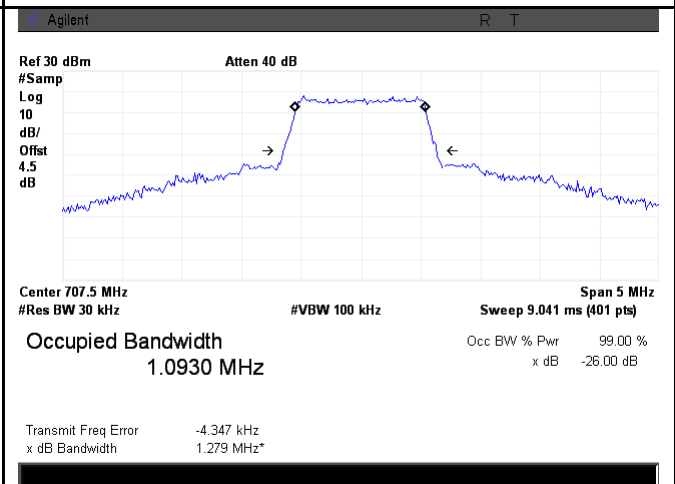

LTE band 12 - Middle CH 16QAM-1.4

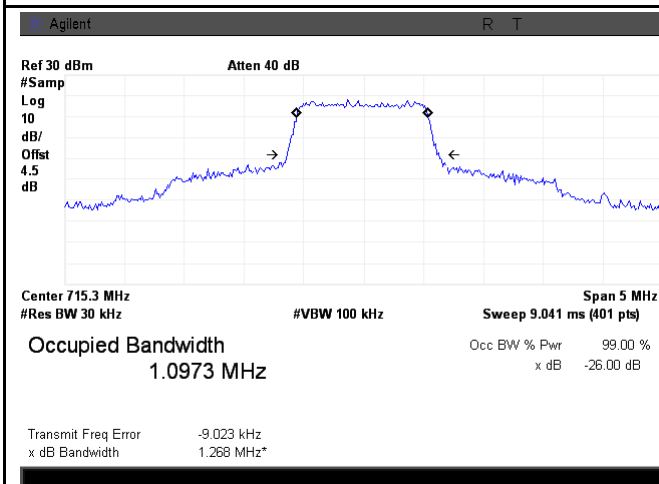

LTE band 12 - High CH QPSK-1.4

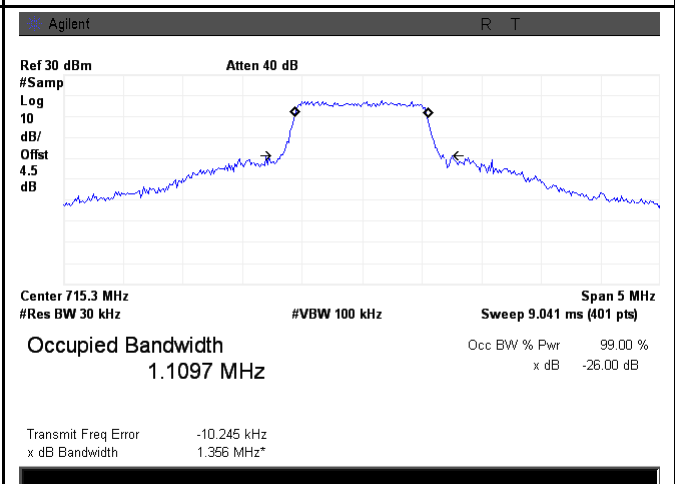

LTE band 12 - High CH 16QAM-1.4

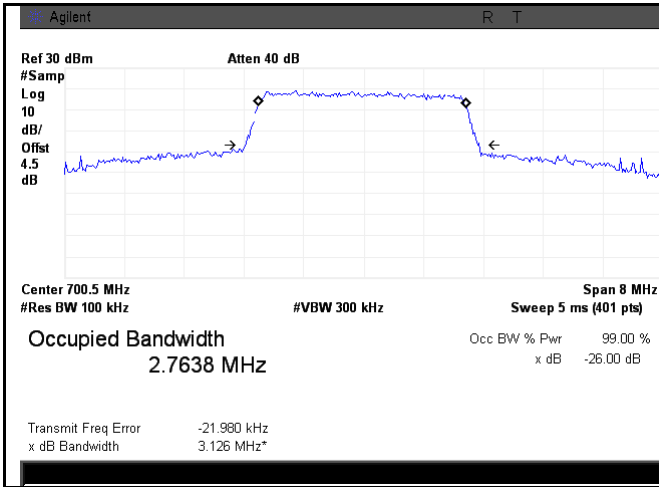

LTE band 12 - Low CH QPSK-3

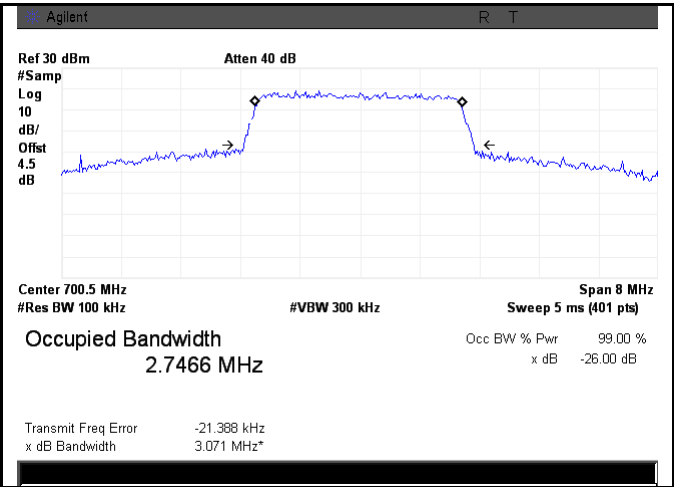

LTE band 12 - Low CH 16QAM-3

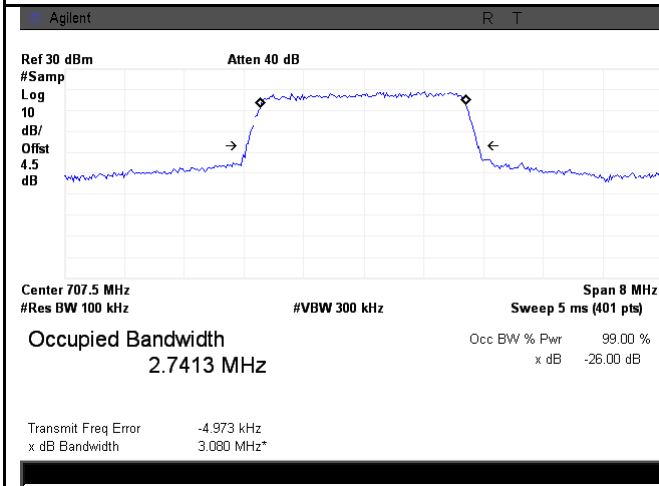

LTE band 12 - Middle CH QPSK-3

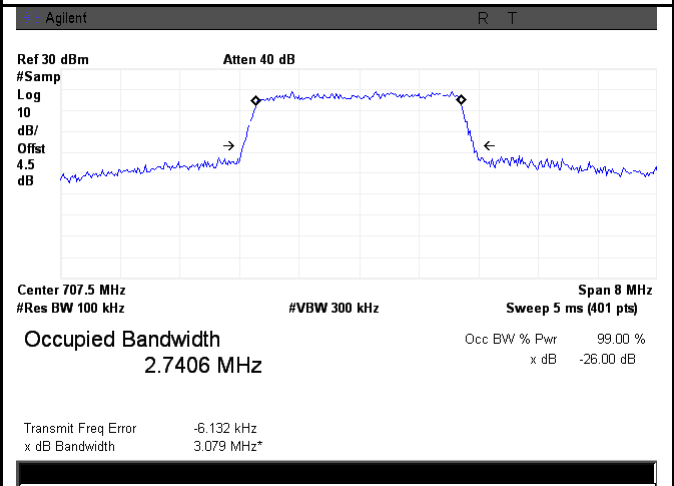

LTE band 12 - Middle CH 16QAM-3

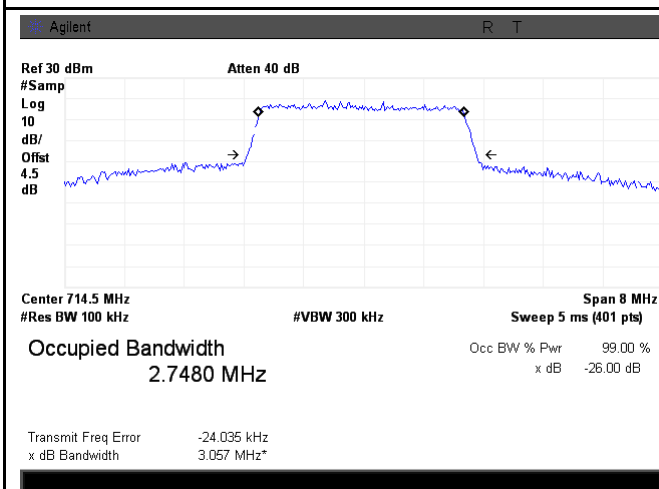

LTE band 12 - High CH QPSK-3

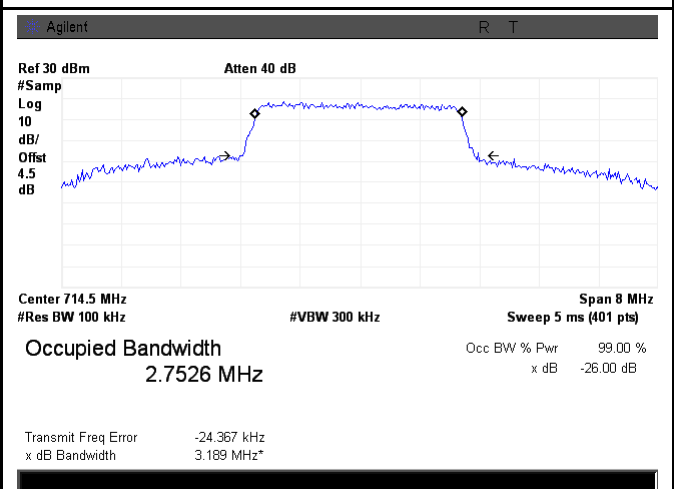

LTE band 12 - High CH 16QAM-3

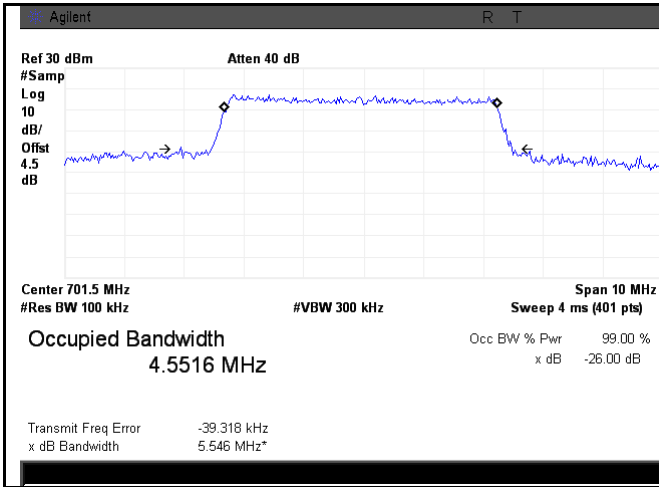

LTE band 12 - Low CH QPSK-5

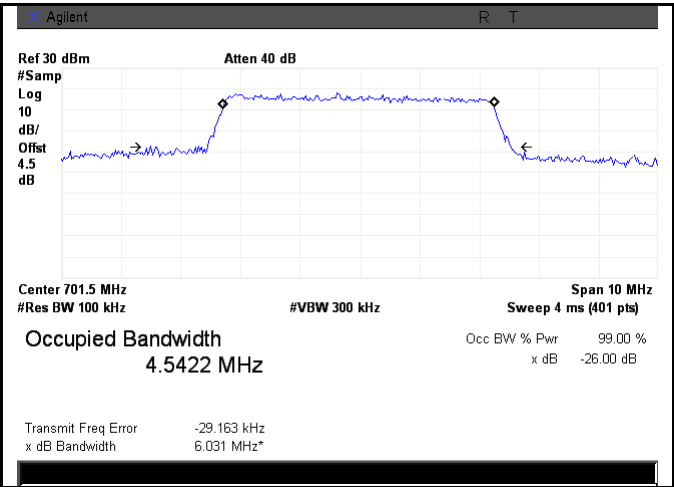

LTE band 12 - Low CH 16QAM-5

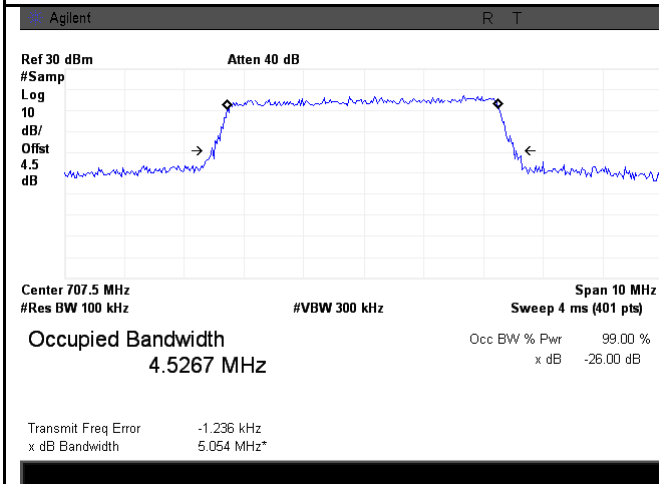

LTE band 12 - Middle CH QPSK-5

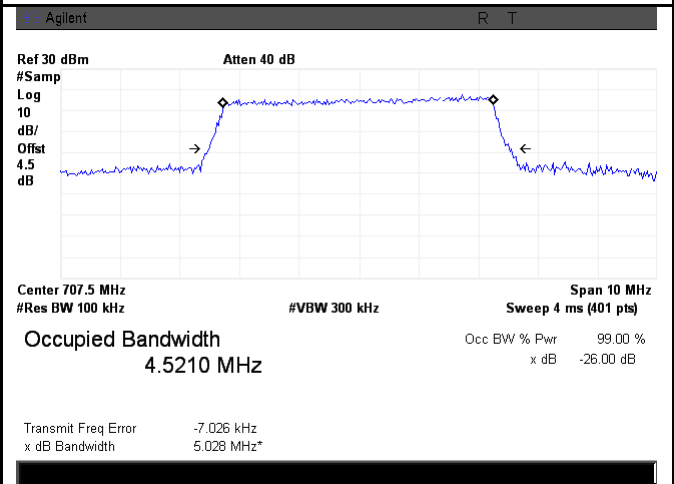

LTE band 12 - Middle CH 16QAM-5

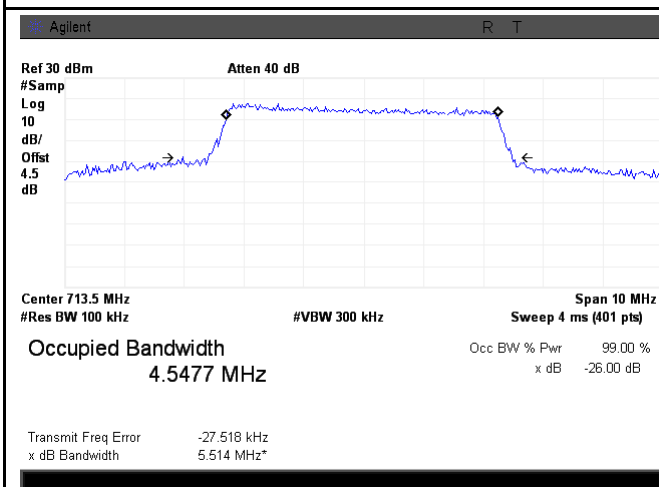

LTE band 12 - High CH QPSK-5

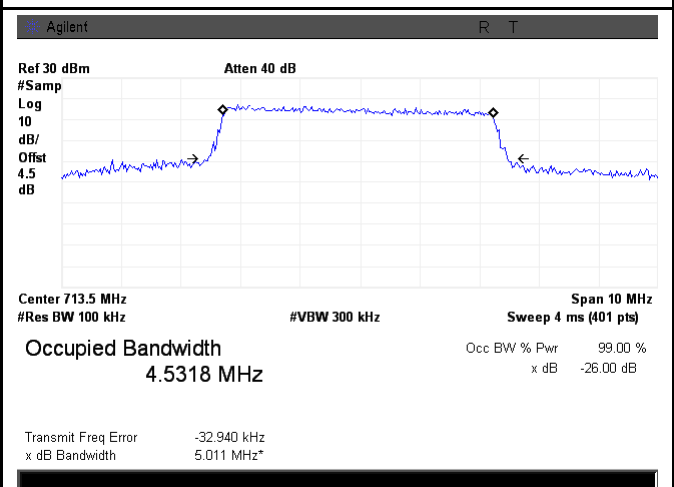

LTE band 12 - High CH 16QAM-5

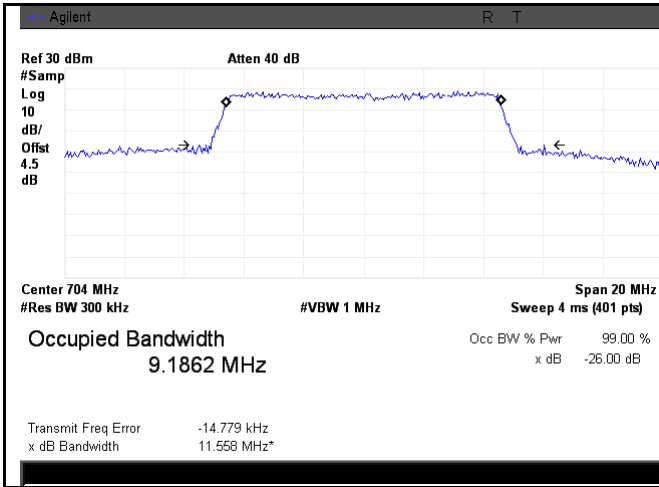

LTE band 12 - Low CH QPSK-10

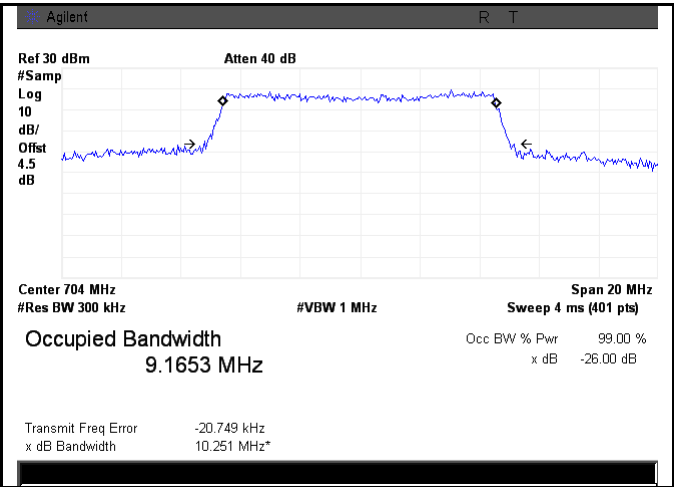

LTE band 12 - Low CH 16QAM-10

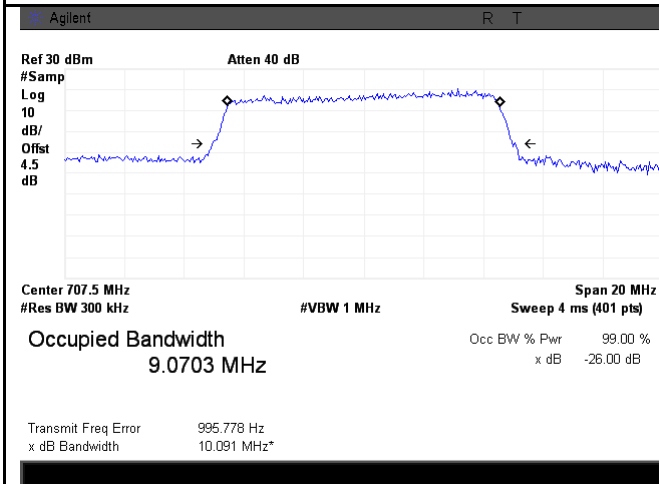

LTE band 12 - Middle CH QPSK-10

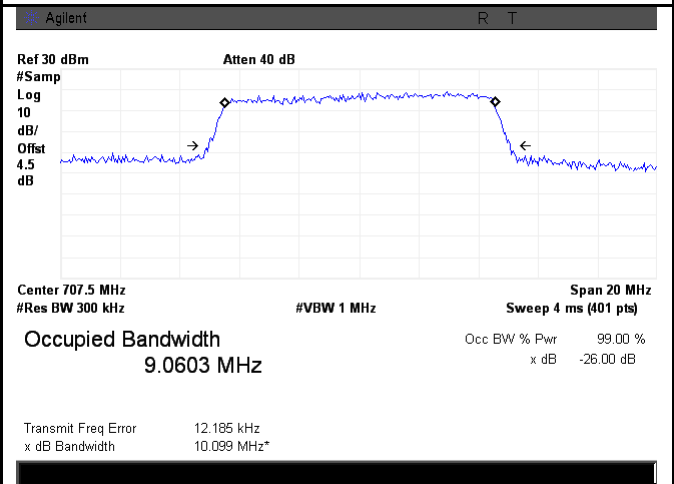

LTE band 12 - Middle CH 16QAM-10

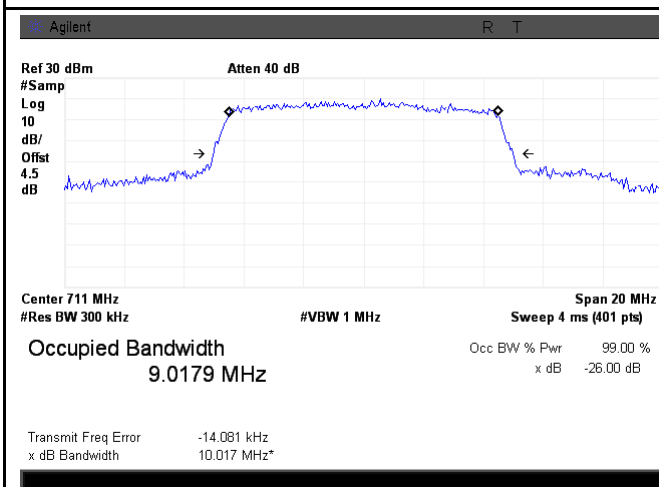

LTE band 12 - High CH QPSK-10

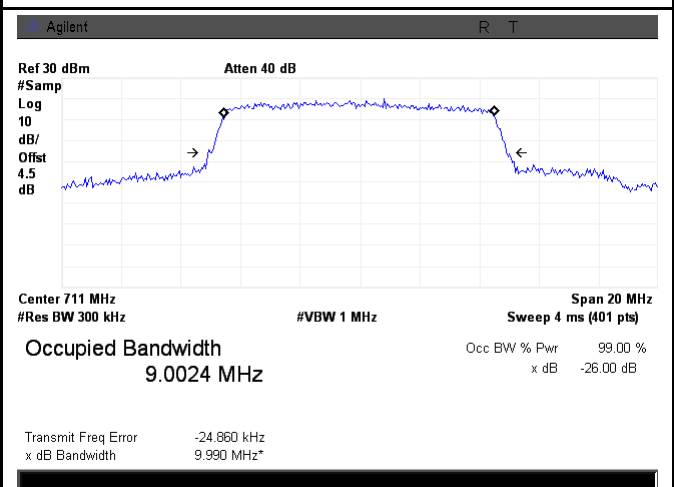

LTE band 12 - High CH 16QAM-10

LTE Band 17 (Part 27)

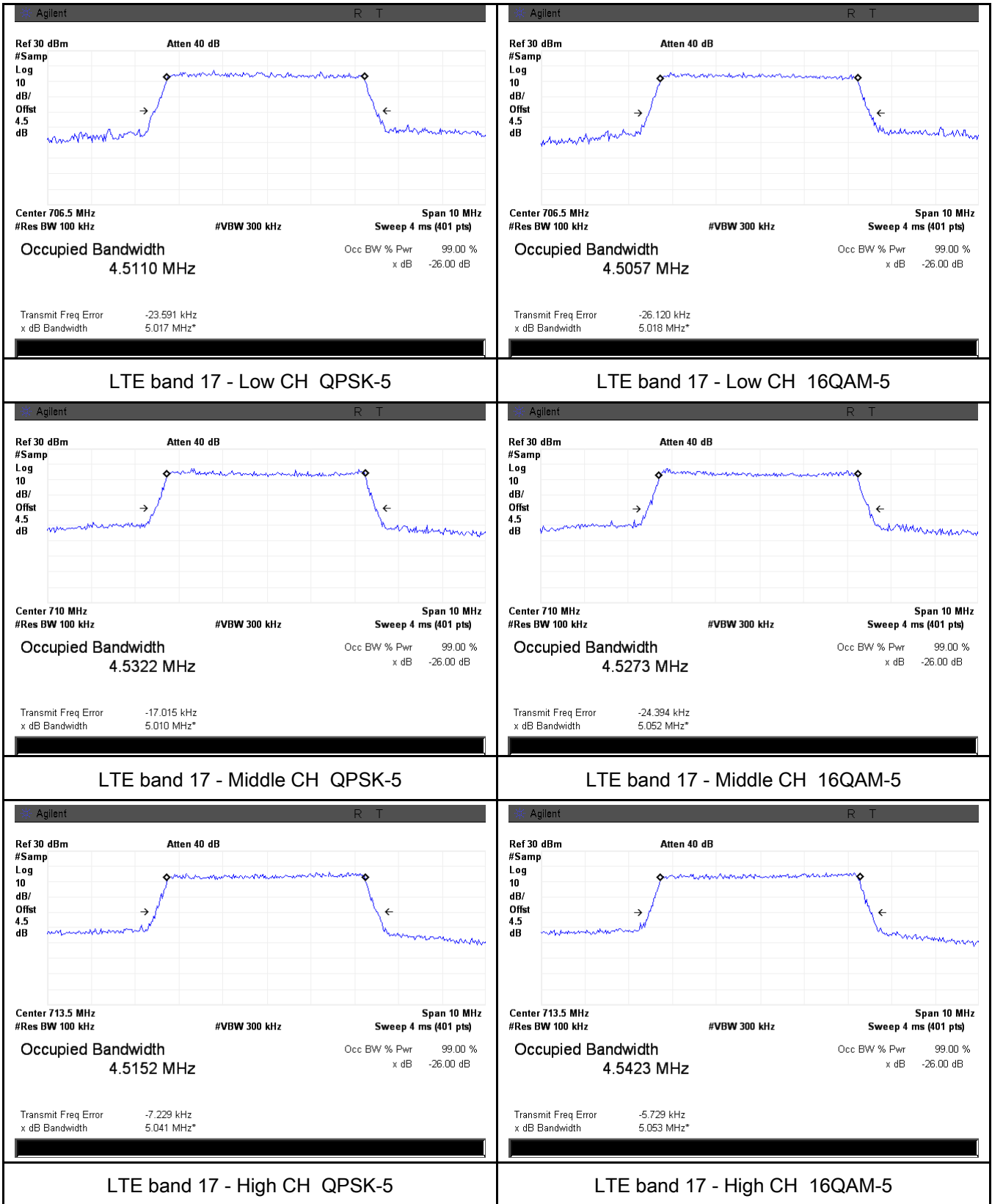

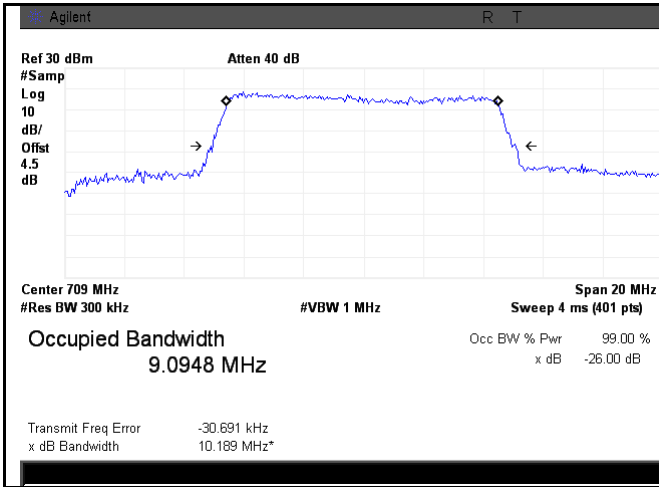

LTE band 17 - Low CH QPSK-10

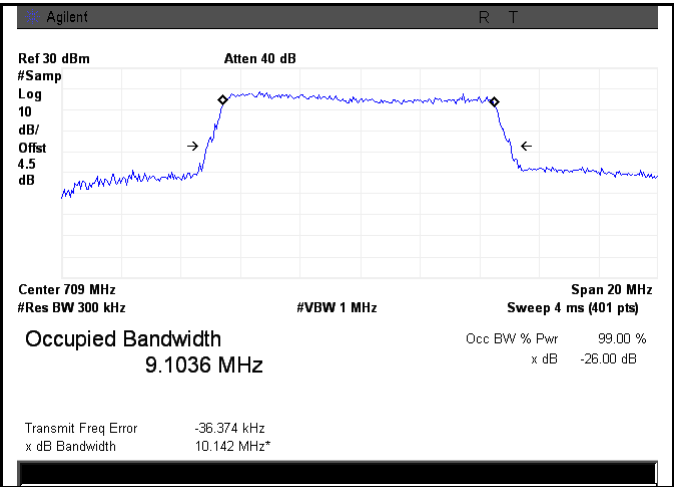

LTE band 17 - Low CH 16QAM-10

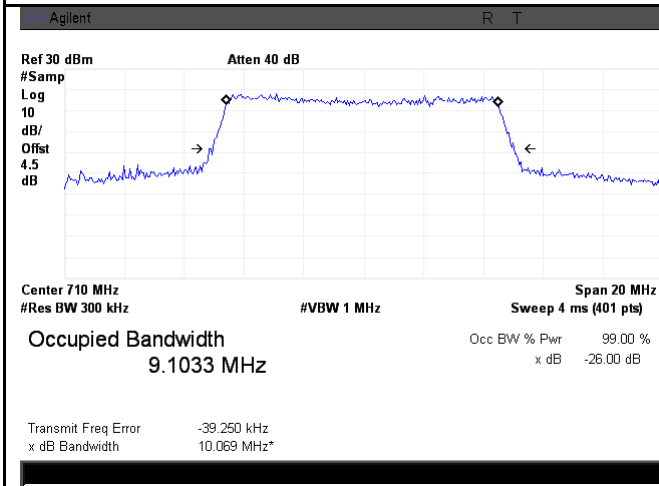

LTE band 17 - Middle CH QPSK-10

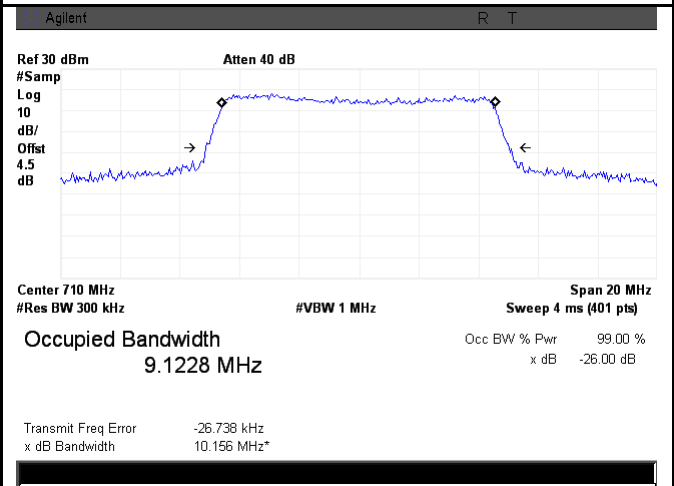

LTE band 17 - Middle CH 16QAM-10

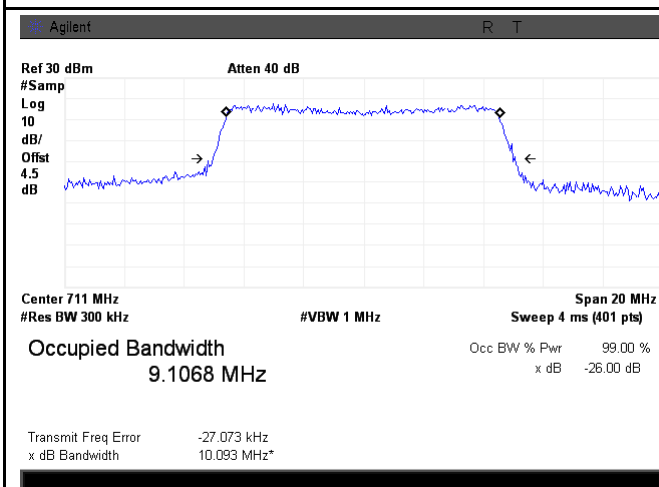

LTE band 17 - High CH QPSK-10

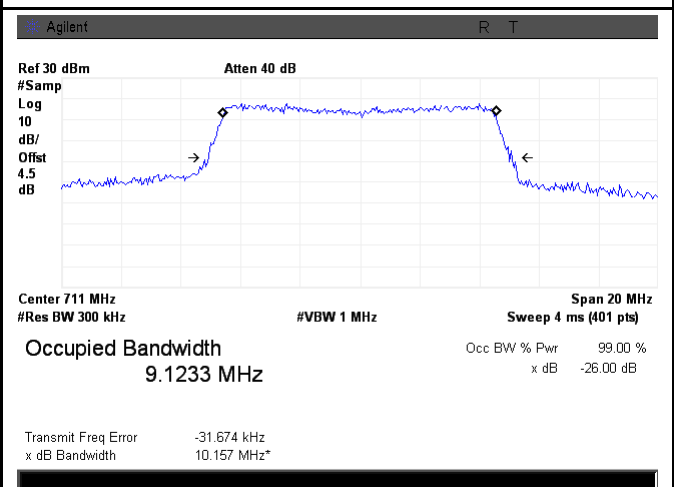

LTE band 17 - High CH 16QAM-10

6.6 Spurious Emissions at Antenna Terminals

Temperature	24°C
Relative Humidity	59%
Atmospheric Pressure	1007mbar
Test date :	August 07, 2015 and November 04, 2015
Tested By :	Winnie Zhang

Requirement(s):

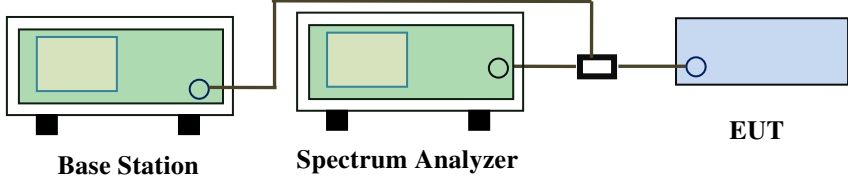
Spec	Item	Requirement	Applicable
§2.1051, §22.917(a)& §24.238(a) § 27.53(h)	a)	The power of any emission outside of the authorized operating frequency ranges must be lower than the transmitter power (P) by a factor of at least $43 + 10 \log(P)$ dB	<input checked="" type="checkbox"/>
Test Setup	 <p>The diagram shows a Base Station (green box) connected to a Spectrum Analyzer (green box) and an EUT (blue box) via a power divider (black box). The Base Station and Spectrum Analyzer are connected to each other, and the Spectrum Analyzer is connected to the power divider, which then splits the signal to the EUT.</p>		
Test Procedure	<ul style="list-style-type: none"> - The EUT was connected to Spectrum Analyzer and Base Station via power divider. - The Band Edges of low and high channels for the highest RF powers were measured. - Setting RBW as roughly BW/100. 		
Remark			
Result	<input checked="" type="checkbox"/> Pass <input type="checkbox"/> Fail		

Test Data Yes N/A
 Test Plot Yes (See below) N/A

Test Plots 30MHz-5GHz
LTE Band 2 (Part 24E)

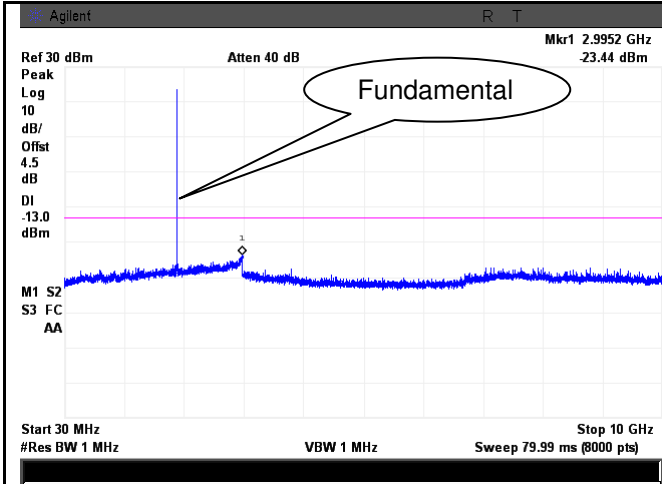

LTE Band 2 - Low Channel-1

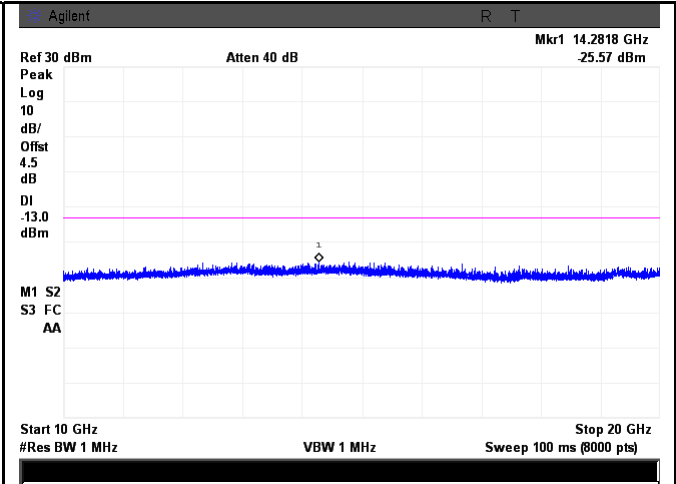

LTE Band 2 - Low Channel-2

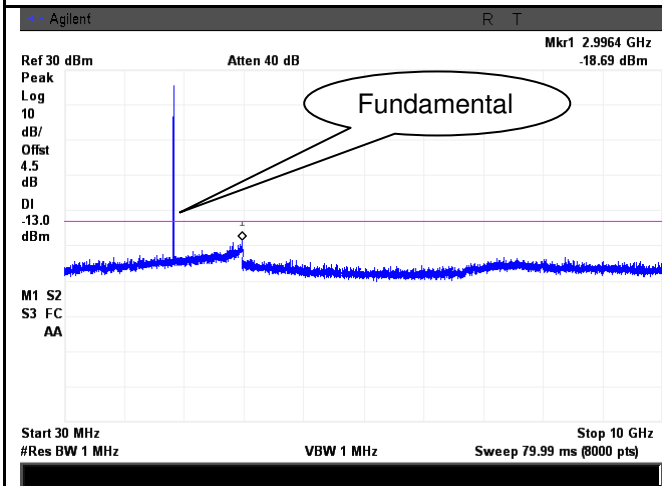

LTE Band 2 Middle Channel-1

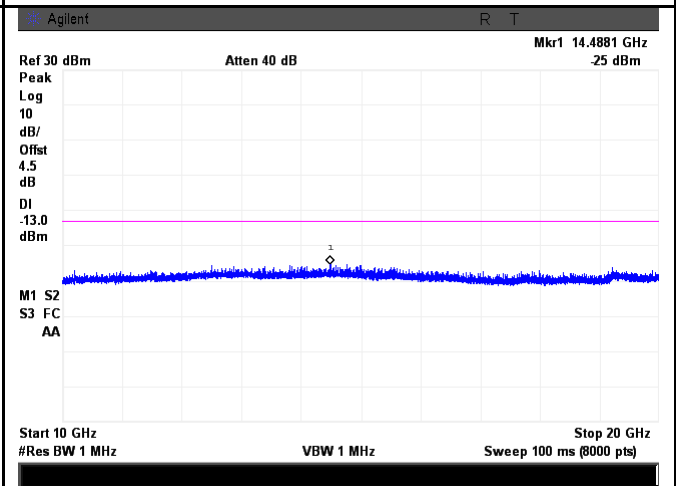

LTE Band 2 Middle Channel-2

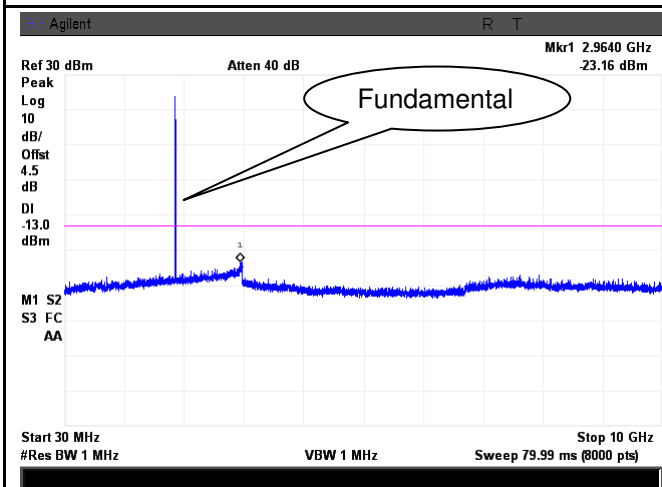

LTE Band 2 - High Channel-1

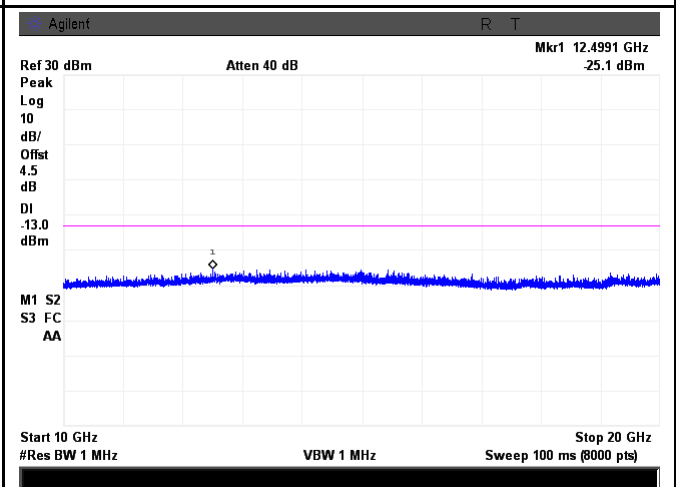

LTE Band 2 - High Channel-2

LTE Band 4 (Part27) result

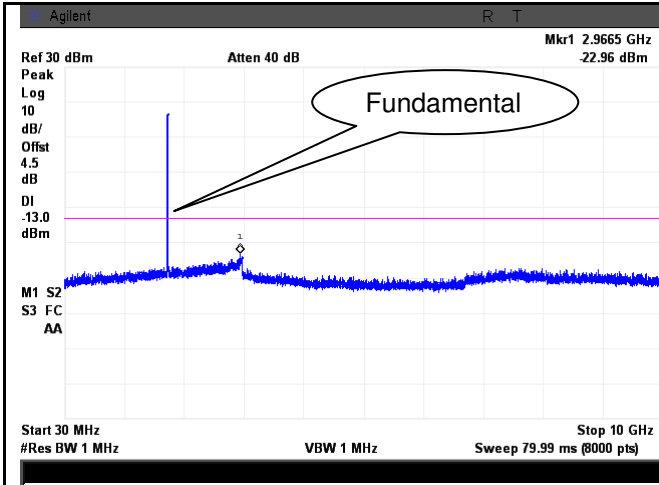

LTE Band 4 - Low Channel-1

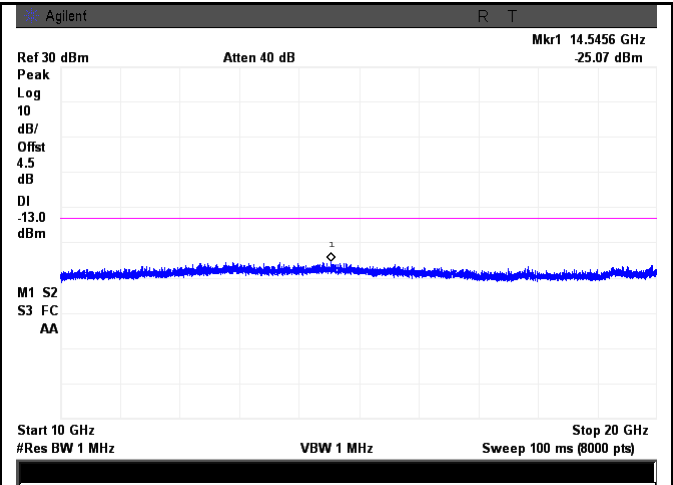

LTE Band 4 - Low Channel-2

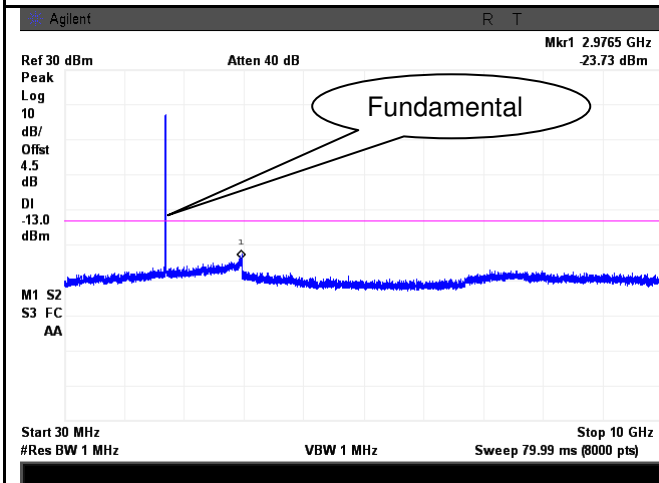

LTE Band 4 - Middle Channel-1

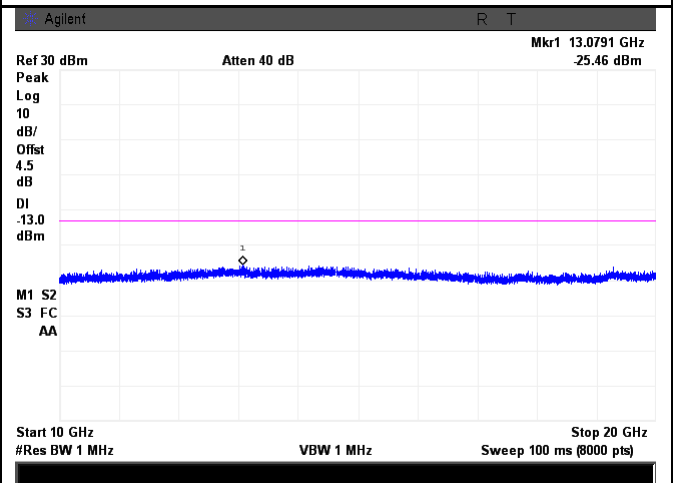

LTE Band 4 - Middle Channel-2

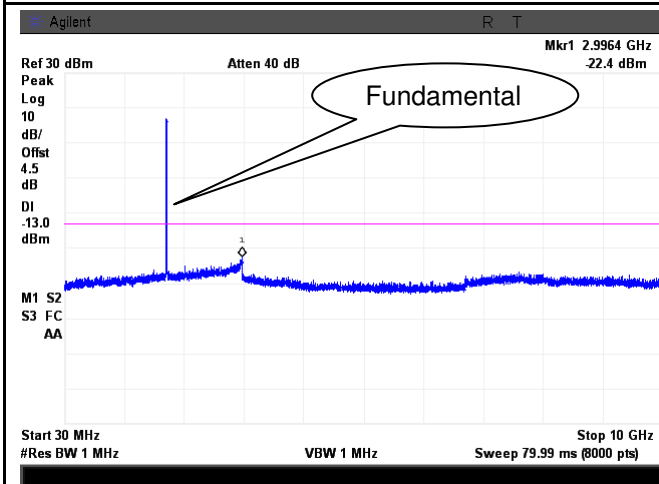

LTE Band 4 - High Channel-1

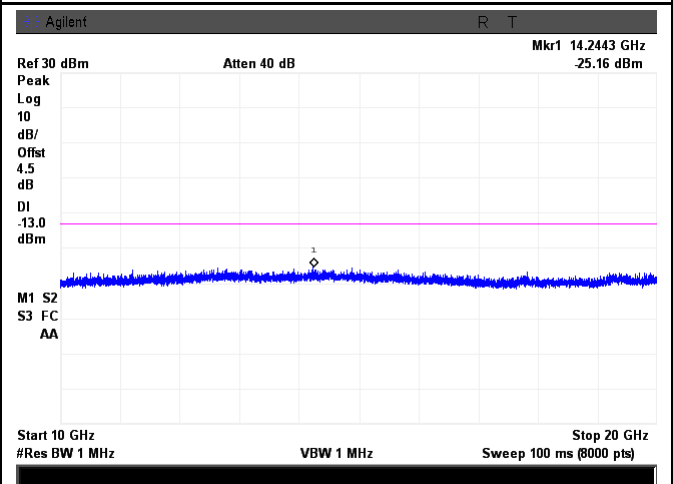

LTE Band 4 - High Channel-2

LTE Band 5 (Part 22H)

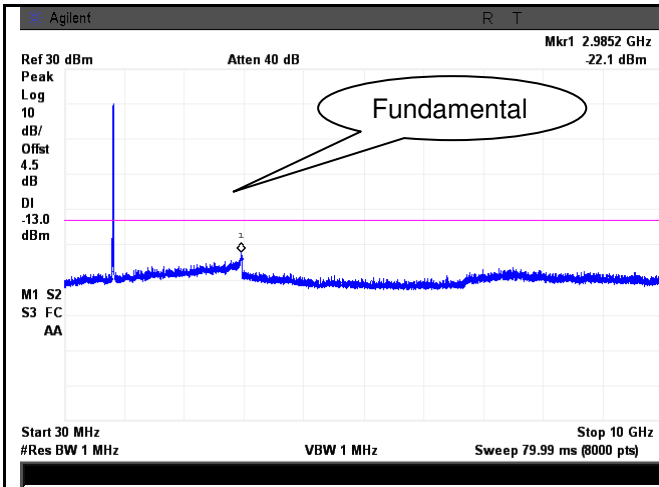

LTE Band 5 - Low Channel-1

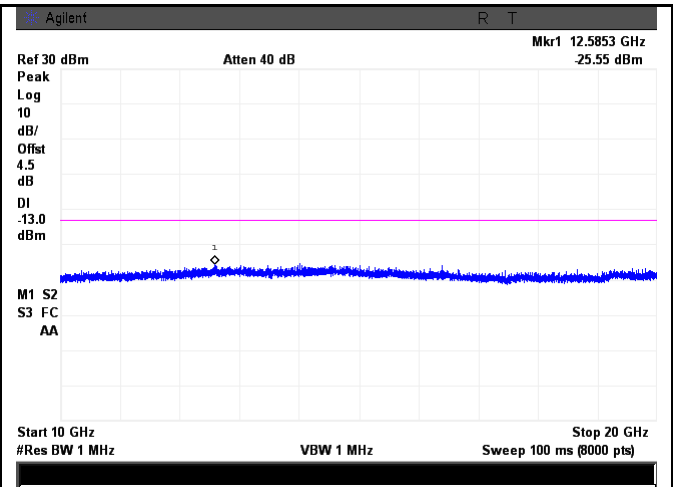

LTE Band 5 - Low Channel-2

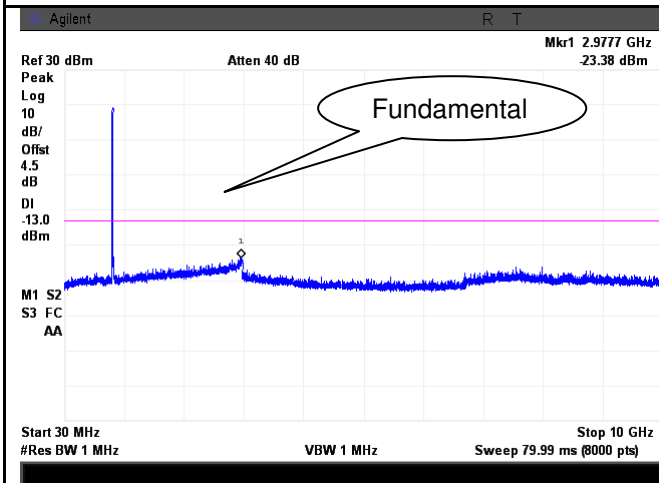

LTE Band 5 - Middle Channel-1

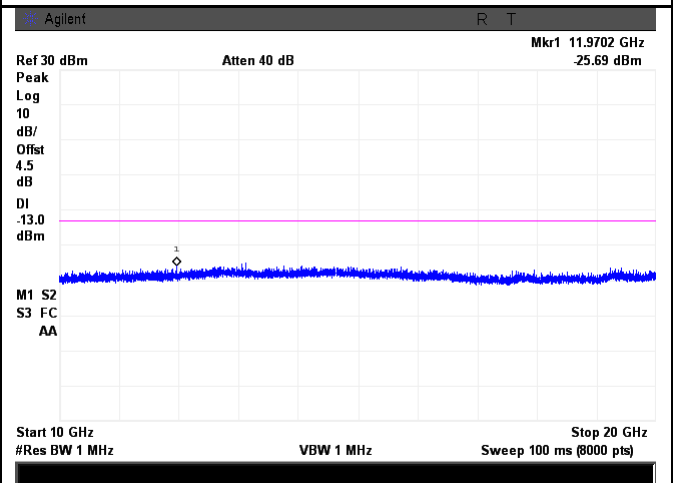

LTE Band 5 - Middle Channel-2

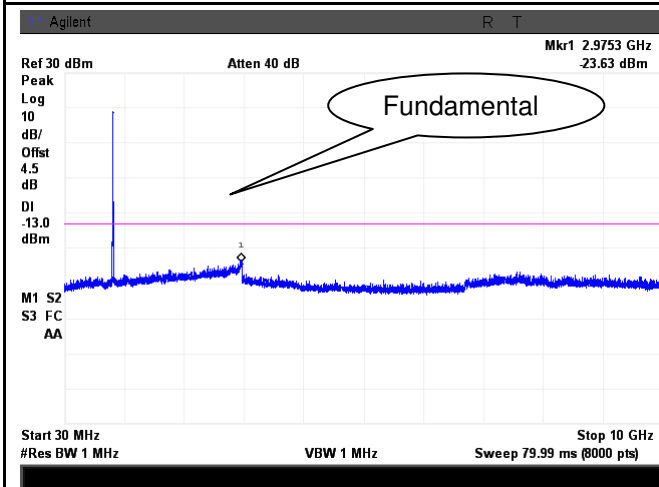

LTE Band 5 - High Channel-1

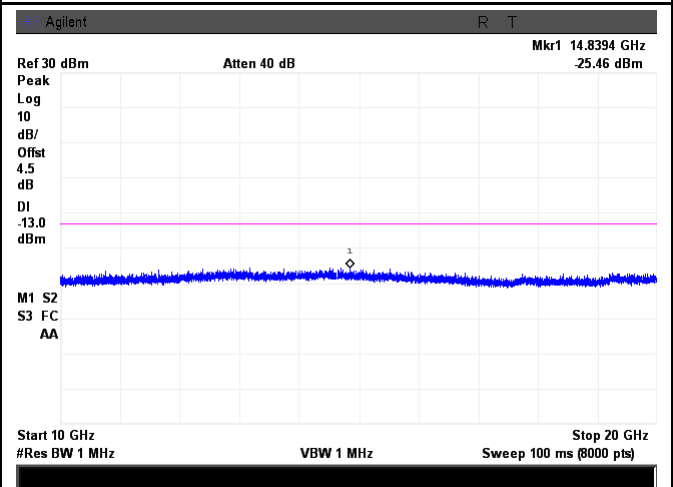

LTE Band 5 - High Channel-2

LTE Band 12 (Part 27)

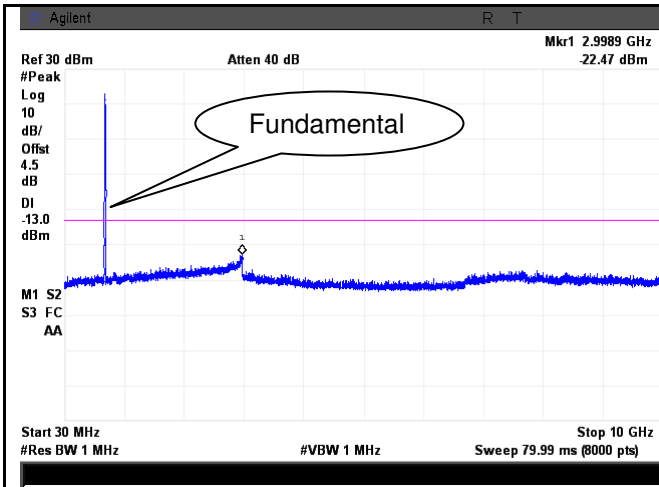

LTE Band 12 - Low Channel-1

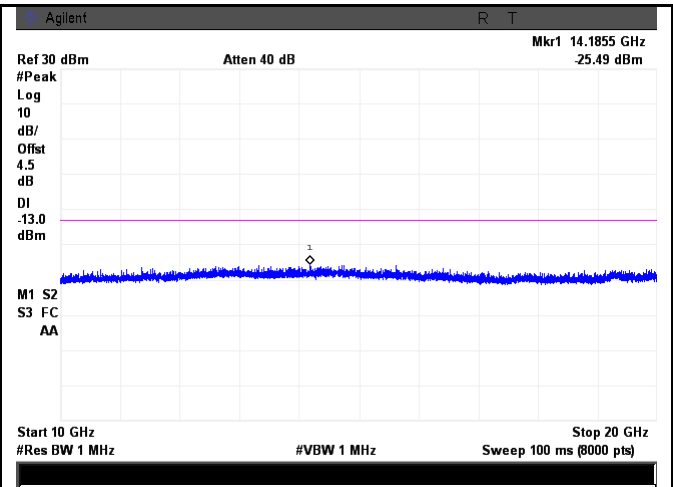

LTE Band 12 - Low Channel-2

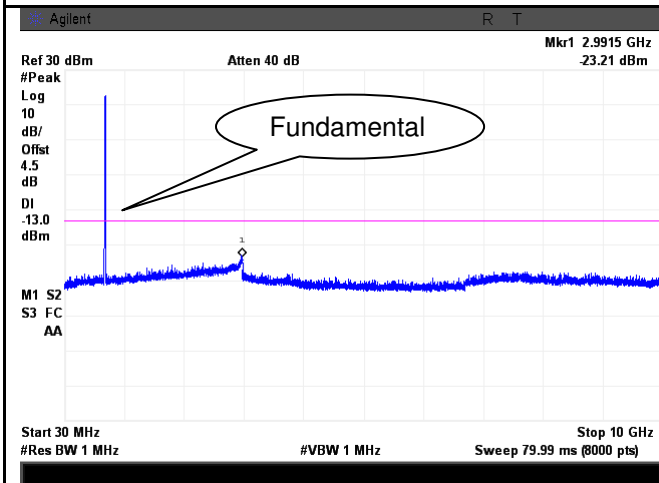

LTE Band 12 - Middle Channel-1

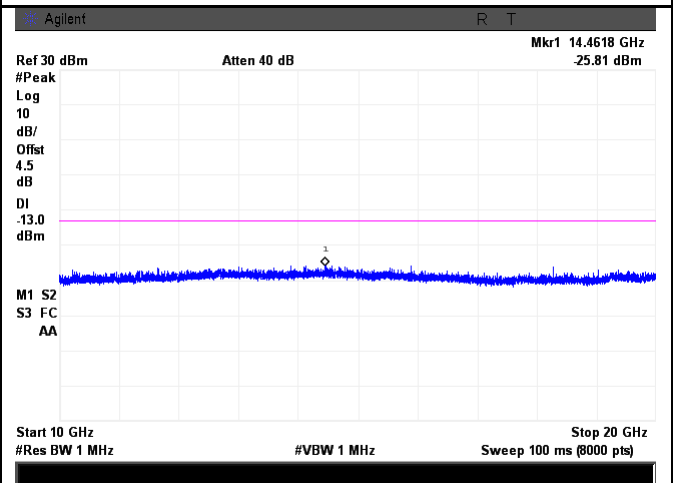

LTE Band 12 - Middle Channel-2

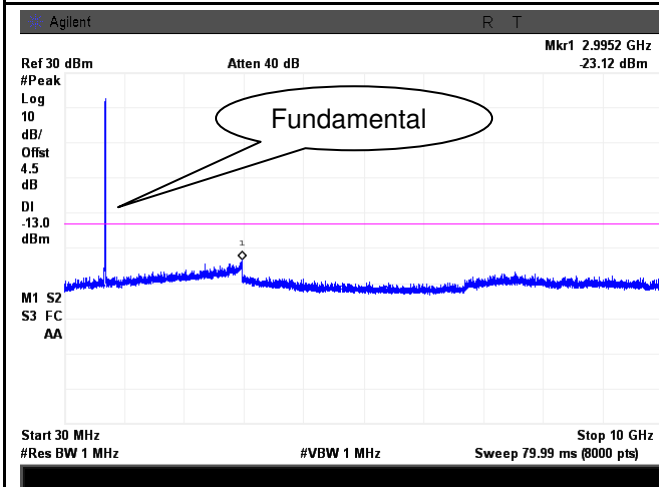

LTE Band 12 - High Channel-1

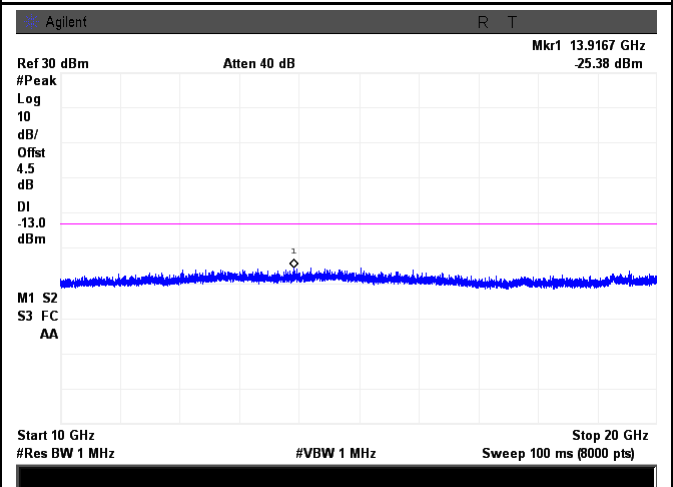

LTE Band 12 - High Channel-2

LTE Band 17 (Part 27)

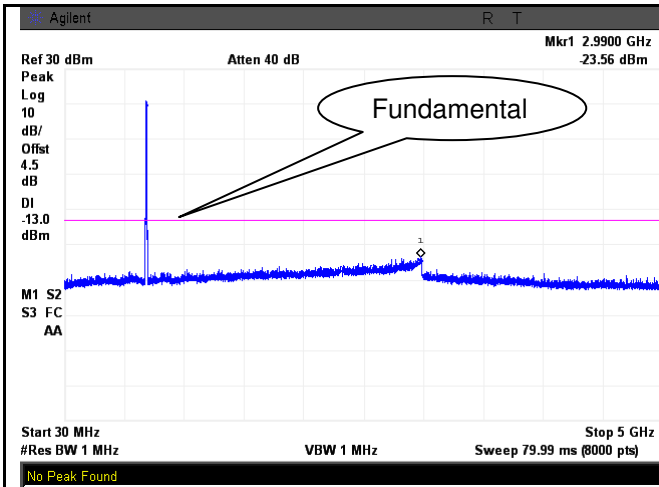

LTE Band 17 - Low Channel-1

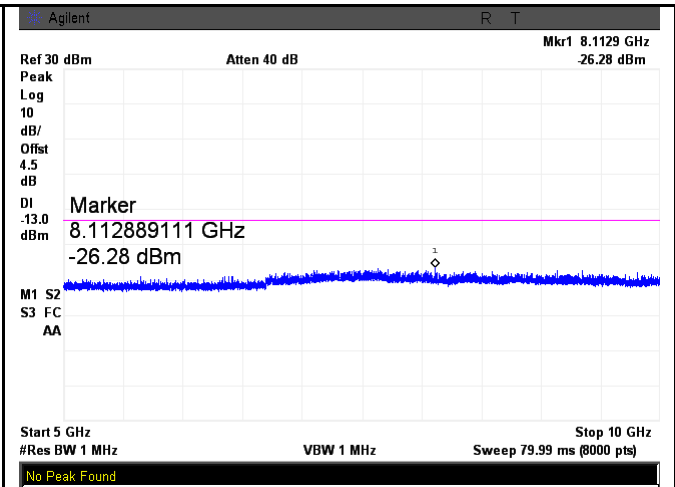

LTE Band 17 - Low Channel-2

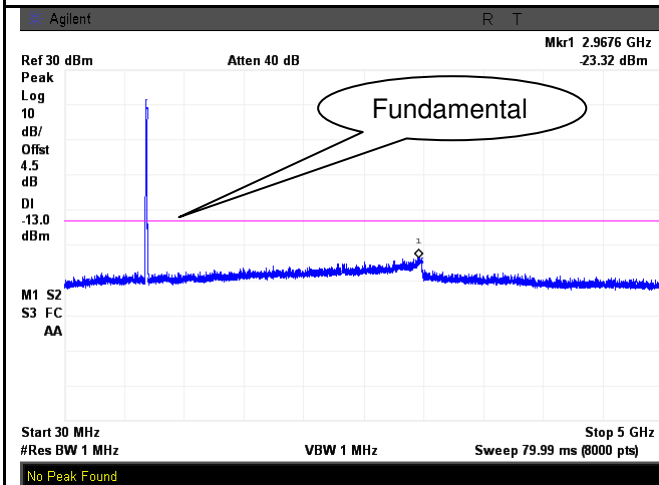

LTE Band 17 - Middle Channel-1

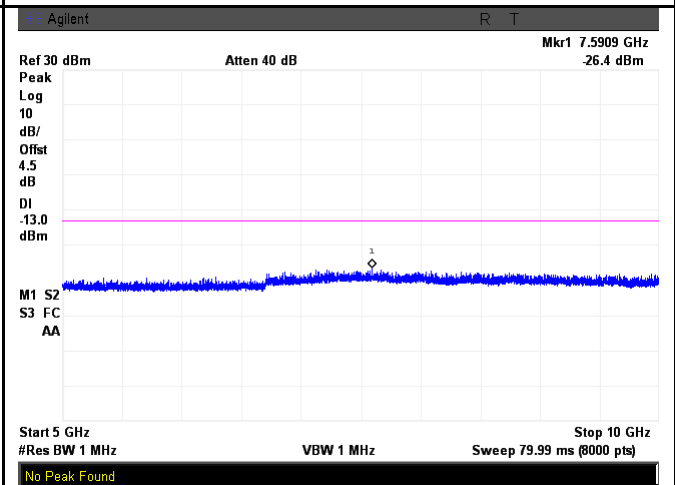

LTE Band 17 - Middle Channel-2

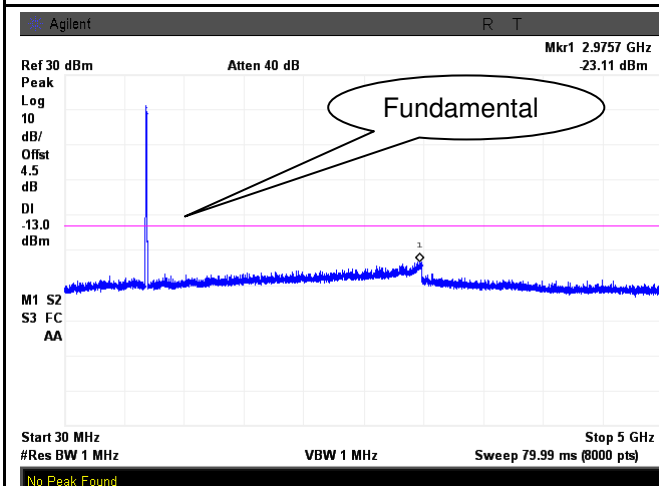

LTE Band 17 - High Channel-1

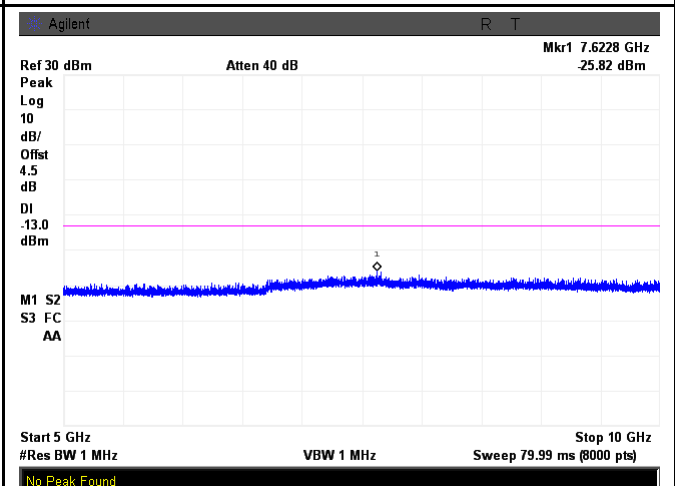

LTE Band 17 - High Channel-2

6.7 Spurious Radiated Emissions

Temperature	24°C
Relative Humidity	59%
Atmospheric Pressure	1007mbar
Test date :	August 07, 2015 and November 04, 2015
Tested By :	Winnie Zhang

Requirement(s):

Spec	Item	Requirement	Applicable
§2.1053, §22.917 & §24.238 § 27.53(h)	a)	The power of any emission outside of the authorized operating frequency ranges must be attenuated below the transmitter power (P) by a factor of at least $43 + 10 \log (P)$ dB. The spectrum is scanned from 30 MHz up to a frequency including its 10th harmonic.	<input checked="" type="checkbox"/>

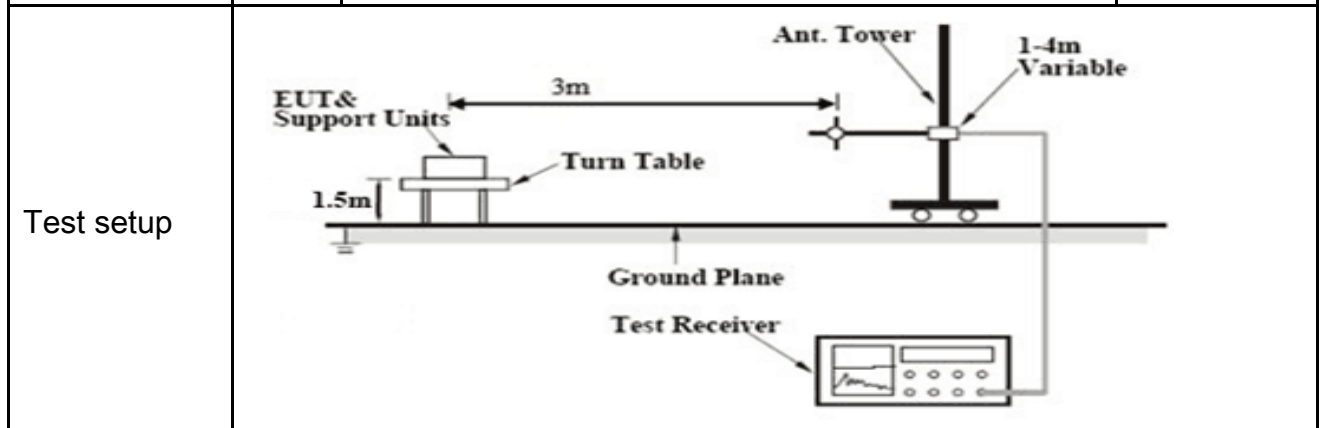

Test Procedure	<ol style="list-style-type: none"> The transmitter was placed on a wooden turntable, and it was transmitting into a non-radiating load which was also placed on the turntable. The measurement antenna was placed at a distance of 3 meters from the EUT. During the tests, the antenna height and polarization as well as EUT azimuth were varied in order to identify the maximum level of emissions from the EUT. The test was performed by placing the EUT on 3-orthogonal axis. Remove the EUT and replace it with substitution antenna. A signal generator was connected to the substitution antenna by a non-radiating cable. The absolute levels of the spurious emissions were measured by the substitution. Sample Calculation: EUT Field Strength = Raw Amplitude (dBμV/m) – Amplifier Gain (dB) + Antenna Factor (dB) + Cable Loss (dB) + Filter Attenuation (dB, if used)
----------------	---

Remark	
--------	--

Result	<input checked="" type="checkbox"/> Pass	<input type="checkbox"/> Fail
--------	--	-------------------------------

Test Data Yes N/A

Test Plot Yes (See below) N/A

LTE Band 2 (Part 24E) result

Low channel

Frequency (MHz)	Substituted level (dBm)	Polarity (H/V)	Antenna Gain Correction (dB)	Cable Loss (dB)	Corrected Reading (dBm)	Limit (dBm)	Margin (dB)
3720	-45.18	V	10.25	2.73	-37.66	-13	-24.66
3720	-45.32	H	10.25	2.73	-37.8	-13	-24.8
361.5	-48.93	V	6.7	0.28	-42.51	-13	-29.51
741.2	-50.17	H	7.1	0.42	-43.49	-13	-30.49

Middle channel

Frequency (MHz)	Substituted level (dBm)	Polarity (H/V)	Antenna Gain Correction (dB)	Cable Loss (dB)	Corrected Reading (dBm)	Limit (dBm)	Margin (dB)
3760	-45.11	V	10.25	2.73	-37.59	-13	-24.59
3760	-45.67	H	10.25	2.73	-38.15	-13	-25.15
361.8	-48.74	V	6.7	0.28	-42.32	-13	-29.32
741.4	-50.22	H	7.1	0.42	-43.54	-13	-30.54

High channel

Frequency (MHz)	Substituted level (dBm)	Polarity (H/V)	Antenna Gain Correction (dB)	Cable Loss (dB)	Corrected Reading (dBm)	Limit (dBm)	Margin (dB)
3800	-45.26	V	10.36	2.73	-37.63	-13	-24.63
3800	-45.83	H	10.36	2.73	-38.2	-13	-25.2
361.5	-48.91	V	6.7	0.28	-42.49	-13	-29.49
741.8	-50.37	H	7.1	0.42	-43.69	-13	-30.69

LTE Band 4(Part27) result

Low channel

Frequency (MHz)	Substituted level (dBm)	Polarity (H/V)	Antenna Gain Correction (dB)	Cable Loss (dB)	Corrected Reading (dBm)	Limit (dBm)	Margin (dB)
3440	-44.95	V	10.06	2.52	-37.41	-13	-24.41
3440	-46.02	H	10.06	2.52	-38.48	-13	-25.48
361.3	-49.16	V	6.7	0.28	-42.74	-13	-29.74
741.6	-50.69	H	7.1	0.42	-44.01	-13	-31.01

Middle channel

Frequency (MHz)	Substituted level (dBm)	Polarity (H/V)	Antenna Gain Correction (dB)	Cable Loss (dB)	Corrected Reading (dBm)	Limit (dBm)	Margin (dB)
3465	-45.61	V	10.09	2.52	-38.04	-13	-25.04
3465	-46.25	H	10.09	2.52	-38.68	-13	-25.68
361.5	-48.83	V	6.7	0.28	-42.41	-13	-29.41
741.3	-50.77	H	7.1	0.42	-44.09	-13	-31.09

High channel

Frequency (MHz)	Substituted level (dBm)	Polarity (H/V)	Antenna Gain Correction (dB)	Cable Loss (dB)	Corrected Reading (dBm)	Limit (dBm)	Margin (dB)
3490	-45.64	V	10.09	2.52	-38.07	-13	-25.07
3490	-46.71	H	10.09	2.52	-39.14	-13	-26.14
361.7	-48.59	V	6.7	0.28	-42.17	-13	-29.17
741.1	-50.62	H	7.1	0.42	-43.94	-13	-30.94

LTE Band 5(Part22H) result

Low channel

Frequency (MHz)	Substituted level (dBm)	Polarity (H/V)	Antenna Gain Correction (dB)	Cable Loss (dB)	Corrected Reading (dBm)	Limit (dBm)	Margin (dB)
1658	-44.86	V	7.95	0.78	-37.69	-13	-24.69
1658	-45.39	H	7.95	0.78	-38.22	-13	-25.22
360.9	-49.11	V	6.7	0.28	-42.69	-13	-29.69
740.5	-50.73	H	7.1	0.42	-44.05	-13	-31.05

Middle channel

Frequency (MHz)	Substituted level (dBm)	Polarity (H/V)	Antenna Gain Correction (dB)	Cable Loss (dB)	Corrected Reading (dBm)	Limit (dBm)	Margin (dB)
1673	-45.07	V	7.95	0.78	-37.9	-13	-24.9
1673	-45.66	H	7.95	0.78	-38.49	-13	-25.49
360.5	-48.39	V	6.7	0.28	-41.97	-13	-28.97
740.1	-50.44	H	7.1	0.42	-43.76	-13	-30.76

High channel

Frequency (MHz)	Substituted level (dBm)	Polarity (H/V)	Antenna Gain Correction (dB)	Cable Loss (dB)	Corrected Reading (dBm)	Limit (dBm)	Margin (dB)
1688	-45.12	V	7.95	0.78	-37.95	-13	-24.95
1688	-45.79	H	7.95	0.78	-38.62	-13	-25.62
360.7	-48.67	V	6.7	0.28	-42.25	-13	-29.25
740.6	-50.53	H	7.1	0.42	-43.85	-13	-30.85

LTE Band 12(Part27) result

Low channel

Frequency (MHz)	Substituted level (dBm)	Polarity (H/V)	Antenna Gain Correction (dB)	Cable Loss (dB)	Corrected Reading (dBm)	Limit (dBm)	Margin (dB)
1408	-47.13	V	7.65	0.75	-40.23	-13	-27.23
1408	-47.51	H	7.65	0.75	-40.61	-13	-27.61
538.2	-51.66	V	6.5	0.36	-45.52	-13	-32.52
814.5	-51.97	H	6.8	0.44	-45.61	-13	-32.61

Middle channel

Frequency (MHz)	Substituted level (dBm)	Polarity (H/V)	Antenna Gain Correction (dB)	Cable Loss (dB)	Corrected Reading (dBm)	Limit (dBm)	Margin (dB)
1415	-47.19	V	7.65	0.75	-40.29	-13	-27.29
1415	-47.62	H	7.65	0.75	-40.72	-13	-27.72
538.6	-51.59	V	6.5	0.36	-45.45	-13	-32.45
814.1	-51.85	H	6.8	0.44	-45.49	-13	-32.49

High channel

Frequency (MHz)	Substituted level (dBm)	Polarity (H/V)	Antenna Gain Correction (dB)	Cable Loss (dB)	Corrected Reading (dBm)	Limit (dBm)	Margin (dB)
1422	-47.21	V	7.65	0.75	-40.31	-13	-27.31
1422	-47.54	H	7.65	0.75	-40.64	-13	-27.64
538.9	-51.83	V	6.5	0.36	-45.69	-13	-32.69
814.6	-51.97	H	6.8	0.44	-45.61	-13	-32.61

LTE Band 17(Part27) result

Low channel

Frequency (MHz)	Substituted level (dBm)	Polarity (H/V)	Antenna Gain Correction (dB)	Cable Loss (dB)	Corrected Reading (dBm)	Limit (dBm)	Margin (dB)
1418	-44.75	V	7.65	0.75	-37.85	-13	-24.85
1418	-45.98	H	7.65	0.75	-39.08	-13	-26.08
363.1	-48.62	V	6.7	0.28	-42.2	-13	-29.2
742.5	-50.27	H	7.1	0.42	-43.59	-13	-30.59

Middle channel

Frequency (MHz)	Substituted level (dBm)	Polarity (H/V)	Antenna Gain Correction (dB)	Cable Loss (dB)	Corrected Reading (dBm)	Limit (dBm)	Margin (dB)
1420	-44.66	V	7.65	0.75	-37.76	-13	-24.76
1420	-46.09	H	7.65	0.75	-39.19	-13	-26.19
363.5	-48.53	V	6.7	0.28	-42.11	-13	-29.11
742.9	-50.41	H	7.1	0.42	-43.73	-13	-30.73

High channel

Frequency (MHz)	Substituted level (dBm)	Polarity (H/V)	Antenna Gain Correction (dB)	Cable Loss (dB)	Corrected Reading (dBm)	Limit (dBm)	Margin (dB)
1422	-44.73	V	7.65	0.75	-37.83	-13	-24.83
1422	-46.15	H	7.65	0.75	-39.25	-13	-26.25
363.8	-49.08	V	6.7	0.28	-42.66	-13	-29.66
742.3	-50.55	H	7.1	0.42	-43.87	-13	-30.87

6.8 Band Edge

Temperature	24°C
Relative Humidity	56%
Atmospheric Pressure	1004mbar
Test date :	August 08-August 13, 2015 and November 04, 2015
Tested By :	Winnie Zhang

Requirement(s):

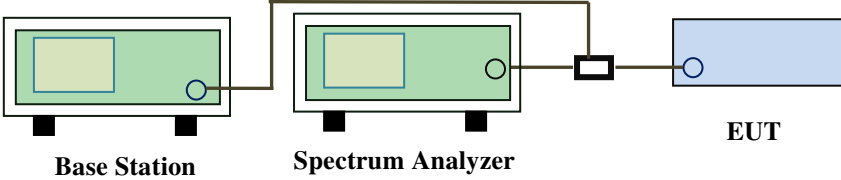
Spec	Item	Requirement	Applicable
§22.917(a) §24.238(a) § 27.53(h)	a)	The power of any emission outside of the authorized operating frequency ranges must be lower than the transmitter power (P) by a factor of at least $43 + 10 \log (P)$ dB.	<input checked="" type="checkbox"/>
Test setup	 <p>The diagram shows a Base Station (green box) connected to a Spectrum Analyzer (green box) and an EUT (blue box) via a power divider (black box). The Base Station and Spectrum Analyzer are connected to each other, and the Spectrum Analyzer is connected to the power divider, which then splits the signal to the EUT.</p>		
Procedure	<ul style="list-style-type: none"> - The EUT was connected to Spectrum Analyzer and Base Station via power divider. - The Band Edges of low and high channels for the highest RF powers were measured. Setting RBW as roughly BW/100. 		
Remark			
Result	<input checked="" type="checkbox"/> Pass <input type="checkbox"/> Fail		

Test Data Yes N/A

Test Plot Yes (See below) N/A

LTE Band 2 (Part 24E) result

BW(MHz)	Channel	Frequency (MHz)	Mode	Emission (dBm)	Limit (dBm)
1.4	18607	1850.7	16QAM	-23.26	-13
			QPSK	-22.38	-13
1.4	18900	1909.3	16QAM	-19.01	-13
			QPSK	-17.56	-13
3	18615	1851.5	16QAM	-23.23	-13
			QPSK	-24.67	-13
3	19185	1908.5	16QAM	-17.32	-13
			QPSK	-20.03	-13
5	18625	1852.5	16QAM	-16.93	-13
			QPSK	-19.02	-13
5	19175	1907.5	16QAM	-22.41	-13
			QPSK	-15.98	-13
10	18650	1855	16QAM	-18.84	-13
			QPSK	-18.41	-13
10	19150	1905	16QAM	-24.00	-13
			QPSK	-16.92	-13
15	18675	1857.5	16QAM	-22.33	-13
			QPSK	-20.49	-13
15	19125	1902.5	16QAM	-19.37	-13
			QPSK	-19.56	-13
20	18700	1860	16QAM	-20.91	-13
			QPSK	-24.59	-13
20	19100	1900	16QAM	-19.44	-13
			QPSK	-16.02	-13

LTE Band 4 (Part 27) result

BW(MHz)	Channel	Frequency (MHz)	Mode	Emission (dBm)	Limit (dBm)
1.4	19957	1710.7	16QAM	-24.09	-13
			QPSK	-23.59	-13
1.4	20393	1754.3	16QAM	-26.80	-13
			QPSK	-29.17	-13
3	19965	1711.5	16QAM	-22.42	-13
			QPSK	-23.65	-13
3	20385	1753.5	16QAM	-20.31	-13
			QPSK	-20.39	-13
5	19975	1712.5	16QAM	-19.66	-13
			QPSK	-19.99	-13
5	20375	1752.5	16QAM	-29.26	-13
			QPSK	-27.46	-13
10	20000	1715	16QAM	-24.28	-13
			QPSK	-23.81	-13
10	20350	1750	16QAM	-24.28	-13
			QPSK	-29.94	-13
15	20025	1717.5	16QAM	-21.26	-13
			QPSK	-20.42	-13
15	20325	1747.5	16QAM	-23.29	-13
			QPSK	-24.94	-13
20	20050	1720	16QAM	-25.56	-13
			QPSK	-26.51	-13
20	20300	1745	16QAM	-29.00	-13
			QPSK	-28.23	-13

LTE Band 5 (Part 22H) result

BW(MHz)	Channel	Frequency (MHz)	Mode	Emission (dBm)	Limit (dBm)
1.4	20407	824.7	16QAM	-29.19	-13
			QPSK	-28.80	-13
1.4	20643	848.3	16QAM	-31.25	-13
			QPSK	-31.41	-13
3	20415	825.5	16QAM	-19.99	-13
			QPSK	-21.12	-13
3	20635	847.5	16QAM	-32.27	-13
			QPSK	-29.74	-13
5	20425	826.5	16QAM	-18.43	-13
			QPSK	-19.08	-13
5	20625	846.5	16QAM	-29.42	-13
			QPSK	-30.16	-13
10	20450	829	16QAM	-20.36	-13
			QPSK	-20.03	-13
10	20800	844	16QAM	-19.53	-13
			QPSK	-20.17	-13

LTE Band 12 (Part 27) result

BW(MHz)	Channel	Frequency (MHz)	Mode	Emission (dBm)	Limit (dBm)
1.4	23017	699.7	QPSK	-21.26	-13
			16QAM	-21.01	-13
1.4	23173	715.3	QPSK	-23.38	-13
			16QAM	-23.44	-13
3	23025	700.5	QPSK	-20.82	-13
			16QAM	-16.82	-13
3	23165	714.5	QPSK	-20.58	-13
			16QAM	-20.98	-13
5	23035	701.5	QPSK	-16.29	-13
			16QAM	-15.18	-13
5	23155	713.5	QPSK	-19.89	-13
			16QAM	-19.85	-13
10	23060	704	QPSK	-17.55	-13
			16QAM	-17.38	-13
10	23130	711	QPSK	-23.10	-13
			16QAM	-23.54	-13

LTE Band 17 (Part 27) result

BW(MHz)	Channel	Frequency (MHz)	Mode	Emission (dBm)	Limit (dBm)
5	23755	706.5	16QAM	-16.13	-13
			QPSK	-16.37	-13
5	23825	713.5	16QAM	-16.96	-13
			QPSK	-16.16	-13
10	23780	709	16QAM	-16.51	-13
			QPSK	-18.56	-13
10	23800	711	16QAM	-15.88	-13
			QPSK	-15.78	-13

Test Plots

LTE Band 2 (Part 24E)

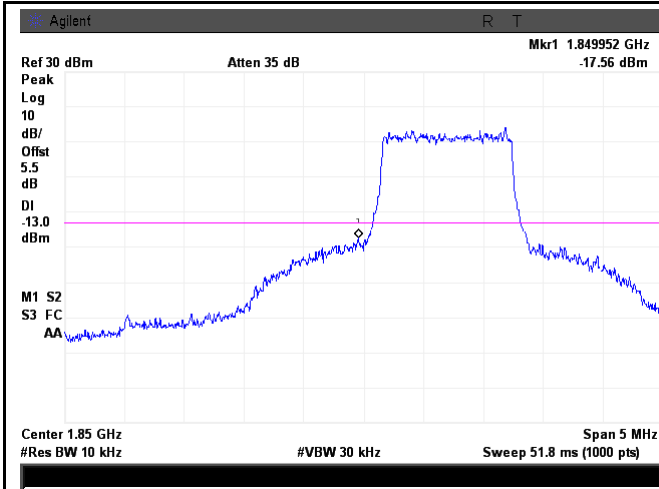

LTE Band 2 - Low Channel QPSK-1.4

Note: Offset=Cable loss (4.5) + 10log
 (12.77/10)=4.5+1.0=5.5 dB

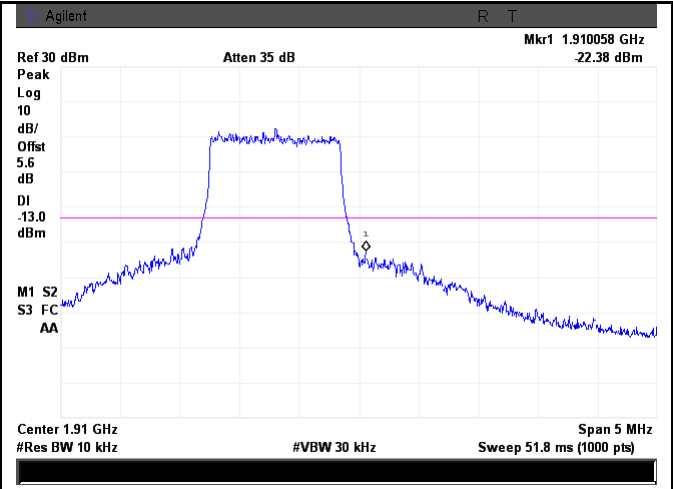

LTE Band 2 - High Channel QPSK-1.4

Note: Offset=Cable loss (4.5) + 10log
 (12.82/10)=4.5+1.1=5.6dB

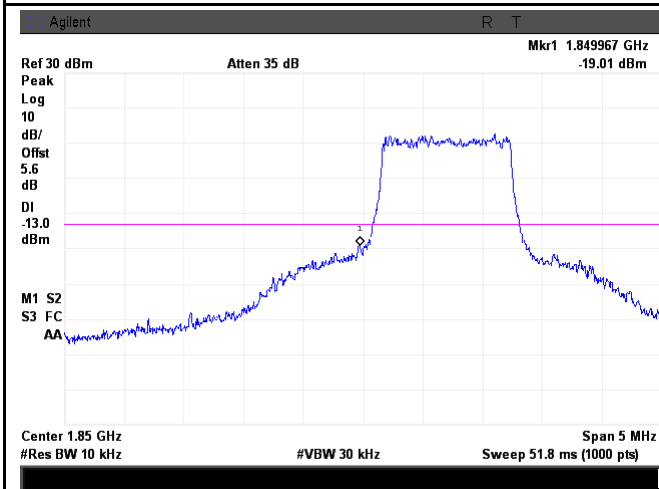

LTE Band 2 - Low Channel 16QAM-1.4

Note: Offset=Cable loss (4.5) + 10log
 (12.77/10)=4.5+1.1=5.1 dB

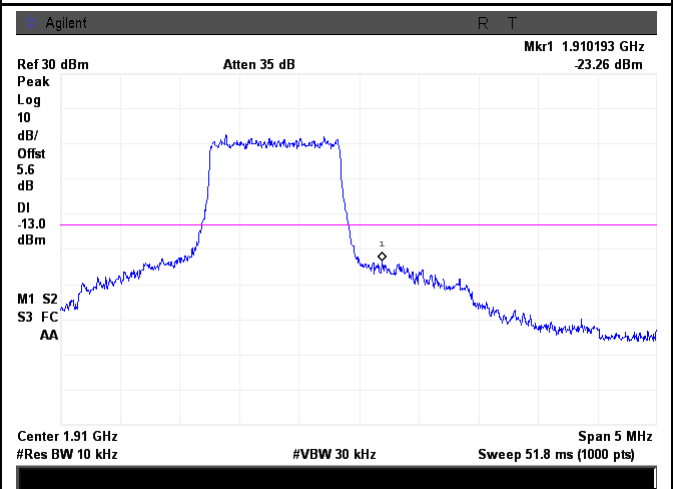

LTE Band 2 - High Channel 16QAM-1.4

Note: Offset=Cable loss (4.5) + 10log
 (12.74/10)=4.5+1.1=5.1dB

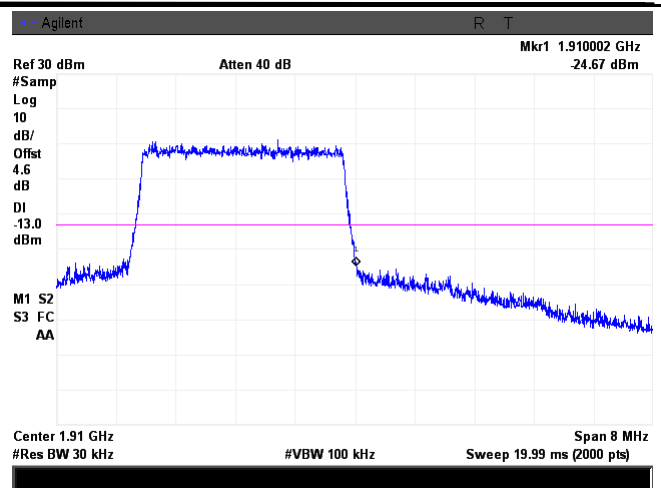
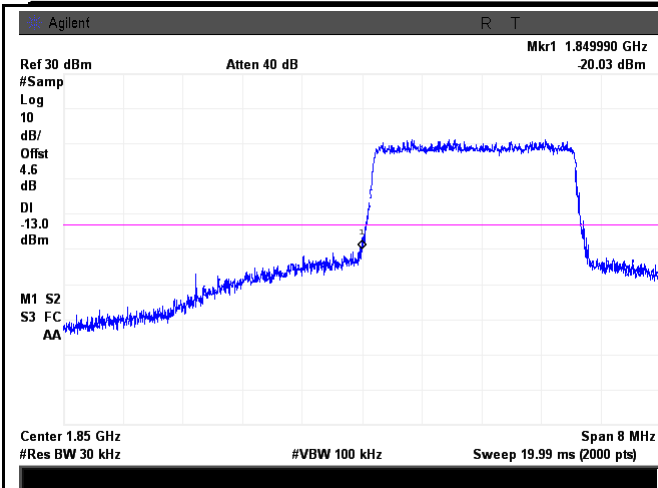

LTE Band 2 - Low Channel QPSK-3

LTE Band 2 - High Channel QPSK-3

Note: Offset=Cable loss (4.5) + 10log
(31.02/30)=4.5+0.1=4.6 dB

Note: Offset=Cable loss (4.5) + 10log
(30.76/30)=4.5+0.1=4.6 dB

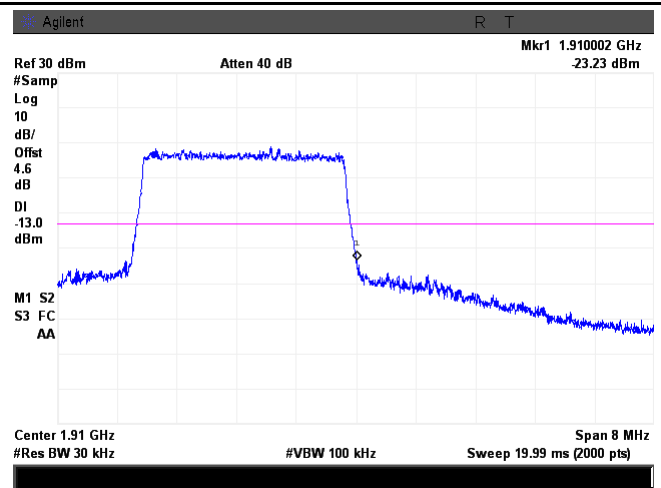
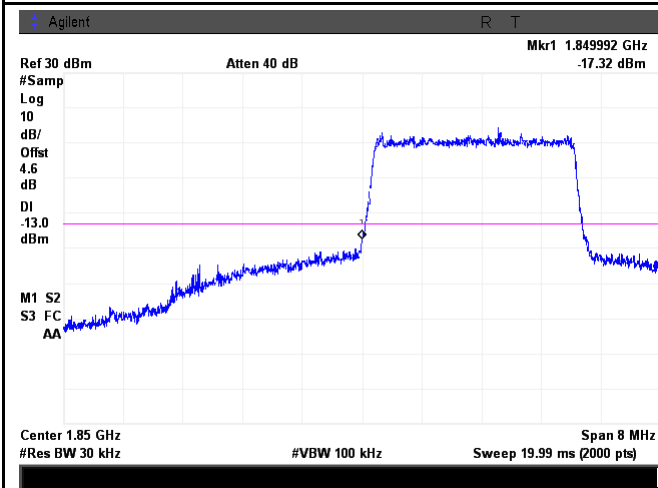

LTE Band 2 - Low Channel 16QAM-3

LTE Band 2 - High Channel 16QAM-3

Note: Offset=Cable loss (4.5) + 10log
(30.70/30)=4.5+0.1=4.6 dB

Note: Offset=Cable loss (4.5) + 10log
(30.61/30)=4.5+0.1=4.6 dB

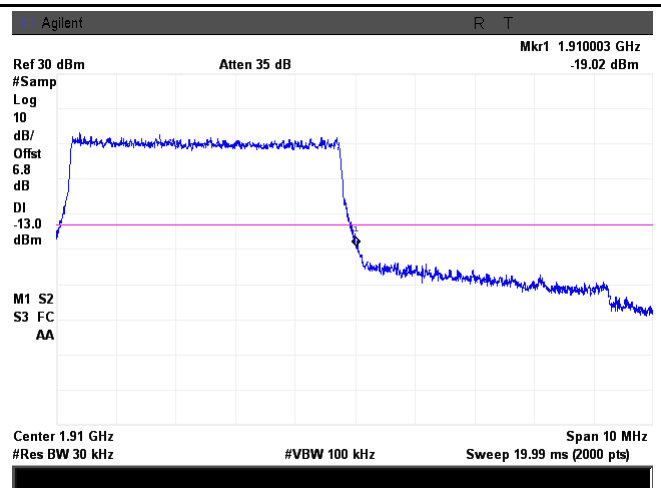
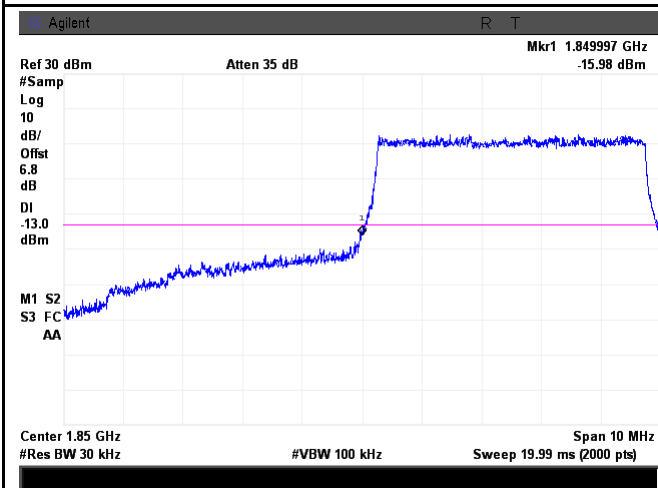

LTE Band 2 - Low Channel QPSK-5

LTE Band 2 - High Channel QPSK-5

Note: Offset=Cable loss (4.5) + 10log
(50.85/30)=4.5+2.3=6.8 dB

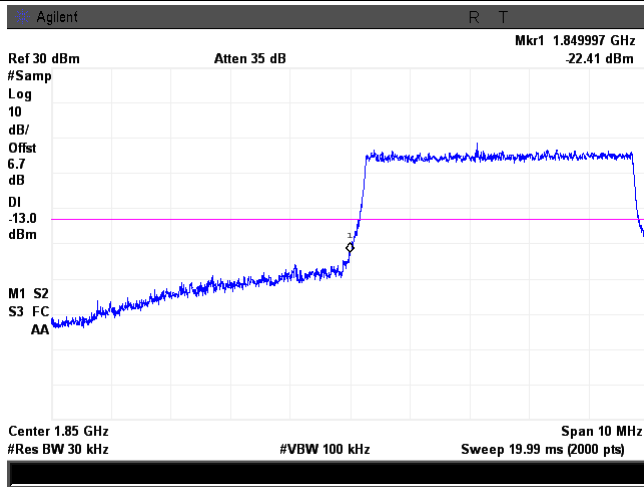

LTE Band 2 - Low Channel 16QAM-5

Note: Offset=Cable loss (4.5) + 10log
(50.97/30)=4.5+2.3=6.8 dB

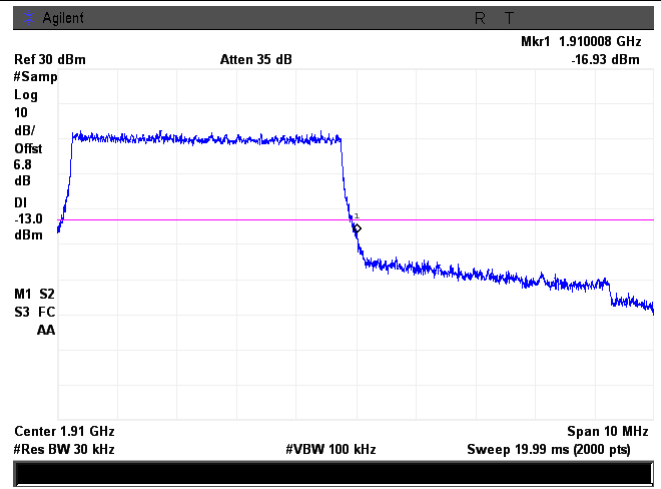

LTE Band 2 - High Channel 16QAM-5

Note: Offset=Cable loss (4.5) + 10log
(50.17/30)=4.5+2.2=6.7 dB

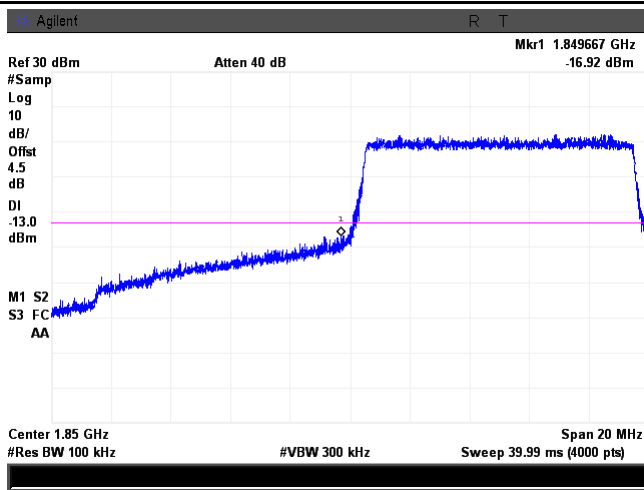

LTE Band 2 - Low Channel QPSK-10

Note: Offset=Cable loss (4.5) + 10log
(50.87/30)=4.5+2.3=6.8 dB

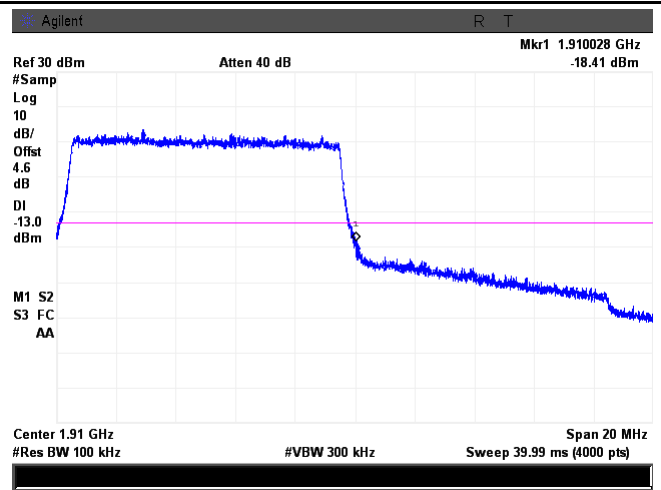

LTE Band 2 - High Channel QPSK-10

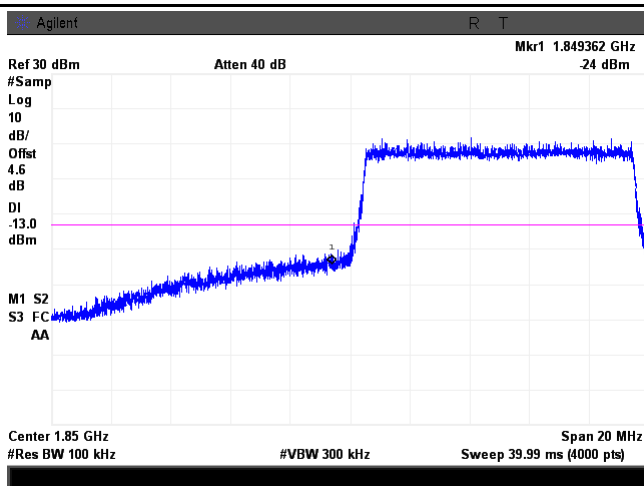

LTE Band 2 - Low Channel 16QAM-10

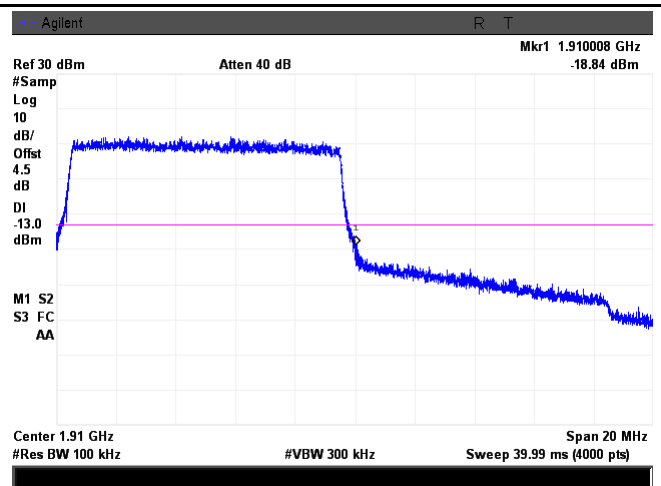

LTE Band 2 - High Channel 16QAM-10

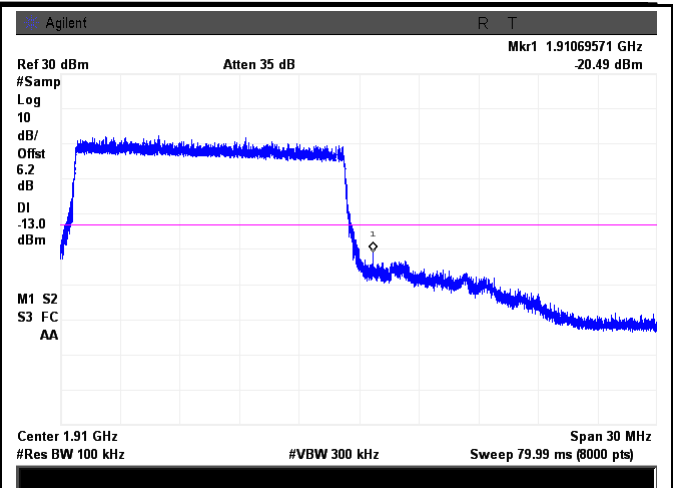
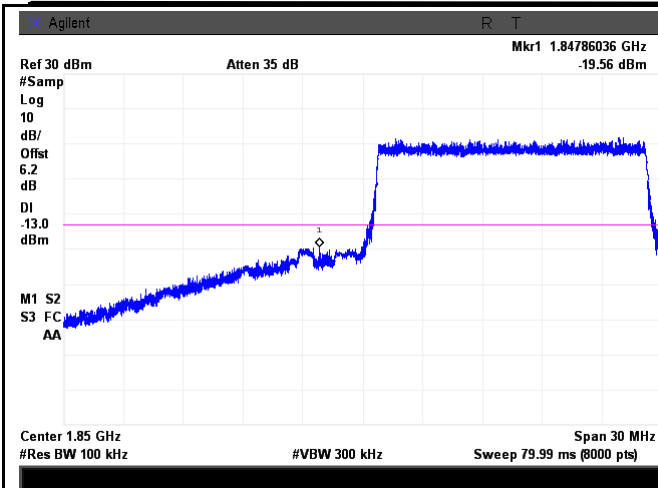

LTE Band 2 - Low Channel QPSK-15

LTE Band 2 - High Channel QPSK-15

Note: Offset=Cable loss (4.5) + 10log
(148.5/100)=4.5+1.7=6.2dB

Note: Offset=Cable loss (4.5) + 10log
(147.7/100)=4.5+1.7=6.2 dB

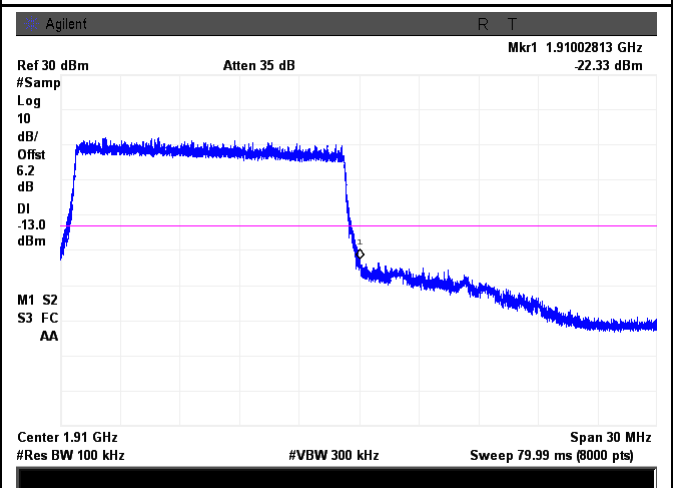
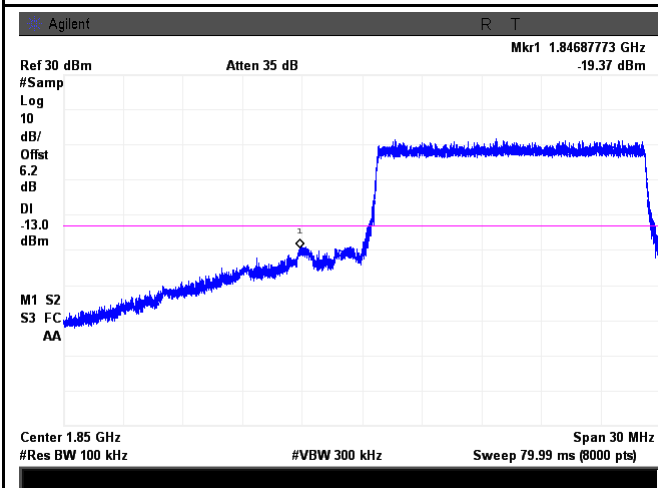

LTE Band 2 - Low Channel 16QAM-15

LTE Band 2 - High Channel 16QAM-15

Note: Offset=Cable loss (4.5) + 10log
(149.1/100)=4.5+1.7=6.2 dB

Note: Offset=Cable loss (4.5) + 10log
(148.2/100)=4.5+1.7=6.2 dB

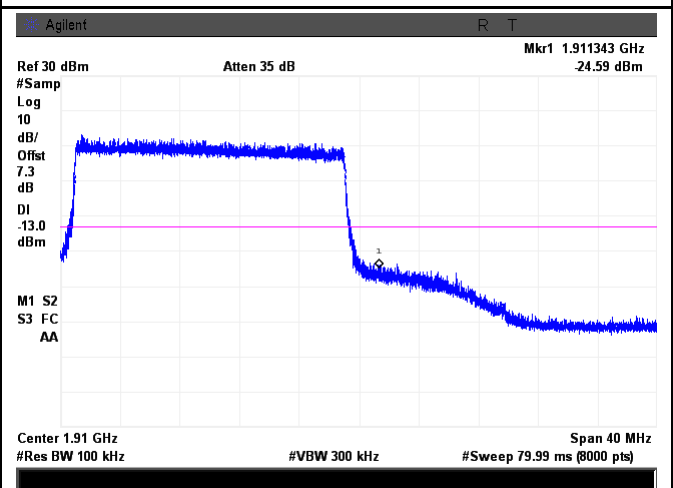
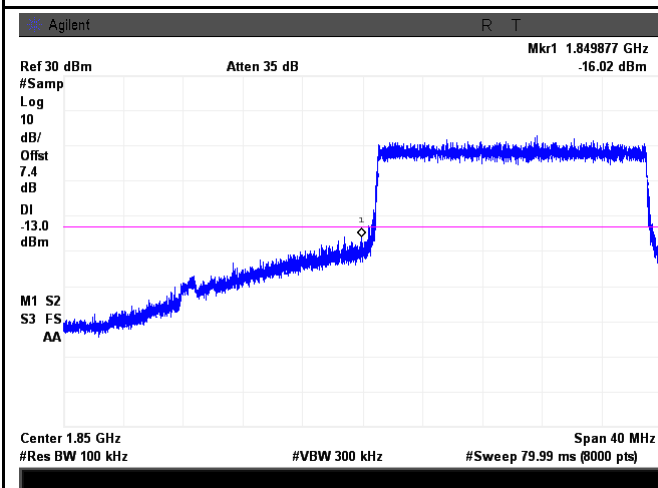

LTE Band 2 - Low Channel QPSK-20

LTE Band 2 - High Channel QPSK-20

Note: Offset=Cable loss (4.5) + 10log
 (193.5/100)=4.5+2.9=7.4dB

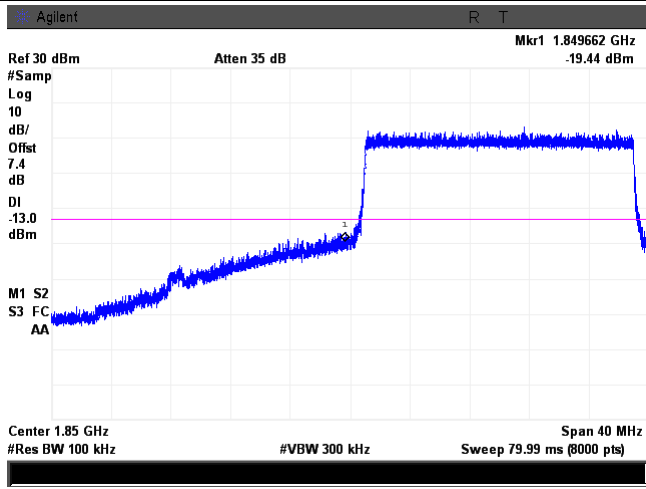

LTE Band 2 - Low Channel 16QAM-20

Note: Offset=Cable loss (4.5) + 10log
 (193.8/100)=4.5+2.9=7.4 dB

Note: Offset=Cable loss (4.5) + 10log
 (192.1/100)=4.5+2.8=7.3 dB

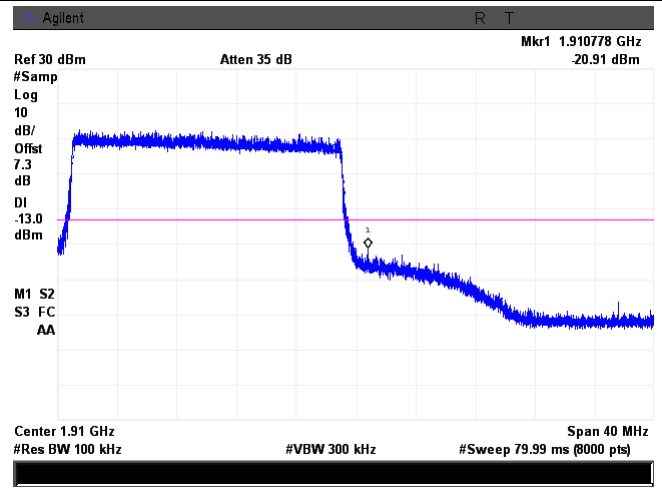

LTE Band 2 - High Channel 16QAM-20

Note: Offset=Cable loss (4.5) + 10log
 (190.7/100)=4.5+2.8=7.3 dB

LTE Band 4 (Part 27)

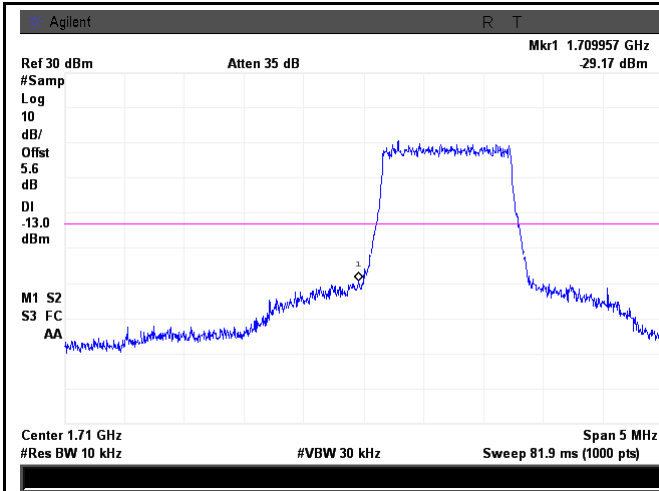

LTE Band 4 - Low Channel QPSK-1.4

Note: Offset=Cable loss (4.5) + 10log
(12.97/10)=4.5+1.1=5.6 dB

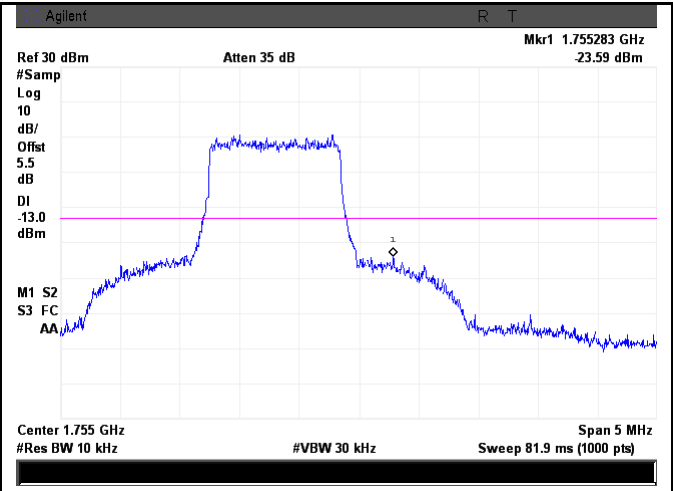

LTE Band 4 - High Channel QPSK-1.4

Note: Offset=Cable loss (4.5) + 10log
(12.69/10)=4.5+1.0=5.5 dB

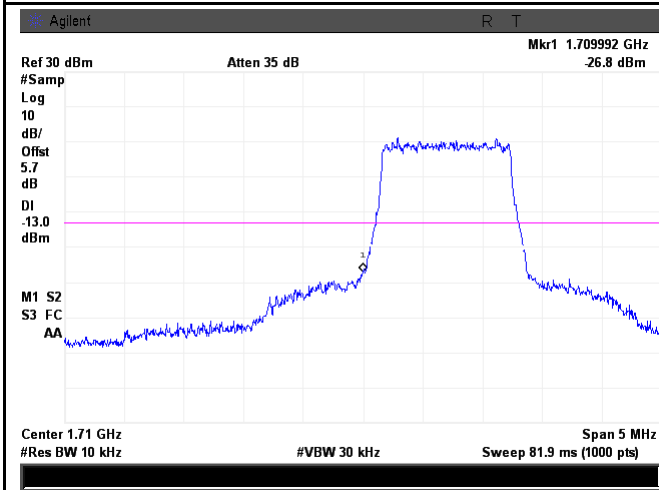

LTE Band 4 - Low Channel 16QAM-1.4

Note: Offset=Cable loss (4.5) + 10log
(13.06/10)=4.5+1.2=5.7 dB

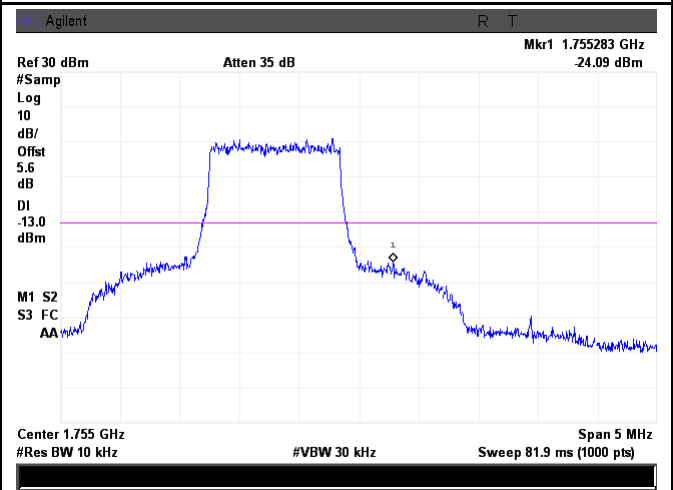

LTE Band 4 - High Channel 16QAM-1.4

Note: Offset=Cable loss (4.5) + 10log
(12.85/10)=4.5+1.1=5.6 dB

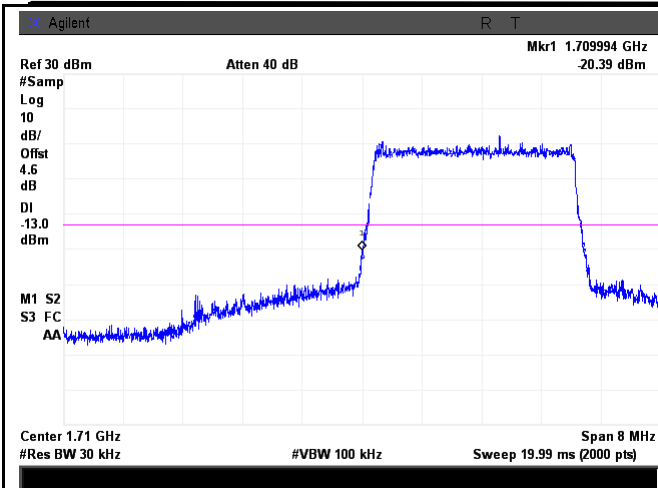

LTE Band 4 - Low Channel QPSK-3

Note: Offset=Cable loss (4.5) + 10log
(30.79/30)=4.5+0.1=4.6 dB

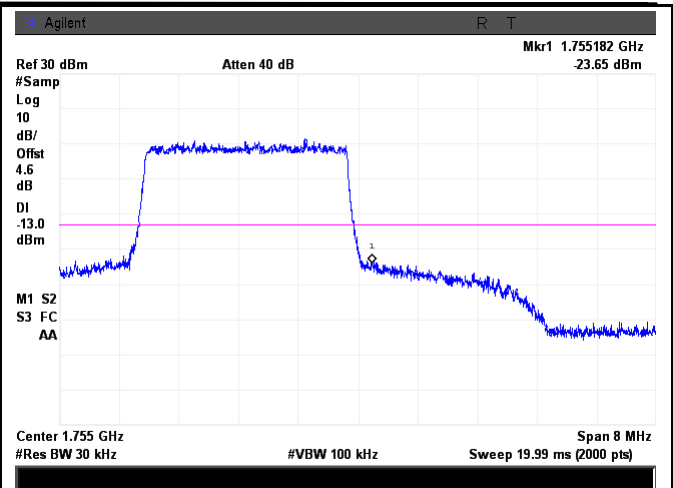

LTE Band 4 - High Channel QPSK-3

Note: Offset=Cable loss (4.5) + 10log
(30.63/30)=4.5+0.1=4.6 dB

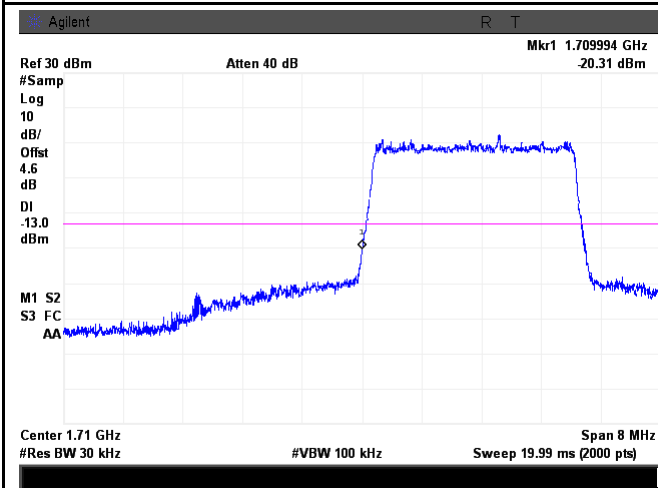

LTE Band 4 - Low Channel 16QAM-3

Note: Offset=Cable loss (4.5) + 10log
(30.38/30)=4.5+0.1=4.6 dB

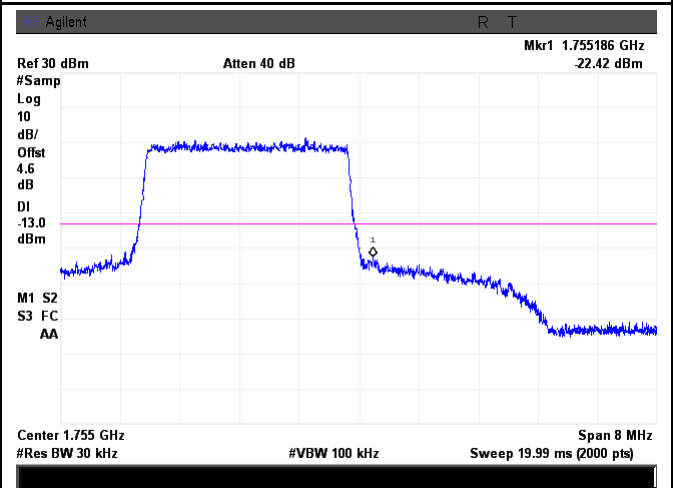

LTE Band 4 - High Channel 16QAM-3

Note: Offset=Cable loss (4.5) + 10log
(30.63/30)=4.5+0.1=4.6 dB

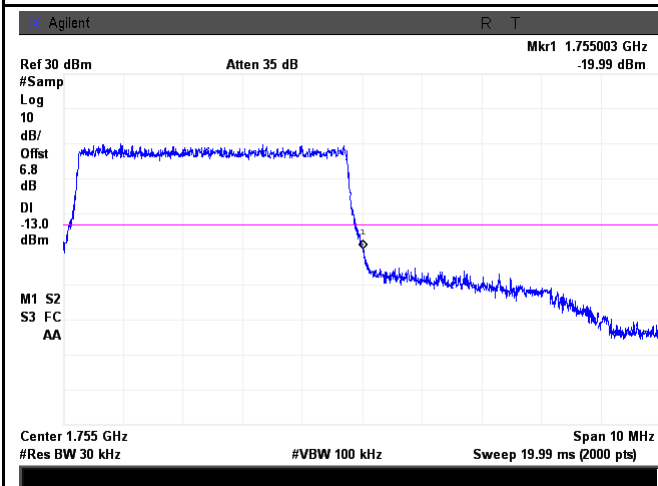

LTE Band 4 - Low Channel QPSK-5

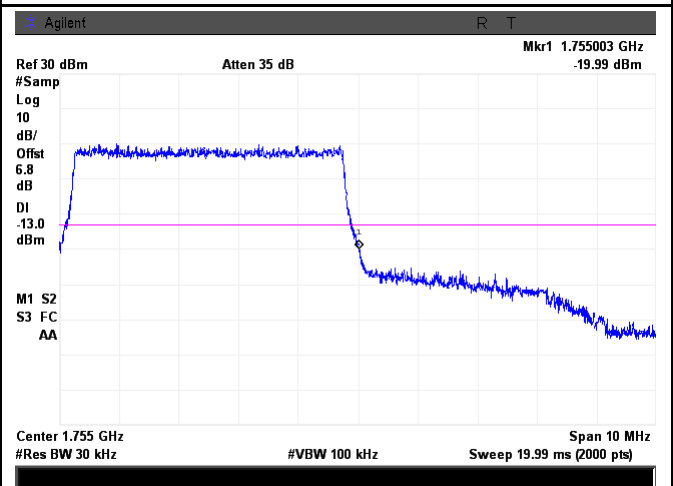

LTE Band 4 - High Channel QPSK-5

Note: Offset=Cable loss (4.5) + 10log
(49.79/30)=4.5+2.3=6.8 dB

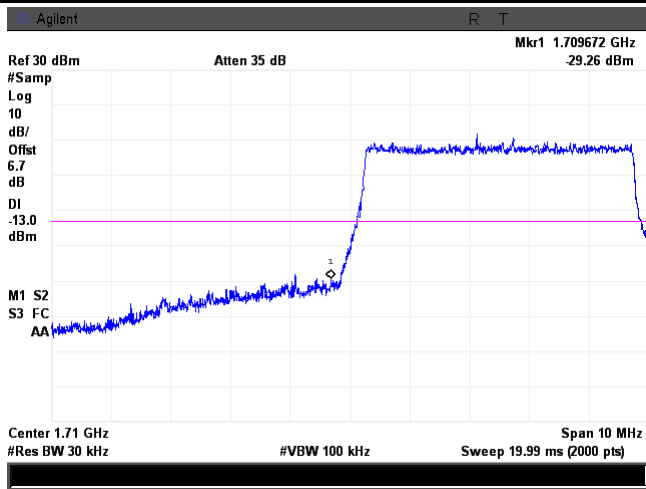

LTE Band 4 - Low Channel 16QAM-5

Note: Offset=Cable loss (4.5) + 10log
(50.66/30)=4.5+2.3=6.8 dB

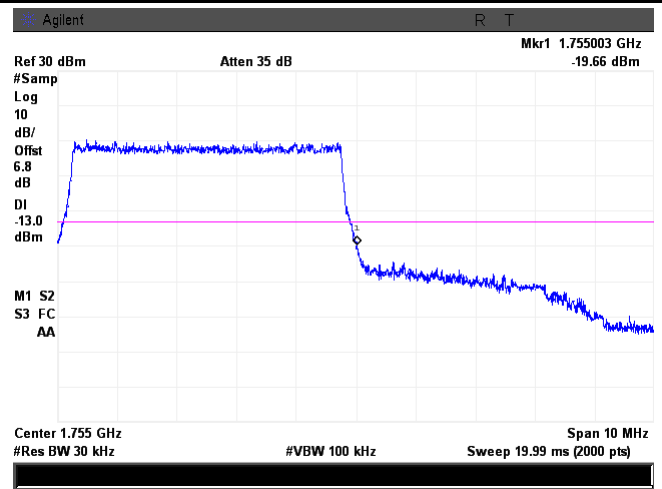

LTE Band 4 - High Channel 16QAM-5

Note: Offset=Cable loss (4.5) + 10log
(50.28/30)=4.5+2.2=6.7dB

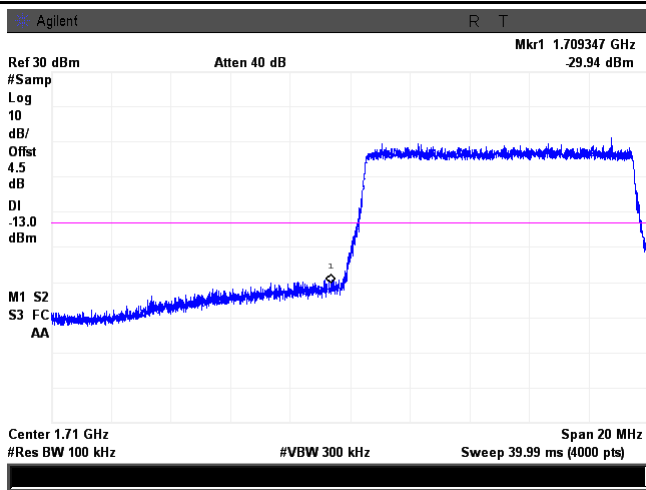

LTE Band 4 - Low Channel QPSK-10

Note: Offset=Cable loss (4.5) + 10log
(50.38/30)=4.5+2.3=6.8 dB

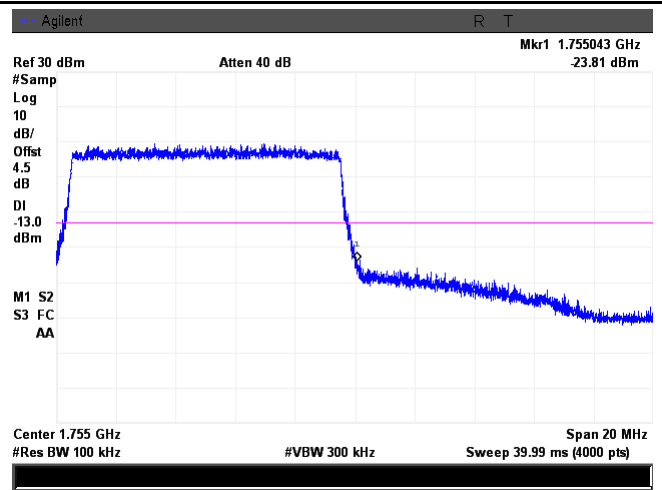

LTE Band 4 - High Channel QPSK-10

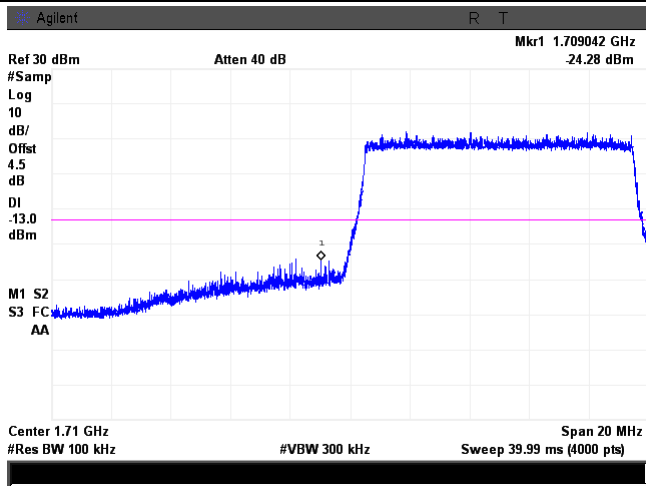

LTE Band 4 - Low Channel 16QAM-10

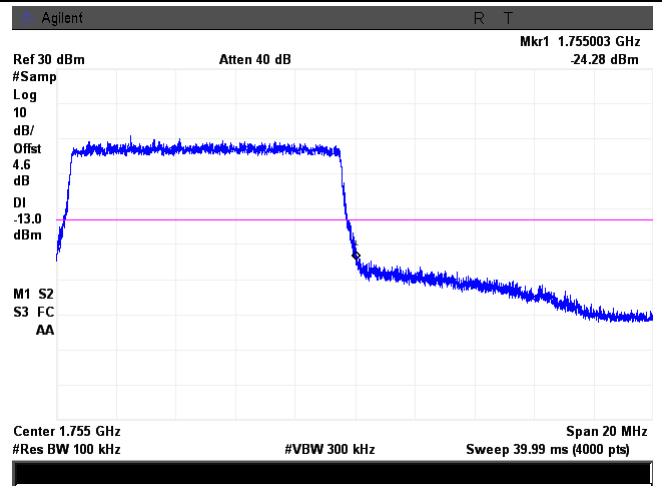

LTE Band 4 - High Channel 16QAM-10

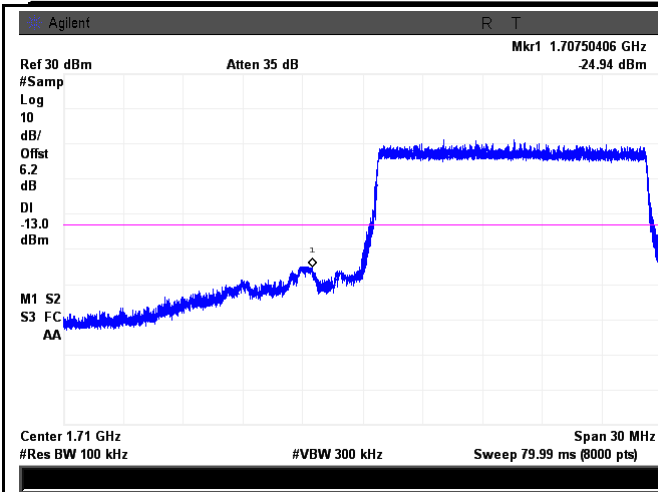

LTE Band 4 - Low Channel QPSK-15

Note: Offset=Cable loss (4.5) + 10log
(147.2/100)=4.5+1.7=6.2 dB

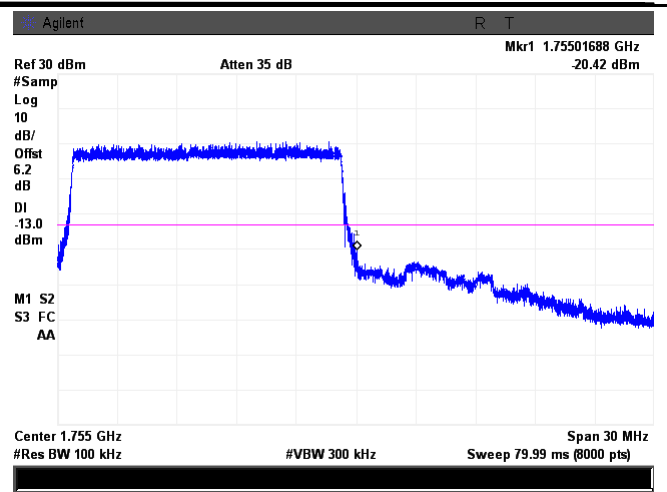

LTE Band 4 - High Channel QPSK-15

Note: Offset=Cable loss (4.5) + 10log
(146.3/100)=4.5+1.7=6.2 dB

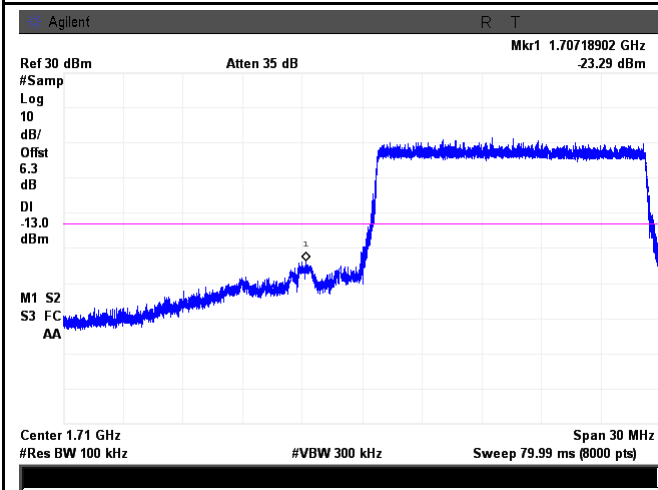

LTE Band 4 - Low Channel 16QAM-15

Note: Offset=Cable loss (4.5) + 10log
(149.9/100)=4.5+1.8=6.3 dB

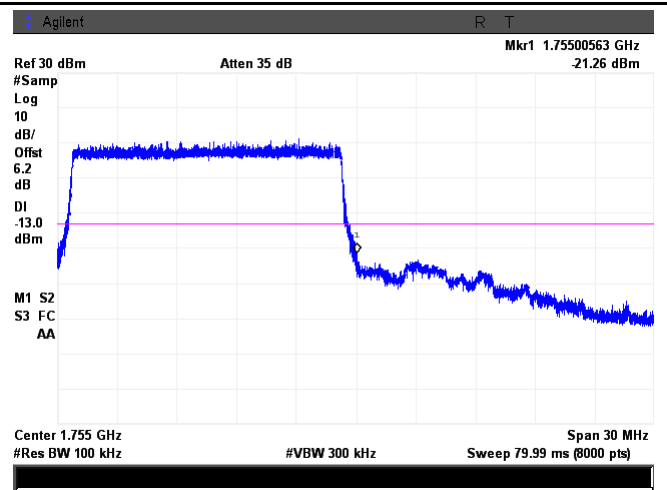

LTE Band 4 - High Channel 16QAM-15

Note: Offset=Cable loss (4.5) + 10log
(147.8/100)=4.5+1.7=6.2 dB

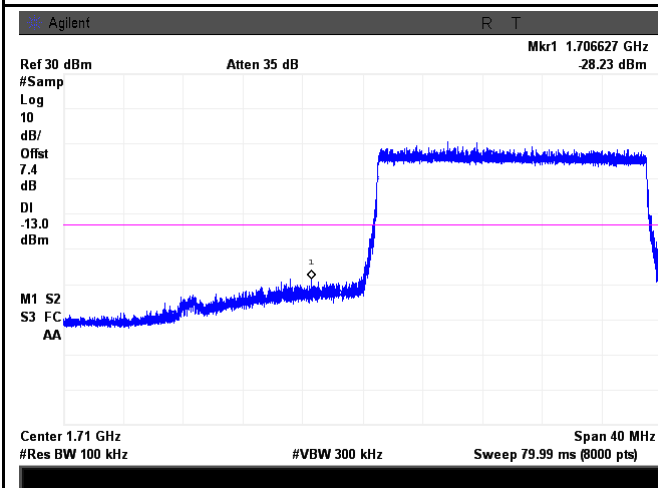

LTE Band 4 - Low Channel QPSK-20

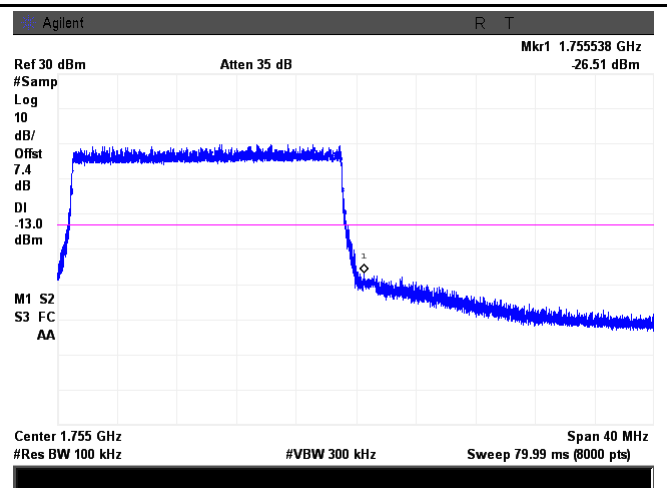

LTE Band 4 - High Channel QPSK-20

Note: Offset=Cable loss (4.5) + 10log
 (193.4/100)=4.5+2.9=7.4 dB

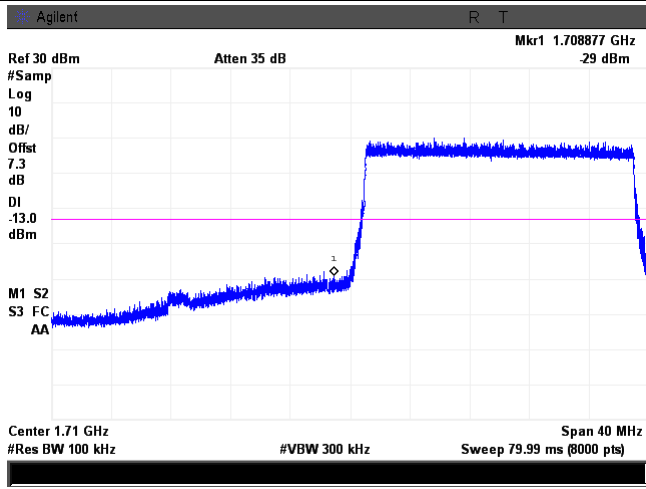

LTE Band 4 - Low Channel 16QAM-20

Note: Offset=Cable loss (4.5) + 10log
 (191.0/100)=4.5+2.8=7.30dB

Note: Offset=Cable loss (4.5) + 10log
 (193.0/100)=4.5+2.9=7.4 dB

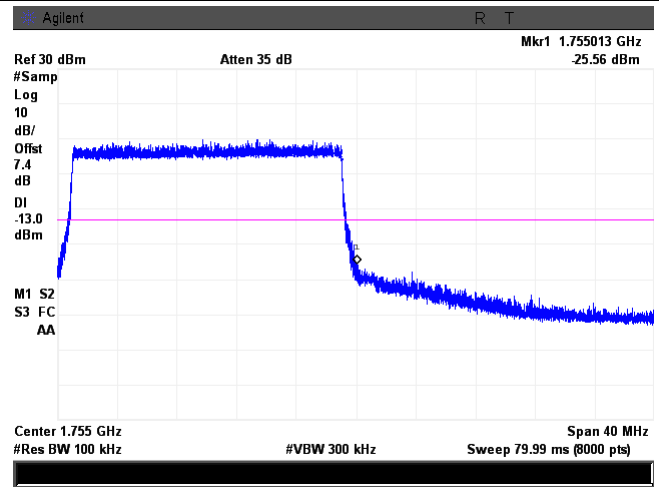

LTE Band 4 - High Channel 16QAM-20

Note: Offset=Cable loss (4.5) + 10log
 (193.7/100)=4.5+2.9=7.4 dB

LTE Band 5 (Part 22H)

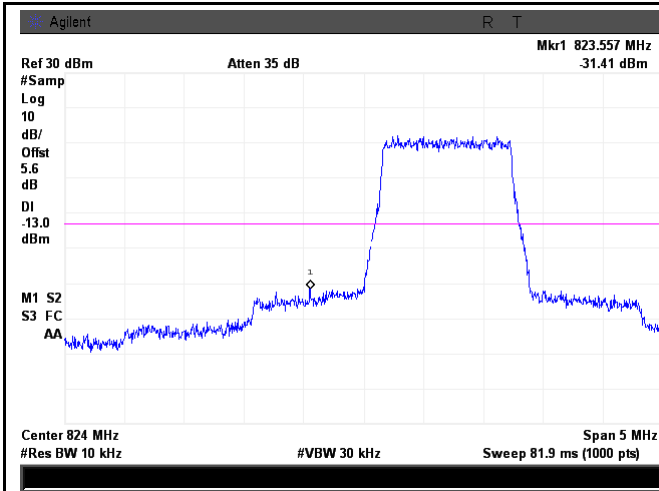

LTE Band 5 - Low Channel QPSK-1.4

Note: Offset=Cable loss (4.5) + 10log
(12.89/10)=4.5+1.1=5.6 dB

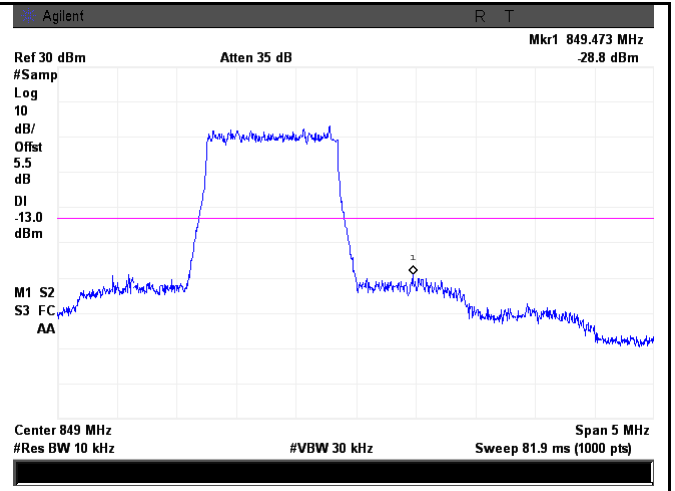

LTE Band 5 - High Channel QPSK-1.4

Note: Offset=Cable loss (4.5) + 10log
(12.57/10)=4.5+1.0=5.5 dB

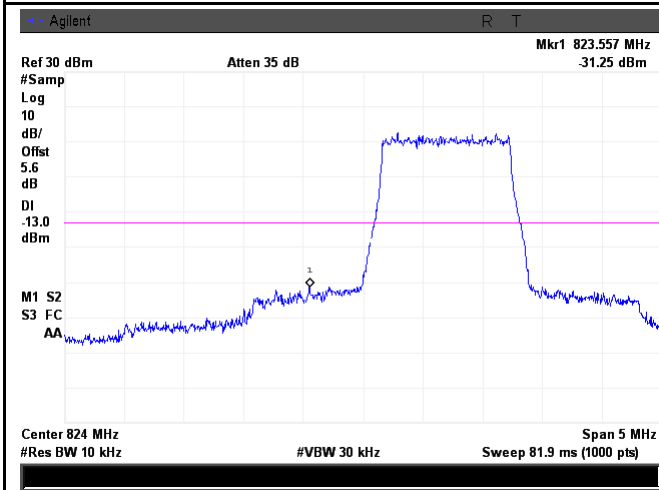

LTE Band 5 - Low Channel 16QAM-1.4

Note: Offset=Cable loss (4.5) + 10log
(12.76/10)=4.5+1.1=5.6 dB

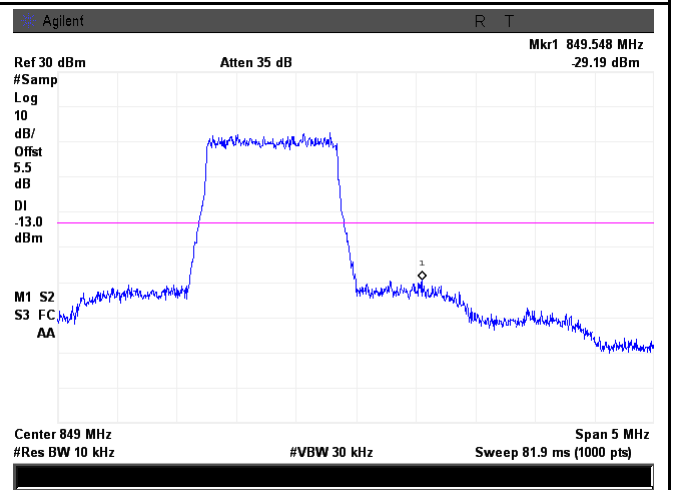

LTE Band 5 - High Channel 16QAM-1.4

Note: Offset=Cable loss (4.5) + 10log
(12.67/10)=4.5+1.0=5.5 dB

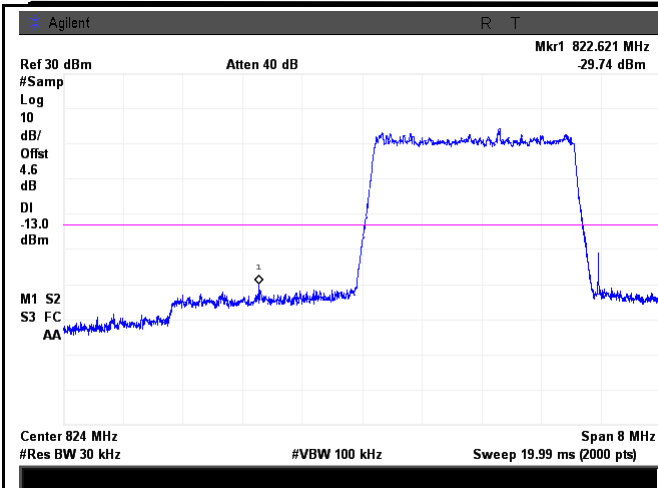

LTE Band 5 - Low Channel QPSK-3

Note: Offset=Cable loss (4.5) + 10log
(31.02/30)=4.5+0.1=4.6 dB

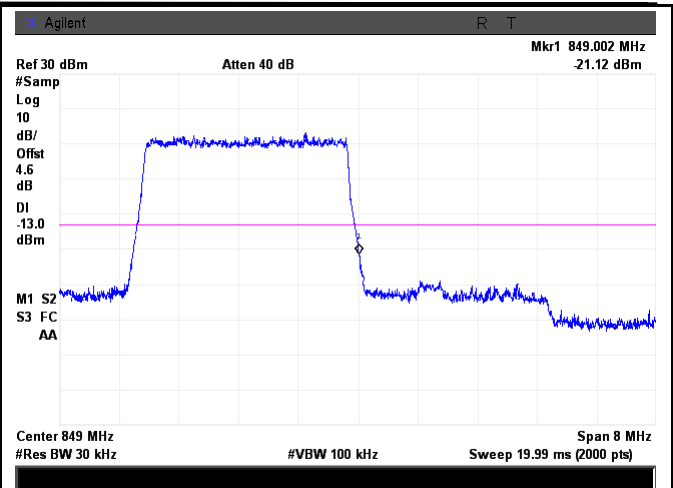

LTE Band 5 - High Channel QPSK-3

Note: Offset=Cable loss (4.5) + 10log
(30.87/30)=4.5+0.1=4.6 dB

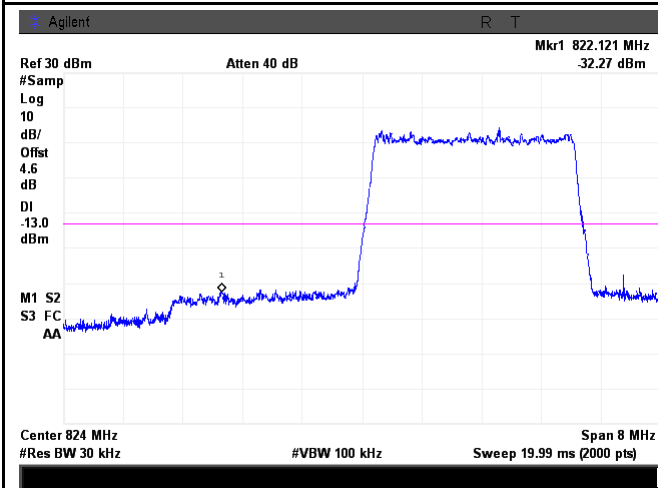

LTE Band 5 - Low Channel 16QAM-3

Note: Offset=Cable loss (4.5) + 10log
(31.04/30)=4.5+0.1=4.6 dB

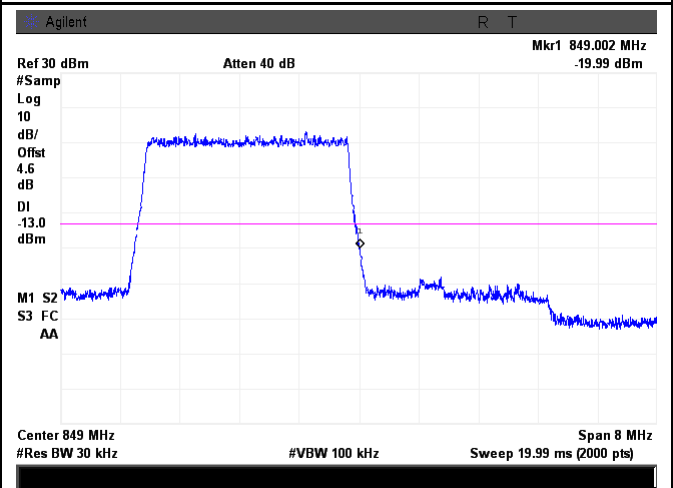

LTE Band 5 - High Channel 16QAM-3

Note: Offset=Cable loss (4.5) + 10log
(30.73/30)=4.5+0.1=4.6 dB

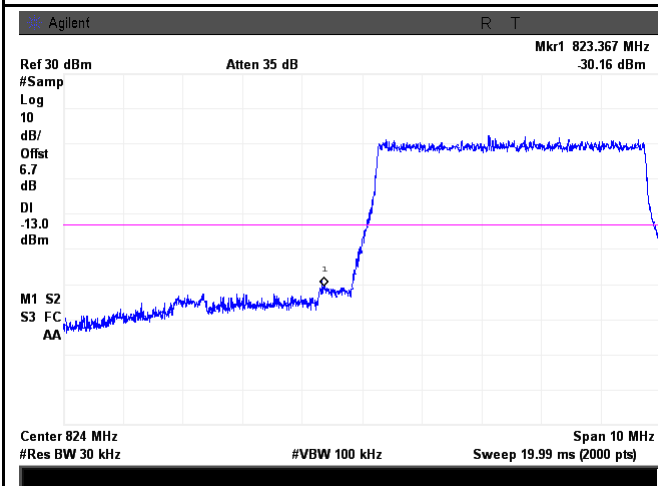

LTE Band 5 - Low Channel QPSK-5

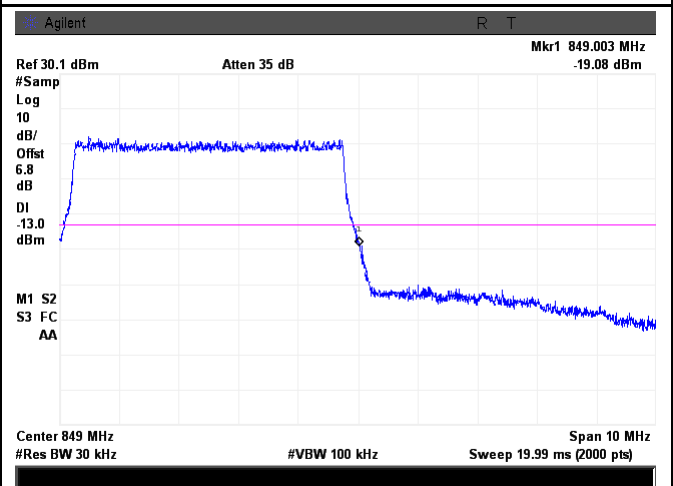

LTE Band 5 - High Channel QPSK-5

Note: Offset=Cable loss (4.5) + 10log
(50.24/30)=4.5+2.2=6.7 dB

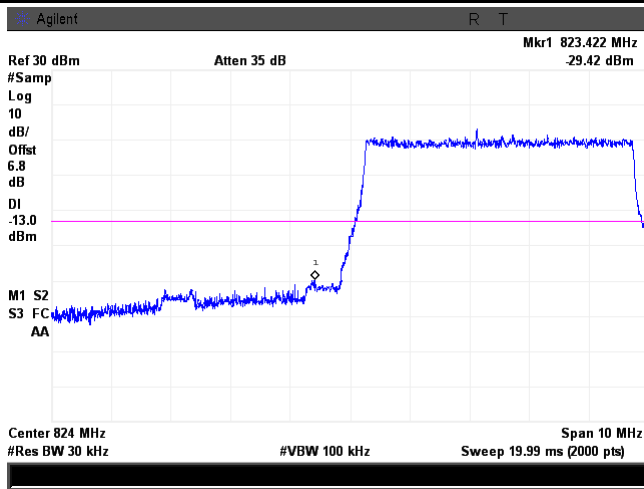

LTE Band 5 - Low Channel 16QAM-5

Note: Offset=Cable loss (4.5) + 10log
(50.52/30)=4.5+2.3=6.8 dB

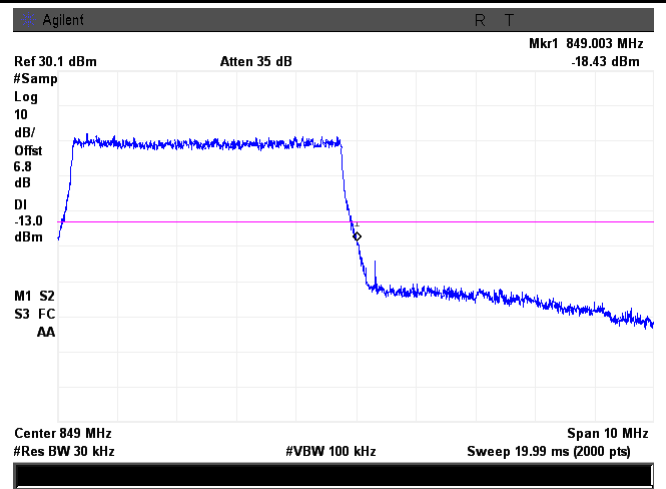

LTE Band 5 - High Channel 16QAM-5

Note: Offset=Cable loss (4.5) + 10log
(50.46/30)=4.5+2.3=6.8 dB

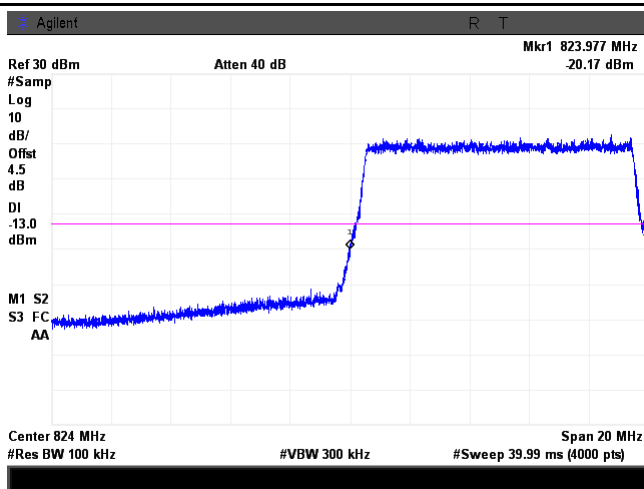

LTE Band 5 - Low Channel QPSK-10

Note: Offset=Cable loss (4.5) + 10log
(50.63/30)=4.5+2.3=6.8 dB

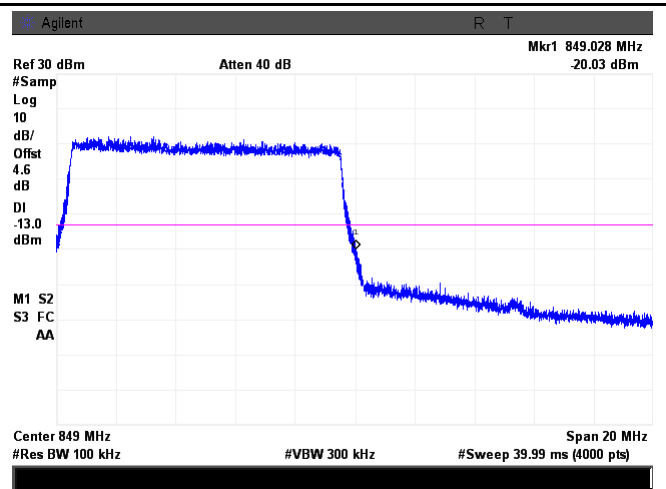

LTE Band 5 - High Channel QPSK-10

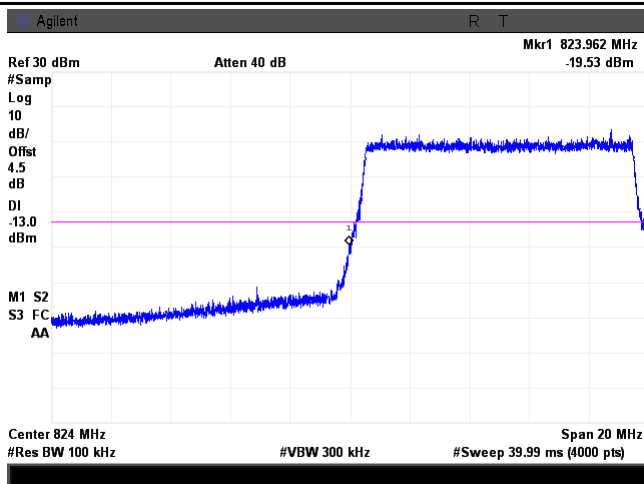

LTE Band 5 - Low Channel 16QAM-10

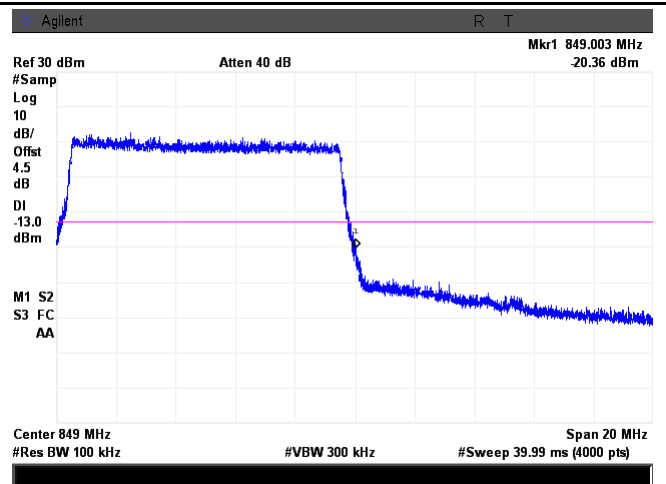

LTE Band 5 - High Channel 16QAM-10

LTE Band 12 (Part 27)

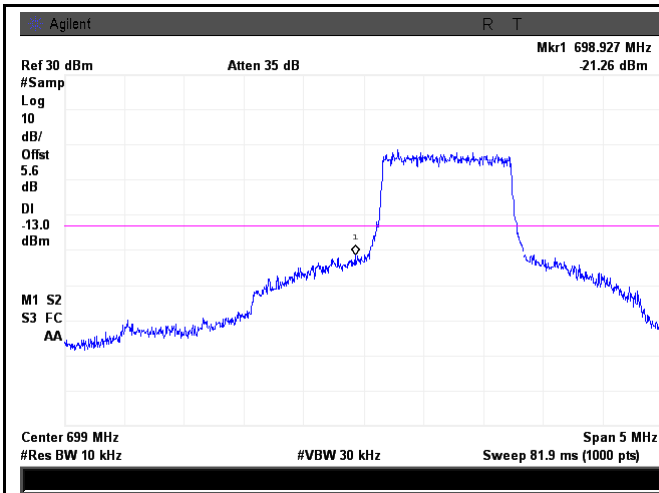

LTE Band 12 - Low Channel QPSK-1.4

Note: Offset=Cable loss (4.5) + 10log
(12.81/10)=4.5+1.1=5.6 dB

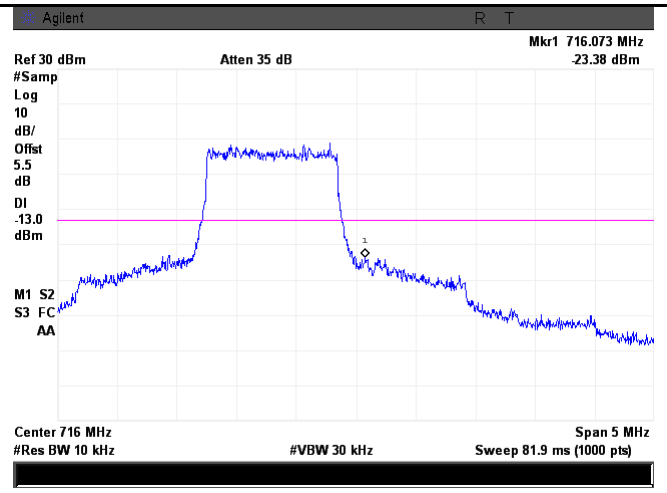

LTE Band 12 - High Channel QPSK-1.4

Note: Offset=Cable loss (4.5) + 10log
(12.68/10)=4.5+1.0=5.5dB

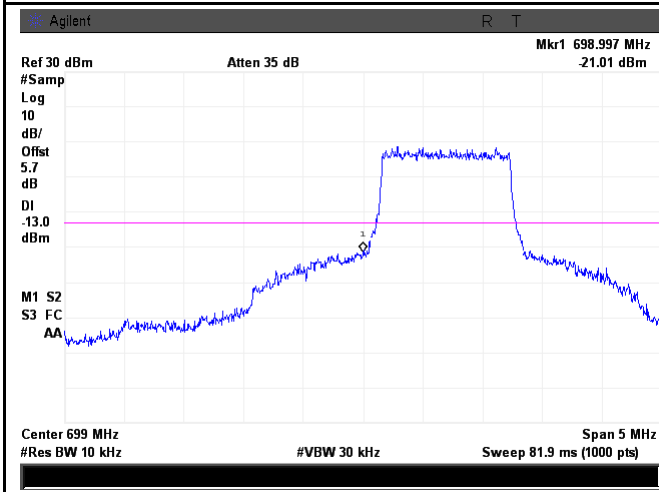

LTE Band 12 - Low Channel 16QAM-1.4

Note: Offset=Cable loss (4.5) + 10log
(13.19/10)=4.5+1.2=5.7 dB

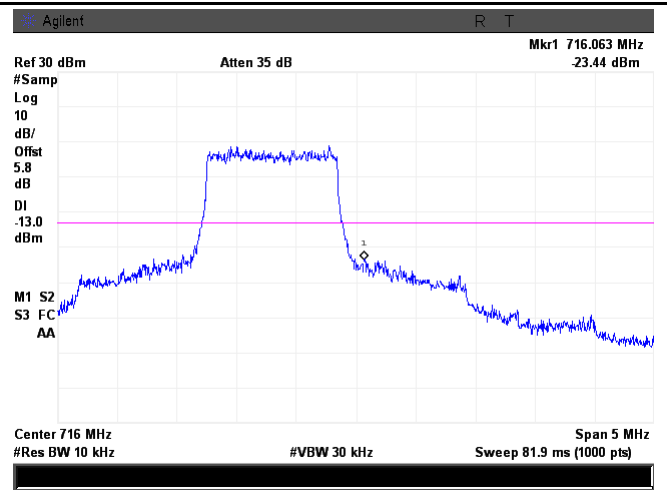

LTE Band 12 - High Channel 16QAM-1.4

Note: Offset=Cable loss (4.5) + 10log
(13.56/10)=4.5+1.3=5.8 dB

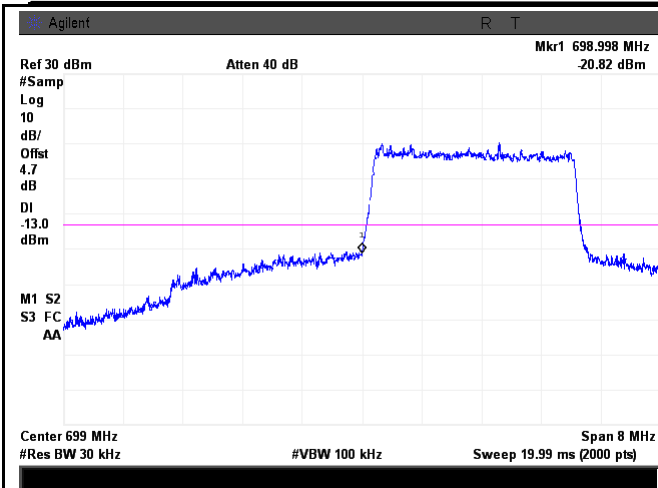

LTE Band 12 - Low Channel QPSK-3

Note: Offset=Cable loss (4.5) + 10log
(31.26/30)=4.5+0.2=4.7 dB

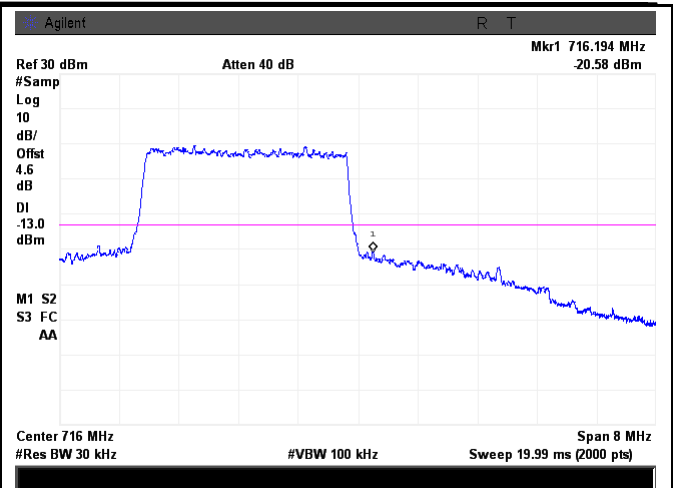

LTE Band 12 - High Channel QPSK-3

Note: Offset=Cable loss (4.5) + 10log
(30.57/30)=4.5+0.1=4.6 dB

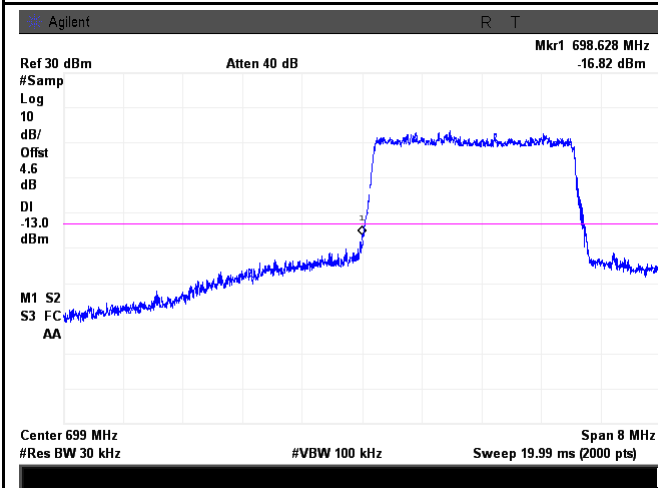

LTE Band 12 - Low Channel 16QAM-3

Note: Offset=Cable loss (4.5) + 10log
(30.71/30)=4.5+0.1=4.6 dB

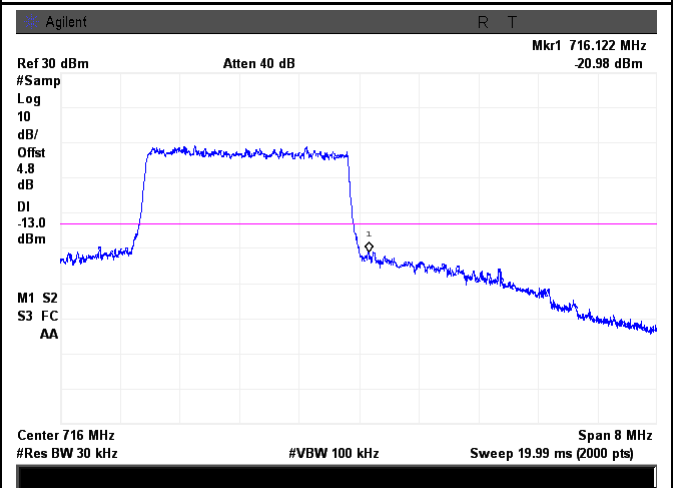

LTE Band 12 - High Channel 16QAM-3

Note: Offset=Cable loss (4.5) + 10log
(31.89/30)=4.5+0.3=4.8 dB

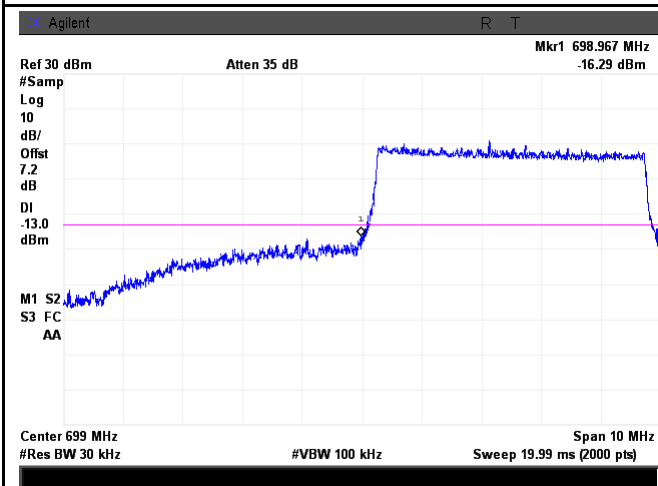

LTE Band 12 - Low Channel QPSK-5

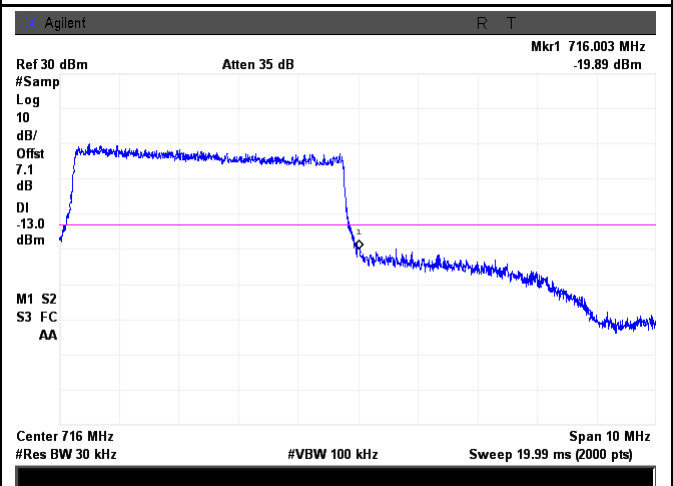

LTE Band 12 - High Channel QPSK-5

Note: Offset=Cable loss (4.5) + 10log
(55.46/30)=4.5+2.7=7.2 dB

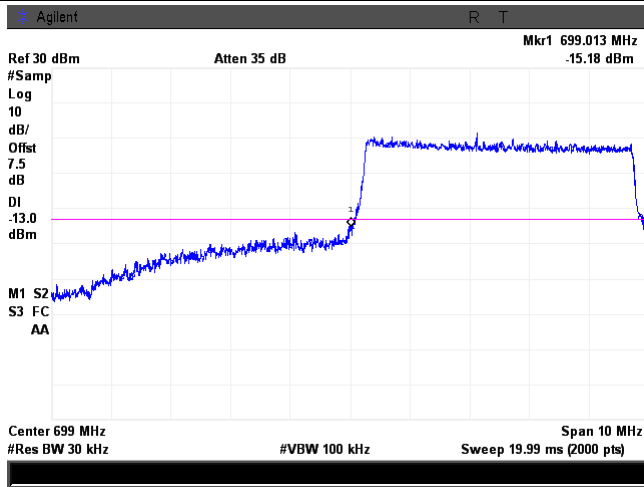

LTE Band 12 - Low Channel 16QAM-5

Note: Offset=Cable loss (4.5) + 10log
(55.14/30)=4.5+2.6=7.1 dB

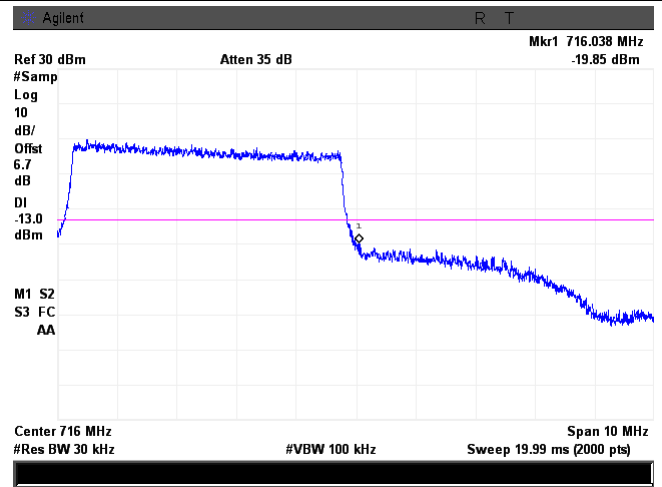

LTE Band 12 - High Channel 16QAM-5

Note: Offset=Cable loss (4.5) + 10log
(60.31/30)=4.5+3.0=7.5 dB

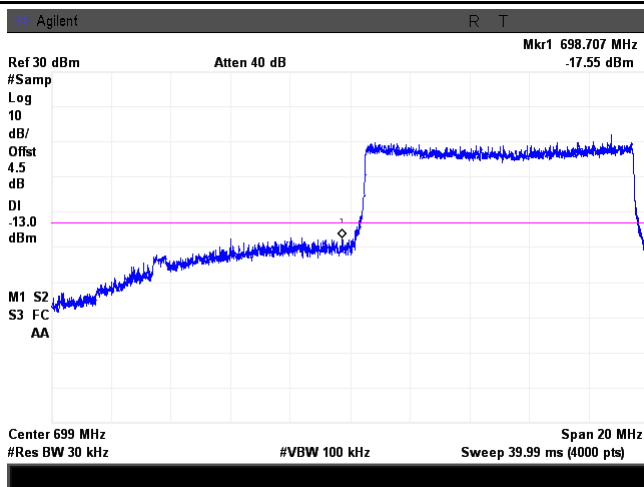

LTE Band 12 - Low Channel QPSK-10

Note: Offset=Cable loss (4.5) + 10log
(50.11/30)=4.5+2.2=6.7 dB

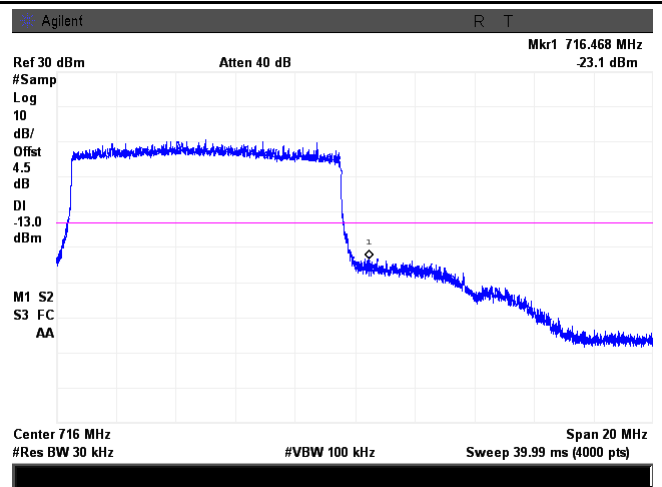

LTE Band 12 - High Channel QPSK-10

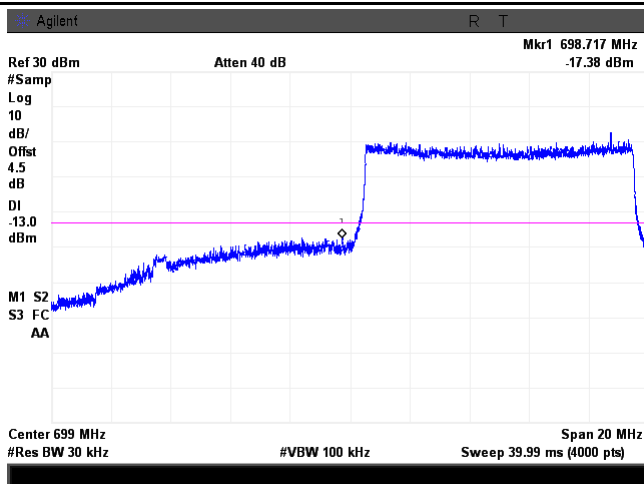

LTE Band 12 - Low Channel 16QAM-10

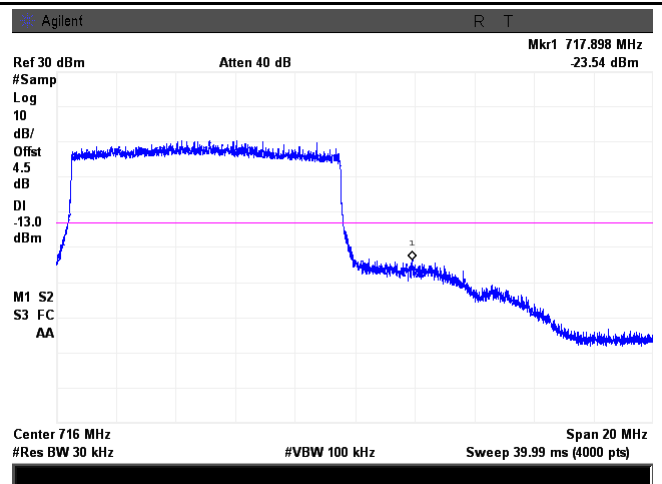

LTE Band 12 - High Channel 16QAM-10

LTE Band 17 (Part 27)

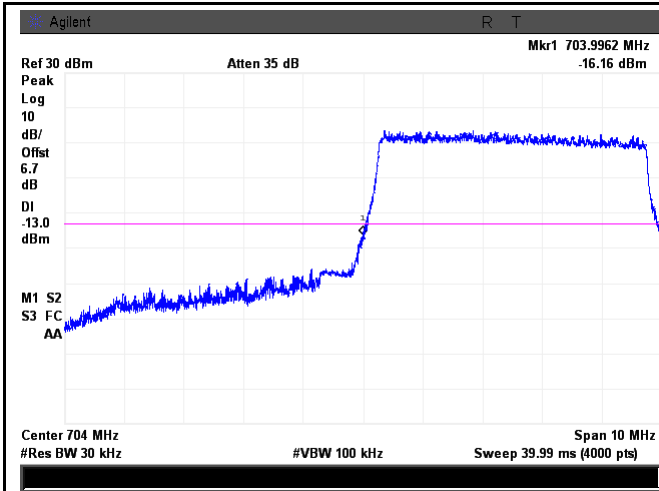

LTE Band 17 - Low Channel QPSK-5

Note: Offset=Cable loss (4.0) + 10log
(50.17/30)=4.5+2.2=6.7 dB

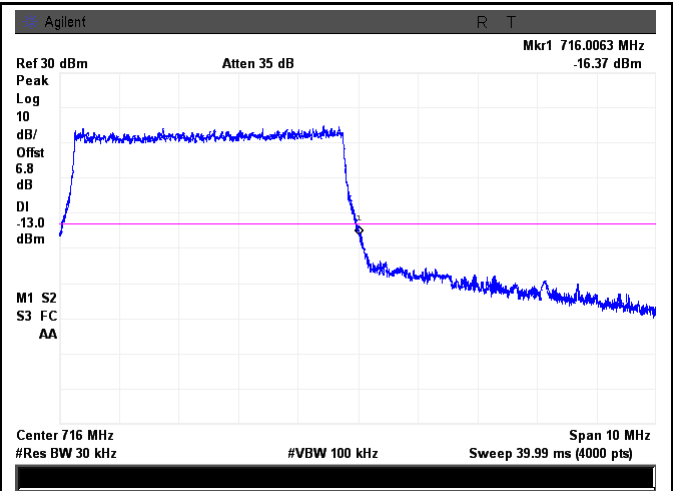

LTE Band 17 - High Channel QPSK-5

Note: Offset=Cable loss (4.0) + 10log
(50.41/30)=4.5+2.3=6.8 dB

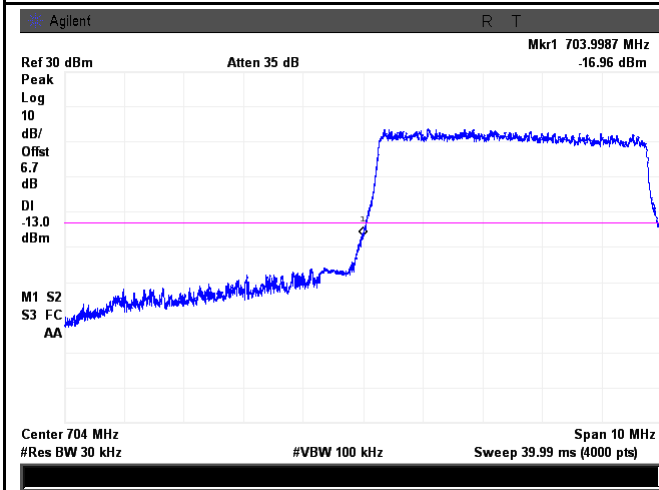

LTE Band 17 - Low Channel 16QAM-5

Note: Offset=Cable loss (4.0) + 10log
(50.18/30)=4.5+2.2=6.7 dB

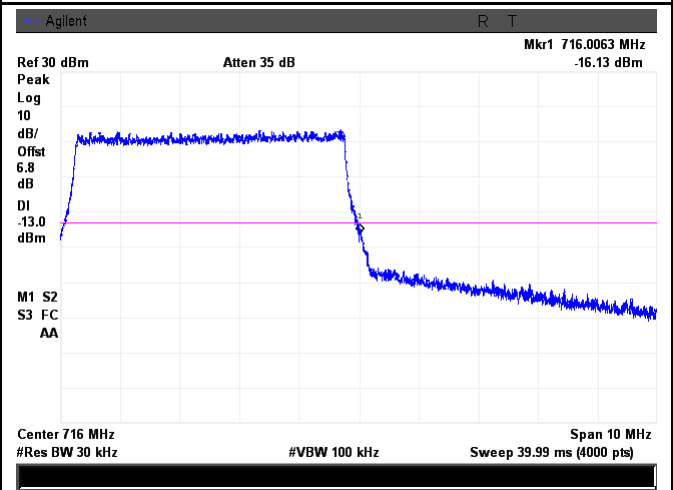

LTE Band 17 - High Channel 16QAM-5

Note: Offset=Cable loss (4.0) + 10log
(50.53/30)=4.5+2.3=6.8 dB

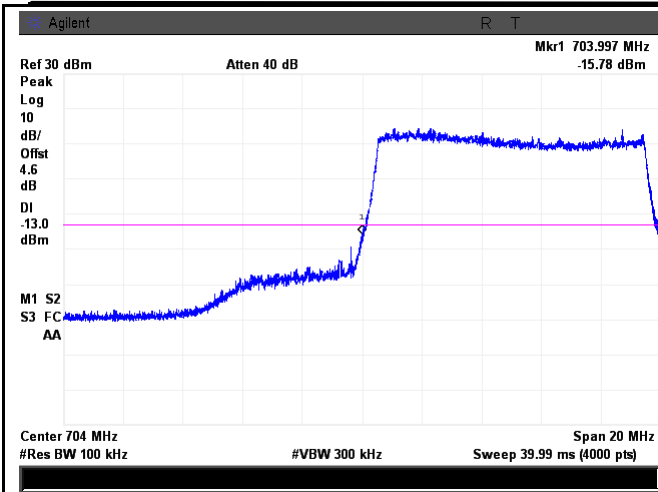

LTE Band 17 - Low Channel QPSK-10

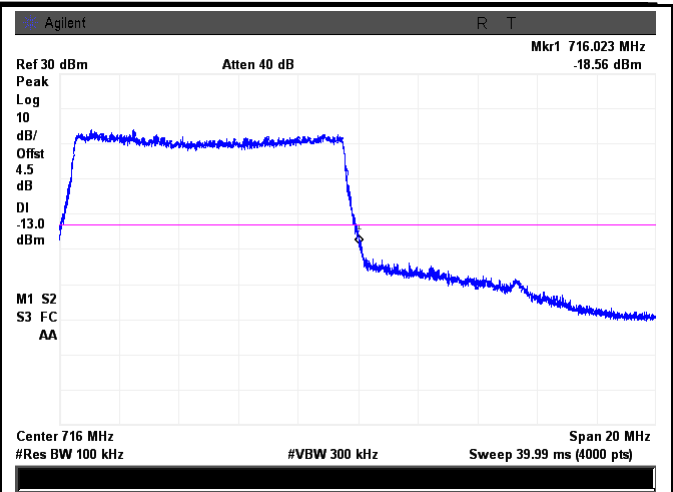

LTE Band 17 - High Channel QPSK-10

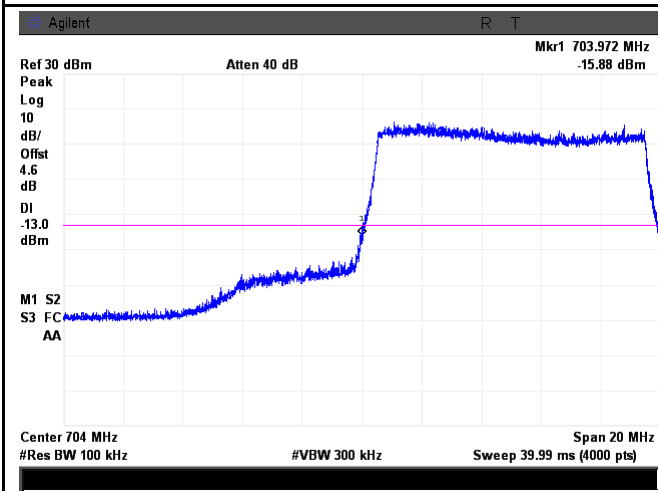

LTE Band 17 - Low Channel 16QAM-10

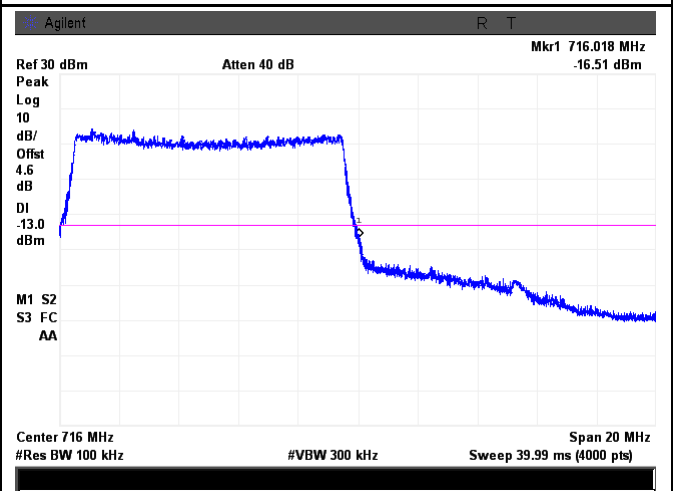

LTE Band 17 - High Channel 16QAM-10

6.9 Band Edge 27.53(m)

Temperature	24°C
Relative Humidity	59%
Atmospheric Pressure	1007mbar
Test date :	August 07, 2015 and November 04, 2015
Tested By :	Winnie Zhang

Requirement(s):

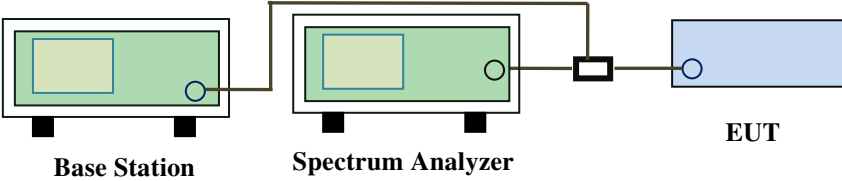
Spec	Requirement	Applicable
§27.53(m)	According to FCC 27.53(m)(4) specified that power of any emission outside of the channel edge must be attenuated below the transmitting power(P) by a factor shall be not less than $43+10\log(P)$ dB at the channel edge, the limit of emission equal to -13dBm. And $55+10\log(P)$ dB at 5.5MHz from the channel edges, the limit of emission equal to -25dBm. In the 1MHz bands immediately outside and adjacent to the frequency block a resolution bandwidth of at least one percent of the emission bandwidth of the fundamental emission of the transmitter may be employed.	<input checked="" type="checkbox"/>
Test Setup	 <p style="text-align: center;">Base Station Spectrum Analyzer EUT</p>	
Test Procedure	<ul style="list-style-type: none"> - The EUT was connected to Spectrum Analyzer and Base Station via power divider. - The 99% and 26 dB occupied bandwidth (BW) of the middle channel for the highest RF powers. 	
Remark		
Result	<input checked="" type="checkbox"/> Pass <input type="checkbox"/> Fail	

Test Data Yes N/A
 Test Plot Yes (See below) N/A

6.10 Frequency Stability

Temperature	24°C
Relative Humidity	59%
Atmospheric Pressure	1007mbar
Test date :	August 07, 2015 and November 04, 2015
Tested By :	Winnie Zhang

Requirement(s):

Spec	Item	Requirement	Applicable																																
§2.1055, §22.355 & §24.235 § 27.5(h); § 27.54	a)	<p>According to §22.355, the carrier frequency of each transmitter in the Public Mobile Services must be maintained within the tolerances given in Table below:</p> <p>Frequency Tolerance for Transmitters in the Public Mobile Services</p> <table border="1"> <thead> <tr> <th>Frequency Range (MHz)</th> <th>Base, fixed (ppm)</th> <th>Mobile ≤ 3 watts (ppm)</th> <th>Mobile ≤ 3 watts (ppm)</th> </tr> </thead> <tbody> <tr> <td>25 to 50</td> <td>20.0</td> <td>20.0</td> <td>50.0</td> </tr> <tr> <td>to 450</td> <td>5.0</td> <td>5.0</td> <td>50.0</td> </tr> <tr> <td>450 to 512</td> <td>2.5</td> <td>5.0</td> <td>5 0</td> </tr> <tr> <td>821 to 896</td> <td>1.5</td> <td>2.5</td> <td>2.5</td> </tr> <tr> <td>928 to 929.</td> <td>5.0</td> <td>N/A</td> <td>N/A</td> </tr> <tr> <td>929 to 960.</td> <td>1.5</td> <td>N/A</td> <td>N/A</td> </tr> <tr> <td>2110 to 2220</td> <td>10.0</td> <td>N/A</td> <td>N/A</td> </tr> </tbody> </table>	Frequency Range (MHz)	Base, fixed (ppm)	Mobile ≤ 3 watts (ppm)	Mobile ≤ 3 watts (ppm)	25 to 50	20.0	20.0	50.0	to 450	5.0	5.0	50.0	450 to 512	2.5	5.0	5 0	821 to 896	1.5	2.5	2.5	928 to 929.	5.0	N/A	N/A	929 to 960.	1.5	N/A	N/A	2110 to 2220	10.0	N/A	N/A	<input checked="" type="checkbox"/>
		Frequency Range (MHz)	Base, fixed (ppm)	Mobile ≤ 3 watts (ppm)	Mobile ≤ 3 watts (ppm)																														
		25 to 50	20.0	20.0	50.0																														
		to 450	5.0	5.0	50.0																														
		450 to 512	2.5	5.0	5 0																														
		821 to 896	1.5	2.5	2.5																														
		928 to 929.	5.0	N/A	N/A																														
		929 to 960.	1.5	N/A	N/A																														
2110 to 2220	10.0	N/A	N/A																																
<p>According to §24.235, the frequency stability shall be sufficient to ensure that the fundamental emissions stay within the authorized frequency block.</p>																																			
<p>According to §27.54, The frequency stability shall be sufficient to ensure that the fundamental emissions stay within the authorized bands of operation.</p>																																			

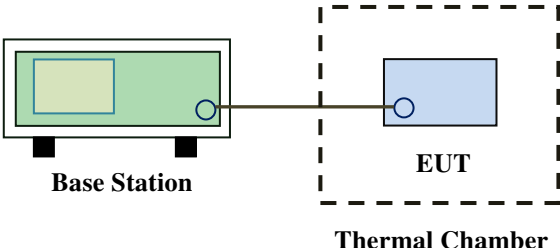
<p>Test setup</p>	 <p>The diagram illustrates the test setup. On the left, a green rectangular box labeled 'Base Station' is shown with a smaller green box inside it. A horizontal line connects the right side of the Base Station to the left side of a blue rectangular box labeled 'EUT'. The EUT is enclosed within a dashed-line rectangular box labeled 'Thermal Chamber'.</p>
<p>Procedure</p>	<p>A communication link was established between EUT and base station. The frequency error was monitored and measured by base station under variation of ambient temperature and variation of primary supply voltage.</p> <p>Limit: The frequency stability of the transmitter shall be maintained within $\pm 0.00025\%$ ($\pm 2.5\text{ppm}$) of the center frequency.</p>
<p>Remark</p>	<p>Frequency Stability versus Temperature: The Frequency tolerance of the carrier signal shall be maintained within 2.5ppm of the operating frequency over a temperature variation of -10°C to $+55^{\circ}\text{C}$ at normal supply voltage.</p>
<p>Result</p>	<p><input checked="" type="checkbox"/> Pass <input type="checkbox"/> Fail</p>

Test Data Yes N/A

Test Plot Yes (See below) N/A

LTE Band 2 (Part 24E) result

Middle Channel, $f_0 = 1880$ MHz				
Temperature (°C)	Power Supplied (V _{DC})	Frequency Error (Hz)	Frequency Error (ppm)	Limit (ppm)
-10	3.7	-7	0.0037	2.5
0		-11	0.0059	2.5
10		-7	0.0037	2.5
20		-10	0.0053	2.5
30		-12	0.0064	2.5
40		-9	0.0048	2.5
50		-12	0.0064	2.5
55		-8	0.0043	2.5
25	4.2	-9	0.0048	2.5
	3.5	-11	0.0059	2.5

LTE Band 4 (Part 27) result

Middle Channel, $f_0 = 1732.5$ MHz				
Temperature (°C)	Power Supplied (V _{DC})	Frequency Error (Hz)	Frequency Error (ppm)	Limit (ppm)
-10	3.7	-14	0.0081	2.5
0		-13	0.0075	2.5
10		-11	0.0063	2.5
20		-12	0.0069	2.5
30		-10	0.0058	2.5
40		-12	0.0069	2.5
50		-16	0.0092	2.5
55		-14	0.0081	2.5
25	4.2	-13	0.0075	2.5
	3.5	-16	0.0092	2.5

LTE Band 5 (Part 22H) result

Middle Channel, $f_0 = 1732.5$ MHz				
Temperature (°C)	Power Supplied (V _{DC})	Frequency Error (Hz)	Frequency Error (ppm)	Limit (ppm)
-10	3.7	6	0.0072	2.5
0		5	0.0060	2.5
10		6	0.0072	2.5
20		8	0.0096	2.5
30		11	0.0132	2.5
40		12	0.0143	2.5
50		8	0.0096	2.5
55		9	0.0108	2.5
25	4.2	7	0.0084	2.5
	3.5	10	0.0120	2.5

LTE Band 12 (Part 27) result

Middle Channel, $f_0 = 707.5$ MHz				
Temperature (°C)	Power Supplied (V _{DC})	Frequency Error (Hz)	Frequency Error (ppm)	Limit (ppm)
-10	3.7	-6	0.0032	2.5
0		-10	0.0053	2.5
10		-8	0.0043	2.5
20		-11	0.0059	2.5
30		-12	0.0064	2.5
40		-10	0.0053	2.5
50		-11	0.0059	2.5
55		-7	0.0037	2.5
25	4.2	-10	0.0053	2.5
	3.5	-11	0.0059	2.5

LTE Band 17 (Part 27) result

Middle Channel, $f_0 = 710$ MHz				
Temperature (°C)	Power Supplied (V _{DC})	Frequency Error (Hz)	Frequency Error (ppm)	Limit (ppm)
-10	3.7	8	0.0113	2.5
0		7	0.0099	2.5
10		6	0.0085	2.5
20		5	0.0070	2.5
30		6	0.0085	2.5
40		10	0.0141	2.5
50		11	0.0155	2.5
55		6	0.0085	2.5
25		4.2	9	0.0127
	3.5	11	0.0155	2.5

Annex A. TEST INSTRUMENT

LTE Band 2,4,5,17

Instrument	Model	Serial #	Cal Date	Cal Due	In use
RF Conducted Test					
Agilent ESA-E SERIES SPECTRUM ANALYZER	E4407B	MY45108319	09/17/2014	09/16/2015	<input checked="" type="checkbox"/>
Power Splitter	1#	1#	09/02/2014	09/01/2015	<input checked="" type="checkbox"/>
Universal Radio Communication Tester	CMU200	121393	09/26/2014	09/25/2015	<input checked="" type="checkbox"/>
Wideband Radio Communication Tester	CMW500	120906	03/29/2014	03/28/2015	<input checked="" type="checkbox"/>
Temperature/Humidity Chamber	UHL-270	001	10/10/2014	10/09/2015	<input checked="" type="checkbox"/>
DC Power Supply	E3640A	MY40004013	09/18/2014	09/17/2015	<input checked="" type="checkbox"/>
Radiated Emissions					
EMI test receiver	ESL6	100262	09/18/2014	09/17/2015	<input checked="" type="checkbox"/>
OPT 010 AMPLIFIER (0.1-1300MHz)	8447E	2727A02430	09/02/2014	09/01/2015	<input checked="" type="checkbox"/>
Microwave Preamplifier (0.5 ~ 18GHz)	PAM-118	443008	09/02/2014	09/01/2015	<input checked="" type="checkbox"/>
Bilog Antenna (30MHz~6GHz)	JB6	A110712	09/22/2014	09/21/2015	<input checked="" type="checkbox"/>
Bilog Antenna (30MHz~2GHz)	JB1	A112017	09/22/2014	09/21/2015	<input checked="" type="checkbox"/>
Double Ridge Horn Antenna (1 ~18GHz)	AH-118	71259	09/25/2014	09/24/2015	<input checked="" type="checkbox"/>
Double Ridge Horn Antenna (1 ~18GHz)	AH-118	71283	09/25/2014	09/24/2015	<input checked="" type="checkbox"/>
SYNTHESIZED SIGNAL GENERATOR	8665B	3744A01293	09/18/2014	09/17/2015	<input checked="" type="checkbox"/>
Tunable Notch Filter	3NF-800/1000-S	AA4	09/02/2014	09/01/2015	<input checked="" type="checkbox"/>
Tunable Notch Filter	3NF-1000/2000-S	AM 4	09/02/2014	09/01/2015	<input checked="" type="checkbox"/>

LTE Band 12

Instrument	Model	Serial #	Cal Date	Cal Due	In use
RF Conducted Test					
Agilent ESA-E SERIES SPECTRUM ANALYZER	E4407B	MY45108319	09/16/2015	09/15/2016	<input checked="" type="checkbox"/>
Power Splitter	1#	1#	09/01/2015	08/31/2016	<input checked="" type="checkbox"/>
Universal Radio Communication Tester	CMU200	121393	09/25/2015	09/24/2016	<input checked="" type="checkbox"/>
Wideband Radio Communication Tester	CMW500	120906	03/28/2015	03/27/2016	<input checked="" type="checkbox"/>
Temperature/Humidity Chamber	UHL-270	001	10/10/2014	10/09/2015	<input checked="" type="checkbox"/>
DC Power Supply	E3640A	MY40004013	09/17/2015	09/16/2016	<input checked="" type="checkbox"/>
Radiated Emissions					
EMI test receiver	ESL6	100262	09/17/2015	09/16/2016	<input checked="" type="checkbox"/>
OPT 010 AMPLIFIER (0.1-1300MHz)	8447E	2727A02430	09/01/2015	08/31/2016	<input checked="" type="checkbox"/>
Microwave Preamplifier (0.5 ~ 18GHz)	PAM-118	443008	09/01/2015	08/31/2016	<input checked="" type="checkbox"/>
Bilog Antenna (30MHz~6GHz)	JB6	A110712	09/21/2015	09/20/2016	<input checked="" type="checkbox"/>
Bilog Antenna (30MHz~2GHz)	JB1	A112017	09/21/2015	09/20/2016	<input checked="" type="checkbox"/>
Double Ridge Horn Antenna (1 ~18GHz)	AH-118	71259	09/24/2015	09/23/2016	<input checked="" type="checkbox"/>
Double Ridge Horn Antenna (1 ~18GHz)	AH-118	71283	09/24/2015	09/23/2016	<input checked="" type="checkbox"/>
SYNTHESIZED SIGNAL GENERATOR	8665B	3744A01293	09/17/2015	09/16/2016	<input checked="" type="checkbox"/>
Tunable Notch Filter	3NF-800/1000-S	AA4	09/01/2015	08/31/2016	<input checked="" type="checkbox"/>
Tunable Notch Filter	3NF-1000/2000-S	AM 4	09/01/2015	08/31/2016	<input checked="" type="checkbox"/>

Annex B. EUT And Test Setup Photographs

Annex B.i. Photograph: EUT External Photo

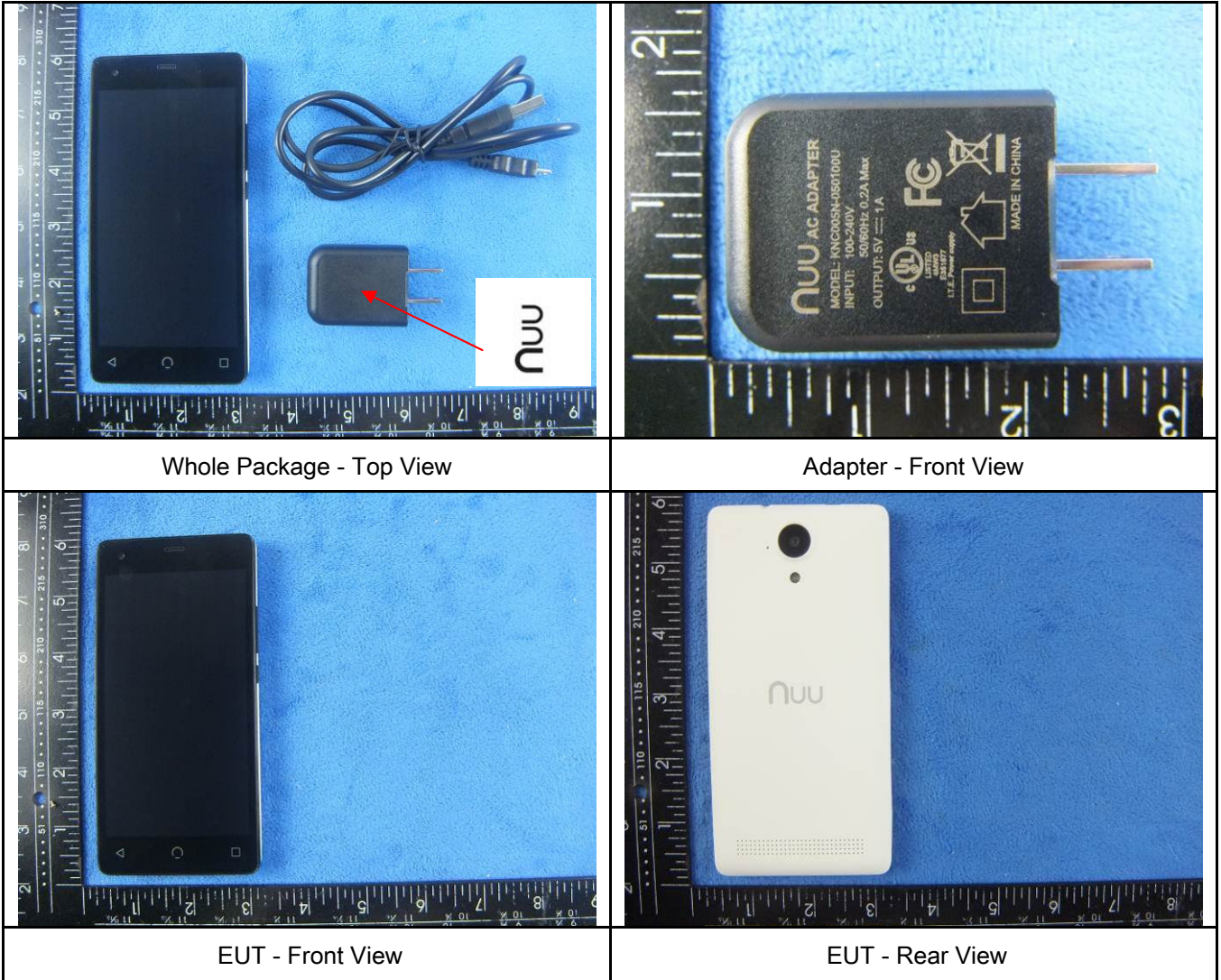

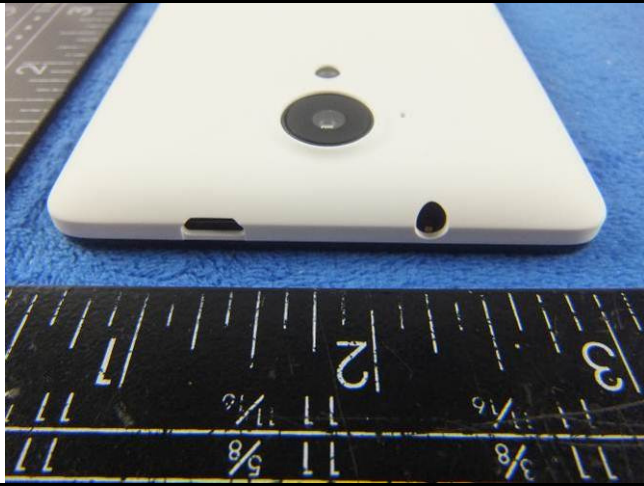

EUT - Top View

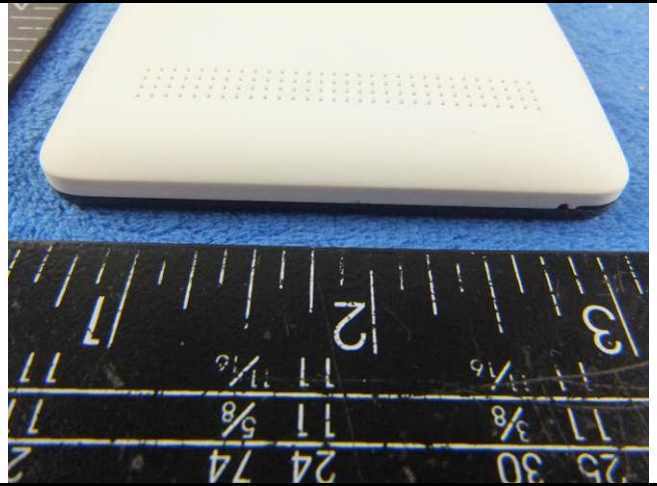

EUT - Bottom View



EUT - Left View



EUT - Right View

Annex B.ii. Photograph: EUT Internal Photo



Cover Off - Top View 1



Cover Off - Top View 2



Battery - Front View



Battery - Rear View

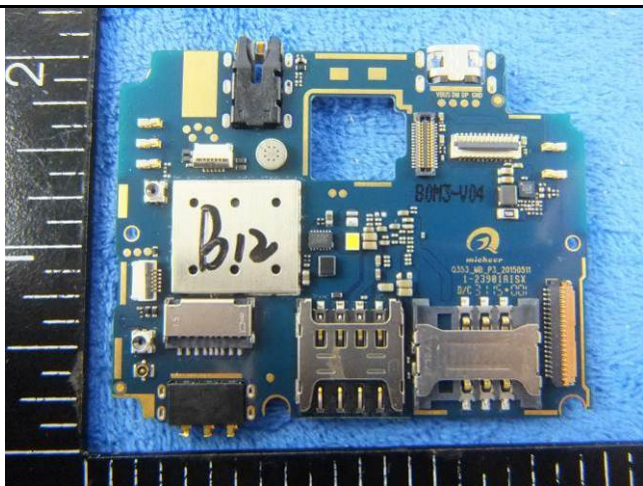

Mainboard with Shielding - Front View



Mainboard without shielding - Front View



Mainboard with Shielding - Rear View

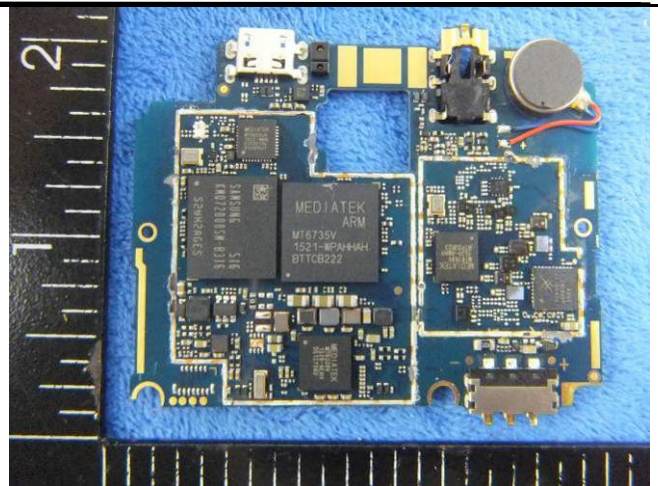

Mainboard without Shielding - Rear View

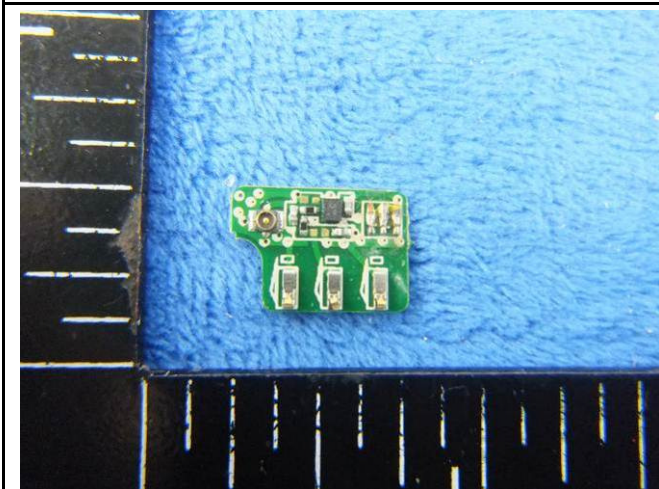

Mini Mainboard - Front View

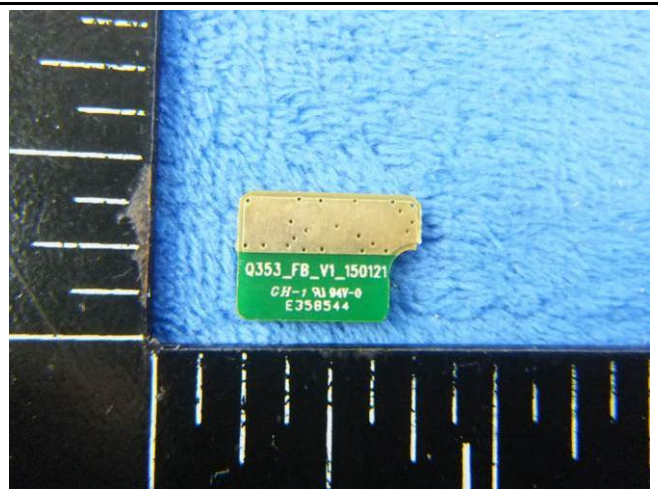

Mini Mainboard - Rear View



LCD - Front View



LCD - Rear View



GSM/PCS/UMTS-FDD/LTE Antenna View



WIFI/BT/BLE - Antenna View



GPS - Antenna View

Annex B.iii. Photograph: Test Setup Photo

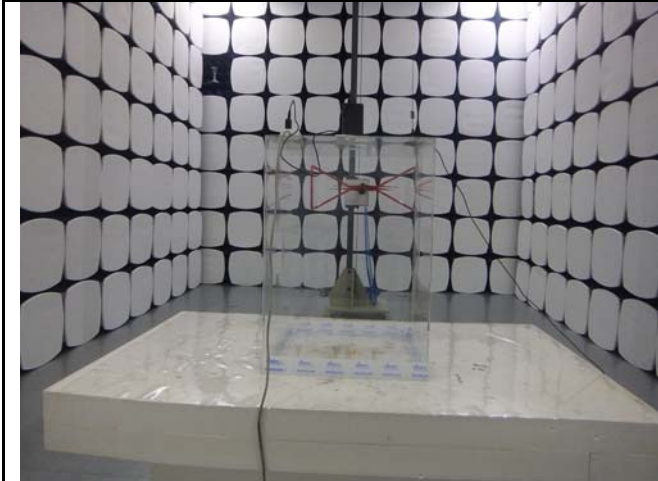

Radiated Spurious Emissions Test Setup Below 1GHz

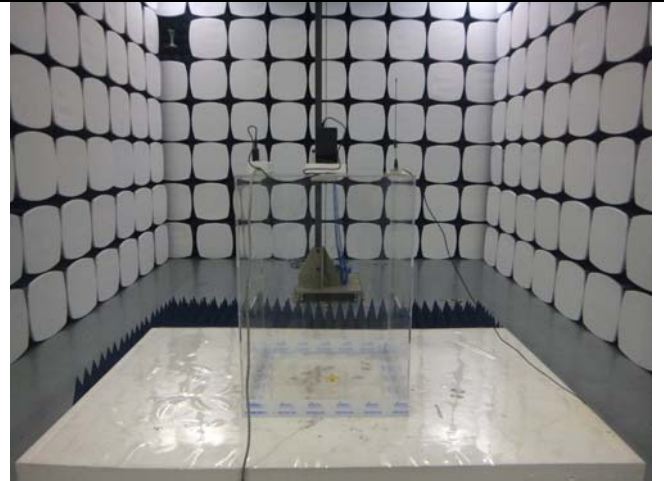

Radiated Spurious Emissions Test Setup Above
1GHz

Annex C. TEST SETUP AND SUPPORTING EQUIPMENT

Annex C.ii. TEST SET UP BLOCK

Block Configuration Diagram for Radiated Emissions

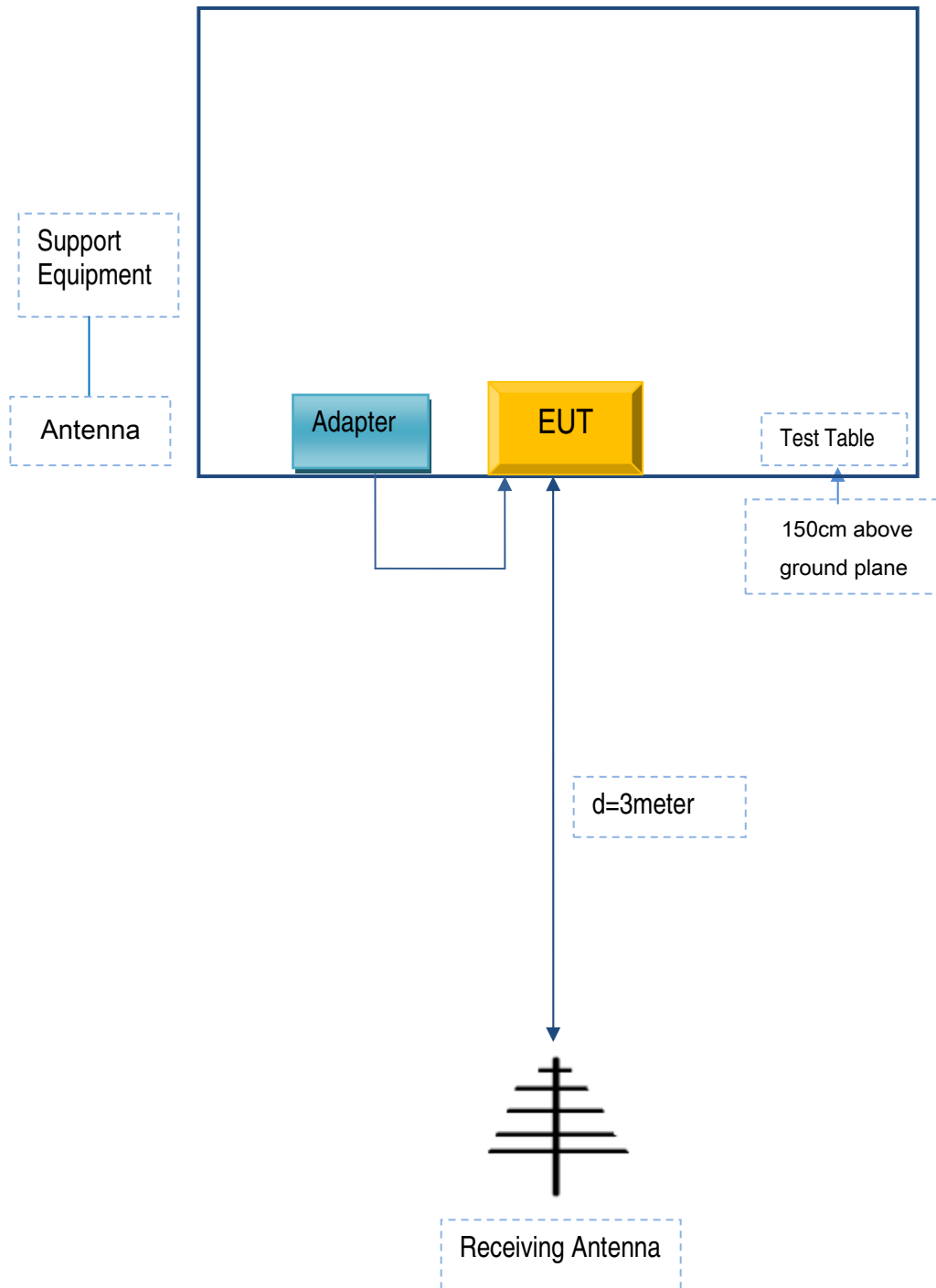

Annex C. ii. SUPPORTING EQUIPMENT DESCRIPTION

The following is a description of supporting equipment and details of cables used with the EUT.

Manufacturer	Equipment Description	Model	Calibration Date	Calibration Due Date
N/A	N/A	N/A	N/A	N/A

Test Report	15071019-FCC-R5
Page	130 of 132

Annex C.ii. EUT OPERATING CONKITIONS

N/A

Test Report	15071019-FCC-R5
Page	131 of 132

Annex D. User Manual / Block Diagram / Schematics / Partlist

Please see attachment

Test Report	15071019-FCC-R5
Page	132 of 132

Annex E. DECLARATION OF SIMILARITY

N/A