

# FCC REPORT

## (LTE)

**Applicant:** SUN CUPID TECHNOLOGY (HK) LIMITED

**Address of Applicant:** 16/F, CEO Tower, 77 Wing Hong Street, Cheung Sha Wan, Hong Kong

**Equipment Under Test (EUT)**

Product Name: LTE mobile phone

Model No.: M2, M2+, M2-AM, M2+-AM

Trade mark: NUU

**FCC ID:** 2ADINNUUM2

**Applicable standards:** FCC CFR Title 47 Part 2  
FCC CFR Title 47 Part 24 Subpart E  
FCC CFR Title 47 Part 27 Subpart L  
FCC CFR Title 47 Part 27 Subpart M  
FCC CFR Title 47 Part 27 Subpart H

**Date of sample receipt:** 23 Oct., 2016

**Date of Test:** 24 Oct., to 12 Dec., 2016

**Date of report issued:** 13 Dec., 2016

**Test Result:** PASS\*

\* In the configuration tested, the EUT complied with the standards specified above.

Authorized Signature:



Bruce Zhang  
Laboratory Manager

This report details the results of the testing carried out on one sample. The results contained in this test report do not relate to other samples of the same product and does not permit the use of the CCIS product certification mark. The manufacturer should ensure that all products in series production are in conformity with the product sample detailed in this report.

This report may only be reproduced and distributed in full. If the product in this report is used in any configuration other than that detailed in the report, the manufacturer must ensure the new system complies with all relevant standards.

This document cannot be reproduced except in full, without prior written approval of the Company. Any unauthorized alteration, forgery or falsification of the content or appearance of this document is unlawful and offenders may be prosecuted to the fullest extent of the law. Unless otherwise stated the results shown in this test report refer only to the sample(s) tested and such sample(s) are retained for 90 days only.

## 2. Version

Version No.	Date	Description
00	13 Dec., 2016	Original

**Tested by:**

*Mike.OU*

**Date:**

13 Dec., 2016

**Test Engineer**

**Reviewed by:**

*Carrey Chen*

**Date:**

13 Dec., 2016

**Project Engineer**

### 3. Contents

	Page
<b>1. COVER PAGE</b> .....	<b>1</b>
<b>2. VERSION</b> .....	<b>2</b>
<b>3. CONTENTS</b> .....	<b>3</b>
<b>4. TEST SUMMARY</b> .....	<b>4</b>
<b>5. GENERAL INFORMATION</b> .....	<b>5</b>
5.1 CLIENT INFORMATION.....	5
5.2 GENERAL DESCRIPTION OF E.U.T.....	5
5.3 TEST MODES.....	12
5.4 RELATED SUBMITTAL(S) / GRANT (S).....	12
5.5 TEST METHODOLOGY.....	12
5.6 LABORATORY FACILITY.....	12
5.7 LABORATORY LOCATION.....	13
5.8 TEST INSTRUMENTS LIST.....	13
<b>6. SYSTEM TEST CONFIGURATION</b> .....	<b>13</b>
6.1 EUT CONFIGURATION.....	13
6.2 EUT EXERCISE.....	13
6.3 CONFIGURATION OF TESTED SYSTEM.....	14
6.4 DESCRIPTION OF TEST MODES.....	14
6.5 CONDUCTED OUTPUT POWER.....	15
6.6 PEAK-TO-AVERAGE RATIO.....	24
6.7 OCCUPY BANDWIDTH.....	28
6.8 MODULATION CHARACTERISTIC.....	77
6.9 OUT OF BAND EMISSION AT ANTENNA TERMINALS.....	77
6.10 ERP, EIRP MEASUREMENT.....	386
6.11 FIELD STRENGTH OF SPURIOUS RADIATION MEASUREMENT.....	403
6.12 FREQUENCY STABILITY V.S. TEMPERATURE MEASUREMENT.....	427
6.13 FREQUENCY STABILITY V.S. VOLTAGE MEASUREMENT.....	441
<b>7 TEST SETUP PHOTO</b> .....	<b>451</b>
<b>8 EUT CONSTRUCTIONAL DETAILS</b> .....	<b>452</b>

## 4. Test Summary

Test Item	Section in CFR 47	Result
RF Exposure (SAR)	Part 1.1307 Part 2.1093	Passed (Please refer to SAR Report)
RF Output Power	Part 2.1046 Part 24.232 (c) Part 27.50 (c)(10) Part 27.50 (d)(4) Part 27.50 (h)(2)	Pass
Peak-to-Average Ratio	Part 24.232 (d)	Pass
Modulation Characteristics	Part 2.1047	Pass
99% & -26 dB Occupied Bandwidth	Part 2.1049 Part 24.238(b) Part 27.53(g) Part 27.53(h) Part 27.53(m)	Pass
Spurious Emissions at Antenna Terminal	Part 2.1051 Part 24.238 (a) Part 27.53 (g) Part 27.53 (h) Part 27.53(m)	Pass
Field Strength of Spurious Radiation	Part 2.1053 Part 24.238 (a) Part 27.53 (g) Part 27.53 (h) Part 27.53(m)	Pass
Out of band emission, Band Edge	Part 24.238 (a) Part 27.53 (g) Part 27.53 (h) Part 27.53(m)	Pass
Frequency stability vs. temperature	Part 2.1055(a)(1)(b)	Pass
Frequency stability vs. voltage	Part 2.1055(d)(1)(2)	Pass

*Pass: The EUT complies with the essential requirements in the standard.*

## 5. General Information

### 5.1 Client Information

Applicant:	SUN CUPID TECHNOLOGY (HK) LIMITED
Address of Applicant:	16/F, CEO Tower, 77 Wing Hong Street, Cheung Sha Wan, Hong Kong
Manufacturer/Factory:	Sun cupid (Shen Zhen) Electronic Ltd
Address of Manufacturer/Factory::	Baolong Industrial City, Longgang District, Shenzhen Hi-Tech Road, Building 1, A 7

### 5.2 General Description of E.U.T.

Product Name:	LTE mobile phone
Model No.:	M2, M2+, M2-AM, M2+-AM
Operation Frequency range:	LTE Band 2: TX: 1850MHz-1910MHz, RX: 1930MHz-1990MHz LTE Band 4:TX: 1710MHz-1755MHz, RX: 2110MHz-2155MHz LTE Band 7: TX: 2500MHz -2570MHz, RX: 2620MHz-2690MHz LTE Band 12: TX: 699MHz -716MHz, RX: 729MHz-746MHz LTE Band 17: TX: 704MHz -716MHz, RX: 734MHz-746MHz
Modulation type:	QPSK, 16QAM
Antenna type:	Internal Antenna
Antenna gain:	LTE Band 2: 0.37dBi LTE Band 4: 0.33dBi LTE Band 7: 0.35dBi LTE Band 12: -0.60dBi LTE Band 17: -0.63dBi
AC adapter:	Model: HNFL050100UU Input: AC100-240V 50/60Hz 0.2A Output: DC 5.0V, 1A
Power supply:	Rechargeable Li-ion Battery DC3.8V-2400mAh
Remark:	The No.: M2, M2+, M2-AM, M2+-AM were identical inside, the electrical circuit design, layout, components used and internal wiring, with only difference being model name.

**Operation Frequency List:**

LTE Band 2(1.4MHz)		LTE Band 2(3MHz)	
Channel	Frequency (MHz)	Channel	Frequency (MHz)
18607	1850.70	18615	1851.50
18608	1850.80	18616	1851.60
....	....	....	....
18899	1879.90	18899	1879.90
18900	1880.00	18900	1880.00
18901	1880.10	18901	1880.10
...	...	...	...
19193	1909.20	19185	1908.40
19194	1909.30	19186	1908.50
LTE Band 2(5MHz)		LTE Band 2(10MHz)	
Channel	Frequency (MHz)	Channel	Frequency (MHz)
18625	1852.50	18650	1855.00
18626	1852.60	18651	1855.10
....	....	....	....
18899	1879.90	18899	1879.90
18900	1880.00	18900	1880.00
18901	1880.10	18901	1880.10
...	...	...	...
19175	1907.40	19150	1904.90
19176	1907.50	19151	1905.00
LTE Band 2(15MHz)		LTE Band 2(20MHz)	
Channel	Frequency (MHz)	Channel	Frequency (MHz)
18675	1857.50	18700	1860.00
18676	1857.60	18701	1860.10
....	....	....	....
18899	1879.90	18899	1879.90
18900	1880.00	18900	1880.00
18901	1880.10	18901	1880.10
...	...	...	...
19125	1902.40	19100	1899.90
19126	1902.50	19101	1900.00

LTE Band 4(1.4MHz)		LTE Band 4(3MHz)	
Channel	Frequency (MHz)	Channel	Frequency (MHz)
19957	1710.70	19965	1711.50
19958	1710.80	19966	1711.60
....	....	....	....
20174	1732.40	20174	1732.40
20175	1732.50	20175	1732.50
20176	1732.60	20176	1732.60
...	...	...	...
20392	1754.20	20384	1753.40
20393	1754.30	20385	1753.50
LTE Band 4(5MHz)		LTE Band 4(10MHz)	
Channel	Frequency (MHz)	Channel	Frequency (MHz)
19975	1712.50	20000	1715.00
19976	1712.60	20001	1715.10
....	....	....	....
20174	1732.40	20174	1732.40
20175	1732.50	20175	1732.50
20176	1732.60	20176	1732.60
...	...	...	...
20374	1752.40	20349	1749.90
20375	1752.50	20350	1750.00
LTE Band 4(15MHz)		LTE Band 4(20MHz)	
Channel	Frequency (MHz)	Channel	Frequency (MHz)
20025	1717.50	20050	1720.00
20026	1717.60	20051	1720.10
....	....	....	....
20174	1732.40	20174	1732.40
20175	1732.50	20175	1732.50
20176	1732.60	20176	1732.60
...	...	...	...
20324	1747.40	20299	1744.90
20325	1747.50	20300	1745.00

LTE Band 7(5MHz)		LTE Band 7(10MHz)	
Channel	Frequency (MHz)	Channel	Frequency (MHz)
20775	2502.50	20800	2505.00
20776	2502.60	20801	2502.10
....	....	....	....
21099	2534.90	21099	2534.90
21100	2535.00	21100	2535.00
21101	2535.20	21101	2535.20
...	...	...	...
21424	2567.40	21399	2564.90
21425	2567.50	21400	2565.00
LTE Band 7(15MHz)		LTE Band 7(20MHz)	
Channel	Frequency (MHz)	Channel	Frequency (MHz)
20825	2507.50	20850	2510.00
20826	2507.60	20851	2510.10
....	....	....	....
21099	2534.90	21099	2534.90
21100	2535.00	21100	2535.00
21101	2535.20	21101	2535.20
...	...	...	...
21374	2562.40	21349	2559.90
21375	2562.50	21350	2560.00



LTE Band 12(1.4MHz)		LTE Band 12(3MHz)	
Channel	Frequency (MHz)	Channel	Frequency (MHz)
23017	699.70	23025	700.50
23018	699.80	23026	700.60
....	....	....	....
23094	707.40	23094	707.40
23095	707.50	23095	707.50
23096	707.60	23096	707.60
...	...	...	...
23174	715.20	23164	714.40
23175	715.30	23165	714.50
LTE Band 12(5MHz)		LTE Band 12(10MHz)	
Channel	Frequency (MHz)	Channel	Frequency (MHz)
23035	701.50	23060	704.00
23036	701.60	23061	704.10
....	....	....	....
23094	707.40	23094	707.40
23095	707.50	23095	707.50
23096	707.60	23096	707.60
...	...	...	...
23154	713.40	23129	710.90
23155	713.50	23130	711.00

LTE Band 17(5MHz)		LTE Band 17(10MHz)	
Channel	Frequency (MHz)	Channel	Frequency (MHz)
23755	706.50	23780	709.00
23756	706.60	23781	709.10
....	....	....	....
23789	709.90	23789	709.90
23790	710.00	23790	710.00
23791	710.10	23791	710.10
...	...	...	...
23824	713.40	23799	710.90
23825	713.50	23800	711.00

Regards to the operating frequency range, the lowest frequency, the middle frequency, and the highest frequency of channel were selected to perform the test, and the selected channels as below:

LTE Band 2(1.4MHz)			LTE Band 2(3MHz)		
Channel		Frequency (MHz)	Channel		Frequency (MHz)
Lowest channel	18607	1850.70	Lowest channel	18615	1851.50
Middle channel	18900	1880.00	Middle channel	18900	1880.00
Highest channel	19193	1909.30	Highest channel	19185	1908.50
LTE Band 2(5MHz)			LTE Band 2(10MHz)		
Channel		Frequency (MHz)	Channel		Frequency (MHz)
Lowest channel	18625	1852.50	Lowest channel	18650	1855.00
Middle channel	18900	1880.00	Middle channel	18900	1880.00
Highest channel	19175	1907.50	Highest channel	19150	1905.00
LTE Band 2(15MHz)			LTE Band 2(20MHz)		
Channel		Frequency (MHz)	Channel		Frequency (MHz)
Lowest channel	18675	1857.50	Lowest channel	18700	1860.00
Middle channel	18900	1880.00	Middle channel	18900	1880.00
Highest channel	19125	1902.50	Highest channel	19100	1900.00

LTE Band 4(1.4MHz)			LTE Band 4(3MHz)		
Channel:		Frequency (MHz)	Channel		Frequency (MHz)
Lowest channel	19957	1710.70	Lowest channel	19965	1711.50
Middle channel	20175	1732.50	Middle channel	20175	1732.50
Highest channel	20393	1754.30	Highest channel	20385	1753.50
LTE Band 4(5MHz)			LTE Band 4(10MHz)		
Channel		Frequency (MHz)	Channel		Frequency (MHz)
Lowest channel	19975	1712.50	Lowest channel	20000	1715.00
Middle channel	20175	1732.50	Middle channel	20175	1732.50
Highest channel	20375	1752.50	Highest channel	20350	1750.00
LTE Band 4(15MHz)			LTE Band 4(20MHz)		
Channel		Frequency (MHz)	Channel		Frequency (MHz)
Lowest channel	20025	1717.50	Lowest channel	20050	1720.00
Middle channel	20175	1732.50	Middle channel	20175	1732.50
Highest channel	20325	1747.50	Highest channel	20300	1745.00

LTE Band 7(5MHz)			LTE Band 7(10MHz)		
Channel		Frequency (MHz)	Channel		Frequency (MHz)
Lowest channel	20775	2502.50	Lowest channel	20800	2505.00
Middle channel	21100	2535.00	Middle channel	21100	2535.00
Highest channel	21425	2567.50	Highest channel	21400	2565.00
LTE Band 7(15MHz)			LTE Band 7(20MHz)		
Channel		Frequency (MHz)	Channel		Frequency (MHz)
Lowest channel	20825	2507.50	Lowest channel	20850	2510.00
Middle channel	21100	2535.00	Middle channel	21100	2535.00
Highest channel	21375	2562.50	Highest channel	21350	2560.00

LTE Band 12(1.4MHz)			LTE Band 12(3MHz)		
Channel		Frequency (MHz)	Channel		Frequency (MHz)
Lowest channel	23017	699.70	Lowest channel	23025	700.50
Middle channel	23095	707.50	Middle channel	23095	707.50
Highest channel	23175	715.30	Highest channel	23165	714.50
LTE Band 12(5MHz)			LTE Band 12(10MHz)		
Channel		Frequency (MHz)	Channel		Frequency (MHz)
Lowest channel	23035	701.50	Lowest channel	23060	704.00
Middle channel	23095	707.50	Middle channel	23095	707.50
Highest channel	23155	713.50	Highest channel	23130	711.00

LTE Band 17(5MHz)			LTE Band 17(10MHz)		
Channel		Frequency (MHz)	Channel		Frequency (MHz)
Lowest channel	23755	706.50	Lowest channel	23780	709.00
Middle channel	23790	710.00	Middle channel	23790	710.00
Highest channel	23825	713.50	Highest channel	23800	711.00

### 5.3 Test modes

Data mode (LTE band 2(QPSK))	Keep the EUT in data communicating mode on LTE band 2(QPSK). (LTE band2(1.4MHz), LTE band2(3MHz), LTE band2(5MHz), LTE band2(10MHz), LTE band2(15MHz), LTE band2(20MHz))
Data mode (LTE band 2(16QAM))	Keep the EUT in data communicating mode on LTE band 2(16QAM). (LTE band2(1.4MHz), LTE band2(3MHz), LTE band2(5MHz), LTE band2(10MHz), LTE band2(15MHz), LTE band2(20MHz))
Data mode (LTE band 4(QPSK))	Keep the EUT in data communicating mode on LTE band 4(QPSK). (LTE band 4(1.4MHz), LTE band 4(3MHz), LTE band 4(5MHz), LTE band 4(10MHz), LTE band 4(15MHz), LTE band 4(20MHz))
Data mode (LTE band 4(16QAM))	Keep the EUT in data communicating mode on LTE band 4(16QAM). (LTE band 4(1.4MHz), LTE band 4(3MHz), LTE band 4(5MHz), LTE band 4(10MHz), LTE band 4(15MHz), LTE band 4(20MHz))
Data mode (LTE band 7(QPSK))	Keep the EUT in data communicating mode on LTE band 7(QPSK). (LTE band7(5MHz), LTE band 7(10MHz), LTE band 7(15MHz), LTE band 7(20MHz))
Data mode (LTE band 7(16QAM))	Keep the EUT in data communicating mode on LTE band 7(16QAM).(LTE band7(5MHz), LTE band7(10MHz), LTE band 7(15MHz), LTE band 7(20MHz))
Data mode (LTE band 12(QPSK))	Keep the EUT in data communicating mode on LTE band12(QPSK). (LTE band12(1.4MHz), LTE band12(3MHz), LTE band12(5MHz), LTE band12(10MHz))
Data mode (LTE band 12(16QAM))	Keep the EUT in data communicating mode on LTE band12(16QAM). (LTE band12(1.4MHz), LTE band12(3MHz), LTE band12(5MHz), LTE band12(10MHz))
Data mode (LTE band 17(QPSK))	Keep the EUT in data communicating mode on LTE band17(QPSK). (LTE band17(5MHz), LTE band17(10MHz))
Data mode (LTE band 17(16QAM))	Keep the EUT in data communicating mode on LTE band 17(16QAM).(LTE band17(5MHz), LTE band17(10MHz))
Remark :	Just the worst case data were shown in the report.

### 5.4 Related Submittal(s) / Grant (s)

This submittal(s) (test report) is filing to comply with Section Part 24 subpart E, Part 27 subpart L, Part 27 Subpart M and Part 27 subpart H of the FCC CFR 47 Rules.

### 5.5 Test Methodology

Both conducted and radiated testing were performed according to the procedures document on TIA/EIA 603 and FCC CFR 47clause 2.1046, 2.1047, 2.1049, 2.1051, 2.1053, 2.1055 and 2.1057

### 5.6 Laboratory Facility

The test facility is recognized, certified, or accredited by the following organizations:

● **FCC - Registration No.: 817957**

Shenzhen ZhongjianNanfang Testing Co., Ltd. EMC Laboratory has been registered and fully described in a report filed with the (FCC) Federal Communications Commission. The acceptance letter from the FCC is maintained in out files. Registration 817957, February 27, 2012.

● **IC - Registration No.: 10106A-1**

The 3m Semi-anechoic chamber of Shenzhen ZhongjianNanfang Testing Co., Ltd. has been Registered by Certification and Engineering Bureau of Industry Canada for radio equipment testing with Registration No.: 10106A-1.

● **CNAS - Registration No.: CNAS L6048**

Shenzhen ZhongjianNanfang Testing Co., Ltd. is accredited to ISO/IEC 17025:2005 General Requirements for the Competence of Testing and Calibration laboratories for the competence of testing. The Registration No. is CNAS L6048.

## 5.7 Laboratory Location

Shenzhen ZhongjianNanfang Testing Co., Ltd.  
 Address: No.B-C, 1/F., Building 2, Laodong No.2 Industrial Park, Xixiang Road,  
 Bao'an District, Shenzhen, Guangdong, China  
 Tel: +86-755-23118282  
 Fax: +86-755-23116366

## 5.8 Test Instruments list

Test Equipment	Manufacturer	Model No.	Inventory No.	Cal. Date (mm-dd-yy)	Cal. Due date (mm-dd-yy)
3m Semi- Anechoic Chamber	SAEMC	9(L)*6(W)* 6(H)	CCIS0001	08-23-2014	08-22-2017
BiConiLog Antenna	SCHWARZBECK MESS-ELEKTRONIK	VULB9163	CCIS0005	03-25-2016	03-25-2017
Double -ridged waveguide horn	SCHWARZBECK MESS-ELEKTRONIK	BBHA9120D	CCIS0006	03-25-2016	03-25-2017
EMI Test Software	AUDIX	E3	N/A	N/A	N/A
Amplifier (10kHz-1.3GHz)	HP	8447D	CCIS0003	04-01-2016	03-31-2017
Amplifier (1GHz-18GHz)	Compliance Direction Systems Inc.	PAP-1G18	CCIS0011	04-01-2016	03-31-2017
Pre-amplifier (18-26GHz)	Rohde & Schwarz	AFS33-18002 650-30-8P-44	GTS218	04-01-2016	03-31-2017
Horn Antenna	ETS-LINDGREN	3160	GTS217	04-01-2016	03-31-2017
Printer	HP	HP LaserJet P1007	N/A	N/A	N/A
Positioning Controller	UC	UC3000	CCIS0015	N/A	N/A
Spectrum analyzer 9k-30GHz	Rohde & Schwarz	FSP 30	CCIS0023	03-28-2016	03-28-2017
EMI Test Receiver	Rohde & Schwarz	ESPI	CCIS0022	03-28-2016	03-28-2017
EMI Test Receiver	Rohde & Schwarz	ESRP7	CCIS0167	03-24-2016	03-24-2017
Loop antenna	Laplace instrument	RF300	EMC0701	04-01-2016	03-31-2017
Universal radio communication tester	Rhode & Schwarz	CMU200	CCIS0069	03-28-2016	03-28-2017
Signal Analyzer	Rohde & Schwarz	FSIQ3	CCIS0088	04-08-2016	04-08-2017
DC Power Supply	Shenzhen XinNuoEr Technologies Co., Ltd.	WYK-10020K	CCIS0201	10-31-2015	10-30-2016
				10-31-2016	10-30-2017
Temperature Humidity Chamber	Fo Shan HengPu Electronics Co., Ltd.	HPGDS-500	CCIS0240	11-18-2016	11-27-2017

## 6. System test configuration

### 6.1 EUT Configuration

The EUT configuration for testing is installed on RF field strength measurement to meet the commission's requirement and operating in a manner which intends to maximize its emission characteristics in a continuous normal application.

### 6.2 EUT Exercise

The EUT (Transmitter) was operated in the engineering mode to fix the Tx frequency which was for the purpose of the measurements.

### 6.3 Configuration of Tested System

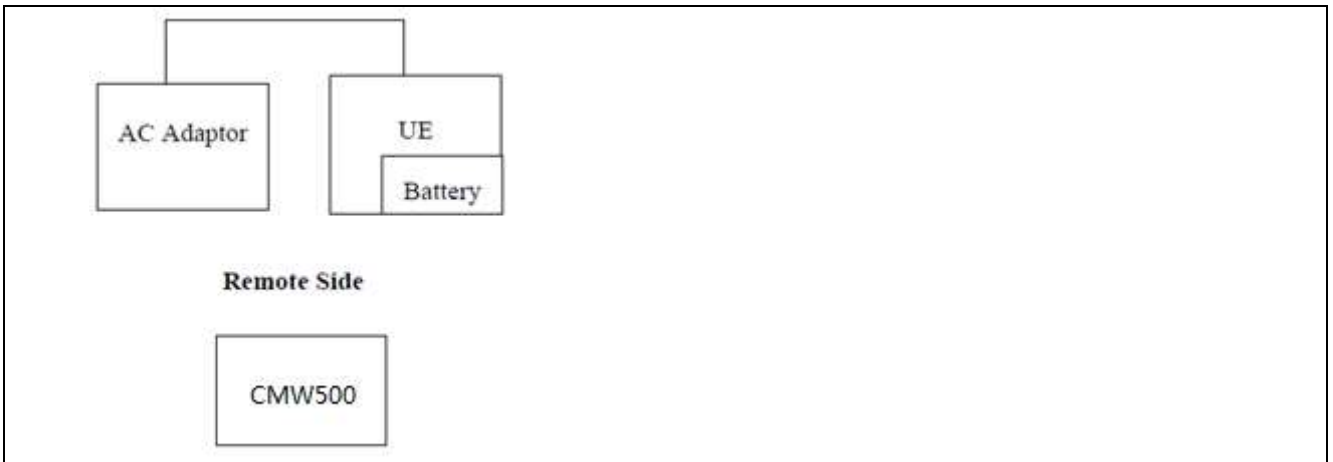

### 6.4 Description of Test Modes

The EUT has been tested under operating condition.  
 EUT staying in continuous transmitting mode. Channel Low, Mid and High for each type band with rated data rate were chosen for full testing.  
 The field strength of spurious radiation emission was measured as EUT stand-up position (H mode) and lie down position (E1, E2 mode) for three modes (LTE Band 2, LTE Band 4, LTE Band 7, LTE Band 12 and LTE Band 17) with power adaptor, earphone and Data cable. The worst-case H mode for LTE Band 2, LTE Band 4, LTE Band 7, LTE Band 12 and LTE Band 17.

## 6.5 Conducted Output Power

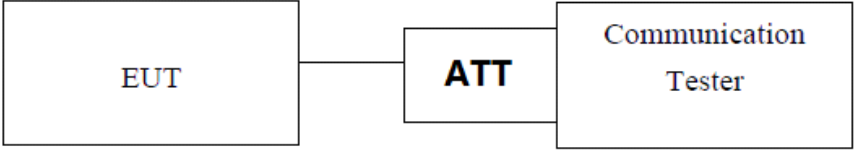
Test Requirement:	FCC Part 24.232 (c), part 27.50(c), part 27.50(d), Part 27.50 (h)
Test Method:	FCC part2.1046
Limit:	LTE Band2: 2W LTE Band 4: 1W LTE Band 7: 2W LTE Band 12: 3W LTE Band 17: 3W
Test setup:	 <p style="text-align: center;"><i>Note: Measurement setup for testing on Antenna connector</i></p>
Test Procedure:	The transmitter output was connected to a calibrated attenuator, the other end of which was connected to the CMW500. Transmitter output power was read off in dBm.
Test Instruments:	Refer to section 5.8 for details
Test mode:	Refer to section 5.3 for details
Test results:	Passed

**Measurement Data:  
LTE Band 2 part**

LTE Band	Bandwidth (MHz)	Modulation	RB Size	RB Offset	Average Power (dBm)		
					18607	18900	19193
					1850.7MHz	1880.0MHz	1909.3MHz
2	1.4	QPSK	1	0	22.37	22.27	22.17
			1	2	22.32	22.35	22.16
			1	5	22.33	22.28	22.14
			3	0	22.44	22.30	22.37
			3	1	22.44	22.40	22.40
			3	2	22.48	22.37	22.34
		16QAM	1	0	21.94	21.48	21.76
			1	2	21.91	21.79	21.68
			1	5	21.90	21.77	21.69
			3	0	21.65	21.52	21.45
			3	1	21.67	21.57	21.42
			3	2	21.75	21.54	21.38
			6	0	20.55	20.42	20.42
LTE Band	Bandwidth (MHz)	Modulation	RB Size	RB Offset	18615	18900	19185
					1851.5MHz	1880.0MHz	1908.5MHz
					2	3	QPSK
1	7	22.39	22.34	22.32			
1	14	22.33	22.32	22.25			
8	0	21.52	21.39	21.43			
8	4	21.55	21.43	21.38			
8	7	21.52	21.40	21.41			
16QAM	15	0	21.51	21.42			21.34
	1	0	21.54	21.56			21.74
	1	7	21.64	21.84			21.46
	1	14	21.57	21.84			21.38
	8	0	20.58	20.68			20.45
	8	4	20.55	20.48			20.44
	8	7	20.53	20.68			20.58
	15	0	20.51	20.50			20.44
					Average Power (dBm)		
LTE Band	Bandwidth (MHz)	Modulation	RB Size	RB Offset	18625	18900	19175
					1852.5MHz	1880.0MHz	1907.5MHz
					2	5	QPSK
1	12	22.42	22.40	22.31			
1	24	22.39	22.29	22.37			
12	0	21.60	21.46	21.44			
12	6	21.58	21.48	21.46			
12	11	21.52	21.49	21.44			
16QAM	25	0	21.51	21.39			21.42
	1	0	21.99	21.95			21.45
	1	12	21.51	21.57			21.84
	1	24	21.58	21.60			21.46
	12	0	20.68	20.57			20.54
	12	6	20.61	20.55			20.45
	12	11	20.66	20.60			20.47
	25	0	20.57	20.46			20.40



LTE Band	Bandwidth (MHz)	Modulation	RB Size	RB Offset	Average Power (dBm)		
					18650	18900	19150
					1855.0MHz	1880.0MHz	1905.0MHz
2	10	QPSK	1	0	22.59	22.47	22.39
			1	24	22.48	22.32	22.34
			1	49	22.41	22.27	22.32
			25	0	21.56	21.48	21.39
			25	12	21.51	21.41	21.40
			25	24	21.52	21.42	21.46
		16QAM	50	0	21.54	21.45	21.46
			1	0	21.75	21.64	21.57
			1	24	21.62	21.37	21.48
			1	49	21.62	21.49	21.44
			25	0	20.67	20.52	20.46
			25	12	20.58	20.47	20.42
			25	24	20.52	20.49	20.45
			50	0	20.57	20.51	20.46
LTE Band	Bandwidth (MHz)	Modulation	RB Size	RB Offset	Average Power (dBm)		
					18675	18900	19125
					1857.5MHz	1880.0MHz	1902.5MHz
2	15	QPSK	1	0	22.54	22.41	22.35
			1	37	22.48	22.37	22.34
			1	74	22.36	22.36	22.35
			36	0	21.60	21.51	21.48
			36	16	21.56	21.48	21.52
			36	35	21.54	21.54	21.49
		16QAM	75	0	21.53	21.45	21.45
			1	0	22.34	21.91	21.63
			1	37	21.90	22.13	21.70
			1	74	21.70	21.69	21.31
			36	0	20.67	20.55	20.44
			36	16	20.61	20.56	20.47
			36	35	20.51	20.54	20.45
			75	0	20.53	20.57	20.52
LTE Band	Bandwidth (MHz)	Modulation	RB Size	RB Offset	Average Power (dBm)		
					18700	18900	19100
					1860.0MHz	1880.0MHz	1900.0MHz
2	20	QPSK	1	0	22.61	22.48	22.43
			1	49	22.47	22.40	22.34
			1	99	22.39	22.33	22.44
			50	0	21.62	21.53	21.52
			50	24	21.57	21.48	21.46
			50	49	21.49	21.49	21.51
		16QAM	100	0	21.58	21.48	21.52
			1	0	22.34	21.79	22.19
			1	49	21.65	21.68	21.58
			1	99	21.67	21.58	21.63
			50	0	20.63	20.57	20.51
			50	24	20.56	20.53	20.48
			50	49	20.58	20.54	20.57
			100	0	20.54	20.49	20.54

**LTE Band 4 part**

LTE Band	Bandwidth (MHz)	Modulation	RB Size	RB Offset	Average Power (dBm)		
					19957	20175	20393
					1710.7MHz	1732.5MHz	1754.3MHz
4	1.4	QPSK	1	0	22.21	22.31	22.43
			1	2	22.24	22.33	22.45
			1	5	22.16	22.29	22.36
			3	0	22.29	22.39	22.55
			3	1	22.18	22.36	22.46
			3	2	22.25	22.40	22.53
		16QAM	6	0	21.29	21.38	21.47
			1	0	21.39	21.50	21.48
			1	2	21.39	21.45	21.50
			1	5	21.31	21.46	21.44
			3	0	21.37	21.53	21.68
			3	1	21.22	21.47	21.42
			3	2	21.29	21.52	21.44
			6	0	20.32	20.42	20.48
LTE Band	Bandwidth (MHz)	Modulation	RB Size	RB Offset	Average Power (dBm)		
					19965	20175	20385
					1711.5MHz	1732.5MHz	1753.5MHz
4	3	QPSK	1	0	22.14	22.21	22.34
			1	7	22.19	22.32	22.44
			1	14	22.19	22.24	22.42
			8	0	21.28	21.41	21.47
			8	4	21.27	21.43	21.52
			8	7	21.31	21.35	21.48
		16QAM	15	0	21.32	21.37	21.49
			1	0	21.29	21.21	21.28
			1	7	21.29	21.17	21.48
			1	14	21.54	21.43	21.67
			8	0	20.48	20.39	20.40
			8	4	20.32	20.36	20.52
			8	7	20.43	20.41	20.50
			15	0	20.32	20.45	20.53
LTE Band	Bandwidth (MHz)	Modulation	RB Size	RB Offset	Average Power (dBm)		
					19975	20175	20375
					1712.5MHz	1732.5MHz	1752.5MHz
4	5	QPSK	1	0	22.20	22.35	22.40
			1	12	22.24	22.31	22.50
			1	24	22.16	22.24	22.36
			12	0	21.31	21.42	21.49
			12	6	21.37	21.41	21.49
			12	11	21.28	21.39	21.49
		16QAM	25	0	21.29	21.36	21.47
			1	0	21.36	21.46	21.50
			1	12	21.72	21.49	21.51
			1	24	21.07	21.47	21.74
			12	0	20.33	20.48	20.51
			12	6	20.31	20.35	20.43
			12	11	20.38	20.45	20.40
			25	0	20.33	20.35	20.39

LTE Band	Bandwidth (MHz)	Modulation	RB Size	RB Offset	Average Power (dBm)		
					20000	20175	20350
					1715.0MHz	1732.5MHz	1750.0MHz
4	10	QPSK	1	0	22.21	22.34	22.40
			1	24	22.21	22.27	22.40
			1	49	22.19	22.34	22.30
			25	0	21.28	21.41	21.49
			25	12	21.27	21.34	21.45
			25	24	21.33	21.34	21.49
		16QAM	50	0	21.34	21.40	21.50
			1	0	21.38	21.18	21.32
			1	24	21.09	21.43	21.44
			1	49	21.39	21.76	21.45
			25	0	20.28	20.38	20.41
			25	12	20.25	20.38	20.39
			25	24	20.25	20.37	20.40
			50	0	20.29	20.37	20.40
LTE Band	Bandwidth (MHz)	Modulation	RB Size	RB Offset	Average Power (dBm)		
					20025	20175	20325
					1717.5MHz	1732.5MHz	1747.5MHz
4	15	QPSK	1	0	22.27	22.30	22.41
			1	37	22.22	22.27	22.32
			1	74	22.19	22.22	22.36
			36	0	21.36	21.42	21.50
			36	16	21.41	21.39	21.49
			36	35	21.39	21.38	21.54
		16QAM	75	0	21.39	21.39	21.50
			1	0	21.39	21.72	21.28
			1	37	21.60	21.75	21.52
			1	74	21.30	21.42	21.44
			36	0	20.33	20.36	20.43
			36	16	20.33	20.40	20.40
			36	35	20.28	20.36	20.44
			75	0	20.30	20.38	20.42
LTE Band	Bandwidth (MHz)	Modulation	RB Size	RB Offset	Average Power (dBm)		
					20050	20175	20300
					1720.0MHz	1732.5MHz	1745.0MHz
4	20	QPSK	1	0	22.34	22.43	22.52
			1	49	22.28	22.27	22.39
			1	99	22.28	22.33	22.37
			50	0	21.34	21.47	21.51
			50	24	21.35	21.42	21.43
			50	49	21.32	21.39	21.48
		16QAM	100	0	21.36	21.42	21.43
			1	0	21.28	21.58	21.70
			1	49	21.53	21.48	21.99
			1	99	21.38	21.97	21.58
			50	0	20.35	20.39	20.51
			50	24	20.30	20.32	20.40
			50	49	20.27	20.37	20.36
			100	0	20.25	20.38	20.44

**LTE Band 7 part**

LTE Band	Bandwidth (MHz)	Modulation	RB Size	RB Offset	Average Power (dBm)		
					20775	21100	21425
					2502.5MHz	2535.0MHz	2567.5MHz
7	5	QPSK	1	0	22.57	22.34	22.25
			1	12	22.60	22.46	22.25
			1	24	22.61	22.34	22.18
			12	0	21.78	21.55	21.40
			12	6	21.76	21.54	21.39
			12	11	21.76	21.49	21.38
		16QAM	25	0	21.65	21.53	21.32
			1	0	21.75	21.63	21.41
			1	12	21.75	21.55	21.40
			1	24	21.70	21.36	21.34
			12	0	20.60	20.52	20.43
			12	6	20.62	20.38	20.39
			12	11	20.80	20.55	20.38
			25	0	20.73	20.47	20.41
LTE Band	Bandwidth (MHz)	Modulation	RB Size	RB Offset	Average Power (dBm)		
					20800	21100	21400
					2505.0MHz	2535.0MHz	2565.0MHz
7	10	QPSK	1	0	22.65	22.44	22.35
			1	24	22.54	22.41	22.27
			1	49	22.61	22.41	22.14
			25	0	21.77	21.52	21.39
			25	12	21.74	21.51	21.42
			25	24	21.73	21.52	21.39
		16QAM	50	0	21.74	21.52	21.40
			1	0	21.83	21.58	21.45
			1	24	21.56	21.59	21.48
			1	49	21.65	21.49	21.66
			25	0	20.75	20.48	20.41
			25	12	20.66	20.46	20.34
			25	24	20.65	20.46	20.35
			50	0	20.70	20.47	20.44

LTE Band	Bandwidth (MHz)	Modulation	RB Size	RB Offset	Average Power (dBm)		
					20825	21100	21375
					2507.5MHz	2535.0MHz	2562.5MHz
7	15	QPSK	1	0	22.66	22.49	22.30
			1	37	22.63	22.39	22.33
			1	74	22.72	22.42	22.41
			36	0	21.80	21.63	21.50
			36	16	21.78	21.55	21.50
			36	35	21.76	21.56	21.49
			75	0	21.80	21.55	21.48
		16QAM	1	0	21.46	21.30	21.31
			1	37	21.76	21.73	21.51
			1	74	21.97	21.60	21.07
			36	0	20.74	20.65	20.49
			36	16	20.76	20.54	20.44
			36	35	20.71	20.50	20.47
			75	0	20.76	20.55	20.45
LTE Band	Bandwidth (MHz)	Modulation	RB Size	RB Offset	Average Power (dBm)		
					20850	21100	21350
					2510.0MHz	2535.0MHz	2560.0MHz
7	20	QPSK	1	0	22.41	22.62	22.50
			1	49	22.24	22.41	22.32
			1	99	22.46	22.46	22.51
			50	0	21.49	21.60	21.50
			50	24	21.46	21.49	21.47
			50	49	21.47	21.55	21.44
			100	0	21.46	21.58	21.43
		16QAM	1	0	22.02	21.67	21.55
			1	49	21.51	21.20	21.97
			1	99	21.44	21.41	21.44
			50	0	20.47	20.50	20.46
			50	24	20.45	20.51	20.41
			50	49	20.42	20.50	20.43
			100	0	20.44	20.46	20.44

LTE Band	Bandwidth (MHz)	Modulation	RB Size	RB Offset	Average Power (dBm)		
					23017	23095	23175
					699.7MHz	707.5MHz	715.3MHz
12	1.4	QPSK	1	0	22.34	22.34	22.28
			1	2	22.48	22.43	22.33
			1	5	22.43	22.33	22.25
			3	0	22.49	22.50	22.40
			3	1	22.48	22.39	22.33
			3	2	22.43	22.49	22.45
		16QAM	6	0	21.55	21.55	21.48
			1	0	21.70	21.47	21.54
			1	2	21.60	21.63	21.63
			1	5	21.55	21.56	21.52
			3	0	21.70	21.58	21.31
			3	1	21.55	21.40	21.54
			3	2	21.52	21.36	21.71
			6	0	20.49	20.42	20.41
LTE Band	Bandwidth (MHz)	Modulation	RB Size	RB Offset	Average Power (dBm)		
					23025	23095	23165
					700.5MHz	707.5MHz	714.5MHz
12	3	QPSK	1	0	22.25	22.34	22.33
			1	7	22.40	22.35	22.30
			1	14	22.30	22.28	22.24
			8	0	21.55	21.55	21.47
			8	4	21.48	21.52	21.54
			8	7	21.51	21.52	21.53
		16QAM	15	0	21.48	21.49	21.45
			1	0	21.94	21.50	21.28
			1	7	21.76	21.43	21.39
			1	14	21.94	21.56	21.50
			8	0	20.47	20.64	20.45
			8	4	20.57	20.50	20.44
			8	7	20.57	20.47	20.66
			15	0	20.52	20.34	20.34
LTE Band	Bandwidth (MHz)	Modulation	RB Size	RB Offset	Average Power (dBm)		
					23035	23095	23155
					701.5MHz	707.5MHz	713.5MHz
12	5	QPSK	1	0	22.40	22.38	22.37
			1	12	22.43	22.37	22.38
			1	24	22.44	22.35	22.29
			12	0	21.54	21.56	21.51
			12	6	21.53	21.44	21.55
			12	11	21.57	21.59	21.51
		16QAM	25	0	21.44	21.46	21.47
			1	0	21.57	21.64	21.70
			1	12	21.47	21.62	21.48
			1	24	21.96	21.93	21.64
			12	0	20.59	20.48	20.48
			12	6	20.47	20.36	20.54
			12	11	20.40	20.56	20.51
			25	0	20.41	20.45	20.46

LTE Band	Bandwidth (MHz)	Modulation	RB Size	RB Offset	Average Power (dBm)		
					23060	23095	23130
					704.0MHz	707.5MHz	711.0MHz
12	10	QPSK	1	0	22.39	22.41	22.36
			1	24	22.40	22.42	22.45
			1	49	22.44	22.41	22.37
			25	0	21.41	21.50	21.49
			25	12	21.50	21.50	21.50
			25	24	21.57	21.54	21.54
		16QAM	50	0	21.54	21.54	21.48
			1	0	21.63	21.61	21.67
			1	24	21.64	21.35	21.39
			1	49	21.60	21.60	21.66
			25	0	20.41	20.41	20.46
			25	12	20.47	20.43	20.57
			25	24	20.52	20.46	20.50
			50	0	20.49	20.40	20.52

**LTE Band 17 part**

LTE Band	Bandwidth (MHz)	Modulation	RB Size	RB Offset	Average Power (dBm)		
					23755	23790	23825
					706.5MHz	710.0MHz	713.5MHz
17	5	QPSK	1	0	22.25	22.26	22.13
			1	12	22.33	22.23	22.19
			1	24	22.40	22.25	22.12
			12	0	21.25	21.12	21.20
			12	6	21.30	21.15	21.23
			12	11	21.12	21.10	21.23
		16QAM	25	0	21.02	21.12	21.22
			1	0	21.13	21.20	21.38
			1	12	21.25	21.09	21.13
			1	24	21.22	21.11	21.13
			12	0	20.31	20.05	20.12
			12	6	20.36	20.06	20.18
			12	11	20.35	20.05	20.13
			25	0	20.16	20.02	20.15

LTE Band	Bandwidth (MHz)	Modulation	RB Size	RB Offset	Average Power (dBm)		
					23780	23790	23800
					709.0MHz	710.0MHz	711.0MHz
17	10	QPSK	1	0	22.12	22.13	22.00
			1	24	22.17	22.07	22.03
			1	49	22.32	22.17	22.04
			25	0	21.14	21.01	21.09
			25	12	21.27	21.12	21.20
			25	24	20.97	20.95	21.08
		16QAM	50	0	20.80	20.90	21.00
			1	0	21.03	21.10	21.28
			1	24	21.19	21.03	21.07
			1	49	21.04	20.93	20.95
			25	0	20.20	19.94	20.01
			25	12	20.31	20.01	20.13
			25	24	20.19	19.89	19.97
			50	0	20.08	19.94	20.07

## 6.6 Peak-to-Average Ratio

Test Requirement:	FCC part 24.232(d)
Limit:	The peak-to-average ratio (PAR) of the transmission may not exceed 13 dB.
Test setup:	 <p><i>Note: Measurement setup for testing on Antenna connector</i></p>
Test Procedure:	<ol style="list-style-type: none"> <li>1 The RF output of the transceiver was connected to a spectrum analyzer through appropriate attenuation.</li> <li>2 Set the CCDF option in spectrum analyzer, <math>RBW \geq OBW</math>,</li> <li>3 Set the EUT working in highest power level, measured and recorded the 0.1% as PAPR level.</li> <li>4 Repeat step 1~3 at other frequency and modulations.</li> </ol>
Test Instruments:	Refer to section 5.8 for details
Test mode:	Refer to section 5.3 for details
Test results:	Passed

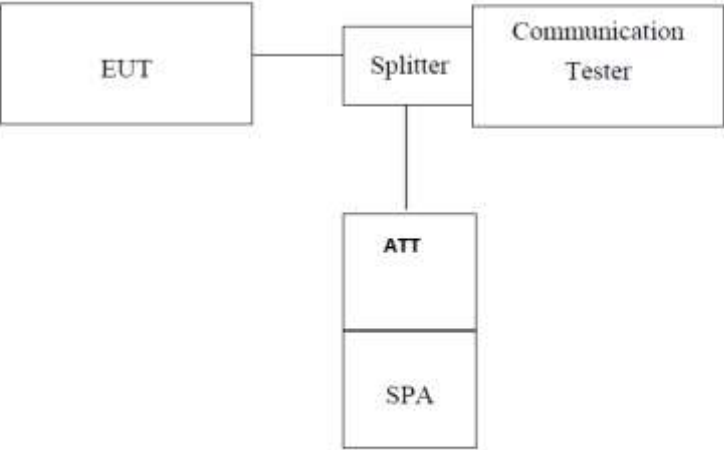

**Measurement Data:**

BW(MHz)	Modulation	RB Size	RB Offset	PAPR
LTE Band 2 (Middle Channel)				
20MHz	QPSK	100	0	4.35
	16QAM	100	0	6.06
LTE Band 4 (Middle Channel)				
20MHz	QPSK	100	0	3.65
	16QAM	100	0	5.65
LTE Band 7 (Middle Channel)				
20MHz	QPSK	100	0	3.71
	16QAM	100	0	5.77
LTE Band 12 (Middle Channel)				
10MHz	QPSK	100	0	4.72
	16QAM	100	0	6.58
LTE Band 17 (Middle Channel)				
10MHz	QPSK	50	0	5.88
	16QAM	50	0	6.67

Test plots as below:

### LTE Band 2 Middle channel

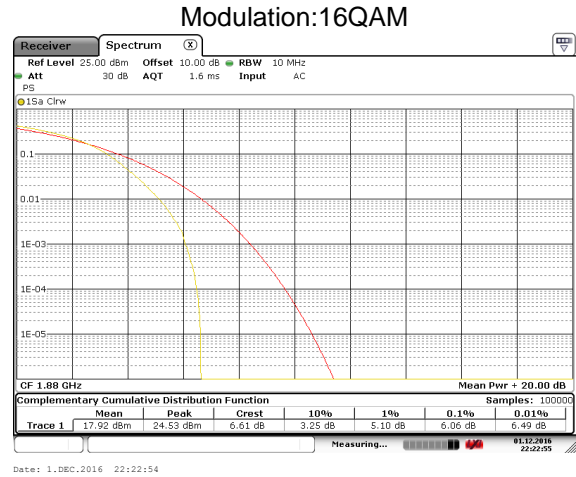
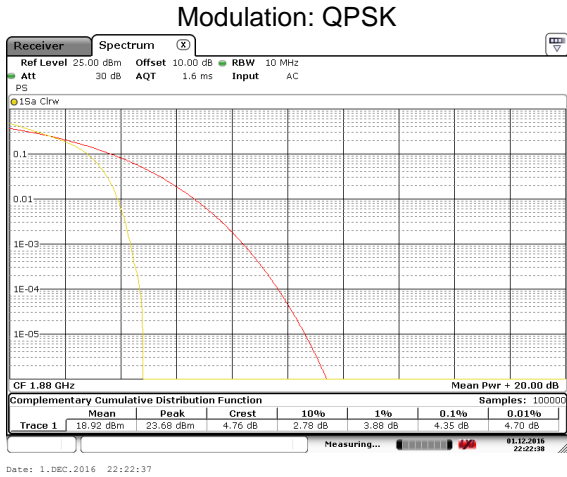

### LTE Band 4 Middle channel

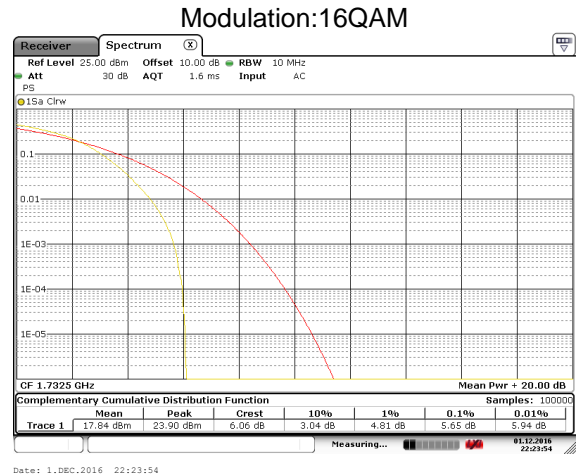
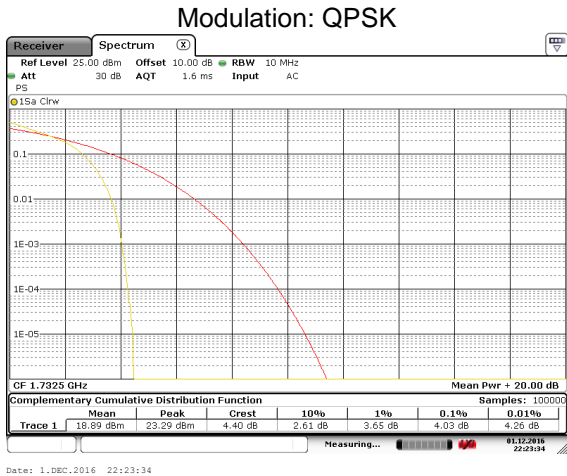

### LTE Band 7 Middle channel

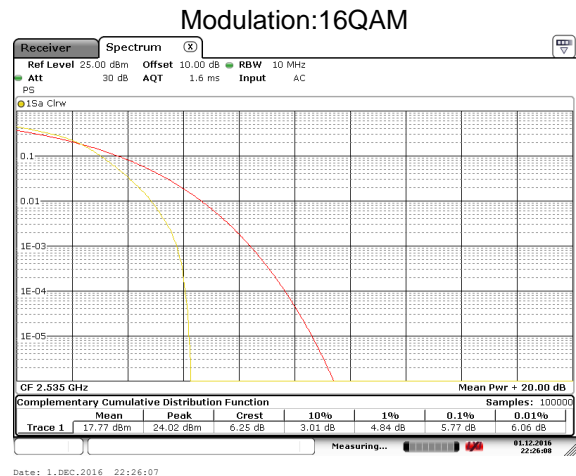
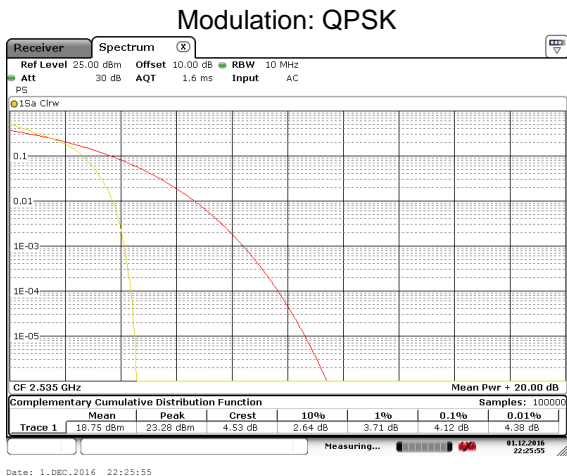

## LTE Band 12 Middle channel

Modulation: QPSK

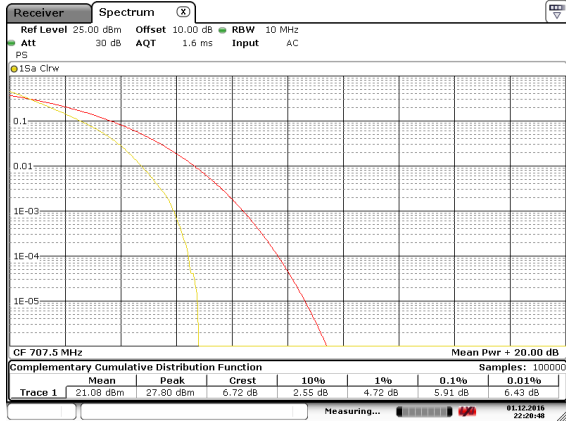

Date: 1.DEC.2016 22:20:47

Modulation:16QAM

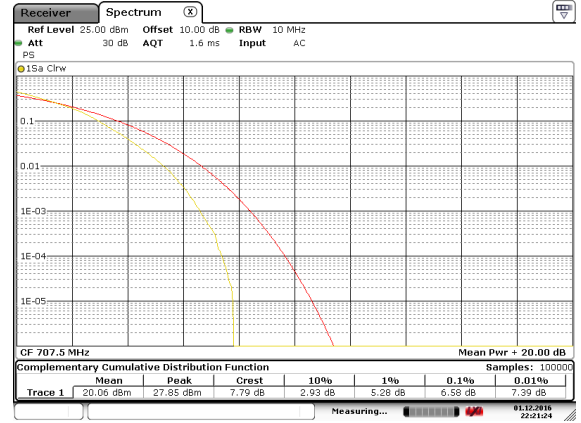

Date: 1.DEC.2016 22:21:24

## LTE Band 17 Middle channel

Modulation: QPSK

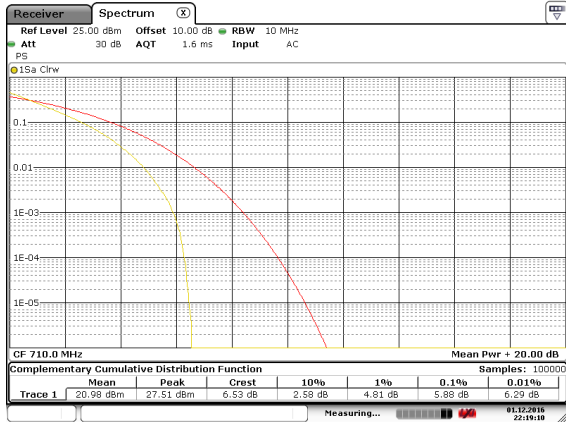

Date: 1.DEC.2016 22:19:10

Modulation:16QAM

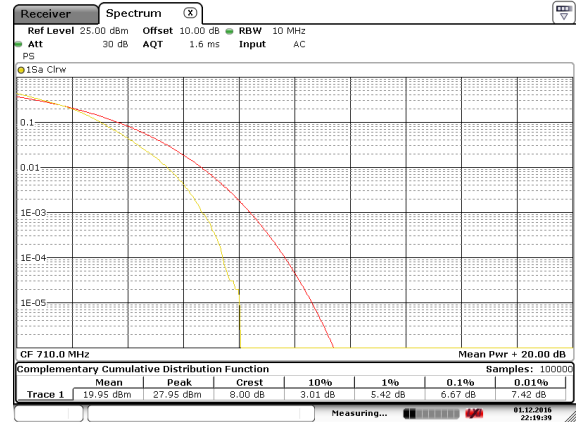

Date: 1.DEC.2016 22:19:39

## 6.7 Occupy Bandwidth

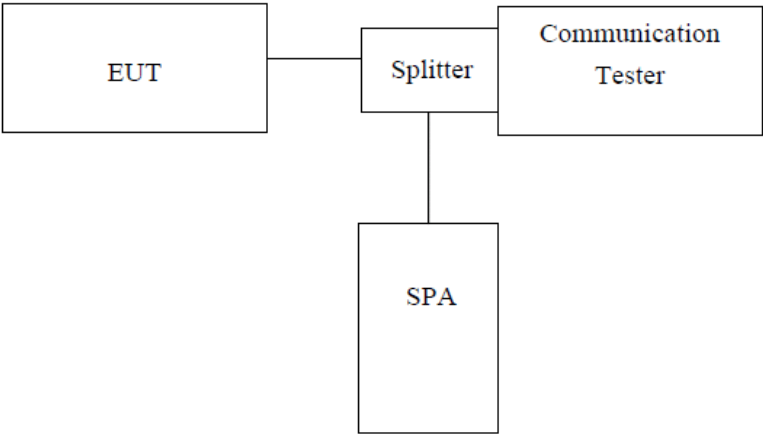
Test Requirement:	FCC Part 24.238, part 27.53(g), part 27.53(h), Part 27.53(m)
Test Method:	FCC part2.1049
Test setup:	 <p style="text-align: center;"><i>Note: Measurement setup for testing on Antenna connector</i></p>
Test Procedure:	<ol style="list-style-type: none"> <li>1. The EUT's output RF connector was connected with a short cable to the spectrum analyzer</li> <li>2. RBW was set to about 1% ~ 5% of emission BW, VBW= 3 times RBW.</li> <li>3. -26dBc display line was placed on the screen (or 99% bandwidth), the occupied bandwidth is the delta frequency between the two points where the display line intersects the signal trace.</li> </ol>
Test Instruments:	Refer to section 5.8 for details
Test mode:	Refer to section 5.3 for details
Test results:	Passed

**Measurement Data:**  
**LTE Band 2 part:**

EUT Mode	Channel	Frequency(MHz)	Modulation	99% OBW (kHz)	-26dBcEBW (kHz)
1.4MHz	18607	1850.70	16QAM	1098	1272
			QPSK	1104	1272
	18900	1880.00	16QAM	1098	1260
			QPSK	1104	1266
	19193	1909.30	16QAM	1098	1266
			QPSK	1104	1266
3MHz	18615	1851.50	16QAM	2736	3036
			QPSK	2736	3048
	18900	1880.00	16QAM	2724	3036
			QPSK	2736	3060
	19185	1908.50	16QAM	2724	3024
			QPSK	2736	3060
5MHz	18625	1852.50	16QAM	4520	4980
			QPSK	4540	5040
	18900	1880.00	16QAM	4520	5040
			QPSK	4540	5020
	19175	1907.50	16QAM	4520	4980
			QPSK	4540	5060
10MHz	18650	1855.00	16QAM	9120	10240
			QPSK	9120	10320
	18900	1880.00	16QAM	9080	10240
			QPSK	9120	10320
	19150	1905.00	16QAM	9120	10120
			QPSK	9120	10240
15MHz	18675	1857.50	16QAM	13560	14820
			QPSK	13560	15000
	18900	1880.00	16QAM	13500	14940
			QPSK	13500	14940
	19125	1902.50	16QAM	13560	14880
			QPSK	13560	15000
20MHz	18700	1860.00	16QAM	17920	19360
			QPSK	17920	19520
	18900	1880.00	16QAM	17920	19280
			QPSK	18080	19600
	19100	1900.00	16QAM	17920	19360
			QPSK	18000	19520

**LTE Band 4 part:**

EUT Mode	Channel	Frequency(MHz)	Modulation	99% OBW (kHz)	-26dBcEBW (kHz)
1.4MHz	19957	1710.7	16QAM	1098	1266
			QPSK	1104	1266
	20175	1732.5	16QAM	1098	1272
			QPSK	1098	1272
	20393	1754.3	16QAM	1098	1272
			QPSK	1110	1278
3MHz	19965	1711.5	16QAM	2724	3000
			QPSK	2736	3036
	20175	1732.5	16QAM	2724	3024
			QPSK	2736	3048
	20385	1750.5	16QAM	2724	3036
			QPSK	2736	3060
5MHz	19975	1712.5	16QAM	4520	4980
			QPSK	4520	5000
	20175	1732.5	16QAM	4520	4960
			QPSK	4540	5040
	20375	1752.5	16QAM	4520	4940
			QPSK	4520	5040
10MHz	20000	1715.0	16QAM	9040	10080
			QPSK	9120	10280
	20175	1732.5	16QAM	9080	10160
			QPSK	9080	10280
	20350	1750.0	16QAM	9120	10120
			QPSK	9080	10200
15MHz	20025	1717.5	16QAM	13500	14820
			QPSK	13560	15000
	20175	1732.5	16QAM	13560	14820
			QPSK	13560	15000
	20325	1747.5	16QAM	13500	14700
			QPSK	13560	14940
20MHz	20050	1720.0	16QAM	17920	19280
			QPSK	18000	19600
	20175	1732.5	16QAM	18000	19520
			QPSK	18080	19600
	20300	1745.0	16QAM	18000	19280
			QPSK	17920	19440

**LTE Band 7 part:**

EUT Mode	Channel	Frequency (MHz)	Modulation	99% OBW (kHz)	-26dB EBW (kHz)
5MHz	20775	2502.5	16QAM	4520	5000
			QPSK	4520	5080
	21100	2535.0	16QAM	4520	4980
			QPSK	4540	4980
	21425	2567.5	16QAM	4520	1900
			QPSK	4520	5020
10MHz	20800	2505.0	16QAM	9080	10080
			QPSK	9120	10280
	21100	2535.0	16QAM	9120	10040
			QPSK	9120	10320
	21400	2565.0	16QAM	9120	10160
			QPSK	9120	10360
15MHz	20825	2507.5	16QAM	13560	14820
			QPSK	13500	15000
	21100	2535.0	16QAM	13500	14820
			QPSK	13560	14940
	21375	2562.5	16QAM	13560	14820
			QPSK	13560	14940
20MHz	20850	2510.0	16QAM	17920	19440
			QPSK	18000	19520
	21100	2535.0	16QAM	18000	19360
			QPSK	18080	19520
	21350	2560.0	16QAM	17920	19440
			QPSK	18000	19520

**LTE Band 12 part:**

EUT Mode	Channel	Frequency (MHz)	Modulation	99% OBW (kHz)	-26dB EBW (kHz)
1.4MHz	23017	699.70	16QAM	1098	1254
			QPSK	1104	1272
	23095	707.50	16QAM	1098	1266
			QPSK	1098	1272
	23175	715.30	16QAM	1098	1248
			QPSK	1098	1266
3MHz	23025	700.50	16QAM	2724	3000
			QPSK	2748	3036
	23095	707.50	16QAM	2724	3000
			QPSK	2748	3048
	23165	714.50	16QAM	2736	2988
			QPSK	2736	3036
5MHz	23035	701.50	16QAM	4500	4960
			QPSK	4500	4960
	23095	707.50	16QAM	4520	4920
			QPSK	4540	5000
	23155	713.50	16QAM	4500	4980
			QPSK	4520	5000
10MHz	23060	704.00	16QAM	9080	10040
			QPSK	9080	10240
	23095	707.50	16QAM	9160	10120
			QPSK	9160	10280
	23130	711.00	16QAM	9040	10040
			QPSK	9120	10240

**LTE Band 17 part:**

EUT Mode	Channel	Frequency (MHz)	Modulation	99% OBW (kHz)	-26dB EBW (kHz)
5MHz	23755	706.5	16QAM	4520	4900
			QPSK	4520	5000
	23790	710.0	16QAM	4520	4980
			QPSK	4540	5040
	23825	713.5	16QAM	4520	4920
			QPSK	4520	5020
10MHz	23780	709.0	16QAM	9120	10080
			QPSK	9160	10320
	23790	710.0	16QAM	9120	10080
			QPSK	9120	10320
	23800	711.0	16QAM	9120	10200
			QPSK	9120	10240



Test plot as follows:  
LTE Band 2 part

Test Item:99% Occupy bandwidth  
BW: 1.4MHz

Modulation: 16QAM

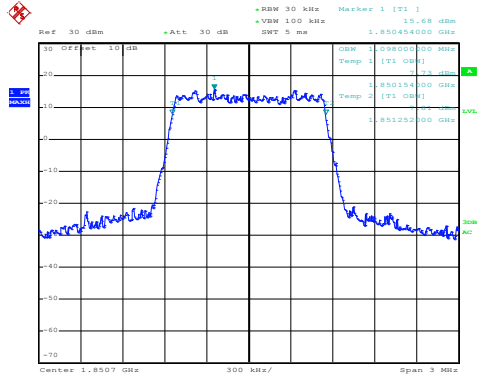

Date: 24.NOV.2016 22:36:02

Modulation: QPSK

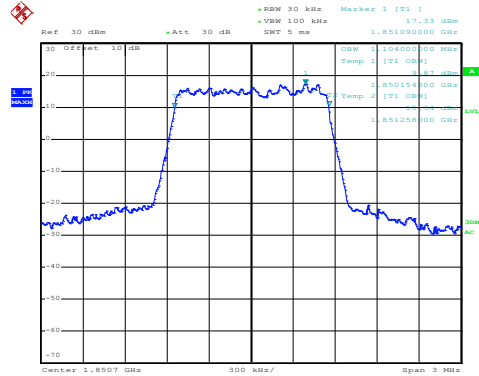

Date: 24.NOV.2016 22:35:49

Lowest channel

Modulation:16QAM

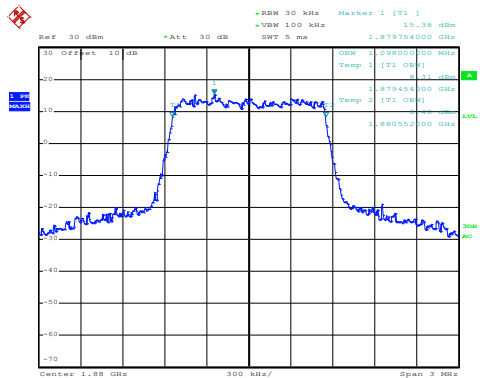

Date: 24.NOV.2016 22:38:09

Modulation: QPSK

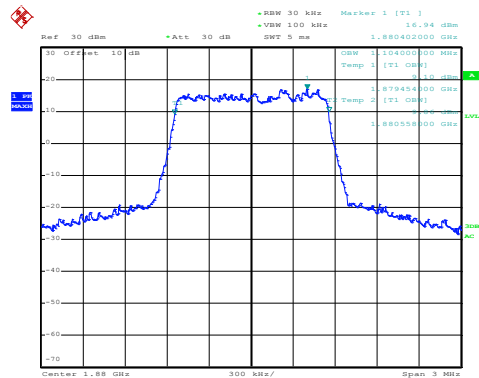

Date: 24.NOV.2016 22:38:02

Middle channel

Modulation:16QAM

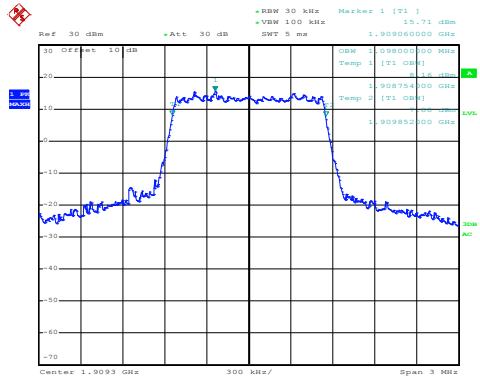

Date: 24.NOV.2016 22:38:58

Modulation: QPSK

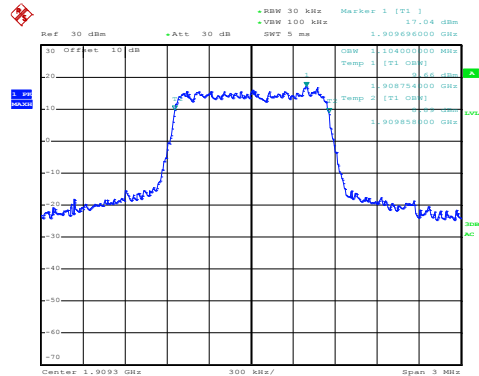

Date: 24.NOV.2016 22:38:37

Highest channel

Test Item:99% Occupy bandwidth  
BW: 3MHz

Modulation:16QAM

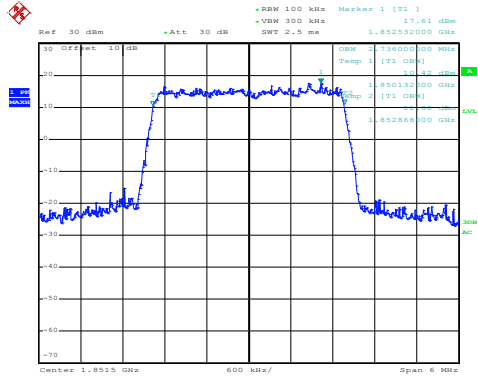

Date: 24.NOV.2016 22:40:56

Modulation: QPSK

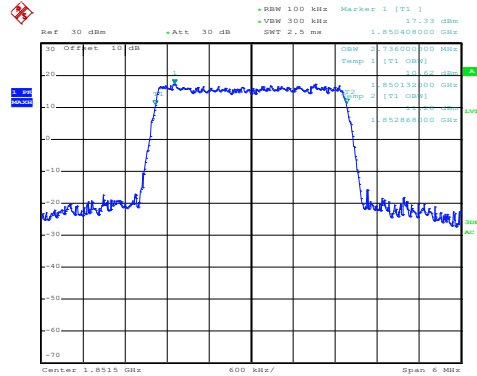

Date: 24.NOV.2016 22:40:45

Lowest channel

Modulation:16QAM

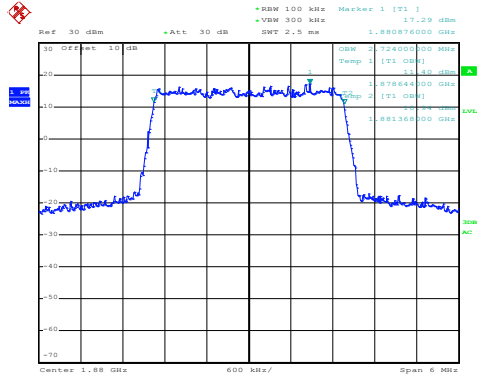

Date: 24.NOV.2016 22:41:31

Modulation: QPSK

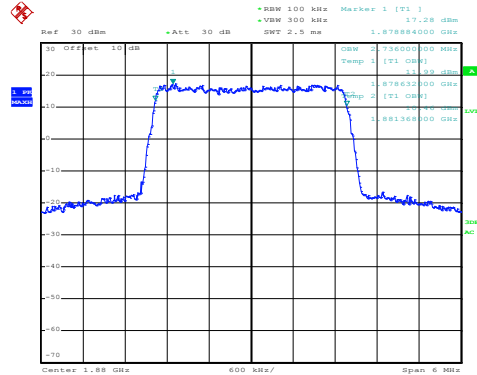

Date: 24.NOV.2016 22:41:23

Middle channel

Modulation:16QAM

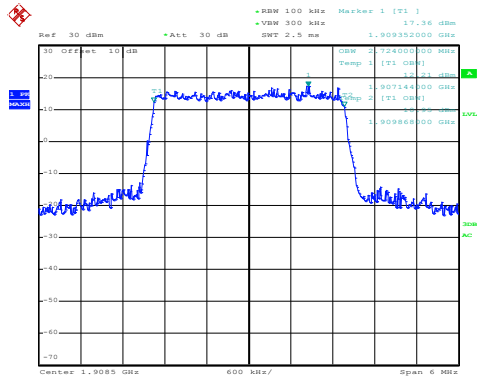

Date: 24.NOV.2016 22:43:11

Modulation: QPSK

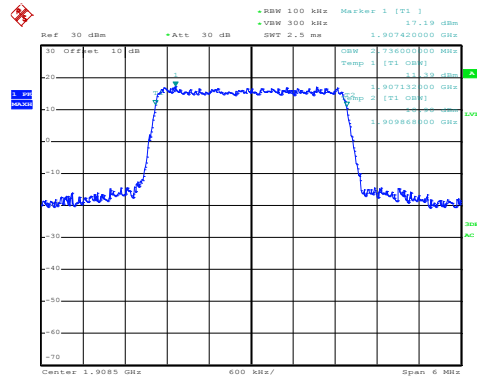

Date: 24.NOV.2016 22:43:02

Highest channel

Test Item: 99% Occupancy bandwidth  
BW: 5MHz

Modulation: 16QAM

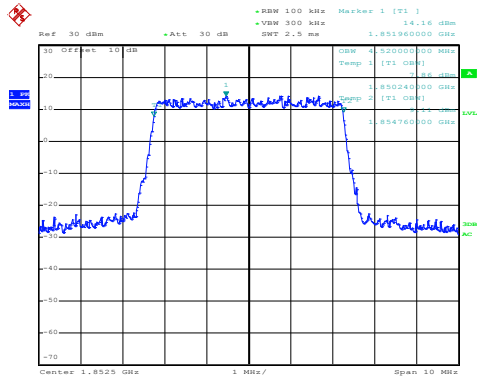

Date: 24.NOV.2016 22:44:33

Modulation: QPSK

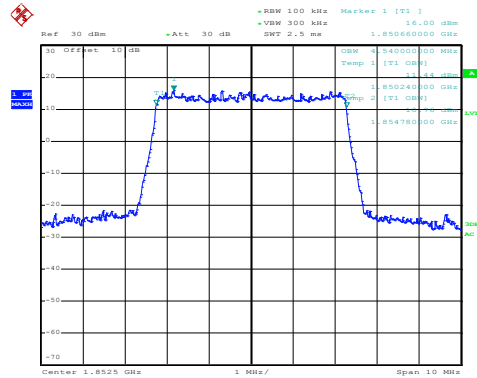

Date: 24.NOV.2016 22:44:21

Lowest channel

Modulation: 16QAM

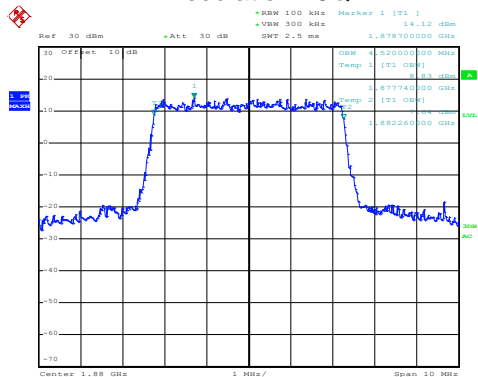

Date: 24.NOV.2016 22:45:49

Modulation: QPSK

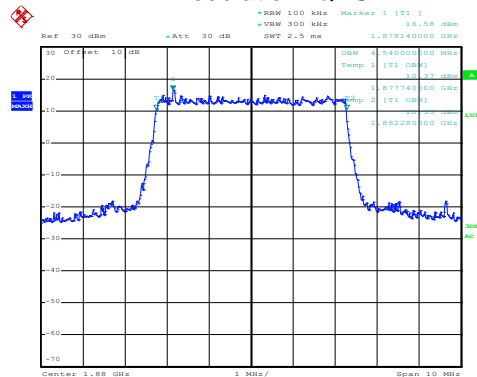

Date: 24.NOV.2016 22:45:41

Middle channel

Modulation: 16QAM

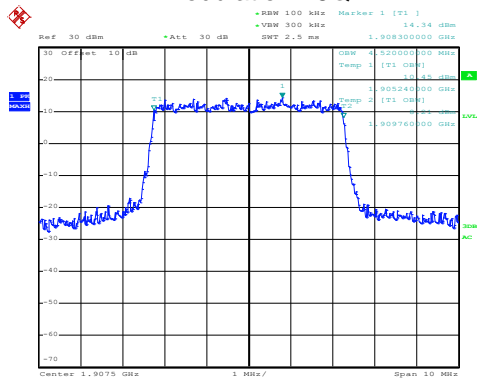

Date: 24.NOV.2016 22:46:20

Modulation: QPSK

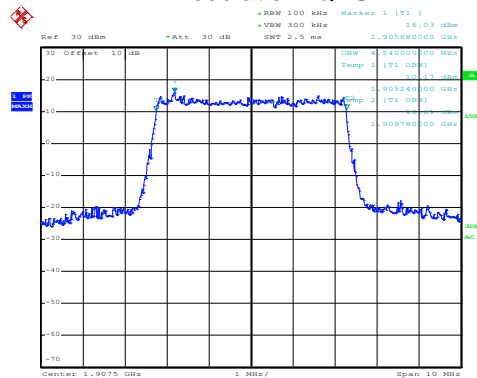

Date: 24.NOV.2016 22:46:13

Highest channel

Test Item:99% Occupy bandwidth  
BW: 10MHz

Modulation:16QAM

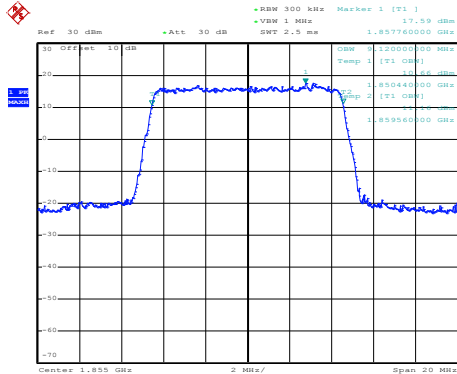

Date: 24.NOV.2016 22:59:13

Modulation: QPSK

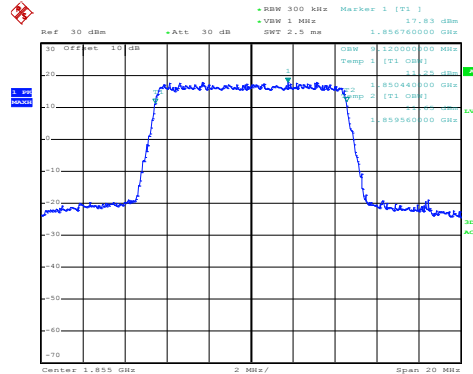

Date: 24.NOV.2016 22:48:05

Lowest channel

Modulation:16QAM

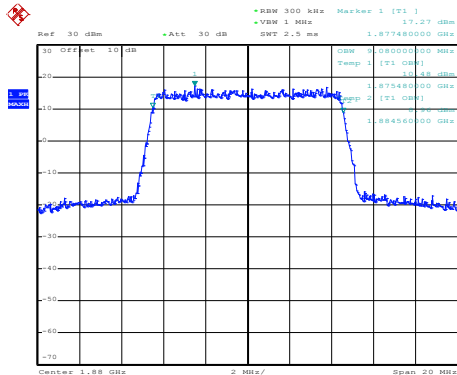

Date: 24.NOV.2016 22:48:44

Modulation: QPSK

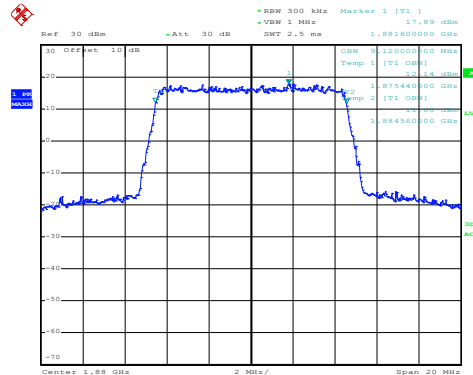

Date: 24.NOV.2016 22:48:36

Middle channel

Modulation:16QAM

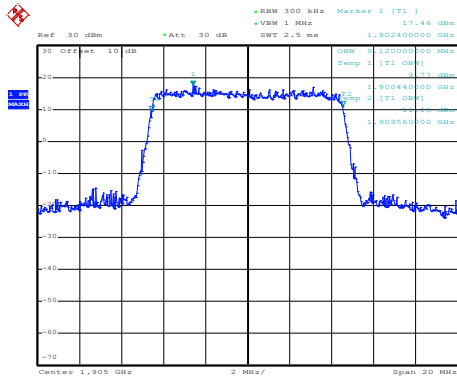

Date: 24.NOV.2016 22:49:54

Modulation: QPSK

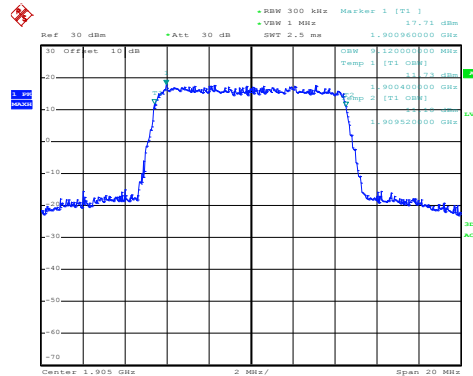

Date: 24.NOV.2016 22:49:47

Highest channel

Test Item:99% Occupy bandwidth  
BW: 15MHz

Modulation:16QAM

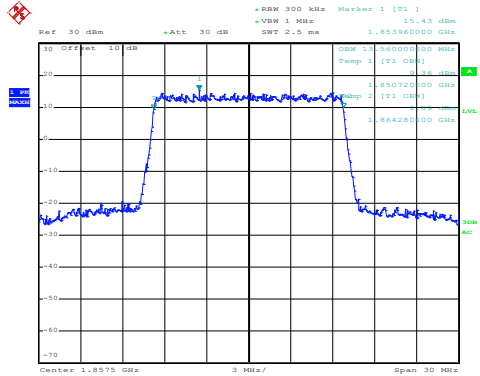

Date: 24.NOV.2016 22:50:57

Modulation: QPSK

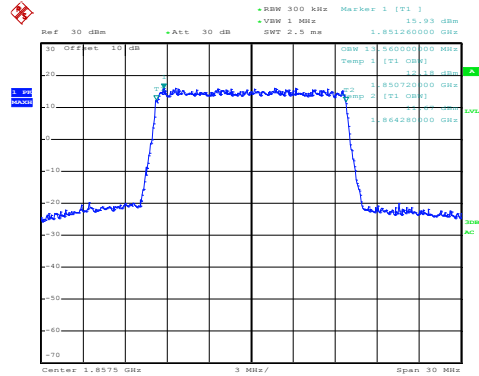

Date: 24.NOV.2016 22:50:50

Lowest channel

Modulation:16QAM

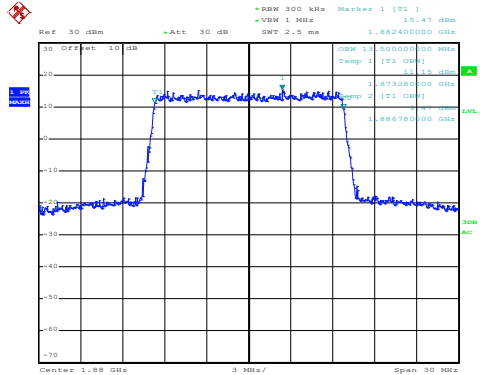

Date: 24.NOV.2016 22:52:12

Modulation: QPSK

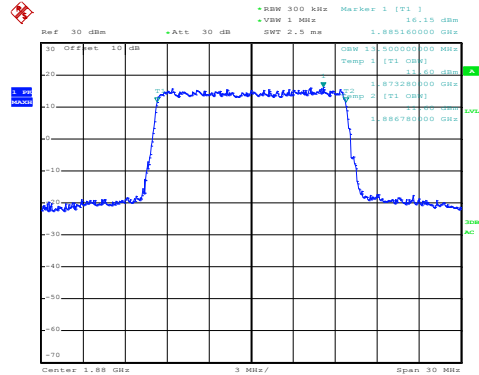

Date: 24.NOV.2016 22:52:04

Middle channel

Modulation:16QAM

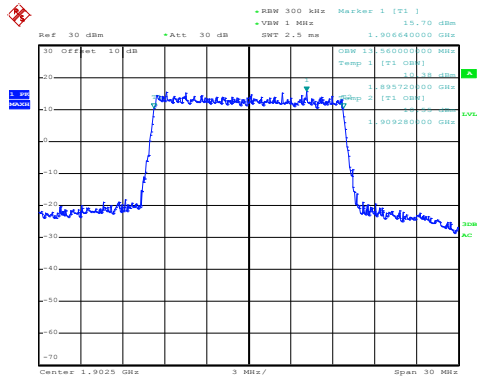

Date: 24.NOV.2016 22:52:40

Modulation: QPSK

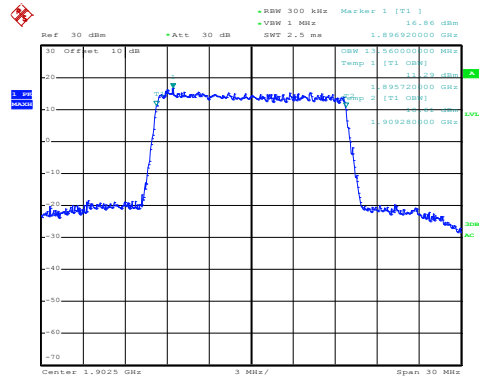

Date: 24.NOV.2016 22:52:33

Highest channel

Test Item:99% Occupy bandwidth  
BW: 20MHz

Modulation:16QAM

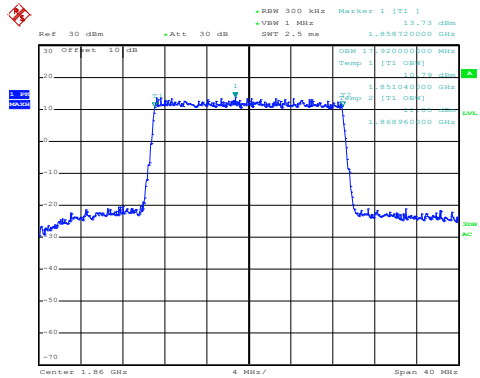

Date: 24.NOV.2016 22:54:14

Modulation: QPSK

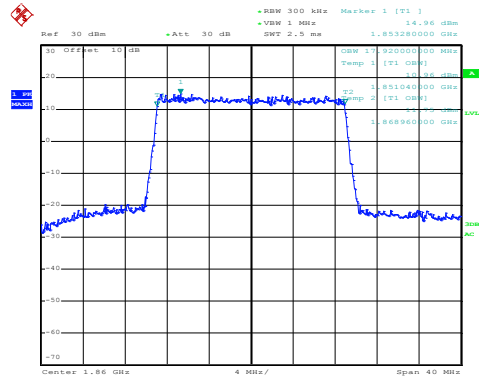

Date: 24.NOV.2016 22:54:07

Lowest channel

Modulation:16QAM

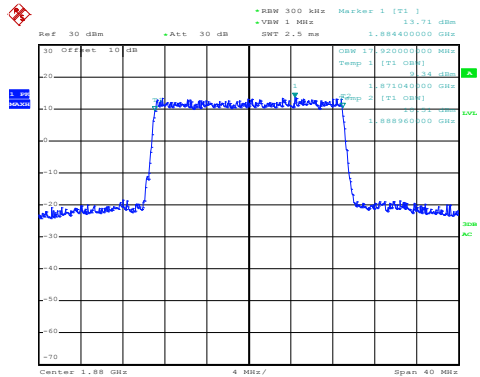

Date: 24.NOV.2016 22:54:43

Modulation: QPSK

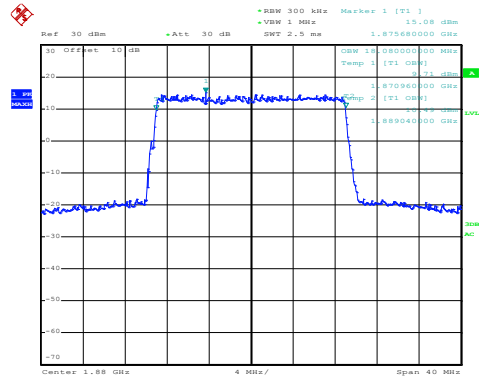

Date: 24.NOV.2016 22:54:35

Middle channel

Modulation:16QAM

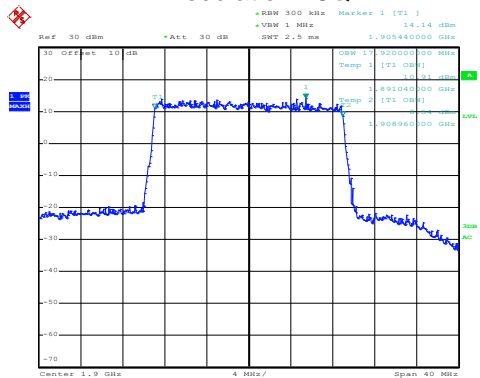

Date: 24.NOV.2016 22:55:51

Modulation: QPSK

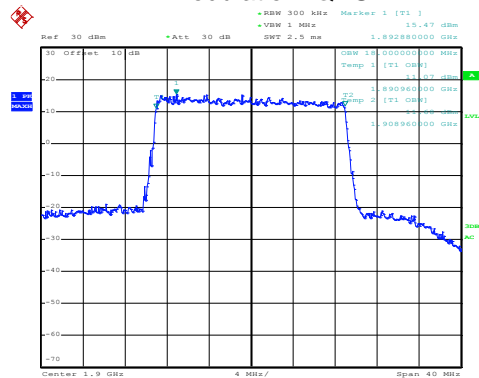

Date: 24.NOV.2016 22:55:43

Highest channel

Test Item:-26dBc bandwidth  
BW: 1.4MHz

Modulation:16QAM

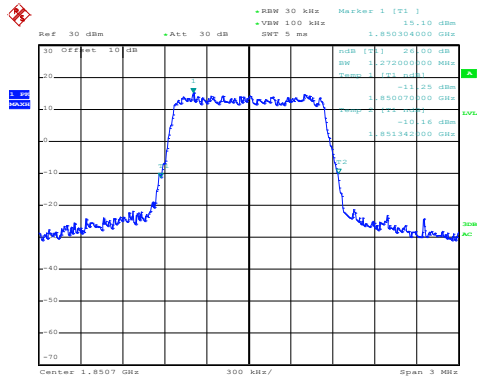

Date: 24.NOV.2016 22:37:14

Modulation: QPSK

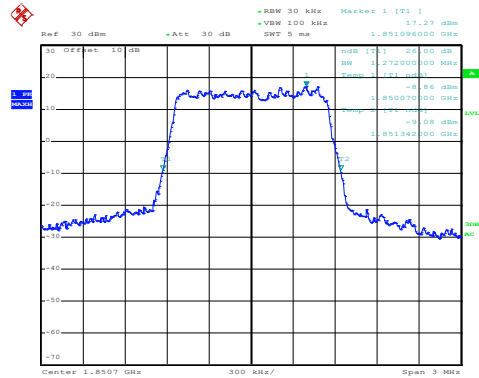

Date: 24.NOV.2016 22:36:20

Lowest channel

Modulation:16QAM

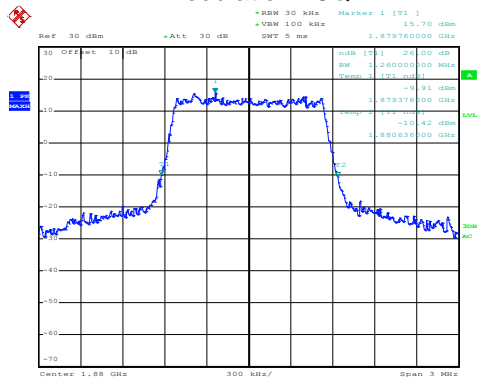

Date: 24.NOV.2016 22:37:45

Modulation: QPSK

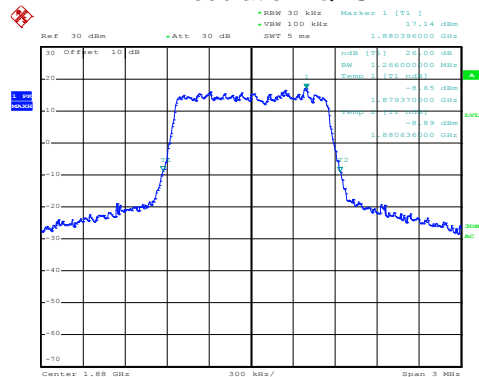

Date: 24.NOV.2016 22:37:37

Middle channel

Modulation:16QAM

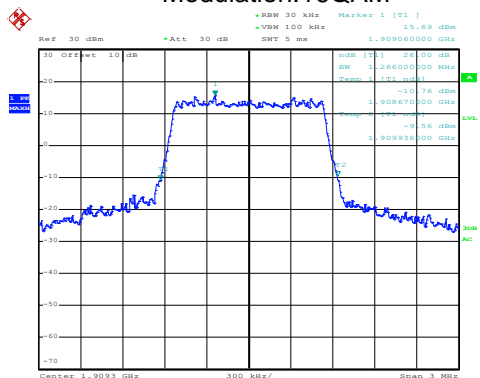

Date: 24.NOV.2016 22:39:28

Modulation: QPSK

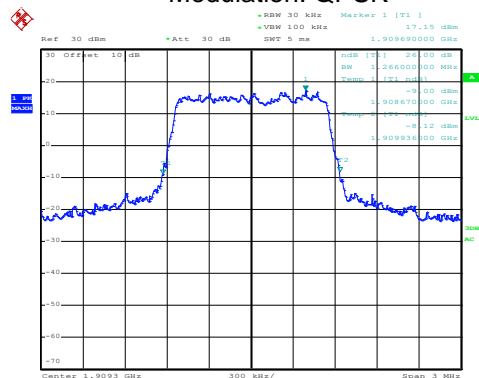

Date: 24.NOV.2016 22:39:17

Highest channel

Test Item:-26dBc bandwidth  
BW: 3MHz

Modulation:16QAM

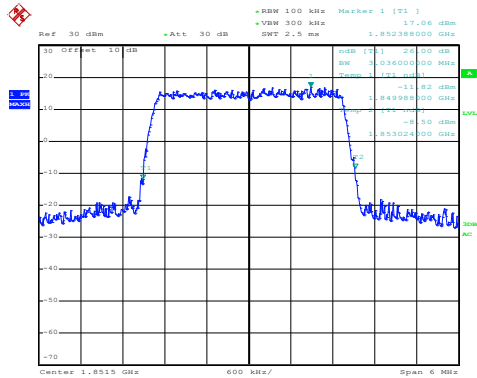

Date: 24.NOV.2016 22:40:32

Modulation: QPSK

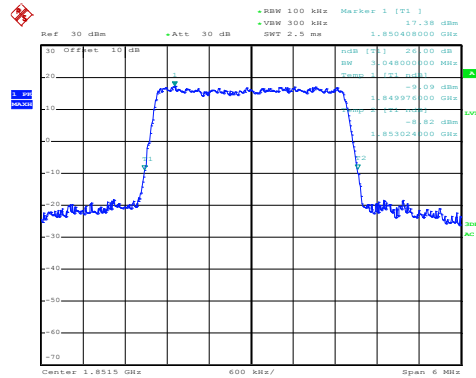

Date: 24.NOV.2016 22:40:22

Lowest channel

Modulation:16QAM

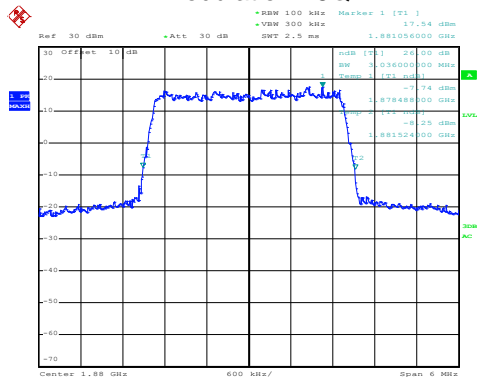

Date: 24.NOV.2016 22:41:56

Modulation: QPSK

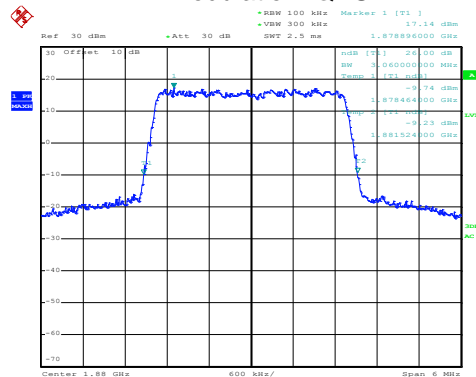

Date: 24.NOV.2016 22:41:45

Middle channel

Modulation:16QAM

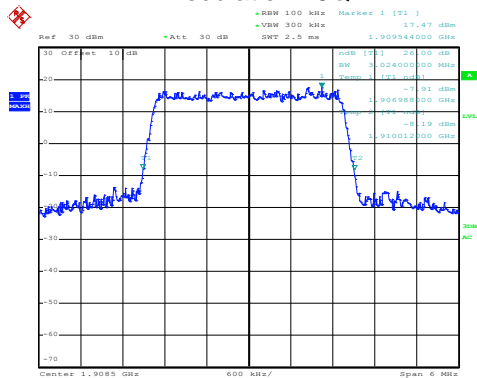

Date: 24.NOV.2016 22:42:45

Modulation: QPSK

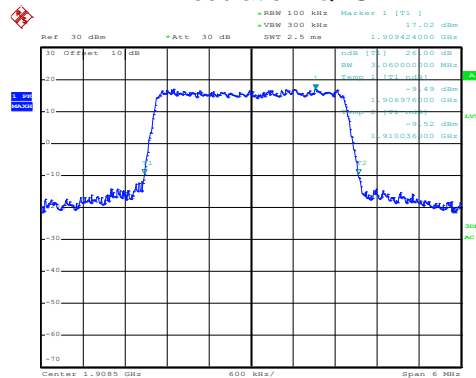

Date: 24.NOV.2016 22:42:28

Highest channel



Test Item:-26dBc bandwidth  
BW: 5MHz

Modulation:16QAM

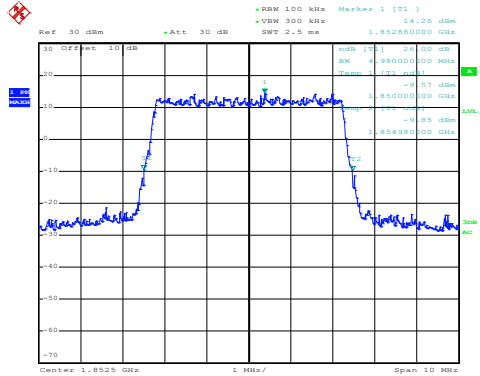

Date: 24.NOV.2016 22:45:00

Modulation: QPSK

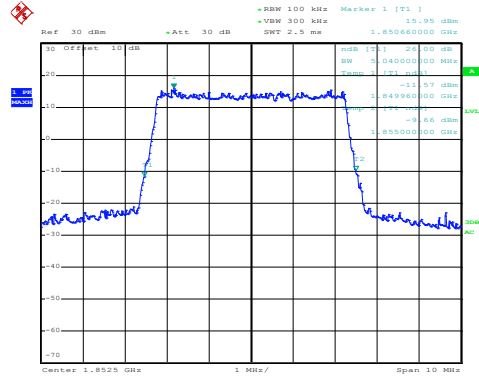

Date: 24.NOV.2016 22:44:52

Lowest channel

Modulation:16QAM

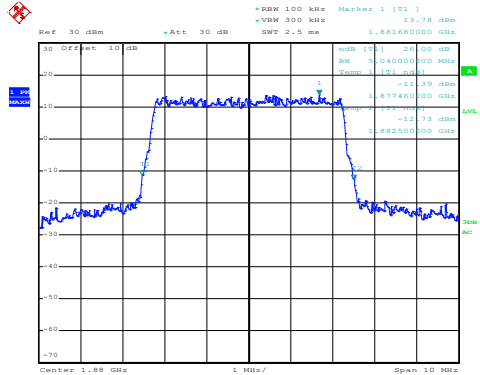

Date: 24.NOV.2016 22:45:27

Modulation: QPSK

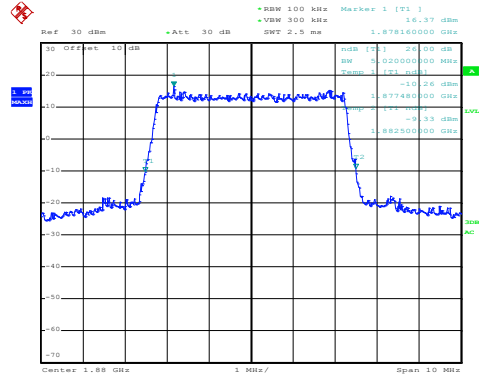

Date: 24.NOV.2016 22:45:20

Middle channel

Modulation:16QAM

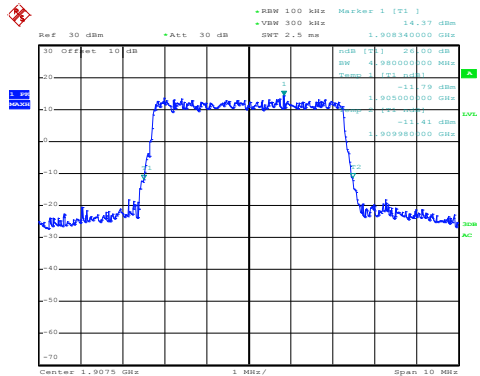

Date: 24.NOV.2016 22:46:39

Modulation: QPSK

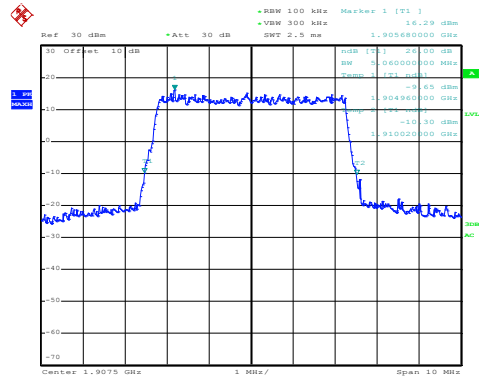

Date: 24.NOV.2016 22:46:32

Highest channel

Test Item:-26dBc bandwidth  
BW: 10MHz

Modulation:16QAM

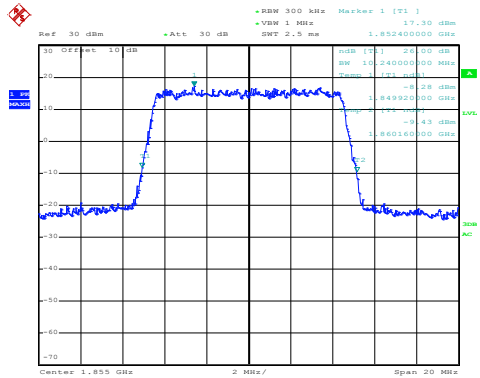

Date: 24.NOV.2016 22:47:49

Modulation: QPSK

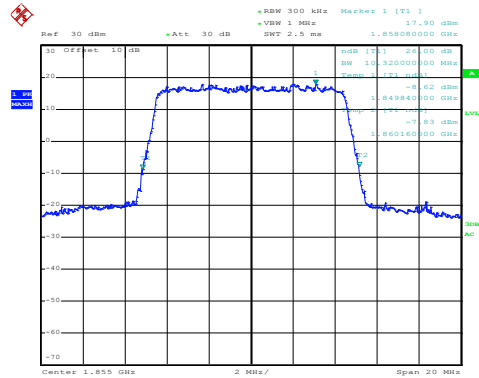

Date: 24.NOV.2016 22:47:40

Lowest channel

Modulation:16QAM

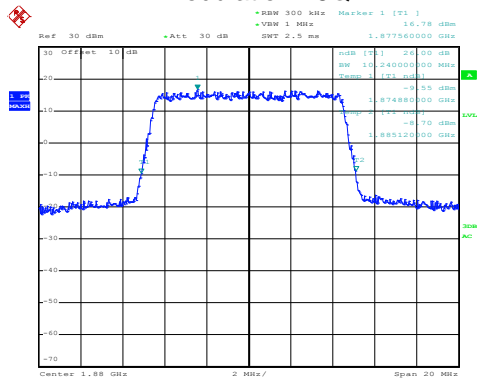

Date: 24.NOV.2016 22:49:04

Modulation: QPSK

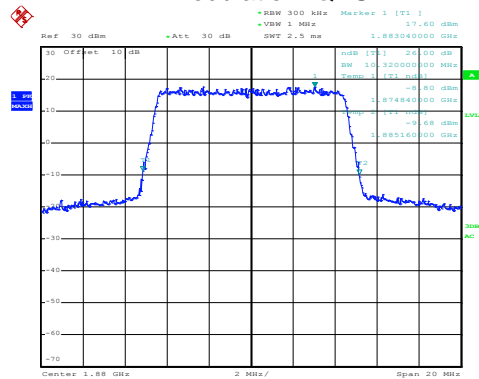

Date: 24.NOV.2016 22:48:56

Middle channel

Modulation:16QAM

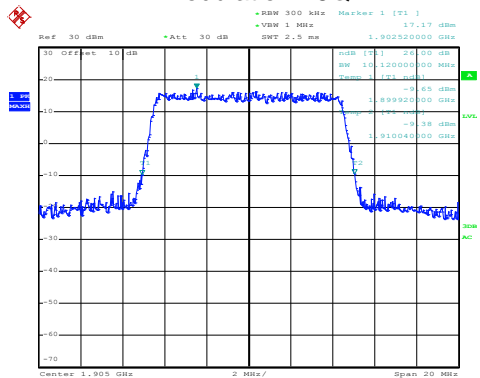

Date: 24.NOV.2016 22:49:34

Modulation: QPSK

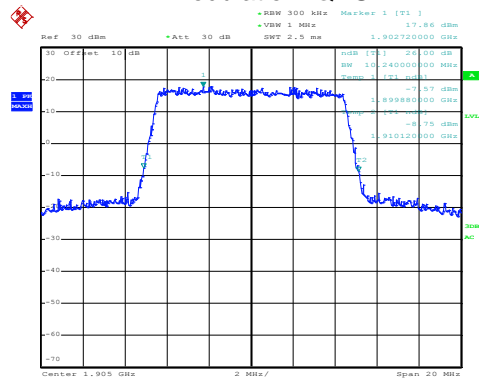

Date: 24.NOV.2016 22:49:28

Highest channel

Test Item:-26dBc bandwidth  
BW: 15MHz

Modulation:16QAM

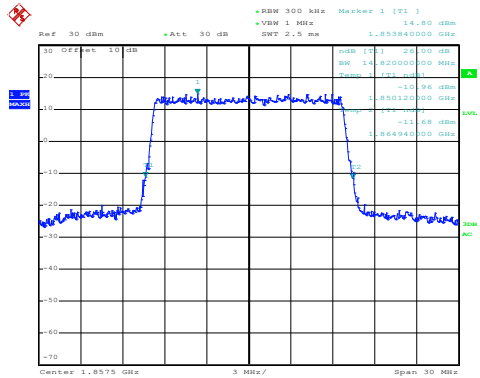

Date: 24.NOV.2016 22:51:18

Modulation: QPSK

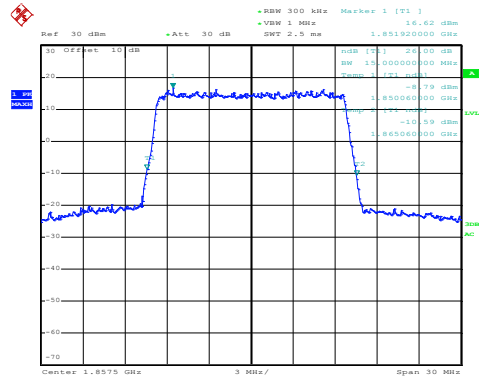

Date: 24.NOV.2016 22:51:11

Lowest channel

Modulation:16QAM

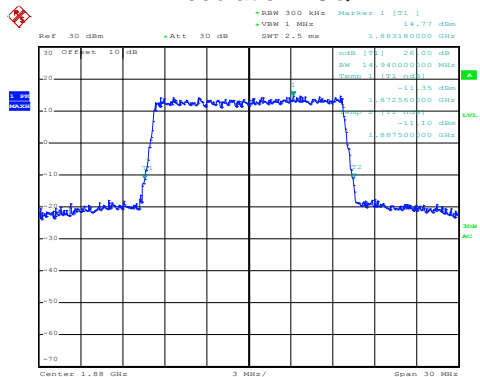

Date: 24.NOV.2016 22:51:51

Modulation: QPSK

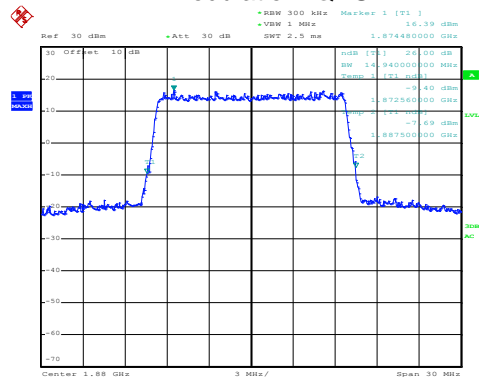

Date: 24.NOV.2016 22:51:43

Middle channel

Modulation:16QAM

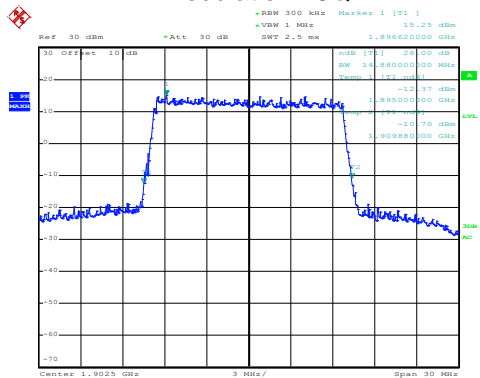

Date: 24.NOV.2016 22:53:05

Modulation: QPSK

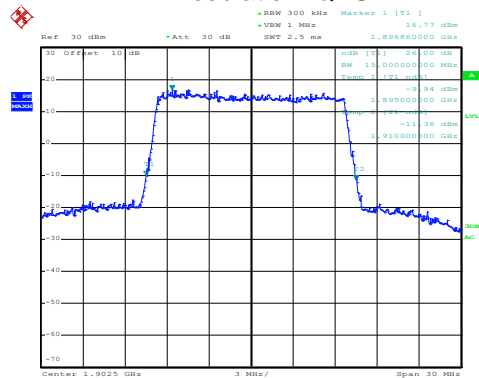

Date: 24.NOV.2016 22:52:57

Highest channel

Test Item:-26dBc bandwidth  
BW: 20MHz

Modulation:16QAM

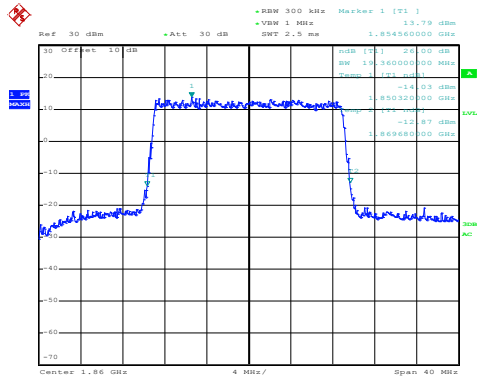

Date: 24.NOV.2016 22:53:56

Modulation: QPSK

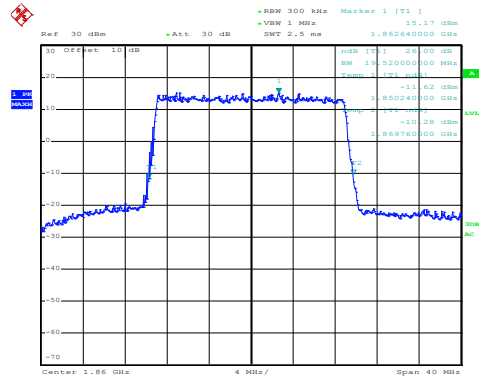

Date: 24.NOV.2016 22:53:50

Lowest channel

Modulation:16QAM

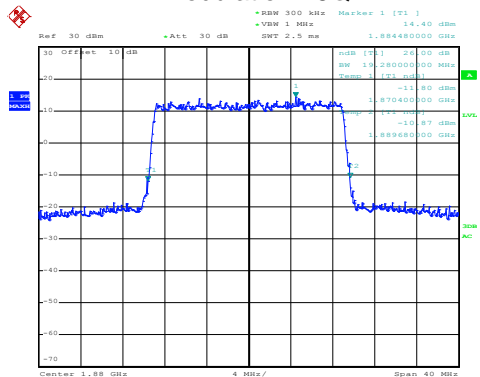

Date: 24.NOV.2016 22:55:01

Modulation: QPSK

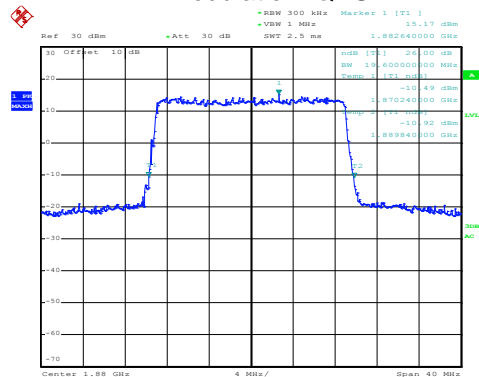

Date: 24.NOV.2016 22:54:55

Middle channel

Modulation:16QAM

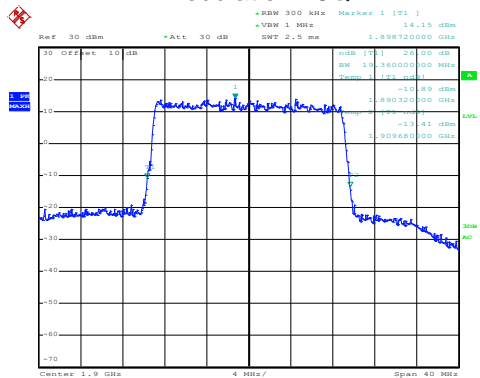

Date: 24.NOV.2016 22:55:31

Modulation: QPSK

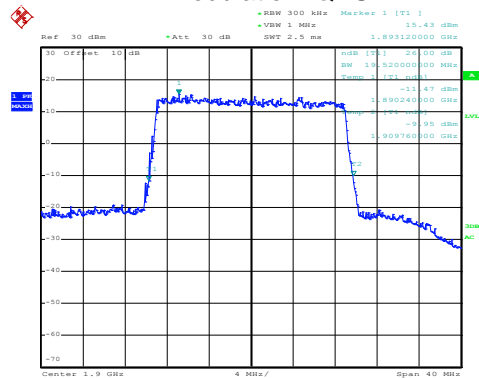

Date: 24.NOV.2016 22:55:24

Highest channel

LTE Band 4 part

Test Item:99% Occupy bandwidth  
 BW: 1.4MHz

Modulation:16QAM

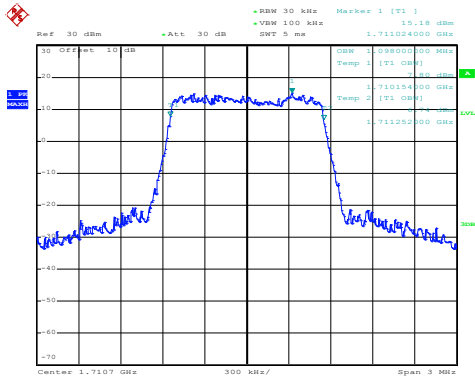

Date: 26.NOV.2016 17:01:47

Modulation: QPSK

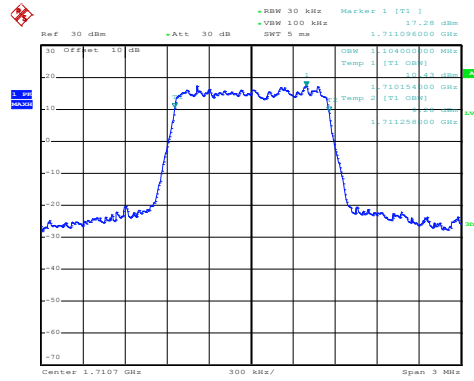

Date: 26.NOV.2016 17:01:38

Lowest channel

Modulation:16QAM

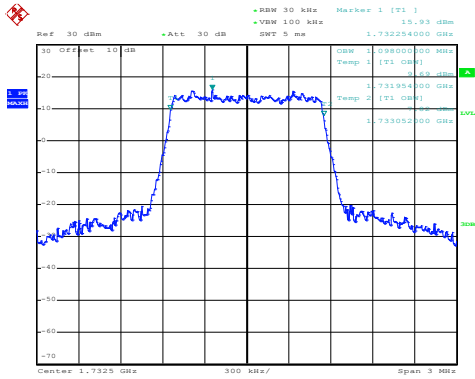

Date: 26.NOV.2016 17:03:12

Modulation: QPSK

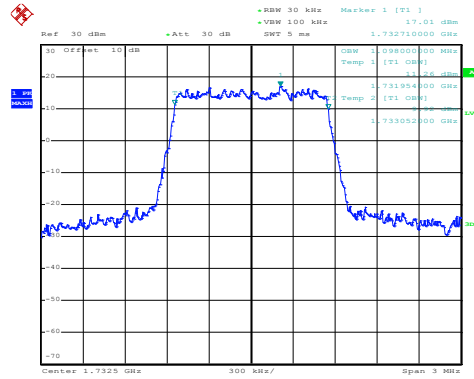

Date: 26.NOV.2016 17:03:02

Middle channel

Modulation:16QAM

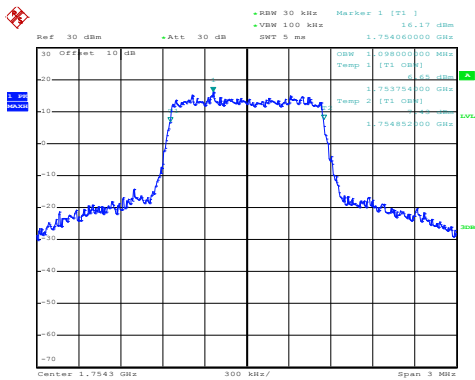

Date: 26.NOV.2016 17:03:47

Modulation: QPSK

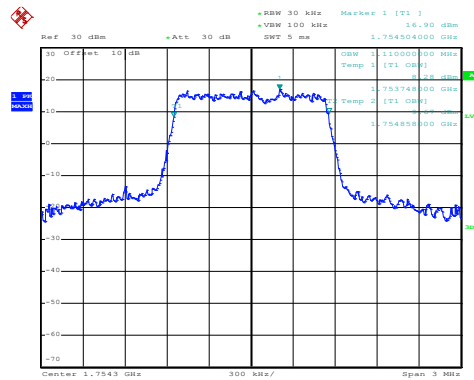

Date: 26.NOV.2016 17:03:40

Highest channel

Test Item:99% Occupy bandwidth  
 BW: 3MHz

Modulation:16QAM

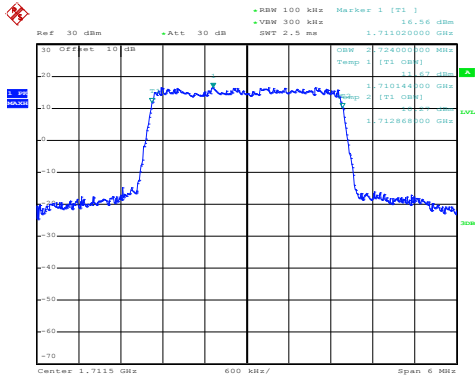

Date: 27.NOV.2016 13:38:29

Modulation: QPSK

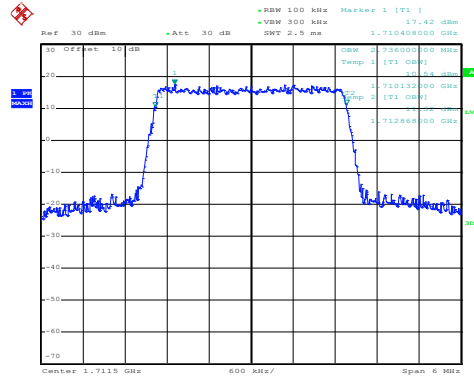

Date: 26.NOV.2016 17:05:38

Lowest channel

Modulation:16QAM

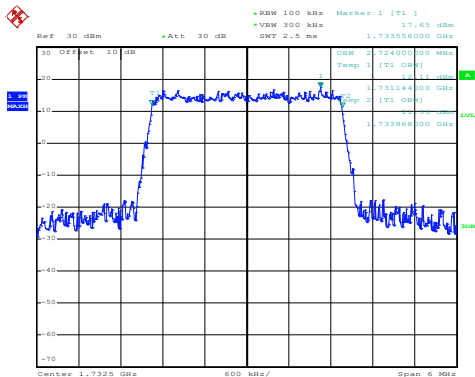

Date: 26.NOV.2016 17:06:25

Modulation: QPSK

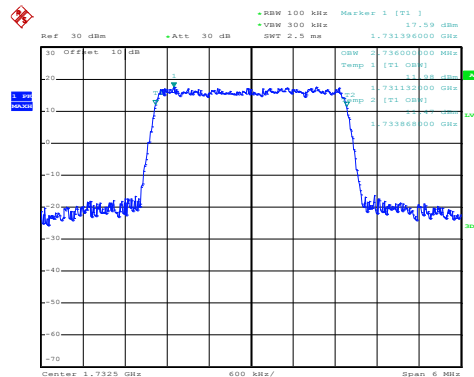

Date: 26.NOV.2016 17:06:19

Middle channel

Modulation:16QAM

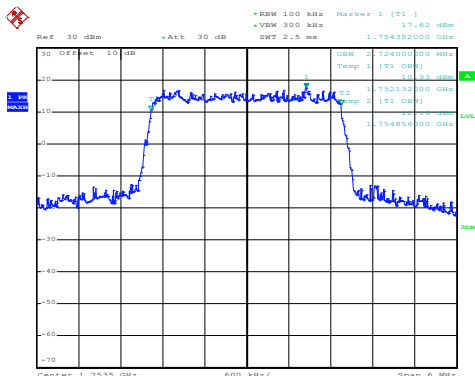

Date: 26.NOV.2016 17:07:31

Modulation: QPSK

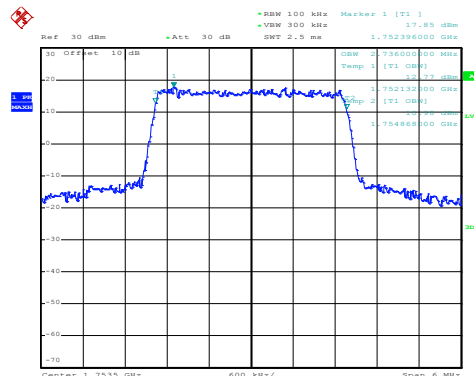

Date: 26.NOV.2016 17:07:25

Highest channel

Test Item:99% Occupy bandwidth  
 BW: 5MHz

Modulation:16QAM

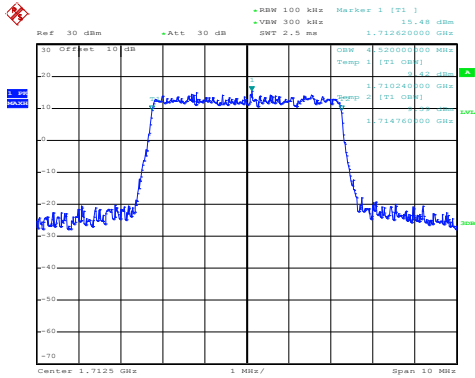

Date: 26.NOV.2016 17:09:27

Modulation: QPSK

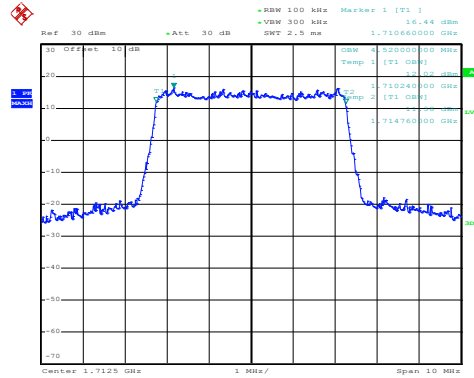

Date: 26.NOV.2016 17:09:17

Lowest channel

Modulation:16QAM

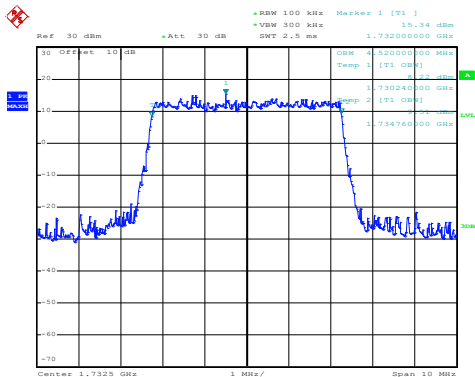

Date: 26.NOV.2016 17:10:29

Modulation: QPSK

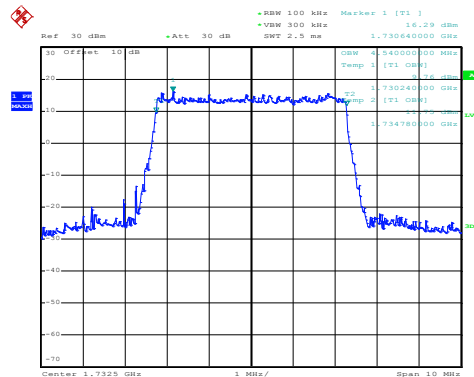

Date: 26.NOV.2016 17:10:23

Middle channel

Modulation:16QAM

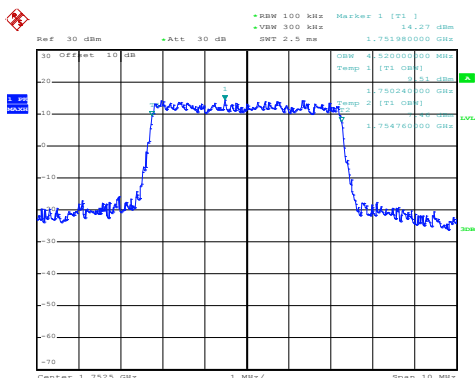

Date: 26.NOV.2016 17:11:22

Modulation: QPSK

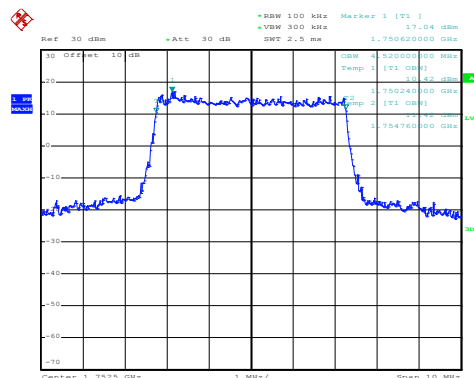

Date: 26.NOV.2016 17:11:16

Highest channel

Test Item: 99% Occupancy bandwidth  
BW: 10MHz

Modulation: 16QAM

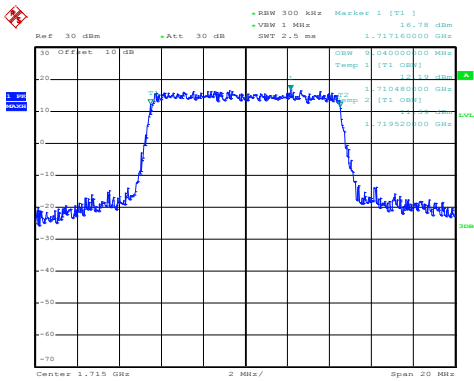

Date: 26.NOV.2016 17:13:09

Modulation: QPSK

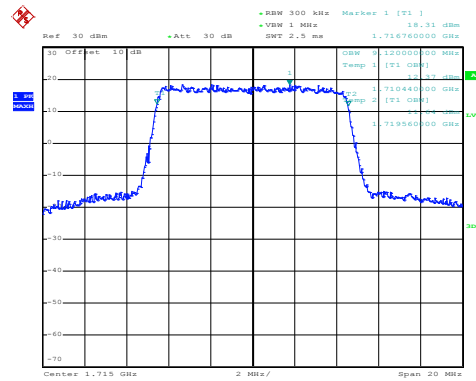

Date: 26.NOV.2016 17:13:04

Lowest channel

Modulation: 16QAM

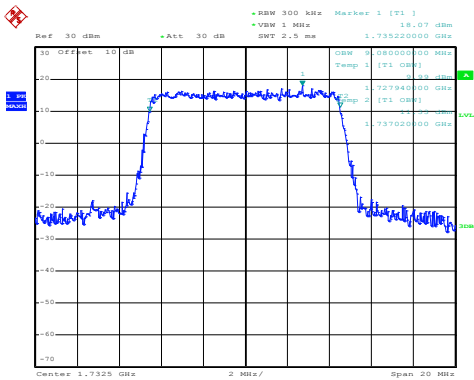

Date: 26.NOV.2016 17:13:38

Modulation: QPSK

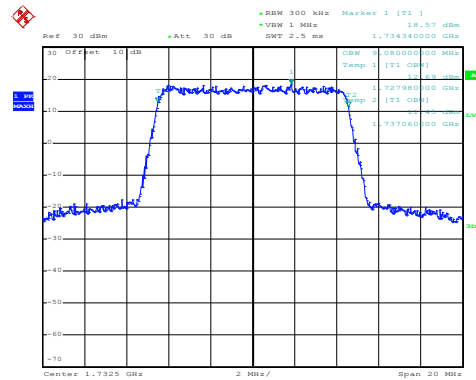

Date: 26.NOV.2016 17:13:32

Middle channel

Modulation: 16QAM

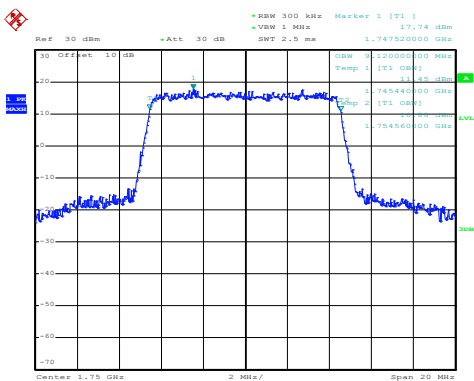

Date: 26.NOV.2016 17:16:02

Modulation: QPSK

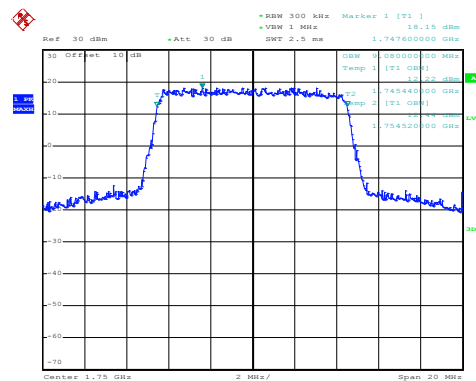

Date: 26.NOV.2016 17:14:37

Highest channel



Test Item:99% Occupy bandwidth  
 BW: 15MHz

Modulation:16QAM

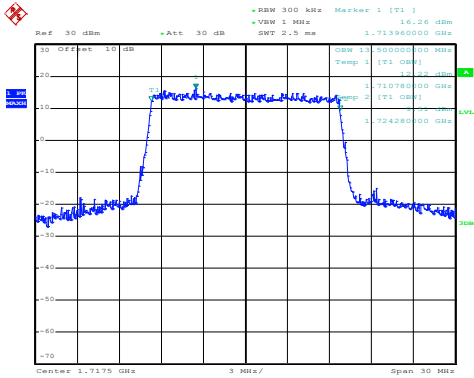

Date: 26.NOV.2016 17:17:32

Modulation: QPSK

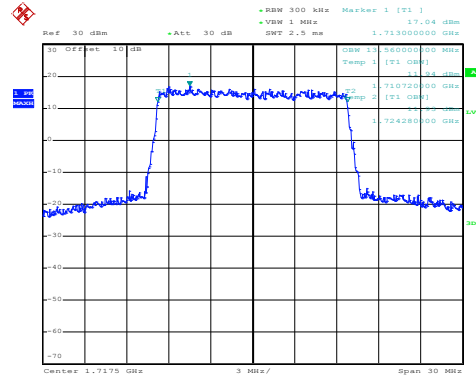

Date: 26.NOV.2016 17:17:25

Lowest channel

Modulation:16QAM

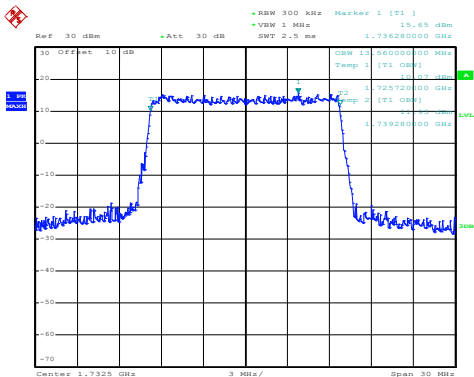

Date: 26.NOV.2016 17:18:08

Modulation: QPSK

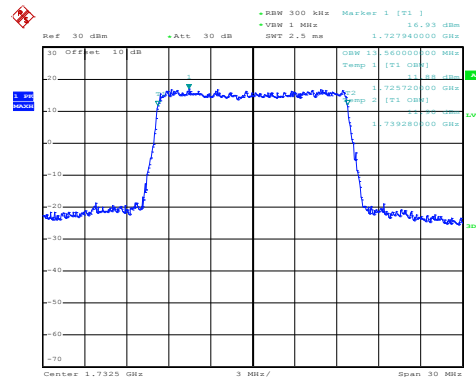

Date: 26.NOV.2016 17:18:00

Middle channel

Modulation:16QAM

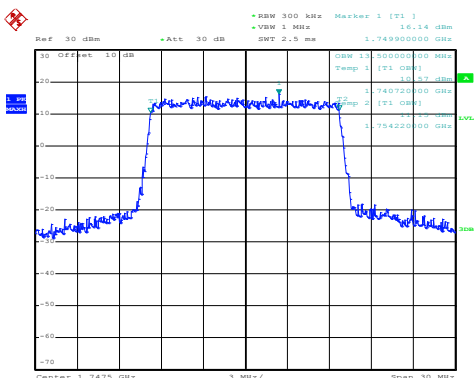

Date: 26.NOV.2016 17:20:50

Modulation: QPSK

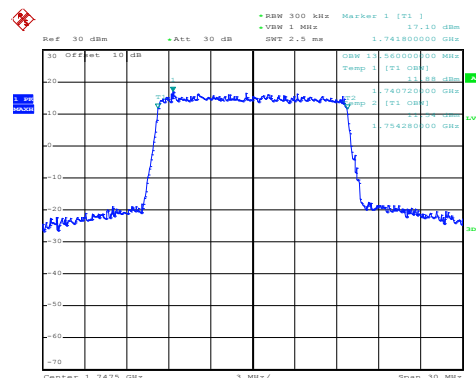

Date: 26.NOV.2016 17:20:44

Highest channel

Test Item:99% Occupy bandwidth  
 BW: 20MHz

Modulation:16QAM

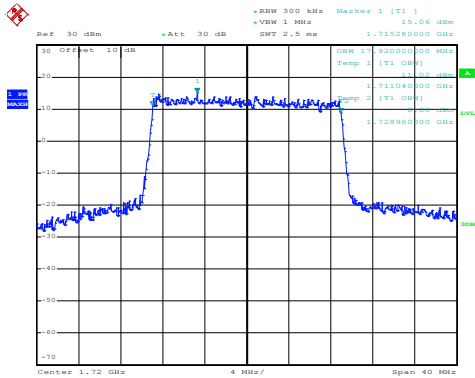

Date: 26.NOV.2016 17:21:50

Modulation: QPSK

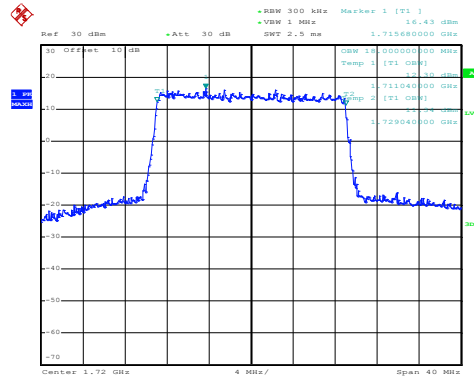

Date: 26.NOV.2016 17:21:44

Lowest channel

Modulation:16QAM

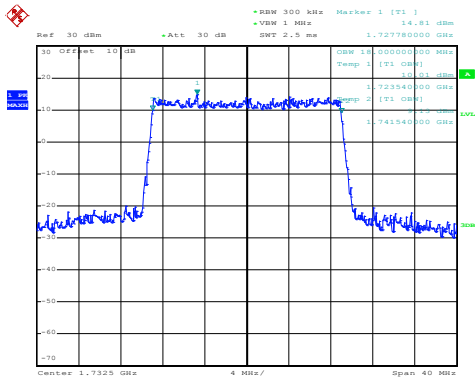

Date: 26.NOV.2016 17:22:51

Modulation: QPSK

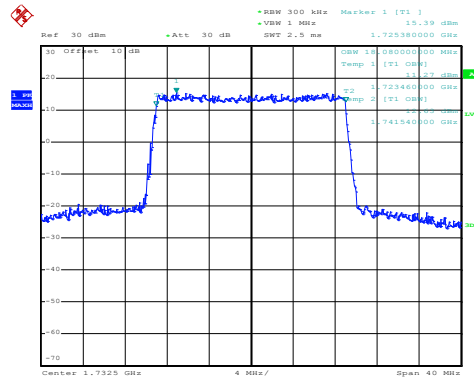

Date: 26.NOV.2016 17:22:46

Middle channel

Modulation:16QAM

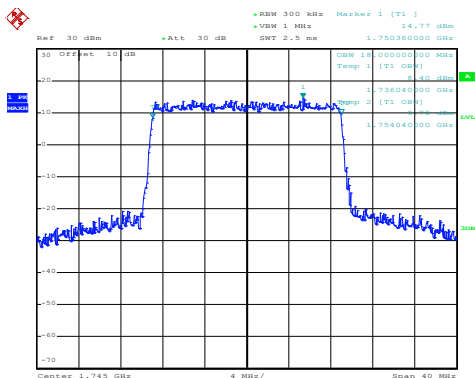

Date: 26.NOV.2016 17:23:21

Modulation: QPSK

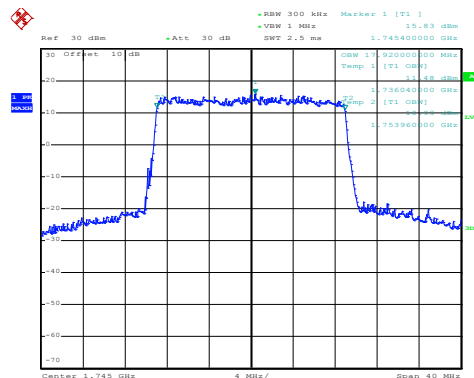

Date: 26.NOV.2016 17:23:15

Highest channel

Test Item:-26dBc bandwidth  
 BW: 1.4MHz

Modulation:16QAM

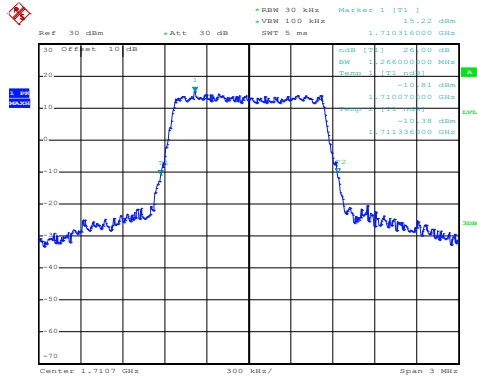

Date: 26.NOV.2016 17:02:13

Modulation: QPSK

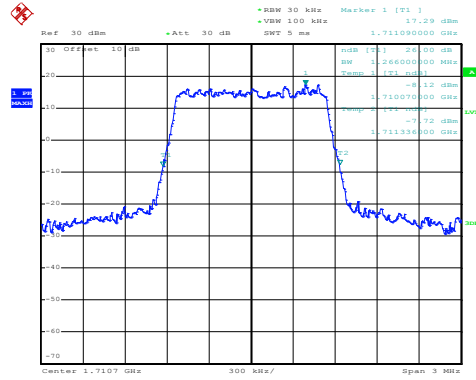

Date: 26.NOV.2016 17:02:04

Lowest channel

Modulation:16QAM

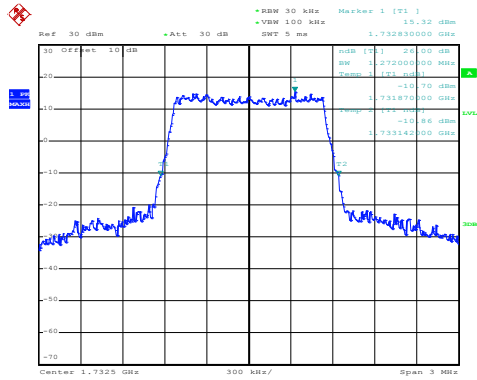

Date: 26.NOV.2016 17:02:49

Modulation: QPSK

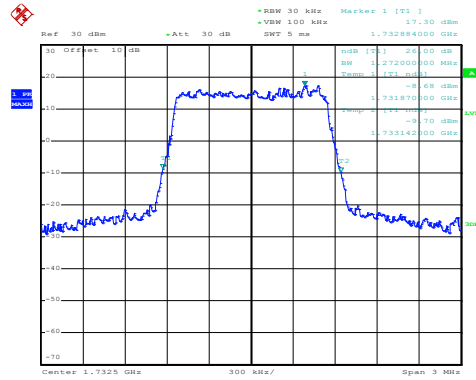

Date: 26.NOV.2016 17:02:43

Middle channel

Modulation:16QAM

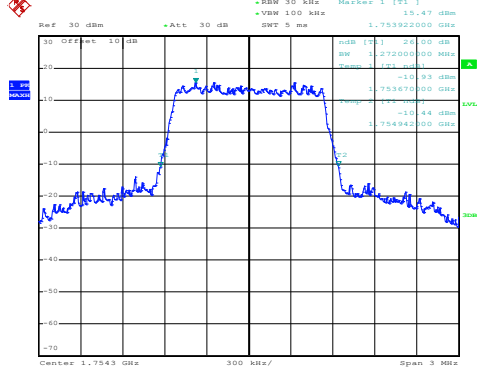

Date: 26.NOV.2016 17:04:07

Modulation: QPSK

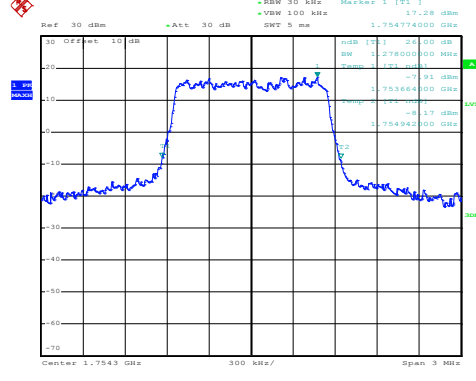

Date: 26.NOV.2016 17:04:01

Highest channel

Test Item:-26dBc bandwidth  
 BW: 3MHz

Modulation:16QAM

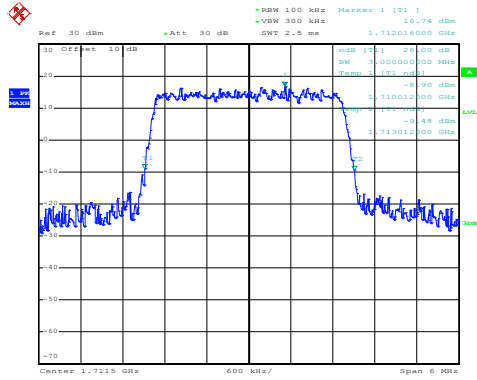

Date: 26.NOV.2016 17:05:26

Modulation: QPSK

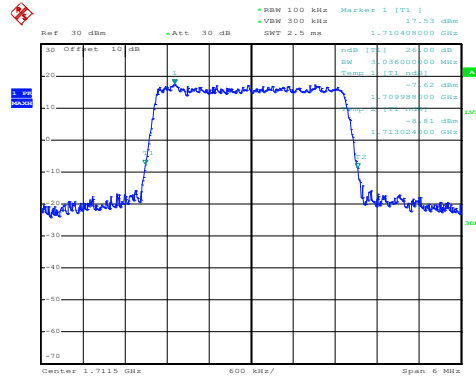

Date: 26.NOV.2016 17:05:20

Lowest channel

Modulation:16QAM

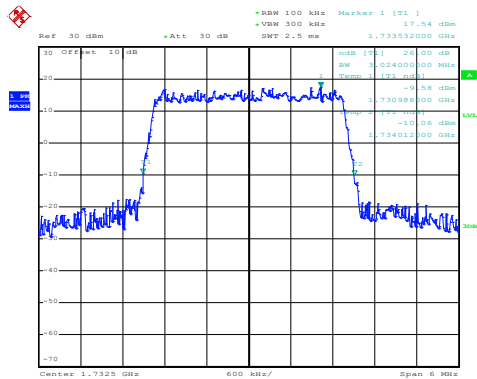

Date: 26.NOV.2016 17:06:43

Modulation: QPSK

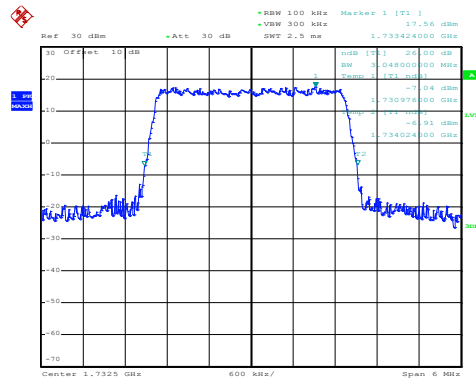

Date: 26.NOV.2016 17:06:38

Middle channel

Modulation:16QAM

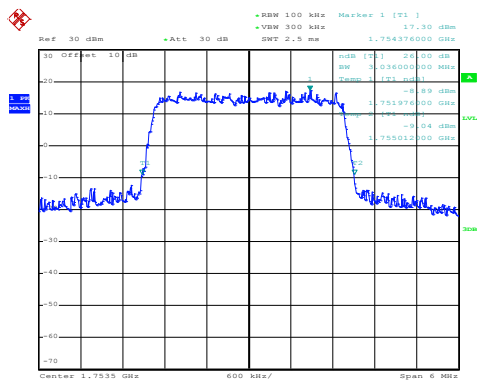

Date: 26.NOV.2016 17:07:14

Modulation: QPSK

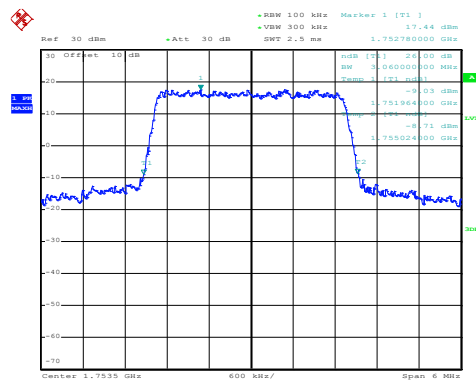

Date: 26.NOV.2016 17:07:08

Highest channel

Test Item:-26dBc bandwidth  
 BW: 5MHz

Modulation:16QAM

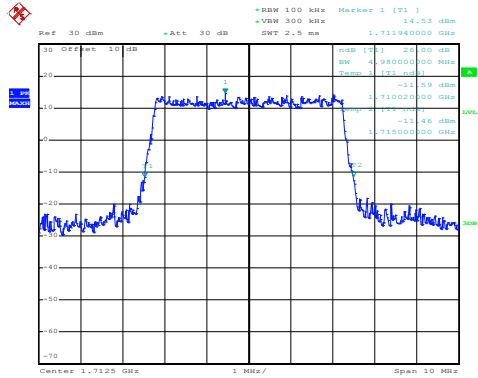

Date: 26.NOV.2016 17:09:44

Modulation: QPSK

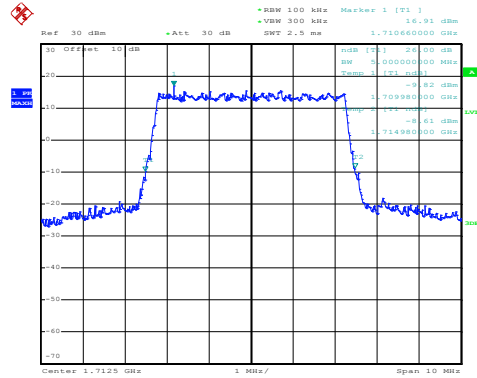

Date: 26.NOV.2016 17:09:38

Lowest channel

Modulation:16QAM

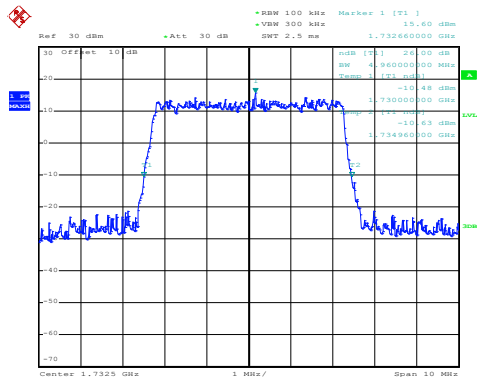

Date: 26.NOV.2016 17:10:13

Modulation: QPSK

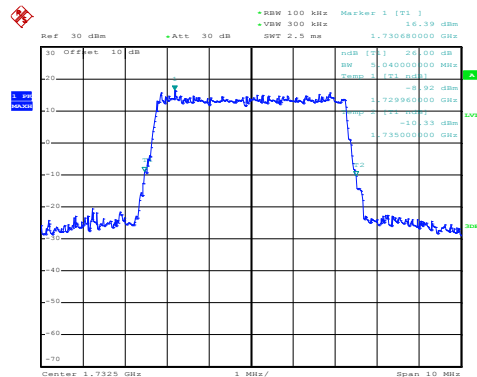

Date: 26.NOV.2016 17:10:07

Middle channel

Modulation:16QAM

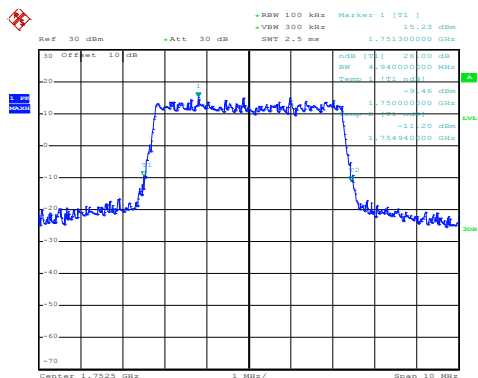

Date: 26.NOV.2016 17:11:44

Modulation: QPSK

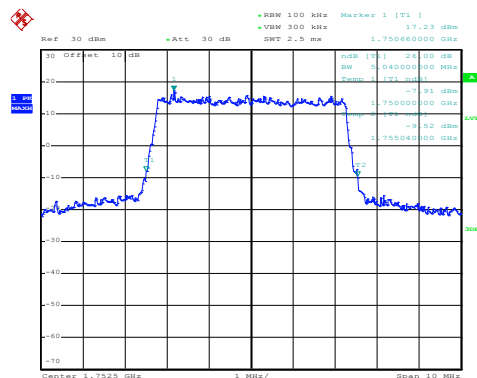

Date: 26.NOV.2016 17:11:37

Highest channel

Test Item:-26dBc bandwidth  
 BW: 10MHz

Modulation:16QAM

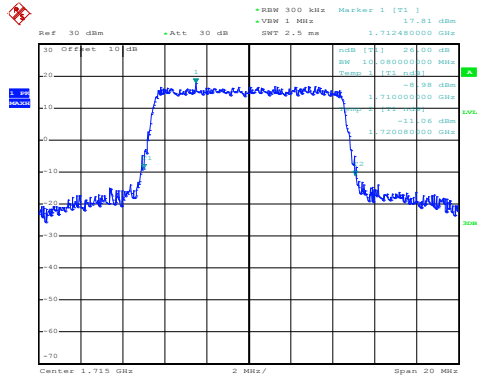

Date: 26.NOV.2016 17:12:48

Modulation: QPSK

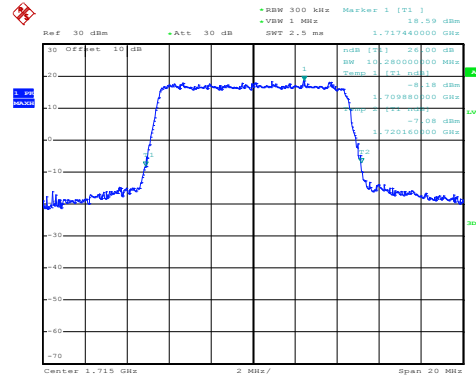

Date: 26.NOV.2016 17:12:40

Lowest channel

Modulation:16QAM

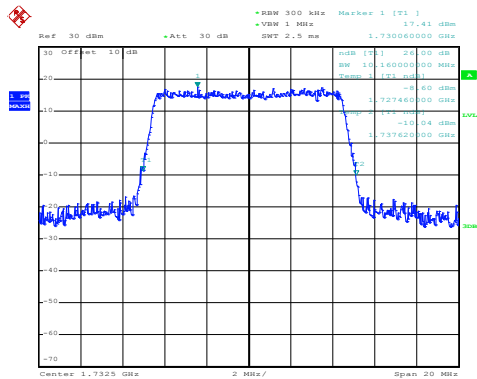

Date: 26.NOV.2016 17:13:57

Modulation: QPSK

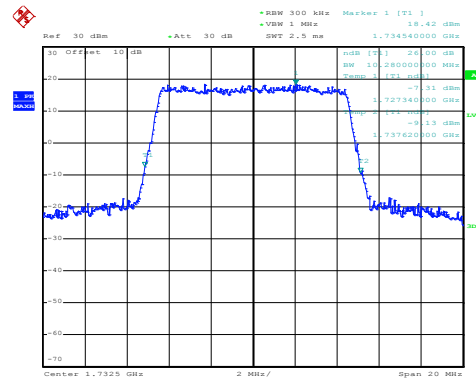

Date: 26.NOV.2016 17:13:51

Middle channel

Modulation:16QAM

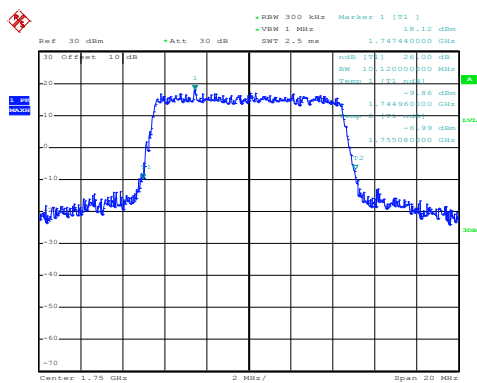

Date: 26.NOV.2016 17:14:27

Modulation: QPSK

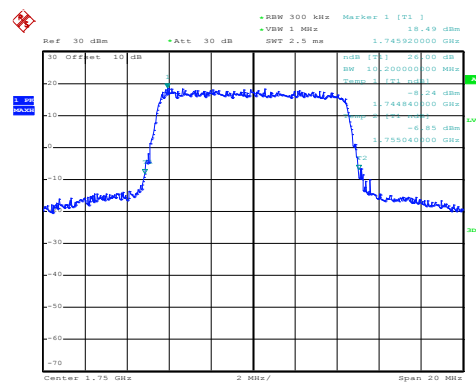

Date: 26.NOV.2016 17:14:22

Highest channel

Test Item:-26dBc bandwidth  
 BW: 15MHz

Modulation:16QAM

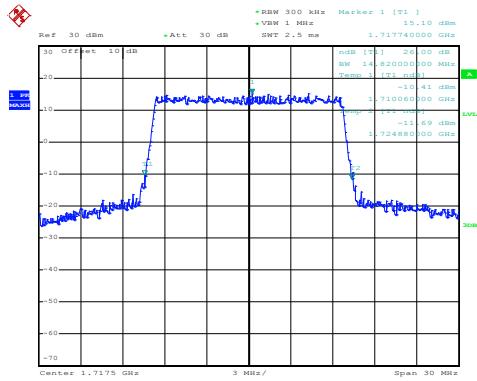

Date: 26.NOV.2016 17:18:55

Modulation: QPSK

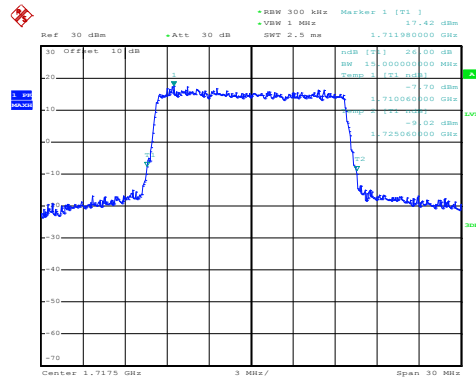

Date: 26.NOV.2016 17:18:50

Lowest channel

Modulation:16QAM

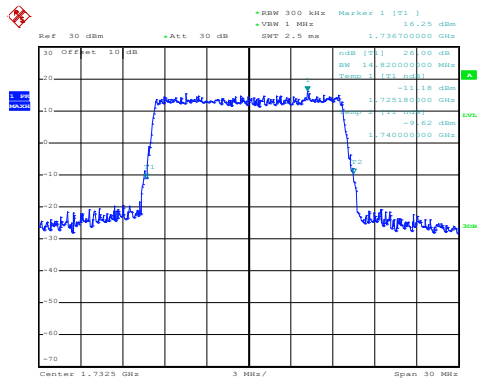

Date: 26.NOV.2016 17:18:30

Modulation: QPSK

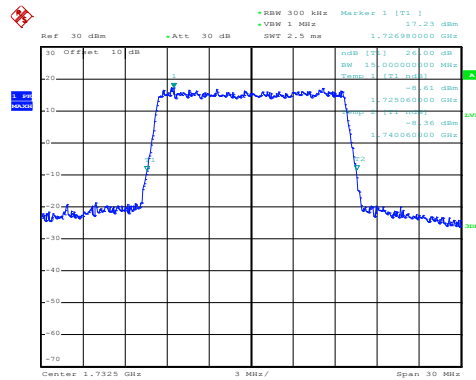

Date: 26.NOV.2016 17:18:24

Middle channel

Modulation:16QAM

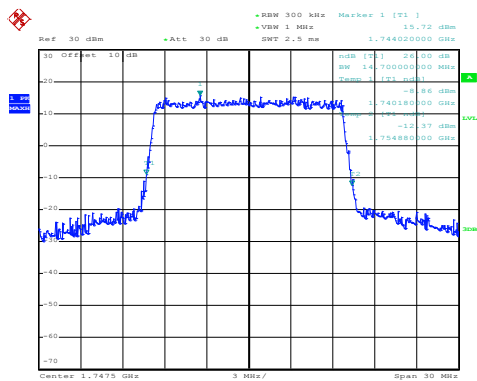

Date: 26.NOV.2016 17:20:32

Modulation: QPSK

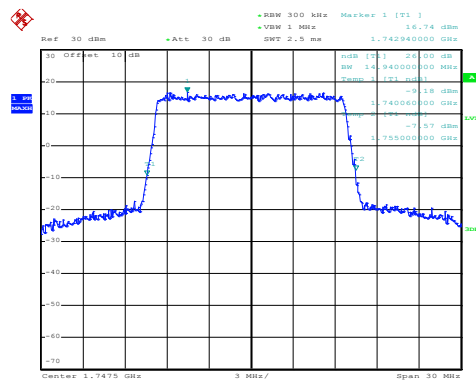

Date: 26.NOV.2016 17:20:26

Highest channel

Test Item:-26dBc bandwidth  
 BW: 20MHz

Modulation:16QAM

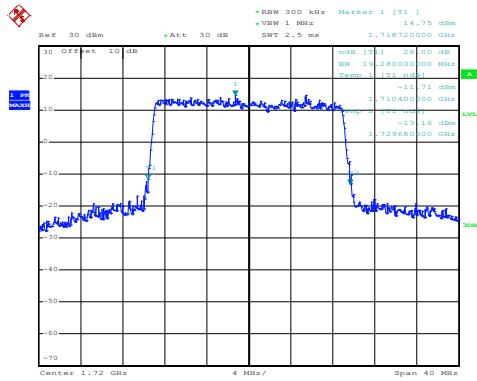

Date: 26.NOV.2016 17:22:08

Modulation: QPSK

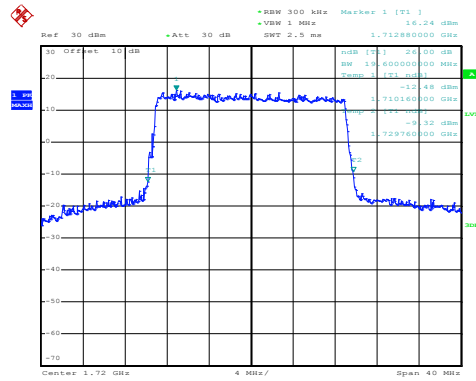

Date: 26.NOV.2016 17:22:03

Lowest channel

Modulation:16QAM

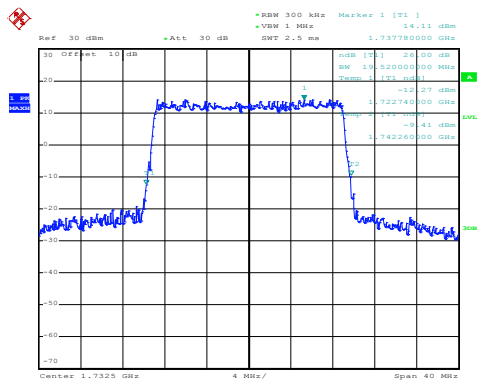

Date: 26.NOV.2016 17:22:34

Modulation: QPSK

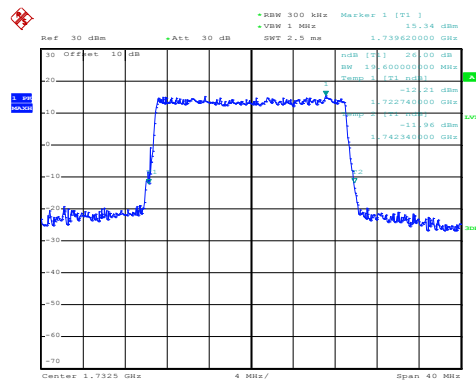

Date: 26.NOV.2016 17:22:28

Middle channel

Modulation:16QAM

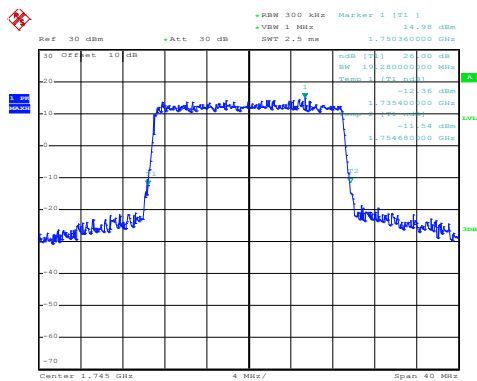

Date: 26.NOV.2016 17:23:39

Modulation: QPSK

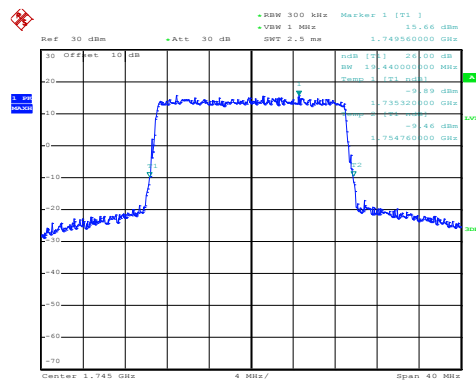

Date: 26.NOV.2016 17:23:33

Highest channel



LTE-Band 7 part

Test Item:99% Occupy bandwidth  
 BW: 5MHz

Modulation:16QAM

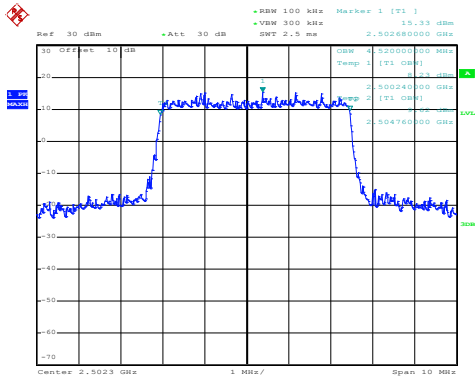

Date: 26.NOV.2016 17:27:57

Modulation:QPSK

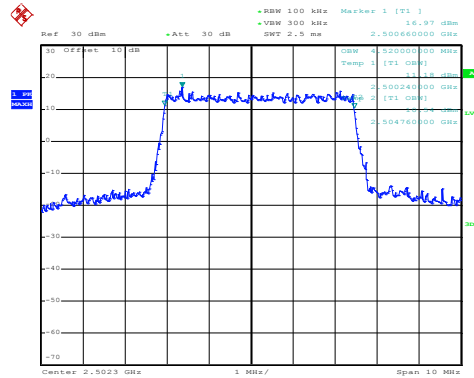

Date: 26.NOV.2016 17:27:52

Lowest channel

Modulation:16QAM

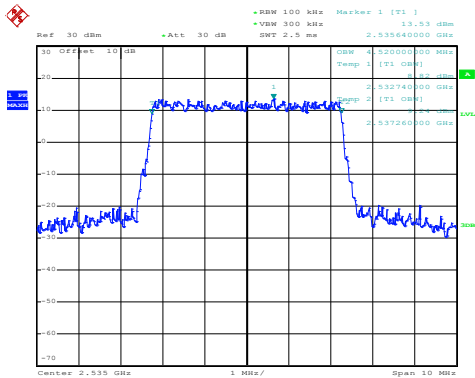

Date: 26.NOV.2016 17:28:31

Modulation:QPSK

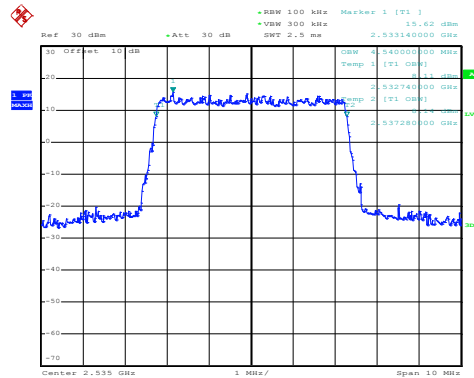

Date: 26.NOV.2016 17:28:25

Middle channel

Modulation:16QAM

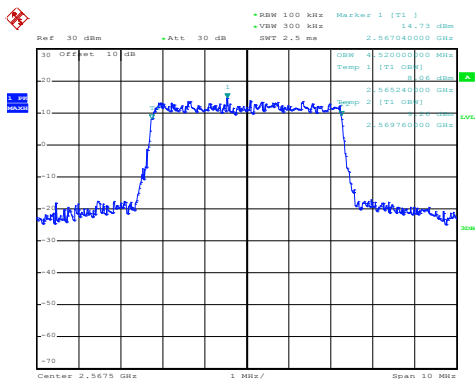

Date: 26.NOV.2016 17:29:28

Modulation: QPSK

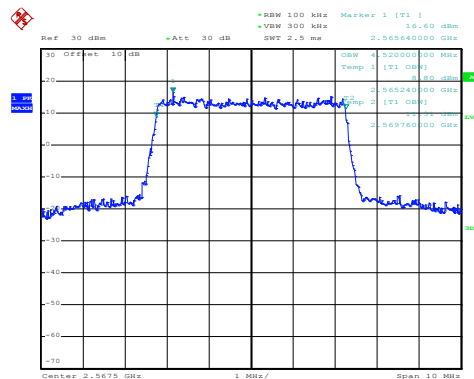

Date: 26.NOV.2016 17:29:23

Highest channel

Test Item:99% Occupy bandwidth  
 BW: 10MHz

Modulation:16QAM

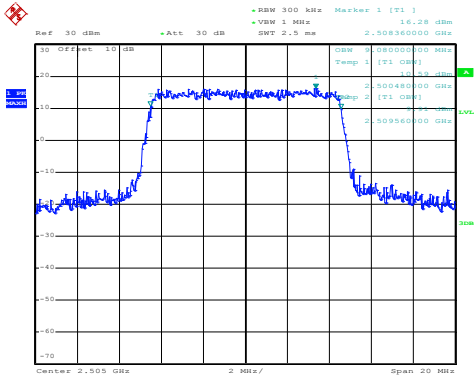

Date: 26.NOV.2016 17:30:21

Modulation:QPSK

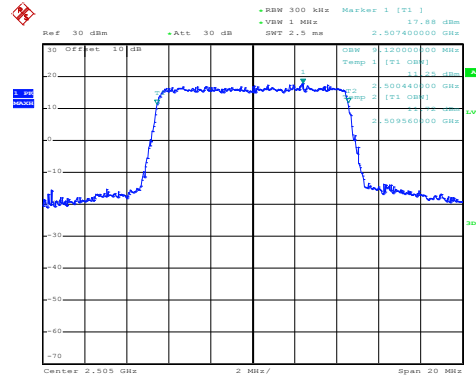

Date: 26.NOV.2016 17:30:16

Lowest channel

Modulation:16QAM

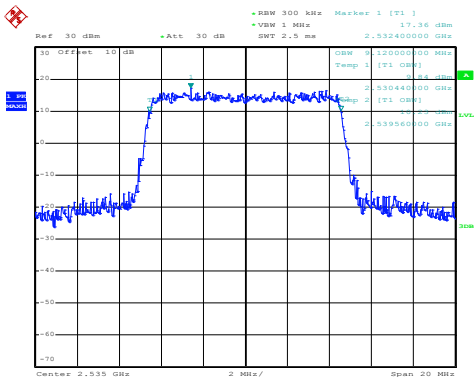

Date: 26.NOV.2016 17:31:26

Modulation:QPSK

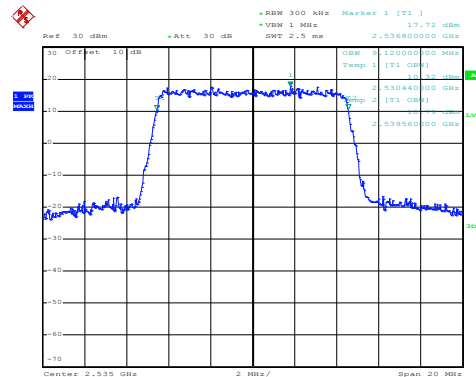

Date: 26.NOV.2016 17:31:20

Middle channel

Modulation:16QAM

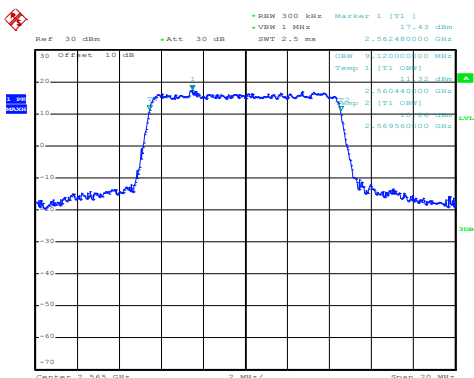

Date: 26.NOV.2016 17:32:38

Modulation:QPSK

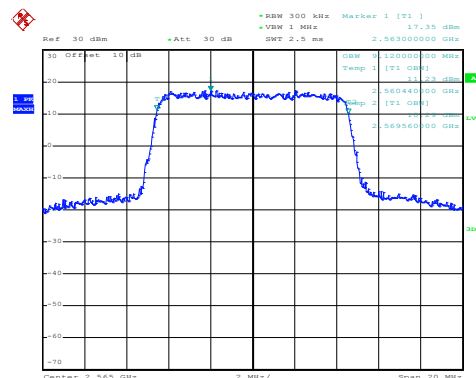

Date: 26.NOV.2016 17:31:54

Highest channel

Test Item:99% Occupy bandwidth  
 BW: 15MHz

Modulation:16QAM

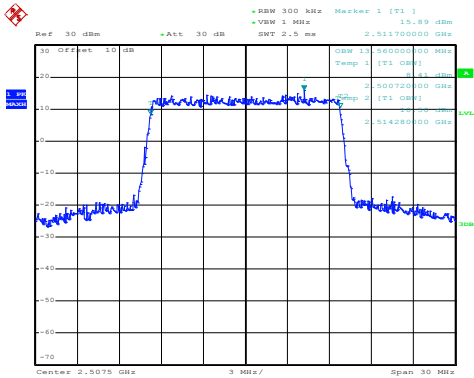

Date: 26.NOV.2016 17:34:09

Modulation:QPSK

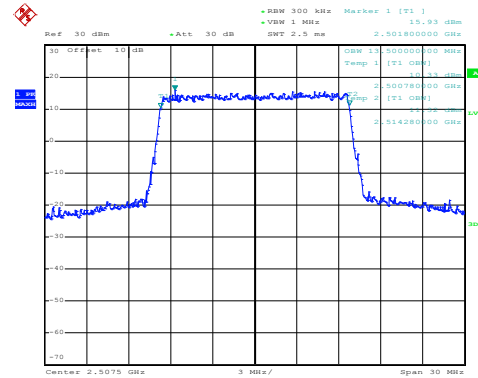

Date: 26.NOV.2016 17:34:03

Lowest channel

Modulation:16QAM

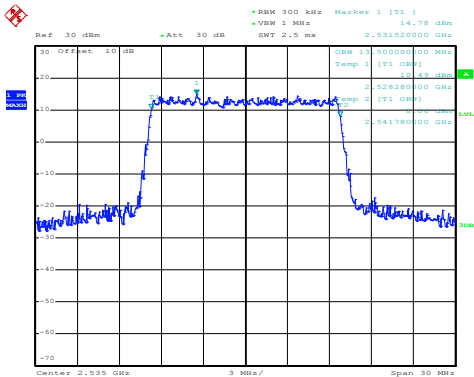

Date: 26.NOV.2016 17:34:46

Modulation:QPSK

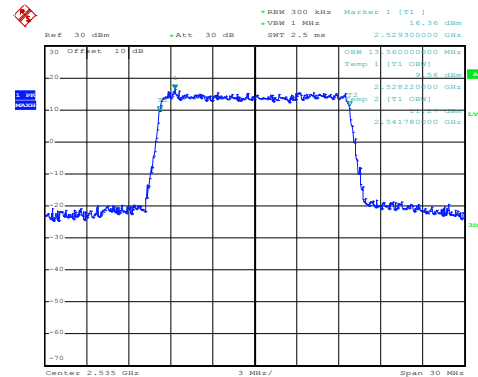

Date: 26.NOV.2016 17:34:40

Middle channel

Modulation:16QAM

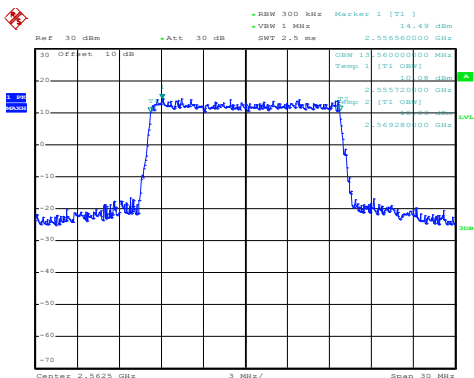

Date: 26.NOV.2016 17:35:56

Modulation: QPSK

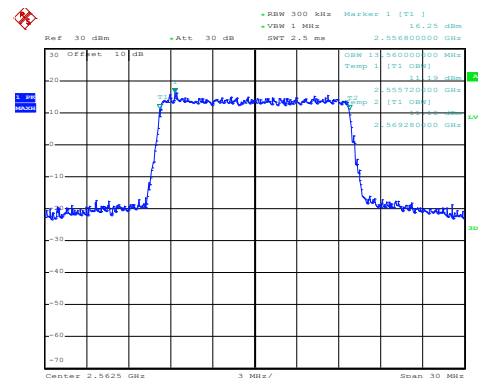

Date: 26.NOV.2016 17:35:51

Highest channel

Test Item:99% Occupy bandwidth  
 BW: 20MHz

Modulation:16QAM

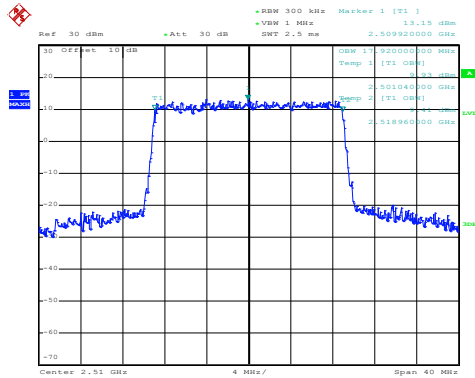

Date: 26.NOV.2016 17:36:48

Modulation:QPSK

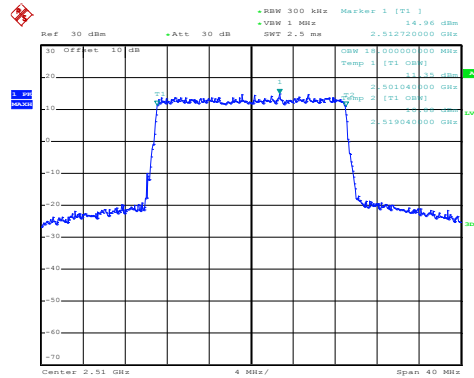

Date: 26.NOV.2016 17:36:42

Lowest channel

Modulation:16QAM

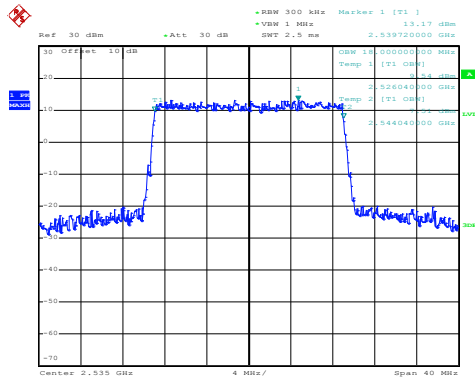

Date: 26.NOV.2016 17:37:53

Modulation:QPSK

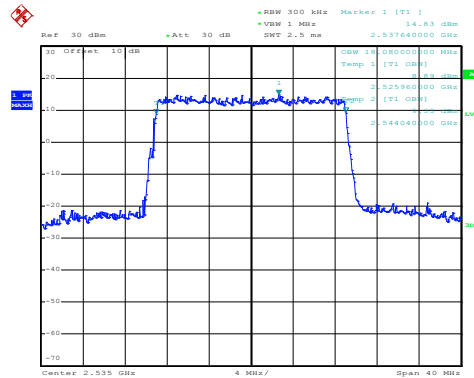

Date: 26.NOV.2016 17:37:48

Middle channel

Modulation:16QAM

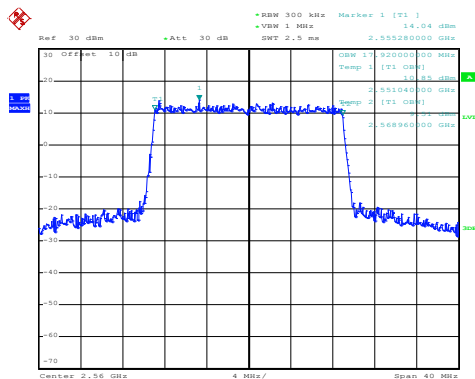

Date: 26.NOV.2016 17:38:25

Modulation:QPSK

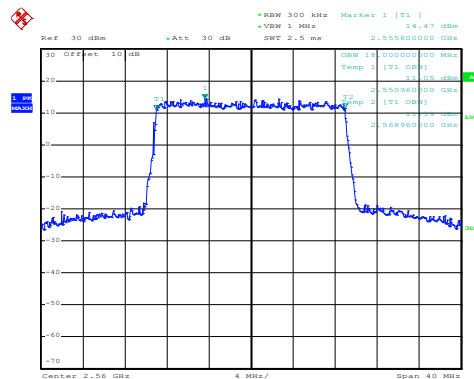

Date: 26.NOV.2016 17:38:19

Highest channel

Test Item:-26dBc bandwidth  
 BW: 5MHz

Modulation:16QAM

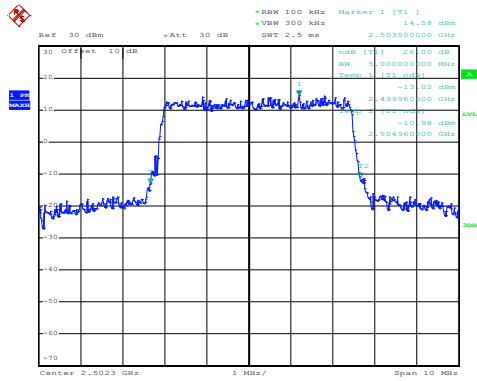

Date: 26.NOV.2016 17:27:39

Modulation:QPSK

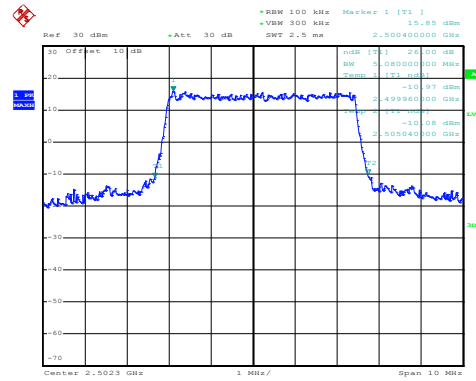

Date: 26.NOV.2016 17:27:34

Lowest channel

Modulation:16QAM

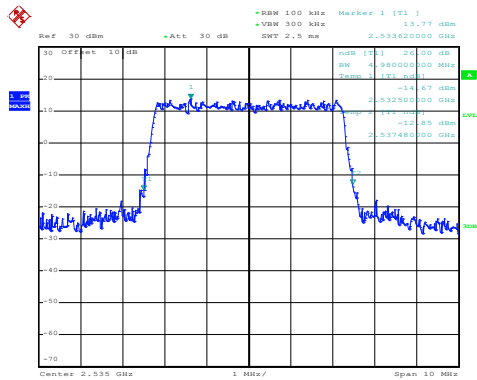

Date: 26.NOV.2016 17:28:47

Modulation:QPSK

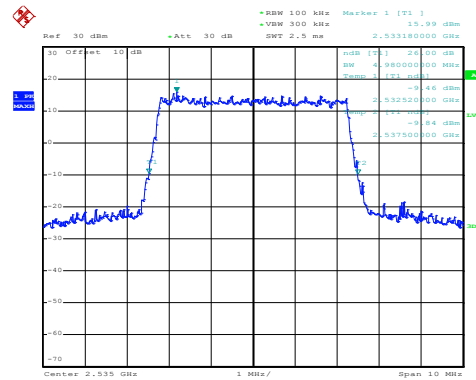

Date: 26.NOV.2016 17:28:42

Middle channel

Modulation:16QAM

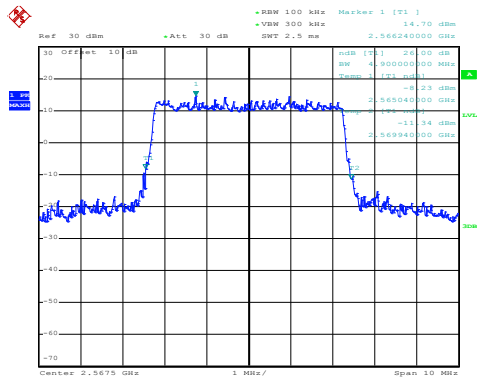

Date: 26.NOV.2016 17:29:13

Modulation:QPSK

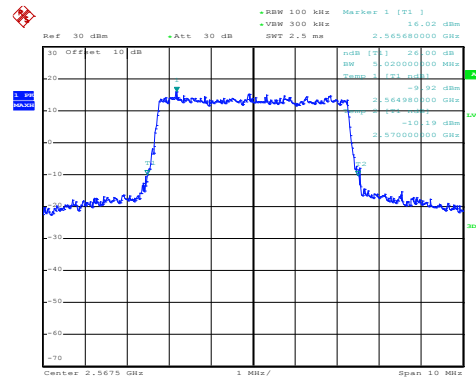

Date: 26.NOV.2016 17:29:08

Highest channel



Test Item:-26dBc bandwidth  
 BW: 15MHz

Modulation:16QAM

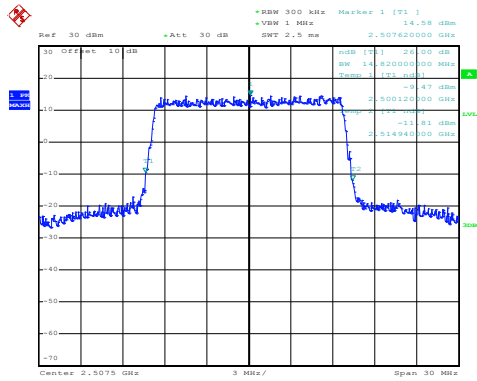

Date: 26.NOV.2016 17:33:53

Modulation:QPSK

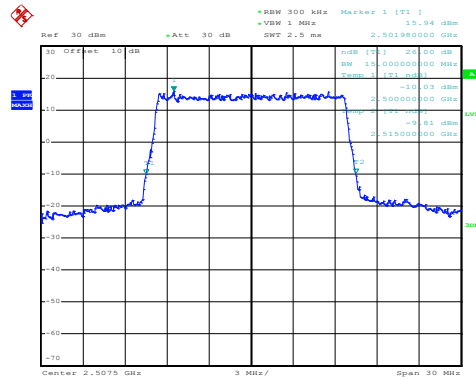

Date: 26.NOV.2016 17:33:47

Lowest channel

Modulation:16QAM

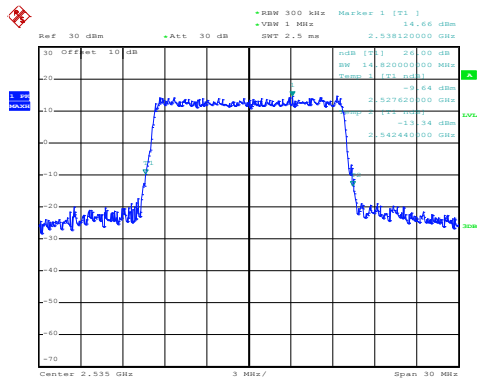

Date: 26.NOV.2016 17:35:05

Modulation:QPSK

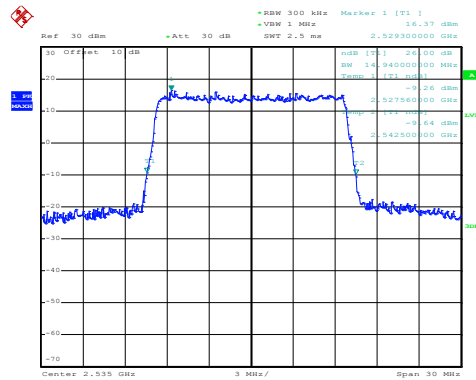

Date: 26.NOV.2016 17:35:00

Middle channel

Modulation:16QAM

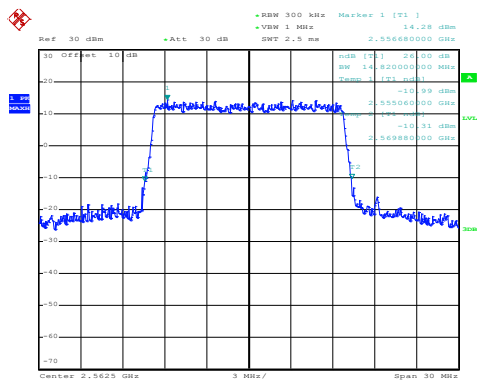

Date: 26.NOV.2016 17:35:39

Modulation:QPSK

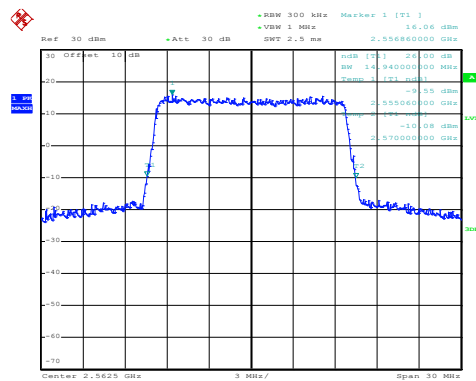

Date: 26.NOV.2016 17:35:33

Highest channel

Test Item:-26dBc bandwidth  
 BW: 20MHz

Modulation:16QAM

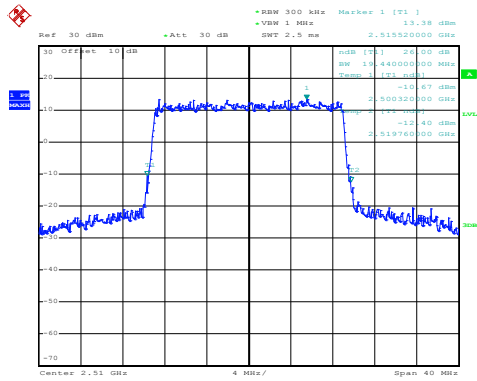

Date: 26.NOV.2016 17:37:03

Modulation:QPSK

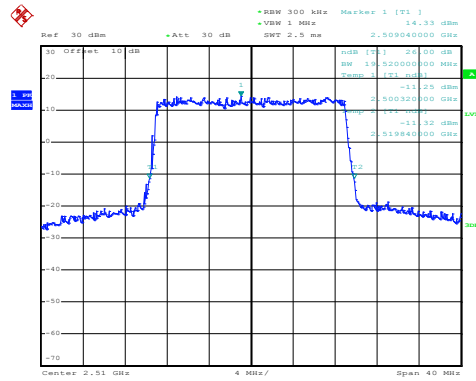

Date: 26.NOV.2016 17:36:58

Lowest channel

Modulation:16QAM

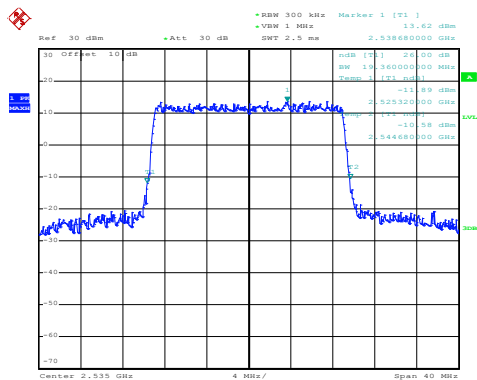

Date: 26.NOV.2016 17:37:33

Modulation:QPSK

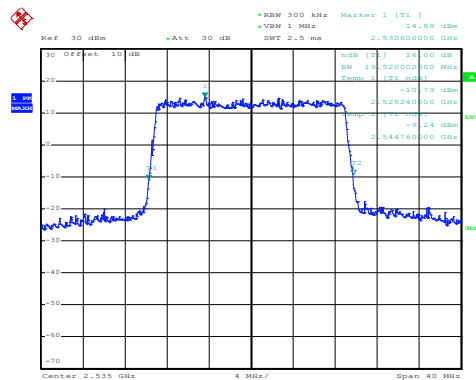

Date: 26.NOV.2016 17:37:25

Middle channel

Modulation:16QAM

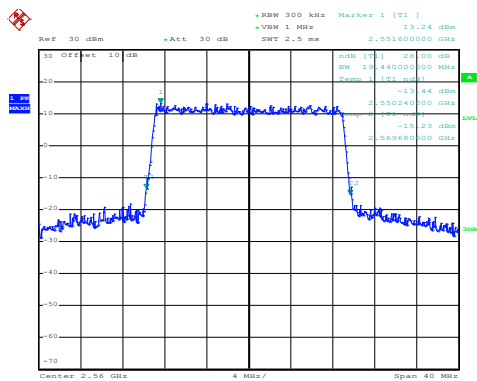

Date: 26.NOV.2016 17:38:42

Modulation:QPSK

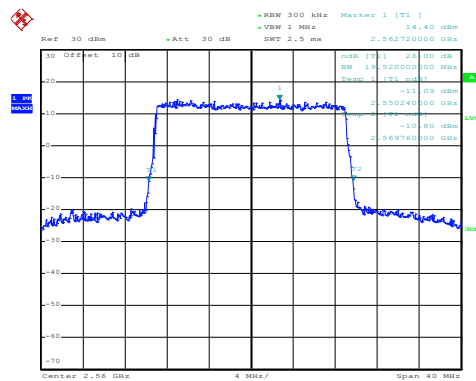

Date: 26.NOV.2016 17:38:36

Highest channel



LTE-Band 12 part

Test Item:99% Occupy bandwidth  
 BW: 1.4MHz

Modulation:16QAM

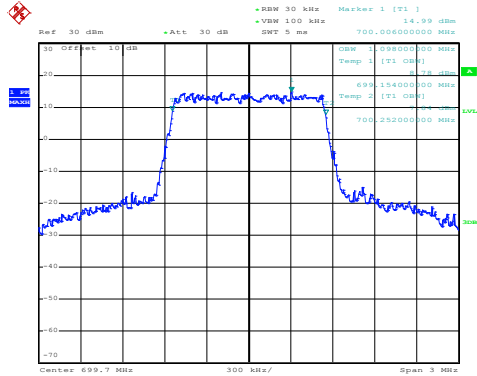

Date: 4.DEC.2016 19:58:21

Modulation: QPSK

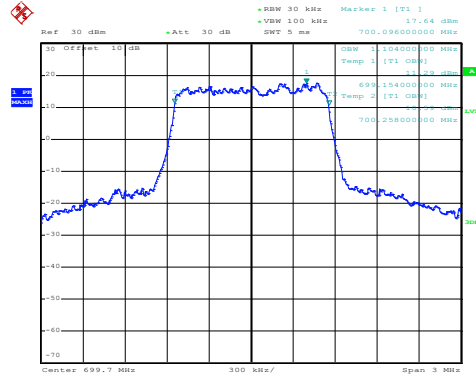

Date: 4.DEC.2016 19:58:11

Lowest channel

Modulation:16QAM

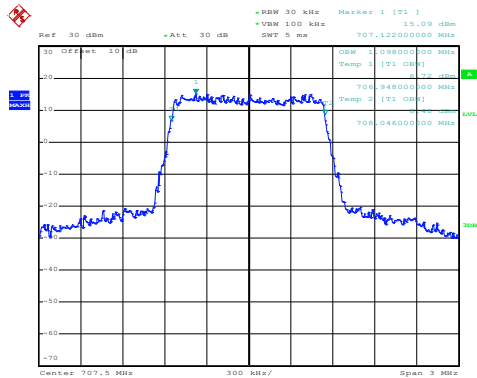

Date: 4.DEC.2016 19:59:21

Modulation: QPSK

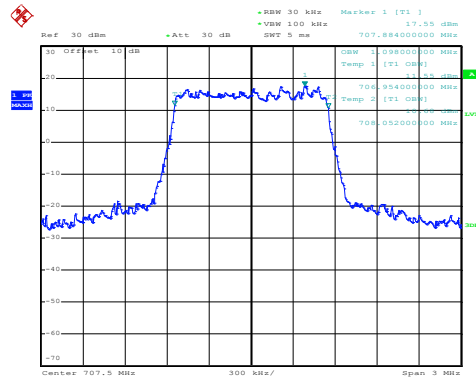

Date: 4.DEC.2016 19:59:13

Middle channel

Modulation:16QAM

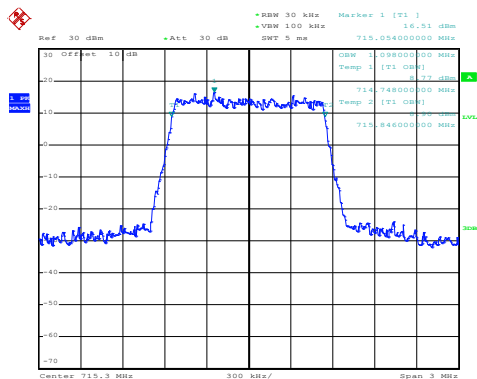

Date: 4.DEC.2016 19:59:58

Modulation: QPSK

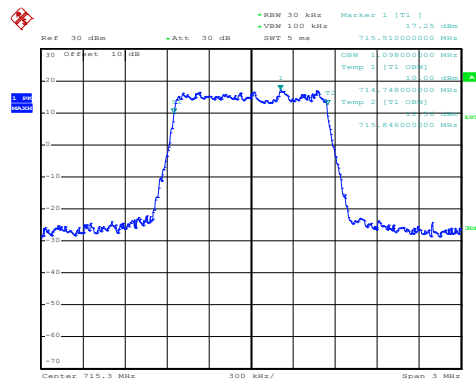

Date: 4.DEC.2016 19:59:49

Highest channel

Test Item: 99% Occupancy bandwidth  
 BW: 3MHz

Modulation: 16QAM

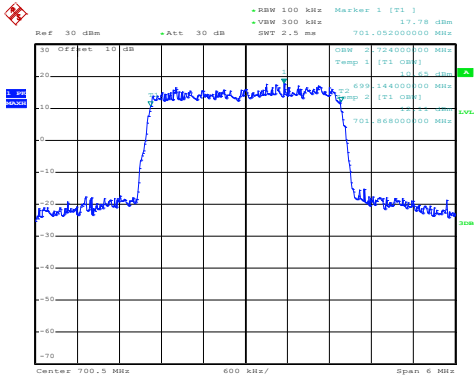

Date: 26.NOV.2016 17:43:17

Modulation: QPSK

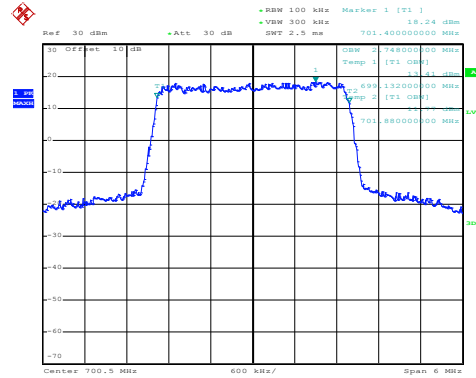

Date: 26.NOV.2016 17:43:09

Lowest channel

Modulation: 16QAM

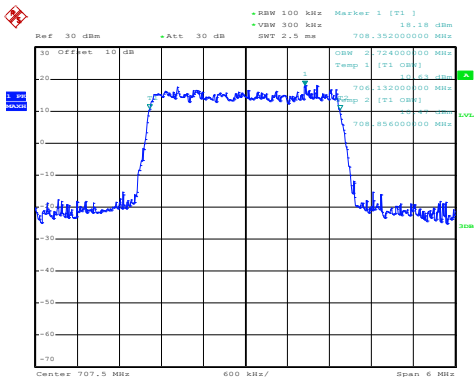

Date: 26.NOV.2016 17:44:27

Modulation: QPSK

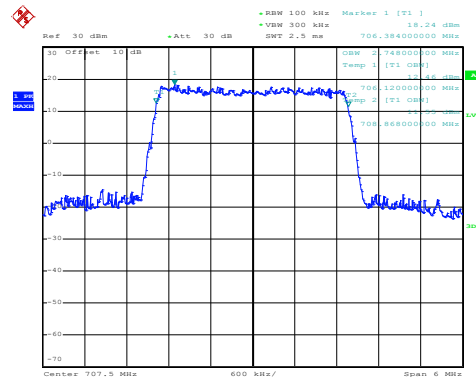

Date: 26.NOV.2016 17:44:22

Middle channel

Modulation: 16QAM

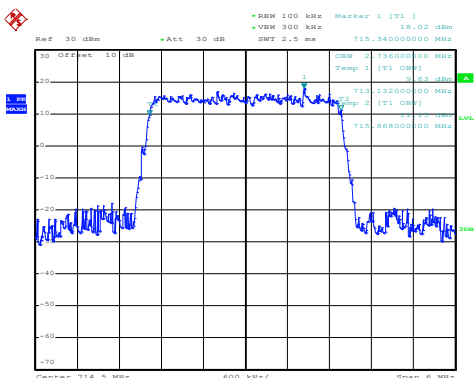

Date: 26.NOV.2016 17:44:55

Modulation: QPSK

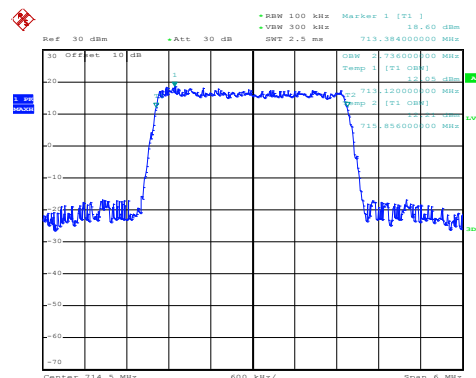

Date: 26.NOV.2016 17:44:50

Highest channel

Test Item: 99% Occupancy bandwidth  
 BW: 5MHz

Modulation: 16QAM

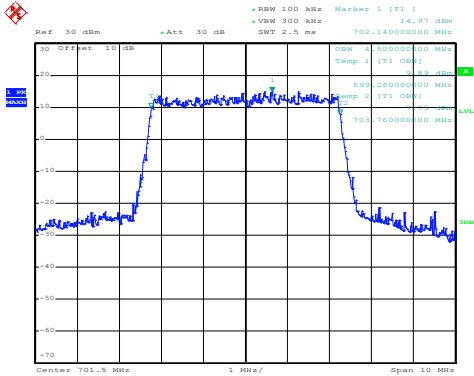

Date: 26.NOV.2016 17:46:31

Modulation: QPSK

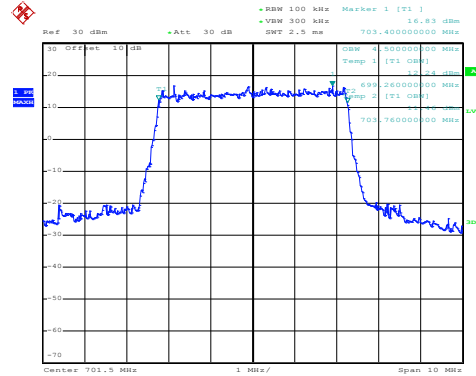

Date: 26.NOV.2016 17:46:25

Lowest channel

Modulation: 16QAM

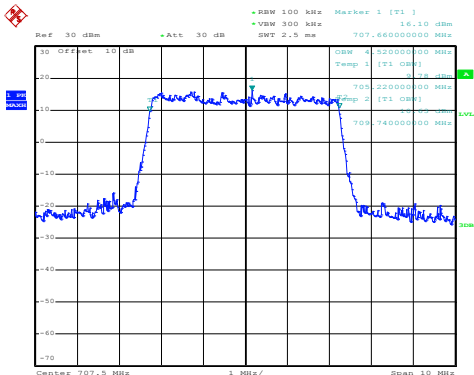

Date: 26.NOV.2016 17:47:47

Modulation: QPSK

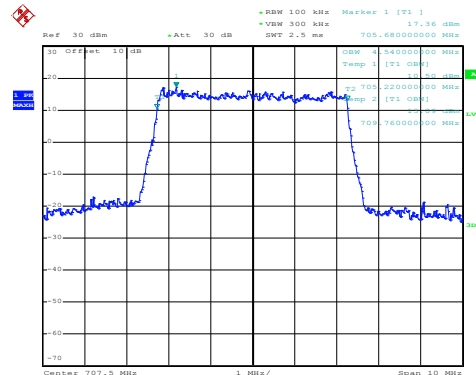

Date: 26.NOV.2016 17:47:33

Middle channel

Modulation: 16QAM

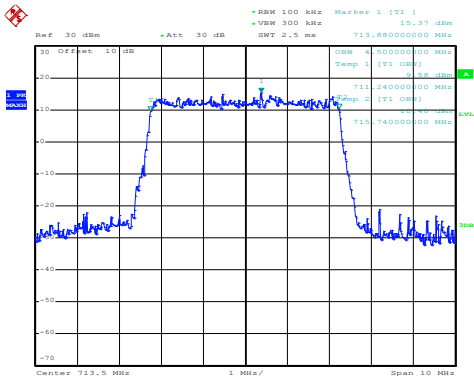

Date: 26.NOV.2016 17:48:45

Modulation: QPSK

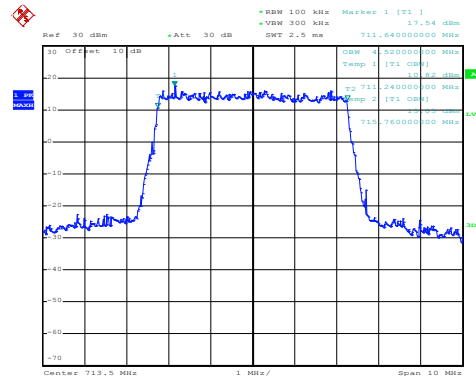

Date: 26.NOV.2016 17:48:40

Highest channel

Test Item:99% Occupy bandwidth  
 BW: 10MHz

Modulation:16QAM

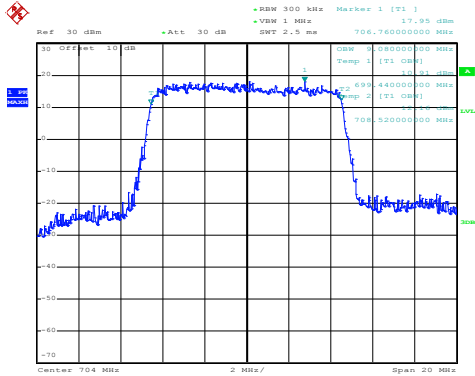

Date: 26.NOV.2016 17:49:59

Modulation: QPSK

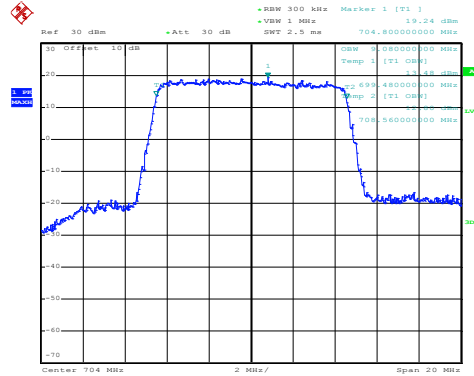

Date: 26.NOV.2016 17:49:53

Lowest channel

Modulation:16QAM

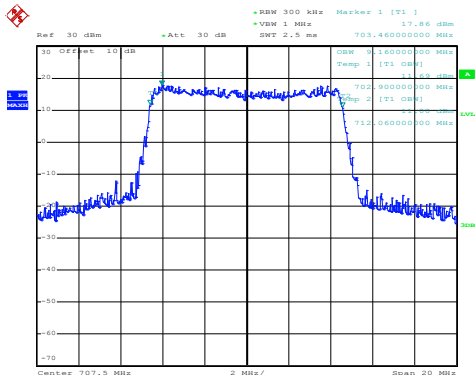

Date: 26.NOV.2016 17:51:23

Modulation: QPSK

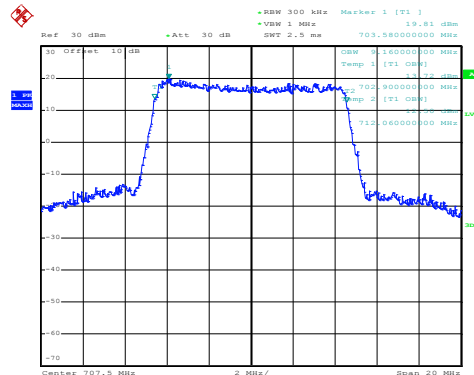

Date: 26.NOV.2016 17:51:17

Middle channel

Modulation:16QAM

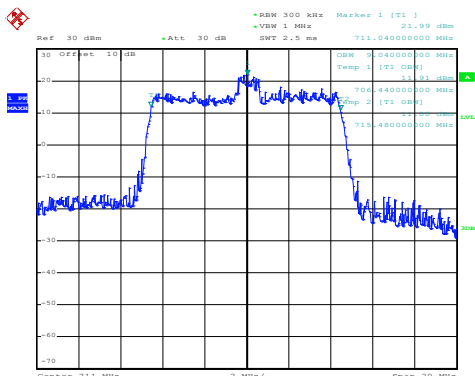

Date: 26.NOV.2016 17:51:56

Modulation: QPSK

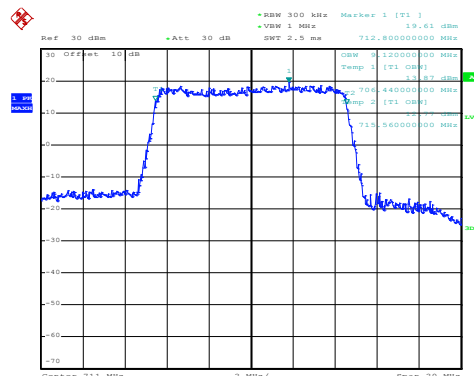

Date: 26.NOV.2016 17:51:49

Highest channel

Test Item:-26dBc bandwidth  
 BW: 1.4MHz

Modulation:16QAM

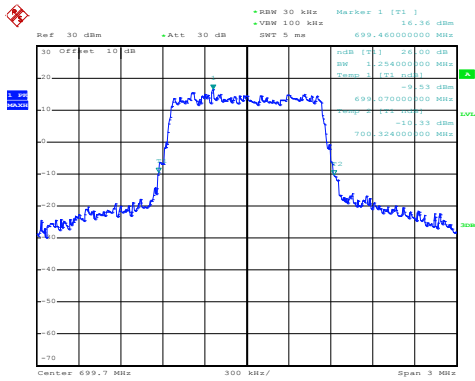

Date: 27.NOV.2016 13:35:00

Modulation: QPSK

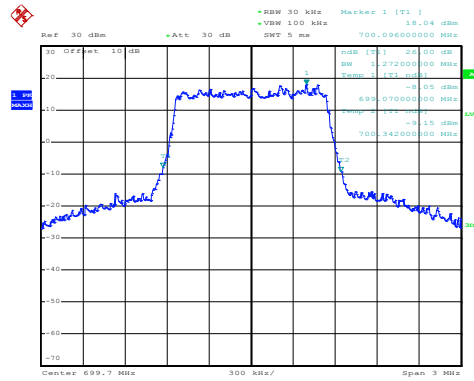

Date: 27.NOV.2016 13:34:53

Lowest channel

Modulation:16QAM

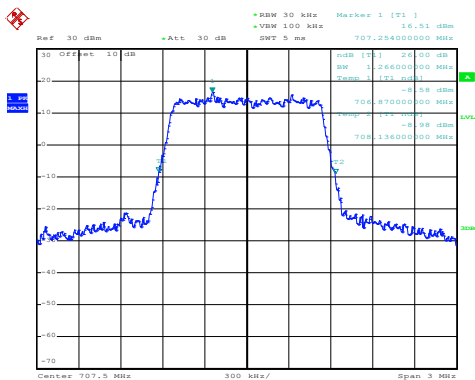

Date: 27.NOV.2016 13:35:43

Modulation: QPSK

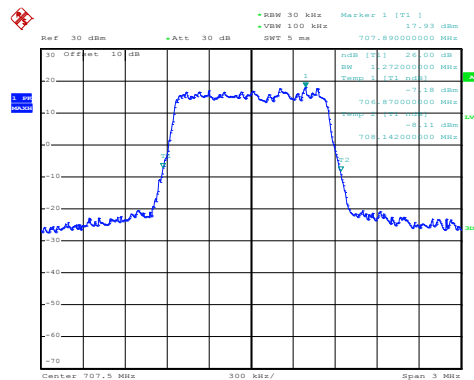

Date: 27.NOV.2016 13:35:35

Middle channel

Modulation:16QAM

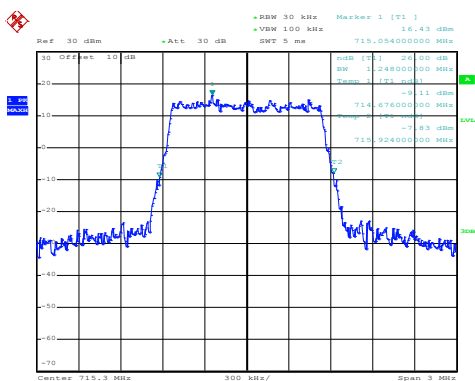

Date: 27.NOV.2016 13:36:53

Modulation: QPSK

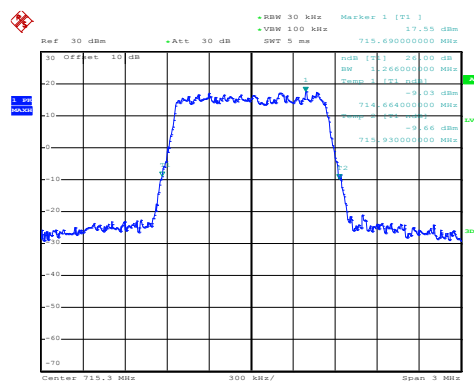

Date: 27.NOV.2016 13:36:48

Highest channel

Test Item:-26dBc bandwidth  
 BW: 3MHz

Modulation:16QAM

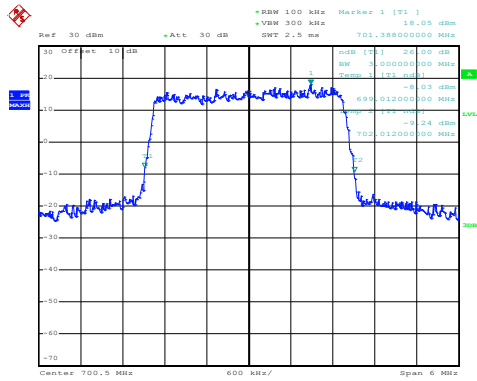

Date: 26.NOV.2016 17:43:35

Modulation: QPSK

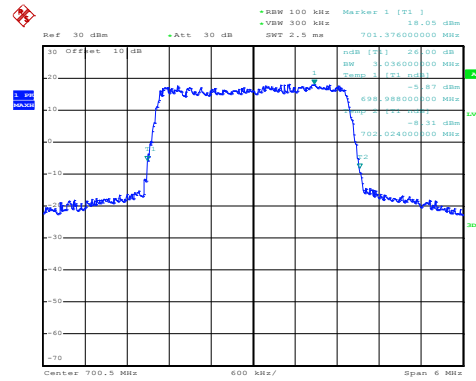

Date: 26.NOV.2016 17:43:29

Lowest channel

Modulation:16QAM

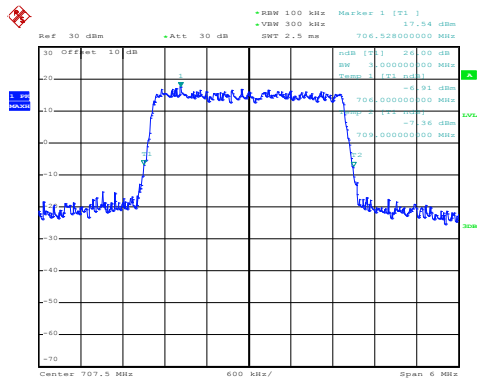

Date: 26.NOV.2016 17:44:12

Modulation: QPSK

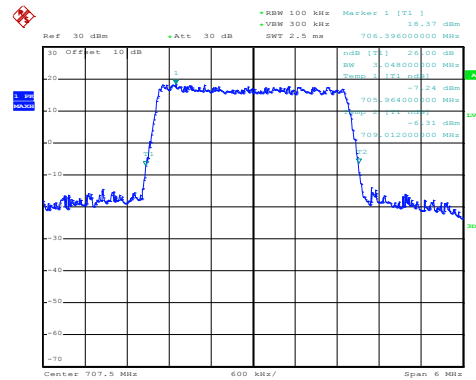

Date: 26.NOV.2016 17:44:06

Middle channel

Modulation:16QAM

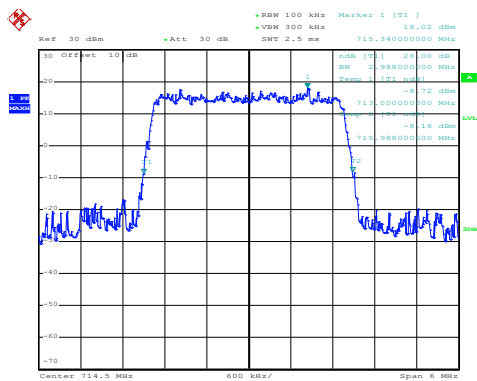

Date: 26.NOV.2016 17:45:12

Modulation: QPSK

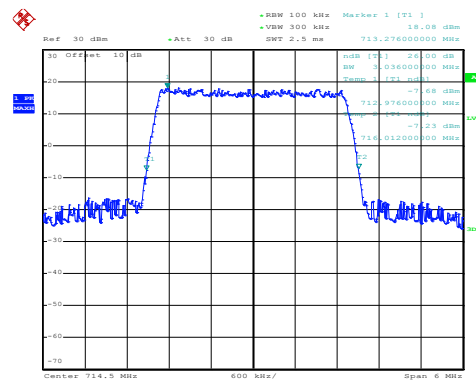

Date: 26.NOV.2016 17:45:06

Highest channel

Test Item:-26dBc bandwidth  
 BW: 5MHz

Modulation:16QAM

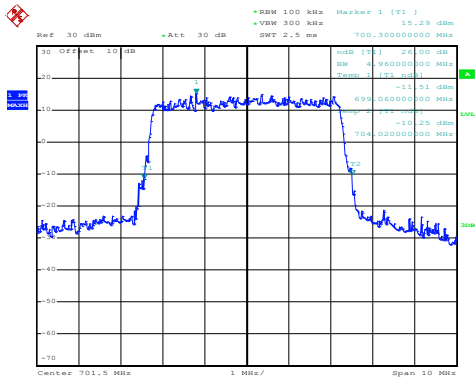

Date: 26.NOV.2016 17:46:10

Modulation: QPSK

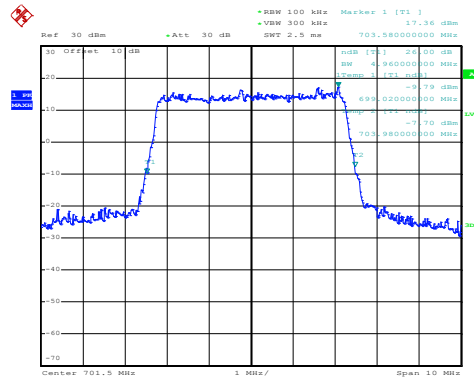

Date: 26.NOV.2016 17:46:04

Lowest channel

Modulation:16QAM

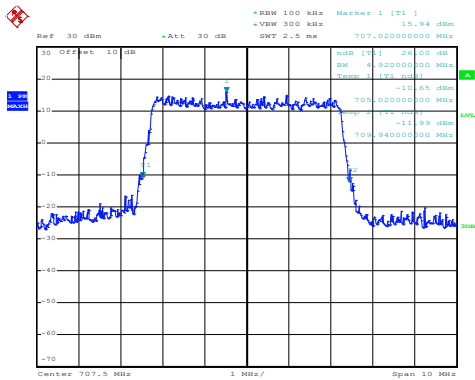

Date: 26.NOV.2016 17:48:05

Modulation: QPSK

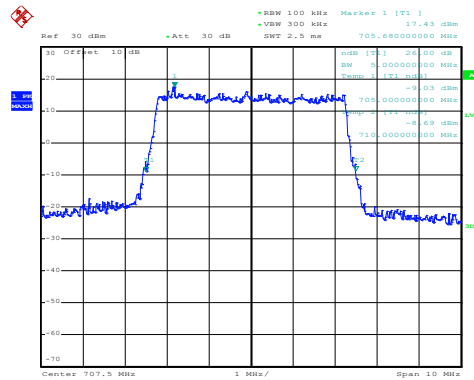

Date: 26.NOV.2016 17:47:58

Middle channel

Modulation:16QAM

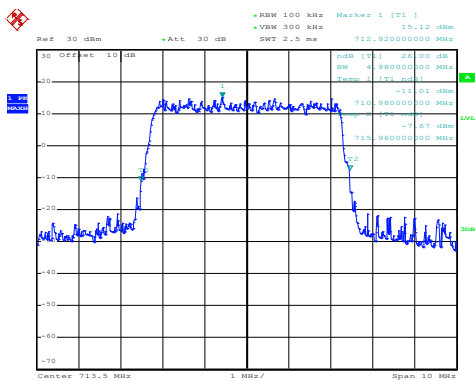

Date: 26.NOV.2016 17:48:29

Modulation: QPSK

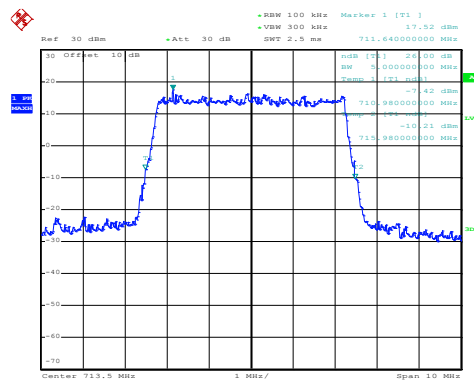

Date: 26.NOV.2016 17:48:25

Highest channel

Test Item:-26dBc bandwidth  
 BW: 10MHz

Modulation:16QAM

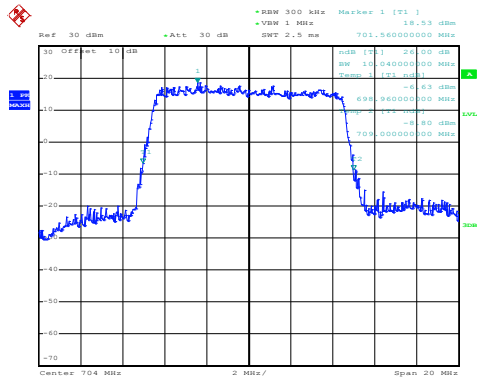

Date: 26.NOV.2016 17:50:32

Modulation: QPSK

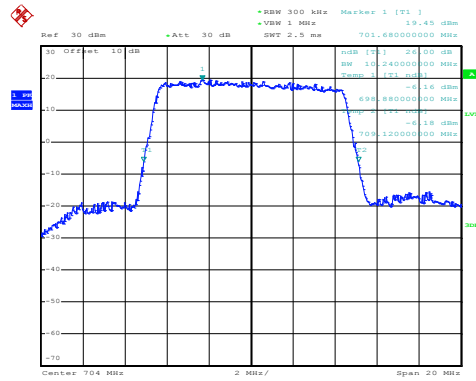

Date: 26.NOV.2016 17:50:26

Lowest channel

Modulation:16QAM

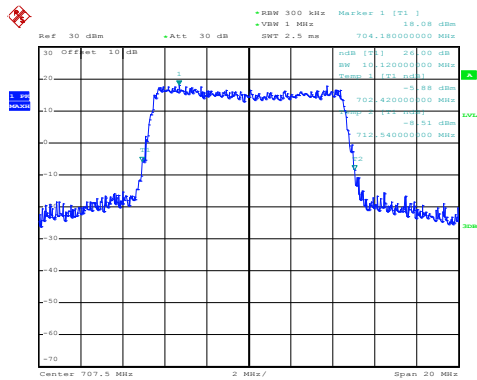

Date: 26.NOV.2016 17:51:07

Modulation: QPSK

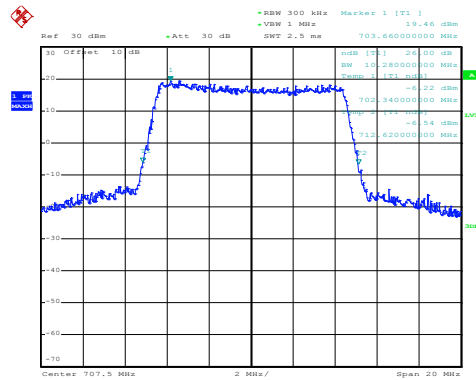

Date: 26.NOV.2016 17:51:02

Middle channel

Modulation:16QAM

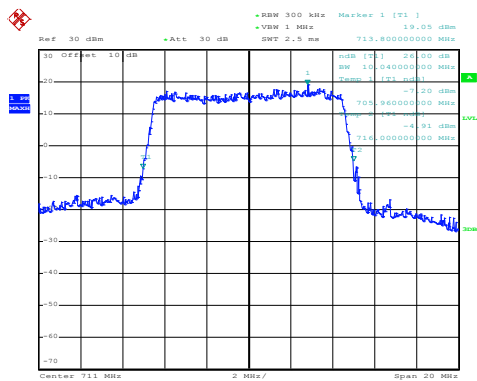

Date: 26.NOV.2016 17:56:34

Modulation: QPSK

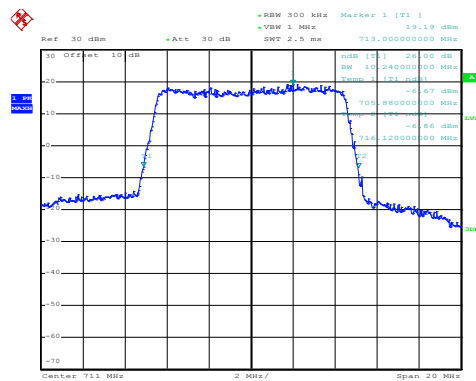

Date: 26.NOV.2016 17:56:27

Highest channel



LTE-Band 17 part

Test Item:99% Occupy bandwidth  
 BW: 5MHz

Modulation:16QAM

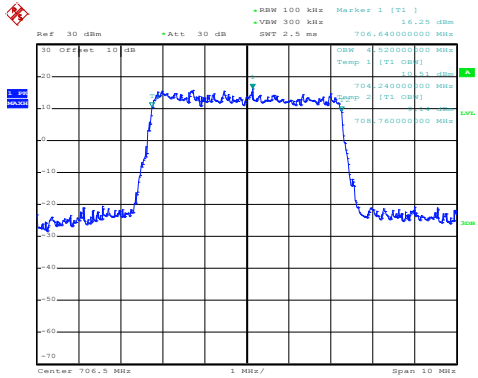

Date: 26.NOV.2016 17:58:19

Modulation: QPSK

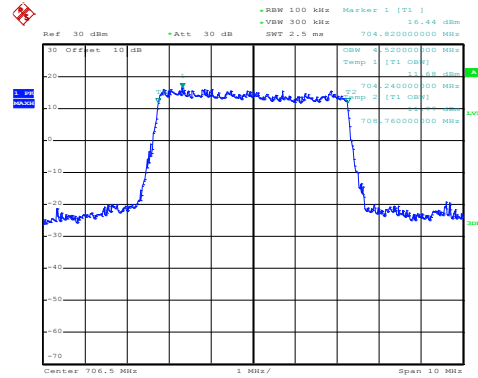

Date: 26.NOV.2016 17:58:08

Lowest channel

Modulation:16QAM

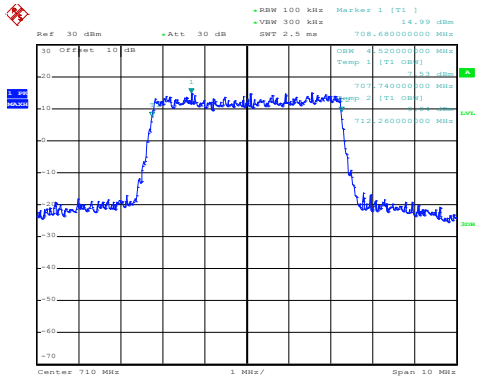

Date: 26.NOV.2016 17:58:45

Modulation: QPSK

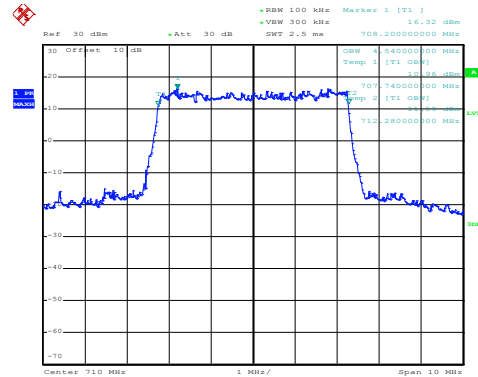

Date: 26.NOV.2016 17:58:39

Middle channel

Modulation:16QAM

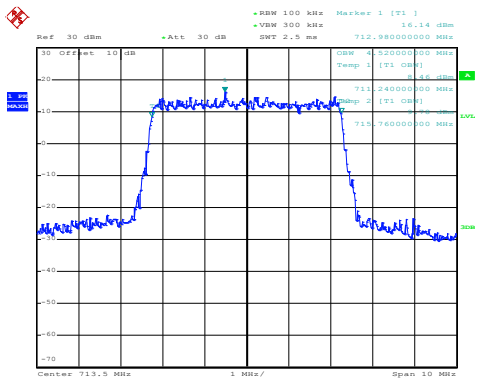

Date: 26.NOV.2016 17:59:52

Modulation: QPSK

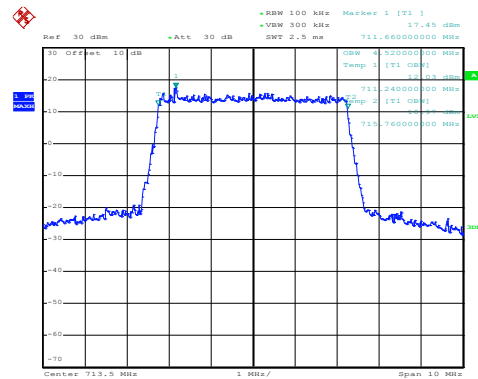

Date: 26.NOV.2016 17:59:46

Highest channel

Test Item:99% Occupy bandwidth  
 BW: 10MHz

Modulation:16QAM

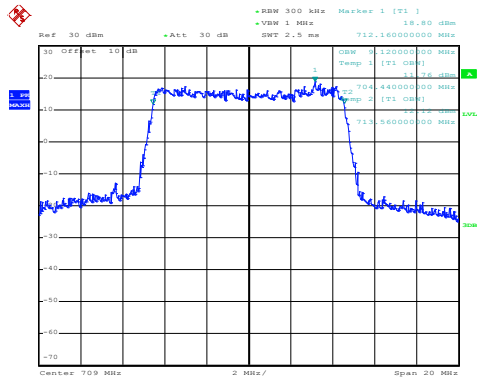

Date: 26.NOV.2016 18:00:44

Modulation: QPSK

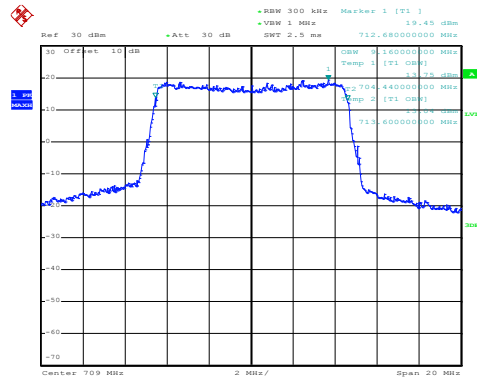

Date: 26.NOV.2016 18:00:39

Lowest channel

Modulation:16QAM

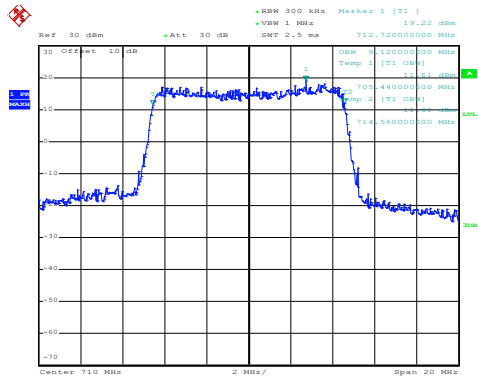

Date: 26.NOV.2016 18:01:40

Modulation: QPSK

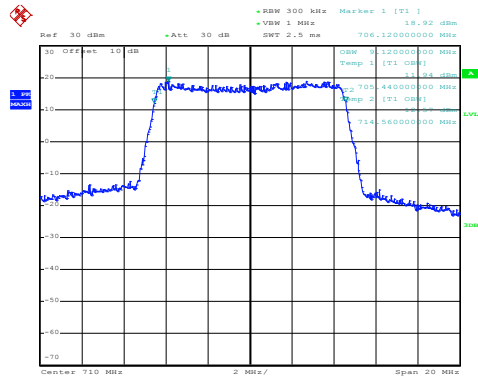

Date: 26.NOV.2016 18:01:35

Middle channel

Modulation:16QAM

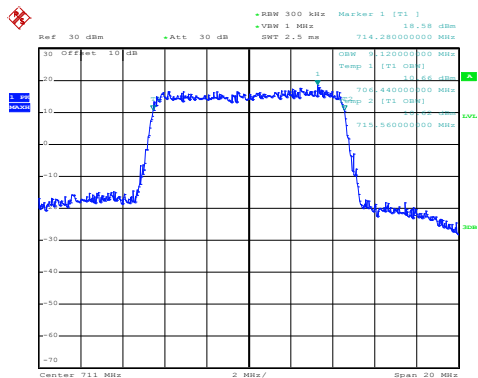

Date: 26.NOV.2016 18:02:06

Modulation: QPSK

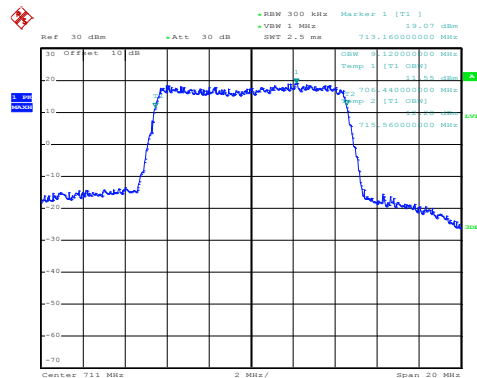

Date: 26.NOV.2016 18:02:00

Highest channel

Test Item:-26dBc bandwidth  
 BW: 5MHz

Modulation:16QAM

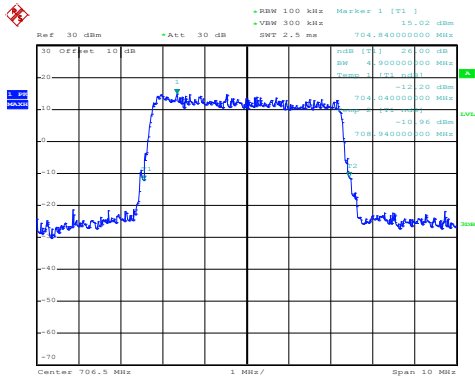

Date: 26.NOV.2016 17:57:43

Modulation: QPSK

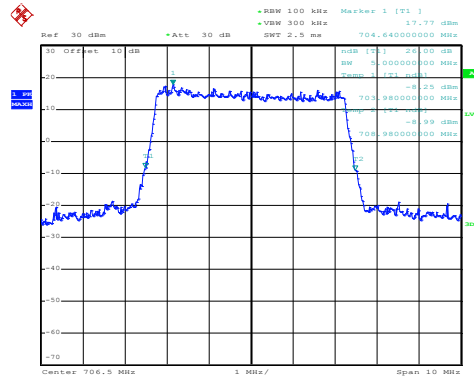

Date: 26.NOV.2016 17:57:36

Lowest channel

Modulation:16QAM

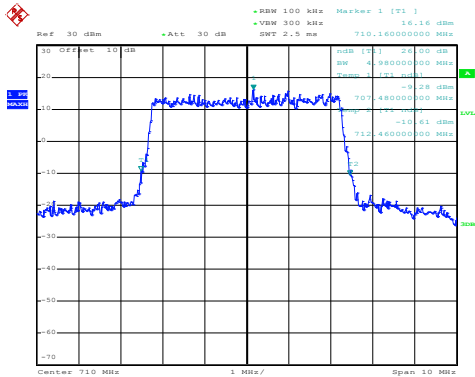

Date: 26.NOV.2016 17:59:01

Modulation: QPSK

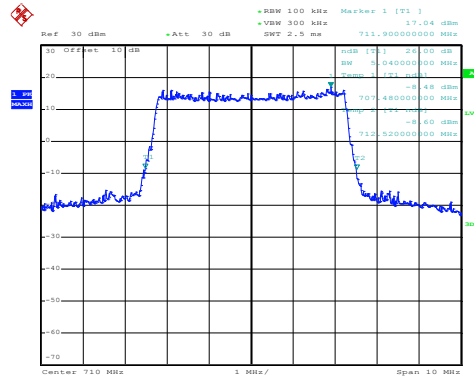

Date: 26.NOV.2016 17:58:56

Middle channel

Modulation:16QAM

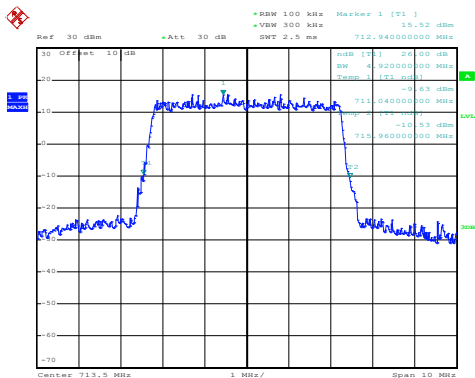

Date: 26.NOV.2016 17:59:34

Modulation: QPSK

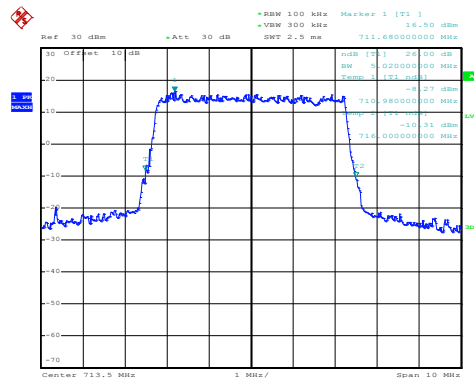

Date: 26.NOV.2016 17:59:29

Highest channel

Test Item:-26dBc bandwidth  
 BW: 10MHz

Modulation:16QAM

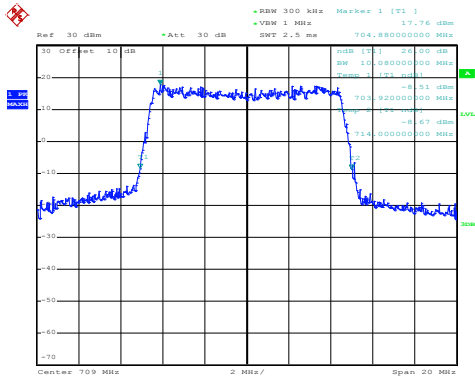

Date: 26.NOV.2016 18:00:58

Modulation: QPSK

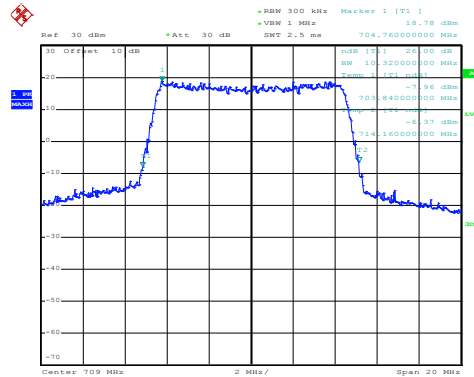

Date: 26.NOV.2016 18:00:53

Lowest channel

Modulation:16QAM

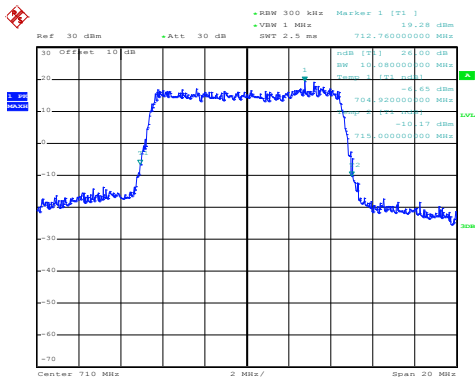

Date: 26.NOV.2016 18:01:23

Modulation: QPSK

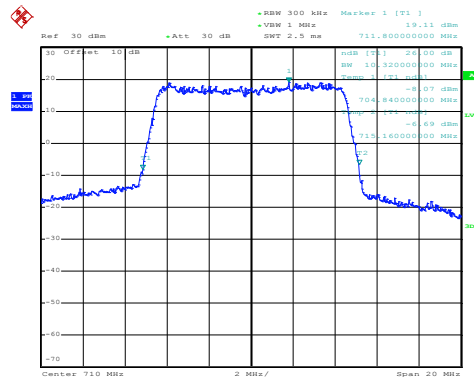

Date: 26.NOV.2016 18:01:19

Middle channel

Modulation:16QAM

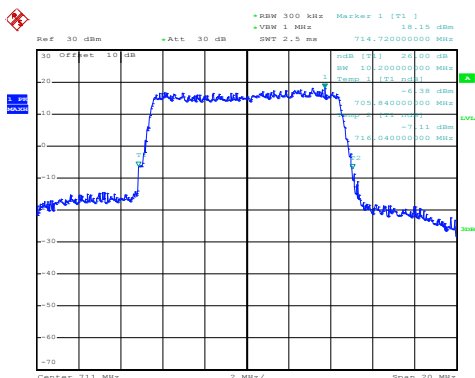

Date: 26.NOV.2016 18:02:26

Modulation: QPSK

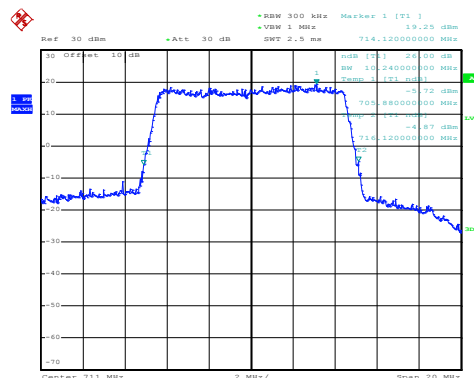

Date: 26.NOV.2016 18:02:20

Highest channel