

FCC REPORT

(LTE)

Applicant: Sun Cupid Technology (HK) Ltd.
Address of Applicant: 16/F, CEO Tower, 77 Wing Hong Street, Cheung Sha Wan, Kowloon, Hong Kong.

Equipment Under Test (EUT)

Product Name: LTE mobile phone
Model No.: N5501L, A5L
Trade mark: NUU

FCC ID: 2ADINN5501L

Applicable standards: FCC CFR Title 47 Part 2
FCC CFR Title 47 Part 22 Subpart H
FCC CFR Title 47 Part 24 Subpart E
FCC CFR Title 47 Part 27 Subpart L
FCC CFR Title 47 Part 27 Subpart M
FCC CFR Title 47 Part 27 Subpart H

Date of sample receipt: 20 Jun., 2018

Date of Test: 20 Jun., to 16 Jul., 2018

Date of report issued: 25 Jul., 2018

Test Result: PASS*

*In the configuration tested, the EUT complied with the standards specified above.

Authorized Signature:



Bruce Zhang
Laboratory Manager

This report details the results of the testing carried out on one sample. The results contained in this test report do not relate to other samples of the same product and does not permit the use of the CCIS product certification mark. The manufacturer should ensure that all products in series production are in conformity with the product sample detailed in this report.

This report may only be reproduced and distributed in full. If the product in this report is used in any configuration other than that detailed in the report, the manufacturer must ensure the new system complies with all relevant standards.

This document cannot be reproduced except in full, without prior written approval of the Company. Any unauthorized alteration, forgery or falsification of the content or appearance of this document is unlawful, and offenders may be prosecuted to the fullest extent of the law. Unless otherwise stated the results shown in this test report refer only to the sample(s) tested and such sample(s) are retained for 90 days only.

2. Version

Version No.	Date	Description
00	25 Jul., 2018	Original

Tested by: YT Yang **Date:** 25 Jul., 2018
Test Engineer

Reviewed by: Wimer Zhang **Date:** 25 Jul., 2018
Project Engineer

3. Contents

	Page
1. COVER PAGE	1
2. VERSION	2
3. CONTENTS	3
4. TEST SUMMARY	4
5. GENERAL INFORMATION	5
5.1 CLIENT INFORMATION.....	5
5.2 GENERAL DESCRIPTION OF E.U.T.....	5
5.3 TEST ENVIRONMENT AND MODE.....	12
5.4 DESCRIPTION OF SUPPORT UNITS.....	12
5.5 MEASUREMENT UNCERTAINTY.....	12
5.6 RELATED SUBMITTAL(S) / GRANT (S).....	12
5.7 LABORATORY FACILITY.....	12
5.8 LABORATORY LOCATION.....	13
5.9 TEST INSTRUMENTS LIST.....	13
6. TEST RESULTS	14
6.1 CONDUCTED OUTPUT POWER.....	14
6.2 PEAK-TO-AVERAGE RATIO.....	24
6.3 OCCUPY BANDWIDTH.....	28
6.4 OUT OF BAND EMISSION AT ANTENNA TERMINALS.....	86
6.5 ERP, EIRP MEASUREMENT.....	243
6.6 FIELD STRENGTH OF SPURIOUS RADIATION MEASUREMENT.....	257
6.7 FREQUENCY STABILITY V.S. TEMPERATURE MEASUREMENT.....	284
6.8 FREQUENCY STABILITY V.S. VOLTAGE MEASUREMENT.....	291
7 TEST SETUP PHOTO	294
8 EUT CONSTRUCTIONAL DETAILS	295

4. Test Summary

Test Items	Section in CFR 47	Result
RF Exposure (SAR)	Part 1.1307 Part 2.1093	Passed (Please refer to SAR Report)
RF Output Power	Part 2.1046 Part 22.913 (a)(2) Part 24.232 (c) Part 27.50 (c)(10) Part 27.50 (d)(4) Part 27.50 (h)(2)	Pass
Peak-to-Average Ratio	Part 24.232 (d) Part 27.50(d)(5)	Pass
Modulation Characteristics	Part 2.1047	Pass
99% & -26 dB Occupied Bandwidth	Part 2.1049 Part 22.917(b) Part 24.238(b) Part 27.53(g) Part 27.53(h) Part 27.53(m)	Pass
Spurious Emissions at Antenna Terminal	Part 2.1051 Part 22.917(a) Part 24.238 (a) Part 27.53 (g) Part 27.53 (h) Part 27.53(m)	Pass
Field Strength of Spurious Radiation	Part 2.1053 Part 22.917(a) Part 24.238 (a) Part 27.53 (g) Part 27.53 (h) Part 27.53(m)	Pass
Out of band emission, Band Edge	Part 22.917(a) Part 24.238 (a) Part 27.53 (g) Part 27.53 (h) Part 27.53(m)	Pass
Frequency stability vs. temperature	Part 22.355 Part 24.235 Part 27.54 Part 2.1055(a)(1)(b)	Pass
Frequency stability vs. voltage	Part 22.355 Part 24.235 Part 27.54 Part 2.1055(d)(2)	Pass

Pass: The EUT complies with the essential requirements in the standard.

5. General Information

5.1 Client Information

Applicant:	Sun Cupid Technology (HK) Ltd.
Address:	16/F, CEO Tower, 77 Wing Hong Street, Cheung Sha Wan, Kowloon, Hong Kong.
Manufacturer:	Sun Cupid Technology (HK) Ltd.
Address:	16/F, CEO Tower, 77 Wing Hong Street, Cheung Sha Wan, Kowloon, Hong Kong.
Factory:	SUNCUPID (ShenZhen) Electronic Ltd
Address:	Baolong Industrial City, Longgang District, Shenzhen Hi-Tech Road, Building 1, A 7, China.

5.2 General Description of E.U.T.

Product Name:	LTE mobile phone
Model No.:	N5501L, A5L
Operation Frequency range:	LTE Band 2: TX: 1850MHz-1910MHz, RX: 1930MHz-1990MHz LTE Band 4: TX: 1710MHz-1755MHz, RX: 2110MHz-2155MHz LTE Band 5: 824MHz-849MHz, RX: 869MHz-894MHz LTE Band 7: TX: 2500MHz-2570MHz, RX: 2620MHz-2690MHz LTE Band 12: TX: 699MHz-716MHz, RX: 729MHz-746MHz LTE Band 17: TX: 704MHz-716MHz, RX: 734MHz-746MHz
Modulation type:	QPSK, 16QAM
Antenna type:	Internal Antenna
Antenna gain:	LTE Band 2: 0.03dBi LTE Band 4: 0.4dBi LTE Band 5: -0.67dBi LTE Band 7: 1.18dBi LTE Band 12: -3.86dBi LTE Band 17: -3.04dBi
Power supply:	Rechargeable Li-ion Battery DC3.8V-2650mAh
AC adapter:	Adapter(1) Model: HNBL050100UX Input: AC100-240V, 50/60Hz, 0.2A Output: DC 5.0V, 1.0A Adapter(2) Model: HJ-0501000E1-US Input: AC100-240V, 50/60Hz, 0.2A Output: DC 5.0V, 1.0A Adapter(3) Model: HJ-0501000B3-EU Input: AC100-240V, 50/60Hz, 0.2A Output: DC 5.0V, 1.0A
Remark:	1. The No.: N5501L, A5L were identical inside, the electrical circuit design, layout, components used and internal wiring, with only difference being model name and trademark. 2. adapter (1) have different pins and the internal structure is the same, so there is no need to do the difference test.

Operation Frequency List:

LTE Band 2 (1.4MHz)		LTE Band 2 (3MHz)	
Channel	Frequency (MHz)	Channel	Frequency (MHz)
18607	1850.70	18615	1851.50
18608	1850.80	18616	1851.60
....
18899	1879.90	18899	1879.90
18900	1880.00	18900	1880.00
18901	1880.10	18901	1880.10
...
19193	1909.20	19185	1908.40
19194	1909.30	19186	1908.50
LTE Band 2 (5MHz)		LTE Band 2 (10MHz)	
Channel	Frequency (MHz)	Channel	Frequency (MHz)
18625	1852.50	18650	1855.00
18626	1852.60	18651	1855.10
....
18899	1879.90	18899	1879.90
18900	1880.00	18900	1880.00
18901	1880.10	18901	1880.10
...
19175	1907.40	19150	1904.90
19176	1907.50	19151	1905.00
LTE Band 2 (15MHz)		LTE Band 2 (20MHz)	
Channel	Frequency (MHz)	Channel	Frequency (MHz)
18675	1857.50	18700	1860.00
18676	1857.60	18701	1860.10
....
18899	1879.90	18899	1879.90
18900	1880.00	18900	1880.00
18901	1880.10	18901	1880.10
...
19125	1902.40	19100	1899.90
19126	1902.50	19101	1900.00

LTE Band 4 (1.4MHz)		LTE Band 4 (3MHz)	
Channel	Frequency (MHz)	Channel	Frequency (MHz)
19957	1710.70	19965	1711.50
19958	1710.80	19966	1711.60
....
20174	1732.40	20174	1732.40
20175	1732.50	20175	1732.50
20176	1732.60	20176	1732.60
...
20392	1754.20	20384	1753.40
20393	1754.30	20385	1753.50
LTE Band 4 (5MHz)		LTE Band 4 (10MHz)	
Channel	Frequency (MHz)	Channel	Frequency (MHz)
19975	1712.50	20000	1715.00
19976	1712.60	20001	1715.10
....
20174	1732.40	20174	1732.40
20175	1732.50	20175	1732.50
20176	1732.60	20176	1732.60
...
20374	1752.40	20349	1749.90
20375	1752.50	20350	1750.00
LTE Band 4 (15MHz)		LTE Band 4 (20MHz)	
Channel	Frequency (MHz)	Channel	Frequency (MHz)
20025	1717.50	20050	1720.00
20026	1717.60	20051	1720.10
....
20174	1732.40	20174	1732.40
20175	1732.50	20175	1732.50
20176	1732.60	20176	1732.60
...
20324	1747.40	20299	1744.90
20325	1747.50	20300	1745.00

LTE Band 5 (1.4MHz)		LTE Band 5 (3MHz)	
Channel	Frequency (MHz)	Channel	Frequency (MHz)
20407	824.70	20415	825.50
20408	824.80	20416	825.60
....
20524	836.40	20524	836.40
20525	836.50	20525	836.50
20526	836.60	20526	836.60
...
20642	848.20	20634	847.40
20643	848.30	20635	847.50
LTE Band 5 (5MHz)		LTE Band 5 (10MHz)	
Channel	Frequency (MHz)	Channel	Frequency (MHz)
20425	826.50	20450	829.00
20426	826.60	20451	829.10
....
20524	836.40	20524	836.40
20525	836.50	20525	836.50
20526	836.60	20526	836.60
...
20624	846.40	20599	839.90
20625	846.50	20600	844.00

LTE Band 7 (5MHz)		LTE Band 7 (10MHz)	
Channel	Frequency (MHz)	Channel	Frequency (MHz)
20775	2502.50	20800	2505.00
20776	2502.60	20801	2502.10
....
21099	2534.90	21099	2534.90
21100	2535.00	21100	2535.00
21101	2535.20	21101	2535.20
...
21424	2567.40	21399	2564.90
21425	2567.50	21400	2565.00
LTE Band 7 (15MHz)		LTE Band 7 (20MHz)	
Channel	Frequency (MHz)	Channel	Frequency (MHz)
20825	2507.50	20850	2510.00
20826	2507.60	20851	2510.10
....
21099	2534.90	21099	2534.90
21100	2535.00	21100	2535.00
21101	2535.20	21101	2535.20
...
21374	2562.40	21349	2559.90
21375	2562.50	21350	2560.00

LTE Band 12 (1.4MHz)		LTE Band 12 (3MHz)	
Channel	Frequency (MHz)	Channel	Frequency (MHz)
23017	699.70	23025	700.50
23756	699.80	23026	700.60
....
23094	707.40	23094	707.40
23095	707.50	23095	707.50
23096	707.60	23096	707.60
...
23172	715.20	23164	714.40
23173	715.30	23165	714.50
LTE Band 12 (5MHz)		LTE Band 12 (10MHz)	
Channel	Frequency (MHz)	Channel	Frequency (MHz)
23035	701.50	23060	704.00
23036	701.60	23061	704.10
....
23094	707.40	23094	707.40
23095	707.50	23095	707.50
23096	707.60	23096	707.60
...
23154	713.40	23129	710.90
23155	713.50	23130	711.00

LTE Band 17 (5MHz)		LTE Band 17 (10MHz)	
Channel	Frequency (MHz)	Channel	Frequency (MHz)
23755	706.50	23780	709.00
23756	706.60	23781	709.10
....
23789	709.90	23789	709.90
23790	710.00	23790	710.00
23791	710.10	23791	710.10
...
23824	713.40	23799	710.90
23825	713.50	23800	711.00

Regards to the operating frequency range, the lowest frequency, the middle frequency, and the highest frequency of channel were selected to perform the test, and the selected channels as below:

LTE Band 2 (1.4MHz)			LTE Band 2 (3MHz)		
Channel	Frequency (MHz)		Channel	Frequency (MHz)	
Lowest channel	18607	1850.70	Lowest channel	18615	1851.50
Middle channel	18900	1880.00	Middle channel	18900	1880.00
Highest channel	19193	1909.30	Highest channel	19185	1908.50
LTE Band 2 (5MHz)			LTE Band 2 (10MHz)		
Channel	Frequency (MHz)		Channel	Frequency (MHz)	
Lowest channel	18625	1852.50	Lowest channel	18650	1855.00
Middle channel	18900	1880.00	Middle channel	18900	1880.00
Highest channel	19175	1907.50	Highest channel	19150	1905.00
LTE Band 2 (15MHz)			LTE Band 2 (20MHz)		
Channel	Frequency (MHz)		Channel	Frequency (MHz)	
Lowest channel	18675	1857.50	Lowest channel	18700	1860.00
Middle channel	18900	1880.00	Middle channel	18900	1880.00
Highest channel	19125	1902.50	Highest channel	19100	1900.00

LTE Band 4 (1.4MHz)			LTE Band 4 (3MHz)		
Channel:	Frequency (MHz)		Channel	Frequency (MHz)	
Lowest channel	19957	1710.70	Lowest channel	19965	1711.50
Middle channel	20175	1732.50	Middle channel	20175	1732.50
Highest channel	20393	1754.30	Highest channel	20385	1753.50
LTE Band 4 (5MHz)			LTE Band 4 (10MHz)		
Channel	Frequency (MHz)		Channel	Frequency (MHz)	
Lowest channel	19975	1712.50	Lowest channel	20000	1715.00
Middle channel	20175	1732.50	Middle channel	20175	1732.50
Highest channel	20375	1752.50	Highest channel	20350	1750.00
LTE Band 4 (15MHz)			LTE Band 4 (20MHz)		
Channel	Frequency (MHz)		Channel	Frequency (MHz)	
Lowest channel	20025	1717.50	Lowest channel	20050	1720.00
Middle channel	20175	1732.50	Middle channel	20175	1732.50
Highest channel	20325	1747.50	Highest channel	20300	1745.00

LTE Band 5 (1.4MHz)			LTE Band 5 (3MHz)		
Channel:	Frequency (MHz)		Channel	Frequency (MHz)	
Lowest channel	20407	824.70	Lowest channel	20415	825.50
Middle channel	20525	836.50	Middle channel	20525	836.50
Highest channel	20643	848.30	Highest channel	20635	847.50
LTE Band 5 (5MHz)			LTE Band 5 (10MHz)		
Channel	Frequency (MHz)		Channel	Frequency (MHz)	
Lowest channel	20425	826.50	Lowest channel	20450	829.00
Middle channel	20525	836.50	Middle channel	20525	836.50
Highest channel	20625	846.50	Highest channel	20600	844.00

LTE Band 7 (5MHz)			LTE Band 7 (10MHz)		
Channel	Frequency (MHz)		Channel	Frequency (MHz)	
Lowest channel	20775	2502.50	Lowest channel	20800	2505.00
Middle channel	21100	2535.00	Middle channel	21100	2535.00
Highest channel	21425	2567.50	Highest channel	21400	2565.00
LTE Band 7 (15MHz)			LTE Band 7 (20MHz)		
Channel	Frequency (MHz)		Channel	Frequency (MHz)	
Lowest channel	20825	2507.50	Lowest channel	20850	2510.00
Middle channel	21100	2535.00	Middle channel	21100	2535.00
Highest channel	21375	2562.50	Highest channel	21350	2560.00

LTE Band 12(1.4MHz)			LTE Band 12(3MHz)		
Channel	Frequency (MHz)		Channel	Frequency (MHz)	
Lowest channel	23017	699.70	Lowest channel	23025	700.50
Middle channel	23095	707.50	Middle channel	23095	707.50
Highest channel	23173	715.30	Highest channel	23165	714.50
LTE Band 12(5MHz)			LTE Band 12(10MHz)		
Channel	Frequency (MHz)		Channel	Frequency (MHz)	
Lowest channel	23035	701.50	Lowest channel	23060	704.00
Middle channel	23095	707.50	Middle channel	23095	707.50
Highest channel	23155	713.50	Highest channel	23130	711.00

LTE Band 17(5MHz)			LTE Band 17(10MHz)		
Channel	Frequency (MHz)		Channel	Frequency (MHz)	
Lowest channel	23755	706.50	Lowest channel	23780	709.00
Middle channel	23790	710.00	Middle channel	23790	710.00
Highest channel	23825	713.50	Highest channel	23800	711.00

5.3 Test environment and mode

Operating Environment:	
Temperature:	Normal: 15°C ~ 35°C, Extreme: -30°C ~ +50°C
Humidity:	20 % ~ 75 % RH
Atmospheric Pressure:	1008 mbar
Voltage:	Nominal: 3.8Vdc, Extreme: Low 3.5Vdc, High 4.35Vdc
Test mode:	
LTE QPSK mode	Keep the EUT communication with simulated station in QPSK mode
LTE 16-QAM mode	Keep the EUT communication with simulated station in 16-QAM mode
Remark: The EUT has been tested under continuous transmitting mode. Channel Low, Mid and High for each type band with rated data rate were chosen for full testing. The field strength of spurious radiation emission was measured as EUT stand-up position (H mode) and lie down position (E1, E2 mode) for these modes with power adaptor, earphone and Data cable. Just the worst case position (H mode) shown in report.	

5.4 Description of Support Units

Test Equipment	Manufacturer	Model No.	Serial No.
Simulated Station	Anritsu	MT8820C	6201026545

5.5 Measurement Uncertainty

Parameters	Expanded Uncertainty
Radiated Emission (9kHz ~ 30MHz)	±2.76 dB (k=2)
Radiated Emission (30MHz ~ 1000MHz)	±4.28 dB (k=2)
Radiated Emission (1GHz ~ 18GHz)	±5.72 dB (k=2)
Radiated Emission (18GHz ~ 40GHz)	±2.88 dB (k=2)

5.6 Related Submittal(s) / Grant (s)

This is an original grant, no related submittals and grants.
--

5.7 Laboratory Facility

<p>The test facility is recognized, certified, or accredited by the following organizations:</p> <ul style="list-style-type: none"> ● FCC - Registration No.: 727551 Shenzhen Zhongjian Nanfang Testing Co., Ltd. has been accredited as a testing laboratory by FCC (Federal Communications Commission). The Registration No. is 727551. ● IC - Registration No.: 10106A-1 The 3m Semi-anechoic chamber of Shenzhen Zhongjian Nanfang Testing Co., Ltd. has been Registered by Certification and Engineering Bureau of Industry Canada for radio equipment testing with Registration No.: 10106A-1. ● CNAS - Registration No.: CNAS L6048 Shenzhen Zhongjian Nanfang Testing Co., Ltd. is accredited to ISO/IEC 17025:2005 General Requirements for the Competence of Testing and Calibration laboratories for the competence of testing. The Registration No. is CNAS L6048. ● A2LA - Registration No.: 4346.01 This laboratory is accredited in accordance with the recognized International Standard ISO/IEC 17025:2005 General requirements for the competence of testing and calibration laboratories. The test scope can be found as below link: https://portal.a2la.org/scopepdf/4346-01.pdf

5.8 Laboratory Location

Shenzhen Zhongjian Nanfang Testing Co., Ltd.
 Address: No. B-C, 1/F., Building 2, Laodong No.2 Industrial Park, Xixiang Road,
 Bao'an District, Shenzhen, Guangdong, China
 Tel: +86-755-23118282, Fax: +86-755-23116366
 Email: info@ccis-cb.com, Website: http://www.ccis-cb.com

5.9 Test Instruments list

Test Equipment	Manufacturer	Model No.	Serial No.	Cal. Date (mm-dd-yy)	Cal. Due date (mm-dd-yy)
3m SAC	SAEMC	9m*6m*6m	966	07-22-2017	07-21-2020
BiConiLog Antenna	SCHWARZBECK	VULB9163	497	03-16-2018	03-15-2019
Biconical Antenna	SCHWARZBECK	VUBA9117	359	06-22-2017	06-21-2018
				06-22-2018	06-21-2019
Horn Antenna	SCHWARZBECK	BBHA9120D	916	03-16-2018	03-15-2019
Horn Antenna	SCHWARZBECK	BBHA9120D	1805	03-16-2018	03-15-2019
EMI Test Software	AUDIX	E3	6.110919b	N/A	N/A
Pre-amplifier	HP	8447D	2944A09358	03-07-2018	03-06-2019
Pre-amplifier	CD	PAP-1G18	11804	03-07-2018	03-06-2019
Spectrum analyzer	Rohde & Schwarz	FSP30	101454	03-07-2018	03-06-2019
EMI Test Receiver	Rohde & Schwarz	ESRP7	101070	03-07-2018	03-06-2019
Spectrum Analyzer	Agilent	N9020A	MY50510123	10-29-2017	10-28-2018
Signal Generator	Rohde & Schwarz	SMX	835454/016	03-07-2018	03-06-2019
Signal Generator	R&S	SMR20	1008100050	03-07-2018	03-06-2019
RF Switch Unit	MWRFTTEST	MW200	N/A	N/A	N/A
Cable	ZDECL	Z108-NJ-NJ-81	1608458	03-07-2018	03-06-2019
Cable	MICRO-COAX	MFR64639	K10742-5	03-07-2018	03-06-2019
Cable	SUHNER	SUCOFLEX100	58193/4PE	03-07-2018	03-06-2019
DC Power Supply	XinNuoEr	WYK-10020K	1409050110020	10-31-2017	10-30-2018
Temperature Humidity Chamber	HengPu	HPGDS-500	20140828008	09-24-2017	09-23-2018
Simulated Station	Rohde & Schwarz	CMW500	140493	06-24-2017	06-23-2018

6. Test results

6.1 Conducted Output Power

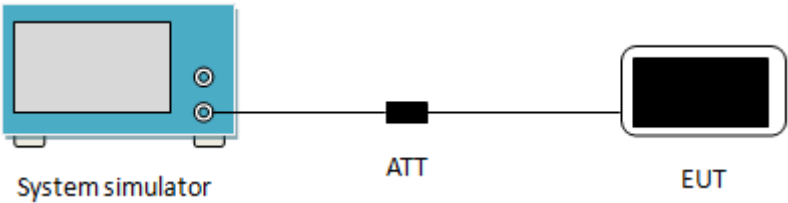
Test Requirement:	Part 22.913(a)(2), Part 24.232(c), part 27.50(c)(10), Part 27.50(d)(4), Part 27.50 (h)(2)
Test Method:	ANSI/TIA-603-D 2010
Limit:	LTE Band 2: 2W, LTE Band 4: 1W, LTE Band 5: 7W, LTE Band 7: 2W, LTE Band 12: 3W, LTE Band 17: 3W
Test Setup:	 <p>The diagram illustrates the test setup. On the left is a blue 'System simulator' with a screen and two ports. A line connects it to a black 'ATT' (attenuator) block. Another line connects the 'ATT' to a black 'EUT' (Equipment Under Test) device.</p>
Test Procedure:	The transmitter output was connected to a calibrated attenuator, the other end of which was connected to the CMW500. Transmitter output power was read off in dBm.
Test Instruments:	Refer to section 5.9 for details
Test mode:	Refer to section 5.3 for details
Test results:	Passed

Measurement Data:

LTE Band	Bandwidth (MHz)	Modulation	RB Size	RB Offset	Average Power (dBm)		
					18607	18900	19193
					1850.7MHz	1880.0MHz	1909.3MHz
2	1.4	QPSK	1	0	21.95	22.26	21.56
			1	2	22.01	22.46	21.77
			1	5	21.98	22.39	21.89
			3	0	21.12	21.37	21.21
			3	1	21.10	21.29	21.18
			3	2	21.14	21.31	21.25
		16QAM	6	0	21.31	21.46	20.48
			1	0	21.13	21.36	21.23
			1	2	21.34	21.54	21.12
			1	5	21.35	21.48	21.32
			3	0	21.27	21.55	20.68
			3	1	21.23	21.54	20.56
			3	2	21.12	21.41	20.34
			6	0	20.36	20.46	20.41
LTE Band	Bandwidth (MHz)	Modulation	RB Size	RB Offset	Average Power (dBm)		
					18615	18900	19185
					1851.5MHz	1880.0MHz	1908.5MHz
2	3	QPSK	1	0	22.25	21.89	21.45
			1	7	22.13	21.78	21.41
			1	14	22.14	21.98	21.35
			8	0	21.14	21.17	20.42
			8	4	21.15	20.86	20.59
			8	7	21.15	20.78	20.40
		16QAM	15	0	21.31	20.84	20.41
			1	0	21.35	20.91	20.72
			1	7	21.32	20.93	20.48
			1	14	21.13	20.82	20.66
			8	0	21.26	21.22	21.20
			8	4	21.03	21.11	21.12
			8	7	20.59	20.44	20.41
			15	0	20.69	20.64	20.36
LTE Band	Bandwidth (MHz)	Modulation	RB Size	RB Offset	Average Power (dBm)		
					18625	18900	19175
					1852.5MHz	1880.0MHz	1907.5MHz
2	5	QPSK	1	0	21.72	22.01	21.35
			1	12	21.83	22.12	21.45
			1	24	21.75	21.89	21.34
			12	0	20.89	21.20	20.47
			12	6	20.86	21.12	20.43
			12	11	20.83	21.12	20.54
			25	0	20.90	21.20	20.53
		16QAM	1	0	21.10	21.48	20.45
			1	12	21.03	21.15	20.90
			1	24	20.87	20.95	20.34
			12	0	20.89	20.88	20.89
			12	6	20.63	20.54	20.92
			12	11	20.65	20.64	20.64
			25	0	20.44	20.54	20.58

LTE Band	Bandwidth (MHz)	Modulation	RB Size	RB Offset	Average Power (dBm)		
					18650	18900	19150
					1855.0MHz	1880.0MHz	1905.0MHz
2	10	QPSK	1	0	21.78	22.12	21.45
			1	24	21.85	22.23	21.35
			1	49	21.74	21.78	21.34
			25	0	21.01	21.24	21.28
			25	12	20.98	21.19	20.51
			25	24	20.95	21.10	20.45
			50	0	20.96	21.12	20.54
		16QAM	1	0	20.72	21.26	20.48
			1	24	21.03	21.33	20.63
			1	49	21.00	21.31	20.51
			25	0	21.23	20.18	21.26
			25	12	21.32	21.56	21.04
			25	24	21.15	21.26	21.22
			50	0	20.56	20.98	20.44
LTE Band	Bandwidth (MHz)	Modulation	RB Size	RB Offset	Average Power (dBm)		
					18675	18900	19125
					1857.5MHz	1880.0MHz	1902.5MHz
2	15	QPSK	1	0	21.75	22.14	21.32
			1	37	21.78	22.01	21.10
			1	74	21.85	21.65	21.32
			36	0	20.87	21.27	20.58
			36	16	21.02	21.20	20.55
			36	35	21.01	21.08	20.52
			75	0	21.03	21.14	20.51
		16QAM	1	0	21.27	21.44	20.53
			1	37	21.47	21.39	20.64
			1	74	21.03	21.14	20.89
			36	0	21.26	20.30	19.53
			36	16	21.31	21.06	20.98
			36	35	21.11	21.13	21.16
			75	0	20.49	20.58	20.56
LTE Band	Bandwidth (MHz)	Modulation	RB Size	RB Offset	Average Power (dBm)		
					18700	18900	19100
					1860.0MHz	1880.0MHz	1900.0MHz
2	20	QPSK	1	0	21.78	22.12	21.35
			1	49	21.93	22.42	21.25
			1	99	21.05	21.39	21.17
			50	0	21.11	21.26	20.82
			50	24	20.89	21.19	20.58
			50	49	21.11	21.11	20.49
			100	0	21.12	21.11	20.60
		16QAM	1	0	20.75	20.88	20.90
			1	49	21.12	21.36	20.54
			1	99	21.23	20.42	20.47
			50	0	21.03	21.11	21.41
			50	24	20.53	20.45	20.65
			50	49	20.63	20.64	20.63
			100	0	20.55	20.52	20.48

LTE Band	Bandwidth (MHz)	Modulation	RB Size	RB Offset	Average Power (dBm)		
					19957	20175	20393
					1710.7MHz	1732.5MHz	1754.3MHz
4	1.4	QPSK	1	0	22.35	22.14	21.98
			1	2	22.25	22.35	21.14
			1	5	22.24	22.16	21.89
			3	0	21.21	21.30	21.10
			3	1	21.23	21.47	21.05
			3	2	21.31	21.15	21.03
		16QAM	6	0	21.24	21.47	21.09
			1	0	21.20	21.19	21.24
			1	2	21.25	21.31	21.03
			1	5	21.23	21.25	20.89
			3	0	21.37	21.30	20.96
			3	1	21.25	21.32	21.19
			3	2	21.21	21.38	21.35
			6	0	20.35	20.63	20.35
LTE Band	Bandwidth (MHz)	Modulation	RB Size	RB Offset	Average Power (dBm)		
					19965	20175	20385
					1711.5MHz	1732.5MHz	1753.5MHz
4	3	QPSK	1	0	22.35	22.29	21.95
			1	7	22.15	22.17	21.85
			1	14	22.14	22.17	22.13
			8	0	21.34	21.28	21.21
			8	4	21.39	21.30	21.14
			8	7	21.25	21.27	21.08
		16QAM	15	0	21.23	21.23	21.03
			1	0	21.45	21.12	21.38
			1	7	21.27	21.25	21.35
			1	14	21.59	21.33	21.43
			8	0	20.38	20.36	20.35
			8	4	20.36	20.36	20.41
			8	7	20.40	20.46	20.36
			15	0	22.35	22.29	21.95
LTE Band	Bandwidth (MHz)	Modulation	RB Size	RB Offset	Average Power (dBm)		
					19975	20175	20375
					1712.5MHz	1732.5MHz	1752.5MHz
4	5	QPSK	1	0	22.23	22.25	22.12
			1	12	22.24	22.23	22.05
			1	24	22.19	22.15	22.06
			12	0	21.33	21.27	21.00
			12	6	21.36	21.31	21.14
			12	11	21.24	21.26	21.06
		16QAM	25	0	21.32	21.35	21.41
			1	0	21.28	21.13	21.13
			1	12	21.39	21.69	21.36
			1	24	21.64	21.41	21.31
			12	0	20.63	20.36	20.36
			12	6	20.35	20.45	20.52
			12	11	20.51	20.53	20.41
			25	0	20.33	20.36	20.33

LTE Band	Bandwidth (MHz)	Modulation	RB Size	RB Offset	Average Power (dBm)		
					20000	20175	20350
					1715.0MHz	1732.5MHz	1750.0MHz
4	10	QPSK	1	0	22.35	22.35	22.17
			1	24	22.45	22.42	22.15
			1	49	22.34	22.19	22.16
			25	0	21.41	21.36	21.19
			25	12	21.32	21.32	21.21
			25	24	21.36	21.33	21.16
		16QAM	50	0	21.42	21.40	21.25
			1	0	21.46	21.38	21.35
			1	24	21.50	21.28	21.36
			1	49	21.02	21.48	21.24
			25	0	20.52	20.38	20.39
			25	12	20.46	20.39	20.35
			25	24	20.44	20.53	20.45
			50	0	20.36	20.36	20.33
LTE Band	Bandwidth (MHz)	Modulation	RB Size	RB Offset	Average Power (dBm)		
					20025	20175	20325
					1717.5MHz	1732.5MHz	1747.5MHz
4	15	QPSK	1	0	22.45	22.35	22.17
			1	37	22.36	22.23	22.16
			1	74	22.14	22.19	22.23
			36	0	21.35	21.41	21.28
			36	16	21.27	21.39	21.02
			36	35	21.29	21.20	21.05
			75	0	21.39	21.37	21.19
		16QAM	1	0	21.79	21.35	21.16
			1	37	21.41	21.20	21.70
			1	74	21.68	21.66	21.05
			36	0	20.38	20.34	20.56
			36	16	20.41	20.39	20.41
			36	35	20.39	20.41	20.66
			75	0	20.34	20.42	20.34
LTE Band	Bandwidth (MHz)	Modulation	RB Size	RB Offset	Average Power (dBm)		
					20050	20175	20300
					1720.0MHz	1732.5MHz	1745.0MHz
4	20	QPSK	1	0	22.35	22.45	22.18
			1	49	22.14	22.12	22.12
			1	99	22.16	22.14	21.86
			50	0	21.34	21.48	21.34
			50	24	21.33	21.35	21.35
			50	49	21.34	21.45	21.17
			100	0	21.30	21.34	21.34
		16QAM	1	0	21.40	21.84	21.78
			1	49	21.75	21.83	21.79
			1	99	21.06	21.70	21.48
			50	0	20.34	20.35	20.35
			50	24	20.41	20.45	20.41
			50	49	20.56	20.96	20.52
			100	0	20.34	20.31	20.31

LTE Band	Bandwidth (MHz)	Modulation	RB Size	RB Offset	Average Power (dBm)		
					20407	20525	20643
					824.7MHz	836.5MHz	848.3MHz
5	1.4	QPSK	1	0	23.45	23.00	22.34
			1	2	23.41	23.13	22.58
			1	5	23.36	23.14	22.25
			3	0	22.57	21.85	22.45
			3	1	22.52	21.95	22.53
			3	2	22.37	22.14	22.34
		16QAM	6	0	22.18	22.12	21.43
			1	0	22.85	22.12	21.40
			1	2	22.51	22.35	21.56
			1	5	22.43	22.08	21.43
			3	0	22.60	22.13	21.53
			3	1	22.67	22.23	21.44
			3	2	22.42	22.06	21.50
			6	0	21.62	20.85	20.47
LTE Band	Bandwidth (MHz)	Modulation	RB Size	RB Offset	Average Power (dBm)		
					20415	20525	20635
					825.5MHz	836.5MHz	847.50MHz
5	3	QPSK	1	0	23.45	23.01	22.51
			1	7	23.42	23.14	22.45
			1	14	23.35	22.89	22.34
			8	0	22.52	22.07	21.50
			8	4	22.55	22.03	21.58
			8	7	22.38	22.05	21.53
		16QAM	15	0	22.48	22.01	21.39
			1	0	22.41	22.15	21.69
			1	7	22.35	22.11	21.75
			1	14	22.34	22.07	21.78
			8	0	21.34	21.05	20.45
			8	4	21.42	20.96	20.35
			8	7	21.39	20.94	20.44
			15	0	21.40	20.95	20.43
LTE Band	Bandwidth (MHz)	Modulation	RB Size	RB Offset	Average Power (dBm)		
					20425	20525	20625
					826.5MHz	836.5MHz	846.5MHz
5	5	QPSK	1	0	23.45	22.98	22.40
			1	12	23.41	22.52	22.45
			1	24	23.17	22.46	22.13
			12	0	22.48	22.01	21.63
			12	6	22.45	22.12	21.45
			12	11	22.38	21.90	21.40
		16QAM	25	0	22.45	22.13	21.58
			1	0	22.41	21.88	21.45
			1	12	22.53	21.91	21.57
			1	24	22.33	21.96	21.26
			12	0	21.39	21.20	20.63
			12	6	21.37	21.11	20.58
			12	11	21.39	21.96	20.47
			25	0	21.40	21.01	20.54

LTE Band	Bandwidth (MHz)	Modulation	RB Size	RB Offset	Average Power (dBm)		
					20450	20525	20600
					829.0MHz	836.5MHz	844.0MHz
5	10	QPSK	1	0	23.41	23.14	22.78
			1	24	23.41	23.05	22.65
			1	49	23.15	22.67	22.39
			25	0	22.52	22.29	21.84
			25	12	22.41	22.08	21.74
			25	24	22.31	22.18	21.66
			50	0	22.47	22.05	21.70
		16QAM	1	0	22.65	22.63	21.92
			1	24	22.87	22.24	21.85
			1	49	22.54	21.20	21.41
			25	0	21.53	21.17	20.86
			25	12	21.48	21.93	20.68
			25	24	21.27	20.87	20.72
			50	0	21.46	21.08	20.61

LTE Band	Bandwidth (MHz)	Modulation	RB Size	RB Offset	Average Power (dBm)		
					20775	21100	21425
					2502.5MHz	2535.0MHz	2567.5MHz
7	5	QPSK	1	0	20.95	21.12	21.45
			1	12	21.13	21.12	21.53
			1	24	21.10	21.32	21.45
			12	0	20.12	20.40	20.65
			12	6	20.13	20.30	20.58
			12	11	20.15	20.35	20.53
			25	0	20.14	20.21	20.64
		16QAM	1	0	20.15	20.40	20.55
			1	12	20.36	20.35	20.70
			1	24	20.44	20.39	20.45
			12	0	21.12	21.11	21.10
			12	6	21.22	21.16	21.03
			12	11	20.89	20.84	20.46
			25	0	20.49	20.44	20.58

LTE Band	Bandwidth (MHz)	Modulation	RB Size	RB Offset	Average Power (dBm)		
					20800	21100	21400
					2505.0MHz	2535.0MHz	2565.0MHz
7	10	QPSK	1	0	21.02	21.12	21.56
			1	24	21.35	21.33	21.78
			1	49	21.14	21.73	21.65
			25	0	20.34	20.48	20.75
			25	12	20.45	20.44	20.85
			25	24	20.39	20.45	20.89
			50	0	20.37	20.39	20.72
		16QAM	1	0	20.14	20.12	20.87
			1	24	20.24	20.29	20.98
			1	49	20.61	20.40	20.53
			25	0	21.45	21.14	21.10
			25	12	21.16	21.25	21.13
			25	24	20.69	20.66	20.65
			50	0	20.35	20.64	20.41

LTE Band	Bandwidth (MHz)	Modulation	RB Size	RB Offset	Average Power (dBm)		
					20825	21100	21375
					2507.5MHz	2535.0MHz	2562.5MHz
7	15	QPSK	1	0	21.15	21.08	21.54
			1	37	21.35	21.12	21.53
			1	74	21.21	21.41	21.63
			36	0	20.25	20.35	20.78
			36	16	20.24	20.33	20.63
			36	35	20.17	20.54	20.70
			75	0	20.21	20.41	20.69
		16QAM	1	0	19.75	20.21	20.45
			1	37	20.54	20.13	20.46
			1	74	20.73	20.31	20.45
			36	0	21.15	21.22	21.03
			36	16	21.11	21.13	21.20
			36	35	20.58	20.45	20.41
			75	0	20.69	20.63	20.65
LTE Band	Bandwidth (MHz)	Modulation	RB Size	RB Offset	Average Power (dBm)		
					20850	21100	21350
					2510.0MHz	2535.0MHz	2560.0MHz
7	20	QPSK	1	0	21.74	21.78	21.52
			1	49	21.42	21.34	21.47
			1	99	20.98	21.12	20.35
			50	0	20.45	20.31	20.82
			50	24	20.49	20.42	20.72
			50	49	20.31	20.58	20.66
			100	0	20.43	20.36	20.81
		16QAM	1	0	20.66	20.42	20.83
			1	49	20.34	20.75	20.81
			1	99	20.51	20.33	20.85
			50	0	21.15	21.22	21.10
			50	24	20.59	20.66	20.58
			50	49	20.43	20.44	20.47
			100	0	20.93	20.55	20.44

LTE Band	Bandwidth (MHz)	Modulation	RB Size	RB Offset	Average Power (dBm)		
					23017	23095	23173
					699.7MHz	707.5MHz	715.3MHz
12	1.4	QPSK	1	0	22.63	22.69	23.14
			1	2	22.75	22.78	23.25
			1	5	22.64	22.58	23.16
			3	0	21.71	21.47	21.19
			3	1	21.65	21.69	21.20
			3	2	21.74	21.81	21.22
			6	0	21.87	21.77	21.31
		16QAM	1	0	21.39	21.86	21.85
			1	2	21.65	21.64	22.05
			1	5	21.67	21.73	21.90
			3	0	21.57	21.63	22.14
			3	1	21.72	21.89	22.03
			3	2	21.63	21.57	21.90
			6	0	20.75	21.69	21.04
LTE Band	Bandwidth (MHz)	Modulation	RB Size	RB Offset	Average Power (dBm)		
					23025	23095	23165
					700.5MHz	707.5MHz	714.5MHz
12	3	QPSK	1	0	22.15	22.45	23.15
			1	7	22.21	22.14	23.23
			1	14	22.34	22.56	23.21
			8	0	21.12	21.66	22.14
			8	4	21.31	21.66	22.23
			8	7	21.29	21.85	22.14
			15	0	21.22	21.71	22.19
		16QAM	1	0	21.23	21.57	21.84
			1	7	21.22	21.79	21.96
			1	14	21.25	21.80	22.05
			8	0	20.47	20.78	20.95
			8	4	20.35	20.69	21.13
			8	7	20.31	20.78	20.96
			15	0	20.30	20.75	20.95
LTE Band	Bandwidth (MHz)	Modulation	RB Size	RB Offset	Average Power (dBm)		
					23035	23095	23155
					701.5MHz	707.5MHz	713.5MHz
12	5	QPSK	1	0	22.14	22.39	22.78
			1	12	22.35	22.64	22.90
			1	24	22.14	22.68	23.13
			12	0	21.05	21.70	21.85
			12	6	21.31	21.75	21.17
			12	11	21.35	21.72	21.95
			25	0	21.28	21.82	21.98
		16QAM	1	0	21.00	21.13	21.89
			1	12	21.34	21.56	21.45
			1	24	21.37	21.69	21.89
			12	0	20.34	20.86	21.00
			12	6	20.56	20.66	21.21
			12	11	20.44	20.77	21.03
			25	0	20.37	20.87	20.95

LTE Band	Bandwidth (MHz)	Modulation	RB Size	RB Offset	Average Power (dBm)		
					23060	23095	23130
					704.0MHz	707.5MHz	711.0MHz
12	10	QPSK	1	0	22.54	22.15	22.15
			1	24	22.45	22.74	22.57
			1	49	22.56	22.56	22.63
			25	0	21.80	22.12	21.43
			25	12	21.44	21.22	21.58
			25	24	21.43	21.45	21.61
			50	0	21.29	21.45	21.53
		16QAM	1	0	21.57	20.96	21.05
			1	24	21.51	21.05	21.47
			1	49	21.76	21.30	21.59
			25	0	20.53	20.39	20.43
			25	12	20.35	20.31	20.48
			25	24	20.39	20.44	20.65
			50	0	20.34	20.33	20.58

LTE Band	Bandwidth (MHz)	Modulation	RB Size	RB Offset	Average Power (dBm)		
					23755	23790	23825
					706.5MHz	710.0MHz	713.5MHz
17	5	QPSK	1	0	22.94	22.75	22.65
			1	12	22.92	22.69	22.89
			1	24	22.78	22.78	22.95
			12	0	22.18	21.88	21.70
			12	6	22.10	21.74	21.97
			12	11	22.16	21.85	21.89
			25	0	22.17	22.01	21.95
		16QAM	1	0	21.95	21.72	21.74
			1	12	21.88	21.85	21.92
			1	24	21.52	21.80	21.95
			12	0	21.12	20.87	20.75
			12	6	20.99	20.82	20.95
			12	11	20.88	20.91	20.89
			25	0	20.95	20.99	20.87

LTE Band	Bandwidth (MHz)	Modulation	RB Size	RB Offset	Average Power (dBm)		
					23780	23790	23800
					709.0MHz	710.0MHz	711.0MHz
17	10	QPSK	1	0	22.89	22.78	22.65
			1	24	22.78	22.75	22.85
			1	49	22.45	22.63	22.74
			25	0	22.05	21.89	21.87
			25	12	21.94	21.86	21.95
			25	24	21.94	21.82	21.87
			50	0	21.88	21.92	21.97
		16QAM	1	0	21.95	21.68	21.57
			1	24	21.78	21.63	21.80
			1	49	21.49	21.80	21.80
			25	0	20.89	20.78	21.03
			25	12	20.91	20.77	20.90
			25	24	20.81	20.83	21.05
			50	0	20.93	20.92	21.03

6.2 Peak-to-Average Ratio

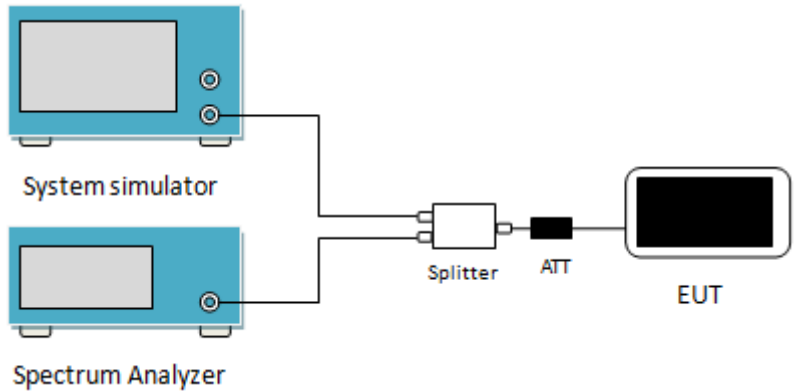
Test Requirement:	Part 24.232 (d), Part 27.50(d)(5)
Test Method:	ANSI/TIA-603-D 2010
Limit:	The peak-to-average ratio (PAR) of the transmission may not exceed 13 dB.
Test Setup:	 <p>The diagram shows a test setup for measuring Peak-to-Average Ratio (PAR). It consists of a System simulator and a Spectrum Analyzer connected to a Splitter. The Splitter is connected to an ATT (Attenuator) and an EUT (Equipment Under Test).</p>
Test Procedure:	<ol style="list-style-type: none"> 1 The RF output of the transceiver was connected to a spectrum analyzer through appropriate attenuation. 2 Set the CCDF option in spectrum analyzer, $RBW \geq OBW$, 3 Set the EUT working in highest power level, measured and recorded the 0.1% as PAPR level. 4 Repeat step 1~3 at other frequency and modulations.
Test Instruments:	Refer to section 5.9 for details
Test mode:	Refer to section 5.3 for details
Test results:	Passed

Measurement Data (Worst case):

Bandwidth	Modulation	RB Size	RB Offset	PAPR
LTE Band 2 (Middle Channel)				
20MHz	QPSK	100	0	5.04
	16QAM	100	0	5.94
LTE Band 4 (Middle Channel)				
20MHz	QPSK	100	0	4.72
	16QAM	100	0	5.57
LTE Band 5 (Middle Channel)				
10MHz	QPSK	50	0	5.19
	16QAM	50	0	6.09
LTE Band 7 (Middle Channel)				
20MHz	QPSK	100	0	4.52
	16QAM	100	0	5.48
LTE Band 12 (Middle Channel)				
10MHz	QPSK	50	0	4.58
	16QAM	50	0	5.45
LTE Band 17 (Middle Channel)				
10MHz	QPSK	50	0	4.32
	16QAM	50	0	5.54

Test plots as below:

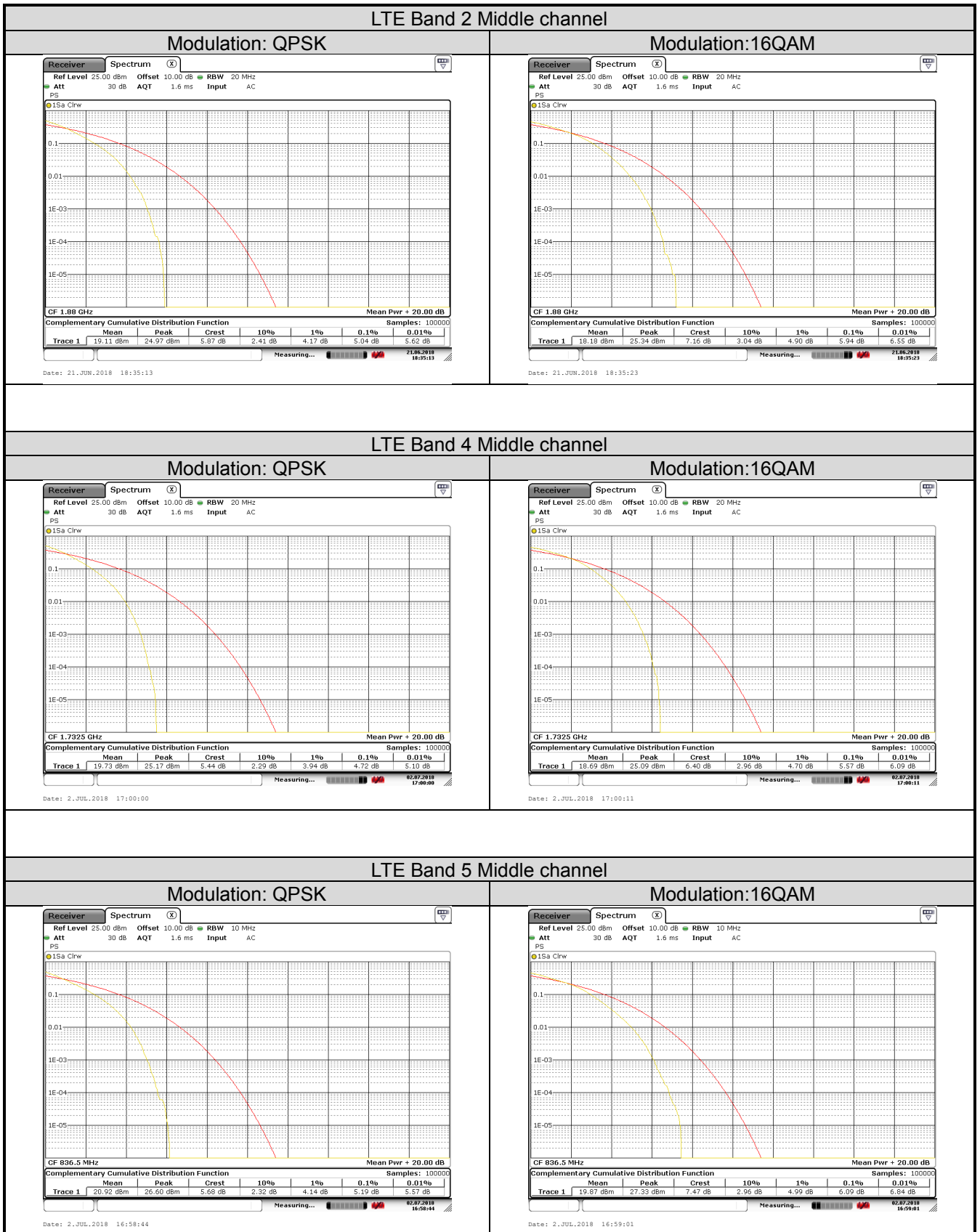

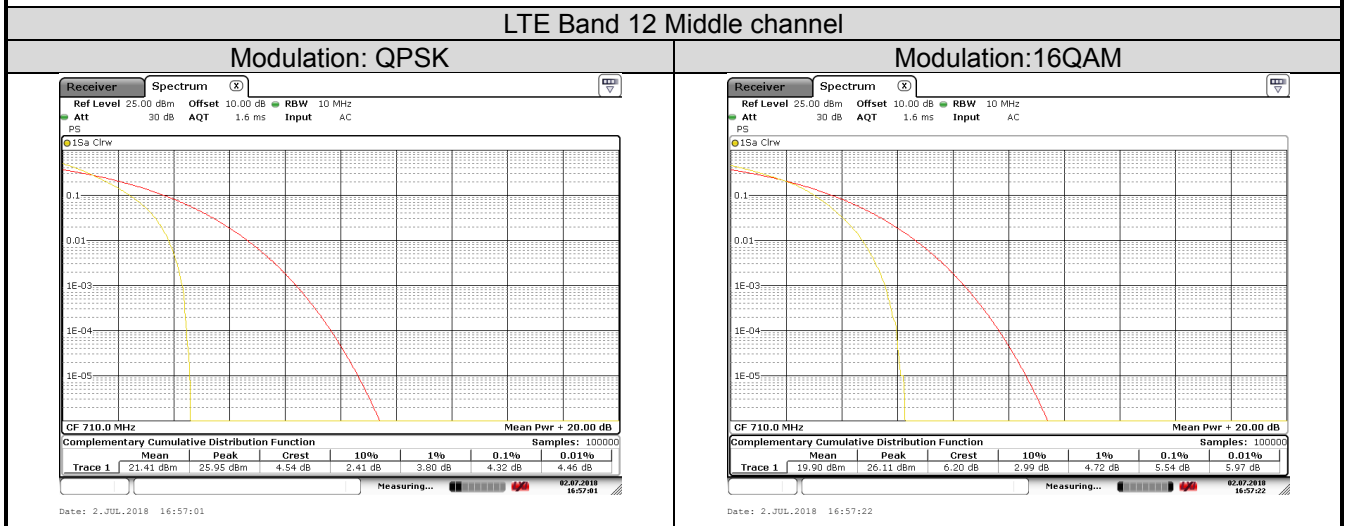
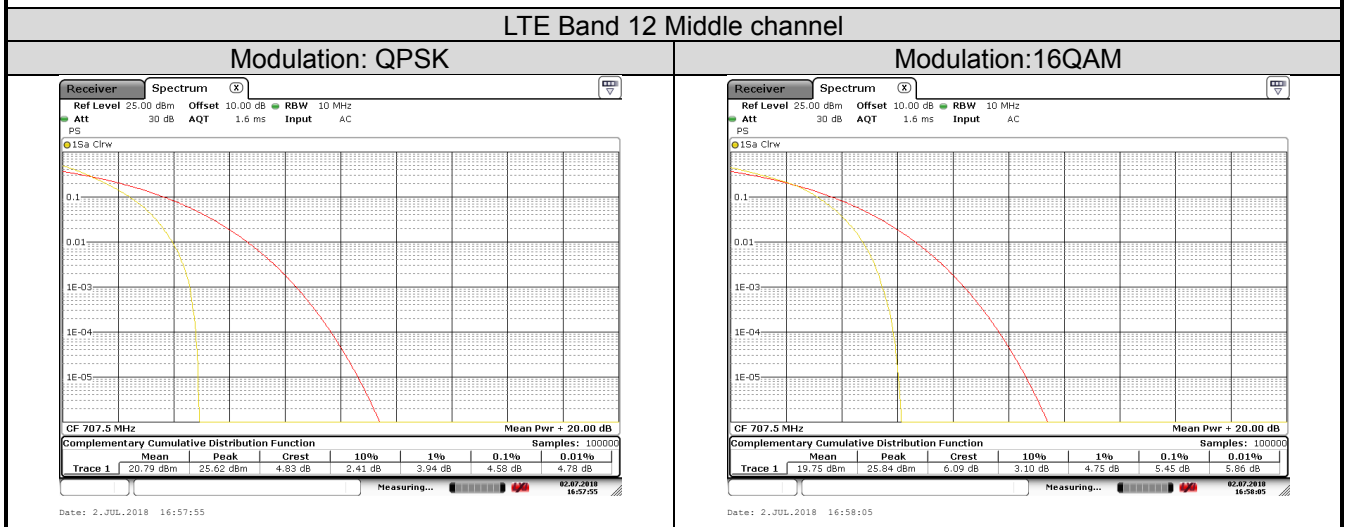
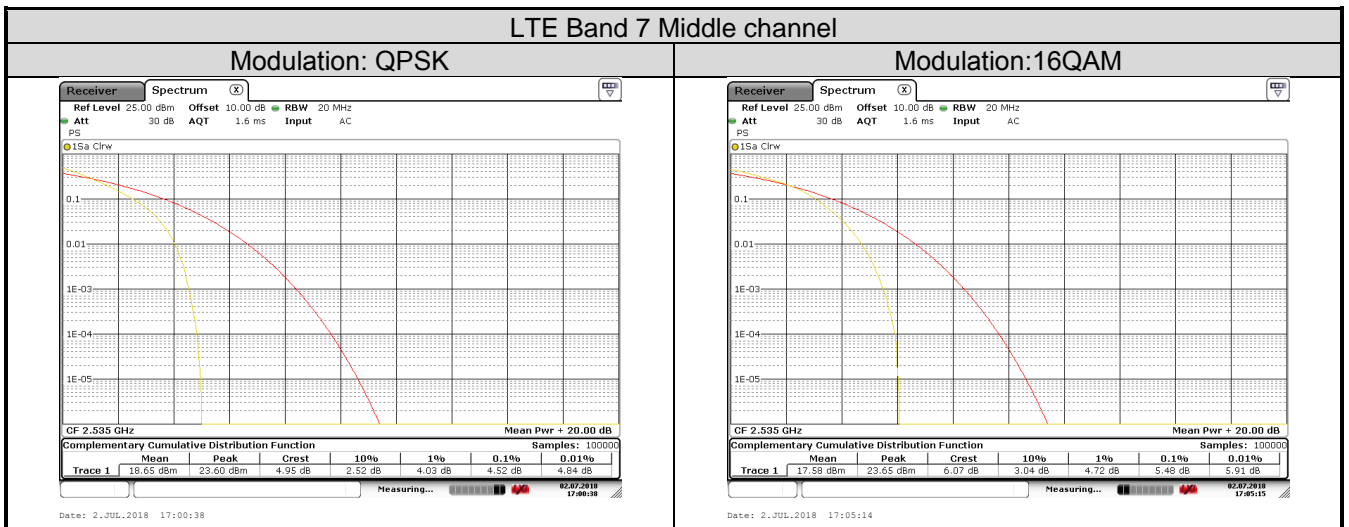

6.3 Occupy Bandwidth

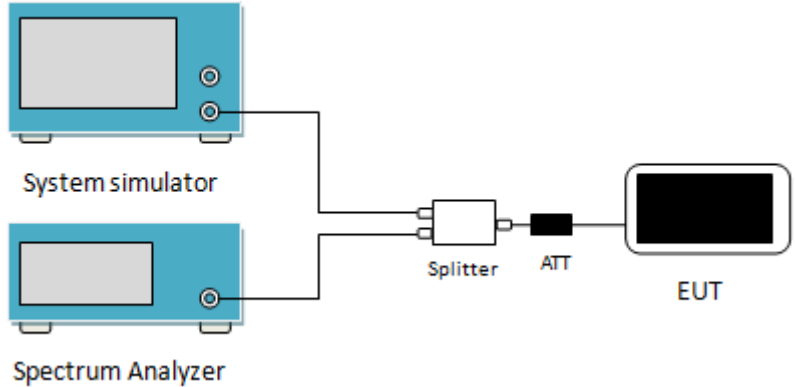
Test Requirement:	Part 22.917(b), Part 24.238(b), Part 27.53(g), Part 27.53(h), Part 27.53(m)
Test Method:	ANSI/TIA-603-D 2010
Test Setup:	 <p>The diagram shows a test setup. On the left, there are two blue rectangular devices: the top one is labeled 'System simulator' and the bottom one is labeled 'Spectrum Analyzer'. Both have a screen and two circular ports on the right side. A single cable connects the top port of the System simulator to the top port of the Spectrum Analyzer. From the bottom port of the System simulator, a cable goes to the left input of a white rectangular 'Splitter'. From the bottom port of the Spectrum Analyzer, a cable goes to the right input of the 'Splitter'. The 'Splitter' has two outputs: one to the left and one to the right. The right output is connected to a black rectangular 'ATT' (Attenuator). The 'ATT' is connected to the left side of a white rectangular 'EUT' (Equipment Under Test) which has a black screen on its front.</p>
Test Procedure:	<ol style="list-style-type: none"> 1. The EUT's output RF connector was connected with a short cable to the spectrum analyzer 2. RBW was set to about 1% ~ 5% of emission BW, VBW= 3 times RBW. 3. -26dBc display line was placed on the screen (or 99% bandwidth), the occupied bandwidth is the delta frequency between the two points where the display line intersects the signal trace.
Test Instruments:	Refer to section 5.9 for details
Test mode:	Refer to section 5.3 for details
Test results:	Passed

Measurement Data:

LTE Band 2					
Bandwidth	Channel	Frequency (MHz)	Modulation	99% OBW (kHz)	-26dBcEBW (kHz)
1.4MHz	18607	1850.70	16QAM	1098	1278
			QPSK	1104	1278
	18900	1880.00	16QAM	1092	1248
			QPSK	1092	1290
	19193	1909.30	16QAM	1092	1290
			QPSK	1104	1296
3MHz	18615	1851.50	16QAM	2712	3835
			QPSK	2736	3000
	18900	1880.00	16QAM	2712	2964
			QPSK	2736	3000
	19185	1908.50	16QAM	2712	2964
			QPSK	2736	3000
5MHz	18625	1852.50	16QAM	4500	4980
			QPSK	4520	5100
	18900	1880.00	16QAM	4500	4960
			QPSK	4540	5140
	19175	1907.50	16QAM	4500	5020
			QPSK	4520	5080
10MHz	18650	1855.00	16QAM	9120	10120
			QPSK	9120	10560
	18900	1880.00	16QAM	9120	10320
			QPSK	9160	10400
	19150	1905.00	16QAM	9120	10120
			QPSK	9160	10440
15MHz	18675	1857.50	16QAM	13560	14880
			QPSK	13560	15120
	18900	1880.00	16QAM	13620	14700
			QPSK	13620	15060
	19125	1902.50	16QAM	13560	15000
			QPSK	13560	14940
20MHz	18700	1860.00	16QAM	17920	19280
			QPSK	18080	19760
	18900	1880.00	16QAM	18000	19440
			QPSK	18080	19680
	19100	1900.00	16QAM	18000	19600
			QPSK	18080	19840

LTE Band 4					
Bandwidth	Channel	Frequency (MHz)	Modulation	99% OBW (kHz)	-26dBcEBW (kHz)
1.4MHz	19957	1710.7	16QAM	1092	1296
			QPSK	1098	1296
	20175	1732.5	16QAM	1098	1290
			QPSK	1098	1290
	20393	1754.3	16QAM	1098	1290
			QPSK	1104	1290
3MHz	19965	1711.5	16QAM	2724	2988
			QPSK	2736	3024
	20175	1732.5	16QAM	2712	2952
			QPSK	2736	3012
	20385	1750.5	16QAM	2724	2988
			QPSK	2724	3000
5MHz	19975	1712.5	16QAM	4520	5060
			QPSK	4520	5140
	20175	1732.5	16QAM	4520	5060
			QPSK	4520	5120
	20375	1752.5	16QAM	4520	4980
			QPSK	4520	5140
10MHz	20000	1715.0	16QAM	9120	10120
			QPSK	9120	10480
	20175	1732.5	16QAM	9120	10240
			QPSK	9120	10360
	20350	1750.0	16QAM	9120	10160
			QPSK	9120	10360
15MHz	20025	1717.5	16QAM	13560	15060
			QPSK	13560	15120
	20175	1732.5	16QAM	13560	14820
			QPSK	13560	15180
	20325	1747.5	16QAM	13500	15060
			QPSK	13560	14940
20MHz	20050	1720.0	16QAM	18000	19360
			QPSK	18080	19680
	20175	1732.5	16QAM	17920	19520
			QPSK	18000	19600
	20300	1745.0	16QAM	18000	19360
			QPSK	18000	19600

TE Band 5					
Bandwidth	Channel	Frequency (MHz)	Modulation	99% OBW (kHz)	-26dBcEBW (kHz)
1.4MHz	20407	824.7	16QAM	1092	1266
			QPSK	1092	1284
	20525	836.5	16QAM	1098	1272
			QPSK	1098	1278
	20643	848.3	16QAM	1086	1284
			QPSK	1098	1284
3MHz	20415	825.5	16QAM	2724	2952
			QPSK	2736	3000
	20525	836.50	16QAM	2712	2964
			QPSK	2724	3012
	20635	847.50	16QAM	2712	2964
			QPSK	2736	3012
5MHz	20425	826.50	16QAM	4500	5020
			QPSK	4520	5060
	20525	836.50	16QAM	4500	5020
			QPSK	4520	5160
	20625	846.50	16QAM	4520	5100
			QPSK	4520	5060
10MHz	20450	829.00	16QAM	9080	10280
			QPSK	9120	10440
	20525	836.50	16QAM	9080	10240
			QPSK	9080	10520
	20600	844.00	16QAM	9120	10200
			QPSK	9120	10480

LTE Band 7					
Bandwidth	Channel	Frequency (MHz)	Modulation	99% OBW (kHz)	-26dBcEBW (kHz)
5MHz	20775	2502.5	16QAM	4500	4980
			QPSK	4500	5080
	21100	2535.0	16QAM	4500	5000
			QPSK	4520	5100
	21425	2567.5	16QAM	4520	5000
			QPSK	4540	5080
10MHz	20800	2505.0	16QAM	9120	10200
			QPSK	9080	10440
	21100	2535.0	16QAM	9120	10240
			QPSK	9160	10280
	21400	2565.0	16QAM	9120	10160
			QPSK	9120	10360
15MHz	20825	2507.5	16QAM	13500	14640
			QPSK	13560	15000
	21100	2535.0	16QAM	13560	14880
			QPSK	13500	15060
	21375	2562.5	16QAM	13500	14820
			QPSK	13620	15060
20MHz	20850	2510.0	16QAM	17920	19200
			QPSK	18080	19760
	21100	2535.0	16QAM	17920	18000
			QPSK	18000	18000
	21350	2560.0	16QAM	17920	19600
			QPSK	18080	19680

LTE Band 12					
Bandwidth	Channel	Frequency (MHz)	Modulation	99% OBW (kHz)	-26dBcEBW (kHz)
1.4MHz	23017	699.7	16QAM	1098	1278
			QPSK	1098	1284
	23095	707.5	16QAM	1098	1302
			QPSK	1104	1302
	23173	715.3	16QAM	1092	1278
			QPSK	1104	1308
3MHz	23025	700.5	16QAM	2736	2952
			QPSK	2724	2976
	23095	707.5	16QAM	2736	2964
			QPSK	2724	3012
	23165	714.5	16QAM	2724	2952
			QPSK	2724	3000
5MHz	23035	701.5	16QAM	4500	4920
			QPSK	4500	5020
	23095	707.5	16QAM	4540	4980
			QPSK	4520	5180
	23155	713.5	16QAM	4500	4920
			QPSK	4500	5040
10MHz	23060	704.0	16QAM	9040	10080
			QPSK	9120	10280
	23095	707.5	16QAM	9200	10120
			QPSK	9240	10560
	23130	711.0	16QAM	9080	10080
			QPSK	9120	10360

LTE Band 17					
Bandwidth	Channel	Frequency (MHz)	Modulation	99% OBW (kHz)	-26dBcEBW (kHz)
5MHz	23755	706.5	16QAM	4540	4860
			QPSK	4520	5160
	23790	710.0	16QAM	4500	4940
			QPSK	4540	5100
	23825	713.5	16QAM	4500	4900
			QPSK	4500	5080
10MHz	23780	709.0	16QAM	9160	10200
			QPSK	9200	10320
	23790	710.0	16QAM	9160	10200
			QPSK	9200	10480
	23130	711.0	16QAM	9120	10440
			QPSK	9120	10440

Test plot as follows:
LTE Band 2 part:

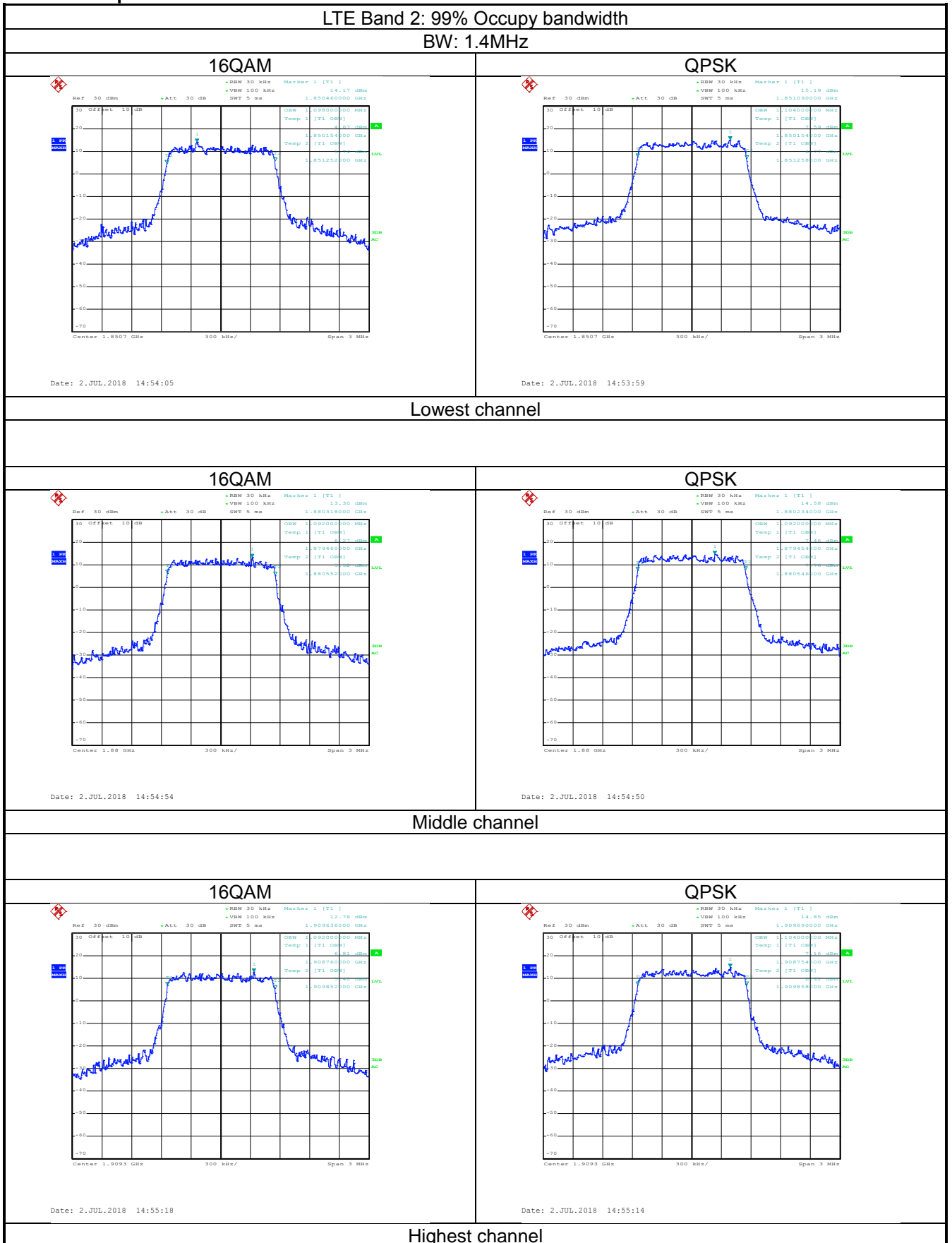

LTE Band 2: 99% Occupy bandwidth
BW: 3MHz

16QAM

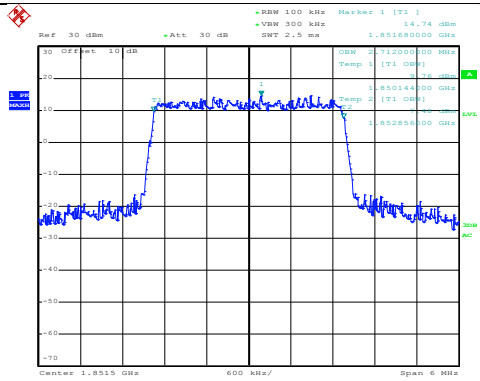

Date: 2.JUL.2018 14:56:40

QPSK

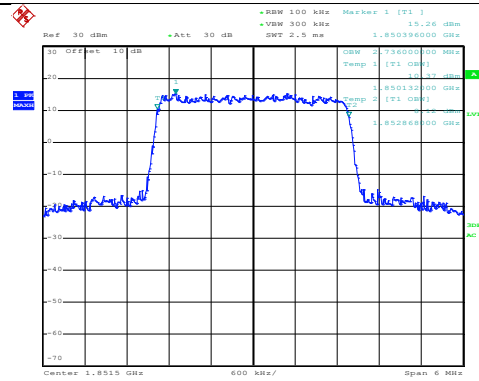

Date: 2.JUL.2018 14:56:35

Lowest channel

16QAM

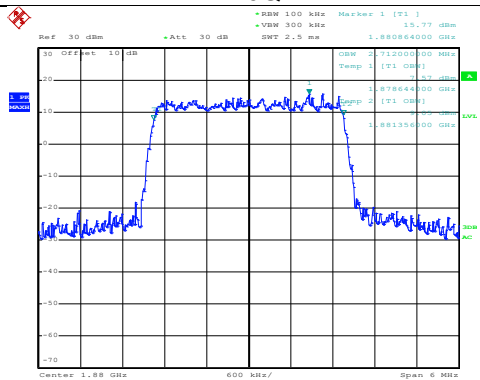

Date: 2.JUL.2018 14:57:00

QPSK

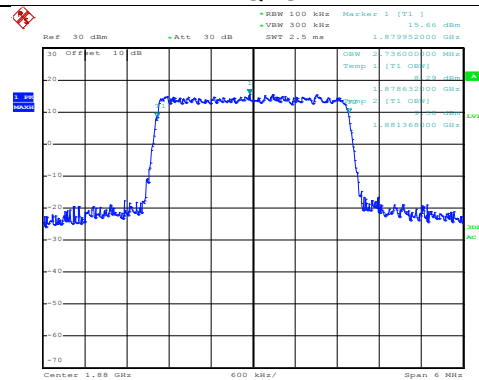

Date: 2.JUL.2018 14:56:56

Middle channel

16QAM

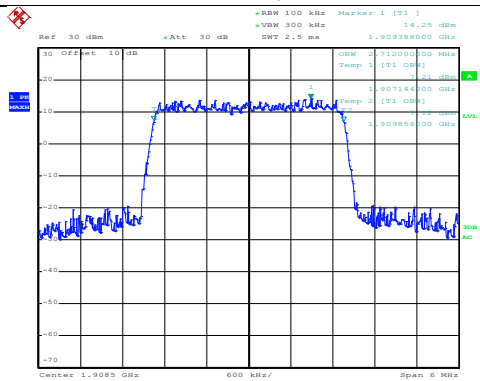

Date: 2.JUL.2018 14:57:48

QPSK

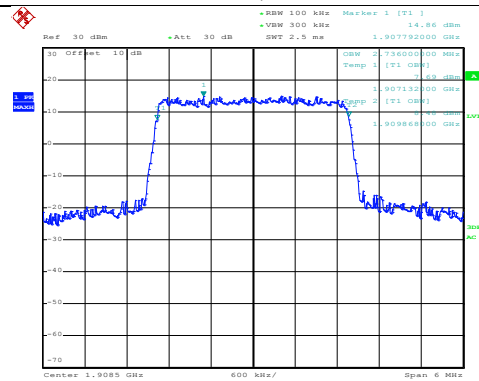

Date: 2.JUL.2018 14:57:43

Highest channel

LTE Band 2: 99% Occupancy bandwidth
BW: 5MHz

16QAM

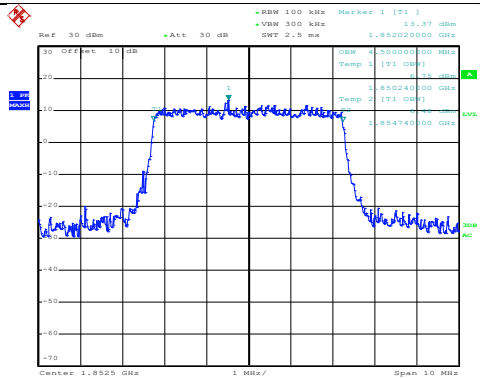

Date: 2.JUL.2018 14:58:34

QPSK

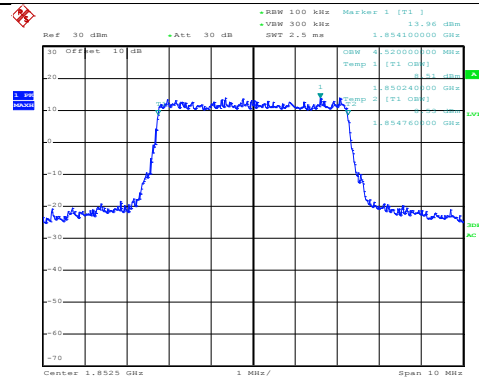

Date: 2.JUL.2018 14:58:30

Lowest channel

16QAM

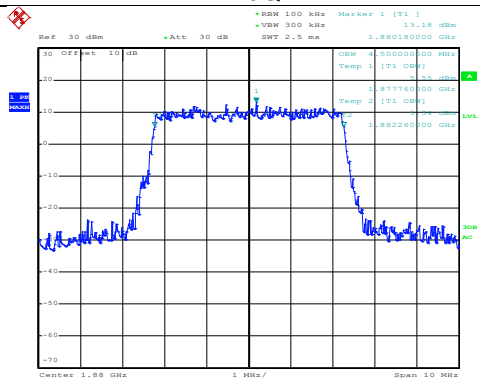

Date: 2.JUL.2018 14:59:52

QPSK

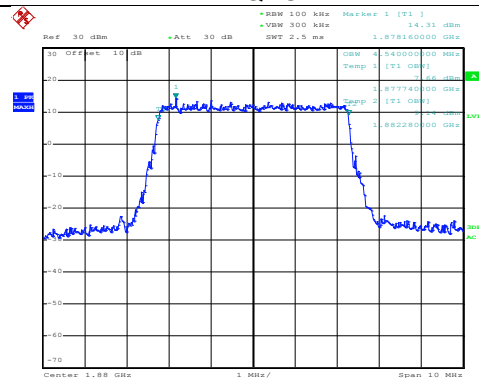

Date: 2.JUL.2018 14:59:48

Middle channel

16QAM

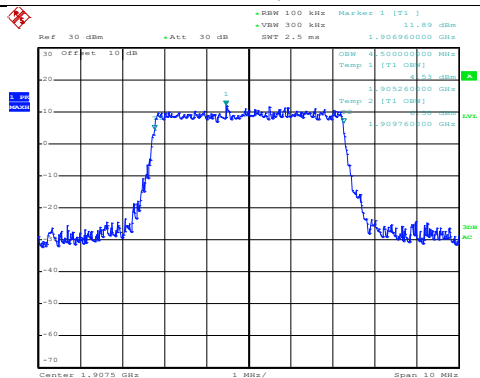

Date: 2.JUL.2018 15:00:15

QPSK

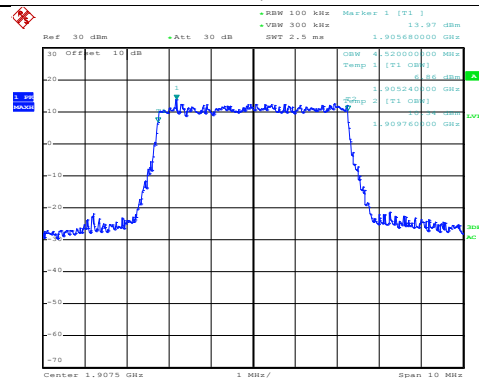

Date: 2.JUL.2018 15:00:10

Highest channel

LTE Band 2: 99% Occupy bandwidth
BW: 10MHz

16QAM

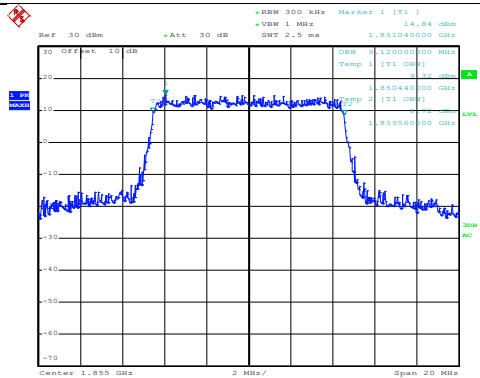

Date: 2.JUL.2018 15:08:40

QPSK

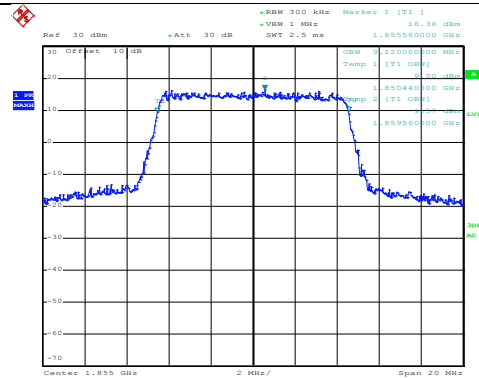

Date: 2.JUL.2018 15:08:36

Lowest channel

16QAM

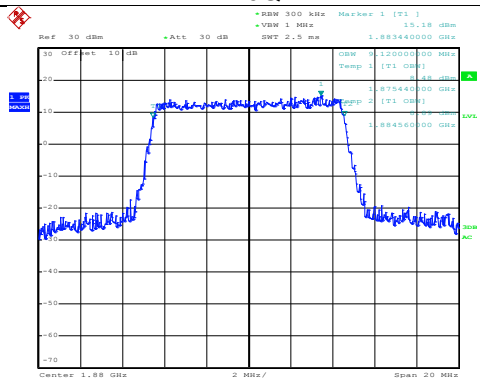

Date: 2.JUL.2018 15:09:28

QPSK

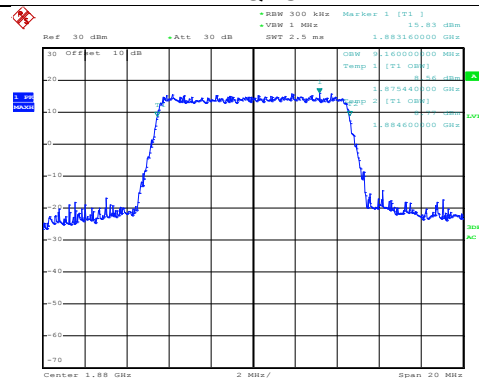

Date: 2.JUL.2018 15:09:23

Middle channel

16QAM

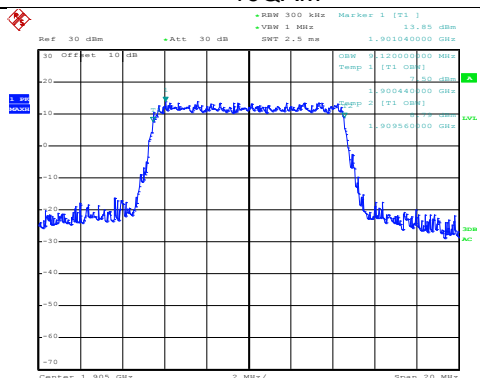

Date: 2.JUL.2018 15:09:49

QPSK

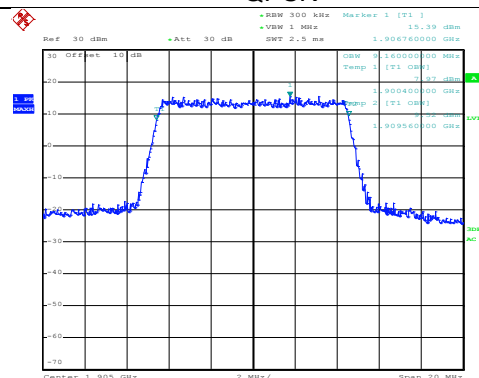

Date: 2.JUL.2018 15:09:44

Highest channel

LTE Band 2: 99% Occupy bandwidth
BW: 15MHz

16QAM

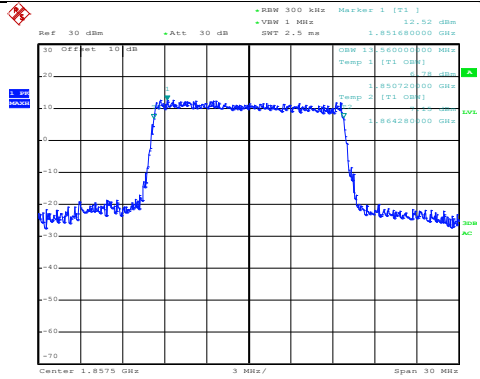

Date: 2.JUL.2018 15:11:15

QPSK

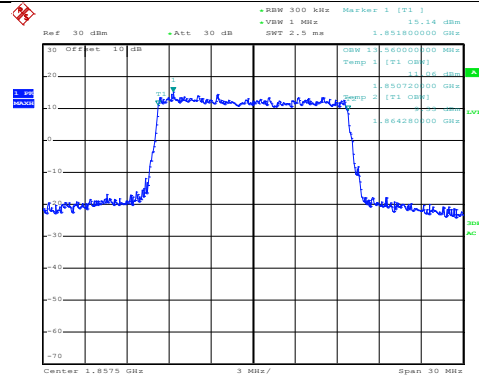

Date: 2.JUL.2018 15:11:11

Lowest channel

16QAM

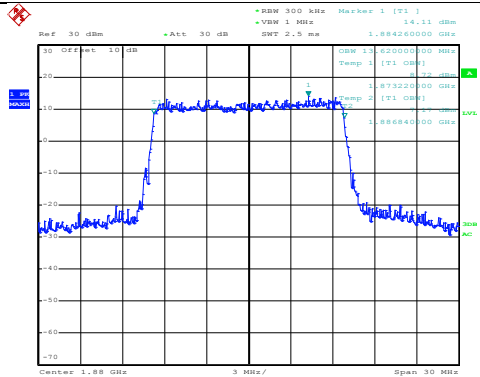

Date: 2.JUL.2018 15:32:15

QPSK

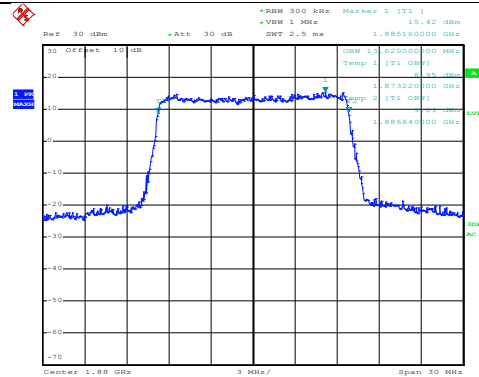

Date: 2.JUL.2018 15:32:11

Middle channel

16QAM

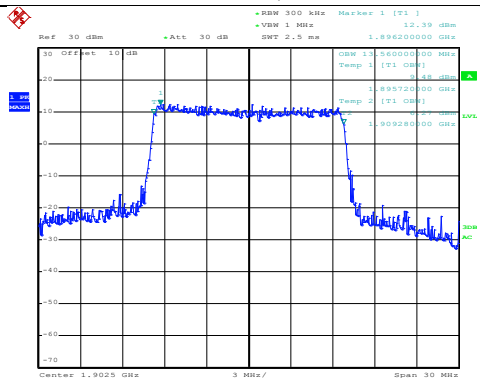

Date: 2.JUL.2018 15:33:03

QPSK

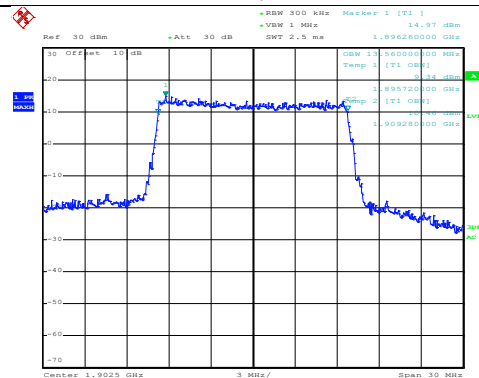

Date: 2.JUL.2018 15:32:59

Highest channel

LTE Band 2: 99% Occupy bandwidth
 BW: 20MHz

16QAM

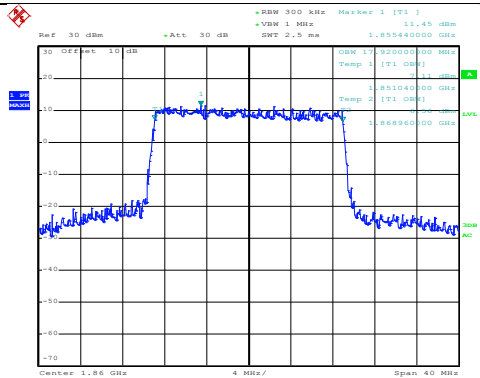

Date: 2.JUL.2018 15:33:42

QPSK

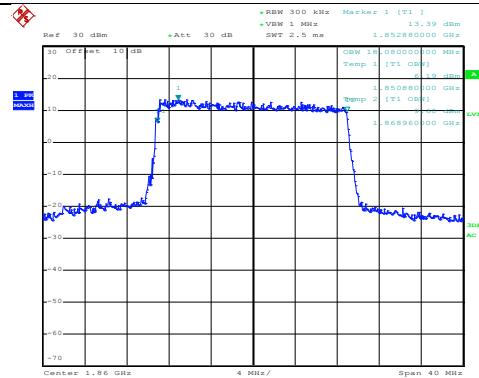

Date: 2.JUL.2018 15:33:38

Lowest channel

16QAM

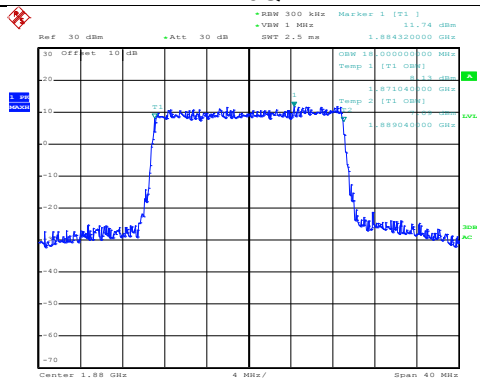

Date: 2.JUL.2018 15:34:29

QPSK

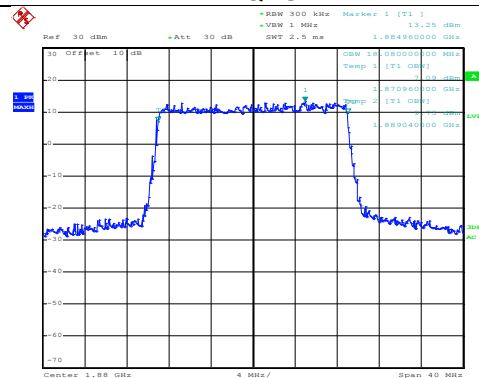

Date: 2.JUL.2018 15:34:25

Middle channel

16QAM

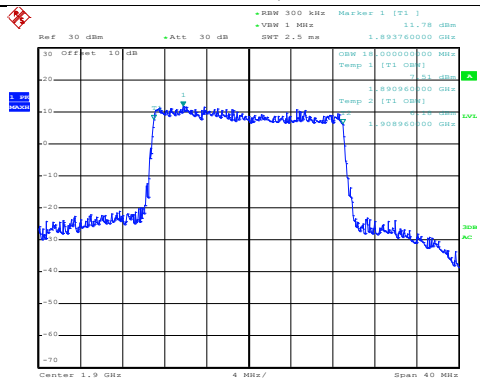

Date: 2.JUL.2018 15:34:51

QPSK

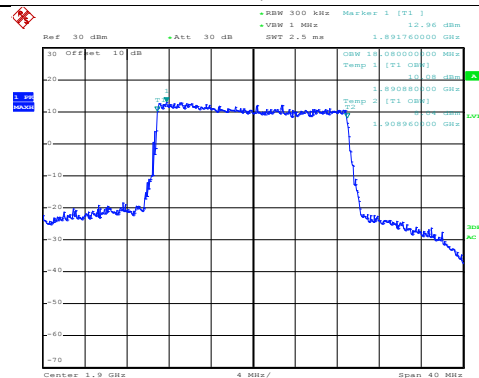

Date: 2.JUL.2018 15:34:47

Highest channel

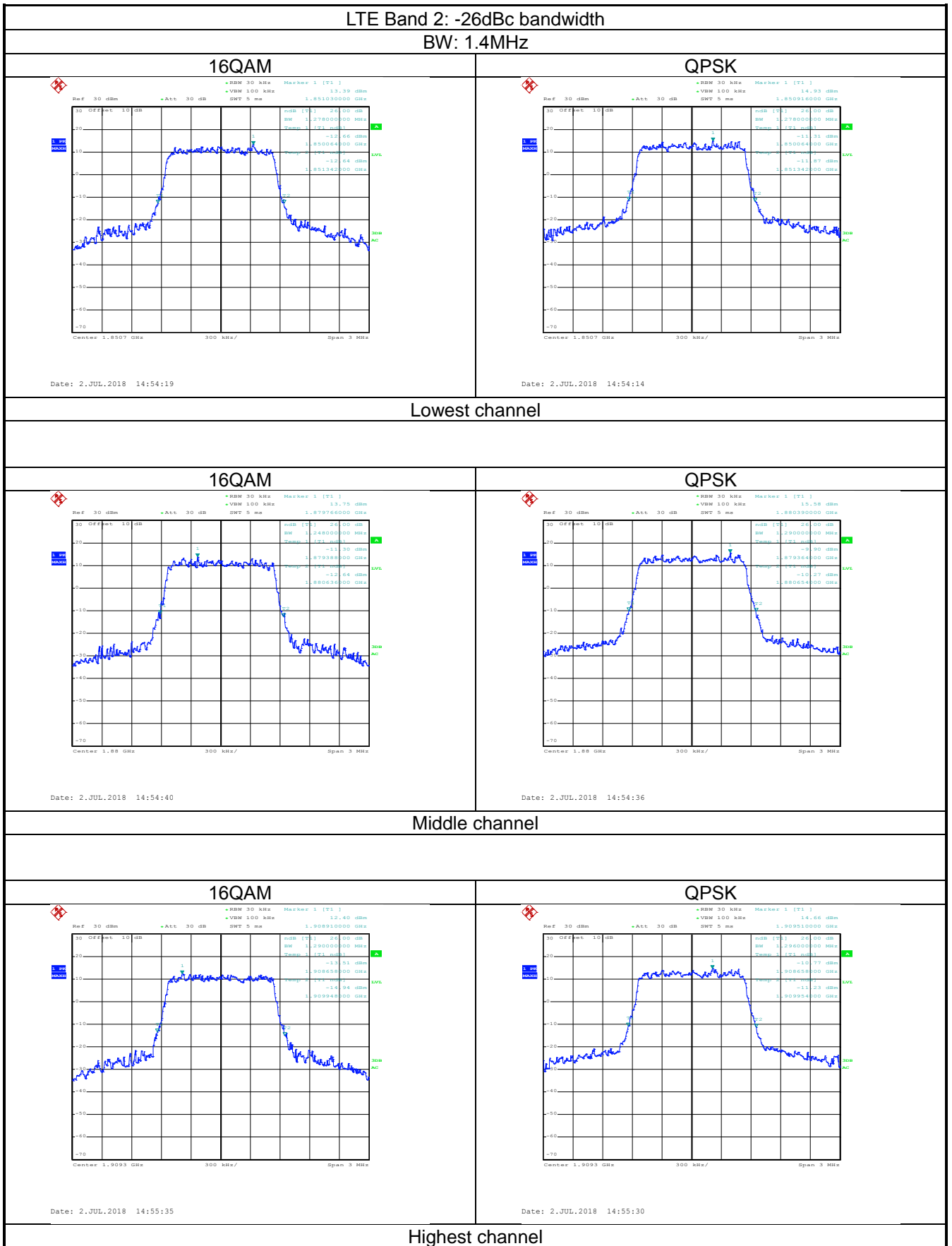

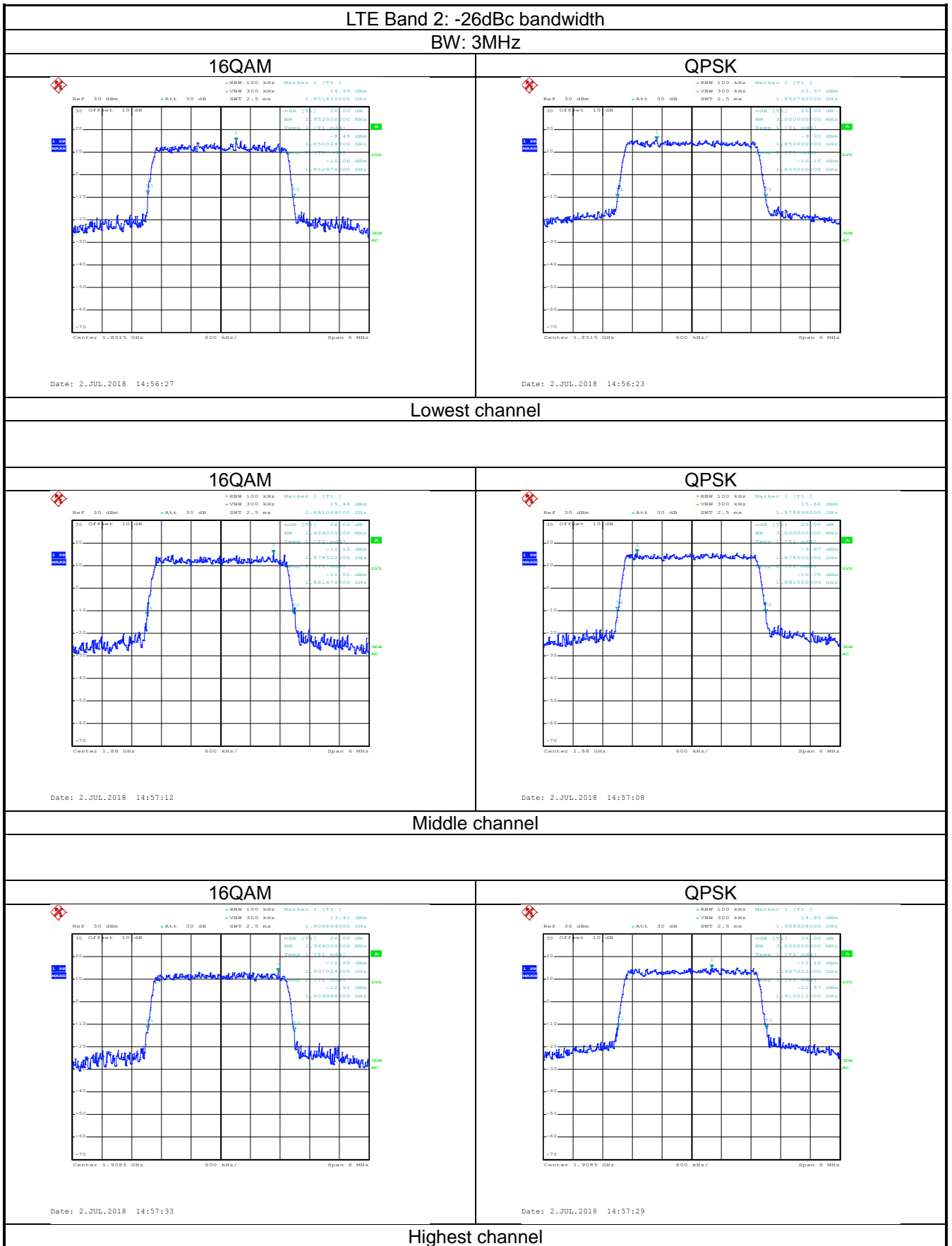

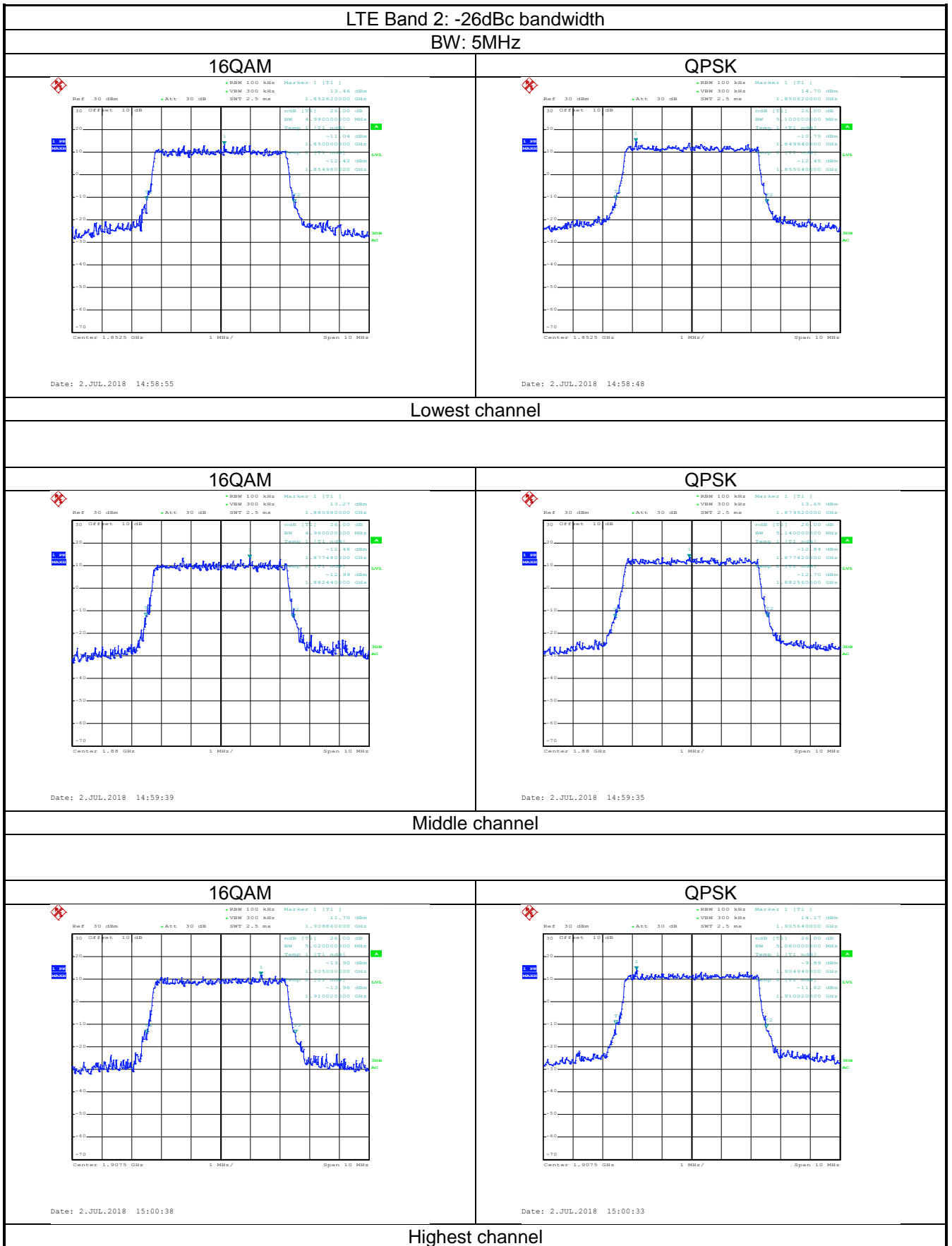

LTE Band 2: -26dBc bandwidth
BW: 10MHz

16QAM

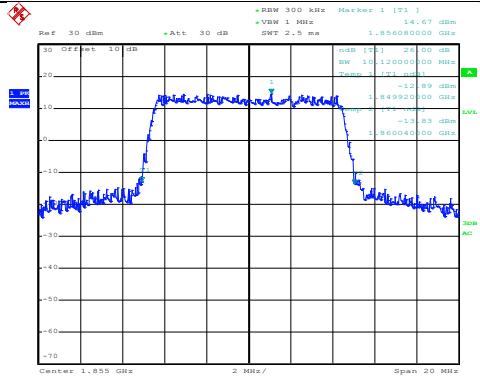

Date: 2.JUL.2018 15:08:27

QPSK

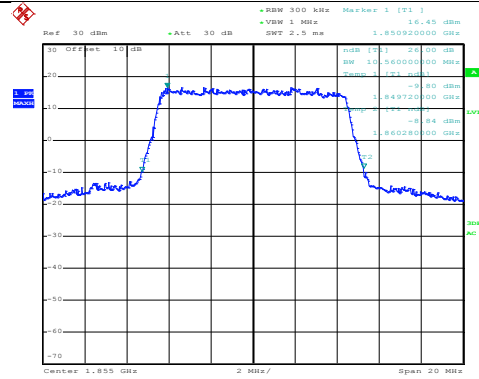

Date: 2.JUL.2018 15:08:23

Lowest channel

16QAM

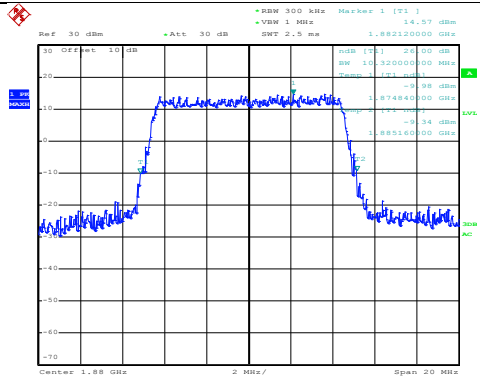

Date: 2.JUL.2018 15:09:15

QPSK

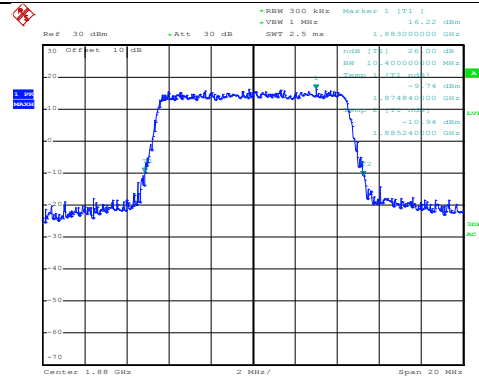

Date: 2.JUL.2018 15:09:11

Middle channel

16QAM

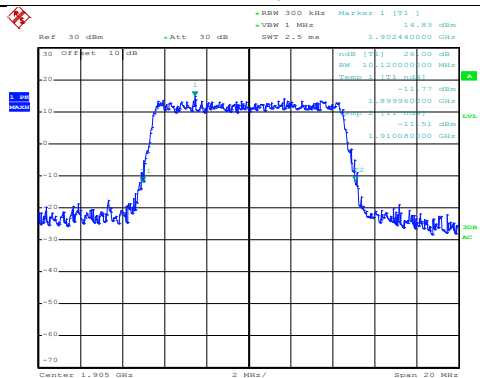

Date: 2.JUL.2018 15:10:01

QPSK

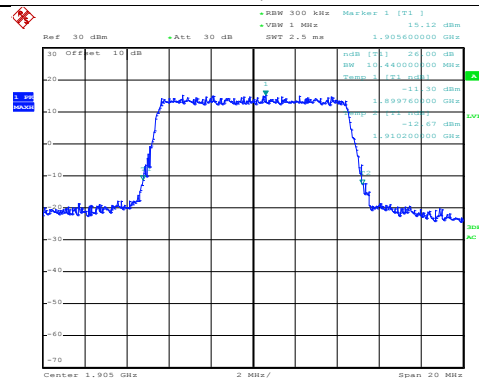

Date: 2.JUL.2018 15:09:57

Highest channel

LTE Band 2: -26dBc bandwidth
BW: 15MHz

16QAM

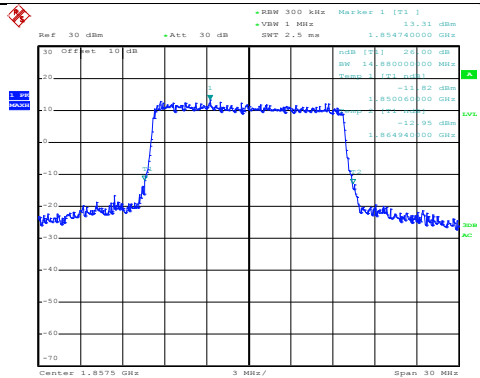

Date: 2.JUL.2018 15:11:02

QPSK

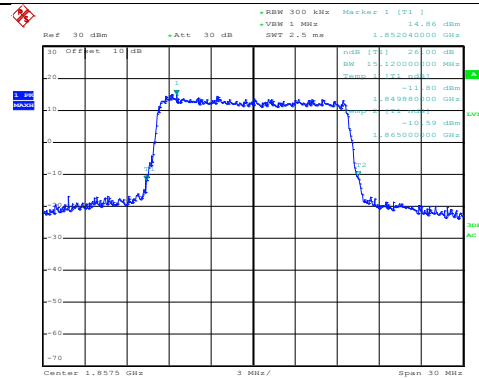

Date: 2.JUL.2018 15:10:57

Lowest channel

16QAM

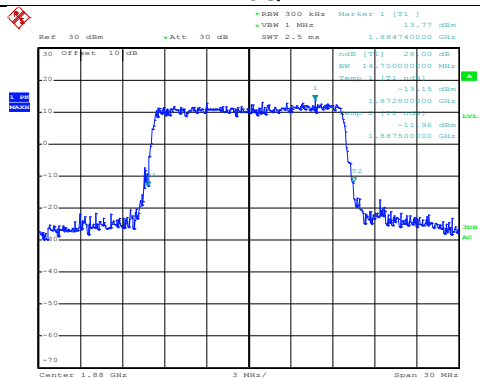

Date: 2.JUL.2018 15:32:29

QPSK

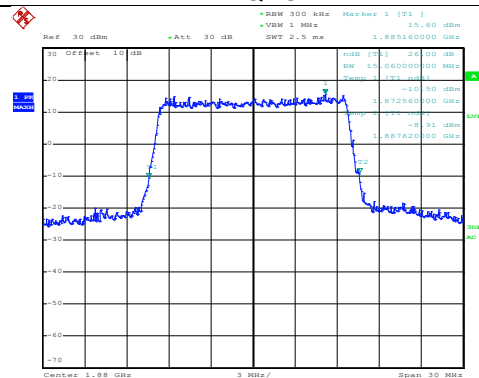

Date: 2.JUL.2018 15:32:25

Middle channel

16QAM

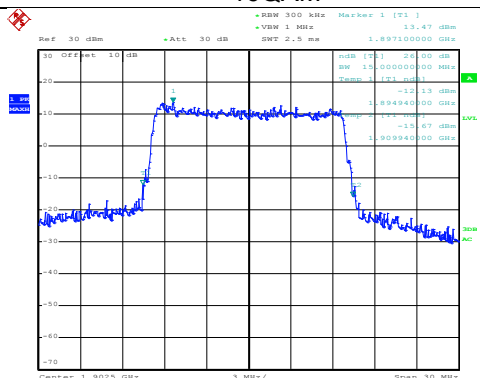

Date: 2.JUL.2018 15:32:50

QPSK

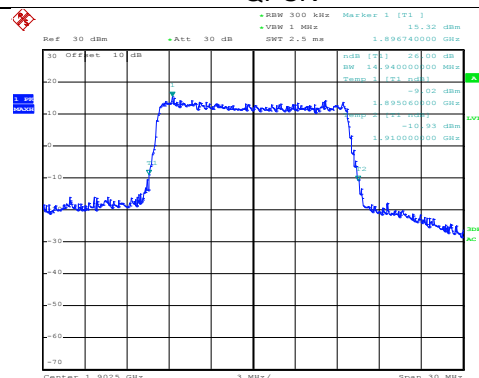

Date: 2.JUL.2018 15:32:46

Highest channel

LTE Band 2: -26dBc bandwidth
BW: 20MHz

16QAM

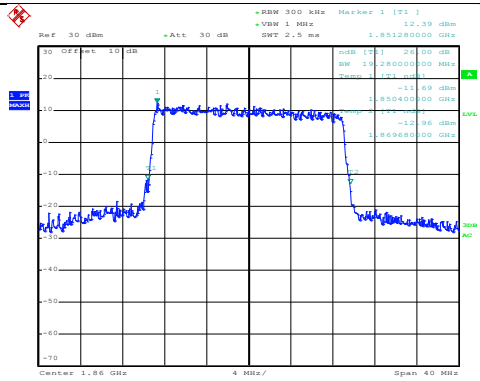

Date: 2.JUL.2018 15:33:54

QPSK

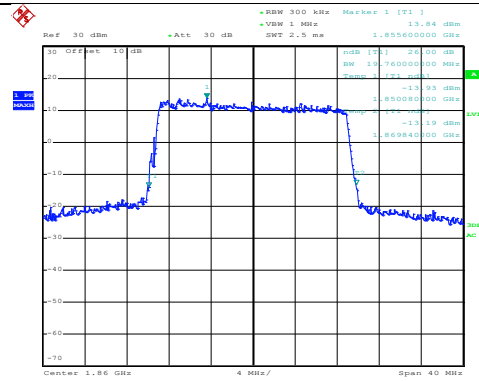

Date: 2.JUL.2018 15:33:50

Lowest channel

16QAM

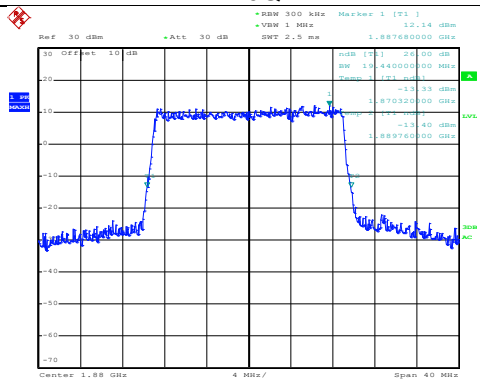

Date: 2.JUL.2018 15:34:16

QPSK

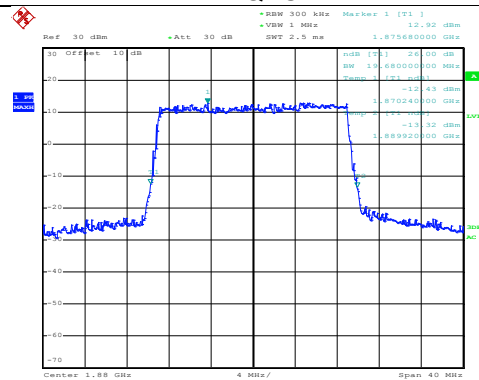

Date: 2.JUL.2018 15:34:12

Middle channel

16QAM

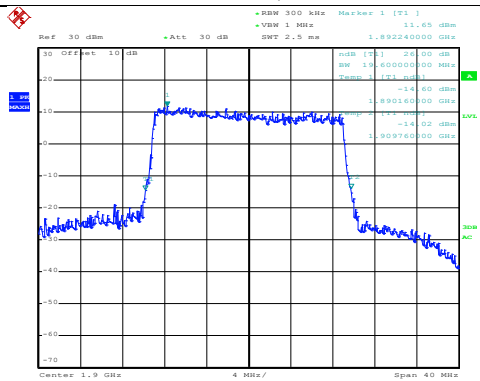

Date: 2.JUL.2018 15:35:06

QPSK

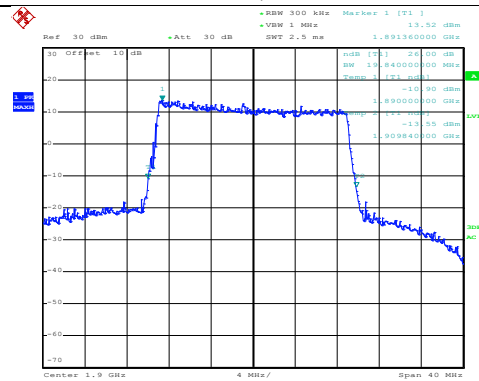

Date: 2.JUL.2018 15:35:02

Highest channel

LTE Band 4 part:

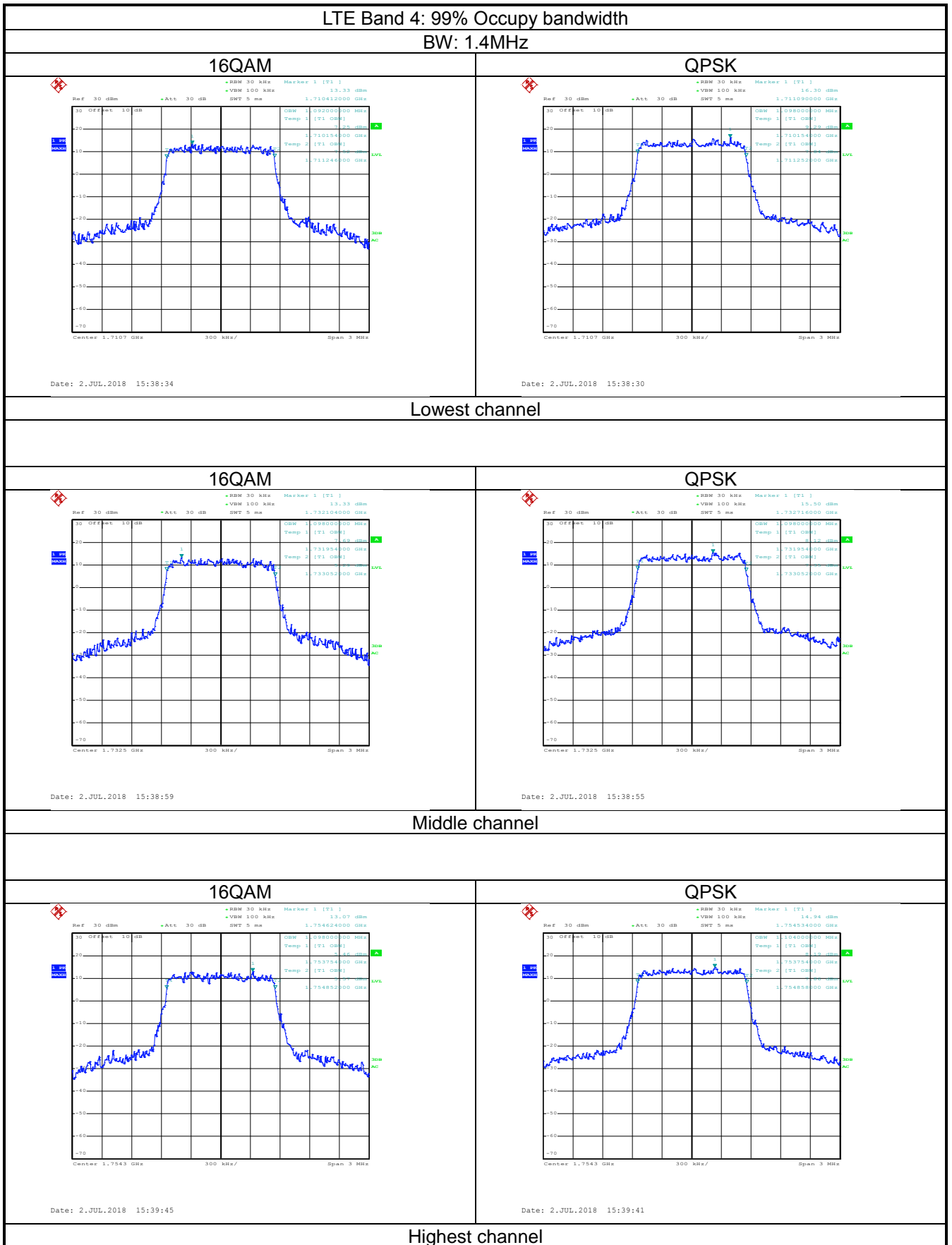

LTE Band 4: 99% Occupancy bandwidth
 BW: 3MHz

16QAM

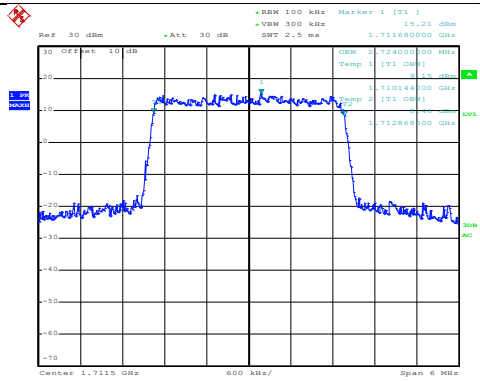

Date: 2.JUL.2018 15:43:34

QPSK

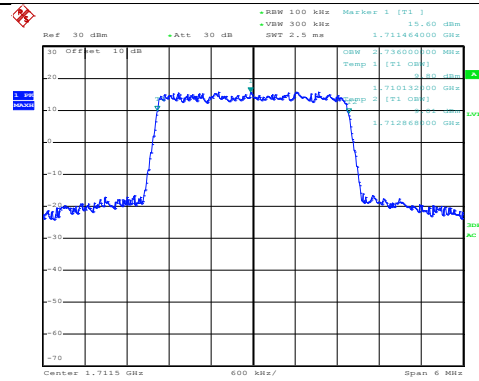

Date: 2.JUL.2018 15:43:28

Lowest channel

16QAM

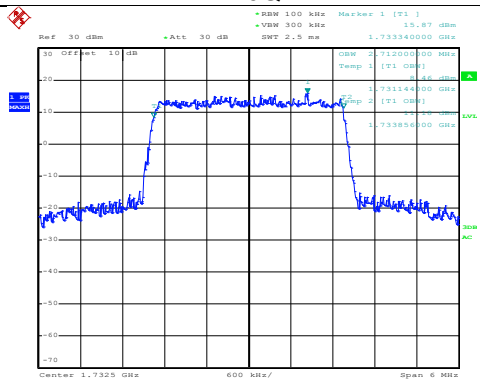

Date: 2.JUL.2018 15:44:04

QPSK

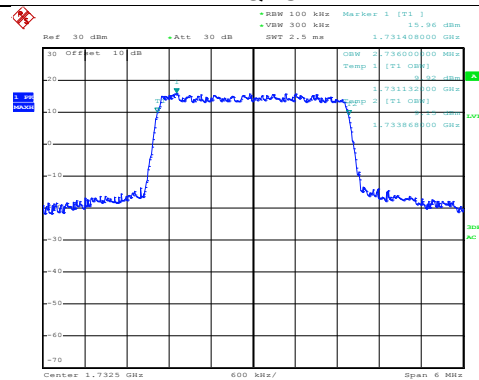

Date: 2.JUL.2018 15:43:58

Middle channel

16QAM

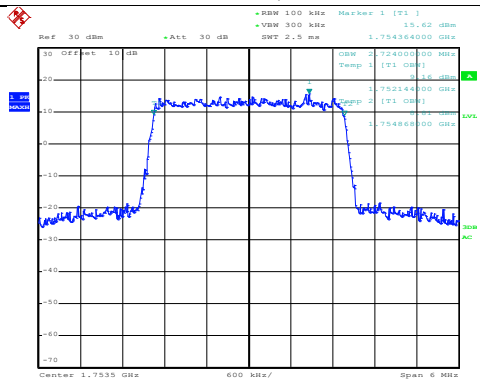

Date: 2.JUL.2018 15:44:02

QPSK

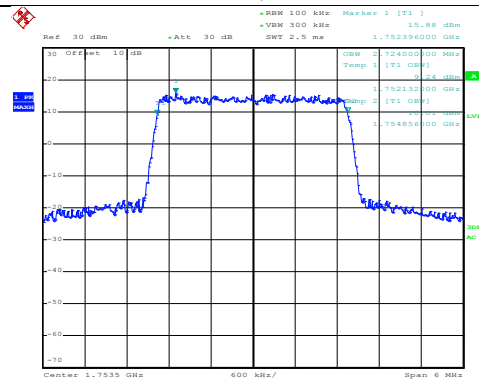

Date: 2.JUL.2018 15:44:55

Highest channel

LTE Band 4: 99% Occupy bandwidth
BW: 5MHz

16QAM

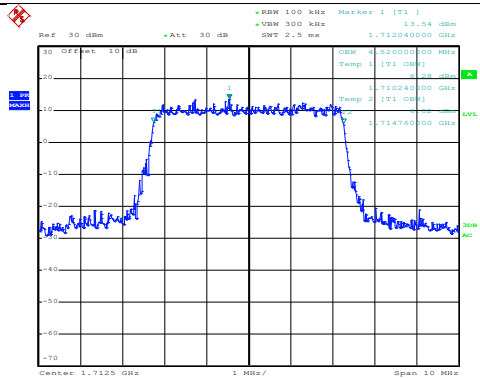

Date: 2.JUL.2018 15:46:11

QPSK

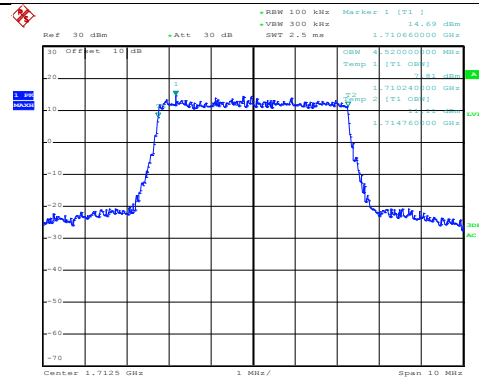

Date: 2.JUL.2018 15:46:06

Lowest channel

16QAM

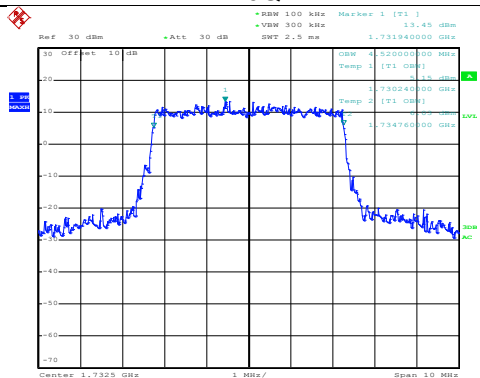

Date: 2.JUL.2018 15:47:03

QPSK

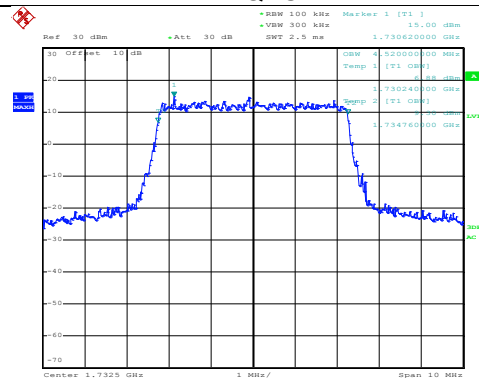

Date: 2.JUL.2018 15:46:58

Middle channel

16QAM

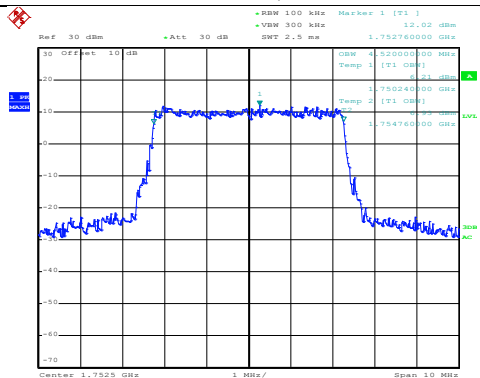

Date: 2.JUL.2018 15:47:24

QPSK

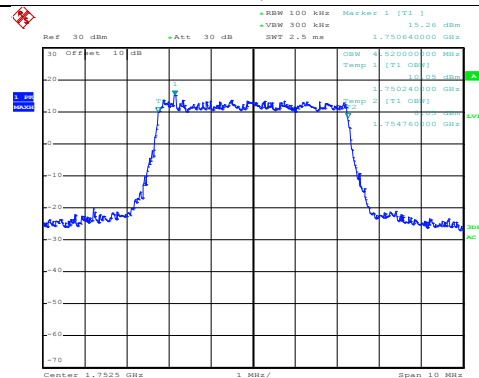

Date: 2.JUL.2018 15:47:20

Highest channel

LTE Band 4: 99% Occupy bandwidth
BW: 10MHz

16QAM

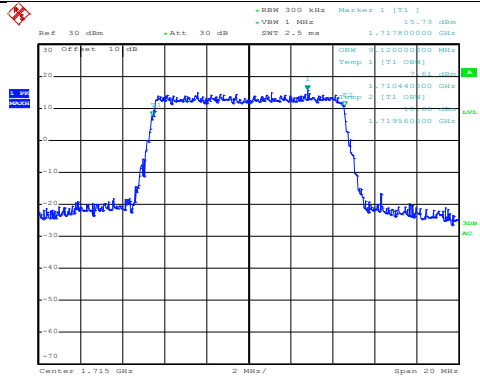

Date: 2.JUL.2018 15:48:37

QPSK

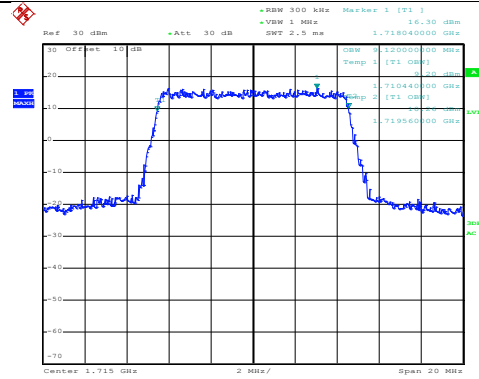

Date: 2.JUL.2018 15:48:32

Lowest channel

16QAM

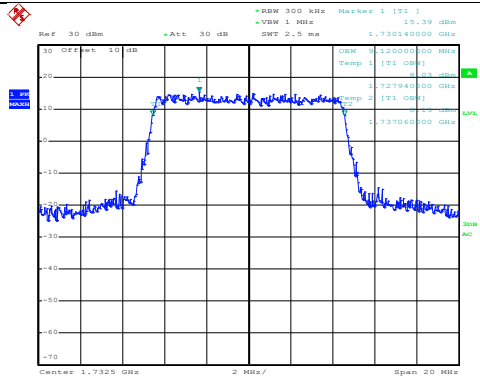

Date: 2.JUL.2018 15:48:57

QPSK

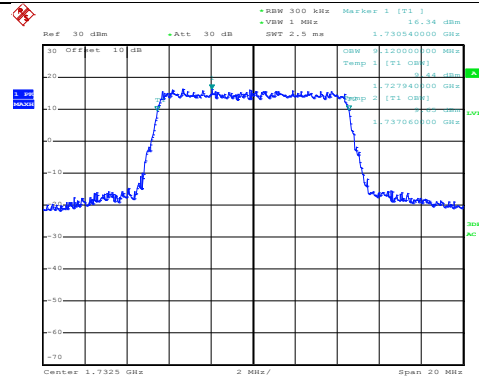

Date: 2.JUL.2018 15:48:52

Middle channel

16QAM

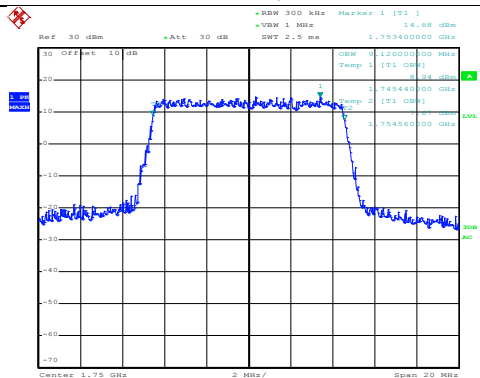

Date: 2.JUL.2018 15:49:43

QPSK

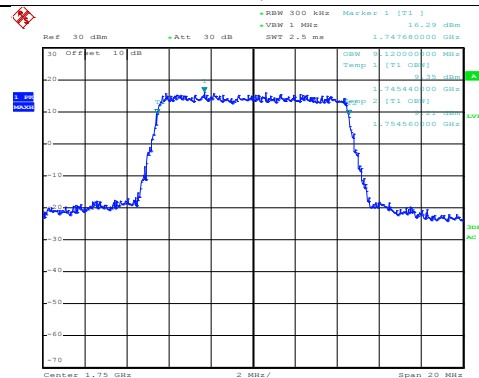

Date: 2.JUL.2018 15:49:38

Highest channel

LTE Band 4: 99% Occupy bandwidth
BW: 15MHz

16QAM

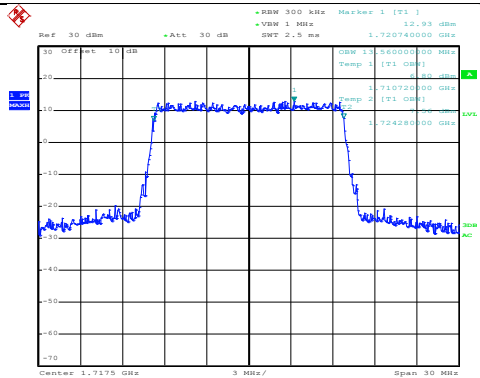

Date: 2.JUL.2018 15:50:14

QPSK

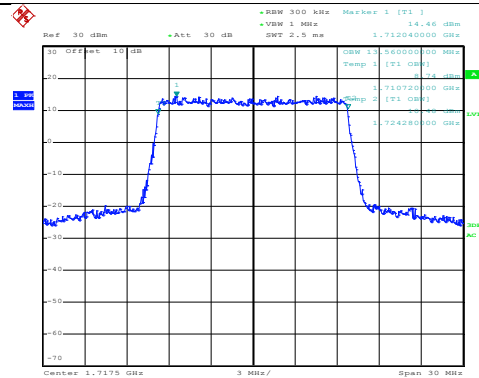

Date: 2.JUL.2018 15:50:10

Lowest channel

16QAM

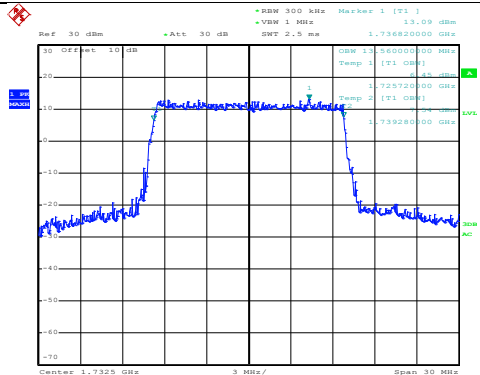

Date: 2.JUL.2018 15:51:04

QPSK

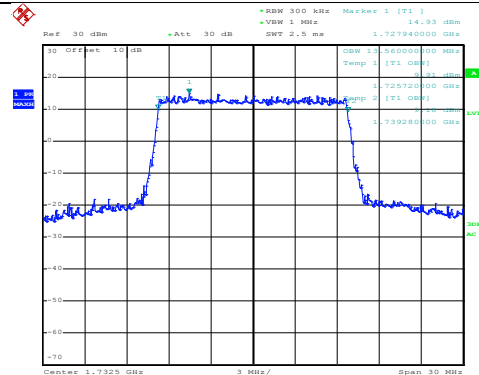

Date: 2.JUL.2018 15:51:00

Middle channel

16QAM

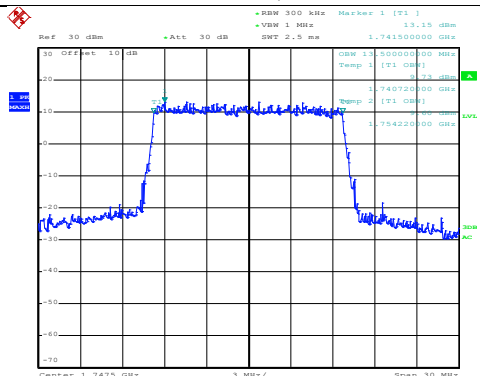

Date: 2.JUL.2018 15:51:25

QPSK

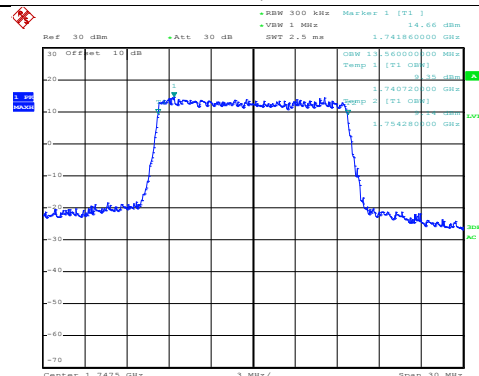

Date: 2.JUL.2018 15:51:21

Highest channel

LTE Band 4: 99% Occupy bandwidth
BW: 20MHz

16QAM

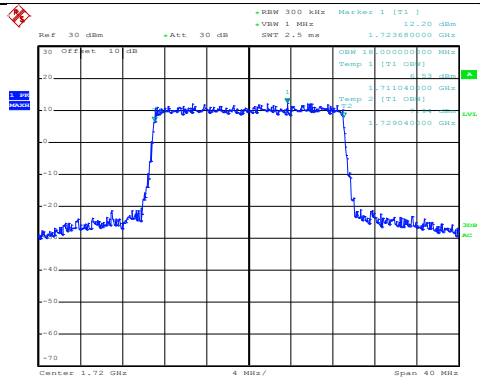

Date: 2.JUL.2018 15:52:38

QPSK

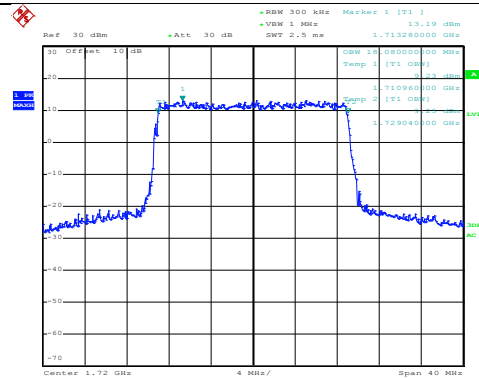

Date: 2.JUL.2018 15:52:32

Lowest channel

16QAM

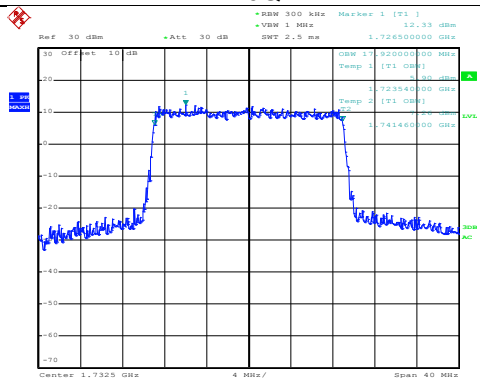

Date: 2.JUL.2018 15:53:01

QPSK

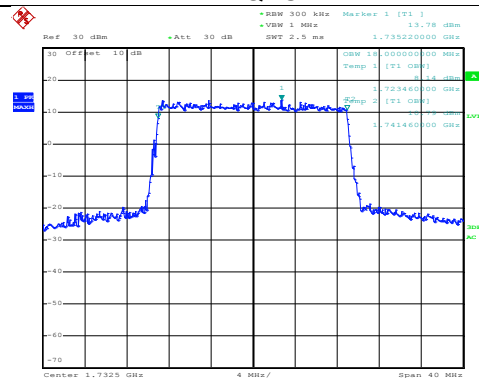

Date: 2.JUL.2018 15:52:57

Middle channel

16QAM

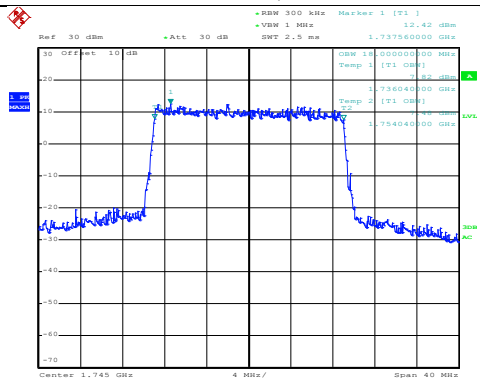

Date: 2.JUL.2018 15:53:48

QPSK

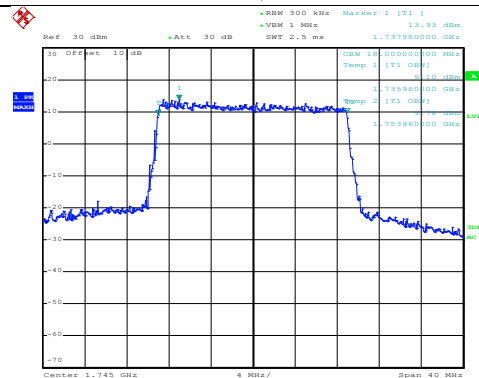

Date: 2.JUL.2018 15:53:43

Highest channel

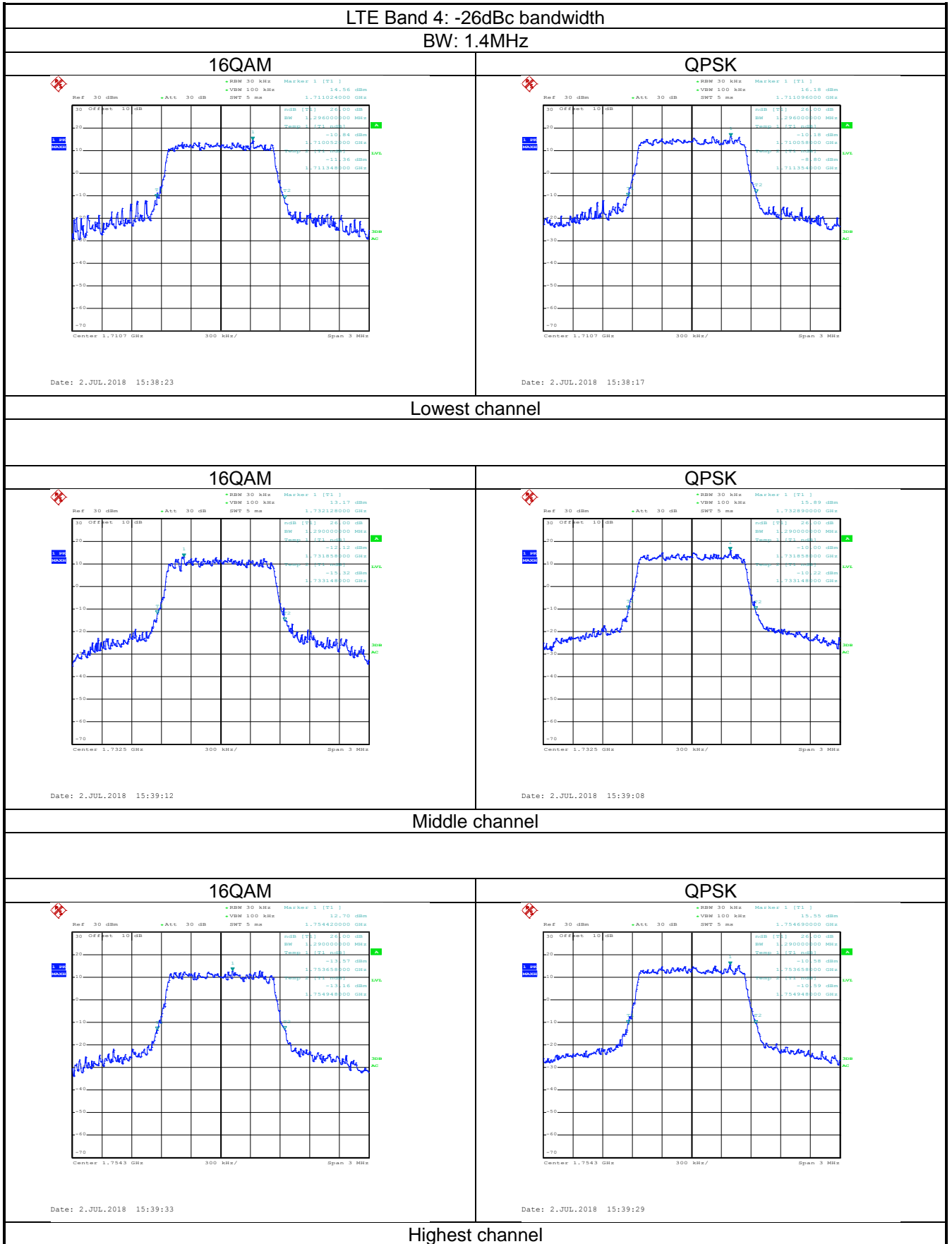

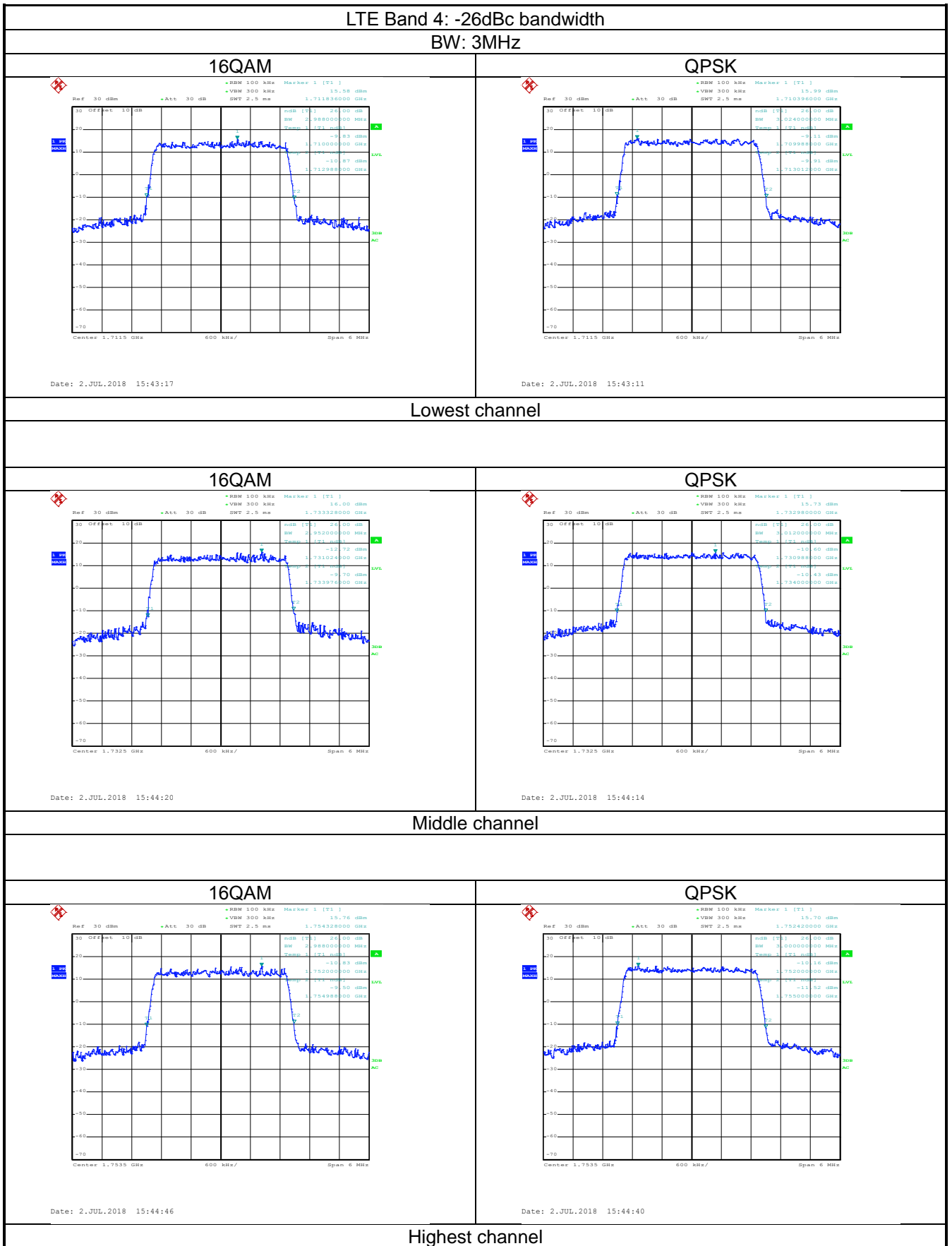

LTE Band 4: -26dBc bandwidth
BW: 5MHz

16QAM

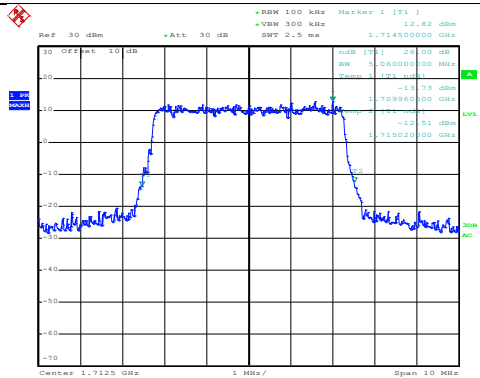

Date: 2.JUL.2018 15:46:25

QPSK

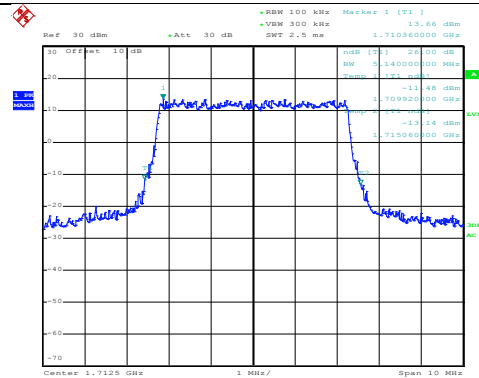

Date: 2.JUL.2018 15:46:20

Lowest channel

16QAM

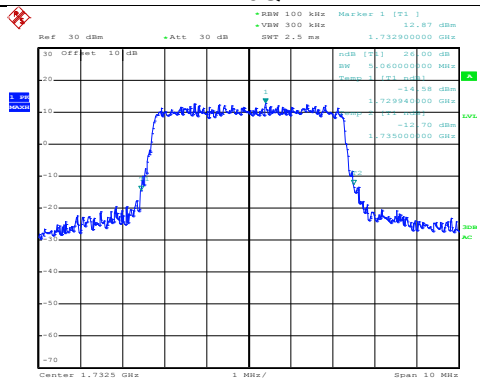

Date: 2.JUL.2018 15:46:48

QPSK

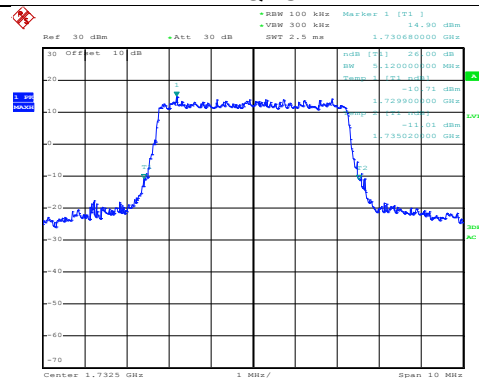

Date: 2.JUL.2018 15:46:44

Middle channel

16QAM

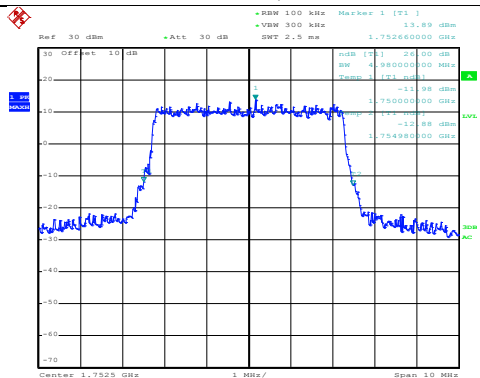

Date: 2.JUL.2018 15:47:38

QPSK

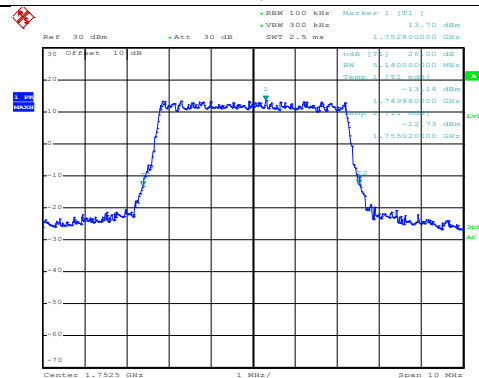

Date: 2.JUL.2018 15:47:33

Highest channel

LTE Band 4: -26dBc bandwidth
BW: 10MHz

16QAM

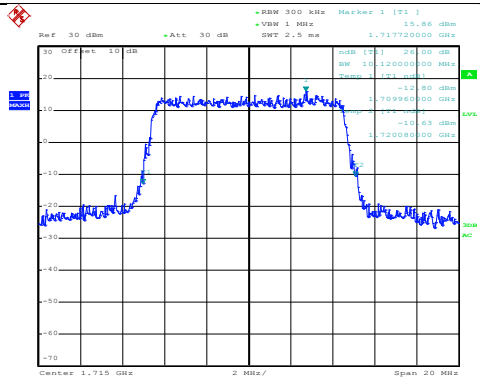

Date: 2.JUL.2018 15:48:22

QPSK

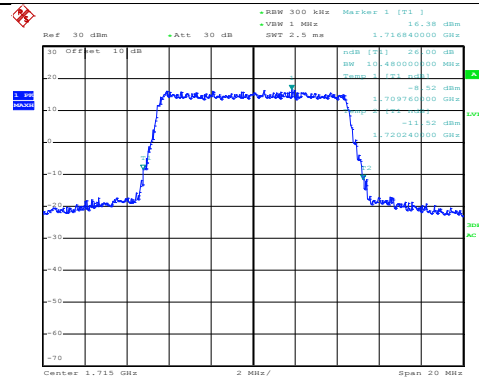

Date: 2.JUL.2018 15:48:18

Lowest channel

16QAM

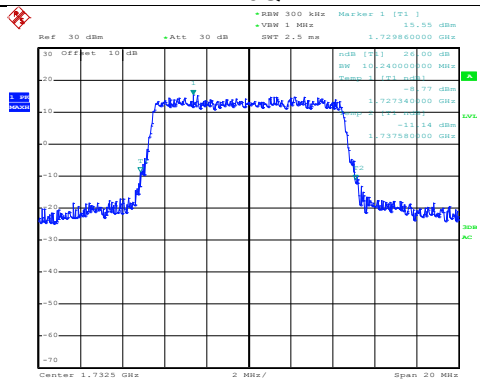

Date: 2.JUL.2018 15:49:10

QPSK

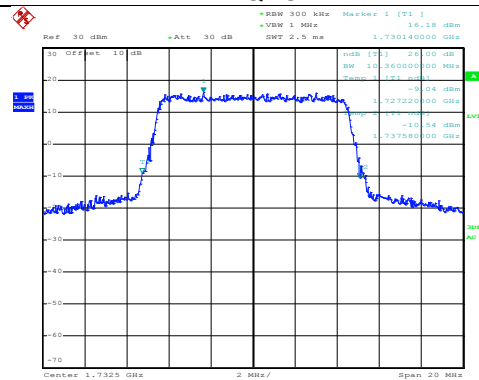

Date: 2.JUL.2018 15:49:05

Middle channel

16QAM

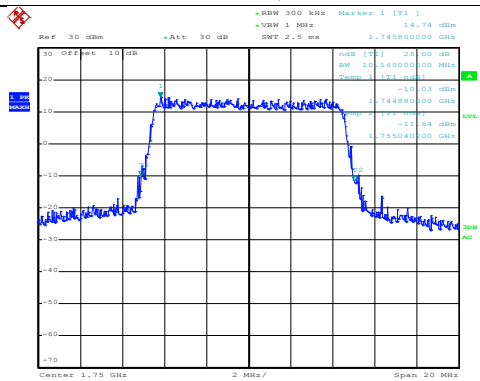

Date: 2.JUL.2018 15:49:30

QPSK

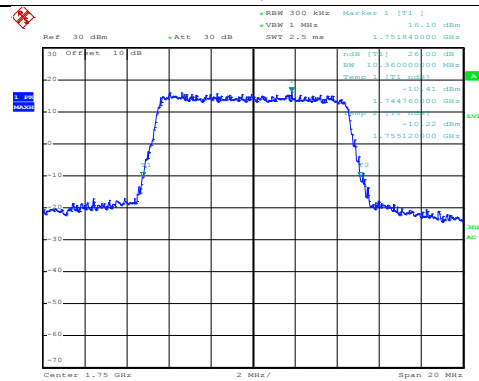

Date: 2.JUL.2018 15:49:26

Highest channel

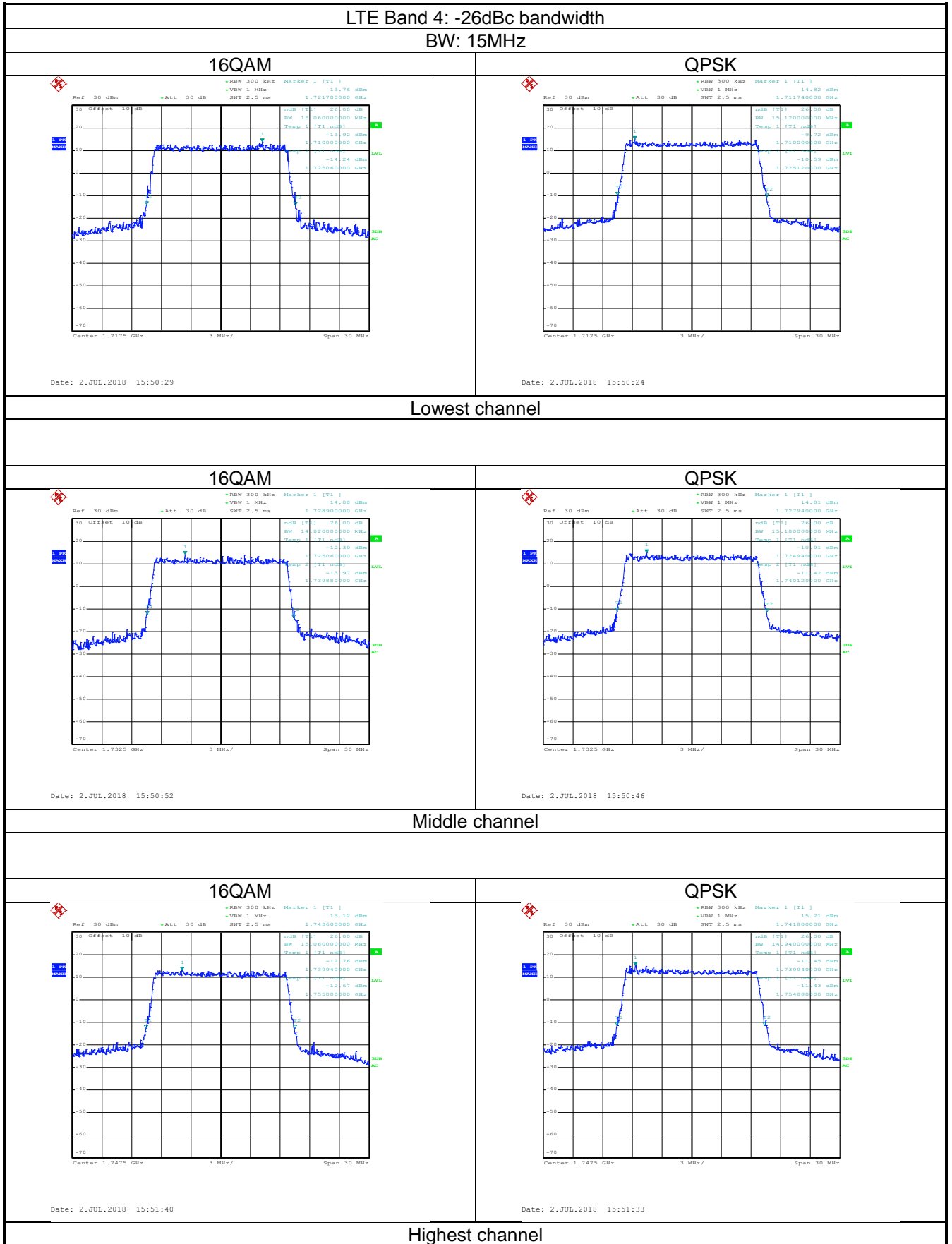

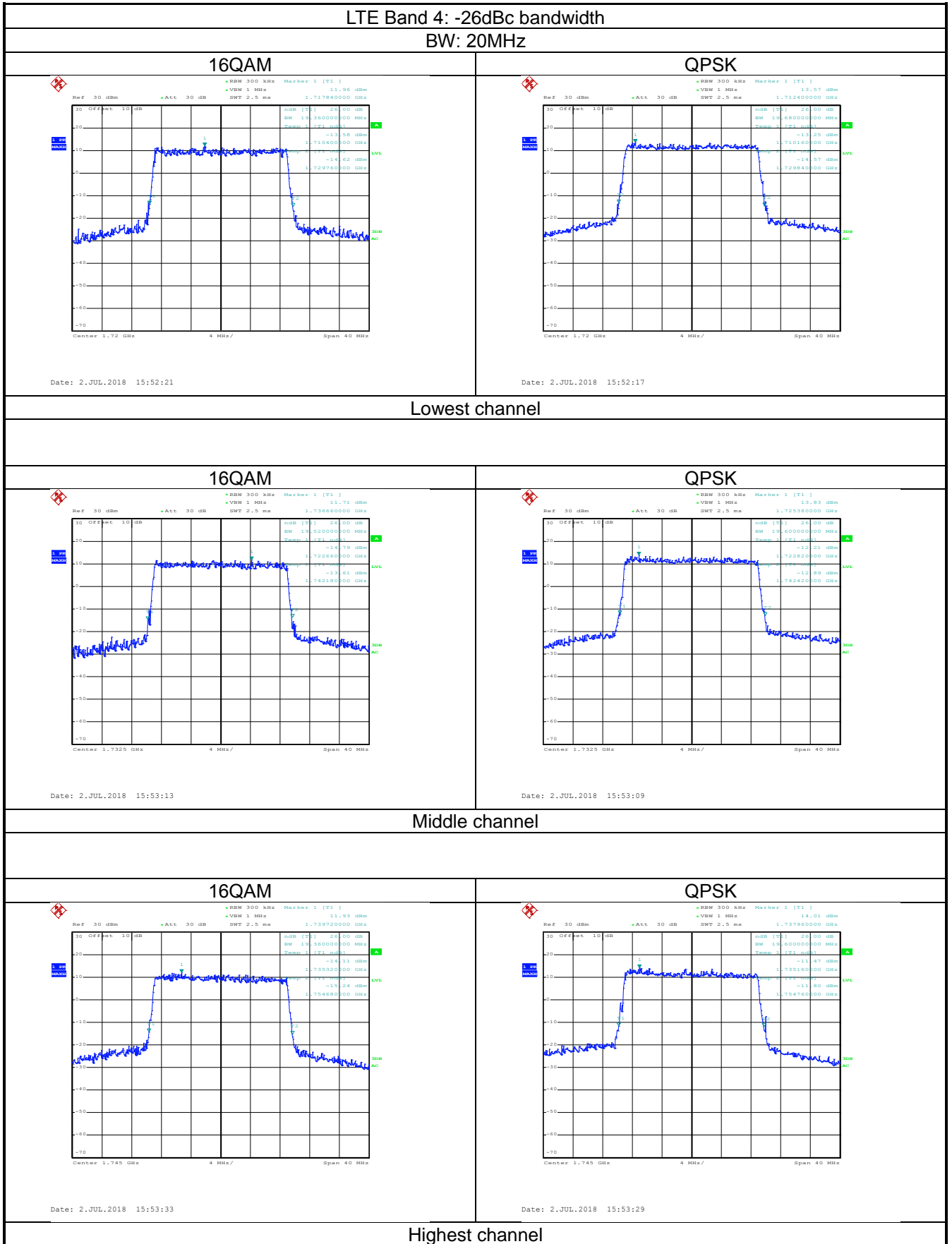

LTE Band 5 part:

LTE Band 5: 99% Occupy bandwidth
BW: 1.4MHz

16QAM

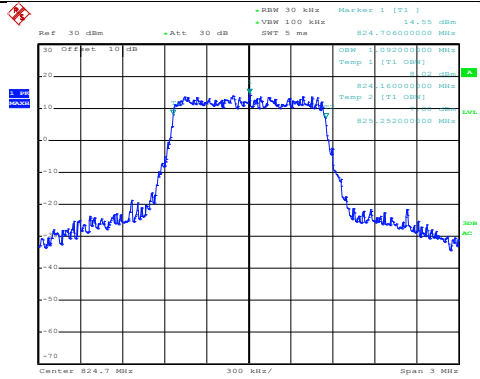

Date: 2.JUL.2018 16:06:10

QPSK

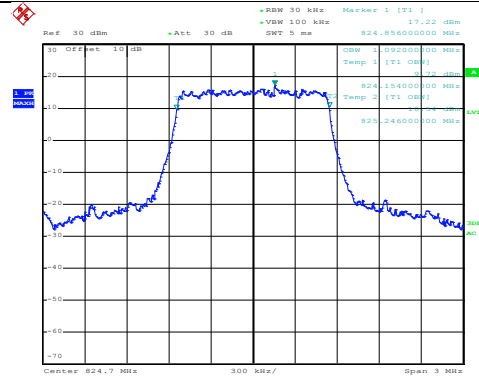

Date: 2.JUL.2018 16:06:06

Lowest channel

16QAM

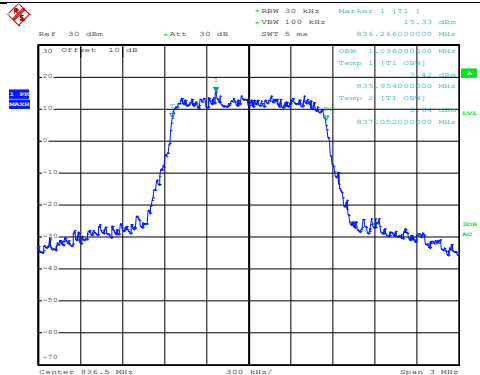

Date: 2.JUL.2018 16:06:59

QPSK

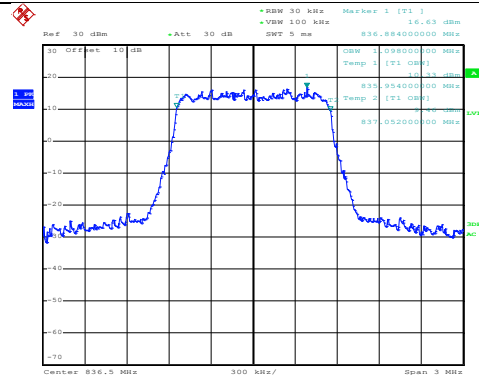

Date: 2.JUL.2018 16:06:55

Middle channel

16QAM

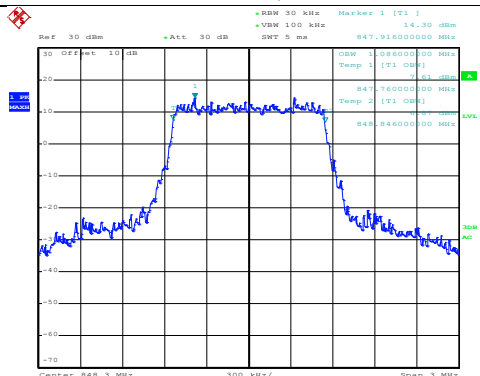

Date: 2.JUL.2018 16:07:24

QPSK

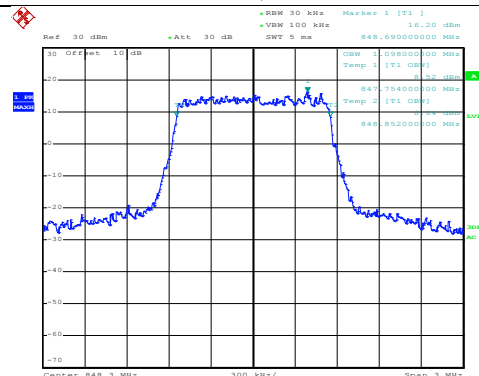

Date: 2.JUL.2018 16:07:20

Highest channel

LTE Band 5: 99% Occupy bandwidth
BW: 3MHz

16QAM

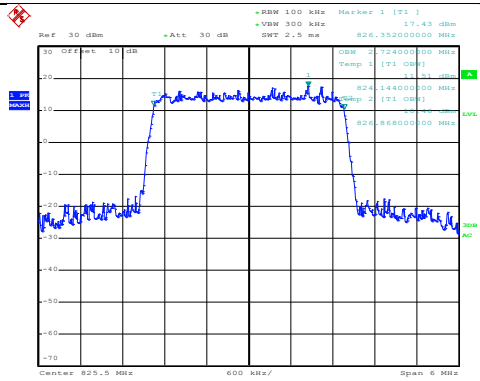

Date: 2.JUL.2018 16:08:28

QPSK

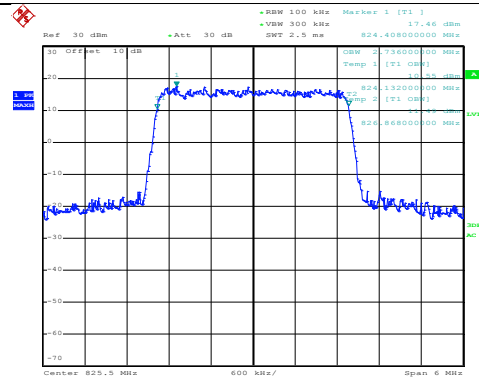

Date: 2.JUL.2018 16:08:23

Lowest channel

16QAM

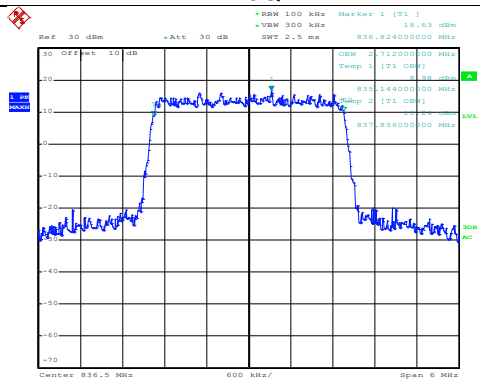

Date: 2.JUL.2018 16:08:47

QPSK

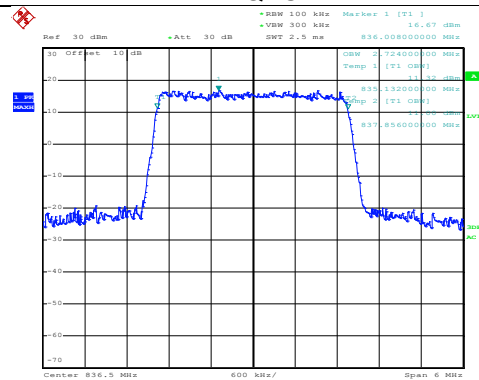

Date: 2.JUL.2018 16:08:43

Middle channel

16QAM

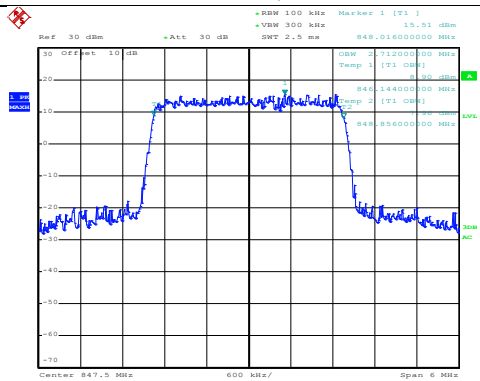

Date: 2.JUL.2018 16:09:40

QPSK

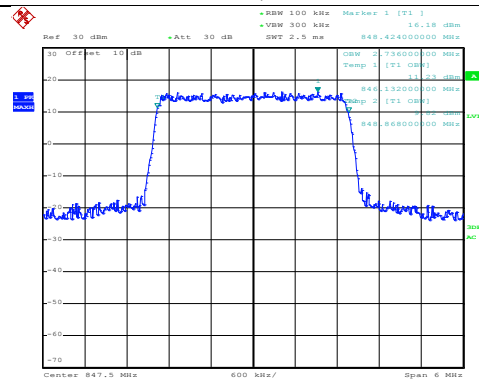

Date: 2.JUL.2018 16:09:35

Highest channel

LTE Band 5: 99% Occupy bandwidth
 BW: 5MHz

16QAM

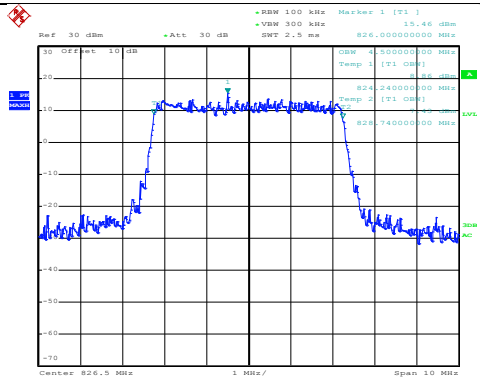

Date: 2.JUL.2018 16:10:17

QPSK

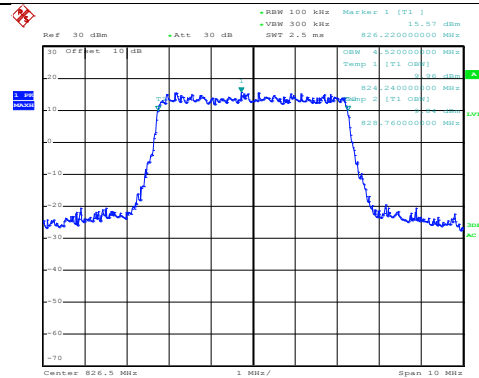

Date: 2.JUL.2018 16:10:13

Lowest channel

16QAM

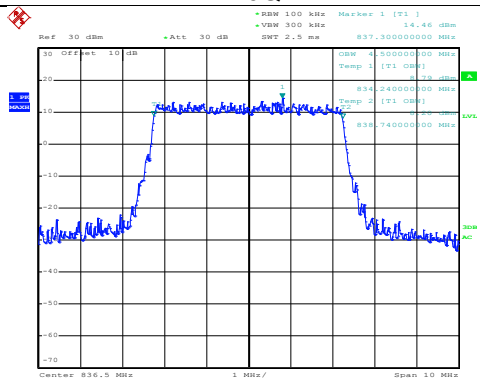

Date: 2.JUL.2018 16:11:08

QPSK

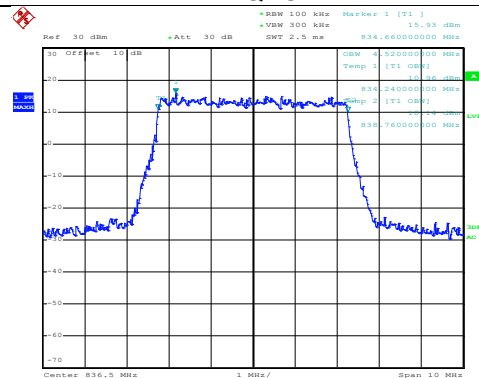

Date: 2.JUL.2018 16:11:04

Middle channel

16QAM

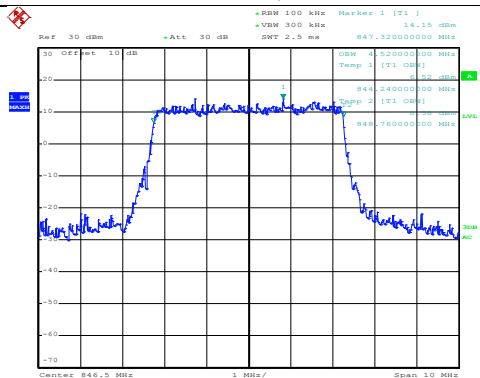

Date: 2.JUL.2018 16:12:06

QPSK

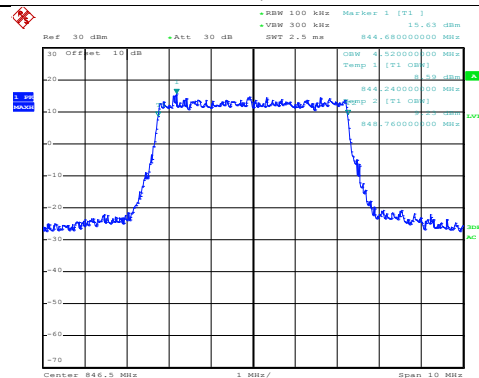

Date: 2.JUL.2018 16:12:01

Highest channel

LTE Band 5: 99% Occupy bandwidth
BW: 10MHz

16QAM

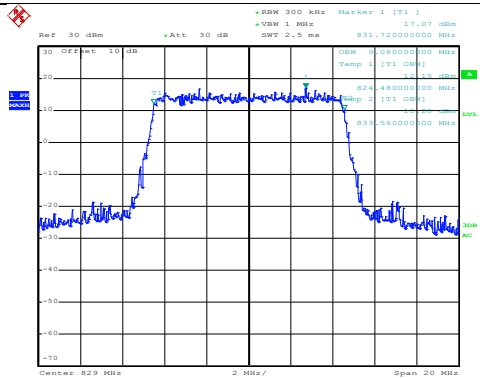

Date: 2.JUL.2018 16:12:57

QPSK

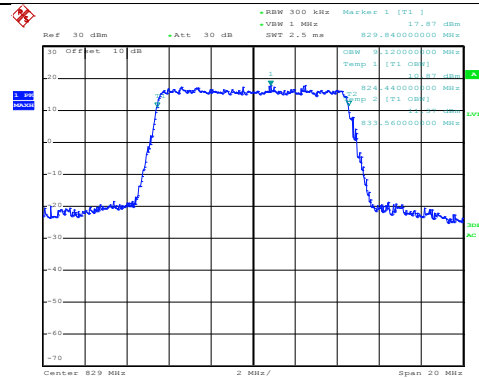

Date: 2.JUL.2018 16:12:53

Lowest channel

16QAM

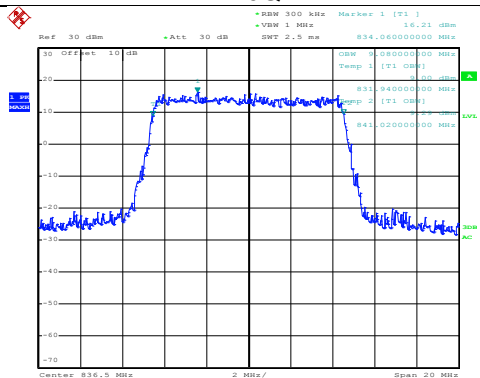

Date: 2.JUL.2018 16:16:21

QPSK

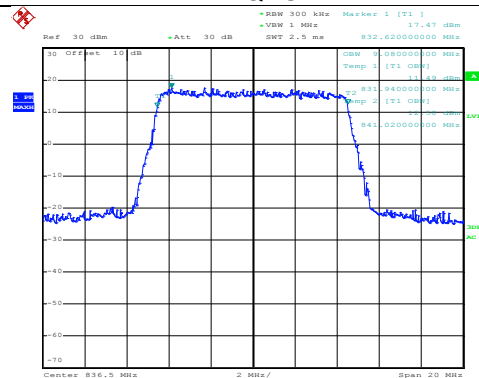

Date: 2.JUL.2018 16:16:17

Middle channel

16QAM

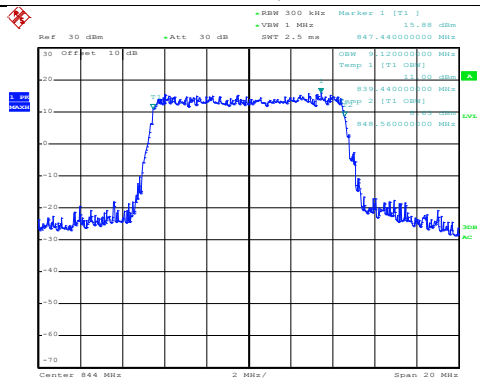

Date: 2.JUL.2018 16:16:45

QPSK

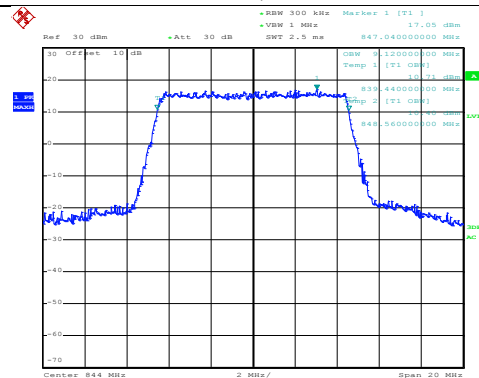

Date: 2.JUL.2018 16:16:40

Highest channel

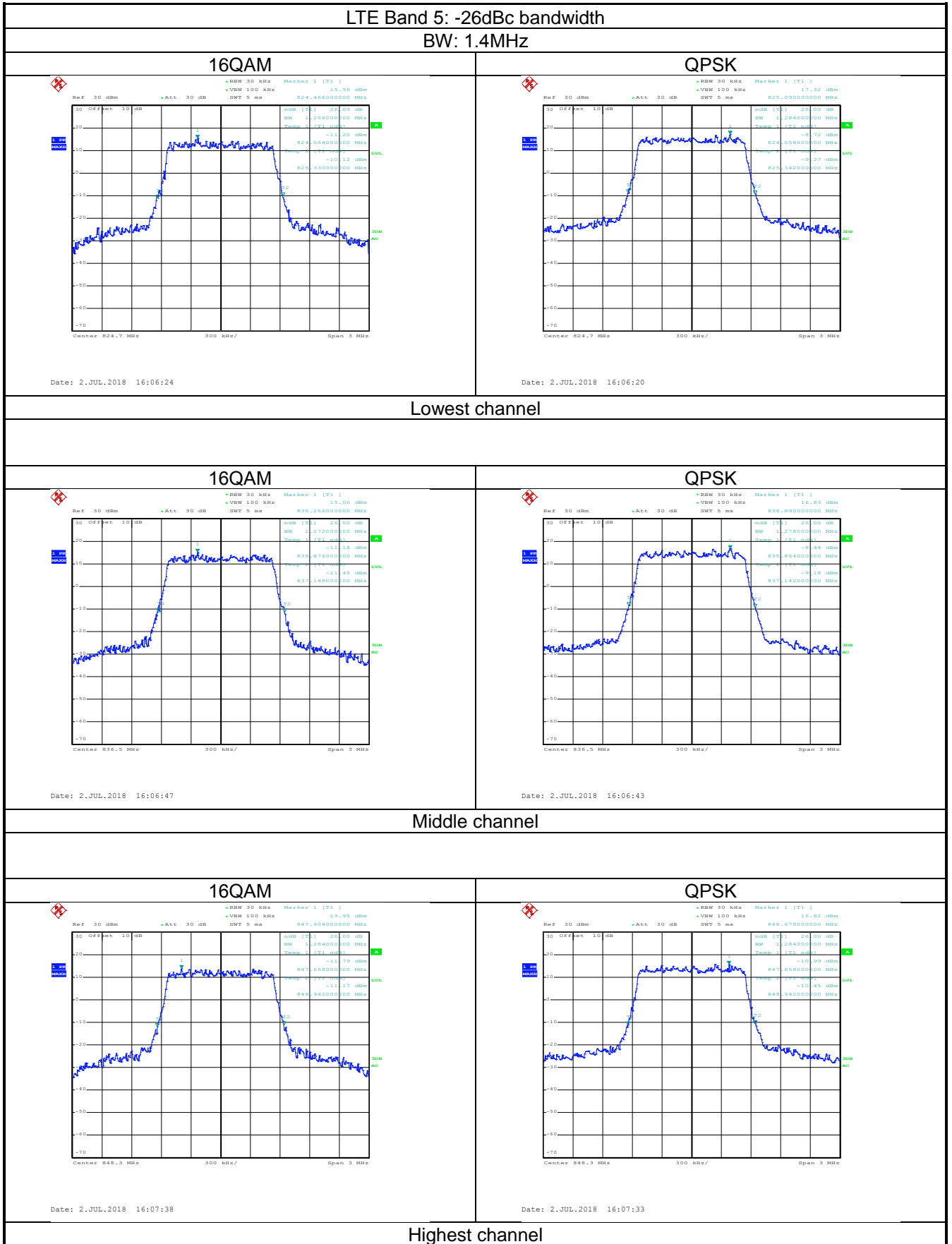

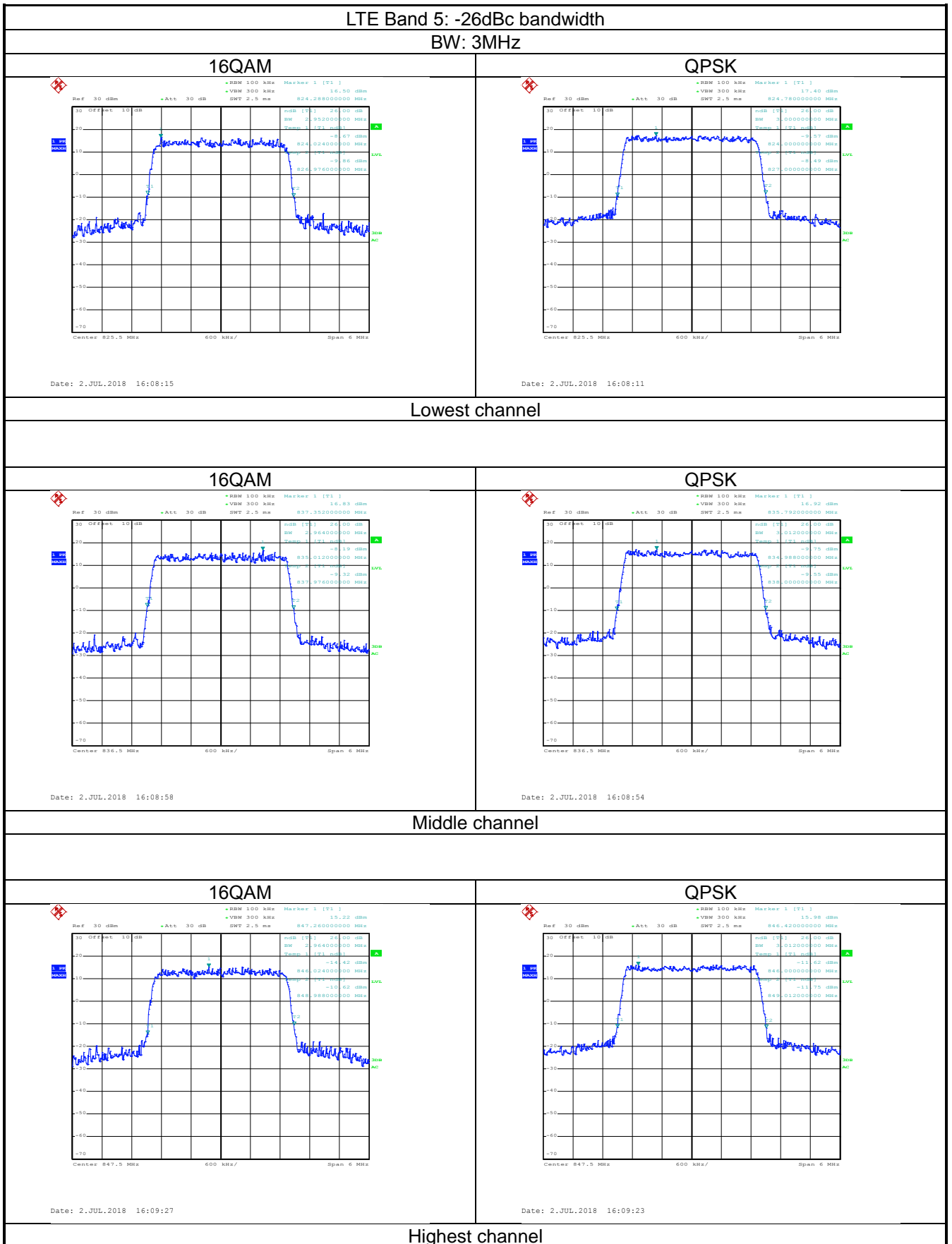

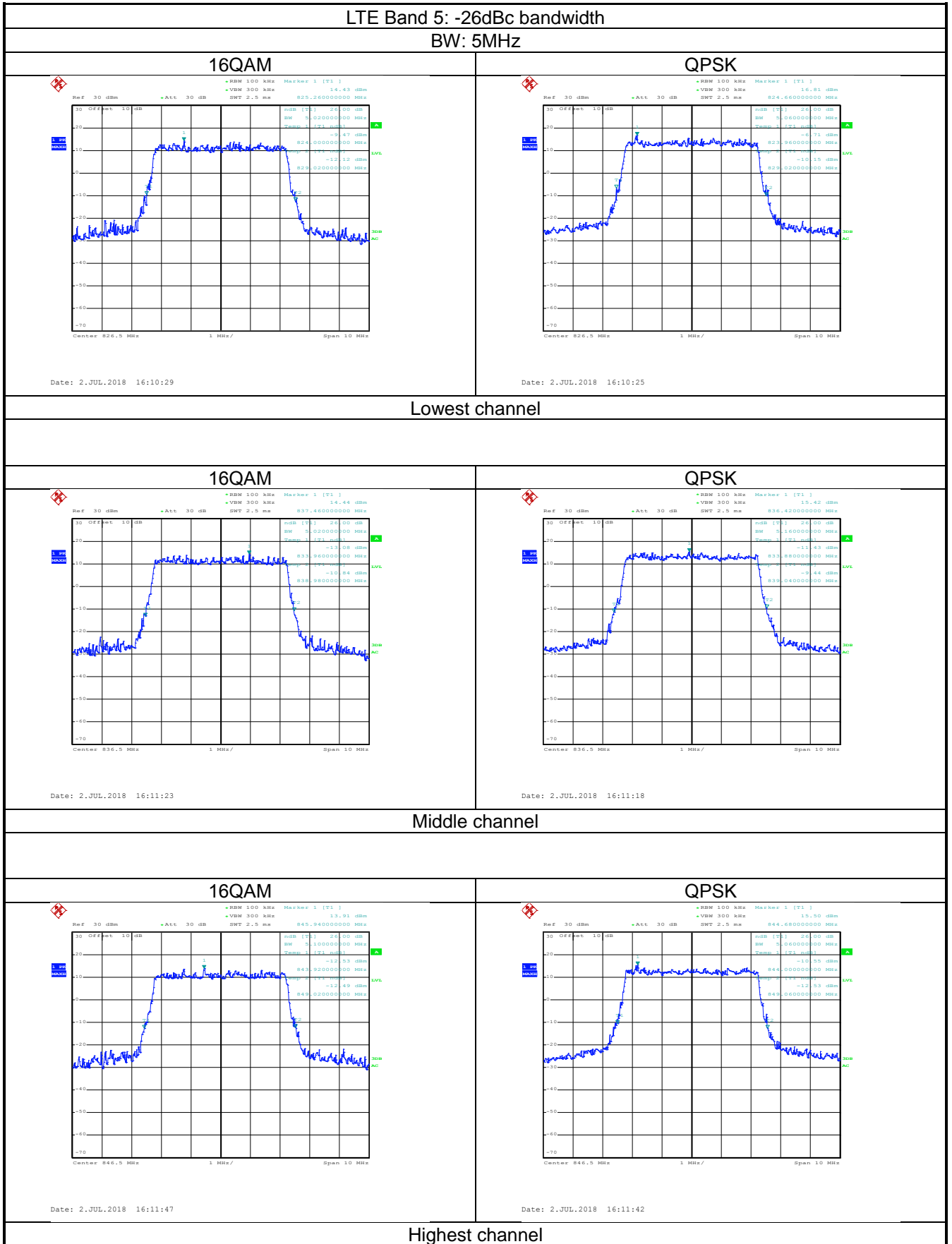

LTE Band 5: -26dBc bandwidth
BW: 10MHz

16QAM

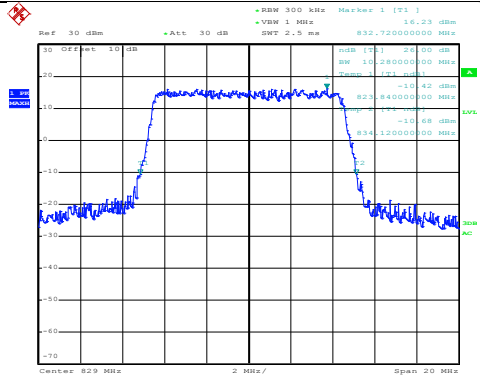

Date: 2.JUL.2018 16:13:11

QPSK

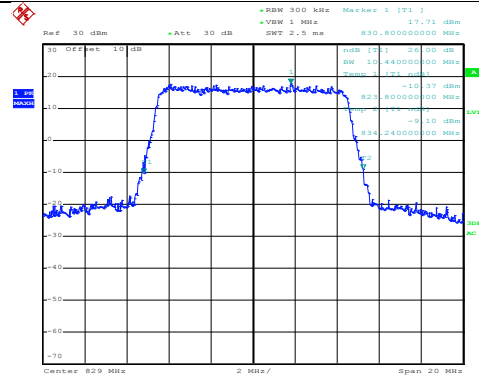

Date: 2.JUL.2018 16:13:06

Lowest channel

16QAM

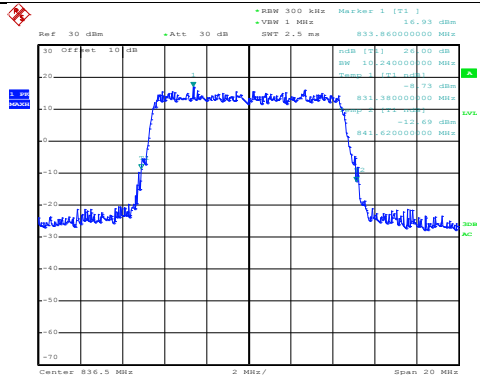

Date: 2.JUL.2018 16:16:06

QPSK

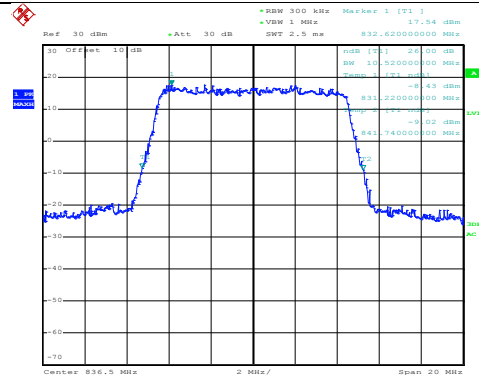

Date: 2.JUL.2018 16:16:03

Middle channel

16QAM

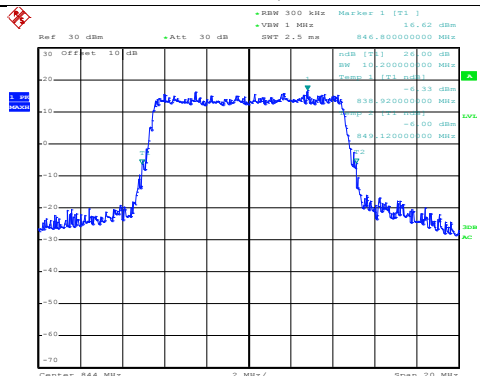

Date: 2.JUL.2018 16:17:00

QPSK

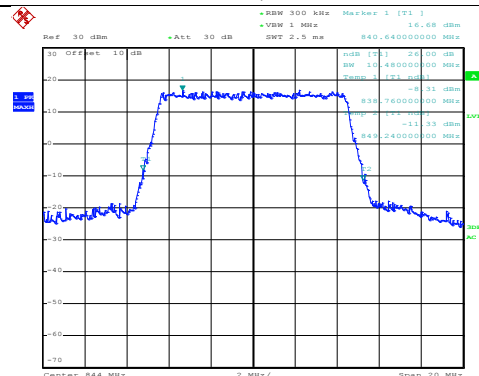

Date: 2.JUL.2018 16:16:56

Highest channel

LTE-Band 7 part:

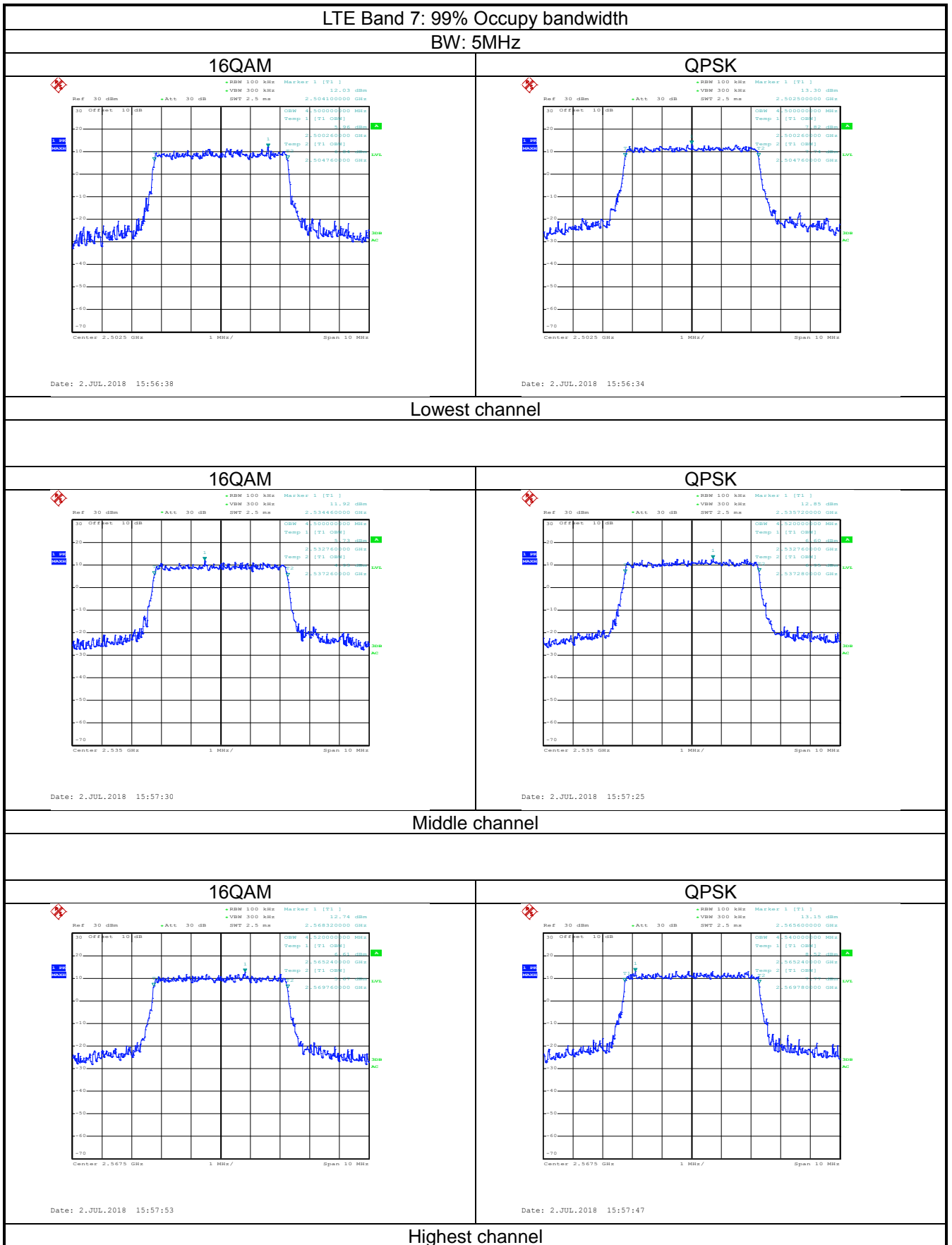

LTE Band 7: 99% Occupy bandwidth
 BW: 10MHz

16QAM

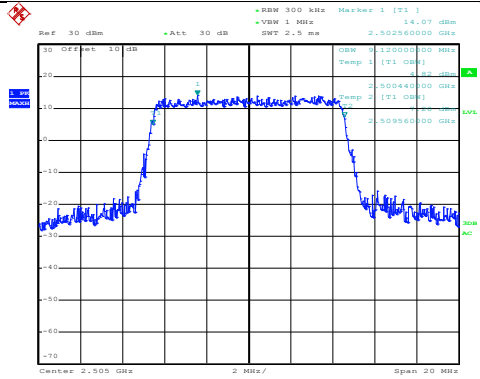

Date: 2.JUL.2018 15:59:52

QPSK

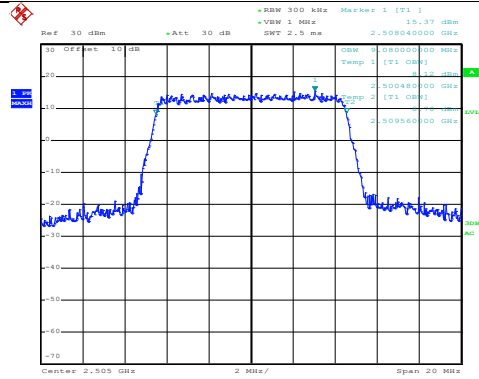

Date: 2.JUL.2018 15:59:47

Lowest channel

16QAM

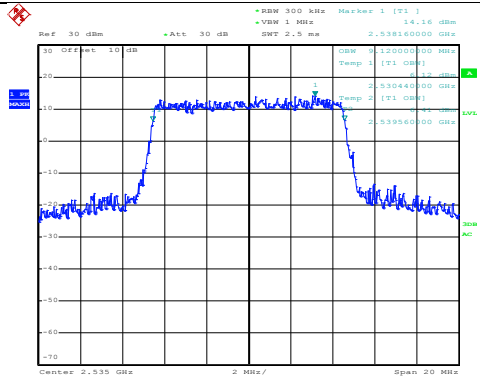

Date: 2.JUL.2018 16:00:11

QPSK

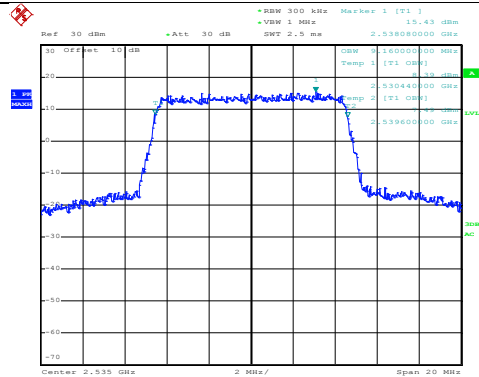

Date: 2.JUL.2018 16:00:08

Middle channel

16QAM

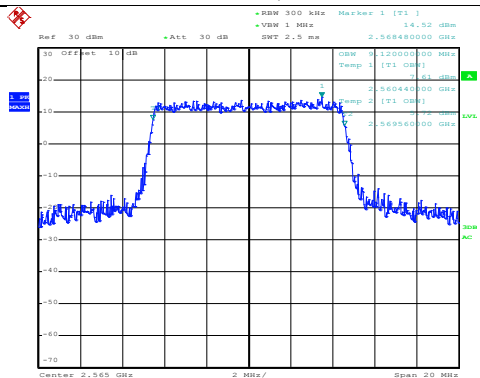

Date: 2.JUL.2018 16:00:57

QPSK

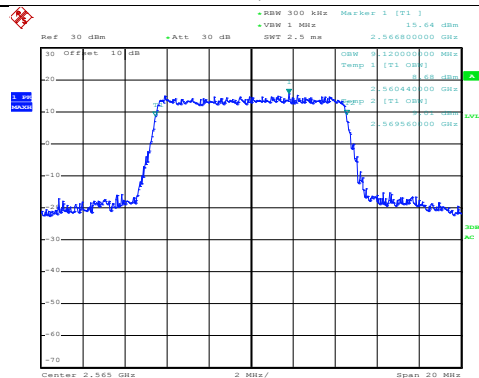

Date: 2.JUL.2018 16:00:53

Highest channel

LTE Band 7: 99% Occupy bandwidth
BW: 15MHz

16QAM

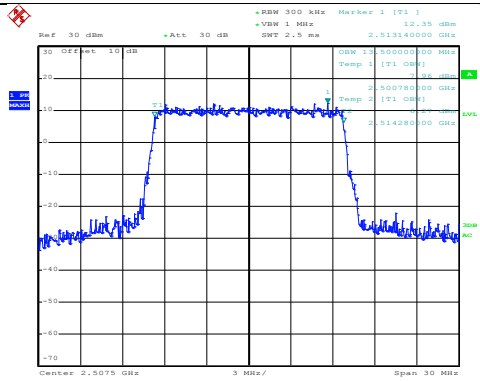

QPSK

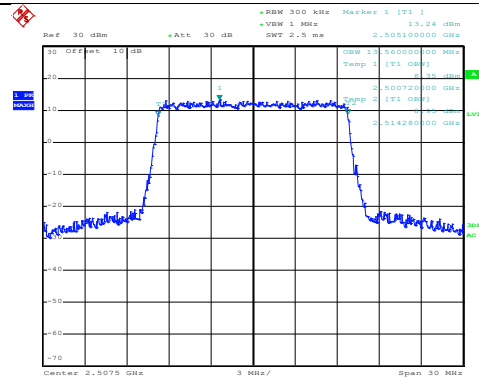

Lowest channel

16QAM

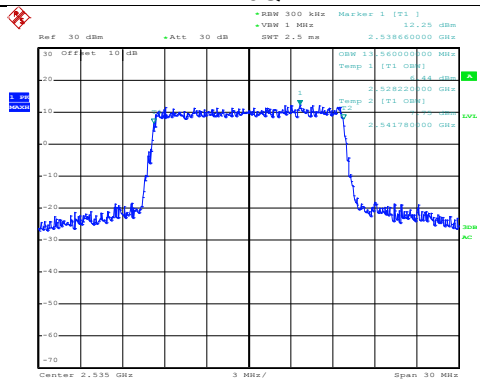

QPSK

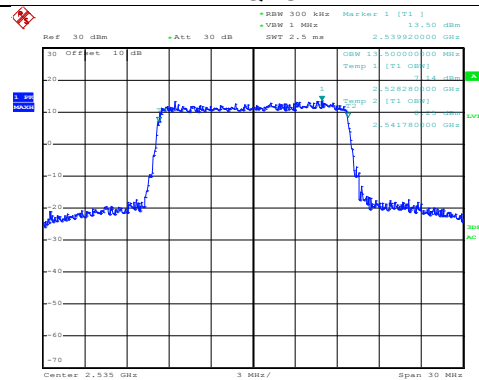

Middle channel

16QAM

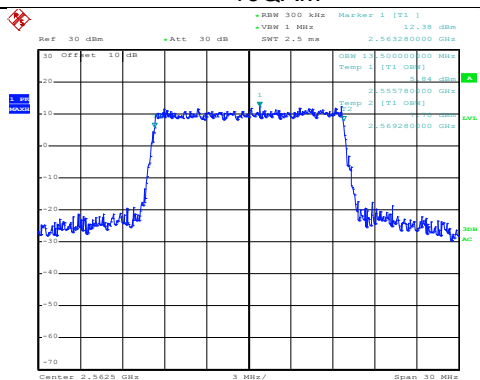

QPSK

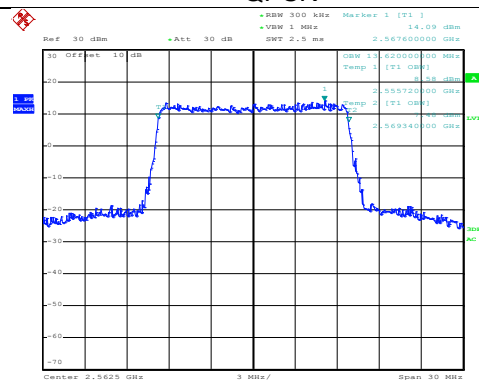

Highest channel

LTE Band 7: 99% Occupy bandwidth
BW: 20MHz

16QAM

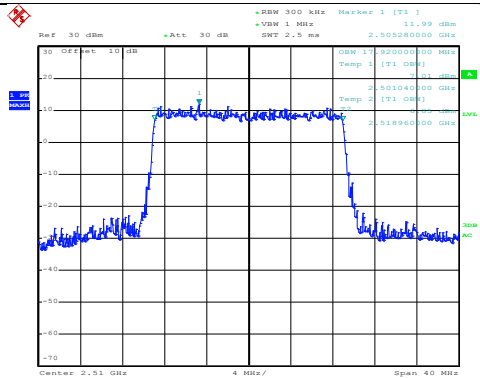

Date: 2.JUL.2018 16:03:58

QPSK

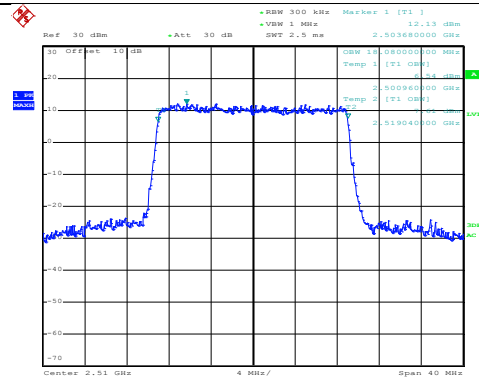

Date: 2.JUL.2018 16:03:54

Lowest channel

16QAM

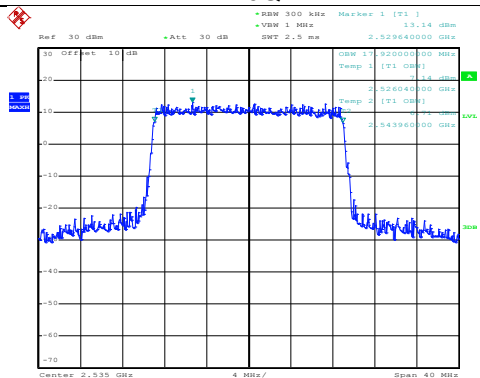

Date: 22.JUN.2018 11:06:46

QPSK

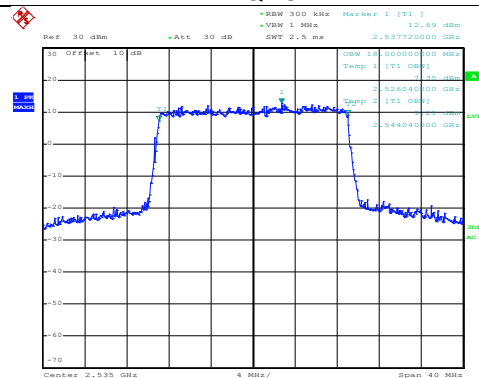

Date: 2.JUL.2018 16:04:12

Middle channel

16QAM

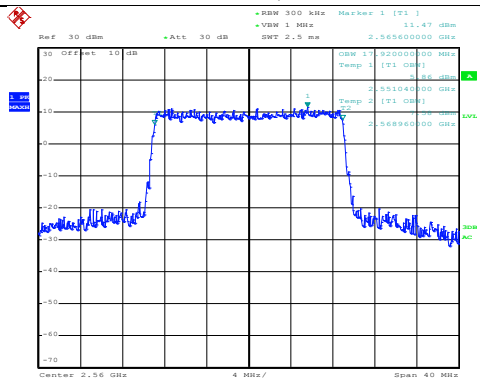

Date: 2.JUL.2018 16:05:14

QPSK

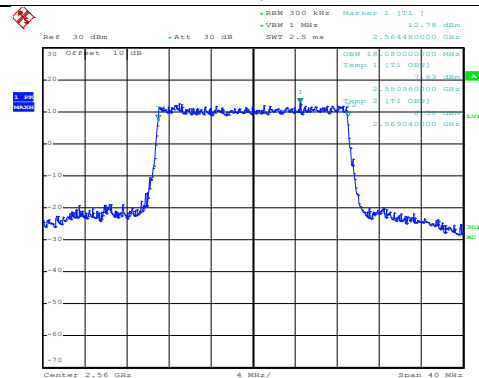

Date: 2.JUL.2018 16:05:10

Highest channel

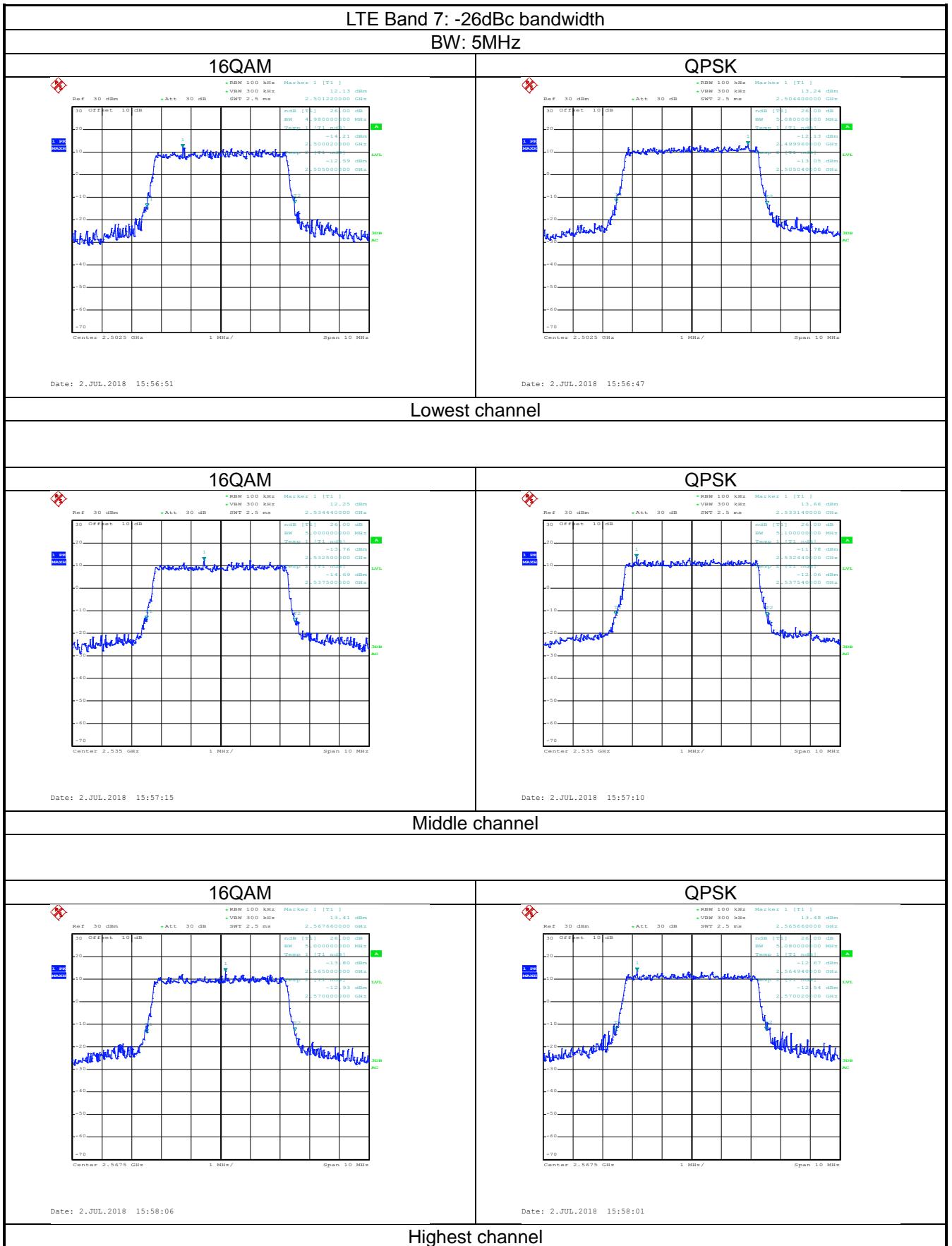

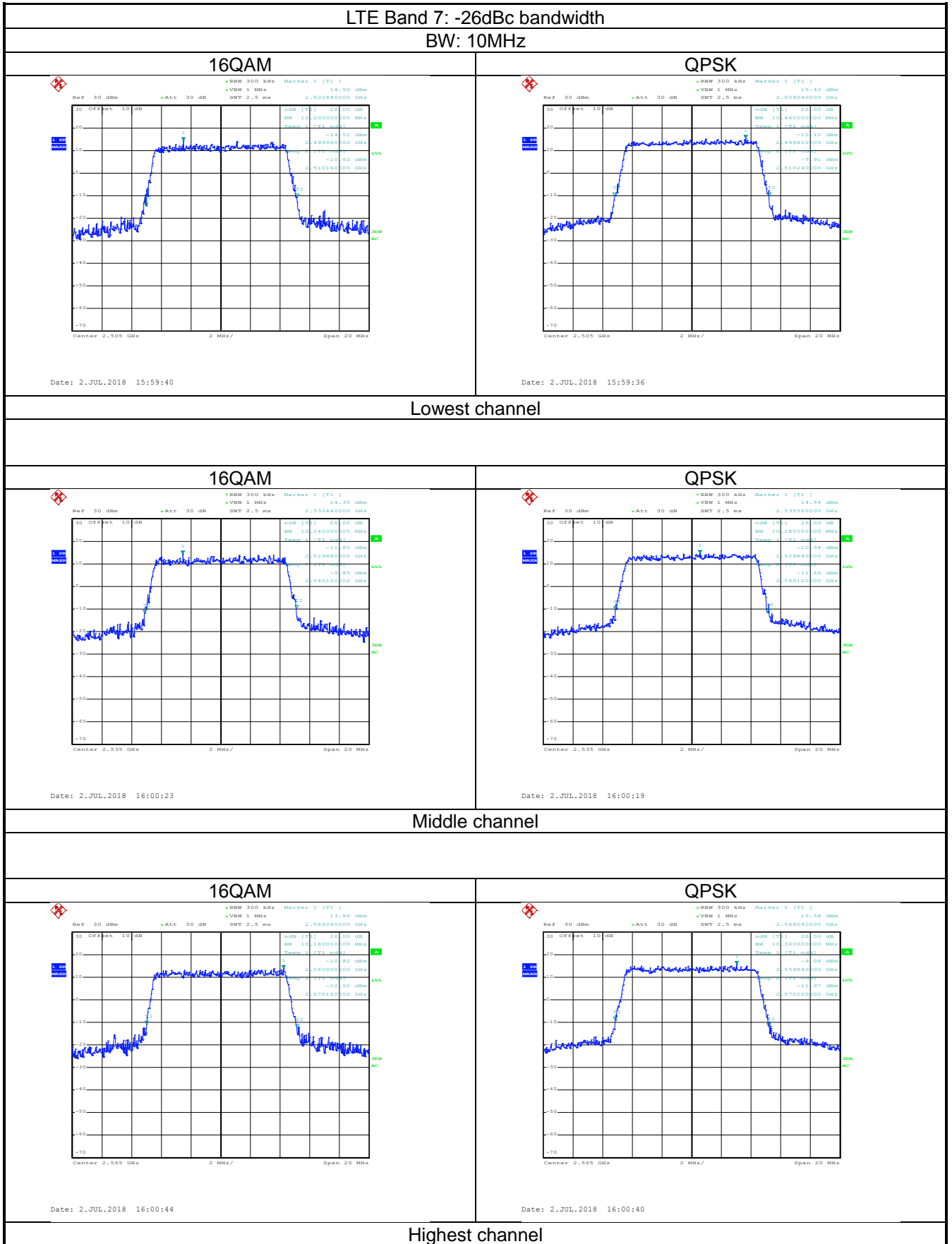

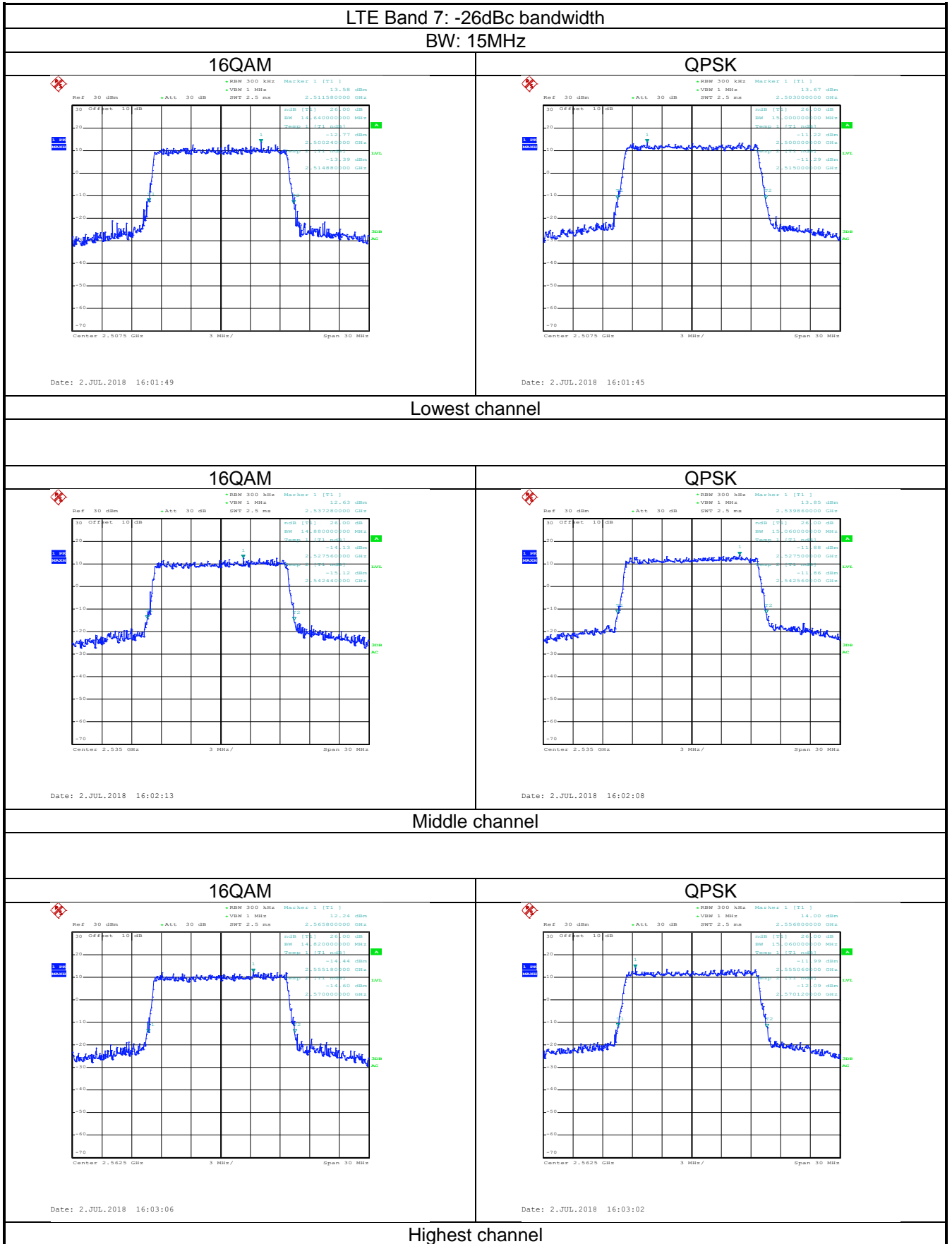

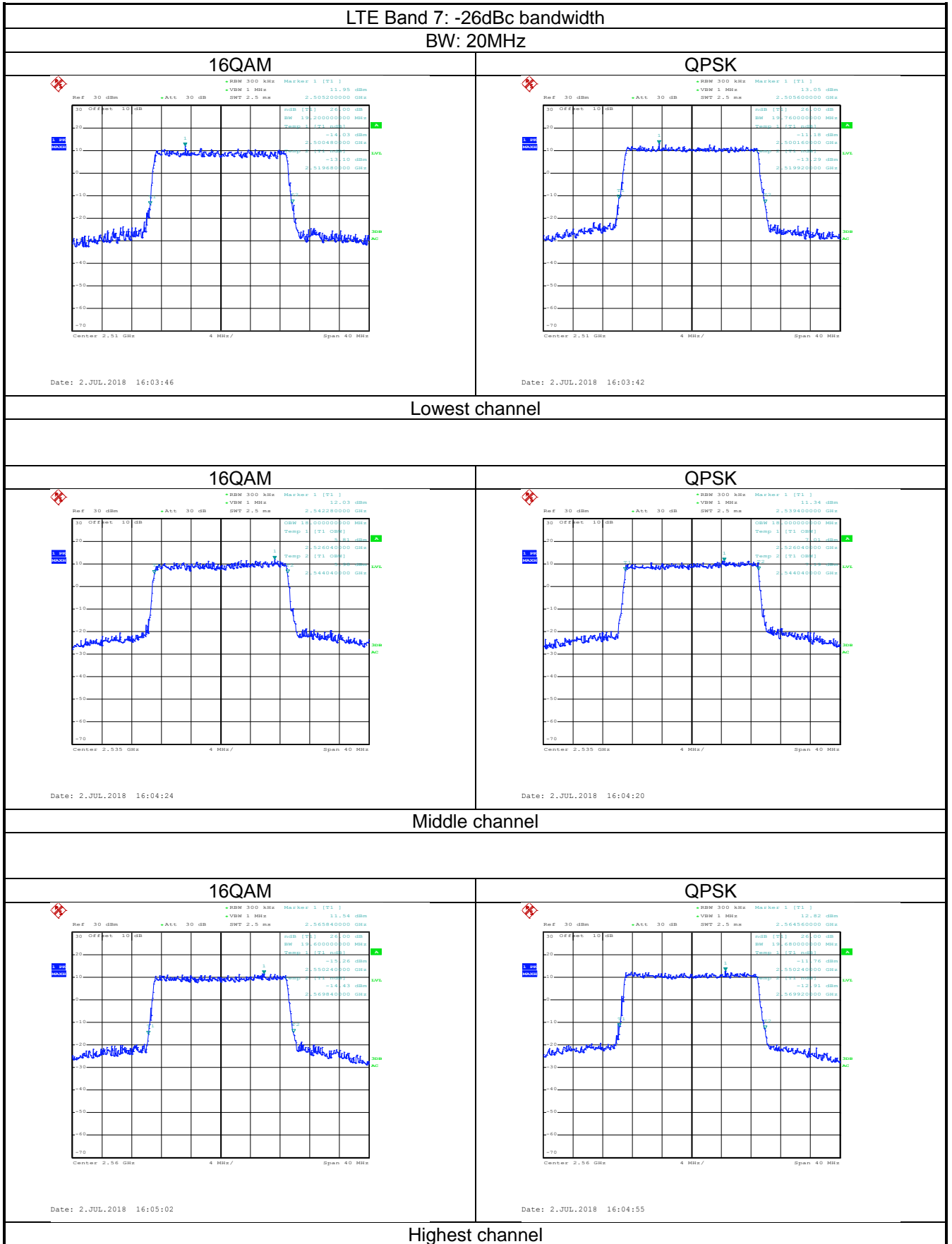

LTE Band 12 part:

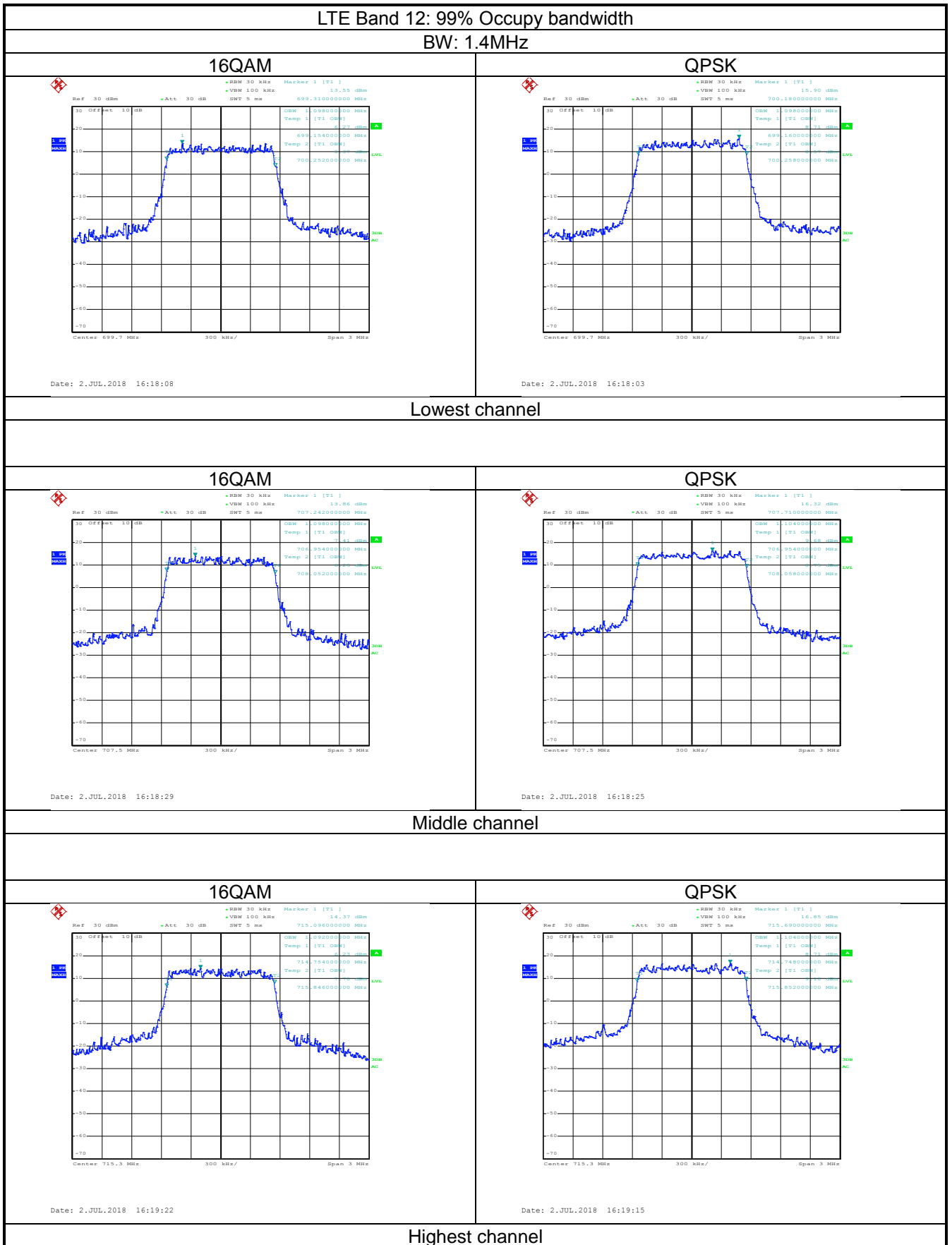

LTE Band 12: 99% Occupy bandwidth
 BW: 3MHz

16QAM

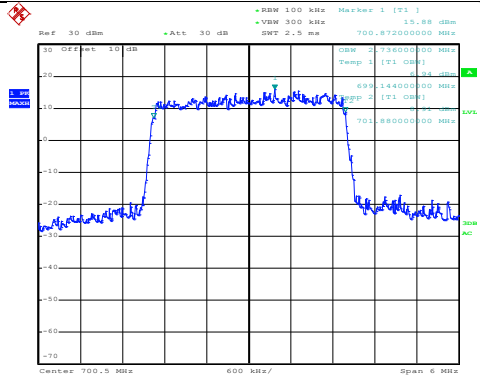

Date: 2.JUL.2018 16:20:01

QPSK

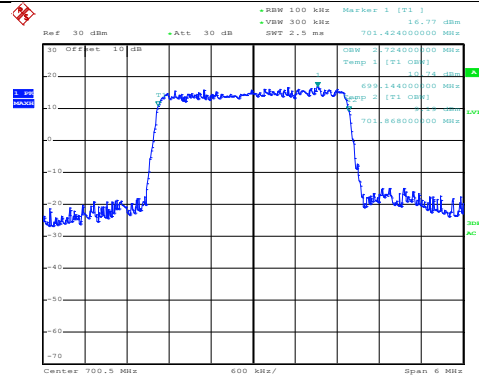

Date: 2.JUL.2018 16:19:57

Lowest channel

16QAM

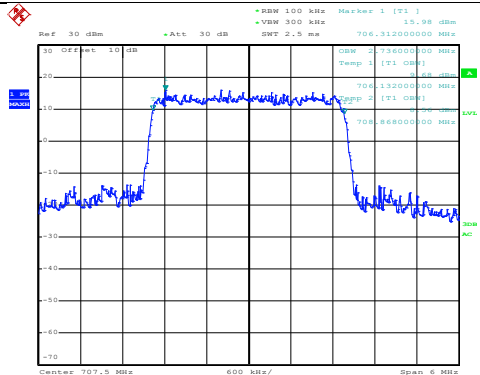

Date: 2.JUL.2018 16:20:49

QPSK

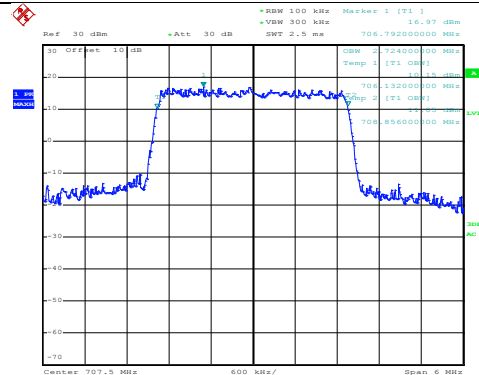

Date: 2.JUL.2018 16:20:44

Middle channel

16QAM

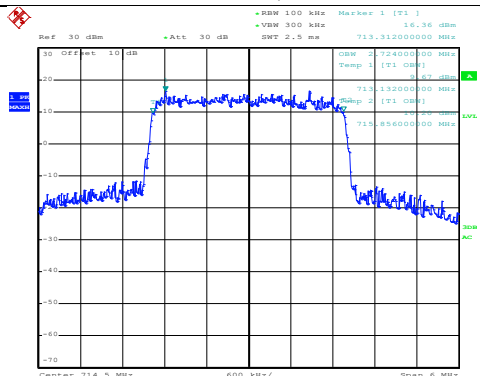

Date: 2.JUL.2018 16:21:10

QPSK

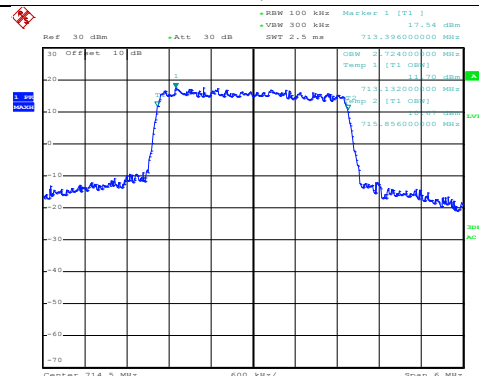

Date: 2.JUL.2018 16:21:06

Highest channel