

**FCC**  
**SAR EVALUATION REPORT**

For

**FCC ID : 2ADINN5005L**

Model: N5005L

<b>Report Type</b> : Original Report	<b>Product Name</b> : LTE PDA
<b>Report Number:</b> <u>RXZ210830006SA01</u>	
<b>Report Date:</b> <u>2021-09-23</u>	
<b>Prepared By:</b> Bay Area Compliance Laboratories Corp. 70, Lane 169, Sec. 2, Datong Road, Xizhi Dist., New Taipei City 22183, Taiwan, R.O.C. Tel: +886 (2)2647 6898 Fax: +886 (2) 2647 6895 <a href="http://www.bacl.com.tw">www.bacl.com.tw</a>	
<b>Facilities:</b> The test site used by Bay Area Compliance Laboratories Corp. to collect test data is located on 70, Lane 169, Sec. 2, Datong Road, Xizhi Dist., New Taipei City 22183, Taiwan, R.O.C.	

### Statement of Compliance

Applicant (Certification Holder)	Sun Cupid Technology (HK) Ltd.
	16/F, CEO Tower, 77 Wing Hong Street, Cheung Sha Wan, Kowloon, Hong Kong
Brand (Trade) Name	NUU
Product (Equipment) Name	LTE PDA
Model Name	N5005L
Serial Model Name	Tab 5, NUU Tab 5
Serial Number	RXZ210830006-01
Test Date	2021/08/31 ~ 2021/09/15

**Measurement Procedures and Standards Used:**

- IEEE1528:2013
- FCC 47 CFR part 2.1091
- FCC 47 CFR part 2.1093
- EN 62209-1:2016
- EN 62209-2:2010+A1:2019
- KDB 447498 D01 General RF Exposure Guidance v06
- KDB 648474 D04 Handset SAR v01r03
- KDB 865664 D01 SAR Measurement 100 MHz to 6 GHz v01r04
- KDB 865664 D02 RF Exposure Reporting v01r02
- KDB 941225 D01 3G SAR Procedures v03r01
- KDB 941225 D05 SAR for LTE Devices v02r05
- KDB 941225 D06 Hotspot Mode v02r01

The measurement results in this report were performed at Bay Area Compliance Laboratories Corp. Any unauthorized alteration, forgery or falsification of the content or appearance of this document is unlawful and offenders may be prosecuted to the fullest extent of the law.

Unless otherwise stated the results shown in this test report refer only to the sample(s) tested.

The determination of the test results does not require consideration of the uncertainty of the measurement, unless the assessment is required by customer agreement, regulation or standard document specification.

**Report Issued Date:** 2021-09-23

**Project Engineer:** Anson Lu *Anson Lu*

**Reviewed By:** Gimmy Tsai *Gimmy Tsai*

### Revision History

Revision	No.	Report Number	Issue Date	Description	Author/ Revised by
0.0	RXZ210830006	RXZ210830006SA01	2021.10.27	Original Report	Anson Lu

## TABLE OF CONTENTS

<b>EUT RESULTS</b> .....	<b>6</b>
<b>EUT DESCRIPTION</b> .....	<b>8</b>
Technical Specification .....	8
<b>REFERENCE, STANDARDS, AND GUIDELINES</b> .....	<b>10</b>
SAR Limits.....	11
<b>DESCRIPTION OF TEST SYSTEM</b> .....	<b>12</b>
Area Scans .....	16
Zoom Scan (Cube Scan Averaging) .....	16
<b>Recommended Tissue Dielectric Parameters for Head and Body</b> .....	<b>17</b>
Tissue Dielectric Parameters for Head and Body Phantoms .....	17
<b>EQUIPMENT LIST AND CALIBRATION</b> .....	<b>18</b>
Equipment’s List & Calibration Information .....	18
<b>SAR MEASUREMENT SYSTEM VERIFICATION</b> .....	<b>20</b>
Liquid Verification .....	20
System Accuracy Verification.....	23
System Verification Setup Block Diagram .....	23
SAR SYSTEM VALIDATION DATA.....	25
<b>EUT TEST STRATEGY AND METHODOLOGY</b> .....	<b>34</b>
Test Positions for Device Operating Next to a Person’s Ear.....	34
Cheek/Touch Position .....	34
Test positions for body-worn and other configurations.....	36
Test Distance for SAR Evaluation.....	36
SAR Evaluation Procedure.....	37
<b>CONDUCTED OUTPUT POWER MEASUREMENT</b> .....	<b>38</b>
Provision Applicable .....	38
Test Procedure.....	38
Maximum Target Output Power.....	43
Test Results: .....	44
<b>GPRS 850</b> .....	<b>45</b>
<b>GPRS 1900</b> .....	<b>45</b>
<b>EGPRS 850</b> .....	<b>45</b>
<b>EGPRS 1900</b> .....	<b>45</b>
<b>STANDALONE SAR TEST EXCLUSION CONSIDERATIONS</b> .....	<b>68</b>
Antenna Distance to Edge(Front View).....	68
Standalone SAR test exclusion considerations (for Ant. to Edge Distance $\leq 50\text{mm}$ ) .....	70
Standalone SAR test exclusion considerations (for Ant. to Top Distance $> 50\text{mm}$ ).....	70
<b>SAR MEASUREMENT RESULTS</b> .....	<b>72</b>

SAR Test Data..... 72

**SAR SIMULTANEOUS TRANSMISSION DESCRIPTION ..... 89**

**APPENDIX A MEASUREMENT UNCERTAINTY ..... 91**

**APPENDIX B EUT TEST POSITION PHOTOS ..... 92**

**APPENDIX C SAR PLOTS OF SAR MEASUREMENT ..... 93**

**APPENDIX D PROBE & DAE CALIBRATION CERTIFICATES..... 94**

**APPENDIX E DIPOLE CALIBRATION CERTIFICATES ..... 95**

**APPENDIX F SAR Setup PHOTO ..... 96**

**APPENDIX G SAR EUT PHOTO..... 97**

## EUT RESULTS

Attestation of Test Results			
Frequency Band	Max. SAR Level(s) Reported(W/kg)		Limit(W/kg)
GSM 850	1g Head SAR	/	1.6
	1g Body SAR	0.019	
PCS 1900	1g Head SAR	/	
	1g Body SAR	0.589	
WCDMA Band II	1g Head SAR	/	
	1g Body SAR	0.949	
WCDMA Band IV	1g Head SAR	/	
	1g Body SAR	1.084	
WCDMA Band V	1g Head SAR	/	
	1g Body SAR	0.514	
LTE Band 2	1g Head SAR	/	
	1g Body SAR	1.059	
LTE Band 4	1g Head SAR	/	
	1g Body SAR	1.213	
LTE Band 5	1g Head SAR	/	
	1g Body SAR	0.588	
LTE Band 7	1g Head SAR	/	
	1g Body SAR	0.771	
LTE Band 12	1g Head SAR	/	
	1g Body SAR	0.680	
LTE Band 66	1g Head SAR	/	
	1g Body SAR	1.217	
LTE Band 71	1g Head SAR	/	
	1g Body SAR	0.604	
WLAN 2.4GHz	1g Head SAR	/	
	1g Body SAR	0.208	
WLAN 5.2GHz	1g Head SAR	/	
	1g Body SAR	0.211	
WLAN 5.8GHz	1g Head SAR	/	
	1g Body SAR	0.098	

<b>Bluetooth</b>	1g Head SAR	/	
	1g Body SAR	0.032	
<b>Simultaneous</b>	1g Body SAR	1.424	
	1g Body SAR(Hotspot)	1.424	

Note: This wireless device has been shown to be capable of compliance for localized specific absorption rate (SAR) for General Population/Uncontrolled Exposure limits specified in FCC 47 CFR part 2.1093 and has been tested in accordance with the measurement procedures specified in IEEE 1528-2013 and RF exposure KDB procedures.  
**The results and statements contained in this report pertain only to the device(s) evaluated.**

## EUT DESCRIPTION

### Technical Specification

<b>Applicant</b>	Sun Cupid Technology (HK) Ltd.
<b>Exposure Category</b>	Population / Uncontrolled
<b>Antenna Type(s)</b>	FPC Antenna for GSM and WCDMA and LTE FPC Antenna for WLAN and Bluetooth
<b>Modulation Type</b>	GPRS/EGPRS: GMSK,8PSK WCDMA: BPSK,QPSK,16QAM; LTE: QPSK,16QAM 2.4G Wi-Fi: DSSS,OFDM; 5G Wi-Fi: OFDM BT3.0: GFSK, $\pi/4$ -DQPSK,8DPSK; BLE: GFSK
<b>Frequency Band</b>	GPRS/EGPRS 850: 824 ~ 849 MHz(TX) GPRS/EGPRS 1900: 1850 ~ 1910MHz(TX) WCDMA Band II: 1850 ~ 1910 MHz(TX) WCDMA Band IV: 1710 ~ 1755 MHz(TX) WCDMA Band V: 824 ~ 849 MHz(TX) LTE Band 2: 1850 ~ 1910 MHz(TX) LTE Band 4: 1710 ~ 1755 MHz(TX) LTE Band 5: 824 ~ 849 MHz(TX) LTE Band 7: 2500 ~ 2570 MHz(TX) LTE Band 12: 699 ~ 716 MHz(TX) LTE Band 66: 1710 ~ 1780 MHz(TX) LTE Band 71: 663 ~ 698 MHz(TX) 2.4G Wi-Fi: 2412 ~ 2462 MHz(b/g/n20) ; 2422 ~ 2452 MHz(n40) BT/BLE: 2402 ~ 2480 MHz 5GBand 1: 5150 ~ 5250 MHz, 5GBand 4: 5725 ~ 5850 MHz
<b>Conducted RF Power</b>	GPRS 850 : 33.0 dBm GPRS 1900: 30.0 dBm WCDMA Band 2: 24.0 dBm WCDMA Band 4: 24.0 dBm WCDMA Band 5: 24.0 dBm LTE Band 2: 24.5 dBm LTE Band 4: 25.5 dBm LTE Band 5: 24.5 dBm LTE Band 7: 23.0 dBm LTE Band 12: 25.0 dBm LTE Band 66: 25.0 dBm



	LTE Band 71: 25.0 dBm Bluetooth: 13.0 dBm Bluetooth LE: -3.0 dBm Wi-Fi 2.4GHz: 9.5 dBm Wi-Fi 5GHz Band 1: 12.0 dBm ; Wi-Fi 5GHz Band 4: 11.5 dBm
<b>Power Source</b>	DC 3.8V from battery or 5V from Adapter

**Note:**

1. EUT none voice function.
2. All measurement and test data in this report was gathered from production sample serial number :  
 RXZ210830006-01(Assigned by BACL).The EUT supplied by the applicant was received on 2021/08/30.

## **REFERENCE, STANDARDS, AND GUIDELINES**

---

### **FCC :**

The Report and Order requires routine SAR evaluation prior to equipment authorization of portable transmitter devices, including portable telephones. For consumer products, the applicable limit is 1.6 mW/g as recommended by the ANSI/IEEE standard C95.1 [6] for an uncontrolled environment (Paragraph 65). According to the Supplement C of OET Bulletin 65 "Evaluating Compliance with FCC Guide-lines for Human Exposure to Radio frequency Electromagnetic Fields", released on Jun 29, 2001 by the FCC, the device should be evaluated at maximum output power (radiated from the antenna) under "worst-case" conditions for normal or intended use, incorporating normal antenna operating positions, device peak performance frequencies and positions for maximum RF energy coupling.

This report describes the methodology and results of experiments performed on wireless data terminal. The objective was to determine if there is RF radiation and if radiation is found, what is the extent of radiation with respect to safety limits. SAR (Specific Absorption Rate) is the measure of RF exposure determined by the amount of RF energy absorbed by human body (or its parts) – to determine how the RF energy couples to the body or head which is a primary health concern for body worn devices. The limit below which the exposure to RF is considered safe by regulatory bodies in North America is 1.6 mW/g average over 1 gram of tissue mass.

### **CE :**

The order requires routine SAR evaluation prior to equipment authorization of portable transmitter devices, including portable telephones. For consumer products, the applicable limit is 2.0mW/g as recommended by EN62209-1 for an uncontrolled environment. According to the Standard, the device should be evaluated at maximum output power (radiated from the antenna) under "worst-case" conditions for normal or intended use, incorporating normal antenna operating positions, device peak performance frequencies and positions for maximum RF energy coupling.

This report describes the methodology and results of experiments performed on wireless data terminal. The objective was to determine if there is RF radiation and if radiation is found, what is the extent of radiation with respect to safety limits. SAR (Specific Absorption Rate) is the measure of RF exposure determined by the amount of RF energy absorbed by human body (or its parts) – to determine how the RF energy couples to the body or head which is a primary health concern for body worn devices. The limit below which the exposure to RF is considered safe by regulatory bodies in Europe is 2.0mW/g average over 10 gram of tissue mass.

The test configurations were laid out on a specially designed test fixture to ensure the reproducibility of measurements. Each configuration was scanned for SAR. Analysis of each scan was carried out to characterize the above effects in the device.

**SAR Limits**

**FCC Limit**

EXPOSURE LIMITS	SAR (W/kg)	
	(General Population / Uncontrolled Exposure Environment)	(Occupational / Controlled Exposure Environment)
Spatial Average (averaged over the whole body)	0.08	0.4
Spatial Peak (averaged over any 1 g of tissue)	<b>1.60</b>	8.0
Spatial Peak (hands/wrists/feet/ankles averaged over 10 g)	<b>4.0</b>	20.0

**CE Limit**

EXPOSURE LIMITS	SAR (W/kg)	
	(General Population / Uncontrolled Exposure Environment)	(Occupational / Controlled Exposure Environment)
Spatial Average (averaged over the whole body)	0.08	0.4
Spatial Peak (averaged over any 10 g of tissue)	<b>2.0</b>	10
Spatial Peak (hands/wrists/feet/ankles averaged over 10 g)	4.0	20.0

Population/Uncontrolled Environments are defined as locations where there is the exposure of individual who have no knowledge or control of their exposure.

Occupational/Controlled Environments are defined as locations where there is exposure that maybe incurred by people who are aware of the potential for exposure (i.e. as a result of employment or occupation).

General Population/Uncontrolled environments Spatial Peak limit 1.6W/kg (FCC) & 2.0 W/kg (CE) applied to the EUT.

## DESCRIPTION OF TEST SYSTEM

These measurements were performed with the automated near-field scanning system DASY6 from Schmid & Partner Engineering AG (SPEAG) which is the Fifth generation of the system shown in the figure hereinafter:

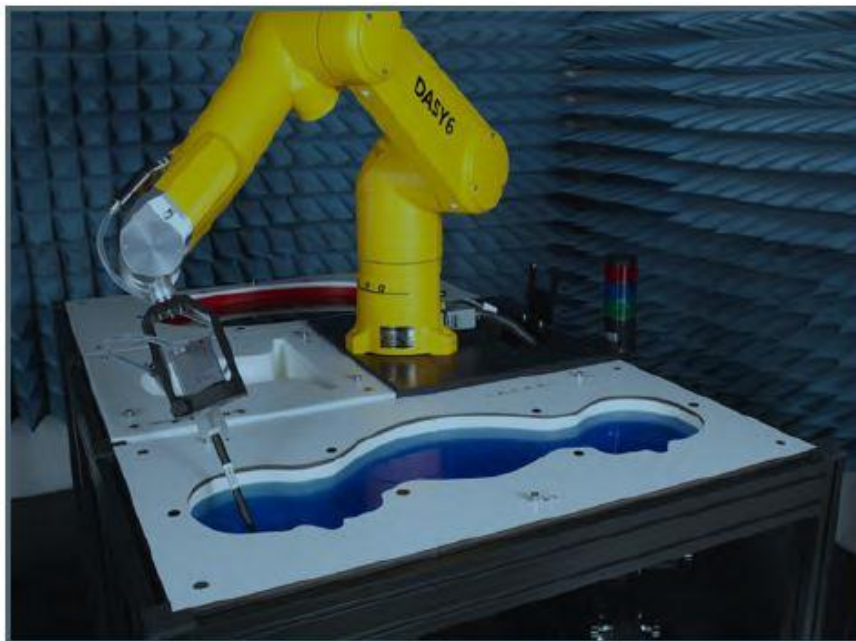

### DASY6 System Description

The DASY6 system for performing compliance tests consists of the following items:

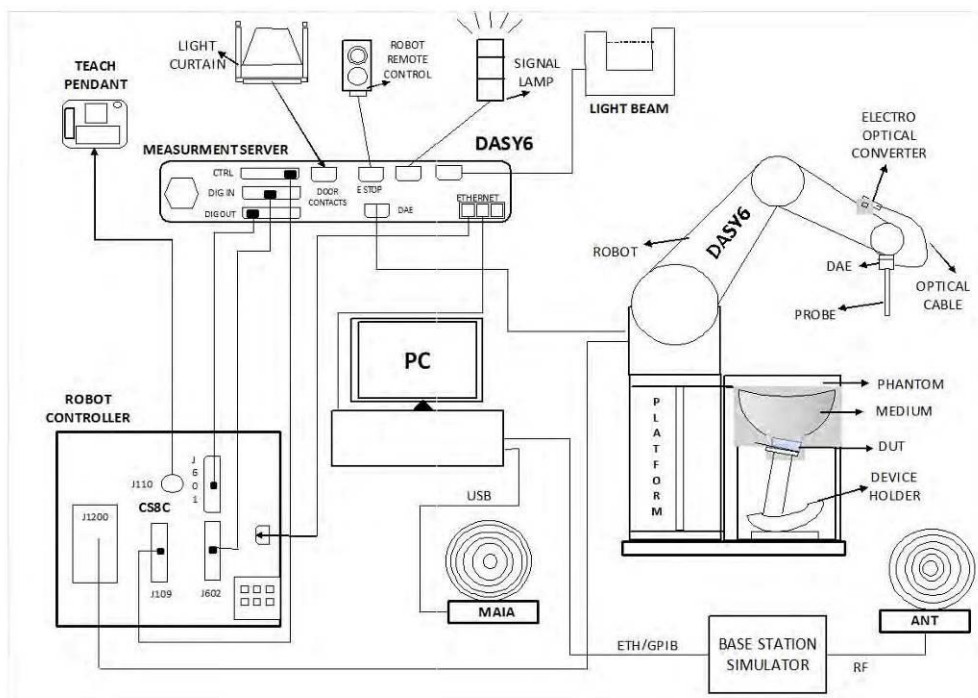

- A standard high precision 6-axis robot (Staubli TX=RX family) with controller, teach pendant and software. An arm extension for accommodating the data acquisition electronics (DAE).
- An isotropic field probe optimized and calibrated for the targeted measurement.
- A data acquisition electronics (DAE) which performs the signal application, signal multiplexing, AD-conversion, offset measurements, mechanical surface detection, collision detection, etc. The unit is battery powered with standard or rechargeable batteries. The signal is optically transmitted to the EOC.
- The Electro-optical converter (EOC) performs the conversion from optical to electrical signals for the digital communication to the DAE. To use optical surface detection, a special version of the EOC is required. The EOC signal is transmitted to the measurement server.
- The function of the measurement server is to perform the time critical tasks such as signal filtering, control of the robot operation and fast movement interrupts.
- The Light Beam used is for probe alignment. This improves the (absolute) accuracy of the probe positioning.
- A computer running Win7 professional operating system and the DASY52 software.
- Remote control and teach pendant as well as additional circuitry for robot safety such as warning lamps, etc.
- The phantom, the device holder and other accessories according to the targeted measurement.

### **DASY6 Measurement Server**

The DASY6 measurement server is based on a PC/104 CPU board with a 400 MHz Intel ULV Celeron, 128 MB chip-disk and 128 MB RAM. The necessary circuits for communication with the DAE4 (or DAE3) electronics box, as well as the 16-bit AD converter system for optical detection and digital I/O interface are contained on the DASY6 I/O board, which is directly connected to the PC/104 bus of the CPU board.



The measurement server performs all real-time data evaluations of field measurements and surface detection, controls robot movements, and handles safety operations. The PC operating system cannot interfere with these time-critical processes. All connections are supervised by a watchdog, and disconnection of any of the cables to the measurement server will automatically disarm the robot and disable all program- controlled robot movements. Furthermore, the measurement server is equipped with an expansion port, which is reserved for future applications. Please note that this expansion port does not have a standardized pinout, and therefore only devices provided by SPEAG can be connected. Connection of devices from any other supplier could seriously damage the measurement server.

### **Data Acquisition Electronics**

The data acquisition electronics (DAE4) consist of a highly sensitive electrometer-grade preamplifier with auto-zeroing, a channel and gain-switching multiplexer, a fast 16 bit AD-converter and a command decoder with a control logic unit. Transmission to the measurement server is accomplished through an optical downlink for data and status information, as well as an optical uplink for commands and the clock.

The mechanical probe mounting device includes two different sensor systems for frontal and sideways probe contacts. They are used for mechanical surface detection and probe collision detection.

The input impedance of both the DAE4 as well as of the DAE3 box is 200MOhm; the inputs are symmetrical and floating. Common mode rejection is above 80 dB.

**EX3DV4 E-Field Probes**

<b>Frequency</b>	10 MHz to > 6 GHz Linearity: ± 0.2 dB (30 MHz to 6 GHz)
<b>Directivity</b>	± 0.3 dB in TSL (rotation around probe axis) ± 0.5 dB in TSL (rotation normal to probe axis)
<b>Dynamic Range</b>	10 µW/g to > 100 mW/g Linearity: ± 0.2 dB (noise: typically < 1 µW/g)
<b>Dimensions</b>	Overall length: 337 mm (Tip: 20 mm) Tip diameter: 2.5 mm (Body: 12 mm) Typical distance from probe tip to dipole centers: 1 mm
<b>Application</b>	High precision dosimetric measurements in any exposure scenario (e.g., very strong gradient fields); the only probe that enables compliance testing for frequencies up to 6 GHz with precision of better 30%.
<b>Compatibility</b>	DASY3, DASY4, DASY52 SAR and higher, EASY4/MRI

**SAM Twin Phantom**

The SAM Twin Phantom (shown in front of DASY6) is a fiberglass shell phantom with shell thickness 2 mm, except in the ear region where the thickness is increased to 6 mm. The phantom has three measurement areas: 1) Left Head, 2) Right Head, and 3) Flat Section. For larger devices, the use of the ELI-Phantom (shown behind DASY6) is required. For devices such as glasses with a wireless link, the Face Down Phantom is the most suitable (between the SAM Twin and ELI phantoms).

When the phantom is mounted inside allocated slot of the DASY6 platform, phantom reference points can be taught directly in the DASY5 V5.2 software. When the DASY6 platform is used to mount the

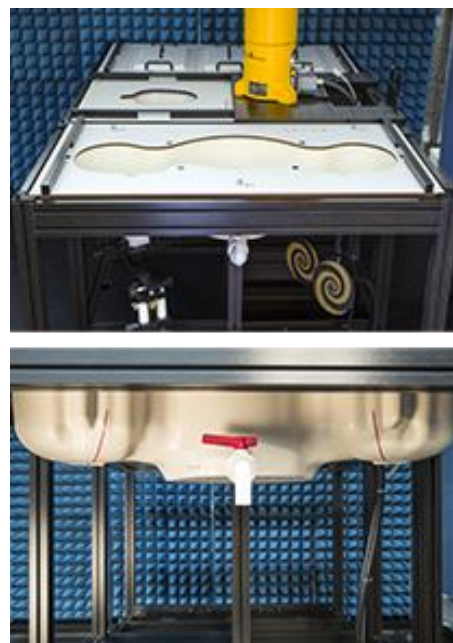

Phantom, some of the phantom teaching points cannot be reached by the robot in DASY5 V5.2. A special tool called P1a-P2aX-Former is provided to transform two of the three points, P1 and P2, to reachable locations. To use these new teaching points, a revised phantom configuration file is required.

In addition to our standard broadband liquids, the phantom can be used with the following tissue simulating liquids:

Sugar-water-based liquids can be left permanently in the phantom. Always cover the liquid when the system is not in use to prevent changes in liquid parameters due to water evaporation. DGBE-based liquids should be used with care. As DGBE is a softener for most plastics, the liquid should be taken out of the phantom, and the phantom should be dried when the system is not in use (desirable at least once a week).

Do not use other organic solvents without previously testing the solvent resistivity of the phantom. Approximately 25 liters of liquid is required to fill the SAM Twin phantom.

### **ELI Phantom**

The ELI phantom is intended for compliance testing of handheld and body-mounted wireless devices in the frequency range of 30MHz to 6 GHz. ELI is fully compatible with the latest draft of the standard IEC 62209-2 and the use of all known tissue simulating liquids. ELI has been optimized for performance and can be integrated into a SPEAG standard phantom table. A cover is provided to prevent evaporation of water and changes in liquid parameters. Reference markings on the phantom allow installation of the complete setup, including all predefined phantom positions and measurement grids, by teaching three points.

The phantom can be used with the following tissue simulating liquids:

- Sugar-water-based liquids can be left permanently in the phantom. Always cover the liquid when the system is not in use to prevent changes in liquid parameters due to water evaporation.
- DGBE-based liquids should be used with care. As DGBE is a softener for most plastics, the liquid should be taken out of the phantom, and the phantom should be dried when the system is not in use (desirable at least once a week).
- Do not use other organic solvents without previously testing the solvent resistivity of the phantom.

Approximately 25 liters of liquid is required to fill the ELI phantom

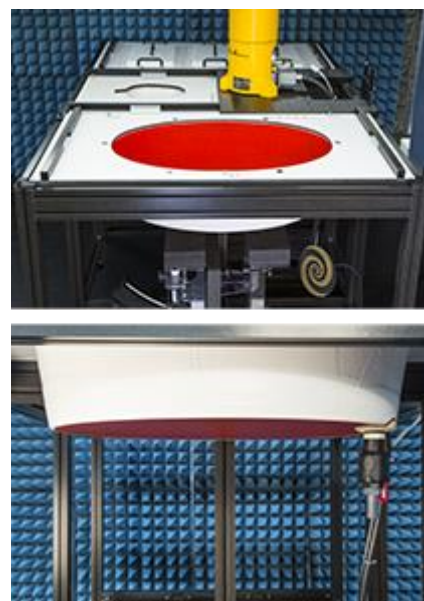

**Robots**

The DASY6 system uses the high-precision industrial robots TX60L, TX90XL, and RX160L from StaubliSA (France). The TX robot family - the successor of the well-known RX robot family - continues to offer the features important for DASY6 applications:

- High precision (repeatability 0.02mm)
- High reliability (industrial design)
- Low maintenance costs (virtually maintenance free due to direct drive gears; no belt drives)
- Jerk-free straight movements (brushless synchrony motors; no stepper motors)
- Low ELF interference (motor control fields shielded via the closed metallic construction shields)

The robots are controlled by the Staubli CS8c robot controllers. All information regarding the use and maintenance of the robot arm and the robot controller is provided

**Area Scans**

Area scans are defined prior to the measurement process being executed with a user defined variable spacing between each measurement point (integral) allowing low uncertainty measurements to be conducted. Scans defined for FCC applications utilize a 15mm<sup>2</sup> step integral, with 1.5mm interpolation used to locate the peak SAR area used for zoom scan assessments.

Where the system identifies multiple SAR peaks (which are within 25% of peak value) the system will provide the user with the option of assessing each peak location individually for zoom scan averaging.

**Zoom Scan (Cube Scan Averaging)**

The averaging zoom scan volume utilized in the DASY6 software is in the shape of a cube and the side dimension of a 1 g or 10 g mass is dependent on the density of the liquid representing the simulated tissue. A density of 1000 kg/m<sup>3</sup> is used to represent the head and body tissue density and not the phantom liquid density, in order to be consistent with the definition of the liquid dielectric properties, i.e. the side length of the 1g cube is 10mm, with the side length of the 10g cube is 21.5mm.

When the cube intersects with the surface of the phantom, it is oriented so that 3 vertices touch the surface of the shell or the center of a face is tangent to the surface. The face of the cube closest to the surface is modified in order to conform to the tangent surface.

The zoom scan integer steps can be user defined so as to reduce uncertainty, but normal practice for typical test applications (including FCC) utilize a physical step of 7 x 7 x 7 (5mmx5mmx5mm) providing a volume of 30 mm in the X & Y & Z axis.



## **Recommended Tissue Dielectric Parameters for Head and Body**

### **Tissue Dielectric Parameters for Head and Body Phantoms**

The head tissue dielectric parameters recommended by the IEC 62209-1:2016

### **Recommended Tissue Dielectric Parameters for Head liquid**

**Table A.3 – Dielectric properties of the head tissue-equivalent liquid**

Frequency MHz	Relative permittivity $\epsilon_r$	Conductivity ( $\sigma$ ) S/m
300	45,3	0,87
450	43,5	0,87
<i>750</i>	<i>41,9</i>	<i>0,89</i>
835	41,5	0,90
900	41,5	0,97
1 450	40,5	1,20
<i>1 500</i>	<i>40,4</i>	<i>1,23</i>
<i>1 640</i>	<i>40,2</i>	<i>1,31</i>
<i>1 750</i>	<i>40,1</i>	<i>1,37</i>
1 800	40,0	1,40
1 900	40,0	1,40
2 000	40,0	1,40
<i>2 100</i>	<i>39,8</i>	<i>1,49</i>
<i>2 300</i>	<i>39,5</i>	<i>1,67</i>
2 450	39,2	1,80
<i>2 600</i>	<i>39,0</i>	<i>1,96</i>
3 000	38,5	2,40
<i>3 500</i>	<i>37,9</i>	<i>2,91</i>
<i>4 000</i>	<i>37,4</i>	<i>3,43</i>
<i>4 500</i>	<i>36,8</i>	<i>3,94</i>
<i>5 000</i>	<i>36,2</i>	<i>4,45</i>
<i>5 200</i>	<i>36,0</i>	<i>4,66</i>
<i>5 400</i>	<i>35,8</i>	<i>4,86</i>
<i>5 600</i>	<i>35,5</i>	<i>5,07</i>
<i>5 800</i>	<i>35,3</i>	<i>5,27</i>
<i>6 000</i>	<i>35,1</i>	<i>5,48</i>

NOTE For convenience, permittivity and conductivity values at those frequencies which are not part of the original data provided by Drossos et al. [33] or the extension to 5 800 MHz are provided (i.e. the values shown *in italics*). These values were linearly interpolated between the values in this table that are immediately above and below these values, except the values at 6 000 MHz that were linearly extrapolated from the values at 3 000 MHz and 5 800 MHz.

# EQUIPMENT LIST AND CALIBRATION

## Equipment's List & Calibration Information

Equipment	Model	S/N	Calibration Date	Calibration Due Date
Robot	TX90	5N26A1	N.C.R	N.C.R
DASY5 Test Software	DASY5.2	N/A	N.C.R	N.C.R
DASY6 Measurement Server	DASY 6.0	1588	N/A	N/A
Data Acquisition Electronics	DAE4	1561	2020/11/23	2021/11/22
E-Field Probe	EX3DV4	7520	2020/11/16	2021/11/15
Dipole, 750 MHz	D750V3	1079	2020/11/06	2023/11/05
Dipole, 835 MHz	D835V2	454	2020/11/18	2023/11/17
Dipole, 1800 MHz	D1800V2	2d207	2020/11/09	2023/11/08
Dipole, 1900 MHz	D1900V2	5d207	2020/11/11	2023/11/10
Dipole, 2450 MHz	D2450V2	903	2020/11/10	2023/11/09
Dipole, 2600 MHz	D2600V2	1174	2020/11/18	2023/11/17
Dipole, 5GHz	D5GHzV2	1040	2021/06/03	2024/06/02
Twin SAM	Twin SAM V5.0	1368	N/A	N/A
Twin SAM	Twin SAM V8.0	1953	N/A	N/A
Twin ELI	Twin ELI V8.0	2088	N/A	N/A
Simulated Tissue 750 MHz Head	TS-750-H	/	Each Time	/
Simulated Tissue 835 MHz Head	TS-835-H	/	Each Time	/
Simulated Tissue 1800 MHz Head	TS-1800-H	/	Each Time	/
Simulated Tissue 1900 MHz Head	TS-1900-H	/	Each Time	/
Simulated Tissue 2450 MHz Head	TS-2450-H	/	Each Time	/
Simulated Tissue 2600 MHz Head	TS-2600-H	/	Each Time	/
Simulated Tissue 5GHz Head	TS-5GHz-H	/	Each Time	/
Wideband Radio Communication Tester	CMU-200	106868	2021/04/07	2022/04/06
Functional radio communication tester	CMW 290	101741	2021/08/07	2022/08/06
Mounting Device	N/A	SD 000 H01 KA	N/A	N/A
Network Analyzer	E5063A	MY54402093	2020/12/29	2021/12/28
Dielectric probe kit	85070B	50207	/	/
Signal Generator	8648C	3537A01745	2020/12/30	2021/12/29
MXG Analog Signal Generator	N5183A	MY50140407	2020/12/30	2021/12/29
Power Meter	E4418B	GB43312279	2020/12/30	2021/12/29
Power Sensor	E9300A	US39210953	2021/05/05	2022/05/04
Power Amplifier	ZVE-8G+	365701647	2021/1/8	2022/1/7
Power Amplifier	ZHL-42W+	329401642	2021/1/8	2022/1/7

Temperature and Humidity Recorder	HTC-1	005	2020/10/30	2021/10/29
Directional Coupler	488Z	810	N.C.R	N.C.R
Attenuator	20dB, 100W	1453	N.C.R	N.C.R

# SAR MEASUREMENT SYSTEM VERIFICATION

## Liquid Verification

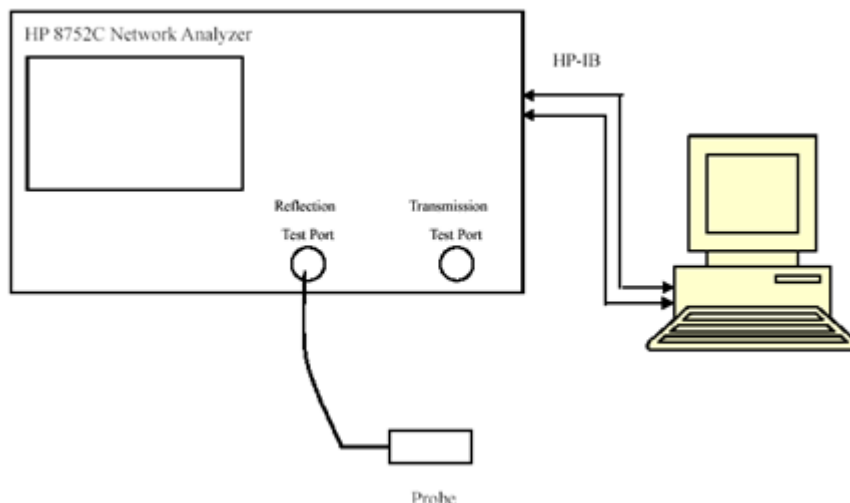

Liquid Verification Setup Block Diagram

## Liquid Verification Results

Test Date	Frequency (MHz)	Liquid Type	Liquid parameter		Target Value		Delta (%)		Tolerance (%)
			$\sigma$ (S/m)	$\epsilon_r$	$\sigma$ (S/m)	$\epsilon_r$	$\sigma$ (S/m)	$\epsilon_r$	
2021/08/31	2450	HSL	1.783	39.136	1.80	39.2	4.09	1.13	$\pm 5$
	2437	HSL	1.775	39.193	1.79	39.22	-0.84	-0.07	$\pm 5$
	2450	HSL	1.783	39.136	1.80	39.2	4.09	1.13	$\pm 5$

Test Date	Frequency (MHz)	Liquid Type	Liquid parameter		Target Value		Delta (%)		Tolerance (%)
			$\sigma$ (S/m)	$\epsilon_r$	$\sigma$ (S/m)	$\epsilon_r$	$\sigma$ (S/m)	$\epsilon_r$	
2021/08/31	5200	HSL	4.465	35.807	4.66	36.0	-4.18	-0.54	$\pm 5$
	5200	HSL	4.465	35.807	4.66	36.0	-4.18	-0.54	$\pm 5$
	5210	HSL	4.648	35.738	4.67	35.99	-0.47	-0.70	$\pm 5$

Test Date	Frequency (MHz)	Liquid Type	Liquid parameter		Target Value		Delta (%)		Tolerance (%)
			$\sigma$ (S/m)	$\epsilon_r$	$\sigma$ (S/m)	$\epsilon_r$	$\sigma$ (S/m)	$\epsilon_r$	
2021/09/01	5800	HSL	5.379	34.47	5.27	35.3	2.07	-2.35	$\pm 5$
	5785	HSL	5.379	34.572	5.26	35.32	2.26	-2.12	$\pm 5$
	5775	HSL	5.384	34.578	5.25	35.33	2.55	-2.13	$\pm 5$

Test Date	Frequency (MHz)	Liquid Type	Liquid parameter		Target Value		Delta (%)		Tolerance (%)
			$\sigma$ (S/m)	$\epsilon_r$	$\sigma$ (S/m)	$\epsilon_r$	$\sigma$ (S/m)	$\epsilon_r$	
2021/09/10	1900	HSL	1.438	39.488	1.4	40	2.71	-1.28	$\pm 5$
	1852.4	HSL	1.407	39.552	1.4	40	0.5	-1.12	$\pm 5$
	1860	HSL	1.411	39.568	1.4	40	0.79	-1.08	$\pm 5$
	1880	HSL	1.422	39.534	1.4	40	1.57	-1.17	$\pm 5$
	1907.6	HSL	1.445	39.438	1.4	40	3.21	-1.405	$\pm 5$

Test Date	Frequency (MHz)	Liquid Type	Liquid parameter		Target Value		Delta (%)		Tolerance (%)
			$\sigma$ (S/m)	$\epsilon_r$	$\sigma$ (S/m)	$\epsilon_r$	$\sigma$ (S/m)	$\epsilon_r$	
2021/09/11	1800	HSL	1.376	41.334	1.4	40	-1.71	3.34	$\pm 5$
	1712.4	HSL	1.323	40.217	1.35	40.14	-2.00	0.19	$\pm 5$
	1732.6	HSL	1.336	40.171	1.36	40.11	-1.76	0.15	$\pm 5$
	1752.6	HSL	1.348	40.128	1.37	40.07	-1.61	0.14	$\pm 5$
	1720	HSL	1.329	40.198	1.35	40.13	-1.56	0.17	$\pm 5$
	1732.5	HSL	1.337	40.171	1.36	40.13	-1.70	0.10	$\pm 5$
	1745	HSL	1.343	40.141	1.97	40.10	-1.31	0.10	$\pm 5$

Test Date	Frequency (MHz)	Liquid Type	Liquid parameter		Target Value		Delta (%)		Tolerance (%)
			$\sigma$ (S/m)	$\epsilon_r$	$\sigma$ (S/m)	$\epsilon_r$	$\sigma$ (S/m)	$\epsilon_r$	
2021/09/13	835	HSL	0.918	40.093	0.9	41.5	2.00	-3.39	$\pm 5$
	836.6	HSL	0.919	40.118	0.9	41.5	2.11	-3.33	$\pm 5$
	836.4	HSL	0.919	40.104	0.9	41.5	2.11	-3.36	$\pm 5$
	836.5	HSL	0.919	40.106	0.9	41.5	2.11	-3.36	$\pm 5$

Test Date	Frequency (MHz)	Liquid Type	Liquid parameter		Target Value		Delta (%)		Tolerance (%)
			$\sigma$ (S/m)	$\epsilon_r$	$\sigma$ (S/m)	$\epsilon_r$	$\sigma$ (S/m)	$\epsilon_r$	
2021/09/14	750	HSL	0.904	40.077	0.89	41.9	1.57	-4.35	$\pm 5$
	707.5	HSL	0.89	40.239	0.89	42.13	0	-4.49	$\pm 5$

Test Date	Frequency (MHz)	Liquid Type	Liquid parameter		Target Value		Delta (%)		Tolerance (%)
			$\sigma$ (S/m)	$\epsilon_r$	$\sigma$ (S/m)	$\epsilon_r$	$\sigma$ (S/m)	$\epsilon_r$	
2021/09/15	750	HSL	0.916	42.911	0.88	42.43	4.09	1.13	$\pm 5$
	680.5	HSL	0.891	43.255	0.89	42.27	0.11	2.26	$\pm 5$

Test Date	Frequency (MHz)	Liquid Type	Liquid parameter		Target Value		Delta (%)		Tolerance (%)
			$\sigma$ (S/m)	$\epsilon_r$	$\sigma$ (S/m)	$\epsilon_r$	$\sigma$ (S/m)	$\epsilon_r$	
2021/09/15	2600	HSL	1.956	39.519	1.96	39.0	-0.20	1.33	$\pm 5$
	2535	HSL	1.891	39.639	1.89	39.09	0.05	1.40	$\pm 5$

### System Accuracy Verification

Prior to the assessment, the system validation kit was used to test whether the system was operating within its specifications of  $\pm 10\%$ . The validation results are tabulated below. And also the corresponding SAR plot is attached as well in the SAR plots files.

The spacing distances in the **System Verification Setup Block Diagram** is given by the following:

- a)  $s = 15 \text{ mm} \pm 0,2 \text{ mm}$  for  $300 \text{ MHz} \leq f \leq 1 \text{ 000 MHz}$ ;
- b)  $s = 10 \text{ mm} \pm 0,2 \text{ mm}$  for  $1 \text{ 000 MHz} < f \leq 3 \text{ 000 MHz}$ ;
- c)  $s = 10 \text{ mm} \pm 0,2 \text{ mm}$  for  $3 \text{ 000 MHz} < f \leq 6 \text{ 000 MHz}$ .

### System Verification Setup Block Diagram

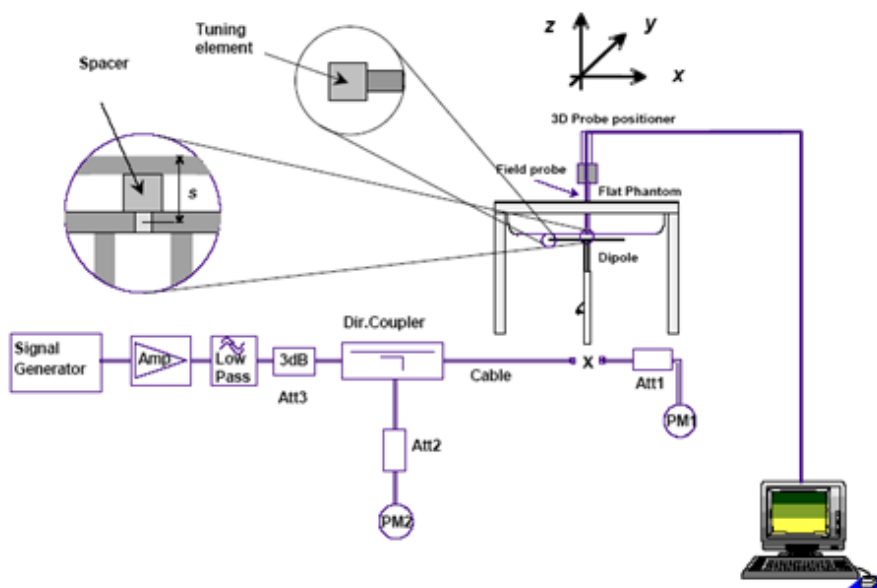

System Accuracy Check Results

Test Date	Frequency Band (MHz)	Liquid Type	Input Power (mW)	Measured SAR (W/kg)		Target Value (W/kg)		Normalized to 1W (W/kg)		Delta (%)	Tolerance (%)
				1g	12.0	1g	52.2	1g	48.0		
2021/08/31	2450	HSL	250	1g	12.0	1g	52.2	1g	48.0	-8.05	±10
				10g	5.61	10g	24.0	10g	22.44	-9.15	±10
2021/08/31	5200	HSL	100	1g	8.25	1g	76.9	1g	82.5	7.28	±10
				10g	2.28	10g	21.8	10g	22.8	4.59	±10
2021/09/01	5800	HSL	100	1g	8.11	1g	77.5	1g	81.1	4.65	±10
				10g	2.23	10g	21.9	10g	2.23	1.83	±10
2021/09/10	1900	HSL	250	1g	9.97	1g	40.10	1g	39.88	-0.55	±10
				10g	5.07	10g	20.80	10g	20.28	-2.50	±10
2021/09/11	1800	HSL	250	1g	9.51	1g	38.90	1g	38.04	-2.21	±10
				10g	4.94	10g	20.30	10g	19.76	-2.66	±10
2021/09/13	835	HSL	250	1g	2.29	1g	9.38	1g	9.16	1.47	±10
				10g	1.47	10g	6.06	10g	5.88	-2.97	±10
2021/09/14	750	HSL	250	1g	2.11	1g	8.25	1g	8.44	2.30	±10
				10g	1.37	10g	5.38	10g	5.48	1.86	±10
2021/09/15	750	HSL	250	1g	2.2	1g	8.25	1g	8.8	6.67	±10
				10g	1.45	10g	5.38	10g	5.8	7.81	±10
2021/09/15	2600	HSL	250	1g	14.3	1g	55.3	1g	57.2	-3.44	±10
				10g	6.44	10g	24.6	10g	25.76	-4.72	±10

**Note:**

- 1) For Frequency  $\leq 3\text{GHz}$ , the power inputted to dipole is 0.25Watt; the SAR values are normalized to 1 Watt forward power by multiplying 4 times.
- 2) For Frequency  $> 3\text{GHz}$ , the power inputted to dipole is 0.10Watt; the SAR values are normalized to 1 Watt forward power by multiplying 10 times.



## SAR SYSTEM VALIDATION DATA

Test Laboratory: BACL . SAR Testing Lab

### System Check\_Body\_2450MHz

**DUT: D2450V2-903**

Communication System: UID 0, CW (0); Frequency: 2450 MHz;Duty Cycle: 1:1

Medium: HSL2450 Medium parameters used:  $f = 2450$  MHz;  $\sigma = 1.783$  S/m;  $\epsilon_r = 39.136$ ;  $\rho = 1000$  kg/m<sup>3</sup>

DASY5 Configuration:

- Probe: EX3DV4 - SN7520; ConvF(7.57, 7.57, 7.57) @ 2450 MHz; Calibrated: 11/16/2020
- Sensor-Surface: 3mm (Mechanical Surface Detection)
- Electronics: DAE4 Sn1561; Calibrated: 11/23/2020
- Phantom: Twin-SAM V8.0 (20deg probe tilt)-Right; Type: QD 000 P40 CB; Serial: 1368
- Measurement SW: DASY52, Version 52.10 (4);SEMCAD X Version 14.6.14 (7483)

**Pin=250mW/Area Scan (61x61x1):** Interpolated grid: dx=1.200 mm, dy=1.200 mm

Maximum value of SAR (interpolated) = 16.1 W/kg

**Pin=250mW/Zoom Scan (7x7x7)/Cube 0:** Measurement grid: dx=5mm, dy=5mm, dz=5mm

Reference Value = 89.99 V/m; Power Drift = 0.04 dB

Peak SAR (extrapolated) = 24.4 W/kg

**SAR(1 g) = 12 W/kg; SAR(10 g) = 5.61 W/kg**

Smallest distance from peaks to all points 3 dB below = 9 mm

Ratio of SAR at M2 to SAR at M1 = 51%

Maximum value of SAR (measured) = 15.9 W/kg

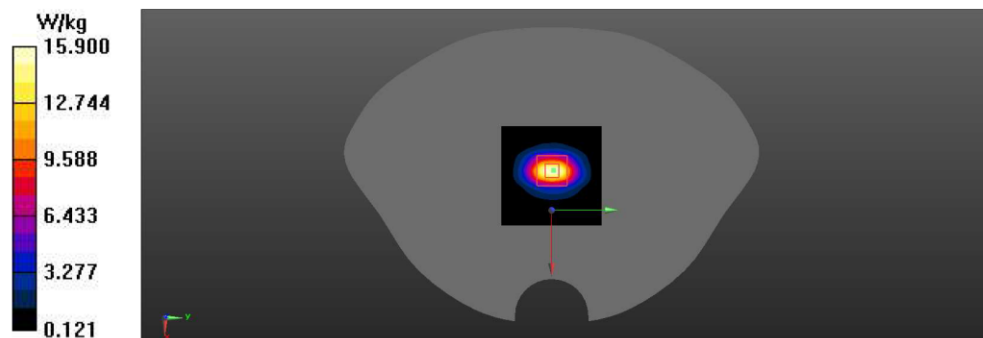

Test Laboratory: BACL . SAR Testing Lab

**System Check\_Head\_5200MHz**

**DUT: D5GHzV2-1040-5200**

Communication System: UID 0, CW (0); Frequency: 5200 MHz;Duty Cycle: 1:1  
Medium: HSL\_5G Medium parameters used: f = 5200 MHz;  $\sigma = 4.645$  S/m;  $\epsilon_r = 35.807$ ;  $\rho = 1000$  kg/m<sup>3</sup>

- DASY5 Configuration:
- Probe: EX3DV4 - SN7520; ConvF(5.61, 5.61, 5.61) @ 5200 MHz; Calibrated: 11/16/2020
  - Sensor-Surface: 1.4mm (Mechanical Surface Detection)
  - Electronics: DAE4 Sn1561; Calibrated: 11/23/2020
  - Phantom: Twin-SAM V8.0 (20deg probe tilt)-Right; Type: QD 000 P40 CB; Serial: 1368
  - Measurement SW: DASY52, Version 52.10 (4);SEMCAD X Version 14.6.14 (7483)

**Pin=100mW/Area Scan (71x71x1):** Interpolated grid: dx=1.000 mm, dy=1.000 mm  
Maximum value of SAR (interpolated) = 19.7 W/kg

**Pin=100mW/Zoom Scan (7x7x7)/Cube 0:** Measurement grid: dx=4mm, dy=4mm, dz=1.4mm  
Reference Value = 71.32 V/m; Power Drift = 0.06 dB  
Peak SAR (extrapolated) = 34.2 W/kg  
**SAR(1 g) = 8.25 W/kg; SAR(10 g) = 2.28 W/kg**  
Smallest distance from peaks to all points 3 dB below = 7.4 mm  
Ratio of SAR at M2 to SAR at M1 = 64%  
Maximum value of SAR (measured) = 20.5 W/kg

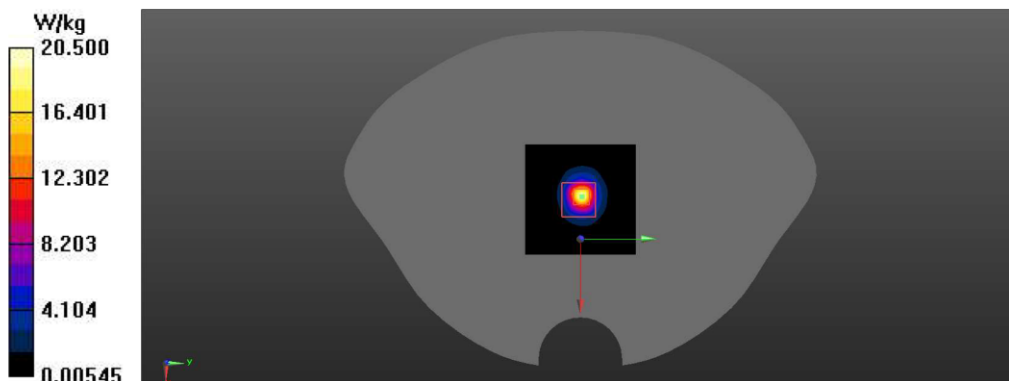

Test Laboratory: BACL . SAR Testing Lab

**System Check\_Head\_5800MHz**

**DUT: D5GHzV2-1040-5800**

Communication System: UID 0, CW (0); Frequency: 5800 MHz;Duty Cycle: 1:1  
Medium: HSL\_5G Medium parameters used:  $f = 5800$  MHz;  $\sigma = 5.379$  S/m;  $\epsilon_r = 34.47$ ;  $\rho = 1000$  kg/m<sup>3</sup>

DASY5 Configuration:

- Probe: EX3DV4 - SN7520; ConvF(5.08, 5.08, 5.08) @ 5800 MHz; Calibrated: 11/16/2020
- Sensor-Surface: 1.4mm (Mechanical Surface Detection)
- Electronics: DAE4 Sn1561; Calibrated: 11/23/2020
- Phantom: Twin-SAM V8.0 (20deg probe tilt)-Right; Type: QD 000 P40 CB; Serial: 1368
- Measurement SW: DASY52, Version 52.10 (4);SEMCAD X Version 14.6.14 (7483)

**Pin=100mW/Area Scan (71x71x1):** Interpolated grid: dx=1.000 mm, dy=1.000 mm  
Maximum value of SAR (interpolated) = 21.1 W/kg

**Pin=100mW/Zoom Scan (7x7x7)/Cube 0:** Measurement grid: dx=4mm, dy=4mm, dz=1.4mm  
Reference Value = 65.95 V/m; Power Drift = 0.10 dB  
Peak SAR (extrapolated) = 38.0 W/kg  
**SAR(1 g) = 8.11 W/kg; SAR(10 g) = 2.23 W/kg**  
Smallest distance from peaks to all points 3 dB below = 7.2 mm  
Ratio of SAR at M2 to SAR at M1 = 60.2%  
Maximum value of SAR (measured) = 20.8 W/kg

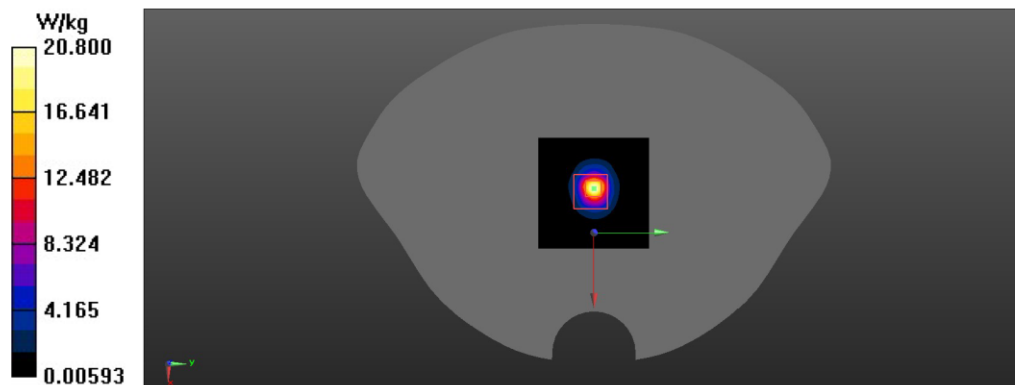

Test Laboratory: BACL . SAR Testing Lab

**System Check\_Head\_1900MHz**

**DUT: D1900V2-5d207**

Communication System: UID 0, CW (0); Frequency: 1900 MHz;Duty Cycle: 1:1

Medium: HSL1900 Medium parameters used:  $f = 1900$  MHz;  $\sigma = 1.438$  S/m;  $\epsilon_r = 39.488$ ;  $\rho = 1000$  kg/m<sup>3</sup>

DASY5 Configuration:

- Probe: EX3DV4 - SN7520; ConvF(8.35, 8.35, 8.35) @ 1900 MHz; Calibrated: 11/16/2020
- Sensor-Surface: 1.4mm (Mechanical Surface Detection)
- Electronics: DAE4 Sn1561; Calibrated: 11/23/2020
- Phantom: Twin-SAM V8.0 (20deg probe tilt)-Right; Type: QD 000 P40 CB; Serial: 1368
- Measurement SW: DASY52, Version 52.10 (4);SEMCAD X Version 14.6.14 (7483)

**Configuration/Pin=250mW 4/Area Scan (61x61x1):** Interpolated grid: dx=1.500 mm, dy=1.500 mm  
 Maximum value of SAR (interpolated) = 16.2 W/kg

**Configuration/Pin=250mW 4/Zoom Scan (5x5x7)/Cube 0:** Measurement grid: dx=8mm, dy=8mm, dz=5mm

Reference Value = 107.4 V/m; Power Drift = -0.02 dB

Peak SAR (extrapolated) = 19.6 W/kg

**SAR(1 g) = 9.97 W/kg; SAR(10 g) = 5.07 W/kg**

Smallest distance from peaks to all points 3 dB below = 9.6 mm

Ratio of SAR at M2 to SAR at M1 = 50.5%

Maximum value of SAR (measured) = 15.9 W/kg

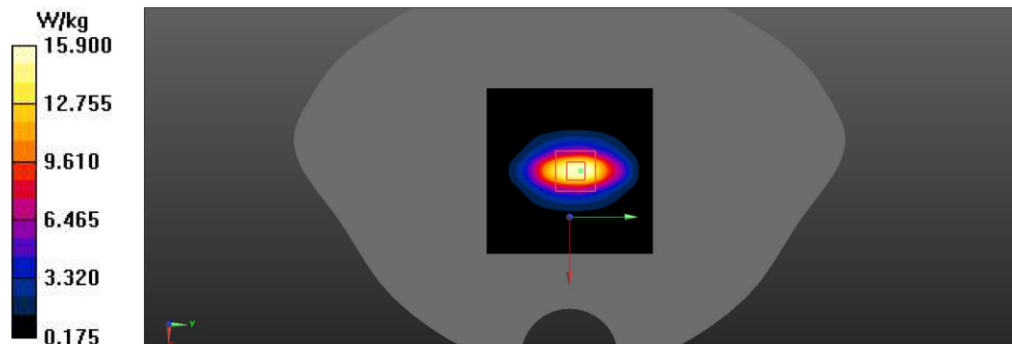

Test Laboratory: BACL SAR Testing Lab

**System Check\_Head\_1800MHz-2**

**DUT: D1800V2-2d207**

Communication System: UID 0, CW (0); Frequency: 1800 MHz; Duty Cycle: 1:1  
Medium: HSL1800 Medium parameters used:  $f = 1800 \text{ MHz}$ ;  $\sigma = 1.376 \text{ S/m}$ ;  $\epsilon_r = 41.334$ ;  $\rho = 1000 \text{ kg/m}^3$

DASY5 Configuration:

- Probe: EX3DV4 - SN7520; ConvF(8.66, 8.66, 8.66) @ 1800 MHz; Calibrated: 11/16/2020
- Sensor-Surface: 1.4mm (Mechanical Surface Detection)
- Electronics: DAE4 Sn1561; Calibrated: 11/23/2020
- Phantom: Twin-SAM V8.0 (20deg probe tilt)-Right; Type: QD 000 P40 CB; Serial: 1368
- Measurement SW: DASY52, Version 52.10 (4); SEMCAD X Version 14.6.14 (7483)

**Pin=250mW/Area Scan (61x61x1):** Interpolated grid:  $dx=1.500 \text{ mm}$ ,  $dy=1.500 \text{ mm}$   
Maximum value of SAR (interpolated) = 15.1 W/kg

**Pin=250mW/Zoom Scan (5x5x7)/Cube 0:** Measurement grid:  $dx=8\text{mm}$ ,  $dy=8\text{mm}$ ,  $dz=5\text{mm}$   
Reference Value = 107.4 V/m; Power Drift = -0.01 dB

Peak SAR (extrapolated) = 18.0 W/kg

**SAR(1 g) = 9.51 W/kg; SAR(10 g) = 4.94 W/kg**

Smallest distance from peaks to all points 3 dB below = 10.7 mm

Ratio of SAR at M2 to SAR at M1 = 53.1%

Maximum value of SAR (measured) = 14.8 W/kg

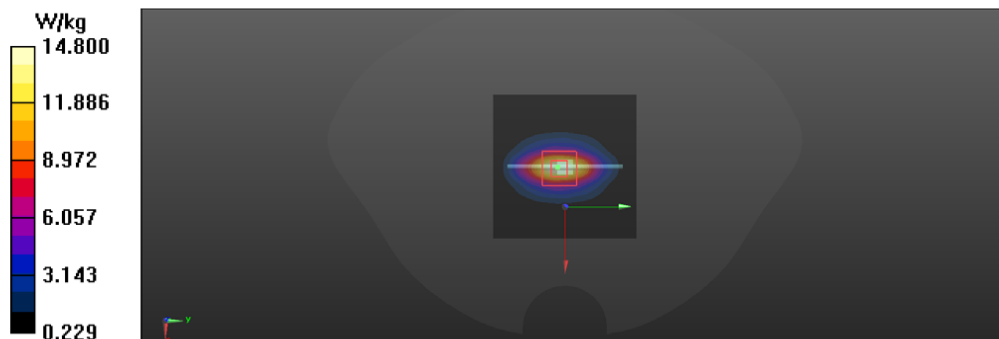

Test Laboratory: BACL . SAR Testing Lab

### System Check\_Head\_835MHz

**DUT: D835V2-454**

Communication System: UID 0, CW; Frequency: 835 MHz; Duty Cycle: 1:1

Medium: HSL835 Medium parameters used:  $f = 835 \text{ MHz}$ ;  $\sigma = 0.918 \text{ S/m}$ ;  $\epsilon_r = 40.093$ ;  $\rho = 1000 \text{ kg/m}^3$

DASY5 Configuration:

- Probe: EX3DV4 - SN7520; ConvF(9.55, 9.55, 9.55) @ 835 MHz; Calibrated: 11/16/2020
- Sensor-Surface: 2mm (Mechanical Surface Detection)
- Electronics: DAE4 Sn1561; Calibrated: 11/23/2020
- Phantom: Twin-SAM V8.0 (20deg probe tilt)-Right; Type: QD 000 P40 CB; Serial: 1368
- Measurement SW: DASY52, Version 52.10 (4); SEMCAD X Version 14.6.14 (7483)

**Pin=250mW/Area Scan (61x61x1):** Interpolated grid:  $dx=1.500 \text{ mm}$ ,  $dy=1.500 \text{ mm}$   
Maximum value of SAR (interpolated) = 2.95 W/kg

**Pin=250mW/Zoom Scan (5x5x7)/Cube 0:** Measurement grid:  $dx=8\text{mm}$ ,  $dy=8\text{mm}$ ,  $dz=5\text{mm}$   
Reference Value = 55.21 V/m; Power Drift = -0.15 dB  
Peak SAR (extrapolated) = 3.55 W/kg  
**SAR(1 g) = 2.29 W/kg; SAR(10 g) = 1.47 W/kg**  
Smallest distance from peaks to all points 3 dB below = 17.2 mm  
Ratio of SAR at M2 to SAR at M1 = 64.6%  
Maximum value of SAR (measured) = 2.94 W/kg

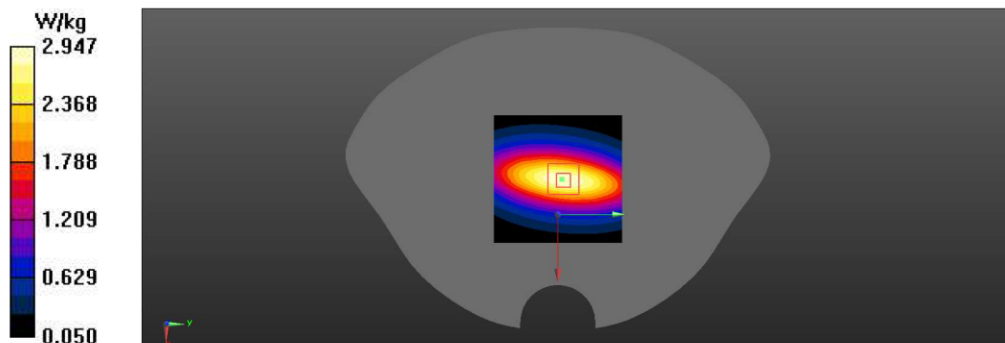

Test Laboratory: BACL . SAR Testing Lab

### System Check\_Head\_750MHz

**DUT: D750V3-1079**

Communication System: UID 0, CW (0); Frequency: 750 MHz; Duty Cycle: 1:1

Medium: HSL750 Medium parameters used:  $f = 750 \text{ MHz}$ ;  $\sigma = 0.904 \text{ S/m}$ ;  $\epsilon_r = 40.077$ ;  $\rho = 1000 \text{ kg/m}^3$

DASY5 Configuration:

- Probe: EX3DV4 - SN7520; ConvF(9.81, 9.81, 9.81) @ 750 MHz; Calibrated: 11/16/2020
- Sensor-Surface: 2mm (Mechanical Surface Detection)
- Electronics: DAE4 Sn1561; Calibrated: 11/23/2020
- Phantom: Twin-SAM V8.0 (20deg probe tilt)-Right; Type: QD 000 P40 CB; Serial: 1368
- Measurement SW: DASY52, Version 52.10 (4); SEMCAD X Version 14.6.14 (7483)

**Pin=250mW/Area Scan (61x61x1):** Interpolated grid:  $dx=1.500 \text{ mm}$ ,  $dy=1.500 \text{ mm}$

Maximum value of SAR (interpolated) = 2.69 W/kg

**Pin=250mW/Zoom Scan (5x5x7)/Cube 0:** Measurement grid:  $dx=8\text{mm}$ ,  $dy=8\text{mm}$ ,  $dz=5\text{mm}$

Reference Value = 53.43 V/m; Power Drift = -0.16 dB

Peak SAR (extrapolated) = 3.18 W/kg

**SAR(1 g) = 2.11 W/kg; SAR(10 g) = 1.37 W/kg**

Smallest distance from peaks to all points 3 dB below = 17.9 mm

Ratio of SAR at M2 to SAR at M1 = 65.9%

Maximum value of SAR (measured) = 2.69 W/kg

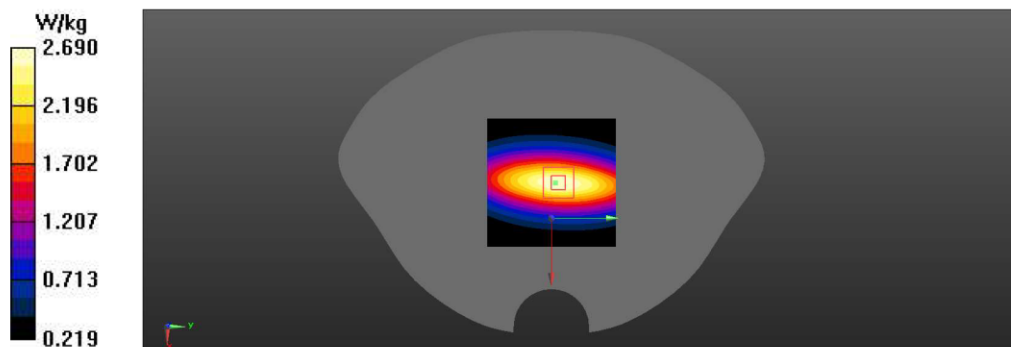

Test Laboratory: BACL . SAR Testing Lab

### System Check\_Head\_750MHz

**DUT: D750V3-1079**

Communication System: UID 0, CW (0); Frequency: 750 MHz; Duty Cycle: 1:1

Medium: HSL650 Medium parameters used:  $f = 750 \text{ MHz}$ ;  $\sigma = 0.916 \text{ S/m}$ ;  $\epsilon_r = 42.911$ ;  $\rho = 1000 \text{ kg/m}^3$

DASY5 Configuration:

- Probe: EX3DV4 - SN7520; ConvF(9.81, 9.81, 9.81) @ 750 MHz; Calibrated: 11/16/2020
- Sensor-Surface: 2mm (Mechanical Surface Detection)
- Electronics: DAE4 Sn1561; Calibrated: 11/23/2020
- Phantom: Twin-SAM V8.0 (20deg probe tilt)-Right; Type: QD 000 P40 CB; Serial: 1368
- Measurement SW: DASY52, Version 52.10 (4); SEMCAD X Version 14.6.14 (7483)

**Configuration/Pin=250mW/Area Scan (61x61x1):** Interpolated grid:  $dx=1.500 \text{ mm}$ ,  $dy=1.500 \text{ mm}$   
Maximum value of SAR (interpolated) = 2.78 W/kg

**Configuration/Pin=250mW/Zoom Scan (5x5x7)/Cube 0:** Measurement grid:  $dx=8\text{mm}$ ,  $dy=8\text{mm}$ ,  $dz=5\text{mm}$

Reference Value = 53.49 V/m; Power Drift = -0.01 dB

Peak SAR (extrapolated) = 3.28 W/kg

**SAR(1 g) = 2.2 W/kg; SAR(10 g) = 1.45 W/kg**

Smallest distance from peaks to all points 3 dB below = 17.6 mm

Ratio of SAR at M2 to SAR at M1 = 67.3%

Maximum value of SAR (measured) = 2.76 W/kg

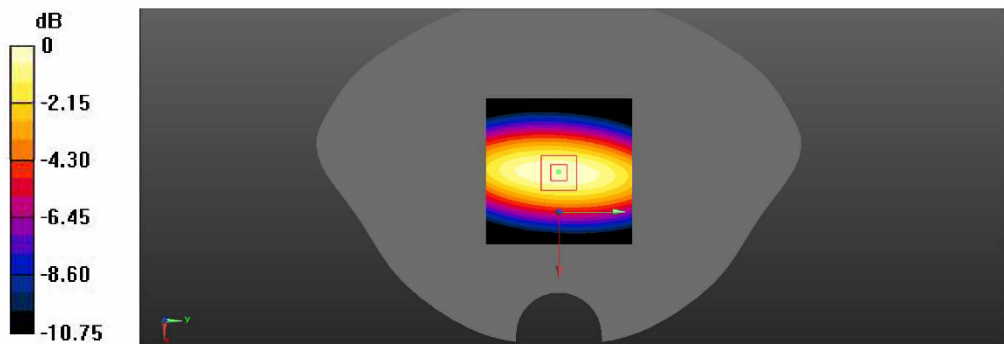



Test Laboratory: BACL . SAR Testing Lab

**System Check\_Head\_2600MHz**

**DUT: D2600V2-1174**

Communication System: UID 0, CW (0); Frequency: 2600 MHz;Duty Cycle: 1:1

Medium: HSL2600 Medium parameters used:  $f = 2600$  MHz;  $\sigma = 1.956$  S/m;  $\epsilon_r = 39.519$ ;  $\rho = 1000$  kg/m<sup>3</sup>

DASY5 Configuration:

- Probe: EX3DV4 - SN7520; ConvF(7.43, 7.43, 7.43) @ 2600 MHz; Calibrated: 11/16/2020
- Sensor-Surface: 1.4mm (Mechanical Surface Detection)
- Electronics: DAE4 Sn1561; Calibrated: 11/23/2020
- Phantom: Twin-SAM V8.0 (20deg probe tilt)-Right; Type: QD 000 P40 CB; Serial: 1368
- Measurement SW: DASY52, Version 52.10 (4);SEMCAD X Version 14.6.14 (7483)

**Pin=250mW/Area Scan (61x61x1):** Interpolated grid: dx=1.200 mm, dy=1.200 mm

Maximum value of SAR (interpolated) = 24.6 W/kg

**Pin=250mW/Zoom Scan (7x7x7)/Cube 0:** Measurement grid: dx=5mm, dy=5mm, dz=5mm

Reference Value = 106.4 V/m; Power Drift = -0.09 dB

Peak SAR (extrapolated) = 31.2 W/kg

**SAR(1 g) = 14.3 W/kg; SAR(10 g) = 6.44 W/kg**

Smallest distance from peaks to all points 3 dB below = 9.2 mm

Ratio of SAR at M2 to SAR at M1 = 45.7%

Maximum value of SAR (measured) = 24.6 W/kg

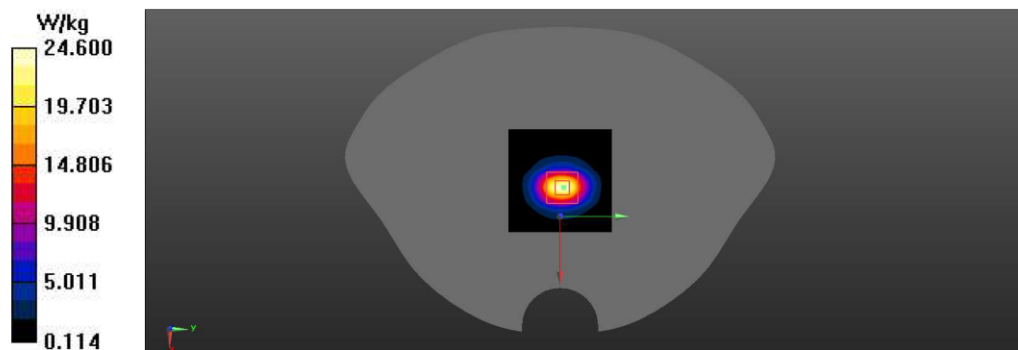

## EUT TEST STRATEGY AND METHODOLOGY

### Test Positions for Device Operating Next to a Person’s Ear

This category includes most wireless handsets with fixed, retractable or internal antennas located toward the top half of the device, with or without a foldout, sliding or similar keypad cover. The handset should have its earpiece located within the upper ¼ of the device, either along the centerline or off-centered, as perceived by its users. This type of handset should be positioned in a normal operating position with the “test device reference point” located along the “vertical centerline” on the front of the device aligned to the “ear reference point”. The “test device reference point” should be located at the same level as the center of the earpiece region. The “vertical centerline” should bisect the front surface of the handset at its top and bottom edges. A “ear reference point” is located on the outer surface of the head phantom on each ear spacer. It is located 1.5 cm above the center of the ear canal entrance in the “phantom reference plane” defined by the three lines joining the center of each “ear reference point” (left and right) and the tip of the mouth.

A handset should be initially positioned with the earpiece region pressed against the ear spacer of a head phantom. For the SCC-34/SC-2 head phantom, the device should be positioned parallel to the “N-F” line defined along the base of the ear spacer that contains the “ear reference point”. For interim head phantoms, the device should be positioned parallel to the cheek for maximum RF energy coupling. The “test device reference point” is aligned to the “ear reference point” on the head phantom and the “vertical centerline” is aligned to the “phantom reference plane”. This is called the “initial ear position”. While maintaining these three alignments, the body of the handset is gradually adjusted to each of the following positions for evaluating SAR:

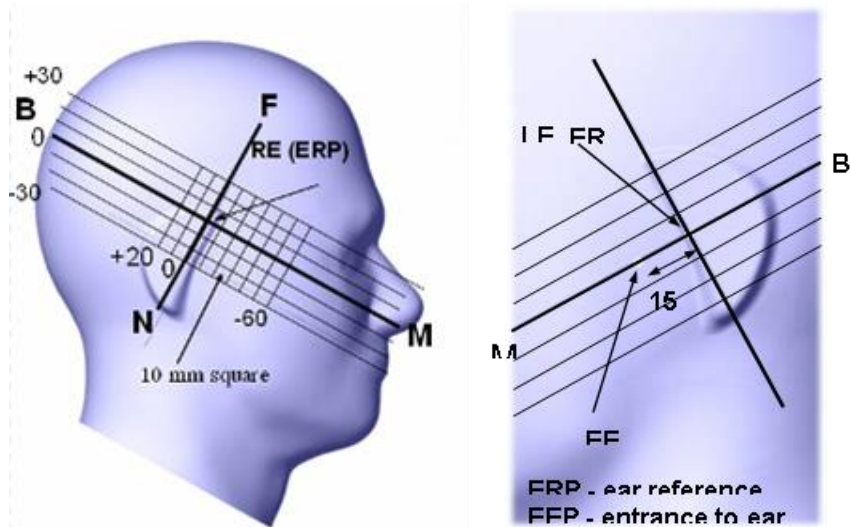

### Cheek/Touch Position

The device is brought toward the mouth of the head phantom by pivoting against the “ear reference point” or along the “N-F” line for the SCC-34/SC-2 head phantom.

This test position is established:

When any point on the display, keypad or mouthpiece portions of the handset is in contact with the phantom.

(or) When any portion of a foldout, sliding or similar keypad cover opened to its intended self-adjusting normal use position is in contact with the cheek or mouth of the phantom.

For existing head phantoms – when the handset loses contact with the phantom at the pivoting point, rotation should continue until the device touches the cheek of the phantom or breaks its last contact from the ear spacer.

**Cheek /Touch Position**

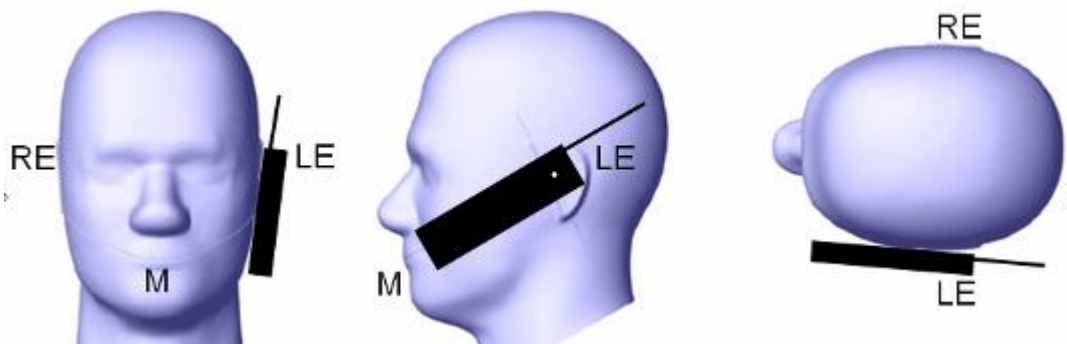

**Ear/Tilt Position**

With the handset aligned in the “Cheek/Touch Position”:

1) If the earpiece of the handset is not in full contact with the phantom’s ear spacer (in the “Cheek/Touch position”) and the peak SAR location for the “Cheek/Touch” position is located at the ear spacer region or corresponds to the earpiece region of the handset, the device should be returned to the “initial ear position” by rotating it away from the mouth until the earpiece is in full contact with the ear spacer.

2) (otherwise) The handset should be moved (translated) away from the cheek perpendicular to the line passes through both “ear reference points” (note: one of these ear reference points may not physically exist on a split head model) for approximate 2-3 cm. While it is in this position, the device handset is tilted away from the mouth with respect to the “test device reference point” until the inside angle between the vertical centerline on the front surface of the phone and the horizontal line passing through the ear reference point is by 15 80°. After the tilt, it is then moved (translated) back toward the head perpendicular to the line passes through both “ear reference points” until the device touches the phantom or the ear spacer. If the antenna touches the head first, the positioning process should be repeated with a tilt angle less than 15° so that the device and its antenna would touch the phantom simultaneously. This test position may require a device holder or positioner to achieve the translation and tilting with acceptable positioning repeatability.

If a device is also designed to transmit with its keypad cover closed for operating in the head position, such positions should also be considered in the SAR evaluation. The device should be tested on the left and right side of the head phantom in the “Cheek/Touch” and “Ear/Tilt” positions. When applicable, each configuration should be tested with the antenna in its fully extended and fully retracted positions. These test configurations should be tested at the high, middle and low frequency channels of each operating mode; for example, AMPS, CDMA, and TDMA. If the SAR measured at the middle channel for each test configuration (left, right, Cheek/Touch, Tilt/Ear, extended and retracted) is at least 2.0 dB lower than the SAR limit, testing at the high and low channels is optional for such test configuration(s). If the transmission band of the test device is less than 10 MHz, testing at the high and low frequency channels is optional.

**Ear /Tilt 15o Position**

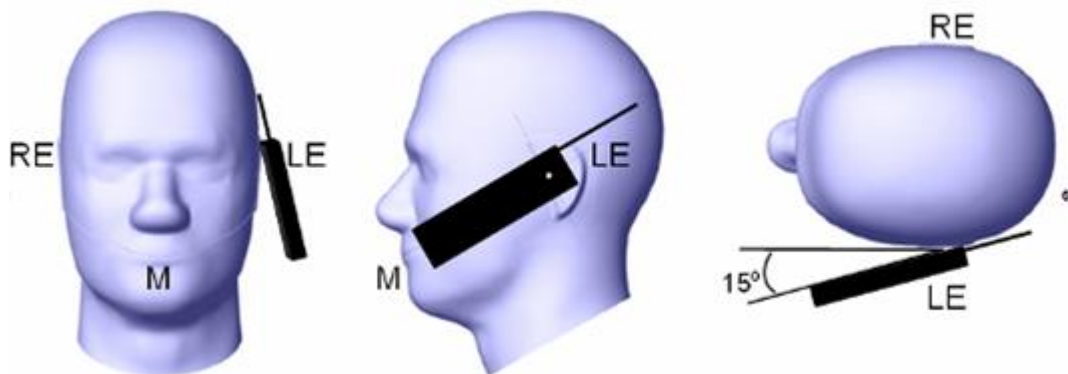

**Test positions for body-worn and other configurations**

Body-worn operating configurations should be tested with the belt-clips and holsters attached to the device and positioned against a flat phantom in normal use configurations. Devices with a headset output should be tested with a headset connected to the device. When multiple accessories that do not contain metallic components are supplied with the device, the device may be tested with only the accessory that dictates the closest spacing to the body. When multiple accessories that contain metallic components are supplied with the device, the device must be tested with each accessory that contains a unique metallic component. If multiple accessories share an identical metallic component (e.g., the same metallic belt-clip used with different holsters with no other metallic components), only the accessory that dictates the closest spacing to the body must be tested.

Body-worn accessories may not always be supplied or available as options for some devices that are intended to be authorized for body-worn use. A separation distance of 1.5 cm between the back of the device and a flat phantom is recommended for testing body-worn SAR compliance under such circumstances. Other separation distances may be used, but they should not exceed 2.5 cm. In these cases, the device may use body-worn accessories that provide a separation distance greater than that tested for the device provided however that the accessory contains no metallic components.

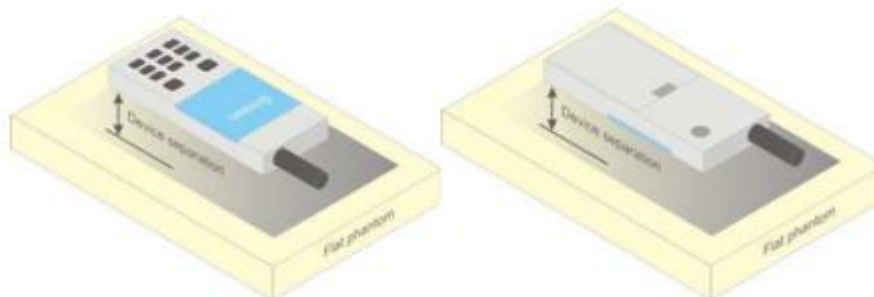

**Figure 5 – Test positions for body-worn devices**

**Test Distance for SAR Evaluation**

For this case the EUT(Equipment Under Test) is set 10mm away from the phantom, the test distance is 10mm.

## SAR Evaluation Procedure

The evaluation was performed with the following procedure:

Step 1: Measurement of the SAR value at a fixed location above the ear point or central position was used as a reference value for assessing the power drop. The SAR at this point is measured at the start of the test and then again at the end of the testing.

Step 2: The SAR distribution at the exposed side of the head was measured at a distance of 4 mm from the inner surface of the shell. The area covered the entire dimension of the head or radiating structures of the EUT, the horizontal grid spacing was 15 mm x 15 mm, and the SAR distribution was determined by integrated grid of 1.5mm x 1.5mm. Based on these data, the area of the maximum absorption was determined by spline interpolation. The first Area Scan covers the entire dimension of the EUT to ensure that the hotspot was correctly identified.

Step 3: Around this point, a volume of 30 mm x 30 mm x 30 mm was assessed by measuring 7x 7 x 7 points. On the basis of this data set, the spatial peak SAR value was evaluated under the following procedure:

- 1) The data at the surface were extrapolated, since the center of the dipoles is 1.2 mm away from the tip of the probe and the distance between the surface and the lowest measuring point is 1.3 mm. The extrapolation was based on a least square algorithm. A polynomial of the fourth order was calculated through the points in z-axes. This polynomial was then used to evaluate the points between the surface and the probe tip.

- 2) The maximum interpolated value was searched with a straightforward algorithm. Around this maximum the SAR values averaged over the spatial volumes (1 g or 10 g) were computed by the 3D-Spline interpolation algorithm. The 3D-Spline is composed of three one dimensional splines with the "Not a knot"-condition (in x, y and z-directions). The volume was integrated with the trapezoidal-algorithm. One thousand points (10 x 10 x 10) were interpolated to calculate the averages.

All neighboring volumes were evaluated until no neighboring volume with a higher average value was found.

Step 4: Re-measurement of the SAR value at the same location as in Step 1. If the value changed by more than 5%, the evaluation was repeated.

## **CONDUCTED OUTPUT POWER MEASUREMENT**

---

### **Provision Applicable**

The measured peak output power should be greater and within 5% than EMI measurement.

### **Test Procedure**

The RF output of the transmitter was connected to the input of the EMI Test Receiver through sufficient attenuation.

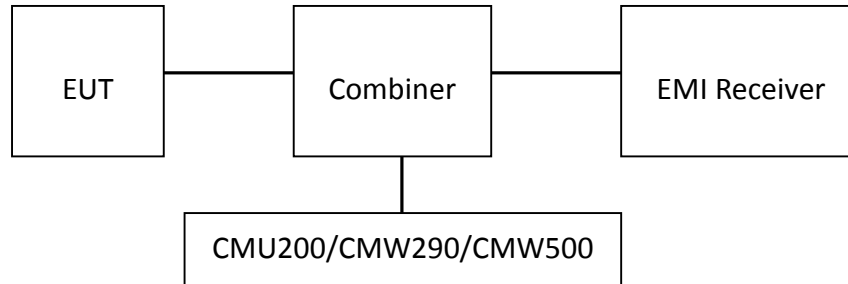

**GSM&3G&LTE**

## **GSM/GPRS/EGPRS**

Function: Menu select > GSM Mobile Station > GPRS 850/1900

Press Connection control to choose the different menus

Press RESET > choose all the reset all settings

Connection Press Signal Off to turn off the signal and change settings

Network Support > GSM + GPRS or GSM + EGSM

Main Service > Packet Data

Service selection > Test Mode A – Auto Slot Config. off

MS Signal Press Slot Config Bottom on the right twice to select and change the number of time slots and power setting

- > Slot configuration > Uplink/Gamma

- > 33 dBm for GPRS 850

- > 30 dBm for GPRS 1900

- > 27 dBm for EGPRS 850

- > 26 dBm for EGPRS 1900

BS Signal Enter the same channel number for TCH channel (test channel) and BCCH channel

Frequency Offset > + 0 Hz

Mode > BCCH and TCH

BCCH Level > -85 dBm (May need to adjust if link is not stable)

BCCH Channel > choose desired test channel [Enter the same channel number for TCH channel (test channel) and BCCH channel]

Channel Type > Off

P0 > 4 dB

Slot Config>Unchanged (if already set under MS signal)

TCH > choose desired test channel

Hopping > Off

Main Timeslot > 3

Network Coding Scheme > CS4 (GPRS) and MCS5 (EGPRS)

Bit Stream > 2E9-1 PSR Bit Stream

AF/RF Enter appropriate offsets for Ext. Att. Output and Ext. Att. Input

Connection Press Signal on to turn on the signal and change settings

**WCDMA Release 99**

The following tests were conducted according to the test requirements outlines in section 5.2 of the 3GPP TS34.121-1 specification. The EUT has a nominal maximum output power of 24dBm (+1.7/-3.7).

<b>WCDMA General Settings</b>	Loopback Mode	Test Mode 1
	Rel99 RMC	12.2kbps RMC
	Power Control Algorithm	Algorithm2
	$\beta_c / \beta_d$	8/15

**HSDPA**

The following tests were conducted according to the test requirements outlines in section 5.2 of the 3GPP TS34.121-1 specification.

	Mode	HSDPA	HSDPA	HSDPA	HSDPA
	Subset	1	2	3	4
<b>WCDMA General Settings</b>	Loopback Mode	Test Mode 1			
	Rel99 RMC	12.2kbps RMC			
	HSDPA FRC	H-Set1			
	Power Control Algorithm	Algorithm2			
	$\beta_c$	2/15	12/15	15/15	15/15
	$\beta_d$	15/15	15/15	8/15	4/15
	$\beta_d$ (SF)	64			
	$\beta_c/\beta_d$	2/15	12/15	15/8	15/4
	$\beta_{hs}$	4/15	24/15	30/15	30/15
	MPR(dB)	0	0	0.5	0.5
<b>HSDPA Specific Settings</b>	DACK	8			
	DNAK	8			
	DCQI	8			
	Ack-Nack repetition factor	3			
	CQI Feedback	4ms			
	CQI Repetition Factor	2			
	$A_{hs}=\beta_{hs}/ \beta_c$	30/15			



**HSUPA**

The following tests were conducted according to the test requirements outlines in section 5.2 of the 3GPP TS34.121-1 specification.

	Mode	HSUPA	HSUPA	HSUPA	HSUPA	HSUPA	
	Subset	1	2	3	4	5	
<b>WCDMA General Settings</b>	Loopback Mode	Test Mode 1					
	Rel99 RMC	12.2kbps RMC					
	HSDPA FRC	H-Set1					
	HSUPA Test	HSUPA Loopback					
	Power Control Algorithm	Algorithm2					
	$\beta_c$	11/15	6/15	15/15	2/15	15/15	
	$\beta_d$	15/15	15/15	9/15	15/15	0	
	$\beta_{ec}$	209/225	12/15	30/15	2/15	5/15	
	$\beta_c/\beta_d$	11/15	6/15	15/9	2/15	-	
	$\beta_{hs}$	22/15	12/15	30/15	4/15	5/15	
CM(dB)	1.0	3.0	2.0	3.0	1.0		
MPR(dB)	0	2	1	2	0		
<b>HSDPA Specific Settings</b>	DACK	8					
	DNAK	8					
	DCQI	8					
	Ack-Nack repetition factor	3					
	CQI Feedback	4ms					
	CQI Repetition Factor	2					
	$A_{hs} = \beta_{hs} / \beta_c$	30/15					
<b>HSUPA Specific Settings</b>	DE-DPCCH	6	8	8	5	7	
	DHARQ	0	0	0	0	0	
	AG Index	20	12	15	17	21	
	ETFCI	75	67	92	71	81	
	Associated Max UL Data Rate kbps	242.1	174.9	482.8	205.8	308.9	
	Reference E_FCI	E-TFCI 11 E E-TFCI PO 4 E-TFCI 67 E-TFCI PO 18 E-TFCI 71 E-TFCI PO23 E-TFCI 75 E-TFCI PO26 E-TFCI 81 E-TFCI PO 27		E-TFCI 11 E-TFCI PO4 E-TFCI 92 E-TFCI PO 18		E-TFCI 11 E E-TFCI PO 4 E-TFCI 67 E-TFCI PO 18 E-TFCI 71 E-TFCI PO23 E-TFCI 75 E-TFCI PO26 E-TFCI 81 E-TFCI PO 27	

**HSPA+**

Sub-test	$\beta_c$ (Note3)	$\beta_d$	$\beta_{hs}$ (Note1)	$\beta_{ec}$	$\beta_{ed}$ (2xSF2) (Note 4)	$\beta_{ed}$ (2xSF4) (Note 4)	CM (dB) (Note 2)	MPR (dB) (Note 2)	AG Index (Note 4)	E-TFCI (Note 5)	E-TFCI (boost)
1	1	0	30/15	30/15	$\beta_{ed1}$ : 30/15 $\beta_{ed2}$ : 30/15	$\beta_{ed3}$ : 24/15 $\beta_{ed4}$ : 24/15	3.5	2.5	14	105	105

- Note 1:  $\Delta_{ACK}, \Delta_{NACK}$  and  $\Delta_{CQI} = 30/15$  with  $\beta_{hs} = 30/15 * \beta_c$ .
- Note 2: CM = 3.5 and the MPR is based on the relative CM difference, MPR = MAX(CM-1,0).
- Note 3: DPDCH is not configured, therefore the  $\beta_c$  is set to 1 and  $\beta_d = 0$  by default.
- Note 4:  $\beta_{ed}$  can not be set directly; it is set by Absolute Grant Value.
- Note 5: All the sub-tests require the UE to transmit 2SF2+2SF4 16QAM EDCH and they apply for UE using E-DPDCH category 7. E-DCH TTI is set to 2ms TTI and E-DCH table index = 2. To support these E-DCH configurations DPDCH is not allocated. The UE is signalled to use the extrapolation algorithm.

The following tests were conducted according to the test requirements in Table C.11.1.4 of 3GPP TS 34.121-1

**LTE**

For UE Power Class 1 and 3, the allowed Maximum Power Reduction (MPR) for the maximum output power in Table 6.2.2-1 due to higher order modulation and transmit bandwidth configuration (resource blocks) is specified in Table 6.2.3-1.

**Table 6.2.3-1: Maximum Power Reduction (MPR) for Power Class 1 and 3**

Modulation	Channel bandwidth / Transmission bandwidth ( $N_{RB}$ )						MPR (dB)
	1.4 MHz	3.0 MHz	5 MHz	10 MHz	15 MHz	20 MHz	
QPSK	> 5	> 4	> 8	> 12	> 16	> 18	≤ 1
16 QAM	≤ 5	≤ 4	≤ 8	≤ 12	≤ 16	≤ 18	≤ 1
16 QAM	> 5	> 4	> 8	> 12	> 16	> 18	≤ 2

For UE Power Class 1 and 3 the specific requirements and identified subclauses are specified in Table 6.2.4-1 along with the allowed A-MPR values that may be used to meet these requirements. The allowed A-MPR values specified below in Table 6.2.4-1 to 6.2.4-15 are in addition to the allowed MPR requirements specified in subclause

**Table 6.2.4-1: Additional Maximum Power Reduction (A-MPR)**

Network Signalling value	Requirements (subclause)	E-UTRA Band	Channel bandwidth (MHz)	Resources Blocks ( $N_{RB}$ )	A-MPR (dB)
NS_01	6.6.2.1.1	Table 5.5-1	1.4, 3, 5, 10, 15, 20	Table 5.6-1	N/A
NS_03	6.6.2.2.1	2, 4, 10, 23, 25, 35, 36	3	>5	≤ 1
			5	>6	≤ 1
			10	>6	≤ 1
			15	>8	≤ 1
NS_04	6.6.2.2.2	41	20	>10	≤ 1
			5	>6	≤ 1
NS_05	6.6.3.3.1	1	10, 15, 20	≥ 50	≤ 1
NS_06	6.6.2.2.3	12, 13, 14, 17	1.4, 3, 5, 10	Table 5.6-1	N/A
NS_07	6.6.2.2.3	13	10	Table 6.2.4-2	
	6.6.3.3.2				
NS_08	6.6.3.3.3	19	10, 15	> 44	≤ 3
				> 40	≤ 1
				> 55	≤ 2
NS_10		20	15, 20	Table 6.2.4-3	
NS_11	6.6.2.2.1	23	1.4, 3, 5, 10, 15, 20	Table 6.2.4-5	
NS_12	6.6.3.3.5	26	1.4, 3, 5	Table 6.2.4-6	
NS_13	6.6.3.3.6	26	5	Table 6.2.4-7	
NS_14	6.6.3.3.7	26	10, 15	Table 6.2.4-8	
NS_15	6.6.3.3.8	26	1.4, 3, 5, 10, 15	Table 6.2.4-9	
				Table 6.2.4-10	
NS_16	6.6.3.3.9	27	3, 5, 10	Table 6.2.4-11, Table 6.2.4-12, Table 6.2.4-13	
NS_17	6.6.3.3.10	28	5, 10	Table 5.6-1	N/A
NS_18	6.6.3.3.11	28	5	≥ 2	≤ 1
			10, 15, 20	≥ 1	≤ 4
NS_19	6.6.3.3.12	44	10, 15, 20	Table 6.2.4-14	
NS_20	6.2.2	23	5, 10, 15, 20	Table 6.2.4-15	
	6.6.2.2.1				
	6.6.3.2				
NS_32	-	-	-	-	-

**Maximum Target Output Power**  
**WWAN Antenna Full Power Target power**

Max Target Power(dBm)				
Mode / Band	Low Channel	Middle Channel	High Channel	
GPRS850 1 TX Slot	24.0	24.0	24.0	
GPRS850 2 TX Slot	25.0	25.0	25.0	
GPRS850 3 TX Slot	25.0	25.0	25.0	
GPRS850 4 TX Slot	23.5	23.5	23.5	
EGPRS850 1 TX Slot	18.0	18.0	18.0	
EGPRS850 2 TX Slot	19.0	19.0	19.0	
EGPRS850 3 TX Slot	19.0	19.0	19.0	
EGPRS850 4 TX Slot	18.0	18.0	18.0	
GPRS1900 1 TX Slot	21.0	21.0	21.0	
GPRS1900 2 TX Slot	22.5	22.5	22.5	
GPRS1900 3 TX Slot	22.0	22.0	22.0	
GPRS1900 4 TX Slot	21.5	21.5	21.5	
EGPRS1900 1 TX Slot	17.0	17.0	17.0	
EGPRS1900 2 TX Slot	18.0	18.0	18.0	
EGPRS1900 3 TX Slot	18.0	18.0	18.0	
EGPRS1900 4 TX Slot	17.5	17.5	17.5	
WCDMA Band 2	24.0	24.0	24.0	
WCDMA Band 4	24.0	24.0	24.0	
WCDMA Band 5	24.0	24.0	24.0	
LTE Band 2	24.5	24.5	24.5	
LTE Band 4	25.5	25.5	25.5	
LTE Band 5	24.5	24.5	24.5	
LTE Band 7	23.0	23.0	23.0	
LTE Band 12	25.0	25.0	25.0	
LTE Band 66	25.0	25.0	25.0	
LTE Band 71	25.0	25.0	25.0	
Bluetooth LE	-3.0	-3.0	-5.0	
WiFi 2.4GHz	9.5	9.5	9.5	
WiFi 5.2GHz 802.11a	12.0	12.0	12.0	
WiFi 5.2GHz 802.11nHT20	10.0	10.0	10.0	
WiFi 5.2GHz 802.11nHT40/AC80	9.5	9.5	9.5	
WiFi 5.8GHz 802.11a	11.5	11.5	11.5	
WiFi 5.8GHz 802.11nHT20/HT40/AC80	10.0	10.0	10.0	
Mode / Band	Low Channel	Middle Channel	2450MHz	High Channel
Bluetooth 1M	11.0	12.0	13.0	7.0
Bluetooth 2M	10.5	11.5	12.0	6.5
Bluetooth 3M	10.5	11.5	12.0	6.5

**Test Results:**

**WWAN Antenna Full Power**

**GPRS:**

Mode	Channel No.	Frequency (MHz)	RF Output Power (Peak / dBm)			
			1 slot	2 slots	3 slots	4 slots
GSM850	128	824.2	32.47	30.58	28.79	26.18
	190	836.6	32.65	30.49	28.96	26.29
	251	848.8	32.57	30.65	28.51	26.25
PCS1900	512	1850.2	29.63	28.13	25.86	23.34
	661	1880	29.84	28.35	25.79	23.36
	810	1909.8	29.63	27.83	26.02	24.27

**EGPRS:**

Mode	Channel No.	Frequency (MHz)	RF Output Power (Peak / dBm)			
			1 slot	2 slots	3 slots	4 slots
GSM850	128	824.2	26.85	24.79	22.74	20.82
	190	836.6	26.76	24.93	22.92	20.95
	251	848.8	26.84	24.88	22.75	20.61
PCS1900	512	1850.2	25.57	23.86	21.94	20.12
	661	1880	25.63	23.81	21.77	20.05
	810	1909.8	25.76	23.85	21.73	20.11

For SAR, the time based average power is relevant, the difference in between depends on the duty cycle of the TDMA signal.

Number of Time slot	1	2	3	4
Duty Cycle	1:8	1:4	1:2.66	1:2
Time based Ave. power compared to slotted Ave. power	-9 dB	-6 dB	-4.25 dB	-3 dB
Crest Factor	8	4	2.66	2

**The time based average power for GPRS**

Band	Channel No.	Frequency (MHz)	Time based average Power (dBm)			
			1 slot	2 slot	3 slots	4 slots
GPRS 850	128	824.2	23.47	24.58	24.54	23.18
	190	836.6	23.65	24.49	<u>24.71</u>	23.29
	251	848.8	23.57	24.65	24.26	23.25
GPRS 1900	512	1850.2	20.63	22.13	21.61	20.34
	661	1880	20.84	<u>22.35</u>	21.54	20.36
	810	1909.8	20.63	21.83	21.77	21.27

**The time based average power for EDGE**

Band	Channel No.	Frequency (MHz)	Time based average Power (dBm)			
			1 slot	2 slot	3 slots	4 slots
EGPRS 850	128	824.2	17.85	18.79	18.49	17.82
	190	836.6	17.76	18.93	18.67	17.95
	251	848.8	17.84	18.88	18.5	17.61
EGPRS 1900	512	1850.2	16.57	17.86	17.69	17.12
	661	1880	16.63	17.81	17.52	17.05
	810	1909.8	16.76	17.85	17.48	17.11

**WCDMAWWAN Antenna Full Power**

**WCDMA Band II**

Test Condition	Test Mode	3GPP Sub Test	Averaged Mean Power (dBm)		
			Low Channel	Mid Channel	High Channel
Normal	Rel 99 RMC	1	23.52	<u>23.67</u>	23.62
	HSDPA	1	23.25	23.54	22.86
		2	22.87	23.68	22.72
		3	23.15	23.61	22.71
		4	23.34	23.98	22.83
		5	23.34	22.94	23.21
	HSUPA	2	23.36	22.84	22.89
		3	23.18	22.67	22.92
		4	23.27	22.64	22.94
		5	23.54	22.58	23.14
		6	22.96	22.53	22.87
	DC-HSDPA	2	23.28	22.47	23.23
		3	23.34	22.68	22.96
		4	23.19	22.62	23.08
		5	23.19	22.62	23.08
	HSPA+	1	21.20	21.36	21.54

**WCDMA Band IV**

Test Condition	Test Mode	3GPP Sub Test	Averaged Mean Power (dBm)		
			Low Channel	Mid Channel	High Channel
Normal	Rel 99 RMC	1	23.82	23.96	<u>23.98</u>
	HSDPA	1	22.87	22.91	22.82
		2	22.67	22.78	22.89
		3	22.83	22.94	22.78
		4	22.89	22.73	22.95
	HSUPA	1	22.47	22.84	22.82
		2	22.96	22.67	22.78
		3	22.68	22.96	22.74
		4	22.85	22.92	22.96
		5	22.74	22.84	22.75
	DC-HSDPA	1	22.52	22.88	22.81
		2	22.71	22.63	22.93
		3	22.93	22.74	22.95
		4	22.75	22.69	22.77
	HSPA+	1	21.10	20.98	21.08

**WCDMA Band V**

Test Condition	Test Mode	3GPP Sub Test	Averaged Mean Power (dBm)		
			Low Channel	Mid Channel	High Channel
Normal	Rel 99 RMC	1	23.62	<u>23.85</u>	23.71
	HSDPA	1	22.69	22.76	22.84
		2	22.47	22.82	22.95
		3	22.53	22.69	22.64
		4	22.48	22.75	22.58
	HSUPA	1	22.96	22.83	22.93
		2	22.74	22.74	22.87
		3	22.58	22.83	22.46
		4	22.36	22.95	22.55
		5	22.71	22.84	22.37
	DC-HSDPA	1	22.29	22.83	22.49
		2	22.54	22.92	22.72
		3	22.18	22.77	22.84
		4	22.83	22.72	22.93
	HSPA+	1	20.86	20.91	20.47



**LTE:  
Full Power**

**LTE Band 2 part1:**

Test Bandwidth	Test Modulation	Resource Block & RB offset	Low Channel (dBm)	Middle Channel (dBm)	High Channel (dBm)
1.4M	QPSK	RB1#0	23.86	23.62	23.42
		RB1#3	23.62	23.74	23.60
		RB1#5	23.85	23.60	23.46
		RB3#0	23.86	23.60	23.38
		RB3#3	23.87	23.66	23.39
		RB6#0	22.93	22.72	22.48
	16-QAM	RB1#0	22.79	22.73	22.30
		RB1#3	22.99	22.89	22.50
		RB1#5	22.80	22.70	22.35
		RB3#0	22.99	22.59	22.45
		RB3#3	23.00	22.60	22.38
		RB6#0	21.88	21.70	21.32
3M	QPSK	RB1#0	23.88	23.65	23.46
		RB1#8	23.89	23.67	23.48
		RB1#14	23.85	23.63	23.49
		RB6#0	22.90	22.64	22.37
		RB6#9	22.85	22.66	22.43
		RB15#0	22.84	22.67	22.41
	16-QAM	RB1#0	23.36	22.77	22.44
		RB1#8	23.34	22.75	22.37
		RB1#14	23.28	22.73	22.29
		RB6#0	21.90	21.61	21.28
		RB6#9	21.83	21.65	21.24
		RB15#0	21.87	21.59	21.43

**LTE Band 2 part2:**

Test Bandwidth	Test Modulation	Resource Block & RB offset	Low Channel (dBm)	Middle Channel (dBm)	High Channel (dBm)
5M	QPSK	RB1#0	23.75	23.54	23.32
		RB1#13	23.84	23.63	23.46
		RB1#24	23.69	23.57	23.32
		RB15#0	22.87	22.64	22.46
		RB15#10	22.83	22.63	22.36
		RB25#0	22.80	22.58	22.34
	16-QAM	RB1#0	22.64	22.85	22.36
		RB1#13	22.73	22.93	22.40
		RB1#24	22.59	22.76	22.30
		RB15#0	21.82	21.62	21.49
		RB15#10	21.82	21.62	21.38
		RB25#0	21.81	21.58	21.43
10M	QPSK	RB1#0	23.81	23.61	23.42
		RB1#25	23.91	23.44	23.21
		RB1#49	23.74	23.60	23.52
		RB25#0	22.83	22.67	22.53
		RB25#25	22.84	22.63	22.39
		RB50#0	22.85	22.62	22.47
	16-QAM	RB1#0	23.33	22.77	22.43
		RB1#25	23.47	22.90	22.60
		RB1#49	23.29	22.69	22.35
		RB25#0	21.86	21.69	21.67
		RB25#25	21.89	21.64	21.46
		RB50#0	21.86	21.63	21.49

**LTE Band 2 part3:**

Test Bandwidth	Test Modulation	Resource Block & RB offset	Low Channel (dBm)	Middle Channel (dBm)	High Channel (dBm)
15M	QPSK	RB1#0	23.74	23.55	23.41
		RB1#38	23.80	23.67	23.47
		RB1#74	23.64	23.47	23.42
		RB36#0	22.94	22.74	22.59
		RB36#39	22.88	22.76	22.55
		RB75#0	22.89	22.77	22.55
	16-QAM	RB1#0	23.21	22.70	22.69
		RB1#38	23.34	22.75	22.82
		RB1#74	23.27	22.56	22.54
		RB36#0	21.85	21.69	21.54
		RB36#39	21.82	21.69	21.43
		RB75#0	21.85	21.75	21.52
20M	QPSK	RB1#0	<u>24.04</u>	<u>23.81</u>	<u>23.63</u>
		RB1#50	23.93	23.80	23.59
		RB1#99	23.50	23.39	23.16
		RB50#0	<u>22.77</u>	<u>22.69</u>	<u>22.49</u>
		RB50#50	22.77	22.58	20.38
		RB100#0	22.77	22.59	20.71
	16-QAM	RB1#0	22.86	22.62	21.03
		RB1#50	23.34	22.93	21.39
		RB1#99	22.87	22.43	22.39
		RB50#0	21.78	21.67	22.26
		RB50#50	21.83	21.54	22.21
		RB100#0	21.85	21.60	22.29

**LTE Band 4 part1:**

Test Bandwidth	Test Modulation	Resource Block & RB offset	Low Channel (dBm)	Middle Channel (dBm)	High Channel (dBm)
1.4M	QPSK	RB1#0	25.12	25.13	25.09
		RB1#3	25.25	25.26	25.23
		RB1#5	25.14	25.12	25.05
		RB3#0	25.19	25.18	25.13
		RB3#3	25.19	25.18	25.08
		RB6#0	24.16	24.16	24.12
	16-QAM	RB1#0	24.05	24.21	24.00
		RB1#3	24.19	24.34	24.17
		RB1#5	24.07	24.18	24.03
		RB3#0	24.34	24.14	24.16
		RB3#3	24.32	24.08	24.14
		RB6#0	23.15	23.20	23.04
3M	QPSK	RB1#0	24.50	24.52	24.51
		RB1#8	25.24	25.27	24.74
		RB1#14	25.30	25.26	24.73
		RB6#0	24.23	24.25	23.68
		RB6#9	24.23	24.23	23.64
		RB15#0	24.27	24.24	23.71
	16-QAM	RB1#0	24.74	24.37	23.73
		RB1#8	24.69	24.38	23.70
		RB1#14	24.72	24.38	23.69
		RB6#0	23.30	23.24	22.65
		RB6#9	23.29	23.27	22.62
		RB15#0	23.37	23.20	22.79

**LTE Band 4 part2:**

Test Bandwidth	Test Modulation	Resource Block & RB offset	Low Channel (dBm)	Middle Channel (dBm)	High Channel (dBm)
5M	QPSK	RB1#0	24.65	24.68	24.66
		RB1#13	24.76	24.78	24.75
		RB1#24	24.68	24.70	24.64
		RB15#0	23.79	23.77	23.76
		RB15#10	23.78	23.73	23.74
		RB25#0	23.69	23.69	23.70
	16-QAM	RB1#0	23.54	23.94	23.68
		RB1#13	23.60	24.00	23.76
		RB1#24	23.51	23.92	23.70
		RB15#0	22.84	22.75	22.79
		RB15#10	22.87	22.77	22.78
		RB25#0	22.81	22.74	22.78
10M	QPSK	RB1#0	24.77	24.74	24.74
		RB1#25	25.02	24.95	25.01
		RB1#49	24.75	24.74	24.72
		RB25#0	23.77	23.82	23.74
		RB25#25	23.84	23.82	23.76
		RB50#0	23.83	23.79	23.76
	16-QAM	RB1#0	24.21	23.83	23.68
		RB1#25	24.41	24.09	23.85
		RB1#49	24.21	23.85	23.64
		RB25#0	22.86	22.84	22.84
		RB25#25	22.90	22.87	22.85
		RB50#0	22.87	22.85	22.84

**LTE Band 4 part3:**

Test Bandwidth	Test Modulation	Resource Block & RB offset	Low Channel (dBm)	Middle Channel (dBm)	High Channel (dBm)
15M	QPSK	RB1#0	24.64	24.69	24.69
		RB1#38	24.84	24.81	24.83
		RB1#74	24.69	24.67	24.66
		RB36#0	23.88	23.89	23.90
		RB36#39	23.95	23.92	23.89
		RB75#0	23.87	23.90	23.90
	16-QAM	RB1#0	24.10	23.75	23.93
		RB1#38	24.27	23.93	24.08
		RB1#74	24.16	23.76	23.96
		RB36#0	22.79	22.84	22.83
		RB36#39	22.85	22.87	22.83
		RB75#0	22.89	22.88	22.83
20M	QPSK	RB1#0	<u>25.30</u>	<u>25.27</u>	<u>25.30</u>
		RB1#50	24.94	24.96	25.00
		RB1#99	24.56	24.53	24.54
		RB50#0	<u>23.78</u>	<u>23.75</u>	<u>23.73</u>
		RB50#50	23.72	23.74	23.67
		RB100#0	23.75	23.77	23.74
	16-QAM	RB1#0	23.78	23.79	23.63
		RB1#50	24.23	24.23	24.04
		RB1#99	23.81	23.77	23.65
		RB50#0	22.77	22.80	22.76
		RB50#50	22.82	22.75	22.72
		RB100#0	22.83	22.81	22.77

**LTE Band 5 part1:**

Test Bandwidth	Test Modulation	Resource Block & RB offset	Low Channel (dBm)	Middle Channel (dBm)	High Channel (dBm)
1.4M	QPSK	RB1#0	23.95	24.00	23.99
		RB1#3	24.13	23.94	23.96
		RB1#5	24.02	24.00	24.02
		RB3#0	24.00	24.06	24.13
		RB3#3	24.01	24.05	24.15
		RB6#0	23.08	23.13	23.14
	16-QAM	RB1#0	22.92	23.08	22.98
		RB1#3	23.13	23.30	23.23
		RB1#5	22.96	23.08	23.07
		RB3#0	23.17	22.99	23.19
		RB3#3	23.15	23.02	23.17
		RB6#0	22.03	22.11	22.04
3M	QPSK	RB1#0	24.00	24.00	24.01
		RB1#8	24.07	24.06	24.05
		RB1#14	23.99	24.02	24.02
		RB6#0	22.96	23.01	23.04
		RB6#9	23.01	23.04	23.02
		RB15#0	22.97	23.01	23.06
	16-QAM	RB1#0	23.45	23.09	23.01
		RB1#8	23.44	23.14	23.07
		RB1#14	23.38	23.09	23.06
		RB6#0	21.98	21.98	21.94
		RB6#9	22.02	22.00	22.00
		RB15#0	21.99	21.94	22.10

**LTE Band 5 part2:**

Test Bandwidth	Test Modulation	Resource Block & RB offset	Low Channel (dBm)	Middle Channel (dBm)	High Channel (dBm)
5M	QPSK	RB1#0	23.84	23.89	23.92
		RB1#13	24.08	24.10	24.05
		RB1#24	23.90	23.91	23.89
		RB15#0	23.01	23.02	23.05
		RB15#10	23.00	23.00	23.10
		RB25#0	22.95	22.98	23.03
	16-QAM	RB1#0	22.72	23.15	22.96
		RB1#13	22.91	23.33	23.15
		RB1#24	22.73	23.10	22.97
		RB15#0	22.00	21.97	22.05
		RB15#10	21.98	21.97	22.09
		RB25#0	21.98	21.96	22.02
10M	QPSK	RB1#0	<u>24.16</u>	<u>24.19</u>	<u>24.22</u>
		RB1#25	23.92	24.17	24.18
		RB1#49	23.93	24.00	24.03
		RB25#0	<u>23.06</u>	<u>23.01</u>	<u>23.04</u>
		RB25#25	23.04	22.99	23.04
		RB50#0	23.03	22.97	23.02
	16-QAM	RB1#0	23.37	23.09	22.92
		RB1#25	23.63	23.28	23.17
		RB1#49	23.52	23.07	23.04
		RB25#0	22.02	22.03	22.07
		RB25#25	22.09	21.97	22.07
		RB50#0	22.00	21.96	22.01



**LTE Band 7 part1:**

Test Bandwidth	Test Modulation	Resource Block & RB offset	Low Channel (dBm)	Middle Channel (dBm)	High Channel (dBm)
5M	QPSK	RB1#0	22.15	22.22	22.23
		RB1#13	22.33	22.40	22.45
		RB1#24	22.17	22.22	22.30
		RB15#0	21.30	21.30	21.44
		RB15#10	21.32	21.33	21.43
		RB25#0	21.29	21.31	21.43
	16-QAM	RB1#0	21.08	21.47	21.35
		RB1#13	21.19	21.60	21.51
		RB1#24	21.01	21.46	21.37
		RB15#0	20.26	20.32	20.51
		RB15#10	20.37	20.30	20.47
		RB25#0	20.26	20.29	20.49
10M	QPSK	RB1#0	22.29	22.30	22.41
		RB1#25	22.04	22.46	22.17
		RB1#49	22.26	22.34	22.42
		RB25#0	21.29	21.37	21.48
		RB25#25	21.33	21.36	21.49
		RB50#0	21.33	21.33	21.50
	16-QAM	RB1#0	21.75	21.40	21.39
		RB1#25	21.90	21.60	21.60
		RB1#49	21.83	21.39	21.43
		RB25#0	20.37	20.39	20.63
		RB25#25	20.44	20.39	20.59
		RB50#0	20.35	20.37	20.54

**LTE Band 7 part2:**

Test Bandwidth	Test Modulation	Resource Block & RB offset	Low Channel (dBm)	Middle Channel (dBm)	High Channel (dBm)
15M	QPSK	RB1#0	22.22	22.19	22.27
		RB1#38	22.30	22.37	22.44
		RB1#74	22.17	22.19	22.33
		RB36#0	21.33	21.39	21.47
		RB36#39	21.36	21.42	21.45
		RB75#0	21.39	21.40	21.46
	16-QAM	RB1#0	21.68	21.31	21.67
		RB1#38	21.87	21.45	21.81
		RB1#74	21.81	21.35	21.75
		RB36#0	20.31	20.34	20.50
		RB36#39	20.39	20.38	20.50
		RB75#0	20.36	20.40	20.44
20M	QPSK	RB1#0	<u>22.40</u>	<u>22.54</u>	<u>22.57</u>
		RB1#50	22.34	22.07	22.56
		RB1#99	21.96	22.10	22.17
		RB50#0	21.33	21.37	21.46
		RB50#50	21.29	21.30	21.35
		RB100#0	21.22	21.35	21.40
	16-QAM	RB1#0	21.48	21.38	21.38
		RB1#50	21.98	21.73	21.75
		RB1#99	21.60	21.41	21.41
		RB50#0	20.21	20.26	20.52
		RB50#50	20.32	20.29	20.40
		RB100#0	20.28	20.31	20.46

**LTE Band 12 part1:**

Test Bandwidth	Test Modulation	Resource Block & RB offset	Low Channel (dBm)	Middle Channel (dBm)	High Channel (dBm)
1.4M	QPSK	RB1#0	24.38	24.41	24.30
		RB1#3	23.83	23.83	23.88
		RB1#5	24.40	24.37	24.32
		RB3#0	24.43	24.34	24.27
		RB3#3	24.45	24.32	24.33
		RB6#0	23.45	23.48	23.37
	16-QAM	RB1#0	23.33	23.37	23.24
		RB1#3	23.51	23.58	23.48
		RB1#5	23.35	23.43	23.25
		RB3#0	23.57	23.22	23.33
		RB3#3	23.56	23.24	23.34
		RB6#0	22.48	22.44	22.28
3M	QPSK	RB1#0	23.91	23.89	23.82
		RB1#8	24.05	24.04	24.07
		RB1#14	23.85	23.90	23.80
		RB6#0	23.97	23.89	23.85
		RB6#9	23.95	23.81	23.83
		RB15#0	22.97	22.98	22.89
	16-QAM	RB1#0	22.86	22.89	22.74
		RB1#8	23.00	23.06	22.95
		RB1#14	22.84	22.88	22.77
		RB6#0	23.07	22.71	22.81
		RB6#9	23.07	22.76	22.86
		RB15#0	21.96	21.94	21.78

**LTE Band 12 part2:**

Test Bandwidth	Test Modulation	Resource Block & RB offset	Low Channel (dBm)	Middle Channel (dBm)	High Channel (dBm)
5M	QPSK	RB1#0	23.82	23.83	23.78
		RB1#13	23.90	23.90	23.84
		RB1#24	23.87	23.92	23.80
		RB15#0	22.79	22.91	22.81
		RB15#10	22.95	22.82	22.85
		RB25#0	22.82	22.81	22.77
	16-QAM	RB1#0	22.73	23.00	22.82
		RB1#13	22.72	23.07	22.90
		RB1#24	22.71	23.07	22.81
		RB15#0	21.83	21.86	21.86
		RB15#10	21.97	21.72	21.81
		RB25#0	21.87	21.77	21.80
10M	QPSK	RB1#0	<u>24.57</u>	<u>24.57</u>	<u>24.50</u>
		RB1#25	24.08	24.07	24.10
		RB1#49	23.94	23.89	23.90
		RB25#0	22.77	22.96	22.93
		RB25#25	22.81	22.93	22.91
		RB50#0	22.82	22.93	22.90
	16-QAM	RB1#0	23.30	22.93	22.76
		RB1#25	23.50	23.09	23.01
		RB1#49	23.26	23.01	22.84
		RB25#0	21.83	21.94	21.96
		RB25#25	21.86	21.90	21.99
		RB50#0	21.79	21.90	21.90

**LTE Band 66 part1:**

Test Bandwidth	Test Modulation	Resource Block & RB offset	Low Channel (dBm)	Middle Channel (dBm)	High Channel (dBm)
1.4M	QPSK	RB1#0	24.68	24.67	24.61
		RB1#3	24.85	24.89	24.86
		RB1#5	24.69	24.70	24.62
		RB3#0	24.79	24.74	24.71
		RB3#3	24.86	24.76	24.78
		RB6#0	23.74	23.79	23.67
	16-QAM	RB1#0	23.63	23.75	23.61
		RB1#3	23.86	23.97	23.81
		RB1#5	23.67	23.77	23.66
		RB3#0	23.94	23.64	23.78
		RB3#3	23.94	23.65	23.73
		RB6#0	22.79	22.79	22.63
3M	QPSK	RB1#0	24.68	24.69	24.69
		RB1#8	24.68	24.71	24.64
		RB1#14	24.70	24.68	24.64
		RB6#0	23.67	23.69	23.61
		RB6#9	23.66	23.65	23.58
		RB15#0	23.67	23.67	23.66
	16-QAM	RB1#0	24.16	23.81	23.66
		RB1#8	24.15	23.75	23.64
		RB1#14	24.14	23.76	23.59
		RB6#0	22.76	22.67	22.58
		RB6#9	22.74	22.68	22.53
		RB15#0	22.78	22.67	22.72

**LTE Band 66 part2:**

Test Bandwidth	Test Modulation	Resource Block & RB offset	Low Channel (dBm)	Middle Channel (dBm)	High Channel (dBm)
5M	QPSK	RB1#0	24.60	24.63	24.56
		RB1#13	24.72	24.76	24.69
		RB1#24	24.61	24.66	24.54
		RB15#0	23.76	23.70	23.69
		RB15#10	23.77	23.70	23.68
		RB25#0	23.70	23.67	23.60
	16-QAM	RB1#0	23.47	23.86	23.59
		RB1#13	23.61	23.95	23.72
		RB1#24	23.49	23.85	23.60
		RB15#0	22.81	22.71	22.73
		RB15#10	22.81	22.73	22.72
		RB25#0	22.80	22.71	22.72
10M	QPSK	RB1#0	24.78	24.76	24.77
		RB1#25	24.93	24.86	24.87
		RB1#49	24.79	24.75	24.71
		RB25#0	23.77	23.76	23.70
		RB25#25	23.79	23.73	23.65
		RB50#0	23.81	23.77	23.68
	16-QAM	RB1#0	24.21	23.86	23.64
		RB1#25	24.36	23.97	23.70
		RB1#49	24.20	23.79	23.66
		RB25#0	22.82	22.82	22.79
		RB25#25	22.89	22.79	22.81
		RB50#0	22.85	22.79	22.77

**LTE Band 66 part3:**

Test Bandwidth	Test Modulation	Resource Block & RB offset	Low Channel (dBm)	Middle Channel (dBm)	High Channel (dBm)
15M	QPSK	RB1#0	24.64	24.68	24.65
		RB1#38	24.78	24.82	24.79
		RB1#74	24.72	24.64	24.63
		RB36#0	23.89	23.91	23.90
		RB36#39	23.91	23.91	23.80
		RB75#0	23.90	23.87	23.86
	16-QAM	RB1#0	24.12	23.77	23.90
		RB1#38	24.26	23.90	23.98
		RB1#74	24.17	23.76	23.91
		RB36#0	22.84	22.83	22.78
		RB36#39	22.86	22.83	22.75
		RB75#0	22.89	22.86	22.77
20M	QPSK	RB1#0	<u>24.95</u>	<u>24.94</u>	<u>24.95</u>
		RB1#50	24.47	24.49	24.40
		RB1#99	24.54	24.50	24.43
		RB50#0	23.76	23.77	23.67
		RB50#50	23.72	23.74	23.64
		RB100#0	23.72	23.75	23.67
	16-QAM	RB1#0	23.77	23.93	23.67
		RB1#50	24.17	24.36	24.08
		RB1#99	23.79	23.94	23.70
		RB50#0	22.72	22.80	22.72
		RB50#50	22.75	22.75	22.63
		RB100#0	22.81	22.79	22.68

**LTE Band 71 part1:**

Test Bandwidth	Test Modulation	Resource Block & RB offset	Low Channel (dBm)	Middle Channel (dBm)	High Channel (dBm)
5M	QPSK	RB1#0	24.01	21.21	23.73
		RB1#13	23.17	24.29	22.89
		RB1#24	23.45	21.21	22.68
		RB15#0	22.61	24.01	23.45
		RB15#10	24.57	23.45	21.77
		RB25#0	22.61	22.89	23.17
	16-QAM	RB1#0	22.05	23.45	24.01
		RB1#13	22.33	23.45	23.14
		RB1#24	21.93	24.29	22.89
		RB15#0	22.05	22.05	23.45
		RB15#10	22.89	23.45	23.45
		RB25#0	21.49	24.01	21.49
10M	QPSK	RB1#0	23.17	23.73	23.15
		RB1#25	22.33	22.61	23.45
		RB1#49	23.73	23.17	23.25
		RB25#0	21.93	23.17	23.17
		RB25#25	21.77	24.57	24.57
		RB50#0	24.29	24.29	21.49
	16-QAM	RB1#0	23.17	22.61	21.21
		RB1#25	21.49	23.17	23.73
		RB1#49	23.45	22.61	21.77
		RB25#0	21.93	24.29	23.73
		RB25#25	23.73	24.29	23.45
		RB50#0	22.05	23.17	24.01



**LTE Band 71 part2:**

Test Bandwidth	Test Modulation	Resource Block & RB offset	Low Channel (dBm)	Middle Channel (dBm)	High Channel (dBm)
15M	QPSK	RB1#0	21.91	23.73	24.01
		RB1#38	24.29	22.61	23.73
		RB1#74	21.49	22.61	21.77
		RB36#0	23.73	22.89	22.67
		RB36#39	23.73	24.29	24.01
		RB75#0	22.33	23.45	24.29
	16-QAM	RB1#0	21.77	21.21	24.57
		RB1#38	24.57	21.77	22.05
		RB1#74	22.05	22.38	22.33
		RB36#0	23.45	21.21	23.45
		RB36#39	22.89	22.46	21.77
		RB75#0	24.57	21.49	24.29
20M	QPSK	RB1#0	<u>24.57</u>	<u>24.57</u>	<u>24.57</u>
		RB1#50	22.35	24.29	22.82
		RB1#99	22.61	22.89	21.77
		RB50#0	24.01	24.57	23.45
		RB50#50	21.21	24.29	22.89
		RB100#0	23.73	23.45	23.24
	16-QAM	RB1#0	22.05	21.62	21.49
		RB1#50	22.05	22.05	23.73
		RB1#99	23.17	22.89	21.77
		RB50#0	22.33	21.95	22.33
		RB50#50	23.73	23.17	24.29
		RB100#0	24.01	21.77	24.29

**Bluetooth Power:**

Mode	Channel	Freq.(MHz)	Conducted Power(Peak/dBm)
GFSK	Low	2402	10.77
	Middle	2441	11.73
		2450	12.50
	High	2480	6.84
$\pi/4$ DQPSK	Low	2402	10.30
	Middle	2441	11.07
		2450	11.85
	High	2480	6.07
8DPSK	Low	2402	10.31
	Middle	2441	11.10
		2450	11.56
	High	2480	6.08
LE 1M	Low	2402	-3.89
	Middle	2440	-3.15
	High	2480	-5.47

**WiFi 2.4G Power:**

Mode	Channel	Freq.(MHz)	Data Rate	Conducted Power(Avg/dBm)
802.11b	Low	2412	1Mbps	<u>9.38</u>
	Middle	2437		9.32
	High	2462		9.30
802.11g	Low	2412	6Mbps	9.36
	Middle	2437		9.33
	High	2462		9.15
802.11n20	Low	2412	MCS0	9.31
	Middle	2437		9.21
	High	2462		9.36
802.11n40	Low	2422	MCS0	9.15
	Middle	2437		9.28
	High	2452		8.88

**WiFi 5GHz Power:**

Band	Mode	Channel	Freq.(MHz)	Conducted Power(dBm)
5.2GHz	802.11a	Low	5180	<u>11.61</u>
		Middle	5200	11.58
		High	5240	11.06
	802.11nHT20	Low	5180	9.55
		Middle	5200	9.46
		High	5240	9.87
	802.11nHT40	Low	5190	9.37
		High	5230	9.16
	802.11ac80	Middle	5210	9.29
Mode	Mode	Channel	Freq.(MHz)	Conducted Power(dBm)
5.8GHz	802.11a	Low	5745	10.92
		Middle	5785	<u>11.05</u>
		High	5825	9.8
	802.11nHT20	Low	5745	9.15
		Middle	5785	9.56
		High	5825	9.22
	802.11nHT40	Low	5755	9.15
		High	5795	9.11
	802.11ac80	Middle	5775	9.54

# STANDALONE SAR TEST EXCLUSION CONSIDERATIONS

## Antennas Location:

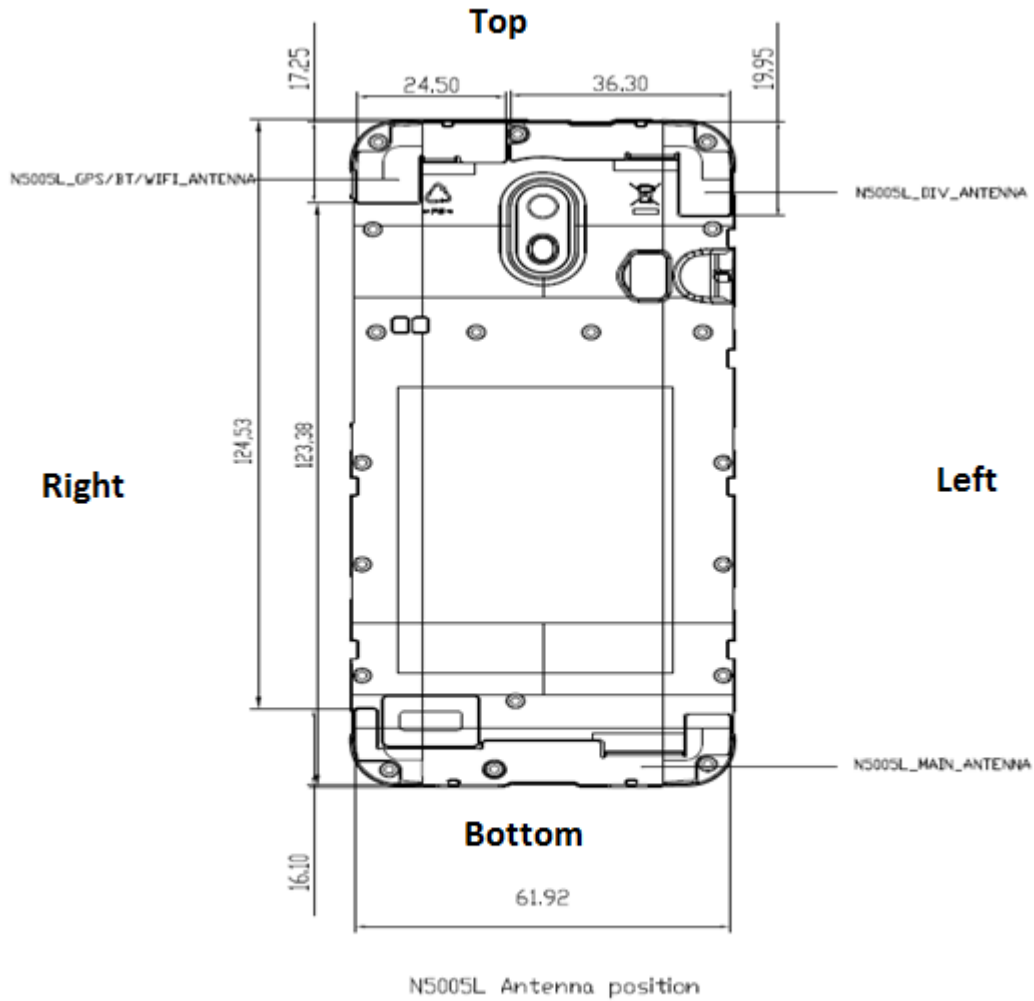

*Note: The LTE DIV antenna can't transmit and is receiving only.*

### Antenna Distance to Edge(Front View)

Antenna	Antenna Distance To Edge(mm)					
	Front	Back	Left	Right	Top	Bottom
WWAN	<5	<5	<5	<5	124.53	<5
WLAN/BT	<5	<5	36.30	<5	<5	123.38

**NOTE:**

- 1) The 1-g and 10-g SAR test exclusion thresholds for 100 MHz to 6 GHz at *test separation distances*  $\leq 50$  mm are determined by:

$[(\text{max. power of channel, including tune-up tolerance, mW}) / (\text{min. test separation distance, mm})] \cdot [\sqrt{f_{(\text{GHz})}}] \leq 3.0$  for 1-g SAR and  $\leq 7.5$  for 10-g extremity SAR,<sup>16</sup> where

- $f_{(\text{GHz})}$  is the RF channel transmit frequency in GHz
- Power and distance are rounded to the nearest mW and mm before calculation<sup>17</sup>
- The result is rounded to one decimal place for comparison

The test exclusions are applicable only when the minimum *test separation distance* is  $\leq 50$  mm and for transmission frequencies between 100 MHz and 6 GHz. When the minimum *test separation distance* is  $< 5$  mm, a distance of 5 mm is applied to determine SAR test exclusion.

- 2) At 100 MHz to 6 GHz and for *test separation distances*  $> 50$  mm, the SAR test exclusion threshold is determined according to the following, and as illustrated in Appendix B:<sup>18</sup>

- a) [Threshold at 50 mm in step 1) + (test separation distance - 50 mm) · ( $f_{(\text{MHz})} / 150$ )] mW, at 100 MHz to 1500 MHz
- b) [Threshold at 50 mm in step 1) + (test separation distance - 50 mm) · 10] mW at  $> 1500$  MHz and  $\leq 6$  GHz

**Standalone SAR test exclusion considerations (for Ant. to Edge Distance  $\leq$  50mm)**

Mode	Frequency (MHz)	Output power (dBm)	Output power (mW)	Distance (mm)	Calculated value	Threshold (1g)	SAR Test Exclusion
WLAN 2.4G	2412	9.5	8.91	5	2.8	3	YES
WLAN 5.2G	5200	12	15.85	12.0	3.0	3	YES
WLAN 5.8G	5785	11.5	14.13	11.2	3.0	3	YES
Bluetooth	2450	13	19.95	10.3	3.0	3	YES

**Note :**

- 1) Peak power for BT, average power for Wi-Fi
- 2) 2.4G WiFi according to KDB447498 D01 4.3.1 a) Although it is up to or exempt, there is still an estimated SAR value

**Standalone SAR test exclusion considerations (for Ant. to Top Distance > 50mm)**

Mode	Frequency (MHz)	Output power (dBm)	Output power (mW)	Ant. To Edge Distance (mm)	Exclusion Power (mW)
GPRS 850	836.6	33	1995.26	124.53	909.30
GPRS 1900	1880	30	1000.00	124.53	854.70
WCDMA 2	1880	24	251.19	124.53	854.70
WCDMA 4	1732.6	24	251.19	124.53	859.26
WCDMA 5	836.4	24	251.19	124.53	909.32
LTE Band 2	1900	24.5	281.84	124.53	854.12
LTE Band 4	1745	25.5	354.81	124.53	858.85
LTE Band 5	836.5	24.5	281.84	124.53	909.31
LTE Band 7	2535	23	199.53	124.53	839.51
LTE Band 12	707.5	25	316.23	124.53	923.63
LTE Band 66	1720	25	316.23	124.53	859.67
LTE Band 71	680.5	25	316.23	124.53	927.13

**SAR test exclusion for the EUT edge considerations Result** (Required: O / Exclusion: X)

Mode	Back	Front	Left	Right	Top	Bottom
GPRS 850	O	O	O	O	O	O
GPRS 1900	O	O	O	O	O	O
WCDMA Band 2	O	O	O	O	X	O
WCDMA Band 4	O	O	O	O	X	O
WCDMA Band 5	O	O	O	O	X	O
LTE Band 2	O	O	O	O	X	O
LTE Band 4	O	O	O	O	X	O
LTE Band 5	O	O	O	O	X	O
LTE Band 7	O	O	O	O	X	O
LTE Band 12	O	O	O	O	X	O
LTE Band 66	O	O	O	O	X	O
LTE Band 71	O	O	O	O	X	O
WLAN2.4G	O	O	X	O	O	X
WLAN 5.2G	O	O	X	O	O	X
WLAN 5.8G	O	O	X	O	O	X
Bluetooth	O	O	X	O	O	X

**Note:**

Required: The distance is less than Test Exclusion Distance, testing is required.

Exclusion\*: SAR test exclusion evaluation has been done above.

Exclusion: The distance is larger than Test Exclusion Distance, testing is not required.

## SAR MEASUREMENT RESULTS

This page summarizes the results of the performed diametric evaluation.

### SAR Test Data

#### Environmental Conditions

<b>Test Date</b>	2021/08/31	2021/08/31	2021/09/01	2021/09/10
<b>Freq. Band(MHz)</b>	2450	5200	5800	1900
<b>Temperature</b>	23.2°C	22.9°C	23.1°C	23.5°C
<b>Relative Humidity</b>	54 %	56 %	52 %	55 %
<b>Test Engineer</b>	Nike Wu / Woods Chen	Nike Wu / Woods Chen	Nike Wu / Woods Chen	Nike Wu / Woods Chen

<b>Test Date</b>	2021/09/11	2021/09/13	2021/09/14	2021/09/15
<b>Freq. Band(MHz)</b>	1800	835	750	650
<b>Temperature</b>	23.3°C	23.4°C	23.2°C	22.9°C
<b>Relative Humidity</b>	57 %	59 %	61 %	58 %
<b>Test Engineer</b>	Nike Wu / Woods Chen	Nike Wu / Woods Chen	Nike Wu / Woods Chen	Nike Wu / Woods Chen

<b>Test Date</b>	2021/09/15
<b>Freq. Band(MHz)</b>	2600
<b>Temperature</b>	23.3°C
<b>Relative Humidity</b>	56 %
<b>Test Engineer</b>	Nike Wu / Woods Chen



**GPRS850 :**

EUT Position	Frequency (MHz)	Test Mode	Max. Meas. Power (dBm)	Max. Rated Power (dBm)	1g SAR (W/Kg)				
					Scaled Factor	Meas. SAR	Scaled SAR	Limit	Plot
Body Back(10mm)	836.6	GPRS 3Tx	24.71	25.00	1.069	0.018	0.019	1.6	53
Body Front(10mm)	836.6	GPRS 3Tx	24.71	25.00	1.069	0.015	0.016	1.6	54
Body Hotspot Back(10mm)	836.6	GPRS 3Tx	24.71	25.00	1.069	0.017	0.018	1.6	55
Body Hotspot Front(10mm)	836.6	GPRS 3Tx	24.71	25.00	1.069	0.013	0.014	1.6	56
Body Hotspot Left(10mm)	836.6	GPRS 3Tx	24.71	25.00	1.069	0.009	0.010	1.6	57
Body Hotspot Right(10mm)	836.6	GPRS 3Tx	24.71	25.00	1.069	0.016	0.017	1.6	58
Body Hotspot Bottom(10mm)	836.6	GPRS 3Tx	24.71	25.00	1.069	0.004	0.004	1.6	59
Body Hotspot Top(10mm)	836.6	GPRS 3Tx	24.71	25.00	1.069	0.005	0.005	1.6	59-2

**GPRS1900 :**

EUT Position	Frequency (MHz)	Test Mode	Max. Meas. Power (dBm)	Max. Rated Power (dBm)	1g SAR (W/Kg)				
					Scaled Factor	Meas. SAR	Scaled SAR	Limit	Plot
Body Back(10mm)	1880	GPRS 2Tx	22.35	22.50	1.035	0.532	0.551	1.6	60
Body Front(10mm)	1880	GPRS 2Tx	22.35	22.50	1.035	0.535	0.554	1.6	61
Body Hotspot Back(10mm)	1880	GPRS 2Tx	22.35	22.50	1.035	0.514	0.532	1.6	62
Body Hotspot Front(10mm)	1880	GPRS 2Tx	22.35	22.50	1.035	0.569	0.589	1.6	63
Body Hotspot Left(10mm)	1880	GPRS 2Tx	22.35	22.50	1.035	0.133	0.138	1.6	64
Body Hotspot Right(10mm)	1880	GPRS 2Tx	22.35	22.50	1.035	0.313	0.324	1.6	65
Body Hotspot Bottom(10mm)	1880	GPRS 2Tx	22.35	22.50	1.035	0.399	0.413	1.6	66
Body Hotspot Top(10mm)	1880	GPRS 2Tx	22.35	22.50	1.035	0.024	0.025	1.6	66-2

**WCDMA Band 2 :**

EUT Position	Frequency (MHz)	Test Mode	Max. Meas. Power (dBm)	Max. Rated Power (dBm)	1g SAR (W/Kg)				
					Scaled Factor	Meas. SAR	Scaled SAR	Limit	Plot
Body Hotspot Back(10mm)	1852.4	RMC	23.52	24.00	1.117	0.850	0.949	1.6	1-2
	1880	RMC	23.67	24.00	1.079	0.765	0.825	1.6	1
	1907.6	RMC	23.62	24.00	1.091	0.680	0.742	1.6	1-3
Body Hotspot Front(10mm)	1880	RMC	23.67	24.00	1.079	0.740	0.798	1.6	2
Body Hotspot Left(10mm)	1880	RMC	23.67	24.00	1.079	0.173	0.187	1.6	3
Body Hotspot Right(10mm)	1880	RMC	23.67	24.00	1.079	0.415	0.448	1.6	4
Body Hotspot Bottom(10mm)	1880	RMC	23.67	24.00	1.079	0.552	0.596	1.6	5

**WCDMA Band 4 :**

EUT Position	Frequency (MHz)	Test Mode	Max. Meas. Power (dBm)	Max. Rated Power (dBm)	1g SAR (W/Kg)				
					Scaled Factor	Meas. SAR	Scaled SAR	Limit	Plot
Body Hotspot Back(10mm)	1712.4	RMC	23.82	24.00	1.042	1.040	1.084	1.6	6-2
	1732.6	RMC	23.96	24.00	1.009	0.998	1.007	1.6	6
	1752.6	RMC	23.98	24.00	1.005	0.964	0.968	1.6	6-3
Body Hotspot Front(10mm)	1712.4	RMC	23.82	24.00	1.042	0.916	0.955	1.6	7-2
	1732.6	RMC	23.96	24.00	1.009	0.907	0.915	1.6	7
	1752.6	RMC	23.98	24.00	1.005	0.885	0.889	1.6	7-3
Body Hotspot Left(10mm)	1732.6	RMC	23.96	24.00	1.009	0.361	0.364	1.6	8
Body Hotspot Right(10mm)	1732.6	RMC	23.96	24.00	1.009	0.265	0.267	1.6	9
Body Hotspot Bottom(10mm)	1732.6	RMC	23.96	24.00	1.009	0.408	0.412	1.6	10

**WCDMA Band 5 :**

EUT Position	Frequency (MHz)	Test Mode	Max. Meas. Power (dBm)	Max. Rated Power (dBm)	1g SAR (W/Kg)				
					Scaled Factor	Meas. SAR	Scaled SAR	Limit	Plot
Body Hotspot Back(10mm)	836.4	RMC	23.85	24.00	1.035	0.497	0.514	1.6	13
Body Hotspot Front(10mm)	836.4	RMC	23.85	24.00	1.035	0.475	0.492	1.6	14
Body Hotspot Left(10mm)	836.4	RMC	23.85	24.00	1.035	0.377	0.390	1.6	15
Body Hotspot Right(10mm)	836.4	RMC	23.85	24.00	1.035	0.484	0.501	1.6	16
Body Hotspot Bottom(10mm)	836.4	RMC	23.85	24.00	1.035	0.101	0.105	1.6	17

**LTE FDD Band 2 :**

EUT Position	Frequency (MHz)	Modulation Type	Bandwidth (MHz)	RB	Max. Meas. Power (dBm)	Max. Rated Power (dBm)	1g SAR (W/Kg)				
							Scaled Factor	Meas. SAR	Scaled SAR	Limit	Plot
Body Hotpot Back(10mm)	1860	QPSK	20	1	24.04	24.50	1.112	0.869	0.966	1.6	18-3
	1880	QPSK	20	1	23.81	24.50	1.172	0.846	0.992	1.6	18
	1900	QPSK	20	1	23.63	24.50	1.222	0.764	0.933	1.6	18-4
	1860	QPSK	20	50%	22.77	24.50	1.496	0.699	1.041	1.6	18-2
	1880	QPSK	20	50%	22.69	24.50	1.517	0.698	1.059	1.6	18-5
	1900	QPSK	20	50%	22.49	24.50	1.589	0.613	0.974	1.6	18-6
Body Hotpot Front(10mm)	1860	QPSK	20	1	24.04	24.50	1.112	0.819	0.911	1.6	19-3
	1880	QPSK	20	1	23.81	24.50	1.172	0.815	0.955	1.6	19
	1900	QPSK	20	1	23.63	24.50	1.222	0.732	0.894	1.6	19-4
	1860	QPSK	20	50%	22.77	24.50	1.496	0.661	0.984	1.6	19-5
	1880	QPSK	20	50%	22.69	24.50	1.517	0.679	1.030	1.6	19-2
	1900	QPSK	20	50%	22.49	24.50	1.589	0.595	0.945	1.6	19-6
Body Hotpot Left(10mm)	1880	QPSK	20	1	23.81	24.50	1.172	0.180	0.211	1.6	20
	1880	QPSK	20	50%	22.69	24.50	1.517	0.150	0.228	1.6	20-2
Body Hotpot Right(10mm)	1880	QPSK	20	1	23.81	24.50	1.172	0.387	0.454	1.6	21
	1880	QPSK	20	50%	22.69	24.50	1.517	0.331	0.502	1.6	21-2
Body Hotpot Bottom(10mm)	1880	QPSK	20	1	23.81	24.50	1.172	0.553	0.648	1.6	22
	1880	QPSK	20	50%	22.69	24.50	1.517	0.476	0.722	1.6	22-2

**LTE FDD Band 4 :**

EUT Position	Frequency (MHz)	Modulation Type	Bandwidth (MHz)	RB	Max. Meas. Power (dBm)	Max. Rated Power (dBm)	1g SAR (W/Kg)				
							Scaled Factor	Meas. SAR	Scaled SAR	Limit	Plot
Body Hotpot Back(10mm)	1720	QPSK	20	1	25.30	25.50	1.047	0.972	1.018	1.6	23-2
	1732.5	QPSK	20	1	25.27	25.50	1.054	0.991	1.045	1.6	23
	1745	QPSK	20	1	25.30	25.50	1.047	0.962	1.007	1.6	23-3
	1720	QPSK	20	50%	23.78	25.50	1.486	0.705	1.048	1.6	23-5
	1732.5	QPSK	20	50%	23.75	25.50	1.496	0.811	1.213	1.6	23-4
	1745	QPSK	20	50%	23.73	25.50	1.503	0.656	0.986	1.6	23-6
Body Hotpot Front(10mm)	1720	QPSK	20	1	25.30	25.50	1.047	1.040	1.089	1.6	24-3
	1732.5	QPSK	20	1	25.27	25.50	1.054	0.775	0.817	1.6	24
	1745	QPSK	20	1	25.30	25.50	1.047	1.010	1.058	1.6	24-4
	1720	QPSK	20	50%	23.78	25.50	1.486	0.746	1.109	1.6	24-5
	1732.5	QPSK	20	50%	23.75	25.50	1.496	0.635	0.950	1.6	24-2
	1745	QPSK	20	50%	23.73	25.50	1.503	0.694	1.043	1.6	24-6
Body Hotpot Left(10mm)	1732.5	QPSK	20	1	25.27	25.50	1.054	0.382	0.403	1.6	25
	1732.5	QPSK	20	50%	23.75	25.50	1.496	0.310	0.464	1.6	25-2
Body Hotpot Right(10mm)	1732.5	QPSK	20	1	25.27	25.50	1.054	0.282	0.297	1.6	26
	1732.5	QPSK	20	50%	23.75	25.50	1.496	0.238	0.356	1.6	26-2
Body Hotpot Bottom(10mm)	1732.5	QPSK	20	1	25.27	25.50	1.054	0.465	0.490	1.6	27
	1732.5	QPSK	20	50%	23.75	25.50	1.496	0.391	0.585	1.6	27-2

**LTE FDD Band 5 :**

EUT Position	Frequency (MHz)	Modulation Type	Bandwidth (MHz)	RB	Max. Meas. Power (dBm)	Max. Rated Power (dBm)	1g SAR (W/Kg)				
							Scaled Factor	Meas. SAR	Scaled SAR	Limit	Plot
Body Hotpot Back(10mm)	836.5	QPSK	10	1	24.19	24.50	1.074	0.459	0.493	1.6	28
	836.5	QPSK	10	50%	23.01	24.50	1.409	0.417	0.588	1.6	28-2
Body Hotpot Front(10mm)	836.5	QPSK	10	1	24.19	24.50	1.074	0.431	0.463	1.6	29
	836.5	QPSK	10	50%	23.01	24.50	1.409	0.371	0.523	1.6	29-2
Body Hotpot Left(10mm)	836.5	QPSK	10	1	24.19	24.50	1.074	0.380	0.408	1.6	30
	836.5	QPSK	10	50%	23.01	24.50	1.409	0.301	0.424	1.6	30-2
Body Hotpot Right(10mm)	836.5	QPSK	10	1	24.19	24.50	1.074	0.471	0.506	1.6	31
	836.5	QPSK	10	50%	23.01	24.50	1.409	0.378	0.533	1.6	31-2
Body Hotpot Bottom(10mm)	836.5	QPSK	10	1	24.19	24.50	1.074	0.091	0.098	1.6	32
	836.5	QPSK	10	50%	23.01	24.50	1.409	0.076	0.107	1.6	32-2



**LTE FDD Band 7 :**

EUT Position	Frequency (MHz)	Modulation Type	Bandwidth (MHz)	RB	Max. Meas. Power (dBm)	Max. Rated Power (dBm)	1g SAR (W/Kg)				
							Scaled Factor	Meas. SAR	Scaled SAR	Limit	Plot
Body Hotpot Back(10mm)	2535	QPSK	20	1	22.54	23.00	1.112	0.651	0.724	1.6	33
	2535	QPSK	20	50%	21.37	23.00	1.455	0.530	0.771	1.6	33-2
Body Hotpot Front(10mm)	2535	QPSK	20	1	22.54	23.00	1.112	0.483	0.537	1.6	34
	2535	QPSK	20	50%	21.37	23.00	1.455	0.408	0.594	1.6	34-2
Body Hotpot Left(10mm)	2535	QPSK	20	1	22.54	23.00	1.112	0.349	0.388	1.6	35
	2535	QPSK	20	50%	21.37	23.00	1.455	0.301	0.438	1.6	35-2
Body Hotpot Right(10mm)	2535	QPSK	20	1	22.54	23.00	1.112	0.149	0.166	1.6	36
	2535	QPSK	20	50%	21.37	23.00	1.455	0.124	0.180	1.6	36-2
Body Hotpot Bottom(10mm)	2535	QPSK	20	1	22.54	23.00	1.112	0.571	0.635	1.6	37
	2535	QPSK	20	50%	21.37	23.00	1.455	0.471	0.686	1.6	37-2

**LTE FDD Band 12 :**

EUT Position	Frequency (MHz)	Modulation Type	Bandwidth (MHz)	RB	Max. Meas. Power (dBm)	Max. Rated Power (dBm)	1g SAR (W/Kg)				
							Scaled Factor	Meas. SAR	Scaled SAR	Limit	Plot
Body Hotpot Back(10mm)	707.5	QPSK	10	1	24.57	25.00	1.104	0.504	0.556	1.6	48
	707.5	QPSK	10	50%	22.96	25.00	1.600	0.425	0.680	1.6	48-4
Body Hotpot Front(10mm)	707.5	QPSK	10	1	24.57	25.00	1.104	0.368	0.406	1.6	49
	707.5	QPSK	10	50%	22.96	25.00	1.600	0.290	0.464	1.6	49-2
Body Hotpot Left(10mm)	707.5	QPSK	10	1	24.57	25.00	1.104	0.281	0.310	1.6	50
	707.5	QPSK	10	50%	22.96	25.00	1.600	0.221	0.354	1.6	50-2
Body Hotpot Right(10mm)	707.5	QPSK	10	1	24.57	25.00	1.104	0.343	0.379	1.6	51
	707.5	QPSK	10	50%	22.96	25.00	1.600	0.272	0.435	1.6	51-2
Body Hotpot Bottom(10mm)	707.5	QPSK	10	1	24.57	25.00	1.104	0.058	0.064	1.6	52
	707.5	QPSK	10	50%	22.96	25.00	1.600	0.046	0.074	1.6	52-2

**LTE FDD Band 66 :**

EUT Position	Frequency (MHz)	Modulation Type	Bandwidth (MHz)	RB	Max. Meas. Power (dBm)	Max. Rated Power (dBm)	1g SAR (W/Kg)				
							Scaled Factor	Meas. SAR	Scaled SAR	Limit	Plot
Body Hotpot Back(10mm)	1720	QPSK	20	1	24.95	25.00	1.012	1.080	1.093	1.6	38-2
	1745	QPSK	20	1	24.94	25.00	1.014	1.060	1.075	1.6	38
	1770	QPSK	20	1	24.95	25.00	1.012	1.030	1.042	1.6	38-3
	1720	QPSK	20	50%	23.76	25.00	1.330	0.883	1.175	1.6	38-5
	1745	QPSK	20	50%	23.77	25.00	1.327	0.831	1.103	1.6	38-4
	1770	QPSK	20	50%	23.67	25.00	1.358	0.786	1.068	1.6	38-6
Body Hotpot Front(10mm)	1720	QPSK	20	1	24.95	25.00	1.012	1.080	1.093	1.6	39-3
	1745	QPSK	20	1	24.94	25.00	1.014	1.040	1.054	1.6	39
	1770	QPSK	20	1	24.95	25.00	1.012	1.010	1.022	1.6	39-4
	1720	QPSK	20	50%	23.76	25.00	1.330	0.915	1.217	1.6	39-5
	1745	QPSK	20	50%	23.77	25.00	1.327	0.879	1.167	1.6	39-2
	1770	QPSK	20	50%	23.67	25.00	1.358	0.847	1.150	1.6	39-6
Body Hotpot Left(10mm)	1745	QPSK	20	1	24.94	25.00	1.014	0.411	0.417	1.6	40
	1745	QPSK	20	50%	23.77	25.00	1.327	0.337	0.447	1.6	40-2
Body Hotpot Right(10mm)	1745	QPSK	20	1	24.94	25.00	1.014	0.301	0.305	1.6	41
	1745	QPSK	20	50%	23.77	25.00	1.327	0.254	0.337	1.6	41-2
Body Hotpot Bottom(10mm)	1745	QPSK	20	1	24.94	25.00	1.014	0.419	0.425	1.6	42
	1745	QPSK	20	50%	23.77	25.00	1.327	0.347	0.461	1.6	42-2

**LTE FDD Band 71 :**

EUT Position	Frequency (MHz)	Modulation Type	Bandwidth (MHz)	RB	Max. Meas. Power (dBm)	Max. Rated Power (dBm)	1g SAR (W/Kg)				
							Scaled Factor	Meas. SAR	Scaled SAR	Limit	Plot
Body Hotpot Back(10mm)	680.5	QPSK	20	1	24.57	25.00	1.104	0.547	0.604	1.6	43
	680.5	QPSK	20	50%	24.57	25.00	1.104	0.452	0.499	1.6	43-4
Body Hotpot Front(10mm)	680.5	QPSK	20	1	24.57	25.00	1.104	0.379	0.418	1.6	44
	680.5	QPSK	20	50%	24.57	25.00	1.104	0.323	0.357	1.6	44-2
Body Hotpot Left(10mm)	680.5	QPSK	20	1	24.57	25.00	1.104	0.314	0.347	1.6	45
	680.5	QPSK	20	50%	24.57	25.00	1.104	0.246	0.272	1.6	45-2
Body Hotpot Right(10mm)	680.5	QPSK	20	1	24.57	25.00	1.104	0.348	0.384	1.6	46
	680.5	QPSK	20	50%	24.57	25.00	1.104	0.271	0.299	1.6	46-2
Body Hotpot Bottom(10mm)	680.5	QPSK	20	1	24.57	25.00	1.104	0.058	0.064	1.6	47
	680.5	QPSK	20	50%	24.57	25.00	1.104	0.045	0.050	1.6	47-2

**WiFi 2.4GHz :**

EUT Position	Frequency (MHz)	Modulation Type	Max. Meas. Power (dBm)	Max. Rated Power (dBm)	1g SAR (W/Kg)				
					Scaled Factor	Meas. SAR	Scaled SAR	Limit	Plot
Body Hotpot Back(10mm)	2412	802.11b	9.38	9.50	1.028	0.202	0.208	1.6	71
Body Hotpot Front(10mm)	2412	802.11b	9.38	9.50	1.028	0.113	0.116	1.6	72
Body Hotpot Right(10mm)	2412	802.11b	9.38	9.50	1.028	0.095	0.098	1.6	74
Body Hotpot Top(10mm)	2412	802.11b	9.38	9.50	1.028	0.194	0.199	1.6	76

**WiFi 5.2GHz :**

EUT Position	Frequency (MHz)	Modulation Type	Max. Meas. Power (dBm)	Max. Rated Power (dBm)	1g SAR (W/Kg)				
					Scaled Factor	Meas. SAR	Scaled SAR	Limit	Plot
Body Hotpot Back(10mm)	5200	802.11a	11.58	12.00	1.102	0.192	0.211	1.6	77
Body Hotpot Front(10mm)	5200	802.11a	11.58	12.00	1.102	0.015	0.017	1.6	78
Body Hotpot Right(10mm)	5200	802.11a	11.58	12.00	1.102	0.039	0.043	1.6	80
Body Hotpot Top(10mm)	5200	802.11a	11.58	12.00	1.102	0.056	0.062	1.6	81
Body Hotpot Back(10mm)	5210	802.11ac80	9.29	9.50	1.050	0.149	0.156	1.6	87
Body Hotpot Front(10mm)	5210	802.11ac80	9.29	9.50	1.050	0.018	0.018	1.6	88
Body Hotpot Right(10mm)	5210	802.11ac80	9.29	9.50	1.050	0.011	0.012	1.6	90
Body Hotpot Top(10mm)	5210	802.11ac80	9.29	9.50	1.050	0.034	0.036	1.6	91

**WiFi 5.8GHz :**

EUT Position	Frequency (MHz)	Modulation Type	Max. Meas. Power (dBm)	Max. Rated Power (dBm)	1g SAR (W/Kg)				
					Scaled Factor	Meas. SAR	Scaled SAR	Limit	Plot
Body Hotpot Back(10mm)	5785	802.11a	11.05	11.50	1.109	0.056	0.062	1.6	82
Body Hotpot Front(10mm)	5785	802.11a	11.05	11.50	1.109	0.039	0.043	1.6	83
Body Hotpot Right(10mm)	5785	802.11a	11.05	11.50	1.109	0.050	0.056	1.6	85
Body Hotpot Top(10mm)	5785	802.11a	11.05	11.50	1.109	0.088	0.098	1.6	86
Body Hotpot Back(10mm)	5775	802.11ac80	9.54	10.00	1.112	0.030	0.033	1.6	92
Body Hotpot Front(10mm)	5775	802.11ac80	9.54	10.00	1.112	0.013	0.014	1.6	93
Body Hotpot Right(10mm)	5775	802.11ac80	9.54	10.00	1.112	0.016	0.017	1.6	95
Body Hotpot Top(10mm)	5775	802.11ac80	9.54	10.00	1.112	0.077	0.085	1.6	96

**Bluetooth :**

EUT Position	Frequency (MHz)	Modulation Type	Max. Meas. Power (dBm)	Max. Rated Power (dBm)	1g SAR (W/Kg)				
					Scaled Factor	Meas. SAR	Scaled SAR	Limit	Plot
Body Hotpot Back(10mm)	2450	GFSK	12.55	13.00	1.109	0.018	0.019	1.6	67
Body Hotpot Front(10mm)	2450	GFSK	12.55	13.00	1.109	0.014	0.015	1.6	68
Body Hotpot Right(10mm)	2450	GFSK	12.55	13.00	1.109	0.017	0.019	1.6	69
Body Hotpot Top(10mm)	2450	GFSK	12.55	13.00	1.109	0.029	0.032	1.6	70

**Note:**

1. When the 1-g SAR is  $\leq 0.8\text{W/Kg}$ , testing for other channels are optional.
2. SAR for LTE band exposure configurations is measured according to the procedures of KDB 941225 D05 SAR for LTE Devices v02.
3. KDB941225D05-SAR for higher order modulation is required only when the highest maximum output power for the configuration in the higher order modulation is  $> 0.5\text{ dB}$  higher than the same configuration in QPSK or when the reported SAR for the QPSK configuration is  $> 1.45\text{ W/kg}$
4. KDB941225D05-For QPSK with 100% RB allocation, when the reported SAR measured for the Highest output power channel is  $< 1.45\text{ W/kg}$ , tests for the remaining required test channels are optional.
5. KDB941225D05- For QPSK with 100% RB allocation, SAR is not required when the highest maximum output power for 100 % RB allocation is less than the highest maximum output power in 50% and 1 RB allocations and the highest reported SAR for 1 RB and 50% RB allocation are  $\leq 0.8\text{ W/kg}$ .
6. KDB941225D05- Start with the largest channel bandwidth and measure SAR for QPSK with 1 RB allocation, using the RB offset and required test channel combination with the highest maximum output power among RB offset the upper edge, middle and lower edge of each required test channel.
7. KDB941225D05- other channel bandwidths SAR test is required when the highest maximum output power of a configuration requiring testing in the smaller channel bandwidth is  $> 0.5\text{ dB}$  higher than the equivalent channel configurations in the largest channel bandwidth configuration or the reported SAR of a configuration for the largest channel bandwidth is  $> 1.45\text{ W/kg}$ .
8. Worst case SAR for 50% RB allocation is selected to be tested.
9. According KDB865664 D01 Repeated measurements are required only when the measured SAR is  $\geq 0.80\text{ W/kg}$ . If the measured SAR value of the initial repeated measurement is  $< 1.45\text{ W/kg}$  with  $\leq 20\%$  variation, only one repeated measurement is required to reaffirm that the results are not expected to have substantial variations. A second repeated measurement is required only if the measured result for the initial repeated measurement is within 10% of the SAR limit and vary by more than 20%..



## **SAR SIMULTANEOUS TRANSMISSION DESCRIPTION**

### **Simultaneous Transmission:**

<b>Description of Simultaneous Transmit Capabilities</b>		
<b>Transmitter Combination</b>	<b>Simultaneous?</b>	<b>Hotspot</b>
WWAN(GPRS/WCDMA/LTE) + Bluetooth	√	×
WWAN(GPRS/WCDMA/LTE) + WLAN 2.4G/5.2G/5.8G	√	√
WLAN + Bluetooth	×	×

### **Simultaneous Transmission Consideration Detail**

<b>Transmitter Combination</b>	<b>Position</b>	<b>Max SAR(W/kg)</b>		<b>ΣSAR&lt;1.6W/kg</b>
		<b>SAR1(WWAN)</b>	<b>SAR2(WLAN)</b>	
WWAN+ WLAN 2.4G (Hotspot)	Body Back(10mm)	1.213	0.208	1.421
	Body Front(10mm)	1.217	0.116	1.333
	Body Left(10mm)	0.464	---	0.464
	Body Right(10mm)	0.533	0.098	0.631
	Body Bottom(10mm)	0.722	---	0.722
	Body Top(10mm)	---	0.199	0.199

<b>Transmitter Combination</b>	<b>Position</b>	<b>Max SAR(W/kg)</b>		<b>ΣSAR&lt;1.6W/kg</b>
		<b>SAR1(WWAN)</b>	<b>SAR2(WLAN)</b>	
WWAN+ WLAN 5.2G (Hotspot)	Body Back(10mm)	1.213	0.211	1.424
	Body Front(10mm)	1.217	0.018	1.235
	Body Left(10mm)	0.464	---	0.464
	Body Right(10mm)	0.533	0.043	0.576
	Body Bottom(10mm)	0.722	---	0.722
	Body Top(10mm)	---	0.062	0.062

<b>Transmitter Combination</b>	<b>Position</b>	<b>Max SAR(W/kg)</b>		<b>ΣSAR&lt;1.6W/kg</b>
		<b>SAR1(WWAN)</b>	<b>SAR2(WLAN)</b>	
WWAN+ WLAN 5.8G (Hotspot)	Body Back(10mm)	1.213	0.062	1.275
	Body Front(10mm)	1.217	0.043	1.260
	Body Left(10mm)	0.464	---	0.464
	Body Right(10mm)	0.533	0.056	0.589
	Body Bottom(10mm)	0.722	---	0.722
	Body Top(10mm)	---	0.098	0.098

Transmitter Combination	Position	Max SAR(W/kg)		$\Sigma$ SAR<1.6W/kg
		SAR1(WWAN)	SAR2(BT)	
WWAN+ Bluetooth	Body Back(10mm)	1.213	0.019	1.232
	Body Front(10mm)	1.217	0.015	1.232
	Body Left(10mm)	0.464	---	0.464
	Body Right(10mm)	0.533	0.019	0.552
	Body Bottom(10mm)	0.722	---	0.722
	Body Top(10mm)	---	0.032	0.032

**Conclusion:**

Sum of SAR:  $\Sigma$ SAR  $\leq$  1.6 W/kg for 1g Body SAR, therefore simultaneous transmission SAR with Volume Scans is **not required**.

## APPENDIX A MEASUREMENT UNCERTAINTY

The uncertainty budget has been determined for the measurement system and is given in the following Table.

**Measurement uncertainty evaluation for IEEE1528 SAR test**

Source of uncertainty	Tolerance/uncertainty ± %	Probability distribution	Divisor	ci (1 g)	ci (10 g)	Standard uncertainty ± %, (1 g)	Standard uncertainty ± %, (10 g)
<b>Measurement system</b>							
Probe calibration	6.55	N	1	1	1	6.6	6.6
Axial Isotropy	4.7	R	√3	1	1	2.7	2.7
Hemispherical Isotropy	9.6	R	√3	0	0	0.0	0.0
Boundary effect	1.0	R	√3	1	1	0.6	0.6
Linearity	4.7	R	√3	1	1	2.7	2.7
Detection limits	1.0	R	√3	1	1	0.6	0.6
Readout electronics	0.3	N	1	1	1	0.3	0.3
Response time	0.0	R	√3	1	1	0.0	0.0
Integration time	0.0	R	√3	1	1	0.0	0.0
RF ambient conditions – noise	1.0	R	√3	1	1	0.6	0.6
RF ambient conditions– reflections	1.0	R	√3	1	1	0.6	0.6
Probe positioner mech. Restrictions	0.8	R	√3	1	1	0.5	0.5
Probe positioning with respect to phantom shell	6.7	R	√3	1	1	3.9	3.9
Post-processing	2.0	R	√3	1	1	1.2	1.2
<b>Test sample related</b>							
Test sample positioning	2.8	N	1	1	1	2.8	2.8
Device holder uncertainty	6.3	N	1	1	1	6.3	6.3
Drift of output power	5.0	R	√3	1	1	2.9	2.9
<b>Phantom and set-up</b>							
Phantom uncertainty (shape and thickness tolerances)	4.0	R	√3	1	1	2.3	2.3
Liquid conductivity target)	5.0	R	√3	0.64	0.43	1.8	1.2
Liquid conductivity meas.)	2.5	N	1	0.64	0.43	1.6	1.1
Liquid permittivity target)	5.0	R	√3	0.6	0.49	1.7	1.4
Liquid permittivity meas.)	2.5	N	1	0.6	0.49	1.5	1.2
Combined standard uncertainty		RSS				12.2	12.0
Expanded uncertainty 95 % confidence interval)						24.3	23.9

Note: It may not be duplicated or used in part without prior written consent from Bay Area Compliance Laboratories Corp.

## **APPENDIX B EUT TEST POSITION PHOTOS**

---

**Liquid depth  $\geq 15\text{cm}$**

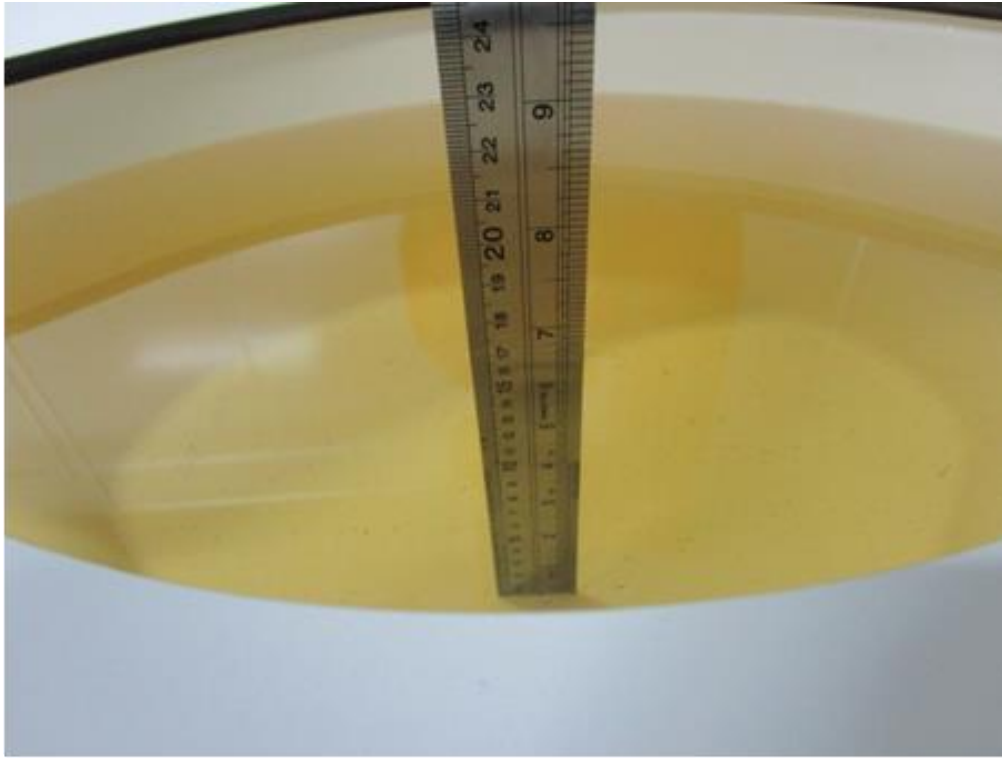

## **APPENDIX C SAR PLOTS OF SAR MEASUREMENT**

---

**Please Refer to the Attachment APPENDIX C SAR PLOTS OF SAR MEASUREMENT\_1123**

**APPENDIX D PROBE & DAE CALIBRATION CERTIFICATES**

**Please refer to the file document PROBE & DAE CALIBRATION CERTIFICATES**

## **APPENDIX E DIPOLE CALIBRATION CERTIFICATES**

**Please refer to the file document DIPOLE CALIBRATION CERTIFICATES**

## **APPENDIX F SAR Setup PHOTO**

**Please refer to the file document SAR Setup PHOTO**



## **APPENDIX G SAR EUT PHOTO**

---

**Please refer to the file document SAR EUT PHOTO**

**\*\*\*\*\* END OF REPORT \*\*\*\*\***