

PRIMA

Interactive Flat Panel INSTRUCTION MANUAL



**Before connecting, operating or adjusting this product, please read the manual completely.
Please keep this manual for future reference.**

Contents

Important Information	1
Important Safety Precautions	2
Important Notice	4
Identification of Controls	5
Remote Control	6
Connections	8
Basic Operations	10
System Settings	12
Network Settings	13
Menu List	21
Using USB Multi Media Player	23
Troubleshooting	26
Specifications	27

CHILD SAFETY

It makes a difference how and where you use your flat panel display

As you enjoy your new product, keep these safety tips in mind

The issue

The home theater entertainment experience is a growing trend, and larger IFPs are popular purchases. However, IFPs are not always supported on the proper stands or installed according to the manufacturer's recommendations. We and the consumer electronics industry are committed to making home entertainment enjoyable and safe.

IFPs that are inappropriately placed on dressers, bookcases, shelves, desks, speakers, chests, or carts may fall over and cause injury.

Tune into safety

- One size of IFP stand does not fit all. Use only a IFP stand rated for the weight of your IFP.
- Carefully read and understand all enclosed instructions for proper use of this product.
- Don't let children climb on or play with entertainment system furniture and IFPs.
- Don't place IFPs on furniture that can easily be used as steps, such as a crate or chest of drawers.
- Remember that children can become excited while watching a program, especially on a "larger-than-life" IFP. Make sure that you place or install the IFP where it cannot be pushed, pulled over, or knocked down.
- Make sure that you route all cords and cables so that they cannot be pulled or grabbed by curious children.



Wall mounting

If you decide to wall mount your IFP, always remember:

- One size of wall mount does not fit all. Use only a wall mount rated for the weight of your IFP and that has been recommended by this IFP manufacturer, listed in this manual, or otherwise listed by an independent laboratory as suitable for your IFP.
- Follow all instructions supplied by the IFP and wall mount manufacturers.
- If you have any doubts about your ability to safely wall mount your IFP, get help from a professional installer.
- Make sure that the wall where you are mounting the IFP is appropriate. Some wall mounts are not designed to be mounted to walls backed with steel studs or cinder blocks. If you are unsure, ask a professional installer.
- IFPs can be heavy. At least two people are required for safe wall mount installation.



Important Safety Precautions



This symbol indicates that dangerous voltage constituting a risk of electric shock is present within your IFP. This label is located on the back of your IFP.



This symbol indicates that there are important operating and maintenance instructions in the literature accompanying your IFP.

- 1 Read these instructions.
- 2 Keep these instructions.
- 3 Heed all warnings.
- 4 Follow all instructions.
- 5 Do not use this apparatus near water.
- 6 Clean only with dry cloth.
- 7 Do not block any ventilation openings. Install in accordance with the manufacturer's instructions.
- 8 Do not install near any heat sources such as radiators, heat registers, stoves, or other apparatus (including amplifiers) that produce heat.
- 9 Do not defeat the safety purpose of the polarized or grounding-type plug. A polarized plug has two blades with one wider than the other. A grounding type plug has two blades and a third grounding prong. The wide blade or the third prong are provided for your safety. If the provided plug does not fit into your outlet, consult an electrician for replacement of the obsolete outlet.
- 10 Protect the power cord from being walked on or pinched particularly at plugs, convenience receptacles, and the point where they exit from the apparatus.
- 11 Only use attachments/accessories specified by the manufacturer.
- 12 Use only with the cart, stand, tripod, bracket, or table specified by the manufacturer, or sold with the apparatus. When a cart is used, use caution when moving the cart/apparatus combination to avoid injury from tip-over.
- 13 Unplug this apparatus during lightning storms or when unused for long periods of time.
- 14 Refer all servicing to qualified service personnel. Servicing is required when the apparatus has been damaged in any way, such as power-supply cord or plug is damaged, liquid has been spilled or objects have fallen into the apparatus, the apparatus has been exposed to rain or moisture, does not operate normally, or has been dropped.
- 15 The *wall plug* is the disconnecting device. The plug must remain readily operable.
- 16 Remote control batteries should not be exposed to excessive heat such as sunshine, fire, or the like.
- 17 The apparatus should not be exposed to dripping or splashing, and no objects filled with liquids, such as vases, should be placed on the apparatus.



WARNING

Electric shock hazard

To reduce the risk of fire or electric shock, do not remove any cover or expose the device to rain or moisture. No user-serviceable parts are inside. Refer servicing to qualified service technicians.

Do not use immediately after moving from a low temperature to high temperature environment, as this causes condensation, which may result in fire, electric shock, or other hazards.

Lightning

For added protection for your device receiver during a lightning storm, or when it is left unattended and unused for long periods of time, unplug it from the power outlet and disconnect any antenna or cable system. This helps prevent property damage and personal injury from lightning and power line surges.

Power lines

An outside antenna system should not be located in the vicinity of overhead power lines or other electric light or power circuits, or where it can fall into such power lines or circuits. When installing an outside antenna system, extreme care should be taken to keep from touching such power lines or circuits as contact with them might be fatal.

Handling the LCD panel

- Your IFP's screen is made of glass. Do not drop your IFP or hit, jolt, or press hard against the LCD panel. If the screen breaks, be careful of broken glass.
- If the LCD panel is broken, make absolutely sure that you do not touch the liquid in the panel. This may cause skin inflammation.
- If the liquid gets in your mouth, immediately gargle, rinse, and consult with your doctor. Also, if the liquid gets in your eyes or touches your skin, consult with your doctor after rinsing for at least 15 minutes or longer in clean water.

Replacement parts

When replacement parts are required, make sure that the service technician uses replacement parts specified by the manufacturer that have the same characteristics as the original part. Unauthorized substitutions may result in fire, electric shock, personal injury, or other hazards.

Safety check

After completing any service or repair to this device, ask the service technician to perform routine safety checks to determine that your IFP is in correct operating condition.

Power source

Operate your IFP only from the type of power source indicated on the marking label. If you are not sure of the type of power supplied to your home, consult an electrician or your local power company.

Servicing

These servicing instructions are for use by qualified service personnel only. To reduce the risk of electric shock, do not perform any servicing other than that contained in the operating instructions unless you are qualified to do so.

Important Safety Precautions (Continued)

CAUTION

Damage requiring service

Unplug this IFP from the power outlet and refer servicing to qualified service personnel under the following conditions:

- When the power supply cord or plug is damaged or frayed.
- If liquid has been spilled or objects have fallen into your IFP.
- If your IFP has been exposed to rain or water.
- If your IFP does not operate normally by following the operating instructions. Adjust only those controls that are covered by the operating instructions because incorrect adjustment of other controls may result in damage and will often require extensive work by a qualified technician to restore your IFP to its normal operation.
- If your IFP has been dropped or damaged in any way.
- When your IFP exhibits a distinct change in performance.

Mobile telephone warning

To avoid interference with your IFP picture and sound, operating problems, or even damage, keep your cordless and cellular telephones away from the IFP.

End of life directives

Your IFP may contain materials that are regulated for environmental reasons. Your IFP also contains materials that can be recycled and reused. To help protect the environment, contact your local authorities for information about disposal or recycling and about finding a recycler in your area before you dispose of your IFP.

Non-active pixels

The LCD panel contains almost 3 million thin film transistors, which provide exceptionally sharp video quality. Occasionally, a few non-active pixels may appear on the screen as a fixed blue, green, or red point. These non-active pixels do not adversely affect the performance of your IFP, and are not considered defects.

Legal notices

FCC Statement

1. This device complies with Part 15 of the FCC Rules. Operation is subject to the following two conditions:
 - (1) This device may not cause harmful interference.
 - (2) This device must accept any interference received, including interference that may cause undesired operation.
2. Changes or modifications not expressly approved by the party responsible for compliance could void the user's authority to operate the equipment.

NOTE: This equipment has been tested and found to comply with the limits for a Class B digital device, pursuant to Part 15 of the FCC Rules. These limits are designed to provide reasonable protection against harmful interference in a residential installation.

This equipment generates uses and can radiate radio frequency energy and, if not installed and used in accordance with the instructions, may cause harmful interference to radio communications. However, there is no guarantee that interference will not occur in a particular installation. If this equipment does cause harmful interference to radio or television reception, which can be determined by turning the equipment off and on, the user is encouraged to try to correct the interference by one or more of the following measures:

Reorient or relocate the receiving antenna.

Increase the separation between the equipment and receiver.

Connect the equipment into an outlet on a circuit different from that to which the receiver is connected.

Consult the dealer or an experienced radio/TV technician for help.

FCC Radiation Exposure Statement:

This equipment complies with FCC radiation exposure limits set forth for an uncontrolled environment. In order to avoid the possibility of exceeding the FCC radio frequency exposure limits, Human proximity to the antenna shall not be less than 20cm (8 inches) during normal operation.

Important Notice

About Location/ Environment

Do not use in hot and cold rooms (locations)

- When the unit is used in rooms (locations) with low temperature, the picture may leave trails or appear slightly delayed. This is not a malfunction, and the unit will recover when the temperature returns to normal.
 - Do not leave the unit in a hot or cold location. Also, do not leave the unit in a location exposed to direct sunlight or near a heater, or in high humidity, as this may cause the cabinet to deform and the screen to malfunction, and affect the IFP's performance .
 - **Environment condition:**
 - Operating temperature: 5°C – 35°C
 - Operating humidity: 20 – 80 % (no moisture condensation)
 - Storage temperature: -15°C – 45°C
 - Storage humidity: 10 – 80 %
 - Atmospheric pressure: 86 kPa ~106 kPa
-

About After-Image

The extended use of fixed image program material can cause a permanent after-image on the screen.

This background image is viewable on normal programs in the form of a stationary fixed image. This type of irreversible screen deterioration can be limited by observing the following steps:

- A. Reduce the brightness/contrast setting to a minimum viewing level.
- B. Do not display the fixed image for extended periods of time.
- C. Turn the power off when not in actual use.

Important Information Regarding Use of Video Games, Computers, Captions or Other Fixed Image Displays.

- Do not allow a still picture to be displayed for an extended period, as this can cause a permanent after-image to remain on the screen.
Examples of still pictures include logos, video games, computer images, teletext and images displayed in 4:3 mode.

CAUTIONS:

- The permanent after-image on the screen resulting from fixed image use is not an operating defect and as such is not covered by the warranty.
 - This product is not designed to display fixed images for extended periods of time.
-

Cleaning and Maintenance

To clean this unit, wipe with a soft, dry cloth.

Clean the cabinet with a soft, lint-free cloth. If the cabinet is especially dirty, moisten a soft, lint-free cloth in a weak detergent solution, squeeze the excess moisture from the cloth, then wipe the cabinet with the cloth. Use a clean cloth to dry the cabinet.

- Clean the screen with a soft, lint-free cloth.
 - Use eyeglass cleaner to remove stubborn dirt from the screen.
 - Never use alcohol, paint thinner or benzine to clean this unit.
-

Carrying or Moving the IFP

- When you move the IFP , hold the frame of the IFP .
 - Be aware of the danger or harm which may caused by carrying or moving the IFP , as the bezel is very thin.
 - When transporting, do not subject the unit to shocks or vibration, or excessive force.
-

Environmental Protection

Waste electrical products should not be disposed of with household waste. Please recycle where facilities exist. Check with your Local Authority or retailer for recycling advice.



Identification of Controls

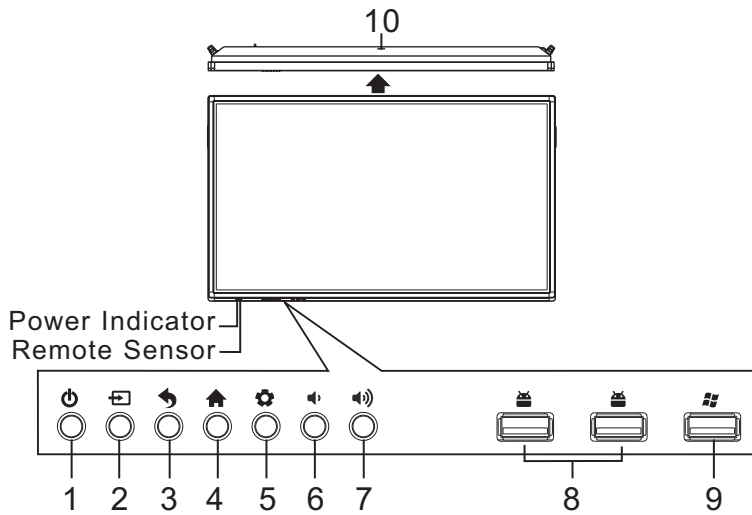

1. : Switch the screen power on or standby.
2. : Press the button to display input source menu or exit the menu screen.
3. : Press the button to return to previous menu.
4. : Press the button to display desktop (Home page) on the screen.
5. : Press the button to open the setting menu.
6. : Press the button to turn down the volume.
7. : Press the button to turn up the volume.
8. : USB for IFP. (Android)
9. : USB for OPS.

Note: If no OPS inserted, the USB port has no function.
 10.USB(2.0)(for camera): This port is connected to PC when current source is PC (internal OPS) , but is changed to Android if current source is AV, USB or in Home page.

Note: The position of the key and port may be different of different models, correct positions depend on the actual model.

Note: Please open the dust cover before being used.

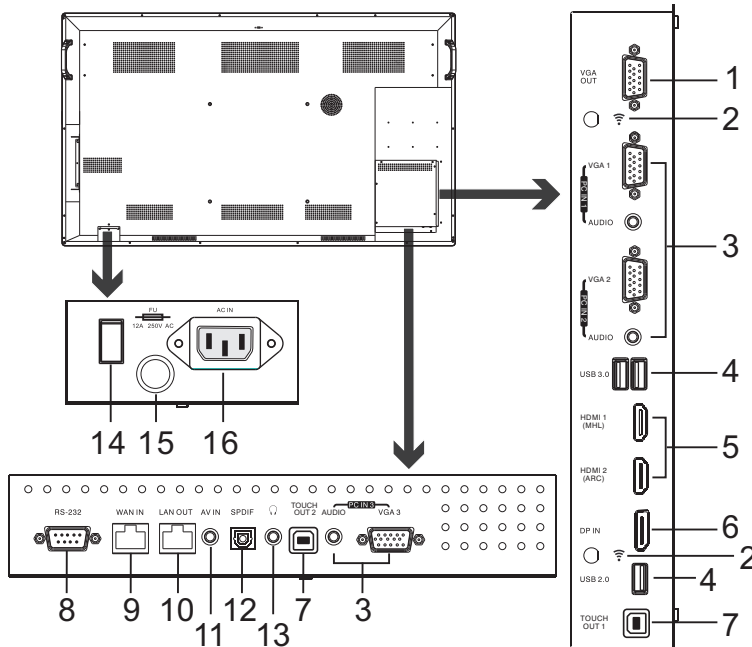

1.VGA OUT

The currently selected PC IN 1/2/3 signal output.

2. WIFI

WIFI antenna for transmitting or receiving network signal.

3.PC IN1/2/3

Enable connection to PC or other external devices with VGA/AUDIO ports.

4.USB2.0/3.0

USB standard interface, enable connection to USB2.0, USB3.0 standard devices. When connecting, please select the appropriate port.

5.HDMI1/2 Input

To connect with those equipments with HDMI or DVI interface.

HDMI1(MHL): Connect an MHL - enabled device such as a cell phone to this jack to view the external device's screen on your screen.

HDMI2(ARC): Connect an ARC-enabled home theater receiver to this jack.

6. DP(DisplayPort) Input

Connect an external device to DP out jack.

7.TOUCH1/2 OUT

Output the touch for external devices connected to PCx or HDMIx port which support touch system.

Note: TOUCH OUT 2 takes precedence over TOUCH OUT 1 in default. You can define it to in Lock menu.

8.RS232

For service, software upgrades and the other uses.

9.WAN IN

The built-in router input port. Connect to the external network.

10.LAN OUT

The built-in router output port. Connection to another computer or other Internet enabled devices.

11.AV IN

Connect an AV device to this jack.

12.S/PDIF digital audio output

Connect a digital sound system to this jack.

13.🎧

Connect headphones to this jack. The screen is the current audio output.

14. Power Switch

Push to (I) to connect the power, push to (O) to cut off.

Note: Do not cover the Power switch, it should be kept free from coverings so that it can be easily and conveniently operated.

15. Fuse (12A 250V)

16. AC IN

Plug the AC cord into this jack and into a power outlet.(~100-240V 50Hz/60Hz)

Remote Control

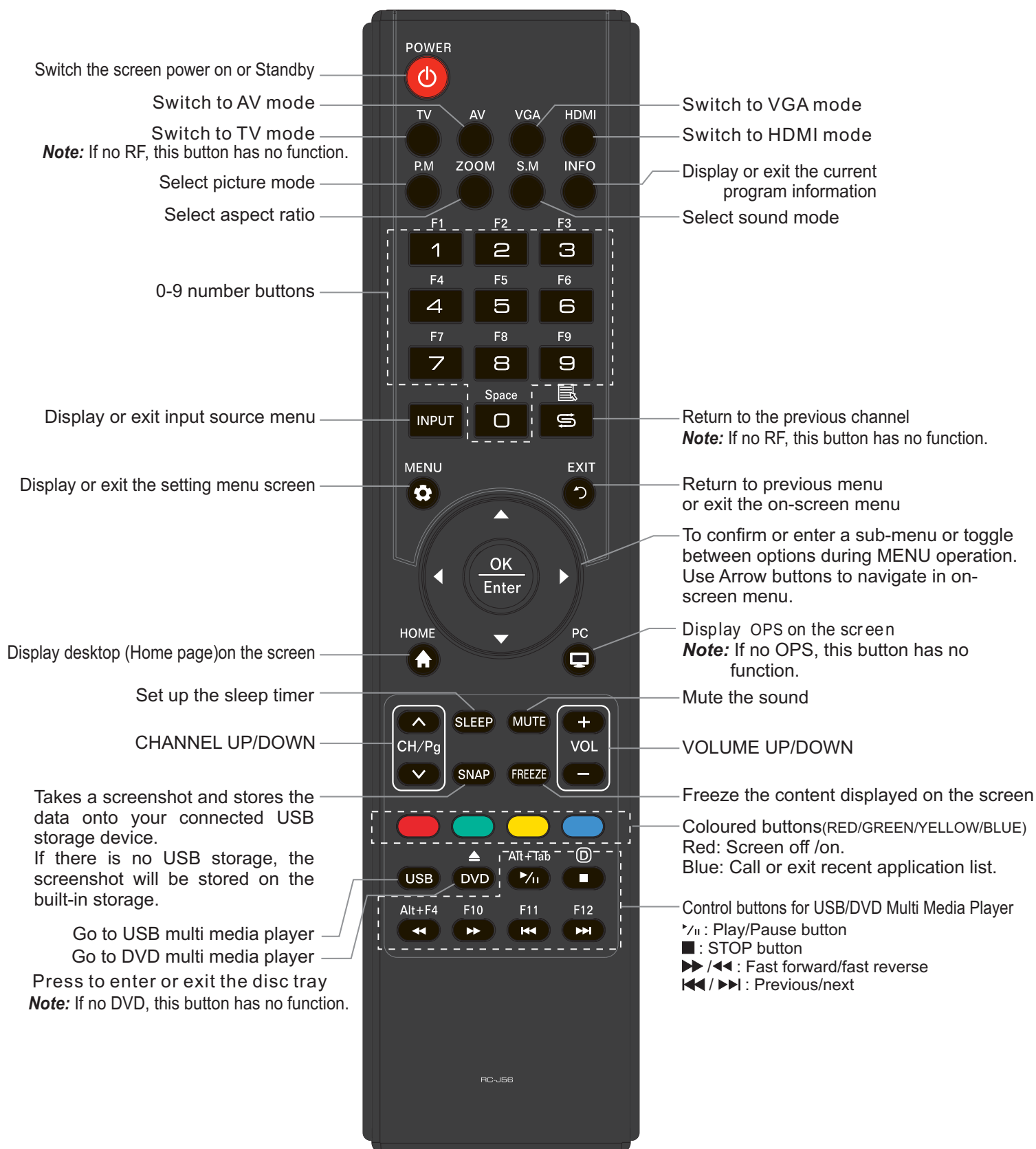

Notes:

- This operation manual provides a description based on operating functions with the remote control.
- In different mode, some buttons may have different function.

Remote Control

Installing remote control Batteries

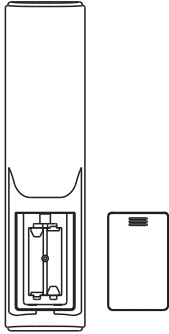

To install remote control batteries:

- 1 Open the battery cover.
- 2 Insert two AAA batteries into the battery compartment. Make sure that the + and – symbols on the batteries match the + and – symbols in the battery compartment.
- 3 Replace the cover.

Battery precautions:

Improper use of batteries can result in a leakage of chemicals and/or explosion. Be sure to follow the instructions below.

- Place batteries with their terminals corresponding to the (+) and (–) indications.
- Different types of batteries have different characteristics. Do not mix batteries of different types.
- Do not mix old and new batteries. Mixing old and new batteries can shorten the life of new batteries and/or cause old batteries to leak chemicals.
- Remove batteries as soon as they are non-operable. Chemicals that leak from batteries can cause a rash. If chemical leakage is found, wipe with a cloth.
- Dispose of batteries in a proper manner.
- If the remote control is not used for an extended period of time, remove the batteries.
- The batteries shall not be exposed to excessive heat such as sunshine, fire or the like.

Aiming the remote control

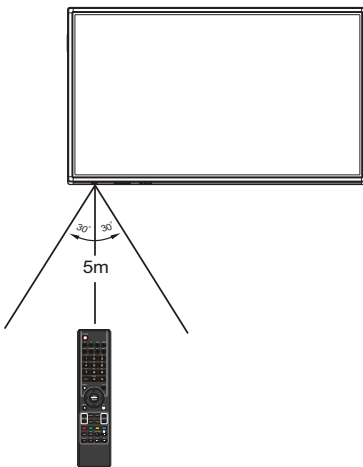

Use the remote control by pointing it towards the remote sensor on the front of your IFP. Objects between the remote control and the remote sensor may prevent proper operation.

Cautions regarding use of remote control

- Do not expose the remote control to shock. In addition, do not expose the remote control to liquids, and do not place in an area with high humidity.
- Do not install or place the remote control under direct sunlight. The heat may cause deformation of the unit.
- The remote control may not work properly if the remote sensor window of the main unit is under direct sunlight or strong lighting. In such a case, change the angle of the lighting or the IFP set, or operate the remote control closer to the remote sensor window.

Connections

Cautions Before Connecting

- When connecting an external device to the IFP, make sure that the IFP and the device are turned off.
- Check the plugs at the ends of cables to make sure that they are the correct type before you try plugging them into jacks on the IFP.
- Make sure that all plugs are securely inserted into the jacks. Loose connections can result in image or color problems.
- The illustration of the external device may be different depending on your model.
- Refer to the operating manual of the external device as well.

1. Connect the female plug to the AC socket on the unit.
2. Connect the male plug to the wall outlet as illustrated.

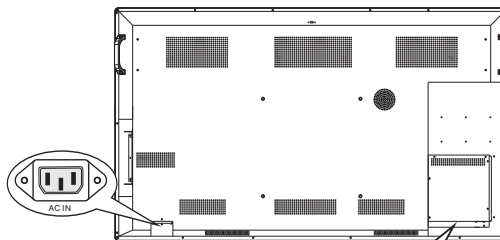

Notes:

- This product should be operated only from the type of power source indicated on the marking label.
- Always unplug the AC cord from power outlet when not using for a long period of time.

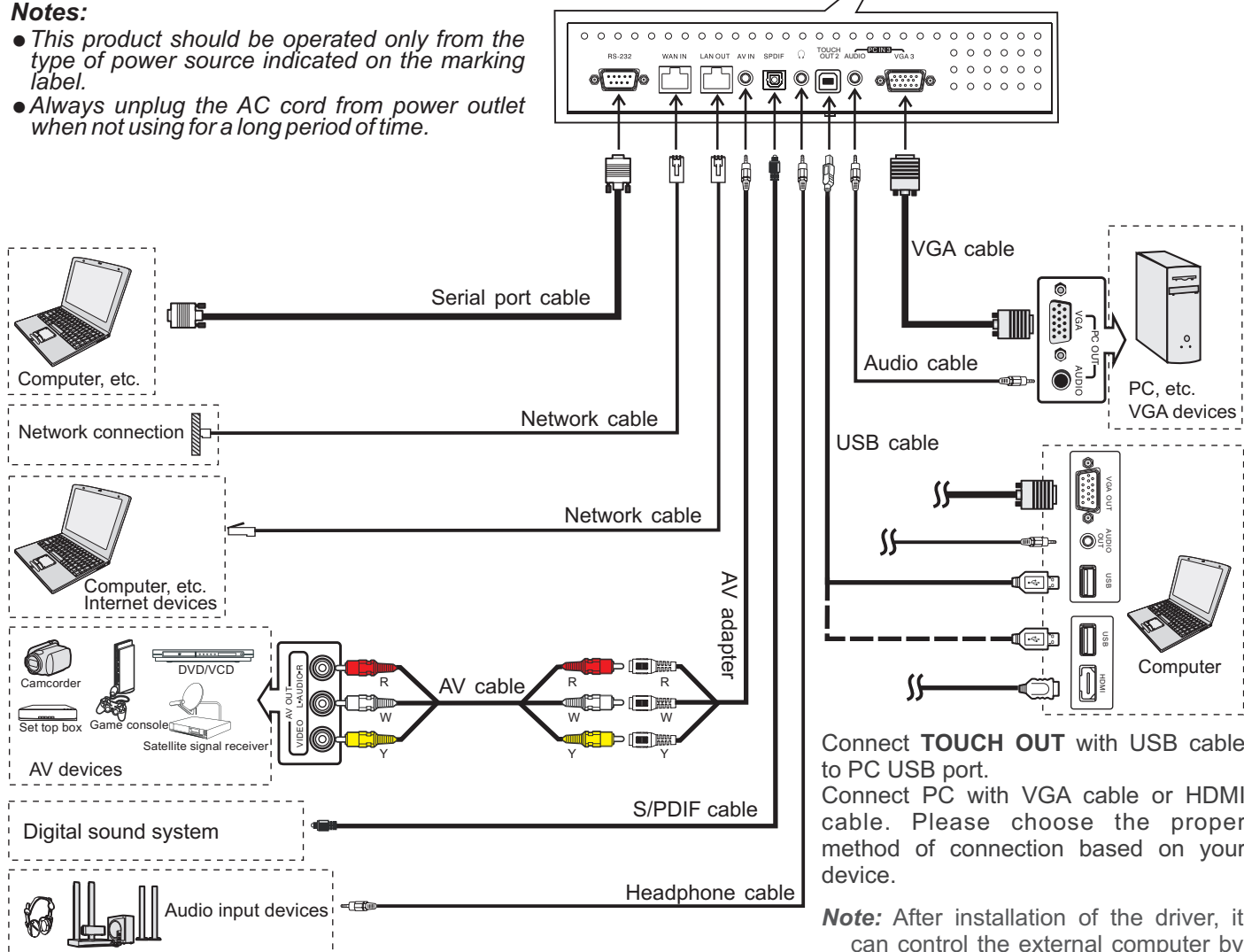

Connect **TOUCH OUT** with USB cable to PC USB port.
 Connect PC with VGA cable or HDMI cable. Please choose the proper method of connection based on your device.

Note: After installation of the driver, it can control the external computer by native touch control. (Only for PC, HDMI signal)
 TOUCH OUT 2 takes precedence over TOUCH OUT 1 in default. You can define it to in Lock menu.

Note: Before using headphones, adjust the device volume so as to avoid excessive levels, as hearing damage may result.

Connections

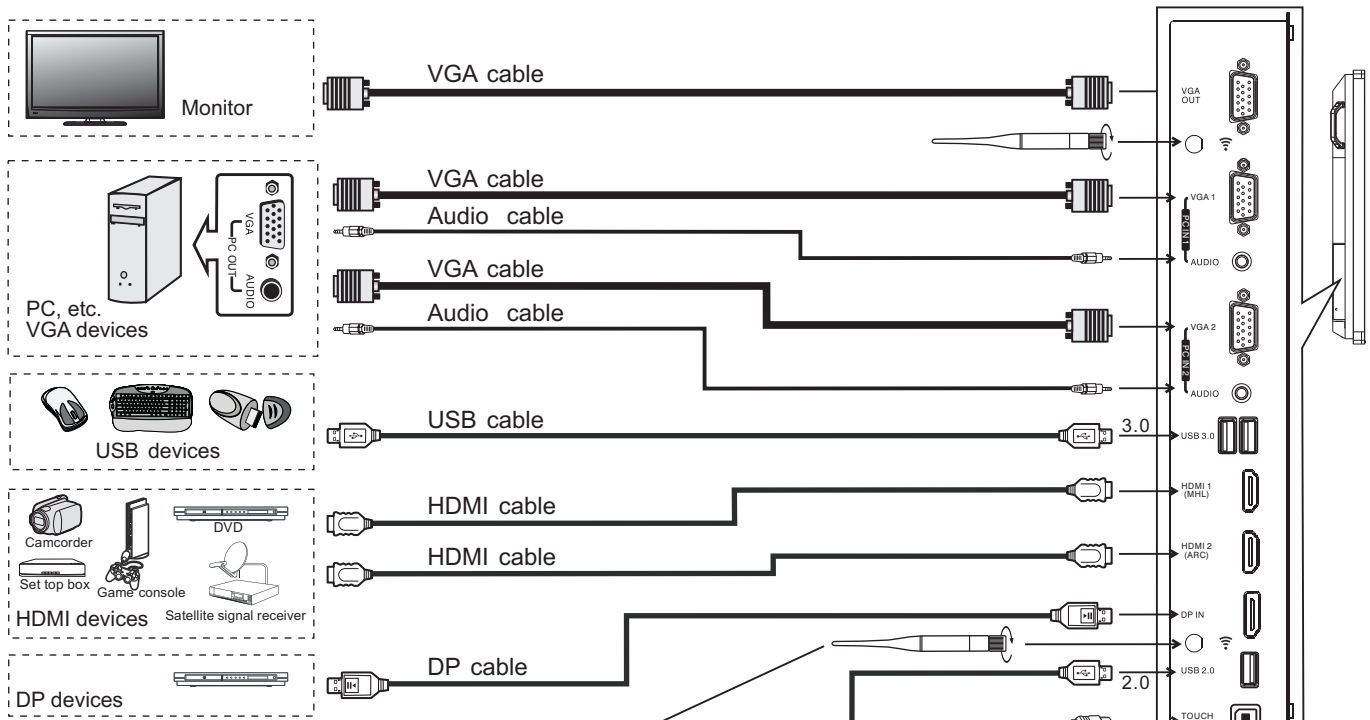

Tighten the WiFi antenna in clockwise direction. The WiFi antenna is able to access WiFi network. Inside AP. When network cable is plugged in WAN port, the antenna will generate WiFi network.

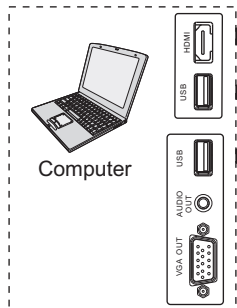

Connect **TOUCH OUT** with USB cable to PC USB port. Connect PC with VGA cable or HDMI cable. Please choose the proper method of connection based on your device.

Note: After installation of the driver, it can control the external computer by native touch control. (Only for PC、HDMI signal)
TOUCH OUT 2 takes precedence over TOUCH OUT 1 in default. You can define it to in Lock menu.

- ⓘ **Notes:** 1. The screen is multiple USB port designed(3.0, 2.0), when connect with USB device, please select the appropriate port.
- 2. The VGA output is signal of what has been currently selected from PC1/2/3.

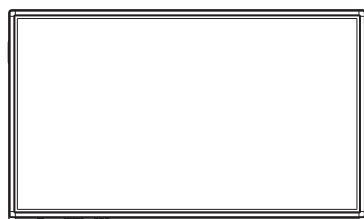

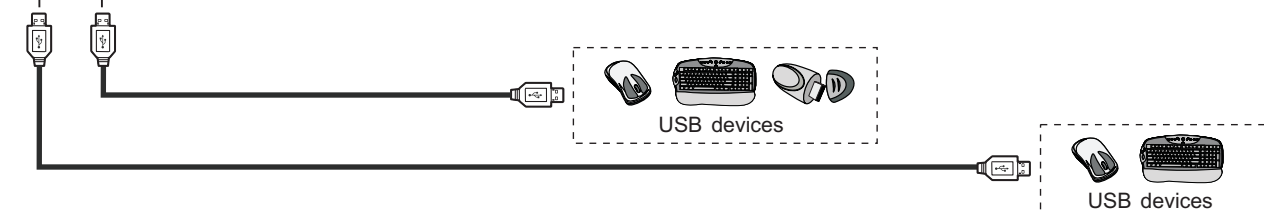
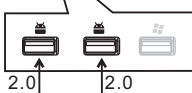

Front USB ports



Basic Operations



Turning the IFP on or off

- 1 Plug the powercord into an AC Power outlet. Press **Power Switch** on the IFP.
- 2 Now the IFP is in standby mode. Wait a moment until the power indicator lights up, then press **POWER**  to turn on the IFP. (Be sure to wait for a few seconds before pressing POWER button. If you promptly press POWER button then the IFP may not respond or act wrongly.)
- 3 Press  button again to turn off the IFP and put the IFP in standby mode.
To cut off the power completely, press **Power Switch** on the IFP.

Note: If the IFP does not receive a displaying signal for a certain time, the IFP goes into standby mode.

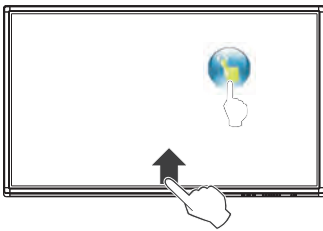
Operating the Float menu



- 1 Touch the bottom of the screen and drag upward to make  appear.
Press and drag  to any place of the screen.
Touch once  to control the MENU appear.
- 2 When displaying at USB, DVD interface, touch once at the lower part of the screen, the display control menu will appear.

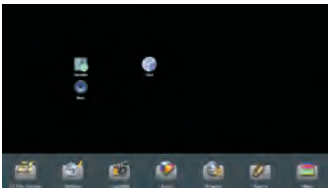

Switch to the Home page.(Android Interface)

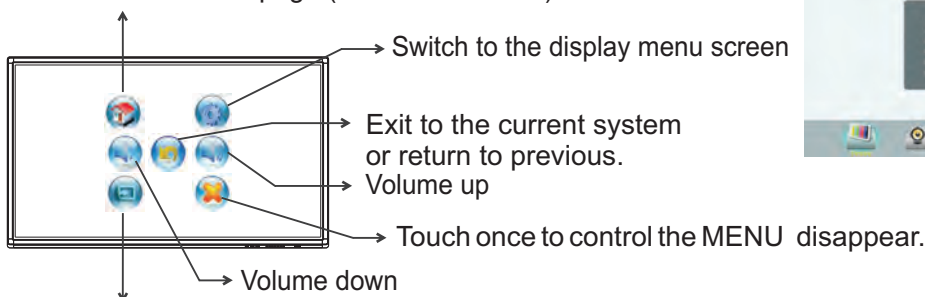

Switch to different input source, i.e. HDMI, VGA, etc.

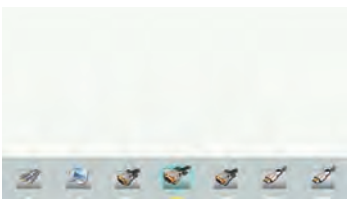

Basic Operations

Home Menu Overview

In all applications, press and drag the icon to on Home page for shortcut created, press and drag the shortcut to **X REMOVE** for shortcut deleted.

Shortcuts you created on Home page



Show all applications

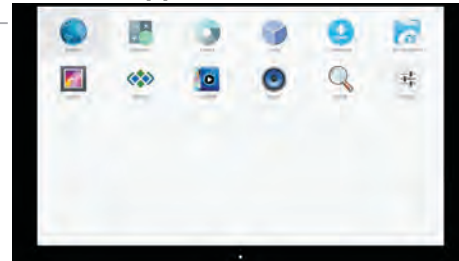

Note: When using the app Camera, the data will be stored on the USB storage. If there no USB storage, the data will be stored on the built-in storage.

ES File Explorer

Go to your **web Browser**.

Open the **System Setup** menu.

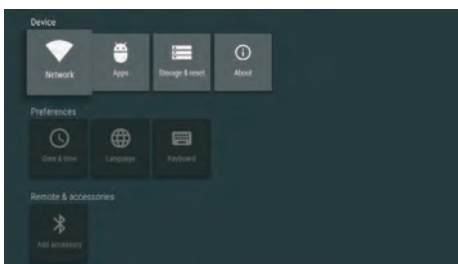

Switch to the display menu screen



Go to your **USB multi-media player**.



Switch to different input source, i.e. HDMI, VGA, etc.



Note: The layout of menu may vary upon different models you purchased.

System Settings

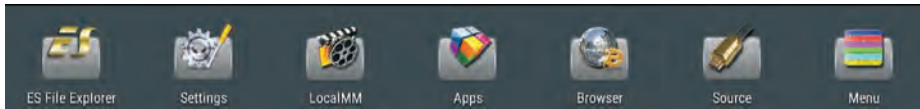

Network Setting

Show all apps

Display system Storage or restore to factory default.

Display information

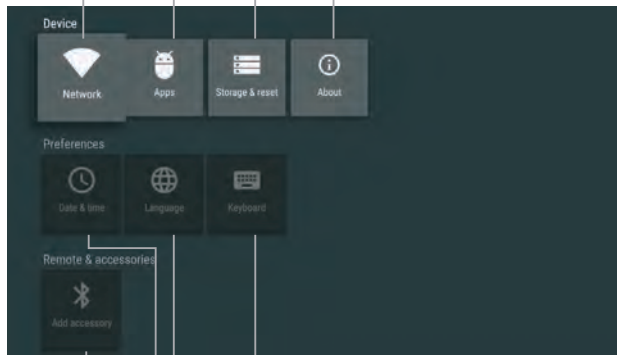

To set default input method
To set Android keyboard(AOSP)

To set on-screen language

To set Date and time

Note: To manually set date and time, you should toggle
"Automatic Date & time" to **OFF**.

Automatic search for Bluetooth devices

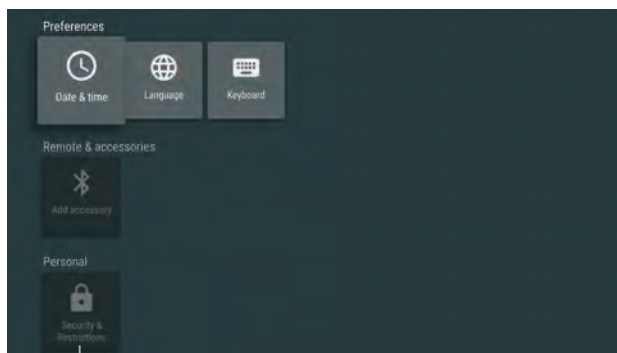

To set Security and Restrictions
Allow installation of apps from sources other than the Play Store.

Network Settings

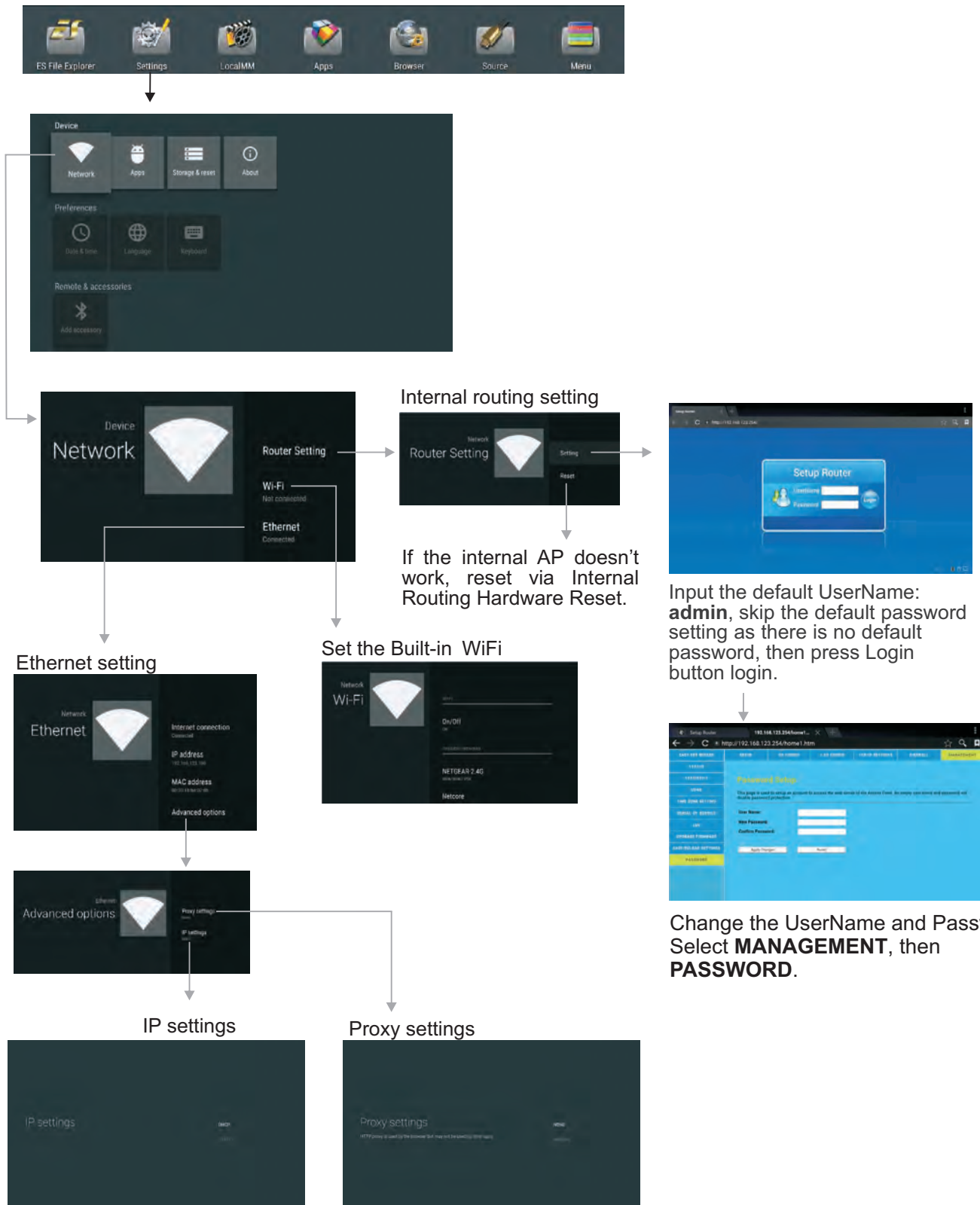

Network Settings(Continued)

Wired Network Setting (Internal router)

Method 1: Easy Set Wizard

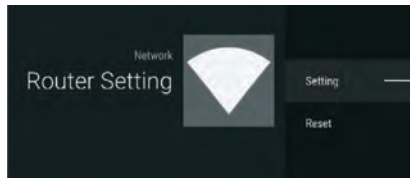
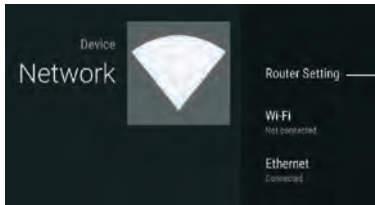

Input the default UserName: **admin**, skip the default password setting as there is no default password, then press Login button login.



Select **Gateway**

Next



Select **Easy Set Wizard**

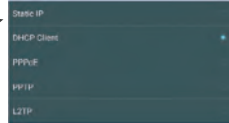
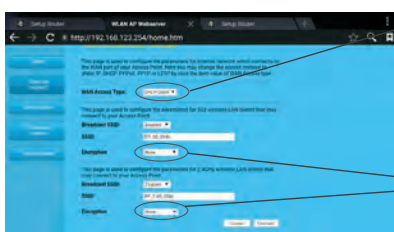

There are five methods to connect with network, choose your preferred one. Recommended to select the **DHCP Client** connection. Automatically obtain IP information from your ISP. **Static IP:** If all Internet IP information is provided by your ISP, then choose Static IP.

Password Setting Format



DHCP Client: Automatically obtain IP information from your ISP. If your ISP doesn't provide a designated IP for you, then choose DHCP Client.

Finished

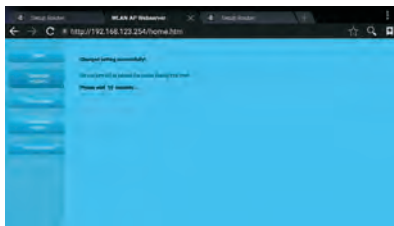

WiFi Password of Internal Router in the IFP. (Password should be set at least 8 characters.)

PPPOE: Ethernet Point to Protocol. Your ISP will provide you with Login ID and password. Usually this option is applicable to DSL service.

PPTP: Point to Point Tunneling Protocol. Your ISP will provide you with Login ID and password.

L2TP: Layer 2 Tunneling Protocol. Your ISP will provide you with Login ID and password. Usually this option is applicable to DSL service.



Get IP, Changed setting successfully.

Network Settings(Continued)

Wired Network Setting (Internal router)

Method 2: Professor model

Input the default UserName: **admin**, skip the default password setting as there is no default password, then press Login button login.

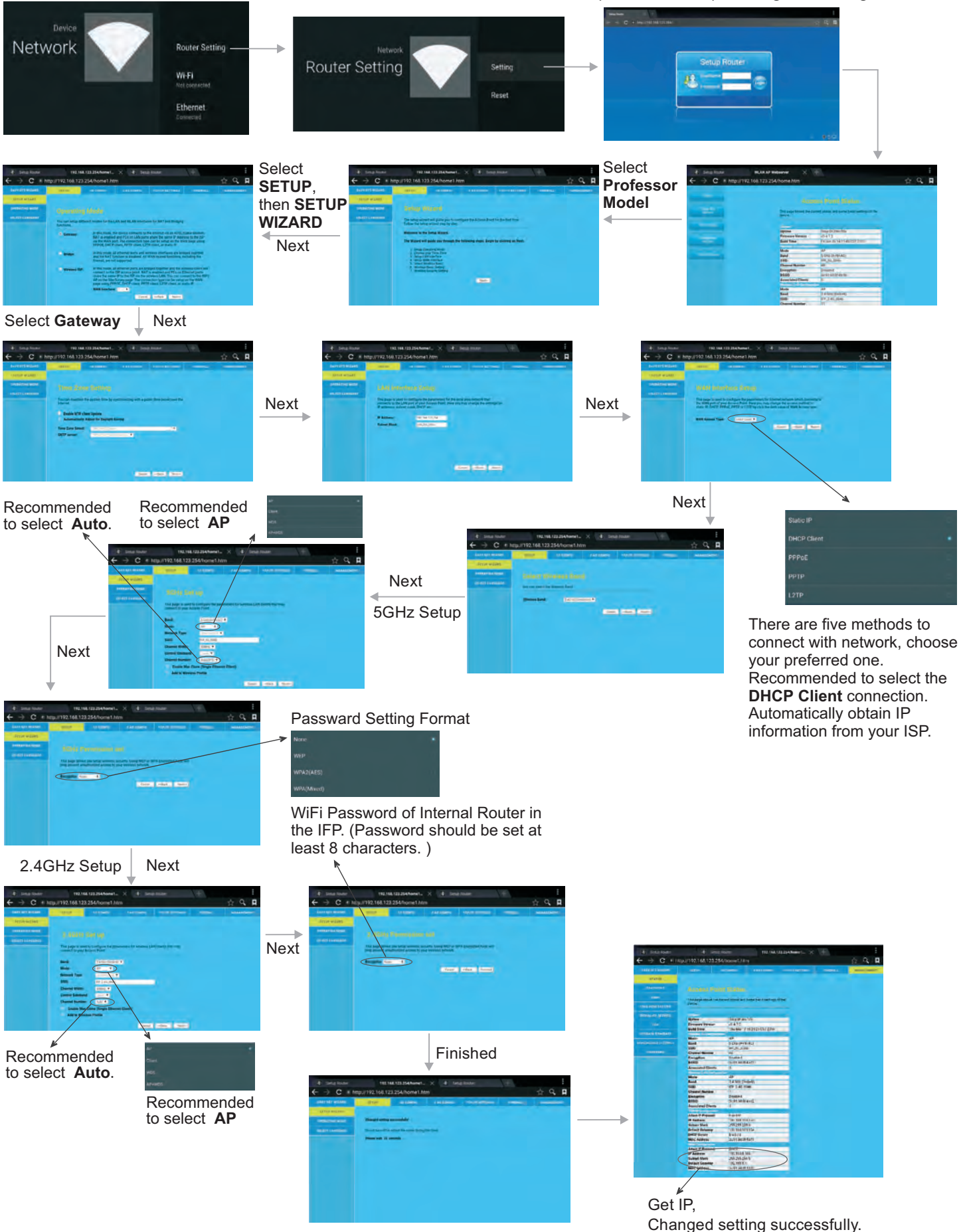

Network Settings(Continued)

Wired Network Setting (Internal router)

Method 3: Operating mode

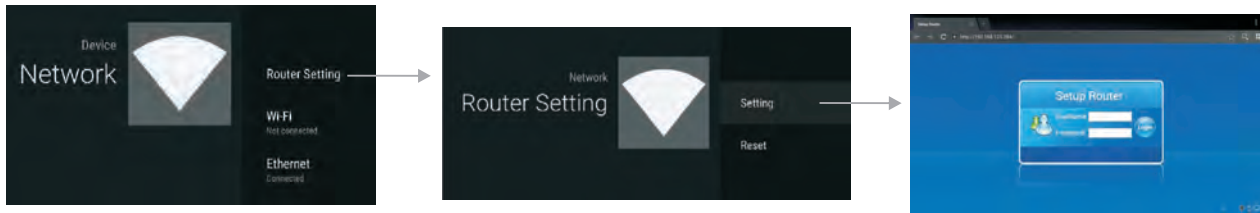

Input the default UserName: **admin**, skip the default password setting as there is no default password, then press Login button login.

Select **SETUP**, then **OPERATING MODE**

Select **Gateway**, then press **Apply Changes**.

Select **Professor Model**



Get IP, Changed setting successfully.

Network Settings(Continued)

Wireless Network Setting (Internal router)

Method 1: Easy Set Wizard (For example, WAN Interface:5G)

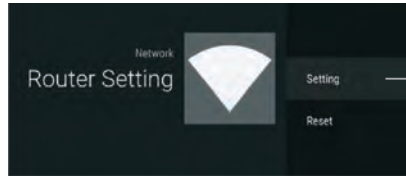

Input the default Username: **admin**, skip the default password setting as there is no default password, then press Login button login.

Select from **5G, 2.4G.**

Select **Wireless ISP**

Next



Select **Easy Set Wizard**

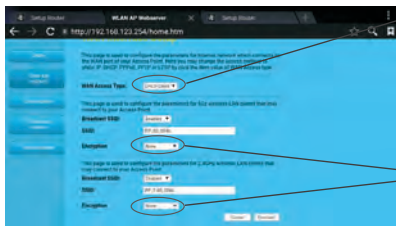

Password Setting Format

WiFi Password of Internal Router in the IFP. (Password should be set at least 8 characters.)

There are five methods to connect with network, choose your preferred one.

Recommended to select the **DHCP Client** connection. Automatically obtain IP information from your ISP.

Static IP: If all Internet IP information is provided by your ISP, then choose Static IP.

DHCP Client: Automatically obtain IP information from your ISP. If your ISP doesn't provide a designated IP for you, then choose DHCP Client.

PPPOE: Ethernet Point to Protocol. Your ISP will provide you with Login ID and password. Usually this option is applicable to DSL service.

PPTP: Point to Point Tunneling Protocol. Your ISP will provide you with Login ID and password.

L2TP: Layer 2 Tunneling Protocol. Your ISP will provide you with Login ID and password. Usually this option is applicable to DSL service.

Finished



Successfully connected to return.

Select **Site Survey**

The wireless networks is based on the **WAN Interface**.



Confirm Site Survey



Select your desired WiFi signal.

Next



Input Password

Connect

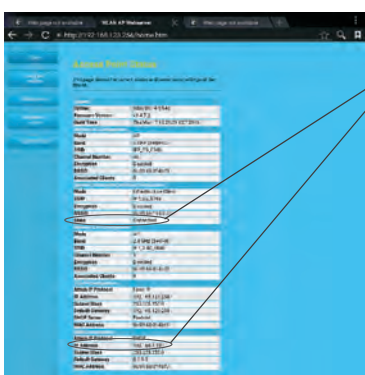

Get IP, Changed setting successfully.



Network Settings(Continued)

Wireless Network Setting (Internal router)

Method 2: Professor model (For example, WAN Interface:5G)

Select **SETUP**, then **SETUPWIZARD**



Network Settings(Continued)

Wireless Network Setting (Internal router)

Method 3: Operating mode (For example, WAN Interface:5G)

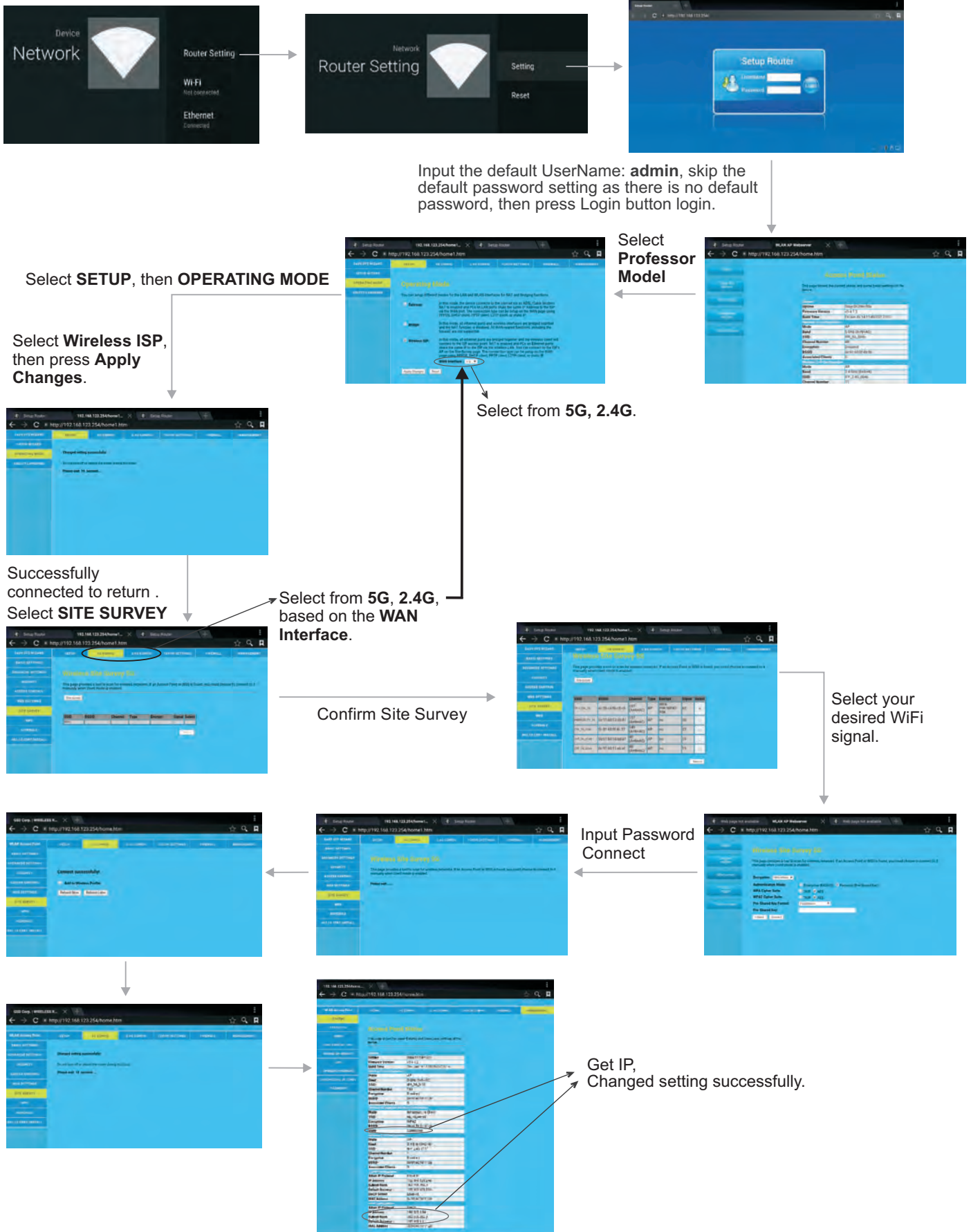

Network Settings(Continued)

Wireless Network Setting (Built-in WiFi card)

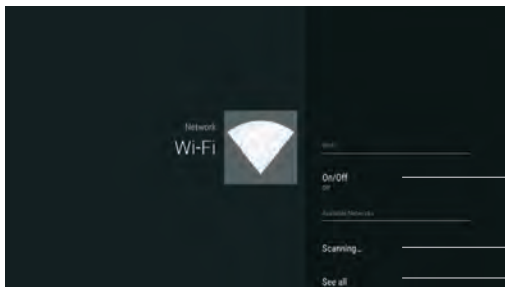
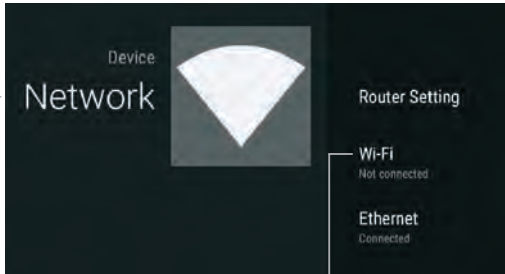
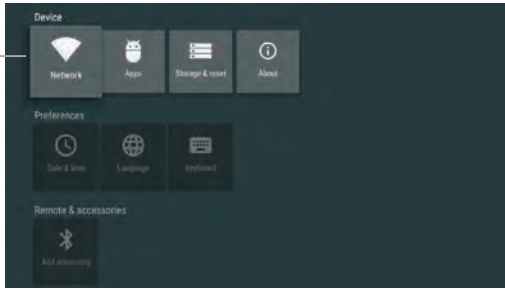

- Turn on/off the built-in WiFi
- Scanning Wi-Fi signal.
- Display of all the Wi-Fi signal.

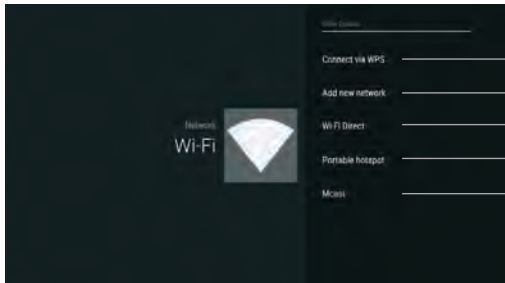

- Select your desired Wi-Fi signal.
- Add new network.
- Scanning Wi-Fi direct device.
- Setting Portable WiFi hotspot.
- Turn on enable Mcast.

Menu List

Adjusting Picture mode



Picture	Picture Mode	Select your favourite picture mode for each input [Standard] / [Soft] / [User] / [Game] / [Writing] / Dynamic .	
	Contrast	Adjust the contrast.	
	Brightness	Adjust the brightness.	
	Hue	Adjust the image hue. (Only for NTSC system)	
	Sharpness	Adjust the sharpness.	
	Saturation	Adjust the color saturation.	
	Backlight	Set up the overall brilliance of the screen.	
	Energy Save	The backlight brightness is decreased.	
	Screen	Clock	Adjust the screen size.
		Phase	Adjust the focus of stable images.
		H-Position	Move the image right or left.
		V-Position	Move the image up or down.
		Auto Adjust	Automatically adjust the image settings such as position and phase.
	Color Temperature	Select the color temperature. If you select User , you can set the level of the Red/Green/Blue as your desired.	
Zoom Mode	Select the aspect ratio (display proportions) according to your video signal type or personal preference.		
OverScan	Adjust the reproduction ratio, you may activate this function to obtain a cleaner picture.		
MFC	Frame rate up conversion. (Only for 4K model.)		
Image NR	Turn on/off the noise reduction mode to reduce picture noise.		

Adjusting Sound mode



Sound	Sound Mode	Select your favourite sound mode for each input [Standard] / [Music] / [Movie] / [Sports] / [User] .
	Bass	Adjust Bass (low sounds) .
	Treble	Adjust Treble (high sounds).
	Balance	Adjust volume level of right and left speakers.
	AVC	Select [On] to equalize overall volume levels across all channels. Select [Off] to turn off the auto volume control.
	Surround	Turn the Surround sound effect on or off.
	SPDIF Output (digital signal only)	Select the digital audio output mode for S/PDIF. Select [RAW] to output audio signal as its original format. Select [PCM] to output audio signal by PCM format.
	SPDIF Volume	Adjust SPDIF volume.
	Alone	Turn off the picture on your monitor and listen to the program audio only. Wake up by any key or touch with two or more fingers.

Menu List

Adjusting Setting menu



Setting	Source Auto Switch	Select On to automatically recognition source.
	Color Range	Select color range. (Only for HDMI mode)
	HDMI EDID Ver.	Select HDMI EDID Ver.
	MHL Auto Switch	Select On to automatically switch to the MHL input when it connected.
	HDMI_ARC	Select On to turn on enable HDMI_ARC.
	Movie Mode	Turn on/off the movie mode.
	Menu Timeout	Select OSD menu display time.
	Date / Time	Display Date and Time.
	Off Timer	Set Off timer to switch the screen to standby at a specified time.
	On Timer	Set On timer to turn on the screen automatically to source at a certain time.
	Sleep Time	Set the duration of time until the screen automatically goes into Standby mode. [Off] / [10 Minutes] / [20 Minutes] / [30 Minutes] / [60 Minutes] / [90 Minutes] / [120 Minutes] / [180 Minutes] / [240 Minutes].

Adjusting Lock menu



The default password is 0000.

Lock	Lock System	Select Off to Lock System unlocked. Select Lock Keypad to the screen buttons is locked. Select Lock Touch to disable the function of the touch panel. Select Lock Both to the screen buttons and the touch panel is locked.
	Float Menu	Turn on/off the float menu display.
	Set Password	Password settings.
	Change Logo	Select Change Logo item to access and change Logo. Note: 1. Save the logo which you are about to change in the USB stick. The logo file sizes should be <512K, and rename it as boot0.jpg. 2. Insert the USB stick into the USB port on the Android board.
	Power on Source	Power on Source Setting, in MEMORY mode, when the screen powered on, it will automatically switch to the source when it powered off last time. otherwise, it is in setting mode.
	System ID	Setting the device ID. (The ID must be in the range of 0-255, but 138, 168 are unused ID, 0 is for broadcast.)
	TouchOut1 To	TouchOut are for define the touch signal output to which input, ex. TouchOut1 is set to VGA1 means touch signal is output from TouchOut1 when input is VGA1. TouchOut2 is priority default when two port are connected.
	TouchOut2 To	
	Wake up by gesture	Select On to enable two or more fingers touch the bottom of the screen and drag upward to turn on the screen when the screen is in standby mode.
Restore To Default	Reset all settings to factory defaults.	

Using USB Multi Media Player

Using USB multi media player

You can connect a USB storage device to your IFP to view compatible photo, movie or play compatible music so that the sound can be output from the IFP's speaker.

To use USB multi media player, please go to USB source by pressing **USB** button. Or you can press **Home** button to display Home Page and then select **USB Drive** icon to access.

Notes:

- Never remove the USB storage device or turn off the IFP while using the USB storage device.
- It is recommended that you back up your USB device data.
- Your screens USB menu may look different to the interface shown in this manual.
- If you want to pull out the USB device, please exit USB mode first. For instructions on using your USB device, refer to the user's manual of your USB device.
- Please name your files in English. Otherwise the file names can not be shown correctly.
- Certain types of USB device may not be compatible with this IFP.

USB multi media interface introduction

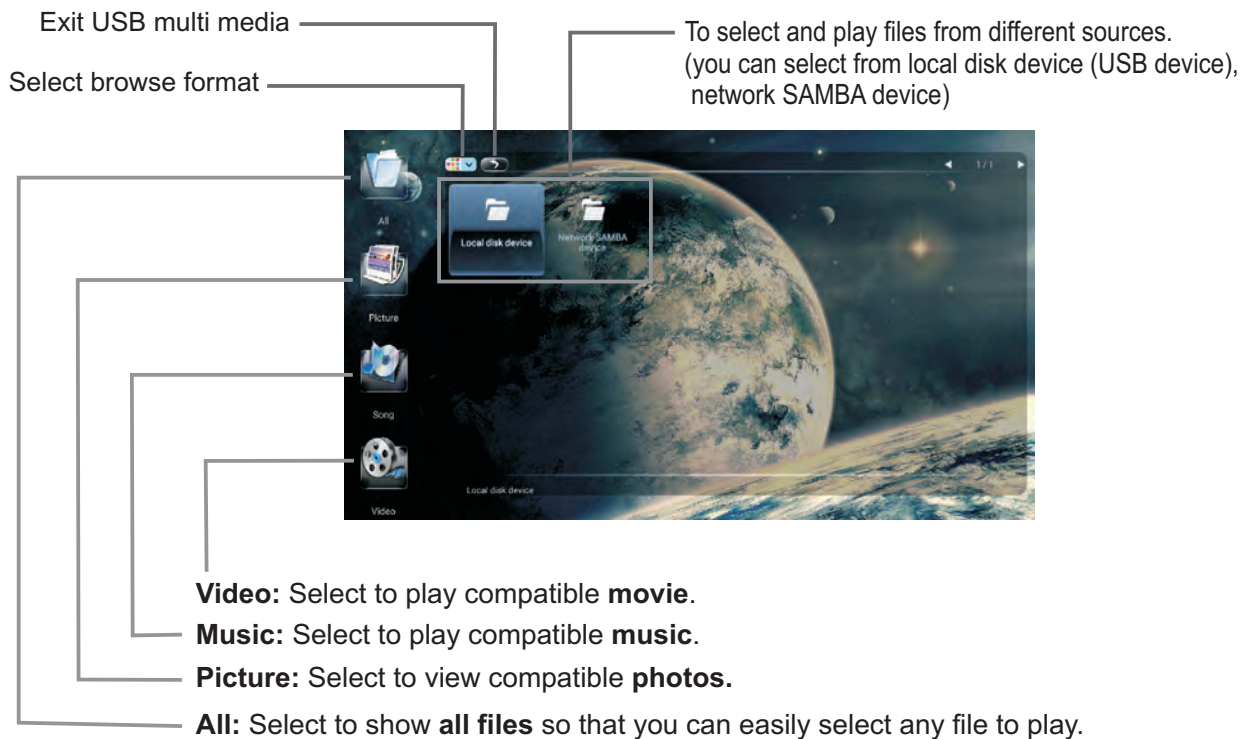

Using USB Multi Media Player

Playing Photo

With the photo viewer, you can view compatible photos (in JPG, BMP or PNG format). Also you can zoom, rotate photo, etc.



- Previous photo
- Play/pause
- Next photo
- Zoom in
- Zoom out
- Show information
- Rotate clockwise
- Rotate anti-clockwise

Note: You can also use \blacktriangle/II (Play/Pause), \blacksquare (STOP), \lll (Previous), \ggg (Next) on the remote control to operate.

Playing Music

With the USB music player, you can play compatible music (in MP3 or AAC format).



- Previous song
- Pause/Play
- Next song
- Repeat mode select
- Show information
- Show playlist

repeat to play single music, repeat to play all music files in current folder when it plays to the end, no repeat when it plays to the end.

Note: You can also use \blacktriangle/II (Play/Pause), \blacksquare (STOP), \lll (Previous), \ggg (Next) on the remote control to operate.

Using USB Multi Media Player

Playing Movie

With the USB movie player, you can play compatible movie (in AVI, MPG, MPEG, DAT, MP4, TS, RM/RMVB, or MKV/MOV format).

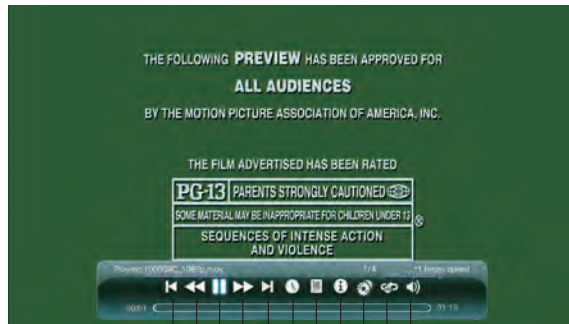

- Previous movie
- Fast reverse
- Play/pause
- Fast forward
- Next movie

- Adjust the volume
- AB Section repeat
- Playing settings
- Show information
- Show playlist

Skip to specific point by input time

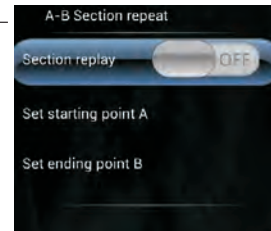
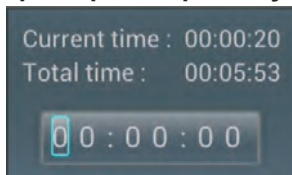

Now AB repeat starts. To cancel, highlight **Section replay** and toggle it to **OFF**.

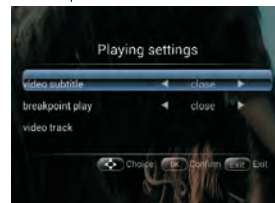

Troubleshooting

If, after reading these operating instructions, you have additional questions related to the use of your IFP, please call the services center in your local area.

Before calling service, please check the symptoms and follow suggested solutions.

Remote Control

<i>Problem</i>	<i>Possible Solutions</i>
Remote control does not operate	<ul style="list-style-type: none">• The batteries could be weak. Replace the batteries.• Check the orientation of the batteries.• Make sure the power cord is plugged in.

Video and Audio

<i>Problem</i>	<i>Possible Solutions</i>
No picture (screen not lit), No sound	<ul style="list-style-type: none">• Make sure the power cord is plugged in.• Press POWER on the IFP or on the remote control.
Dark, poor or no picture (Screen lit), good sound	<ul style="list-style-type: none">• Select a proper picture mode.• Adjust the brightness in the video setting.
No color/dark picture/abnormal color	<ul style="list-style-type: none">• Adjust the color saturation in the video setting.
Dotted lines or stripes	<ul style="list-style-type: none">• Move the IFP away from noise sources such as cars, neon signs, or hair dryers.
Good picture, no sound	<ul style="list-style-type: none">• The sound may be muted. Press MUTE again to cancel.
Audio noise	<ul style="list-style-type: none">• Communication problems may occur if infrared communication equipment (e.g., infrared cordless headphones) is used near the IFP. Move the infrared communication equipment away from the IFP until the noise is eliminated.

General

<i>Problem</i>	<i>Possible Solutions</i>
Some items can't be accessed	<ul style="list-style-type: none">• If a setting option appears in gray, this indicates that the settings option is unavailable in current input mode.
Remote control command is not effect in some cases.	<ul style="list-style-type: none">• During the timing of USB device detection (i.e. when the IFP is turned on with USB device connected, or when you plug in USB device during IFP working), the IFP may not act by remote control buttons in such case. Wait some time, then it is OK.
Control buttons do not operate	<ul style="list-style-type: none">• Disconnect the power cord and wait for a few seconds. Then re-plug the power cord and turn on the unit again.
POWER button responds slowly after power is connected.	<ul style="list-style-type: none">• When you push POWER SWITCH to power on the IFP, in about 3 seconds the POWER button starts to respond after pressed.

Note: If your problem is not solved, turn your unit off and then on again.

Cautions: Never attempt to repair a defective IFP yourself.

Specifications

Model No.		43"	55"	65"	70"	75"	84"
Power Source		AC 100-240 V, 50 / 60 Hz					
Power Consumption	Current Max.	1.2 A	2.4 A	2.8 A	3.1 A	5.2 A	6.2 A
	Standby condition*	< 0.5 W	< 0.5 W	< 0.5 W	< 0.5 W	< 0.5 W	< 0.5 W
Display panel	Number of pixels	1,920 (W) × 1,080 (H)	1,920 (W) × 1,080 (H)	1,920 (W) × 1,080 (H)	1,920 (W) × 1,080 (H)	3,840 (W) × 2,160 (H)	3,840 (W) × 2,160 (H)
	Visible screen size	43 inches(diagonal)	55 inches(diagonal)	65 inches(diagonal)	70 inches(diagonal)	75 inches(diagonal)	84 inches(diagonal)
Dimensions (W × D × H) Unit: mm		1013.5 X 107.8 X 614 (without Stand)	1285 X 111.6 X 770	1501 X 113 X 890	1614 X 100 X 955	1723 X 104.2 X 1016	1951 X 108.6 X 1148
Mass		27 kg Net (without Stand)	39.5 kg Net	54 kg Net	71.5 kg Net	86 kg Net	104 kg Net
Operating conditions		Operating temperature: 5°C - 35°C , Storage temperature: -15°C - 45°C, Operating humidity: 20 % - 80 % (no moisture condensation), Storage humidity: 10% - 80%, Atmospheric pressure: 86kPa ~ 106kPa					
Connection terminals of the IFP	AV IN	1	1	1	1	1	1
	PC IN	3	3	3	3	3	3
	VGA OUT	1	1	1	1	1	1
	HDMI Input	2	2	2	2	2	2
	DP Input	1	1	1	1	1	1
	USB	5	5	5	5	5	5
	WAN IN	1	1	1	1	1	1
	LAN OUT	1	1	1	1	1	1
	S/PDIF OUT	1	1	1	1	1	1
	Headphone	1	1	1	1	1	1
	RS232	1	1	1	1	1	1
TOUCH OUT	2	2	2	2	2	2	

Notes:

1. Correct specifications depend on the actual model all specifications are subject to change without prior notice.
 2. Weight and dimensions shown are approximate.
 3. Specifications and external appearance may be changed for the sake of improvement.
- * Due to different standby conditions, the standby power consumption of some models could be higher than 0.5W.



PRINTED ON
RECYCLED PAPER