

MEASUREMENT REPORT

FCC PART 15.225 RFID

FCC ID: 2ADI8-SL025M

Applicant: BEIJING STRONGLINK TECHNOLOGY CO., LTD.

Application Type: Certification

Product: MIFARE MODULE

Model No.: SL025M_V3.0

FCC Classification: Part 15 Low Power Communication Device Transmitter (DXX)

FCC Rule Part(s): Part 15 Subpart C (Section 15.225)

Test Procedure(s): ANSI C63.10-2013

Test Date: April 11 ~ 19, 2019

Reviewed By: 
(Sunny Sun)

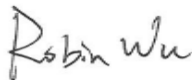
Approved By: 
(Robin Wu)



The test results relate only to the samples tested.

This equipment has been shown to be capable of compliance with the applicable technical standards as indicated in the measurement report and was tested in accordance with the measurement procedures specified in ANSI C63.10. Test results reported herein relate only to the item(s) tested.

The test report shall not be reproduced except in full without the written approval of MRT Technology (Suzhou) Co., Ltd.

Revision History

Report No.	Version	Description	Issue Date	Note
1903RSU039-U1	Rev. 01	Initial Report	04-30-2019	Valid

CONTENTS

Description	Page
§2.1033 General Information	5
1. INTRODUCTION	6
1.1. Scope	6
1.2. MRT Test Location	6
2. PRODUCT INFORMATION	7
2.1. Equipment Description	7
2.2. Test Mode	7
2.3. Test Configuration	7
2.4. EMI Suppression Device(s)/Modifications	7
2.5. Labeling Requirements	7
3. DESCRIPTION OF TEST	8
3.1. Evaluation Procedure	8
3.2. AC Line Conducted Emissions.....	8
3.3. Radiated Emissions.....	9
4. ANTENNA REQUIREMENTS	10
5. TEST EQUIPMENT CALIBRATION DATE	11
6. MEASUREMENT UNCERTAINTY	13
7. TEST RESULT	14
7.1. Summary	14
7.2. In-band Emission.....	15
7.2.1. Test Limit	15
7.2.2. Test Procedure Used.....	15
7.2.3. Test Setting.....	15
7.2.4. Test Setup	16
7.2.5. Test Result.....	17
7.3. Out-band Emission.....	18
7.3.1. Test Limit	18
7.3.2. Test Procedure Used.....	18
7.3.3. Test Setting.....	18
7.3.4. Test Setup	19
7.3.5. Test Result.....	20
7.4. 20dB Bandwidth	21
7.4.1. Test Limit	21

7.4.2.	Test Procedure Used.....	21
7.4.3.	Test Setting.....	21
7.4.4.	Test Setup	21
7.4.5.	Test Result.....	22
7.5.	Frequency Tolerance	23
7.5.1.	Test Limit	23
7.5.2.	Test Procedure Used.....	23
7.5.3.	Test Setting.....	23
7.5.4.	Test Setup	24
7.5.5.	Test Result.....	25
7.6.	AC Conducted Emissions Measurement.....	26
7.6.1.	Test Limit	26
7.6.2.	Test Setup	26
7.6.3.	Test Result.....	27
8.	CONCLUSION.....	30
	Appendix A - Test Setup Photograph.....	31
	Appendix B - EUT Photograph	32

§2.1033 General Information

Applicant:	BEIJING STRONGLINK TECHNOLOGY CO., LTD.
Applicant Address:	Building C No.39 Xi'erqi street Haidian district, Beijing, 100085 China
Manufacturer:	BEIJING STRONGLINK TECHNOLOGY CO., LTD.
Manufacturer Address:	Building C No.39 Xi'erqi street Haidian district, Beijing, 100085 China
Test Site:	MRT Technology (Suzhou) Co., Ltd
Test Site Address:	D8 Building, No.2 Tian'edang Rd., Wuzhong Economic Development Zone, Suzhou, China

Test Facility / Accreditations

Measurements were performed at MRT Laboratory located in Tian'edang Rd., Suzhou, China.

- MRT facility is a FCC registered (MRT Reg. No. 893164) test facility with the site description report on file and has met all the requirements specified in Section 2.948 of the FCC Rules.
- MRT facility is an IC registered (MRT Reg. No. 11384A-1) test laboratory with the site description on file at Industry Canada.
- MRT facility is a VCCI registered (R-20025, G-20034, C-20020, T-20020) test laboratory with the site description on file at VCCI Council.
- MRT Lab is accredited to ISO 17025 by the American Association for Laboratory Accreditation (A2LA) under the American Association for Laboratory Accreditation Program (A2LA Cert. No. 3628.01) in EMC, Telecommunications and Radio testing for FCC, Industry Canada, EU and TELEC Rules.



1. INTRODUCTION

1.1. Scope

Measurement and determination of electromagnetic emissions (EMC) of radio frequency devices including intentional and/or unintentional radiators for compliance with the technical rules and regulations of the Federal Communications Commission and the Industry Canada Certification and Engineering Bureau.

1.2. MRT Test Location

The map below shows the location of the MRT LABORATORY, its proximity to the Taihu Lake. These measurement tests were conducted at the MRT Technology (Suzhou) Co., Ltd. Facility located at D8 Building, No.2 Tian'edang Rd., Wuzhong Economic Development Zone, Suzhou, China. The measurement facility compliant with the test site requirements specified in ANSI C63.4-2014.



2. PRODUCT INFORMATION

2.1. Equipment Description

Product Name:	MIFARE MODULE
Model No.:	SL025M_V3.0
RF ID:	13.56MHz

2.2. Test Mode

Test Mode
Mode 1: Transmit by RFID

2.3. Test Configuration

The device was set to continuous transmission. This was performance using manufacturer software loaded on the MIFARE MODULE to allow for continuous transmission. This device was tested in accordance with the guidance of ANSI C63.10-2013. ANSI C63.4-2014 was used to reference the appropriate EUT setup for radiated spurious emissions testing and AC line conducted testing.

2.4. EMI Suppression Device(s)/Modifications

No EMI suppression device(s) were added and/or no modifications were made during testing.

2.5. Labeling Requirements

Per 2.1074 & 15.19; Docket 95-19

The label shall be permanently affixed at a conspicuous location on the device; instruction manual or pamphlet supplied to the user and be readily visible to the purchaser at the time of purchase. However, when the device is so small wherein placement of the label with specified statement is not practical, only the FCC ID must be displayed on the device per Section 15.19(a)(5). Please see attachment for FCC ID label and label location.

3. DESCRIPTION OF TEST

3.1. Evaluation Procedure

The measurement procedures described in the American National Standard for Testing Unlicensed Wireless Devices (ANSI C63.10-2013) was used in the measurement.

Deviation from measurement procedure.....None

3.2. AC Line Conducted Emissions

The line-conducted facility is located inside an 8'x4'x4' shielded enclosure. A 1m x 2m wooden table 80cm high is placed 40cm away from the vertical wall and 80cm away from the sidewall of the shielded room. Two 10kHz-30MHz, 50Ω/50uH Line-Impedance Stabilization Networks (LISNs) are bonded to the shielded room floor. Power to the LISNs is filtered by external high-current high-insertion loss power line filters. These filters attenuate ambient signal noise from entering the measurement lines. These filters are also bonded to the shielded enclosure.

The EUT is powered from one LISN and the support equipment is powered from the second LISN. All interconnecting cables more than 1 meter were shortened to a 1 meter length by non-inductive bundling (serpentine fashion) and draped over the back edge of the test table. All cables were at least 40cm above the horizontal reference ground-plane. Power cables for support equipment were routed down to the second LISN while ensuring that that cables were not draped over the second LISN.

Sufficient time for the EUT, support equipment, and test equipment was allowed in order for them to warm up to their normal operating condition. The RF output of the LISN was connected to the receiver and exploratory measurements were made to determine the frequencies producing the maximum emission from the EUT. The receiver was scanned from 150kHz to 30MHz. The detector function was set to peak mode for exploratory measurements while the bandwidth of the analyzer was set to 9kHz. The EUT, support equipment, and interconnecting cables were arranged and manipulated to maximize each emission. Each emission was also maximized by varying: power lines, the mode of operation or data exchange speed, or support equipment whichever determined the worst-case emission. Once the worst case emissions have been identified, the one EUT cable configuration/arrangement and mode of operation that produced these emissions are used for final measurements on the same test site. The analyzer is set to CISPR quasi-peak and average detectors with a 9kHz resolution bandwidth for final measurements.

An extension cord was used to connect to a single LISN which powered by EUT. The extension cord was calibrated with LISN, the impedance and insertion loss are compliance with the requirements as stated in ANSI C63.10-2013.

3.3. Radiated Emissions

The radiated test facilities consisted of an indoor 3 meter semi-anechoic chamber used for final measurements and exploratory measurements, when necessary. The measurement area is contained within the semi-anechoic chamber which is shielded from any ambient interference. For measurements above 1GHz absorbers are arranged on the floor between the turn table and the antenna mast in such a way so as to maximize the reduction of reflections. For measurements below 1GHz, the absorbers are removed. A MF Model 210SS turntable is used for radiated measurement. It is a continuously rotatable, remote controlled, metallic turntable and 2 meters (6.56 ft.) in diameter. The turn table is flush with the raised floor of the chamber in order to maintain its function as a ground plane. An 80cm high PVC support structure is placed on top of the turntable.

For all measurements, the spectrum was scanned through all EUT azimuths and from 1 to 4 meter receive antenna height using a broadband antenna from 30MHz up to the upper frequency shown in 15.33(b)(1) depending on the highest frequency generated or used in the device or on which the device operates or tunes. For frequencies above 1GHz, linearly polarized double ridge horn antennas were used. For frequencies below 30MHz, a calibrated loop antenna was used. When exploratory measurements were necessary, they were performed at 1 meter test distance inside the semi-anechoic chamber using broadband antennas, broadband amplifiers, and spectrum analyzers to determine the frequencies and modes producing the maximum emissions. Sufficient time for the EUT, support equipment, and test equipment was allowed in order for them to warm up to their normal operating condition. The test set-up was placed on top of the 0.8 meter high, 1 x 1.5 meter table. The EUT, support equipment, and interconnecting cables were arranged and manipulated to maximize each emission. Appropriate precaution was taken to ensure that all emissions from the EUT were maximized and investigated. The system configuration, clock speed, mode of operation or video resolution, if applicable, turntable azimuth, and receive antenna height was noted for each frequency found.

Final measurements were made in the semi-anechoic chamber using calibrated, linearly polarized broadband and horn antennas. The test setup was configured to the setup that produced the worst case emissions. The spectrum analyzer was set to investigate all frequencies required for testing to compare the highest radiated disturbances with respect to the specified limits. The turntable containing the EUT was rotated through 360 degrees and the height of the receive antenna was varied 1 to 4 meters and stopped at the azimuth and height producing the maximum emission. Each emission was maximized by changing the orientation of the EUT through three orthogonal planes and changing the polarity of the receive antenna, whichever produced the worst-case emissions. According to 3dB Beam-Width of horn antenna, the horn antenna should be always directed to the EUT when rising height.

4. ANTENNA REQUIREMENTS

Excerpt from §15.203 of the FCC Rules/Regulations:

“An intentional radiator antenna shall be designed to ensure that no antenna other than that furnished by the responsible party can be used with the device. The use of a permanently attached antenna or of an antenna that uses a unique coupling to the intentional radiator shall be considered sufficient to comply with the provisions of this section.”

- The antenna of the MIFARE MODULE is **permanently attached**.
- There are no provisions for connection to an external antenna.

Conclusion:

The unit complies with the requirement of §15.203.

5. TEST EQUIPMENT CALIBRATION DATE

Conducted Emissions - SR2

Instrument	Manufacturer	Type No.	Asset No.	Cali. Interval	Cali. Due Date
EMI Test Receiver	R&S	ESR3	MRTSUE06185	1 year	2019/04/20
				1 year	2020/04/15
Two-Line V-Network	R&S	ENV 216	MRTSUE06002	1 year	2019/06/14
Two-Line V-Network	R&S	ENV 216	MRTSUE06003	1 year	2019/06/14
Thermohygrometer	Testo	608-H1	MRTSUE06404	1 year	2019/08/14
Shielding Chamber	MIX-BEP	Chamber-SR2	MRTSUE06214	N/A	N/A

Radiated Emissions - AC1

Instrument	Manufacturer	Type No.	Asset No.	Cali. Interval	Cali. Due Date
EMI Test Receiver	R&S	ESR7	MRTSUE06001	1 year	2019/08/13
PXA Signal Analyzer	Keysight	9030B	MRTSUE06395	1 year	2019/09/25
Loop Antenna	Schwarzbeck	FMZB 1519	MRTSUE06025	1 year	2019/11/09
Bilog Period Antenna	Schwarzbeck	VULB 9168	MRTSUE06172	1 year	2020/03/31
Broad Band Horn Antenna	Schwarzbeck	BBHA 9120D	MRTSUE06023	1 year	2019/10/19
Broad Band Horn Antenna	Schwarzbeck	BBHA 9170	MRTSUE06024	1 year	2019/12/17
Microwave System Amplifier	Agilent	83017A	MRTSUE06076	1 year	2019/11/16
Preamplifier	Schwarzbeck	BBV 9721	MRTSUE06121	1 year	2019/06/12
Thermohygrometer	Testo	608-H1	MRTSUE06403	1 year	2019/08/14
Anechoic Chamber	TDK	Chamber-AC1	MRTSUE06213	1 year	2019/05/01

Radiated Emission - AC2

Instrument	Manufacturer	Type No.	Asset No.	Cali. Interval	Cali. Due Date
Spectrum Analyzer	Keysight	N9038A	MRTSUE06125	1 year	2019/08/13
Loop Antenna	Schwarzbeck	FMZB 1519	MRTSUE06025	1 year	2019/11/09
Bilog Period Antenna	Schwarzbeck	VULB 9162	MRTSUE06022	1 year	2019/10/19
Horn Antenna	Schwarzbeck	BBHA9120D	MRTSUE06171	1 year	2019/11/09
Broad Band Horn Antenna	Schwarzbeck	BBHA 9170	MRTSUE06024	1 year	2019/12/17
Broadband Coaxial Preamplifier	Schwarzbeck	BBV 9718	MRTSUE06176	1 year	2019/11/16
Preamplifier	Schwarzbeck	BBV 9721	MRTSUE06121	1 year	2019/06/12
Temperature/Humidity Meter	Minggao	ETH529	MRTSUE06170	1 year	2019/12/13
Anechoic Chamber	RIKEN	Chamber-AC2	MRTSUE06213	1 year	2019/05/01

Frequency Tolerance - TR3

Instrument	Manufacturer	Type No.	Asset No.	Cali. Interval	Cali. Due Date
EXA Signal Analyzer	Keysight	N9010B	MRTSUE06452	1 year	2019/07/19
Temperature & Humidity Chamber	BAOYT	BYH-150CL	MRTSUE06051	1 year	2019/11/16
Thermohygrometer	testo	608-H1	MRTSUE06401	1 year	2019/08/14

Software	Version	Function
EMI Software	V3	EMI Test Software

6. MEASUREMENT UNCERTAINTY

Where relevant, the following test uncertainty levels have been estimated for tests performed on the EUT as specified in CISPR 16-4-2. This uncertainty represents an expanded uncertainty expressed at approximately the 95% confidence level using a coverage factor of $k = 2$.

AC Conducted Emission Measurement - SR2
<p>The maximum measurement uncertainty is evaluated as:</p> <p>9kHz~150kHz: 3.84dB</p> <p>150kHz~30MHz: 3.46dB</p>
Radiated Emission Measurement - AC1
<p>The maximum measurement uncertainty is evaluated as:</p> <p>Horizontal: 30MHz~300MHz: 4.07dB</p> <p> 300MHz~1GHz: 3.63dB</p> <p> 1GHz~18GHz: 4.16dB</p> <p>Vertical: 30MHz~300MHz: 4.18dB</p> <p> 300MHz~1GHz: 3.60dB</p> <p> 1GHz~18GHz: 4.76dB</p>
Radiated Emission Measurement - AC2
<p>The maximum measurement uncertainty is evaluated as:</p> <p>Horizontal: 30MHz~300MHz: 3.75dB</p> <p> 300MHz~1GHz: 3.53dB</p> <p> 1GHz~18GHz: 4.28dB</p> <p>Vertical: 30MHz~300MHz: 3.86dB</p> <p> 300MHz~1GHz: 3.53dB</p> <p> 1GHz~18GHz: 4.33dB</p>

7. TEST RESULT

7.1. Summary

FCC Part Section(s)	Test Description	Test Limit	Test Condition	Test Result	Reference
15.225(a), (b), (c)	In-Band Emission	For 13.553 ~ 13.567 MHz: 15.848uV/m @ 30m For 13.410 ~ 13.553 MHz & 13.567 ~ 13.710 MHz: 334uV/m @ 30m For 13.110 ~ 13.410 MHz & 13.710 ~ 14.010 MHz: 106uV/m @ 30m	Radiated	Pass	Section 7.2
15.225(d)	Out-Band Emission	Emissions outside of the 13.110~14.010 MHz band shall not exceed the general radiated emission limits in §15.209.		Pass	Section 7.3
2.1049	20dB Bandwidth	N/A		Pass	Section 7.4
15.225(e)	Frequency Tolerance	±0.01% of operating frequency		Pass	Section 7.5
15.207	AC Conducted Emissions 150kHz - 30MHz	< §15.207 limits	Line Conducted	Pass	Section 7.6

Notes: All modes of operation and data rates were investigated. For radiated emission test, every axis (X, Y, Z) was also verified. The test results shown in the following sections represent the worst case emissions.

7.2. In-band Emission

7.2.1. Test Limit

FCC Part 15 Subpart C Paragraph 15.225		
Frequency (MHz)	Distance (m)	Level (uV/m)
13.553 ~13.567	30	15,848
13.410 ~13.553 13.567 ~13.710	30	334.5
13.110 ~13.410 13.710 ~14.010	30	106

Note 1: The lower limit shall apply at the transition frequency.

Note 2: Distance refers to the distance in meters between the measuring instrument antenna and the closed point of any part of the device or system.

Note 3: E field strength (dBuV/m) = 20 log E field strength (uV/m)

7.2.2. Test Procedure Used

ANSI C63.10 Section 6.3 (General Requirements)

ANSI C63.10 Section 6.4 (Standard test method below 30MHz)

7.2.3. Test Setting

1. Analyzer center frequency was set to the frequency of the radiated spurious emission of interest
2. Set the spectrum analyzer frequency span to capture fully the emission that is to be measured.
3. RBW = 9kHz
4. Detector = CISPR quasi-peak
5. Sweep time = auto couple
6. Trace was allowed to stabilize

7.2.4. Test Setup

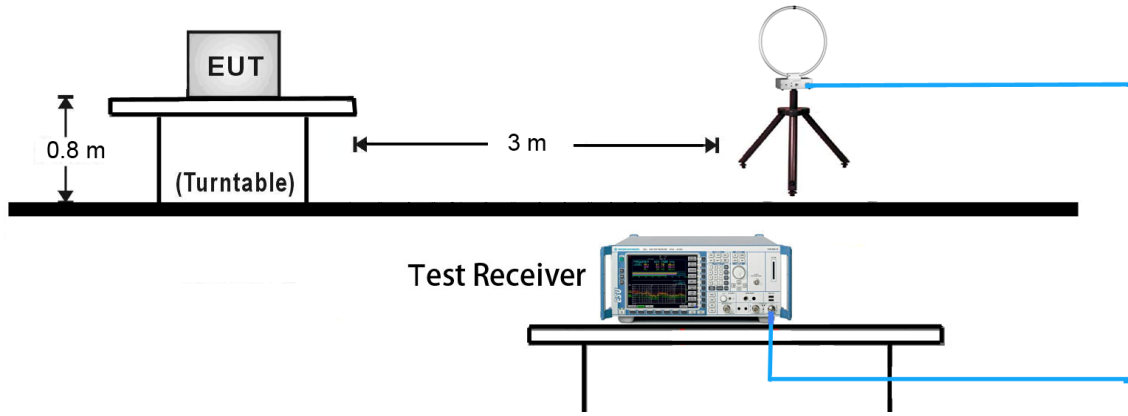

7.2.5. Test Result

Product	MIFARE MODULE	Temperature	25°C
Test Engineer	Flag Yang	Relative Humidity	52%
Test Site	AC1	Test Time	2019/04/11

Frequency	Reading Level (dBuV/m)	Factor (dB)	Measure Level (dBuV/m)	Limit (3m) (dBuV/m)	Margin [dB]	Detector
Face On						
13.34	27.00	19.85	46.85	80.51	-33.66	QP
13.49	29.98	19.87	49.85	90.47	-40.62	QP
13.56	47.79	19.87	67.66	124.00	-56.34	QP
13.64	28.50	19.86	48.36	90.47	-42.11	QP
13.78	25.40	19.88	45.28	80.51	-35.23	QP
Face Off						
13.34	23.75	19.85	43.60	80.51	-36.91	QP
13.52	27.05	19.86	46.91	90.47	-43.56	QP
13.56	44.59	19.87	64.46	124.00	-59.54	QP
13.58	25.54	19.86	45.40	90.47	-45.07	QP
13.72	19.98	19.87	39.85	80.51	-40.66	QP

Note:

- All measurements were performed using a loop antenna. The antenna was positioned in two orthogonal (face on and face off) and the position with the highest emission level was recorded.
- For below 30MHz, the limits were calculated as below:
 E field strength (dBuV/m) = 20 log E field strength (uV/m)
 Limit (dBuV/m)@3m = Limit (dBuV/m)@30m + 40*Log₁₀(30/3).
 For example, the limits of frequency range (13.553 ~ 13.567MHz) are calculated as below:
 Limit (dBuV/m)@3m = [20*log(15,848) + 40*Log₁₀(30/3)] (dBuV/m) ≈ 124.00 (dBuV/m).
- Measure Level (dBuV/m) = Reading Level (dBuV) + Factor (dB)
 Factor (dB) = Cable Loss (dB) + Antenna Factor (dB/m).

7.3. Out-band Emission

7.3.1. Test Limit

FCC Part 15 Subpart C Paragraph 15.209		
Frequency [MHz]	Field Strength [uV/m]	Measured Distance [Meters]
0.009 ~ 0.490	2400/F (kHz)	300
0.490 ~ 1.705	24000/F (kHz)	30
1.705 ~ 30	30	30
30 ~ 88	100	3
88 ~ 216	150	3
216 ~ 960	200	3
Above 960	500	3

Note 1: The lower limit shall apply at the transition frequency.
 Note 2: Distance refers to the distance in meters between the measuring instrument antenna and the closed point of any part of the device or system.
 Note 3: E field strength (dBuV/m) = 20 log E field strength (uV/m)

7.3.2. Test Procedure Used

ANSI C63.10 Section 6.3 (General Requirements)

ANSI C63.10 Section 6.4 (Standard test method below 30MHz)

ANSI C63.10 Section 6.5 (Standard test method above 30MHz to 1GHz)

7.3.3. Test Setting

1. Analyzer center frequency was set to the frequency of the radiated spurious emission of interest
2. Set the spectrum analyzer frequency span to capture fully the emission that is to be measured.
3. RBW = as specified in Table 1
4. Detector = CISPR quasi-peak or average
5. Sweep time = auto couple
6. Trace was allowed to stabilize

Table 1 - RBW as a function of frequency

Frequency	RBW
9 ~ 150 kHz	200 ~ 300 Hz
0.15 ~ 30 MHz	9 ~ 10 kHz
30 ~ 1000 MHz	100 ~ 120 kHz

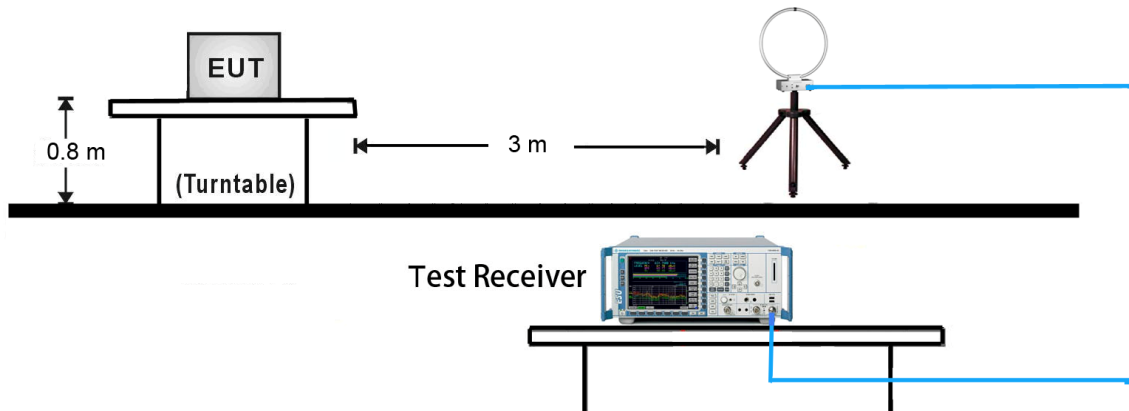
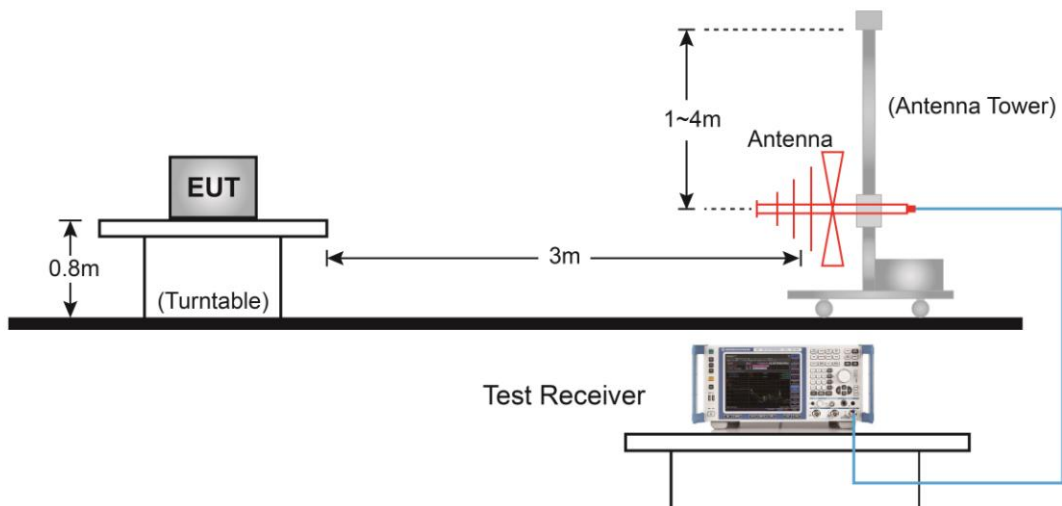
7.3.4. Test Setup
9kHz ~ 30MHz Test Setup:

30MHz ~ 1GHz Test Setup:

7.3.5. Test Result

Product	MIFARE MODULE	Temperature	25°C
Test Engineer	Flag Yang	Relative Humidity	52%
Test Site	AC1	Test Time	2019/04/11

Frequency (MHz)	Reading Level (dBuV/m)	Factor (dB)	Measure Level (dBuV/m)	Limit (dBuV/m)	Margin (dB)	Detector	Polarization
Below 30MHz							
27.12	7.01	19.51	26.52	69.54	-43.02	QP	Face On
27.12	8.78	19.51	28.29	69.54	-41.25	QP	Face Off
Above 30MHz							
74.62	8.18	10.99	19.17	40.00	-20.83	QP	Horizontal
101.30	8.45	11.29	19.74	43.50	-23.76	QP	Horizontal
128.94	5.29	13.88	19.17	43.50	-24.33	QP	Horizontal
164.35	2.54	15.02	17.56	43.50	-25.94	QP	Horizontal
222.55	4.50	12.28	16.78	46.00	-29.22	QP	Horizontal
801.15	-0.83	23.66	22.83	46.00	-23.17	QP	Horizontal
30.49	18.22	13.79	32.01	40.00	-7.99	QP	Vertical
72.20	16.25	11.35	27.60	40.00	-12.40	QP	Vertical
125.06	12.42	13.64	26.06	43.50	-17.44	QP	Vertical
162.41	11.58	15.19	26.77	43.50	-16.73	QP	Vertical
220.61	10.78	12.17	22.95	46.00	-23.05	QP	Vertical
728.89	2.45	22.85	25.30	46.00	-20.70	QP	Vertical

- The measurements were performed using a loop antenna for below 30MHz. The antenna was positioned in two orthogonal (face on and face off) and the position with the highest emission level was recorded.
- For below 30MHz, the limits were calculated as below:

$$E \text{ field strength (dBuV/m)} = 20 \log E \text{ field strength (uV/m)} = 20 * \log(30) \text{ dBuV/m} = 29.54 \text{ dBuV/m}$$

$$\text{Limit (dBuV/m)}@3\text{m} = \text{Limit (dBuV/m)}@30\text{m} + 40 * \log_{10}(30/3) = (29.54 + 40) \text{ dBuV/m} = 69.54 \text{ dBuV/m}.$$
- Measure Level (dBuV/m) = Reading Level (dBuV) + Factor (dB)
 Factor (dB) = Cable Loss (dB) + Antenna Factor (dB/m).

7.4. 20dB Bandwidth

7.4.1. Test Limit

N/A

7.4.2. Test Procedure Used

ANSI C63.10 Clause 6.9.2

7.4.3. Test Setting

1. The span range shall be two times and five times the OBW
2. Set RBW = 1% to 5% of the OBW
3. VBW shall be approximately three times RBW
4. Detector = Peak
5. Trace mode = max hold
6. Sweep = auto couple
7. Allow the trace was allowed to stabilize and marker the highest level.
8. Determine the display level (the highest level - 20dB) and place two markers, one at the lowest frequency and the other at the highest frequency.

7.4.4. Test Setup

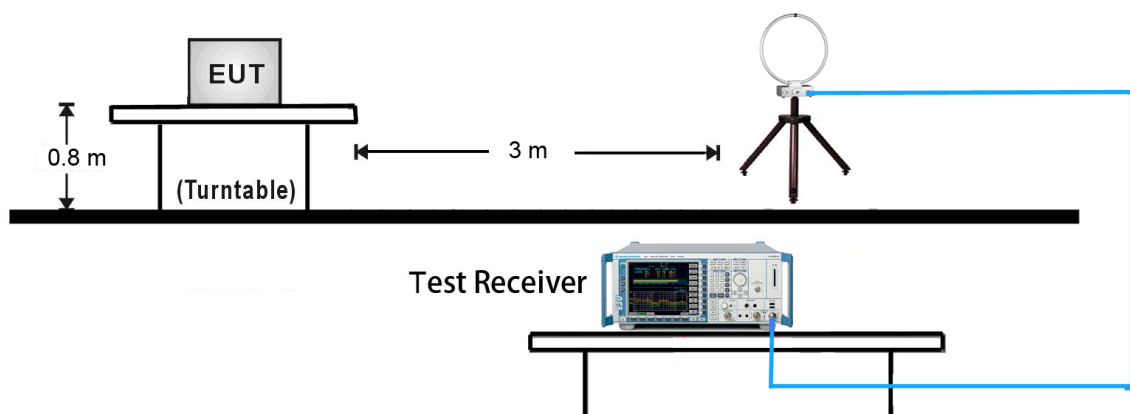

7.4.5. Test Result

Product	MIFARE MODULE	Temperature	25°C
Test Engineer	Flag Yang	Relative Humidity	52%
Test Site	AC1	Test Time	2019/04/16

Bandwidth		Limit
F _L	13.524 MHz	> 13.110 MHz
F _H	13.598 MHz	< 14.010 MHz
20dB Bandwidth	0.074 MHz	
Result	Pass	

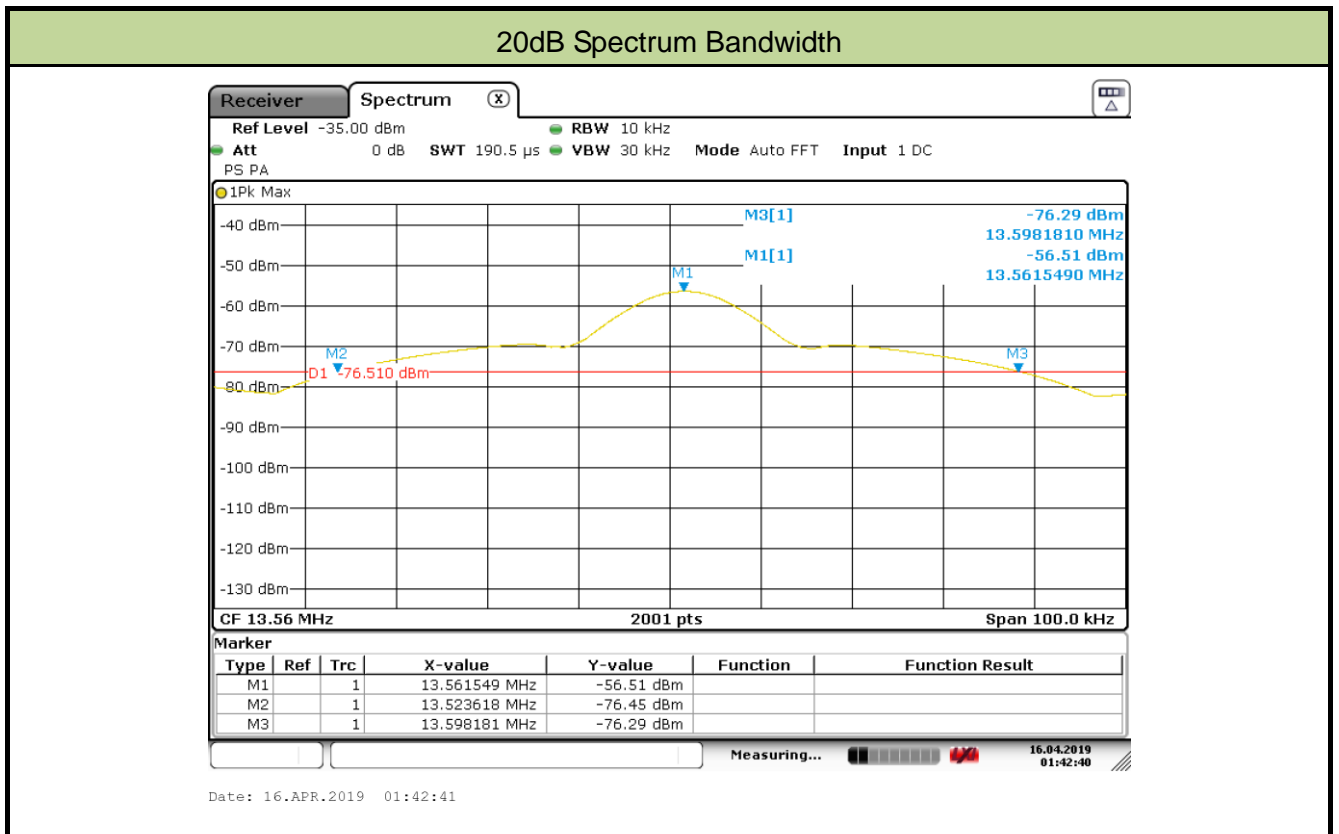

7.5. Frequency Tolerance

7.5.1. Test Limit

The frequency tolerance of the carrier signal shall be maintained within $\pm 0.01\%$ of the operating frequency.

7.5.2. Test Procedure Used

ANSI C63.10 Clause 6.8

7.5.3. Test Setting

Frequency stability with respect to ambient temperature

- a) Supply the EUT with a nominal ac voltage (120 V)
- b) Couple the EUT output to the measuring instrument by connecting an antenna to the measuring instrument with a suitable length of coaxial cable and placing the measuring antenna near the EUT (e.g., 15 cm away).
- c) Adjust the location of the measurement antenna and the controls on the measurement instrument to obtain a suitable signal level.
- d) Turn the EUT OFF and place it inside the environmental temperature chamber.
- e) Set the temperature control on the chamber to the highest (50 °C) and allow the oscillator heater and the chamber temperature to stabilize.
- f) While maintaining a constant temperature inside the environmental chamber, turn the EUT ON and record the operating frequency at startup, and at 2 minutes, 5 minutes, and 10 minutes after the EUT is energized. Four measurements in total are made.
- g) Switch OFF the EUT but do not switch OFF the oscillator heater.
- h) Lower the chamber temperature by not more than 10 °C, and allow the temperature inside the chamber to stabilize.
- i) Repeat step f) through step h) down to the lowest specified temperature (-20 °C).

Frequency stability when varying supply voltage

Unless otherwise specified, these tests shall be made at ambient room temperature (+15 °C to +25 °C)

- a) Supply the EUT with nominal voltage (120 V). Turn ON the EUT and couple its output to a frequency counter or other frequency-measuring instrument.

- b) Adjust the location of the measurement antenna and the controls on the measurement instrument to obtain a suitable signal level.
- c) Repeat the above procedure at 85% and 115% of the nominal supply voltage.

7.5.4. Test Setup

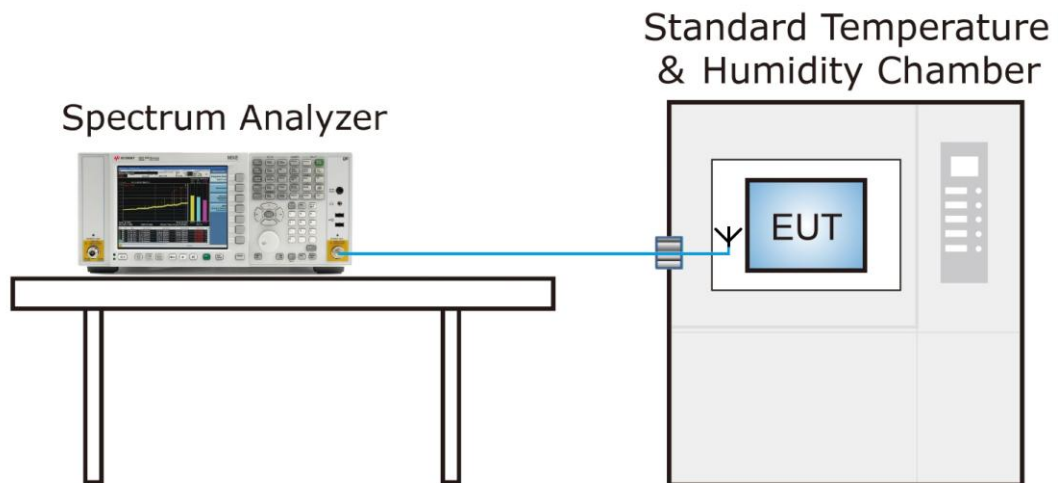

7.5.5. Test Result

Product	MIFARE MODULE	Temperature	-20°C ~ 50°C
Test Engineer	Flag Yang	Relative Humidity	52%
Test Site	TR3	Test Time	2019/04/19

Voltage (%)	Power (VAC)	Temp (°C)	Frequency Tolerance (%)			
			0 minutes	2 minutes	5 minutes	10 minutes
100%	120	- 20	0.0054	0.0048	0.0052	0.0059
		- 10	0.0049	0.0047	0.0044	0.0048
		0	0.0045	0.0046	0.0049	0.0051
		+ 10	0.0048	0.0047	0.0052	0.0053
		+ 20 (Ref)	0.0054	0.0052	0.0051	0.0056
		+ 30	0.0060	0.0058	0.0061	0.0059
		+ 40	0.0068	0.0067	0.0069	0.0071
		+ 50	0.0069	0.0071	0.0068	0.0072
115%	138	+ 20	0.0055	0.0054	0.0056	0.0057
85%	102	+ 20	0.0055	0.0055	0.0057	0.0056

Frequency Tolerance (%) = {[Measured Frequency (Hz) - Declared Frequency (Hz)] / Declared Frequency (Hz)} *100.

7.6. AC Conducted Emissions Measurement

7.6.1. Test Limit

FCC 15.207 Limits		
Frequency (MHz)	QP (dBuV)	AV (dBuV)
0.15 ~ 0.50	66 ~ 56	56 ~ 46
0.50 ~ 5.0	56	46
5.0 ~ 30	60	50

Note 1: The lower limit shall apply at the transition frequencies.

Note 2: The limit decreases linearly with the logarithm of the frequency in the range 0.15MHz to 0.5MHz.

7.6.2. Test Setup

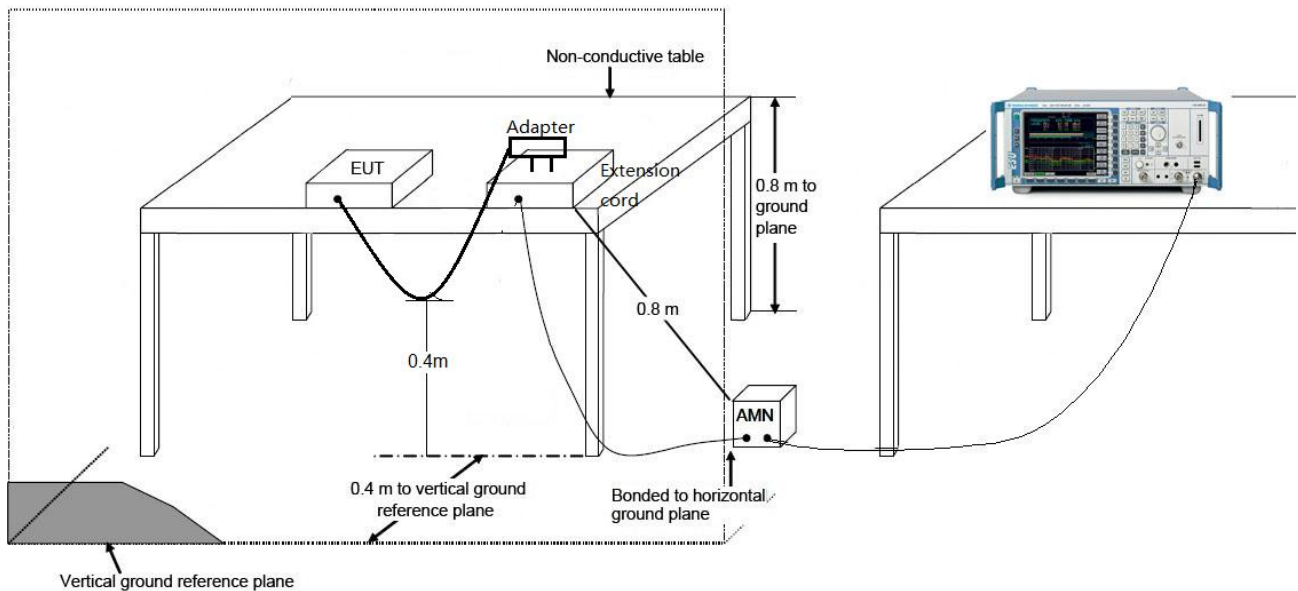

7.6.3. Test Result

Site: SR2	Time: 2019/04/11 - 13:14
Limit: FCC_Part15.207_CE_AC Power	Engineer: David Lv
Probe: ENV216_101683_Filter On	Polarity: Line
EUT: MIFARE MODULE	Power: AC 120V/60Hz
Test Mode 1	

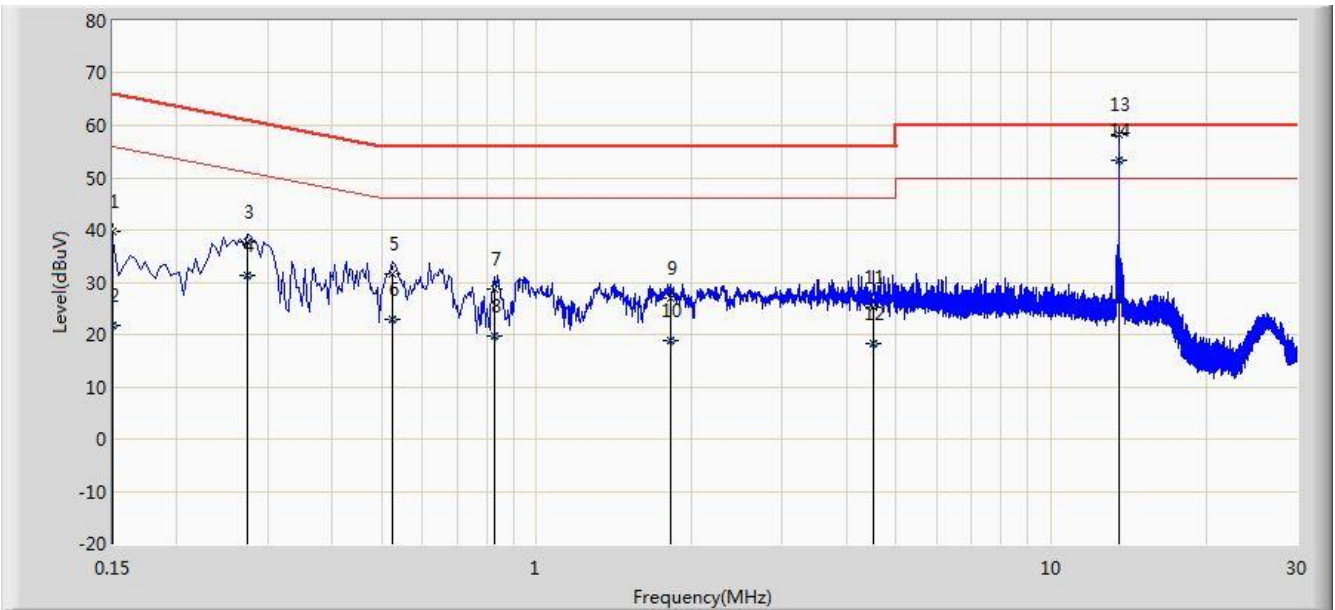

No	Flag	Mark	Frequency (MHz)	Measure Level (dBuV)	Reading Level (dBuV)	Over Limit (dB)	Limit (dBuV)	Factor (dB)	Type
1			0.150	39.708	28.540	-26.292	66.000	11.168	QP
2			0.150	21.881	10.712	-34.119	56.000	11.168	AV
3			0.274	37.676	27.692	-23.320	60.996	9.983	QP
4			0.274	31.172	21.189	-19.824	50.996	9.983	AV
5			0.526	31.529	21.376	-24.471	56.000	10.153	QP
6			0.526	22.914	12.761	-23.086	46.000	10.153	AV
7			0.826	28.560	18.562	-27.440	56.000	9.998	QP
8			0.826	19.600	9.602	-26.400	46.000	9.998	AV
9			1.826	26.915	17.038	-29.085	56.000	9.877	QP
10			1.826	18.887	9.010	-27.113	46.000	9.877	AV
11			4.510	25.206	15.215	-30.794	56.000	9.991	QP
12			4.510	18.239	8.248	-27.761	46.000	9.991	AV
13			13.562	58.258	48.200	N/A	N/A	10.058	QP
14		*	13.562	53.254	43.196	N/A	N/A	10.058	AV

Note 1: Measure Level (dBμV) = Reading Level (dBμV) + Factor (dB)

Factor (dB) = Cable Loss (dB) + LISN Factor (dB).

Note 2: 13.56MHz (Point 13 & 14) is the RFID fundamental signal.

Site: SR2	Time: 2019/04/11 - 13:18
Limit: FCC_Part15.207_CE_AC Power	Engineer: David Lv
Probe: ENV216_101683_Filter On	Polarity: Neutral
EUT: MIFARE MODULE	Power: AC 120V/60Hz
Test Mode 1	

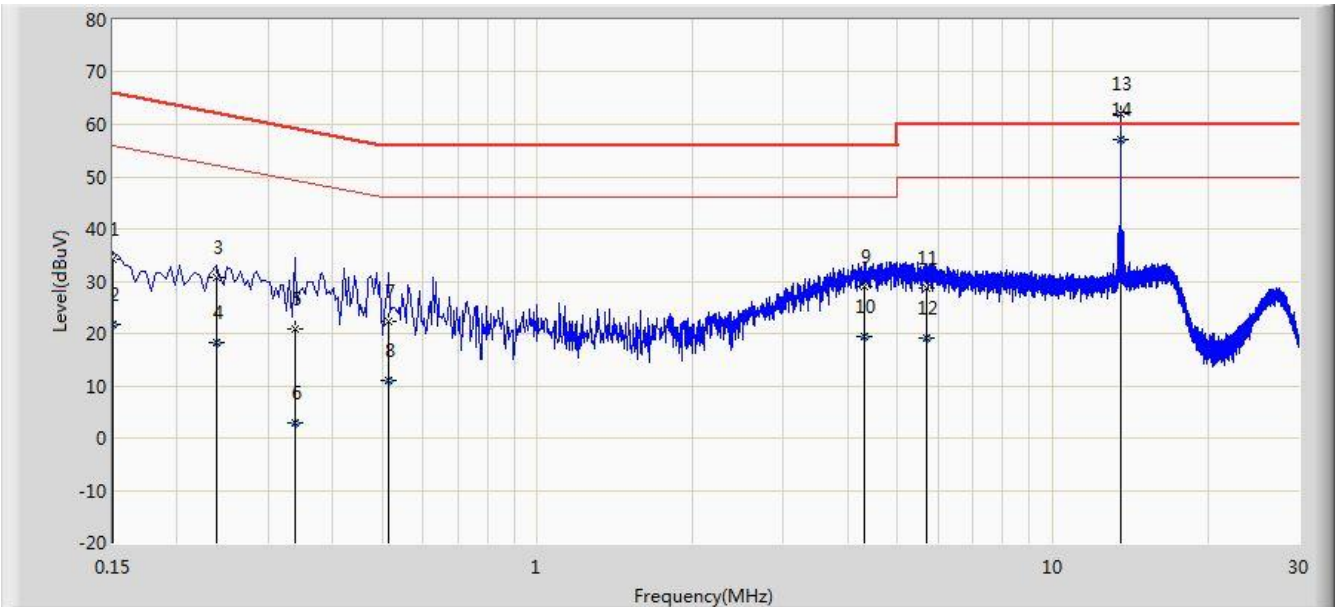

No	Flag	Mark	Frequency (MHz)	Measure Level (dBuV)	Reading Level (dBuV)	Over Limit (dB)	Limit (dBuV)	Factor (dB)	Type
1			0.150	34.090	22.948	-31.910	66.000	11.142	QP
2			0.150	21.809	10.667	-34.191	56.000	11.142	AV
3			0.238	30.811	20.820	-31.354	62.166	9.992	QP
4			0.238	18.297	8.306	-33.868	52.166	9.992	AV
5			0.338	20.987	10.922	-38.265	59.252	10.066	QP
6			0.338	2.958	-7.107	-46.294	49.252	10.066	AV
7			0.514	22.277	12.101	-33.723	56.000	10.176	QP
8			0.514	10.992	0.816	-35.008	46.000	10.176	AV
9			4.306	28.917	18.930	-27.083	56.000	9.988	QP
10			4.306	19.479	9.491	-26.521	46.000	9.988	AV
11			5.706	28.667	18.554	-31.333	60.000	10.113	QP
12			5.706	19.104	8.992	-30.896	50.000	10.113	AV
13			13.562	62.013	51.913	N/A	N/A	10.100	QP
14		*	13.562	57.125	47.025	N/A	N/A	10.100	AV

Note 1: Measure Level (dB μ V) = Reading Level (dB μ V) + Factor (dB)

Factor (dB) = Cable Loss (dB) + LISN Factor (dB).

Note 2: 13.56MHz (Point 13 & 14) is the RFID fundamental signal.

8. CONCLUSION

The data collected relate only the item(s) tested and show that the **MIFARE MODULE** is in compliance with Part 15C of the FCC Rules.

_____ The End _____

Appendix A - Test Setup Photograph

Refer to "1903RSU039-UT" file.

Appendix B - EUT Photograph

Refer to "1903RSU039-UE" file.