



MEASUREMENT REPORT

FCC PART 15.247 BLE

FCC ID: 2ADHUIDO001

APPLICANT: Shenzhen IDO Intelligent Technology Co. Ltd

Application Type: Certification

Product: Smart Wristband

Model No.: IDO001, IDO002

Brand Name: 

FCC Classification: Digital Transmission System (DTS)

FCC Rule Part(s): Part 15.247

Test Procedure(s): ANSI C63.10-2009, KDB 558074 D01v03r02

Test Date: Oct. 31 ~ Nov. 03, 2014

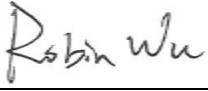
Reviewed By : 
(Robin Wu)

Approved By : 
(Marlin Chen)

The test results relate only to the samples tested.

This equipment has been shown to be capable of compliance with the applicable technical standards as indicated in the measurement report and was tested in accordance with the measurement procedures specified in KDB 558074 D01v03r02. Test results reported herein relate only to the item(s) tested.

The test report shall not be reproduced except in full without the written approval of MRT Technology (Suzhou) Co., Ltd.

Revision History

Report No.	Version	Description	Issue Date
1410RSU02401	Rev. 01	Initial report	11-04-2014

CONTENTS

Description	Page
1. INTRODUCTION	6
1.1. Scope	6
1.2. MRT Test Location	6
2. PRODUCT INFORMATION	7
2.1. Equipment Description.....	7
2.2. Device Capabilities	8
2.3. Test Configuration	8
2.4. Description of Support Units	8
2.5. EMI Suppression Device(s)/Modifications.....	8
2.6. Labeling Requirements.....	8
2.7. Test Software	8
3. DESCRIPTION OF TEST	9
3.1. Evaluation Procedure	9
3.2. AC Line Conducted Emissions	9
3.3. Radiated Emissions	10
4. ANTENNA REQUIREMENTS	11
5. TEST EQUIPMENT CALIBRATION DATE	12
6. MEASUREMENT UNCERTAINTY	13
7. TEST RESULT	14
7.1. Summary	14
7.2. 6dB Bandwidth Measurement.....	15
7.2.1. Test Limit	15
7.2.2. Test Procedure used.....	15
7.2.3. Test Setting.....	15
7.2.4. Test Setup.....	15
7.2.5. Test Result.....	16
7.3. Output Power Measurement.....	17
7.3.1. Test Limit	17
7.3.2. Test Procedure Used	17
7.3.3. Test Setting.....	17
7.3.4. Test Setup.....	17
7.3.5. Test Result of Output Power	18
7.4. Power Spectral Density Measurement	19

7.4.1.	Test Limit	19
7.4.2.	Test Procedure Used	19
7.4.3.	Test Setting.....	19
7.4.4.	Test Setup.....	19
7.4.5.	Test Result.....	20
7.5.	Conducted Band Edge and Out-of-Band Emissions.....	21
7.5.1.	Test Limit	21
7.5.2.	Test Procedure Used	21
7.5.3.	Test Setting.....	21
7.5.4.	Test Setup.....	22
7.5.5.	Test Result.....	23
7.6.	Radiated Spurious Emission Measurement	25
7.6.1.	Test Limit	25
7.6.2.	Test Procedure Used	25
7.6.3.	Test Setting.....	25
7.6.4.	Test Setup.....	27
7.6.5.	Test Result.....	29
7.7.	Radiated Restricted Band Edge Measurement	36
7.7.1.	Test Result.....	36
7.8.	AC Conducted Emissions Measurement.....	44
7.8.1.	Test Limit	44
7.8.2.	Test Setup.....	44
7.8.3.	Test Result.....	45
8.	CONCLUSION.....	47

§2.1033 General Information

Applicant:	Shenzhen IDO Intelligent Technology Co. Ltd
Applicant Address:	Rm. 3204-3205, International Technology Building, Shennan Mid. Rd., Futian District
Manufacturer:	Shenzhen IDO Intelligent Technology Co. Ltd
Manufacturer Address:	Rm. 3204-3205, International Technology Building, Shennan Mid. Rd., Futian District
Test Site:	MRT Technology (Suzhou) Co., Ltd
Test Site Address:	D8 Building, Youxin Industrial Park, No.2 Tian'edang Rd., Wuzhong Economic Development Zone, Suzhou, China
MRT Registration No.:	809388
FCC Rule Part(s):	Part 15.247
Model No.:	IDO001, IDO002
FCC ID:	2ADHUIDO001
Test Device Serial No.:	N/A <input type="checkbox"/> Production <input checked="" type="checkbox"/> Pre-Production <input type="checkbox"/> Engineering
FCC Classification:	Digital Transmission System (DTS)
Date(s) of Test:	Oct. 31 ~ Nov. 03, 2014
Test Report S/N:	1410RSU02401

Test Facility / Accreditations

Measurements were performed at MRT Laboratory located in Tian'edang Rd., Suzhou, China.

- MRT Lab is accredited to ISO 17025 by the American Association for Laboratory Accreditation (A2LA) under the American Association for Laboratory Accreditation Program (A2LA Cert. No. 3628.01) in EMC, Telecommunications and Radio testing for FCC, Industry Canada, EU and TELEC Rules.
- MRT facility is a FCC registered (MRT Reg. No. 809388) test facility with the site description report on file and has met all the requirements specified in Section 2.948 of the FCC Rules and Industry Canada (11384A-1).
- MRT facility is an IC registered (11384A-1) test laboratory with the site description on file at Industry Canada.

1. INTRODUCTION

1.1. Scope

Measurement and determination of electromagnetic emissions (EMC) of radio frequency devices including intentional and/or unintentional radiators for compliance with the technical rules and regulations of the Federal Communications Commission and the Industry Canada Certification and Engineering Bureau.

1.2. MRT Test Location

The map below shows the location of the MRT LABORATORY, its proximity to the Taihu Lake. These measurement tests were conducted at the MRT Technology (Suzhou) Co., Ltd. Facility located at D8 Building, No.2 Tian'edang Rd., Wuzhong Economic Development Zone, Suzhou, China. The detailed description of the measurement facility was found to be in compliance with the requirements of § 2.948 according to ANSI C63.4-2009 on September 30, 2013.



2. PRODUCT INFORMATION

2.1. Equipment Description

Product Name	Smart Wristband
Model No.	IDO001, IDO002
Bluetooth (BLE)	
Bluetooth Frequency	2402~2480MHz
Bluetooth Version	V4.0
Type of modulation	FHSS
Data Rate	1Mbps(GFSK)
Antenna Type	Internal
Antenna Gain	1.46dBi

Channel List for BLE

Channel	Frequency	Channel	Frequency	Channel	Frequency
00	2402 MHz	01	2404 MHz	02	2406 MHz
03	2408 MHz	04	2410 MHz	05	2412 MHz
06	2414 MHz	07	2416 MHz	08	2418 MHz
09	2420 MHz	10	2422 MHz	11	2424 MHz
12	2426 MHz	13	2428 MHz	14	2430 MHz
15	2432 MHz	16	2434 MHz	17	2436 MHz
18	2438 MHz	19	2440 MHz	20	2442 MHz
21	2444 MHz	22	2446 MHz	23	2448 MHz
24	2450 MHz	25	2452 MHz	26	2454 MHz
27	2456 MHz	28	2458 MHz	29	2460 MHz
30	2462 MHz	31	2464 MHz	32	2466 MHz
33	2468 MHz	34	2470 MHz	35	2472 MHz
36	2474 MHz	37	2476 MHz	38	2478 MHz
39	2480 MHz	N/A	N/A	N/A	N/A

2.2. Device Capabilities

This device contains the following capabilities:

Bluetooth (BLE)

2.3. Test Configuration

The **Smart Wristband FCC ID: 2ADHUIDO001** was tested per the guidance of KDB 558074 D01v03r02. ANSI C63.10-2009 was used to reference the appropriate EUT setup for radiated spurious emissions testing and AC line conducted testing.

2.4. Description of Support Units

The EUT has been tested with associated equipment below:

Description	Manufacturer	Model No.
Adapter	Supply by MRT	HSU50600F

2.5. EMI Suppression Device(s)/Modifications

No EMI suppression device(s) were added and/or no modifications were made during testing.

2.6. Labeling Requirements

Per 2.1074 & 15.19; Docket 95-19

The label shall be permanently affixed at a conspicuous location on the device; instruction manual or pamphlet supplied to the user and be readily visible to the purchaser at the time of purchase.

However, when the device is so small wherein placement of the label with specified statement is not practical, only the trade name and FCC ID must be displayed on the device per Section 15.19(a)(5).

Please see attachment for FCC ID label and label location.

2.7. Test Software

The test utility software used during testing was engineering order by applicant.

3. DESCRIPTION OF TEST

3.1. Evaluation Procedure

The measurement procedures described in the American National Standard for Testing Unlicensed Wireless Devices (ANSI C63.10-2009), and the guidance provided in KDB 558074 D01v03r02 were used in the measurement of the **Smart Wristband FCC ID: 2ADHUIDO001**.

Deviation from measurement procedure.....None

3.2. AC Line Conducted Emissions

The line-conducted facility is located inside an 8'x4'x4' shielded enclosure. A 1m x 2m wooden table 80cm high is placed 40cm away from the vertical wall and 80cm away from the sidewall of the shielded room. Two 10kHz-30MHz, 50Ω/50uH Line-Impedance Stabilization Networks (LISNs) are bonded to the shielded room floor. Power to the LISNs is filtered by external high-current high-insertion loss power line filters. These filters attenuate ambient signal noise from entering the measurement lines. These filters are also bonded to the shielded enclosure.

The EUT is powered from one LISN and the support equipment is powered from the second LISN. All interconnecting cables more than 1 meter were shortened to a 1 meter length by non-inductive bundling (serpentine fashion) and draped over the back edge of the test table. All cables were at least 40cm above the horizontal reference ground-plane. Power cables for support equipment were routed down to the second LISN while ensuring that that cables were not draped over the second LISN.

Sufficient time for the EUT, support equipment, and test equipment was allowed in order for them to warm up to their normal operating condition. The RF output of the LISN was connected to the receiver and exploratory measurements were made to determine the frequencies producing the maximum emission from the EUT. The receiver was scanned from 150kHz to 30MHz. The detector function was set to peak mode for exploratory measurements while the bandwidth of the analyzer was set to 9kHz. The EUT, support equipment, and interconnecting cables were arranged and manipulated to maximize each emission. Each emission was also maximized by varying: power lines, the mode of operation or data exchange speed, or support equipment whichever determined the worst-case emission. Once the worst case emissions have been identified, the one EUT cable configuration/arrangement and mode of operation that produced these emissions were used for final measurements on the same test site. The analyzer is set to CISPR quasi-peak and average detectors with a 9kHz resolution bandwidth for final measurements.

An extension cord was used to connect to a single LISN which powered by EUT. The extension cord was calibrated with LISN, the impedance and insertion loss are compliance with the requirements as stated in ANSI C63.10-2009 at Clause 4.3.

Line conducted emissions test results are shown in Section 7.8.

3.3. Radiated Emissions

The radiated test facilities consisted of an indoor 3 meter semi-anechoic chamber used for final measurements and exploratory measurements, when necessary. The measurement area is contained within the semi-anechoic chamber which is shielded from any ambient interference. For measurements above 1GHz absorbers are arranged on the floor between the turn table and the antenna mast in such a way so as to maximize the reduction of reflections. For measurements below 1GHz, the absorbers are removed. A MF Model 210SS turntable is used for radiated measurement. It is a continuously rotatable, remote controlled, metallic turntable and 2 meters (6.56 ft.) in diameter. The turn table is flush with the raised floor of the chamber in order to maintain its function as a ground plane. An 80cm high PVC support structure is placed on top of the turntable.

For all measurements, the spectrum was scanned through all EUT azimuths and from 1 to 4 meter receive antenna height using a broadband antenna from 30MHz up to the upper frequency shown in 15.33(b)(1) depending on the highest frequency generated or used in the device or on which the device operates or tunes. For frequencies above 1GHz, linearly polarized double ridge horn antennas were used. For frequencies below 30MHz, a calibrated loop antenna was used. When exploratory measurements were necessary, they were performed at 1 meter test distance inside the semi-anechoic chamber using broadband antennas, broadband amplifiers, and spectrum analyzers to determine the frequencies and modes producing the maximum emissions. Sufficient time for the EUT, support equipment, and test equipment was allowed in order for them to warm up to their normal operating condition. The test set-up was placed on top of the 0.8 meter high, 1 x 1.5 meter table. The EUT, support equipment, and interconnecting cables were arranged and manipulated to maximize each emission. Appropriate precaution was taken to ensure that all emissions from the EUT were maximized and investigated. The system configuration, clock speed, mode of operation or video resolution, if applicable, turntable azimuth, and receive antenna height was noted for each frequency found.

Final measurements were made in the semi-anechoic chamber using calibrated, linearly polarized broadband and horn antennas. The test setup was configured to the setup that produced the worst case emissions. The spectrum analyzer was set to investigate all frequencies required for testing to compare the highest radiated disturbances with respect to the specified limits. The turntable containing the EUT was rotated through 360 degrees and the height of the receive antenna was varied 1 to 4 meters and stopped at the azimuth and height producing the maximum emission. Each emission was maximized by changing the orientation of the EUT through three orthogonal planes and changing the polarity of the receive antenna, whichever produced the worst-case emissions. According to 3dB BeamWidth of horn antenna, the horn antenna should be always directed to the EUT when rising height.

4. ANTENNA REQUIREMENTS

Excerpt from §15.203 of the FCC Rules/Regulations:

“An intentional radiator antenna shall be designed to ensure that no antenna other than that furnished by the responsible party can be used with the device. The use of a permanently attached antenna or of an antenna that uses a unique coupling to the intentional radiator shall be considered sufficient to comply with the provisions of this section.”

- The antenna of the Smart Wristband is **permanently attached**.
- There are no provisions for connection to an external antenna.

Conclusion:

The **Smart Wristband FCC ID: 2ADHUIDO001** unit complies with the requirement of §15.203.

5. TEST EQUIPMENT CALIBRATION DATE

Conducted Emissions

Instrument	Manufacturer	Type No.	Serial No.	Cali. Interval	Cali. Due Date
EMI Test Receiver	R&S	ESR7	101209	1 year	2014/11/08
Two-Line V-Network	R&S	ENV216	101683	1 year	2014/11/08
Two-Line V-Network	R&S	ENV216	101684	1 year	2014/11/08
Temperature/ Meter Humidity	Anymetre	TH101B	SR2-01	1 year	2014/11/15

Radiated Emission

Instrument	Manufacturer	Type No.	Serial No.	Cali. Interval	Cali. Due Date
Spectrum Analyzer	Agilent	N9010A	MY5144016A	1 year	2015/01/04
Preamplifier	MRT	AP01G18	1310002	1 year	2015/10/06
Loop Antenna	Schwarzbeck	FMZB1519	1519-041	1 year	2014/11/24
TRILOG Antenna	Schwarzbeck	VULB9162	9162-047	1 year	2014/11/24
Broad-Band Horn Antenna	Schwarzbeck	BBHA9120D	9120D-1167	1 year	2014/11/24
Broadband Horn Antenna	Schwarzbeck	BBHA9170	9170-549	1 year	2014/12/11
Temperature/Humidity Meter	Anymetre	TH101B	AC1-01	1 year	2014/11/15

Conducted Test Equipment

Instrument	Manufacturer	Type No.	Serial No.	Cali. Interval	Cali. Due Date
Spectrum Analyzer	Agilent	N9010A	MY5144016A	1 year	2015/01/04
Power Sensor	Agilent	U2021XA	MY52450003	1 year	2014/12/14
Temperature/Humidity Meter	Anymetre	TH101B	TR3-01	1 year	2014/11/15

6. MEASUREMENT UNCERTAINTY

Where relevant, the following test uncertainty levels have been estimated for tests performed on the EUT as specified in CISPR 16-4-2. This uncertainty represents an expanded uncertainty expressed at approximately the 95% confidence level using a coverage factor of $k = 2$.

AC Conducted Emission Measurement
Measuring Uncertainty for a Level of Confidence of 95% ($U=2Uc(y)$): 150kHz~30MHz: $\pm 3.46\text{dB}$
Radiated Emission Measurement
Measuring Uncertainty for a Level of Confidence of 95% ($U=2Uc(y)$): 9kHz ~ 1GHz: $\pm 4.18\text{dB}$ 1GHz ~ 25GHz: $\pm 4.76\text{dB}$

7. TEST RESULT

7.1. Summary

Company Name: Shenzhen IDO Intelligent Technology Co. Ltd
FCC ID: 2ADHUIDO001
FCC Classification: Digital Transmission System (DTS)
Data Rate(s) Tested: 1Mbps (GFSK)

FCC Part Section(s)	Test Description	Test Limit	Test Condition	Test Result	Reference
15.247(a)(2)	6dB Bandwidth	$\geq 500\text{kHz}$	Conducted	Pass	Section 7.2
15.247(b)(3)	Output Power	$\leq 1\text{Watt}$		Pass	Section 7.3
15.247(e)	Power Spectral Density	$\leq 8\text{dBm} / 3\text{kHz Band}$		Pass	Section 7.4
15.247(d)	Band Edge / Out-of-Band Emissions	$\geq 20\text{dBc(Peak)}$		Pass	Section 7.5
15.205 15.209	General Field Strength Limits (Restricted Bands and Radiated Emission Limits)	Emissions in restricted bands must meet the radiated limits detailed in 15.209	Radiated	Pass	Section 7.6 & 7.7
15.207	AC Conducted Emissions 150kHz - 30MHz	< FCC 15.207 limits	Line Conducted	Pass	Section 7.8

Notes:

- 1) All modes of operation and data rates were investigated. The test results shown in the following sections represent the worst case emissions.
- 2) The analyzer plots shown in this section were all taken with a correction table loaded into the analyzer. The correction table was used to account for the losses of the cables and attenuators used as part of the system to connect the EUT to the analyzer at all frequencies of interest.
- 3) All antenna port conducted emissions testing was performed on a test bench with the antenna port of the EUT connected to the spectrum analyzer through calibrated cables and attenuators.

7.2. 6dB Bandwidth Measurement

7.2.1. Test Limit

The minimum 6dB bandwidth shall be at least 500 kHz.

7.2.2. Test Procedure used

KDB 558074 D01v03r02 – Section 8.2 Option 2

7.2.3. Test Setting

1. The Spectrum's automatic bandwidth measurement capability was used to perform the 6dB bandwidth measurement. The "X" dB bandwidth parameter was set to $X = 6$. The bandwidth measurement was not influenced by any intermediate power nulls in the fundamental emission.
2. Set RBW = 100 kHz
3. VBW $\geq 3 \times$ RBW
4. Detector = Peak
5. Trace mode = max hold
6. Sweep = auto couple
7. Allow the trace was allowed to stabilize

7.2.4. Test Setup

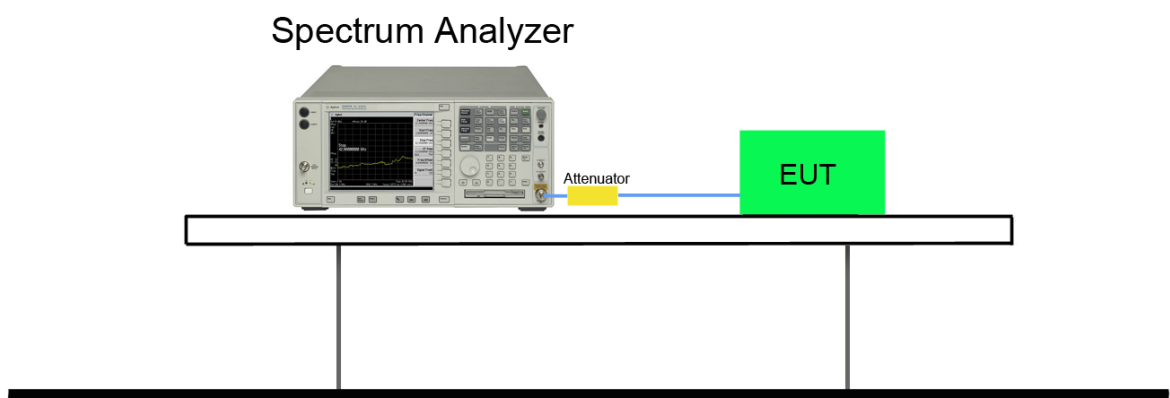

7.2.5. Test Result

Test Mode	Data Rate (Mbps)	Channel No.	Frequency (MHz)	6dB Bandwidth (MHz)	Limit (MHz)	Result
BLE	1	00	2402	0.7032	≥0.5	Pass
BLE	1	19	2440	0.7015	≥0.5	Pass
BLE	1	39	2480	0.7048	≥0.5	Pass

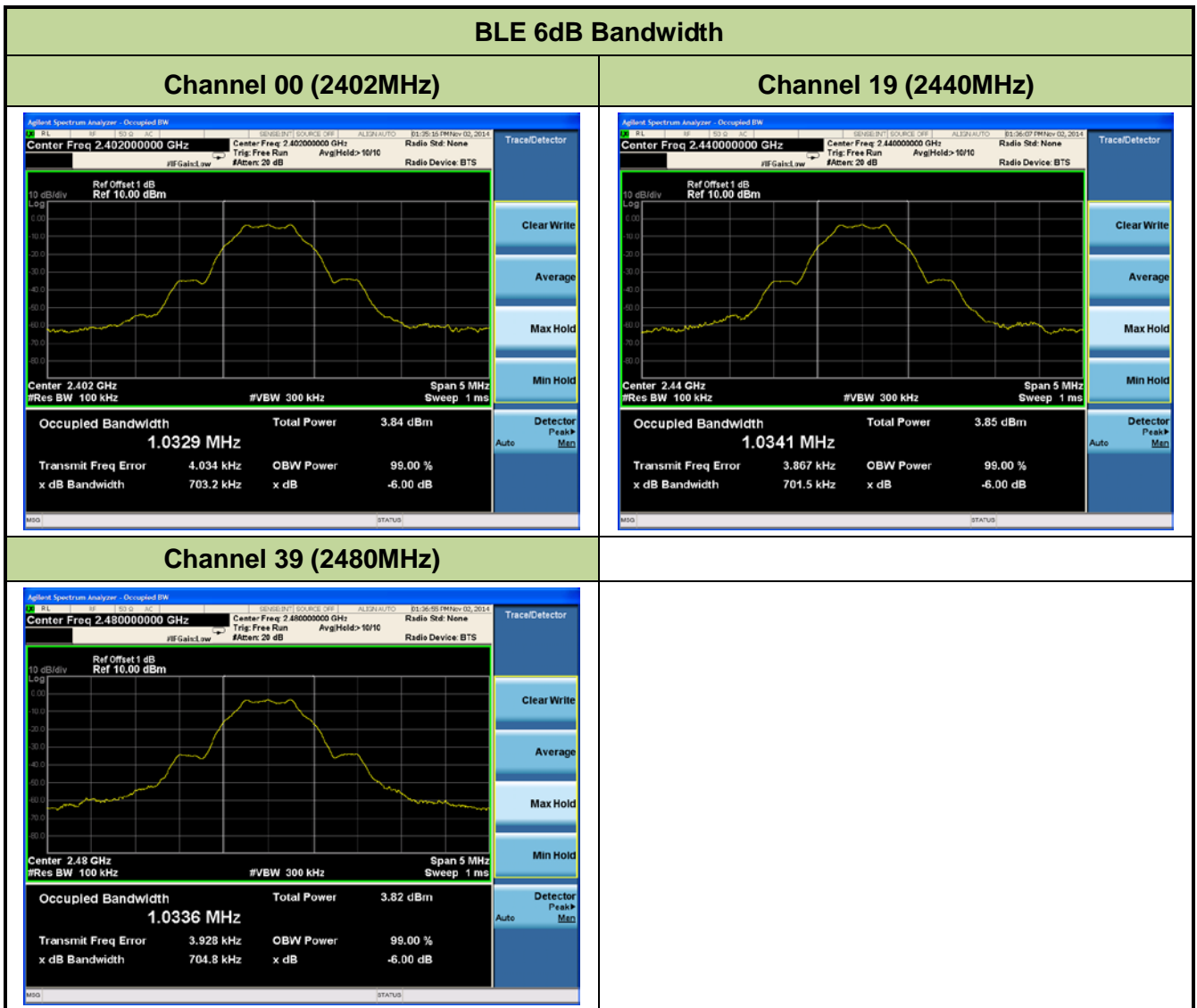

7.3. Output Power Measurement

7.3.1. Test Limit

The maximum out power shall be less 1 Watt (30dBm).

7.3.2. Test Procedure Used

KDB 558074 D01v03r02 - Section 9.1.2 PKPM1 Peak Power Method (for signals with BW \leq 50MHz)

7.3.3. Test Setting

Method PKPM1 (Peak Power Measurement of Signals with DTS BW \leq 50MHz)

Peak power measurements were performed only when the EUT was transmitting at its maximum power control level using a broadband power meter with a pulse sensor. The pulse sensor employs a VBW = 50MHz so this method was only used for signals whose DTS bandwidth was less than or equal to 50MHz.

7.3.4. Test Setup

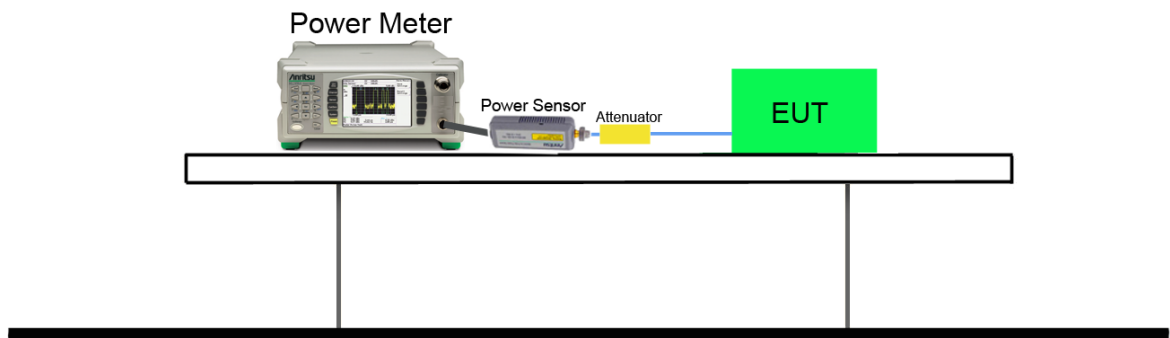

7.3.5. Test Result of Output Power

Test Result of Peak Output Power

Test Mode	Data Rate (Mbps)	Channel No.	Frequency (MHz)	Peak Power (dBm)	Limit (dBm)	Result
BLE	1	00	2402	0.51	≤ 30	Pass
BLE	1	19	2440	0.71	≤ 30	Pass
BLE	1	39	2480	1.18	≤ 30	Pass

7.4. Power Spectral Density Measurement

7.4.1. Test Limit

The maximum permissible power spectral density is 8 dBm in any 3 kHz band.

7.4.2. Test Procedure Used

KDB 558074 D01v03r02 - Section 10.2 Method PKPSD

7.4.3. Test Setting

1. Analyzer was set to the center frequency of the DTS channel under investigation
2. Span = 1.5 times the DTS channel bandwidth
3. RBW = 3kHz
4. VBW = 10kHz
5. Detector = peak
6. Sweep time = auto couple
7. Trace mode = max hold
8. Trace was allowed to stabilize

7.4.4. Test Setup

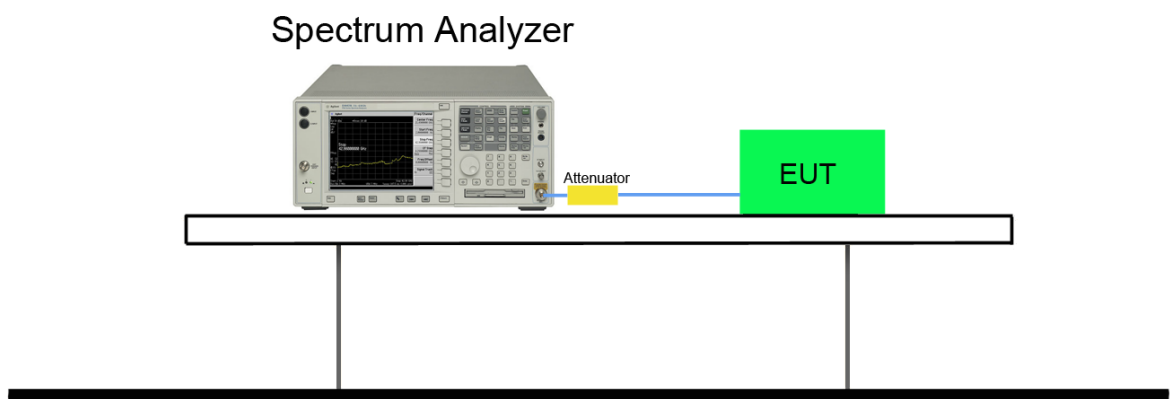

7.4.5. Test Result

Test Mode	Data Rate (Mbps)	Channel No.	Frequency (MHz)	PSD Result (dBm)	Limit (dBm / 3kHz)	Result
BLE	1	00	2402	-17.949	≤8	Pass
BLE	1	19	2440	-17.836	≤8	Pass
BLE	1	39	2480	-18.049	≤8	Pass

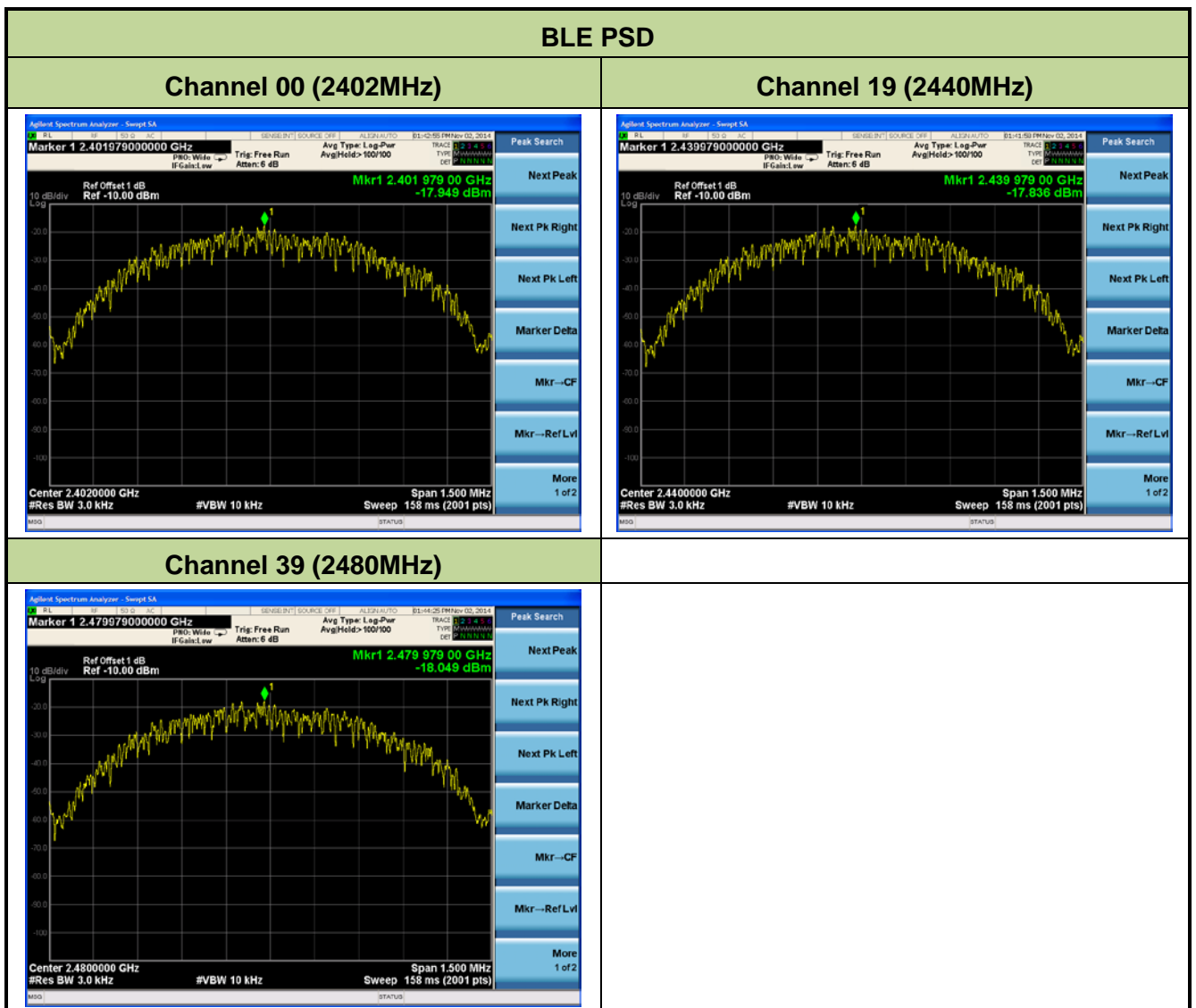

7.5. Conducted Band Edge and Out-of-Band Emissions

7.5.1. Test Limit

The limit for out-of-band spurious emissions at the band edge is 20dB below the fundamental emission level, as determined from the in-band power measurement of the DTS channel performed in a 100kHz bandwidth per the PSD procedure (Section 9.1).

7.5.2. Test Procedure Used

KDB 558074 D01v03r02 - Section 11.2 & Section 11.3

7.5.3. Test Setting

1. Reference level measurement

- (a) Set instrument center frequency to DTS channel center frequency
- (b) Set the span to ≥ 1.5 times the DTS bandwidth
- (c) Set the RBW = 100 kHz
- (d) Set the VBW $\geq 3 \times$ RBW
- (e) Detector = peak
- (f) Sweep time = auto couple
- (g) Trace mode = max hold
- (h) Allow trace to fully stabilize

2. Emission level measurement

- (a) Set the center frequency and span to encompass frequency range to be measured
- (b) RBW = 100kHz
- (c) VBW = 300kHz
- (d) Detector = Peak
- (e) Number of sweep points $\geq 2 \times$ Span/RBW
- (f) Trace mode = max hold
- (g) Sweep time = auto couple

(h) The trace was allowed to stabilize

7.5.4. Test Setup

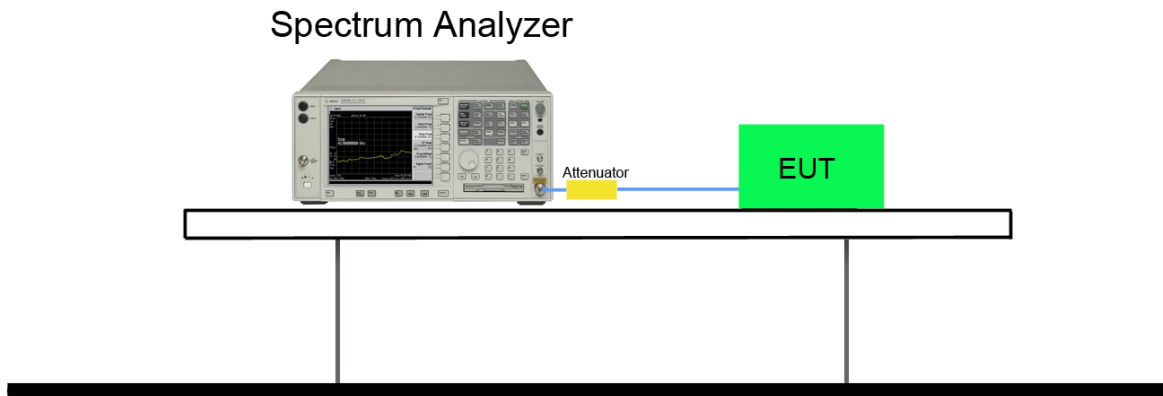

7.5.5. Test Result

Test Mode	Data Rate (Mbps)	Channel No.	Frequency (MHz)	Limit	Result
BLE	1	00	2402	20dBc	Pass
BLE	1	19	2440	20dBc	Pass
BLE	1	39	2480	20dBc	Pass

BLE Out-of-Band Emissions

Channel 00 (2402MHz)

100kHz PSD reference Level

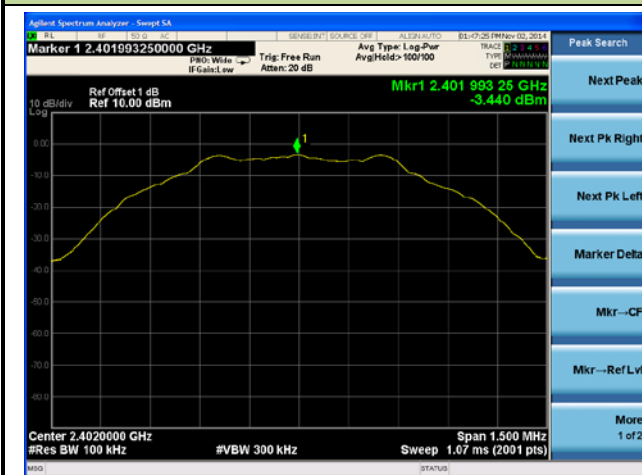

Low Band Edge

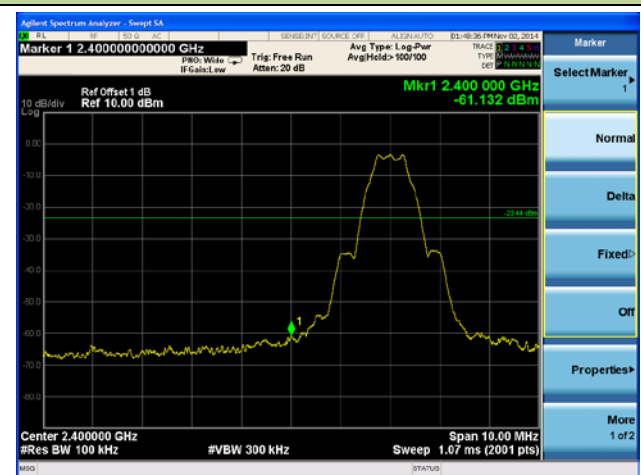

Spurious Emission 30MHz ~ 25GHz

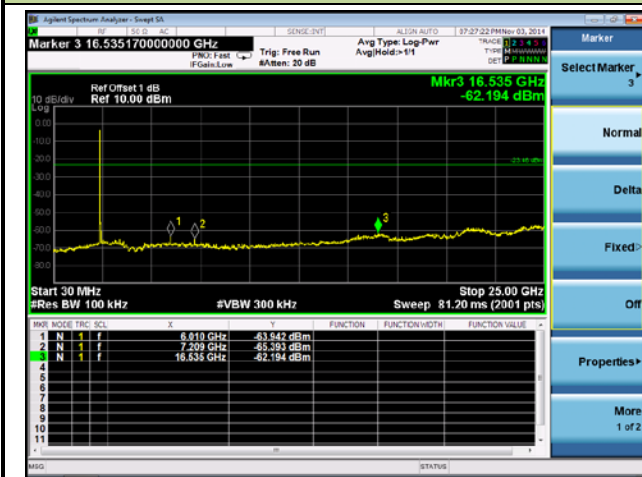

Channel 19 (2440MHz)

100kHz PSD reference Level

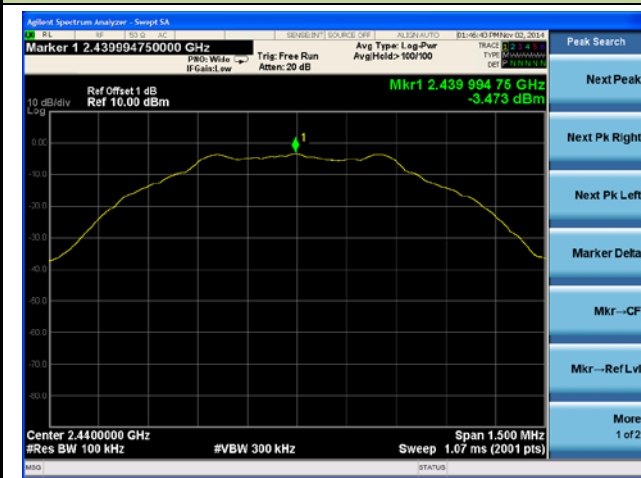

Spurious Emission 30MHz ~ 25GHz

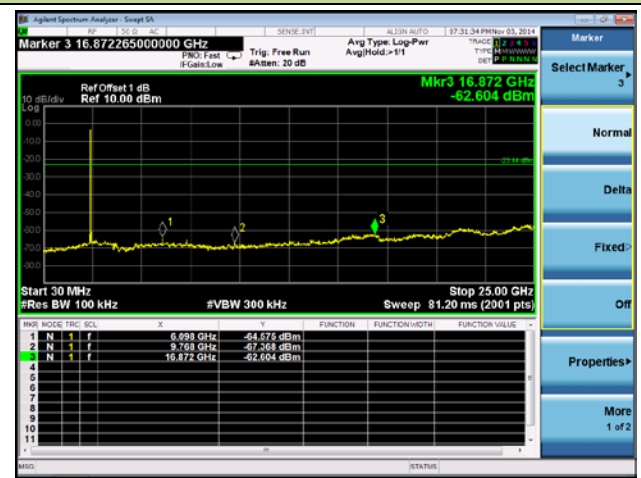

Channel 39 (2480MHz)

100kHz PSD reference Level

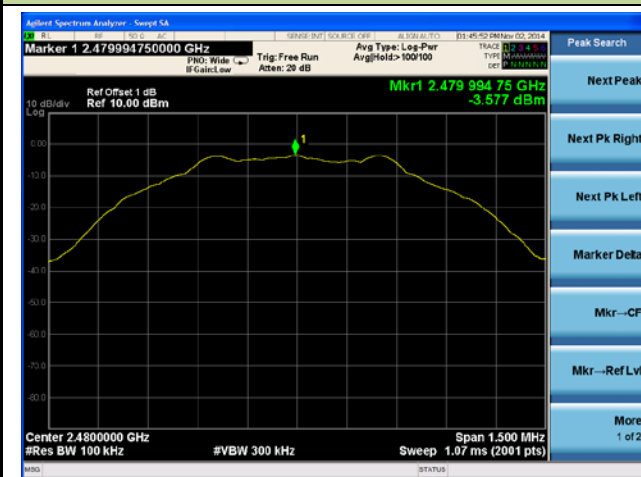

High Band Edge

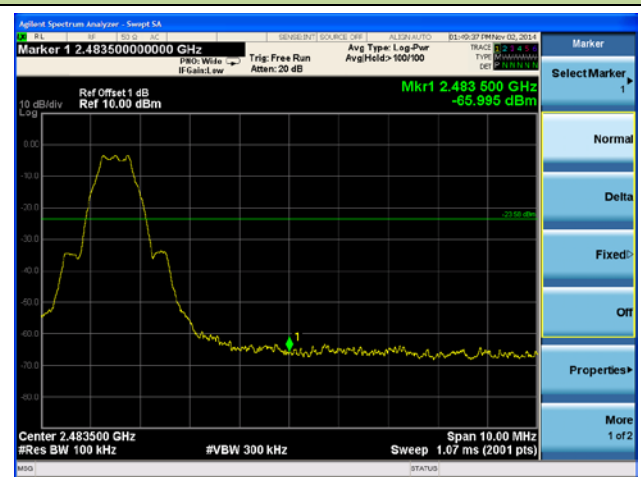

Spurious Emission 30MHz ~ 25GHz

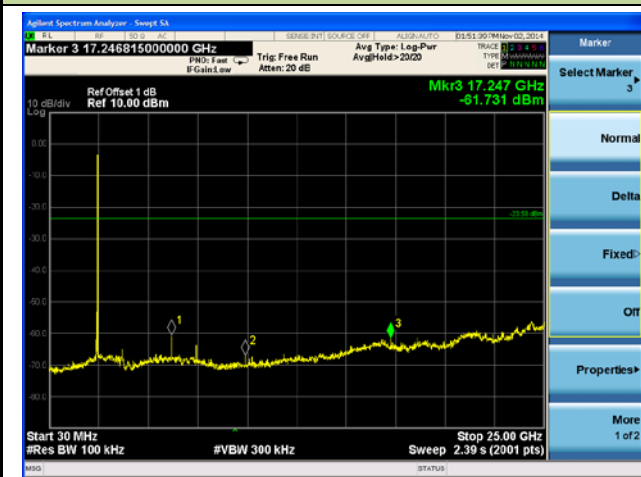

7.6. Radiated Spurious Emission Measurement

7.6.1. Test Limit

All out of band emissions appearing in a restricted band as specified in Section 15.205 of the Title 47 CFR must not exceed the limits shown in Table per Section 15.209.

FCC Part 15 Subpart C Paragraph 15.209		
Frequency [MHz]	Field Strength [V/m]	Measured Distance [Meters]
0.009 – 0.490	2400/F (kHz)	300
0.490 – 1.705	24000/F (kHz)	30
1.705 - 30	30	30
30 - 88	100	3
88 - 216	150	3
216 - 960	200	3
Above 960	500	3

7.6.2. Test Procedure Used

KDB 558074 D01v03r02 – Section 12.2.3 (quasi-peak measurements)

KDB 558074 D01v03r02 – Section 12.2.4 (peak power measurements)

KDB 558074 D01v03r02 – Section 12.2.5 (average power measurements)

7.6.3. Test Setting

Peak Field Strength Measurements per Section 12.2.4 of KDB 558074 D01v03r02

1. Analyzer center frequency was set to the frequency of the radiated spurious emission of interest
2. RBW = as specified in Table 1
3. VBW = 3MHz
4. Detector = peak
5. Sweep time = auto couple

6. Trace mode = max hold
7. Trace was allowed to stabilize

Table 1—RBW as a function of frequency

Frequency	RBW
9 ~ 150 kHz	200 ~ 300 Hz
0.15 ~ 30 MHz	9 ~ 10 kHz
30 ~ 1000 MHz	100 ~ 120 kHz
> 1000 MHz	1 MHz

Average Field Strength Measurements per Section 12.2.5.1 of KDB 558074 D01v03r02

1. Analyzer center frequency was set to the frequency of the radiated spurious emission of interest
2. RBW = 1MHz
3. VBW \geq 1/T
4. De As an alternative, the instrument may be set to linear detector mode. Ensure that video filtering is applied in linear voltage domain (rather than in a log or dB domain). Some instruments require linear display mode in order to accomplish this. Others have a setting for Average-VBW Type, which can be set to “Voltage” regardless of the display mode
5. Detector = Peak
6. Sweep time = auto
7. Trace mode = max hold
8. Allow max hold to run for at least 50 times (1/duty cycle) traces

7.6.4. Test Setup

9kHz ~ 30MHz Test Setup:

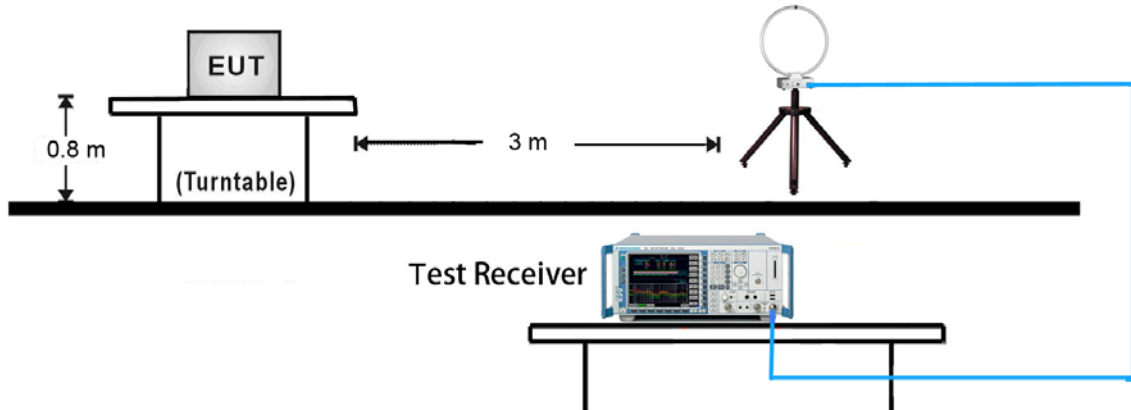

30MHz ~ 1GHz Test Setup:

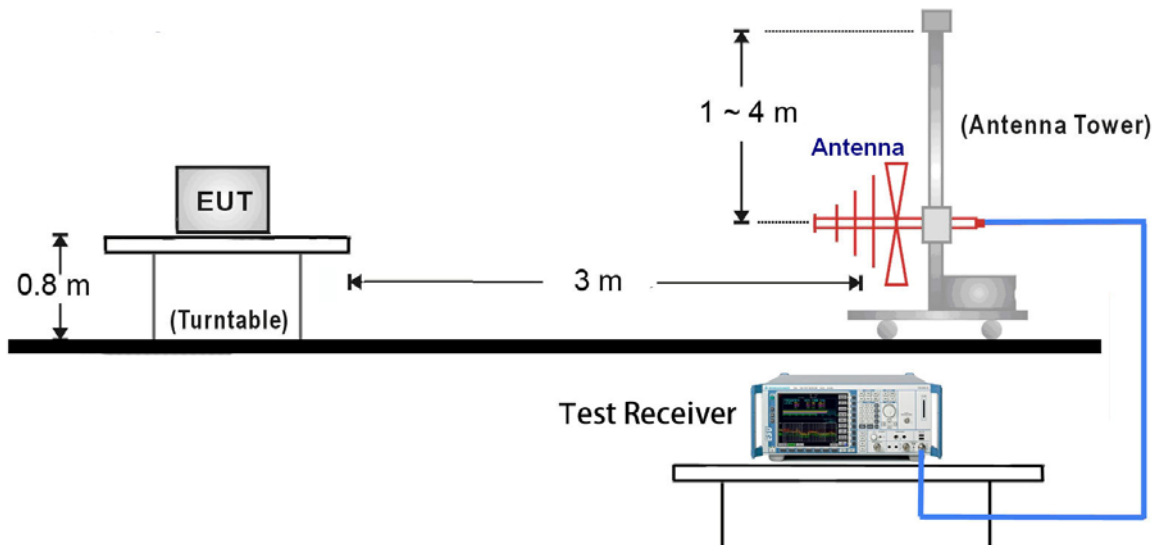

1GHz ~ 25GHz Test Setup:

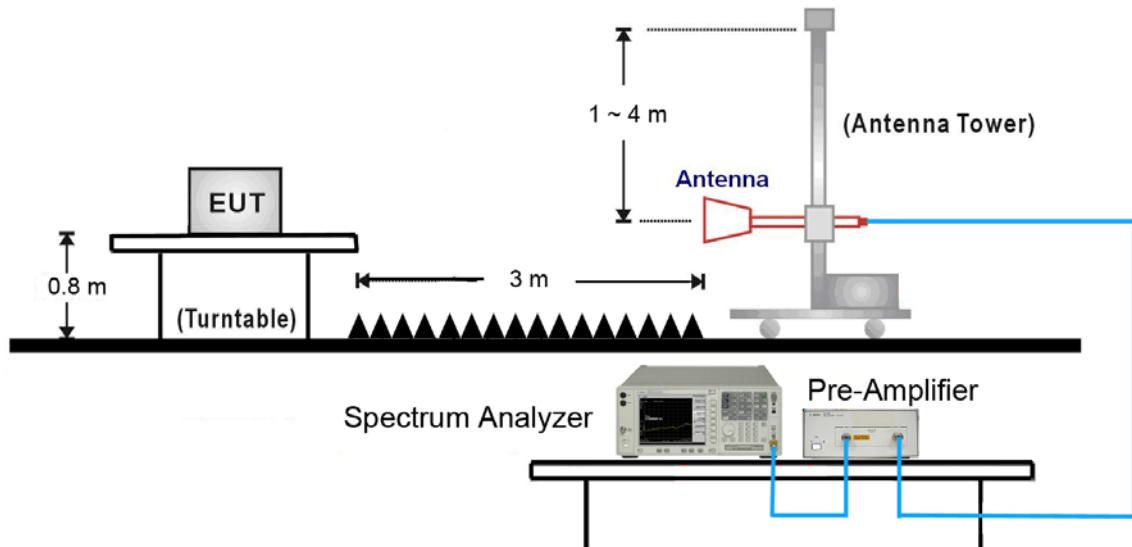

7.6.5. Test Result

Test Mode:	BLE	Test Site:	AC1
Test Channel:	00	Test Engineer:	Milo Li
Remark:	1. Average measurement was not performed if peak level lower than average limit. 2. The worst case of Radiated Spurious Emission. 3. Other frequency was 20dB below limit line within 1-18GHz, there is not show in the report.		

Mark	Frequency (MHz)	Reading Level (dBμV)	Factor (dB)	Measure Level (dBμV/m)	Limit (dBμV/m)	Margin (dB)	Detector	Polarization
*	3533.0	37.2	4.0	41.2	59	-17.8	Peak	Horizontal
*	4442.5	36.6	5.5	42.1	59	-16.9	Peak	Horizontal
	4804.0	37.1	6.4	43.5	74	-30.5	Peak	Horizontal
	7366.5	35.4	14.0	49.4	74	-24.6	Peak	Horizontal
*	3473.5	37.4	3.7	41.1	59	-17.9	Peak	Vertical
*	4459.5	37.4	5.5	42.9	59	-16.1	Peak	Vertical
	4804.0	37.6	6.4	44.0	74	-30.0	Peak	Vertical
	7502.5	35.9	14.5	50.4	74	-23.6	Peak	Vertical

Note 1: "*" is not in restricted band, its limit is 20dBc of the fundamental emission level (79.0dBμV/m).

Note 2: Measure Level (dBμV/m) = Reading Level (dBμV) + Factor (dB)

Factor (dB) = Cable Loss (dB) + Antenna Factor (dB/m) - Pre_Amplifier Gain (dB)

The worst case of Radiated Emission below 1GHz:

Engineer: Milo Li	
Site: AC1	Time: 2014/11/03 - 11:06
Limit: FCC_Part15.209_RE(3m)	Margin: 0
Probe: VULB9162_0.03-8GHz	Polarity: Horizontal
EUT: Smart Wristband	Power: By Battery
Worst Case Mode:: Transmit by BLE at channel 2402MHz	

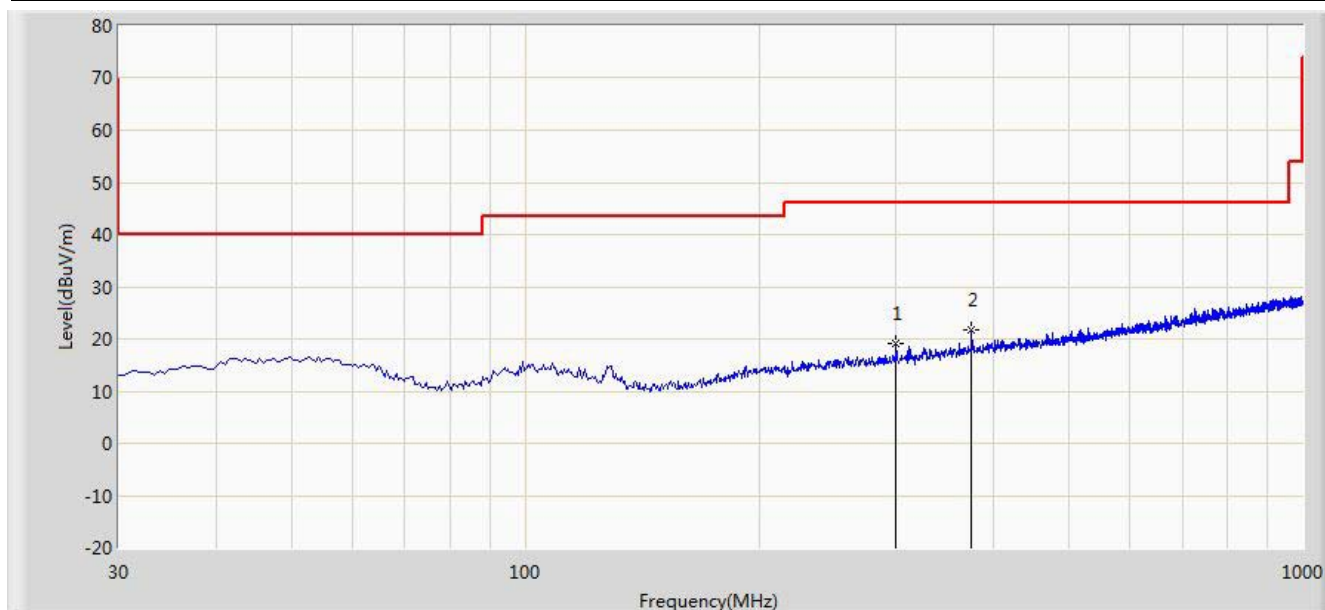

No	Flag	Mark	Frequency (MHz)	Measure Level (dBuV/m)	Reading Level (dBuV)	Over Limit (dB)	Limit (dBuV/m)	Factor	Type
1			300.145	18.998	4.870	-27.002	46.000	14.128	QP
2		*	375.320	21.609	5.873	-24.391	46.000	15.736	QP

Note: Measure Level (dB μ V/m) = Reading Level (dB μ V) + Factor (dB)

Factor (dB) = Cable Loss (dB) + Antenna Factor (dB/m)

Engineer: Milo Li	
Site: AC1	Time: 2014/11/03 - 11:09
Limit: FCC_Part15.209_RE(3m)	Margin: 0
Probe: VULB9162_0.03-8GHz	Polarity: Vertical
EUT: Smart Wristband	Power: By Battery
Worst Case Mode:: Transmit by BLE at channel 2402MHz	

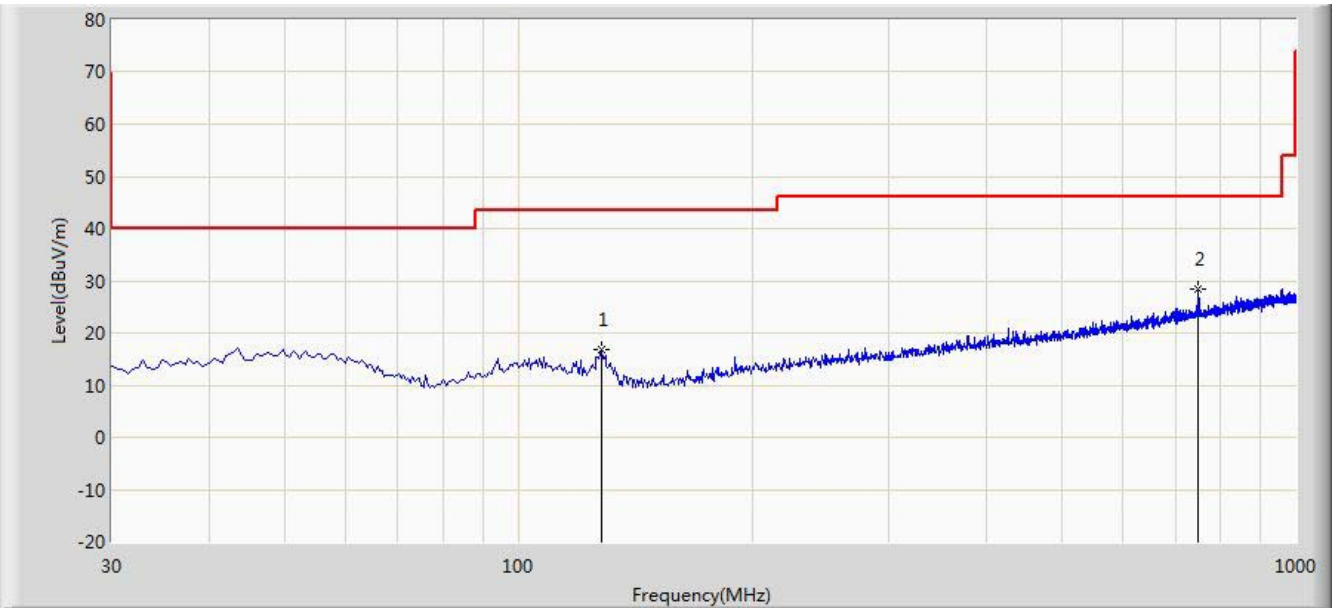

No	Flag	Mark	Frequency (MHz)	Measure Level (dBuV/m)	Reading Level (dBuV)	Over Limit (dB)	Limit (dBuV/m)	Factor	Type
1			127.970	16.789	6.820	-26.711	43.500	9.969	QP
2		*	750.225	28.262	6.729	-17.738	46.000	21.532	QP

Note: Measure Level (dBμV/m) = Reading Level (dBμV) + Factor (dB)

Factor (dB) = Cable Loss (dB) + Antenna Factor (dB/m)

Engineer: Roy Cheng	
Site: AC1	Time: 2014/11/03 - 16:39
Limit: FCC_Part15.209_RE(3m)	Margin: 0
Probe: FMZB1519_0.009-30MHz	Polarity: Face On
EUT: Smart Wristband	Power: By Battery
Note: There is the ambient noise within frequency range 9kHz~30MHz.	

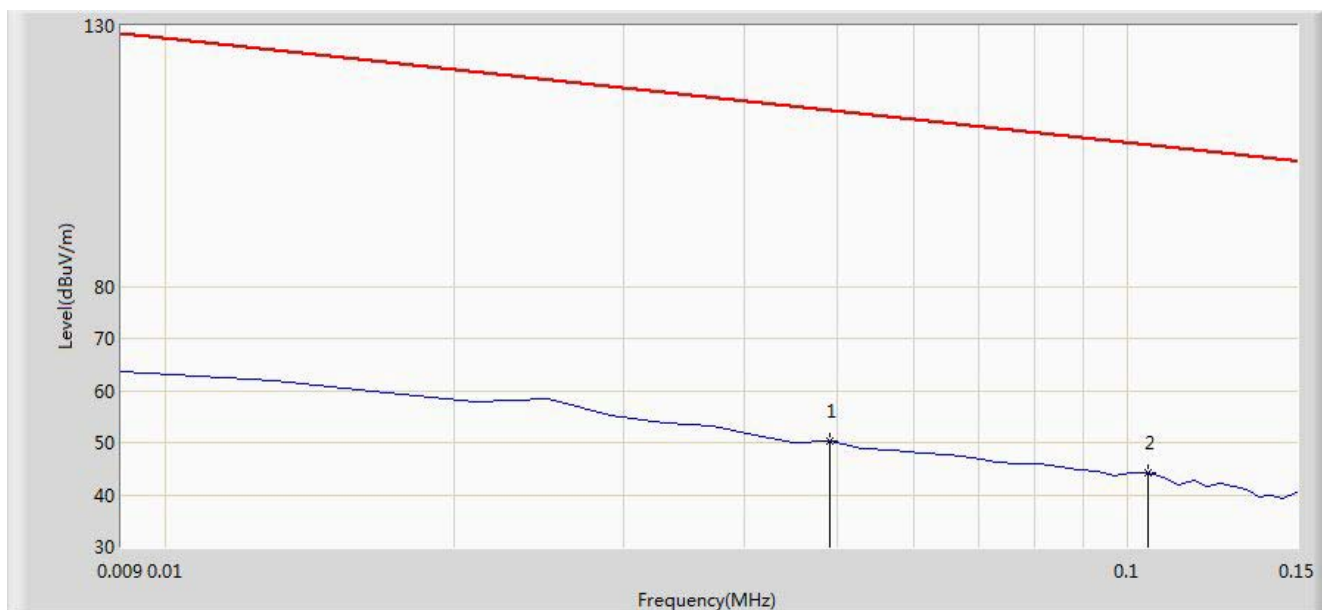

No	Flag	Mark	Frequency (MHz)	Measure Level (dBuV/m)	Reading Level (dBuV)	Over Limit (dB)	Limit (dBuV/m)	Factor (dB)	Type
1			0.049	50.367	29.861	-63.422	113.789	20.505	QP
2		*	0.105	44.143	23.996	-63.029	107.173	20.147	QP

Note: Measure Level (dB μ V/m) = Reading Level (dB μ V) + Factor (dB)

Factor (dB) = Cable Loss (dB) + Antenna Factor (dB/m)

Engineer: Roy Cheng	
Site: AC1	Time: 2014/11/03 - 16:41
Limit: FCC_Part15.209_RE(3m)	Margin: 0
Probe: FMZB1519_0.009-30MHz	Polarity: Face On
EUT: Smart Wristband	Power: By Battery
Note: There is the ambient noise within frequency range 9kHz~30MHz.	

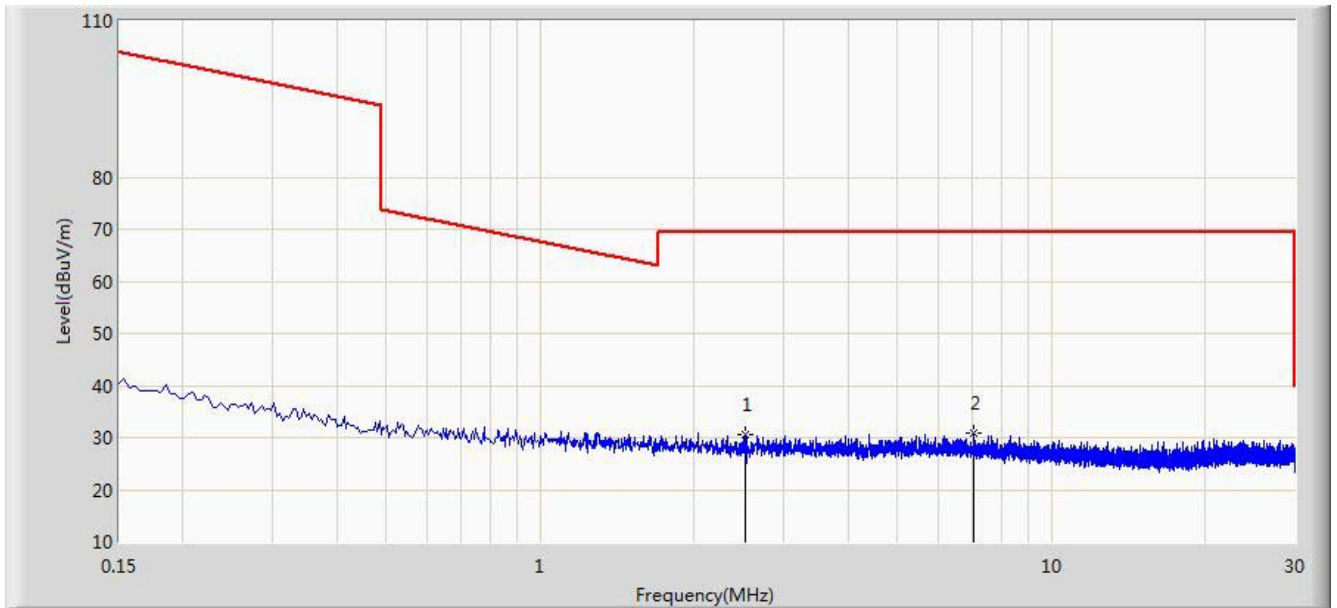

No	Flag	Mark	Frequency (MHz)	Measure Level (dBuV/m)	Reading Level (dBuV)	Over Limit (dB)	Limit (dBuV/m)	Factor (dB)	Type
1			2.513	30.495	10.336	-39.005	69.500	20.159	QP
2		*	7.041	30.974	10.579	-38.526	69.500	20.395	QP

Note: Measure Level (dBμV/m) = Reading Level (dBμV) + Factor (dB)

Factor (dB) = Cable Loss (dB) + Antenna Factor (dB/m)

Engineer: Roy Cheng	
Site: AC1	Time: 2014/11/03 - 17:39
Limit: FCC_Part15.209_RE(3m)	Margin: 0
Probe: BBHA9170_18-40GHz	Polarity: Horizontal
EUT: Smart Wristband	Power: By Battery
Note: There is the ambient noise within frequency range 18 ~ 25GHz.	

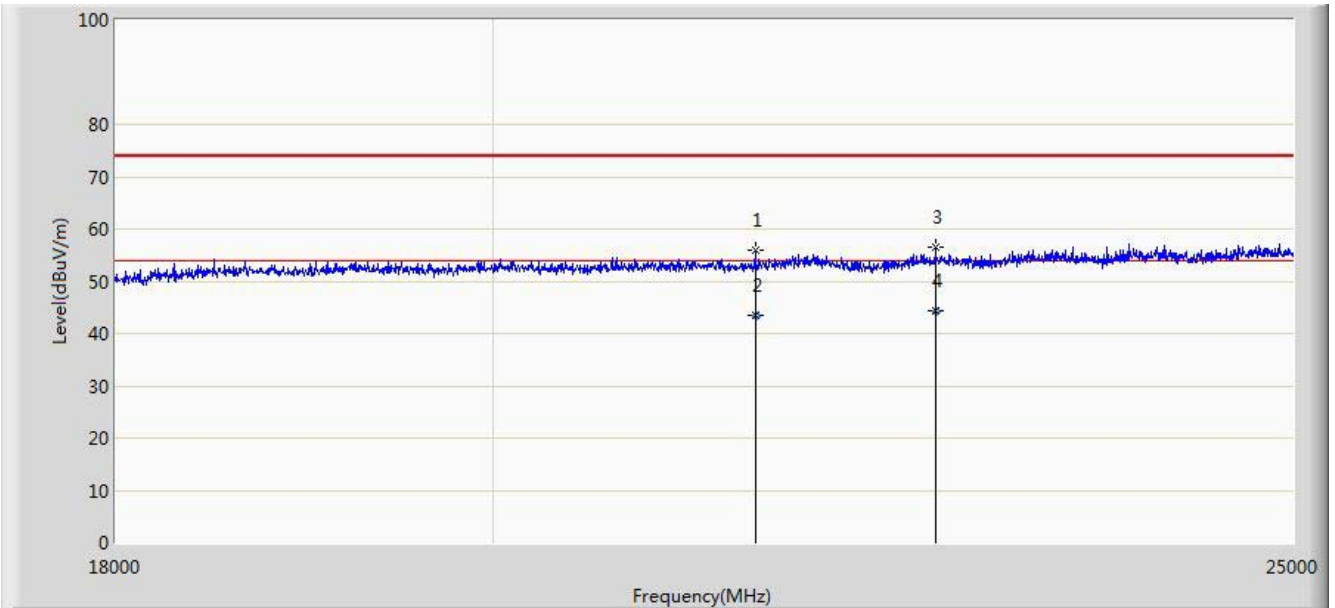

No	Flag	Mark	Frequency (MHz)	Measure Level (dBuV/m)	Reading Level (dBuV)	Over Limit (dB)	Limit (dBuV/m)	Factor (dB)	Type
1			21517.500	55.869	17.883	-18.131	74.000	37.986	PK
2			21517.650	43.351	5.365	-10.649	54.000	37.986	AV
3			22630.500	56.509	18.223	-17.491	74.000	38.286	PK
4		*	22630.540	44.310	6.024	-9.690	54.000	38.286	AV

Note: Measure Level (dBuV/m) = Reading Level (dBuV) + Factor (dB)

Factor (dB) = Cable Loss (dB) + Antenna Factor (dB/m)

Engineer: Roy Cheng	
Site: AC1	Time: 2014/11/03 - 17:43
Limit: FCC_Part15.209_RE(3m)	Margin: 0
Probe: BBHA9170_18-40GHz	Polarity: Vertical
EUT: Smart Wristband	Power: By Battery
Note: There is the ambient noise within frequency range 18 ~ 25GHz.	

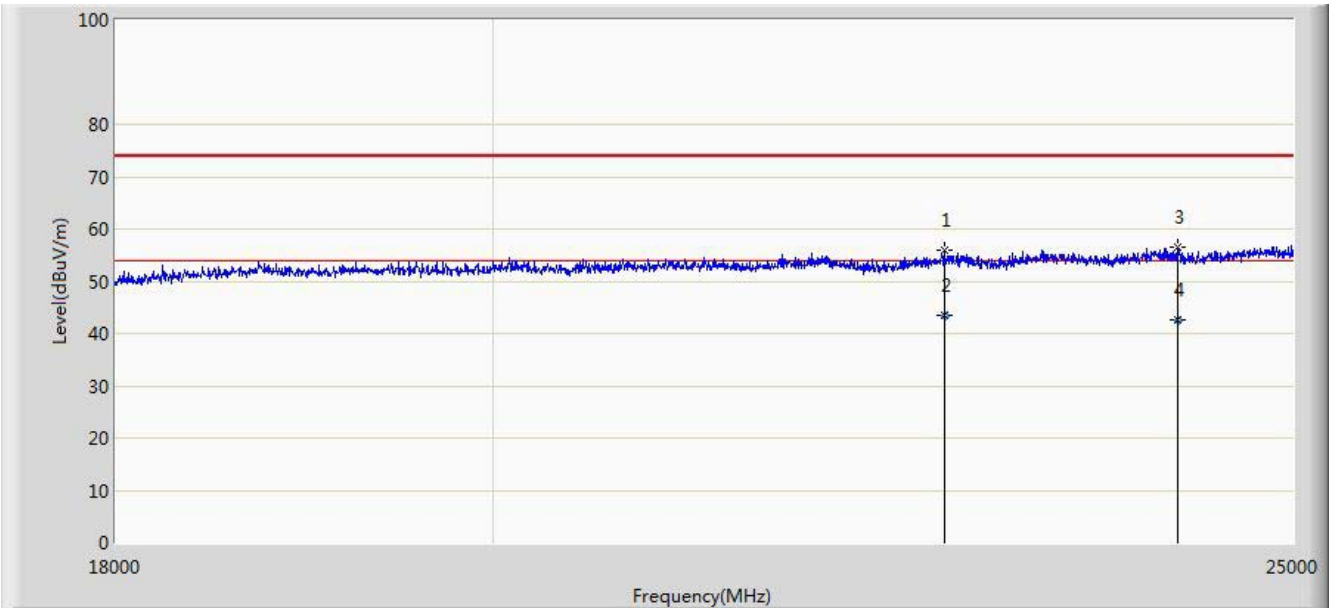

No	Flag	Mark	Frequency (MHz)	Measure Level (dBuV/m)	Reading Level (dBuV)	Over Limit (dB)	Limit (dBuV/m)	Factor (dB)	Type
1			22686.500	55.811	17.457	-18.189	74.000	38.354	PK
2		*	22686.540	43.598	5.244	-10.402	54.000	38.354	AV
3			24205.500	56.430	17.607	-17.570	74.000	38.823	PK
4			24205.658	42.518	3.695	-11.482	54.000	38.823	AV

Note: Measure Level (dB μ V/m) = Reading Level (dB μ V) + Factor (dB)

Factor (dB) = Cable Loss (dB) + Antenna Factor (dB/m)

7.7. Radiated Restricted Band Edge Measurement

7.7.1. Test Result

Engineer: Milo Li	
Site: AC1	Time: 2014/11/03 - 17:37
Limit: FCC_Part15.209_RE(3m)	Margin: 0
Probe: BBHA9120D_1-18GHz	Polarity: Horizontal
EUT: Smart Wristband	Power: By Battery
Test Mode: BLE at channel 2402MHz	

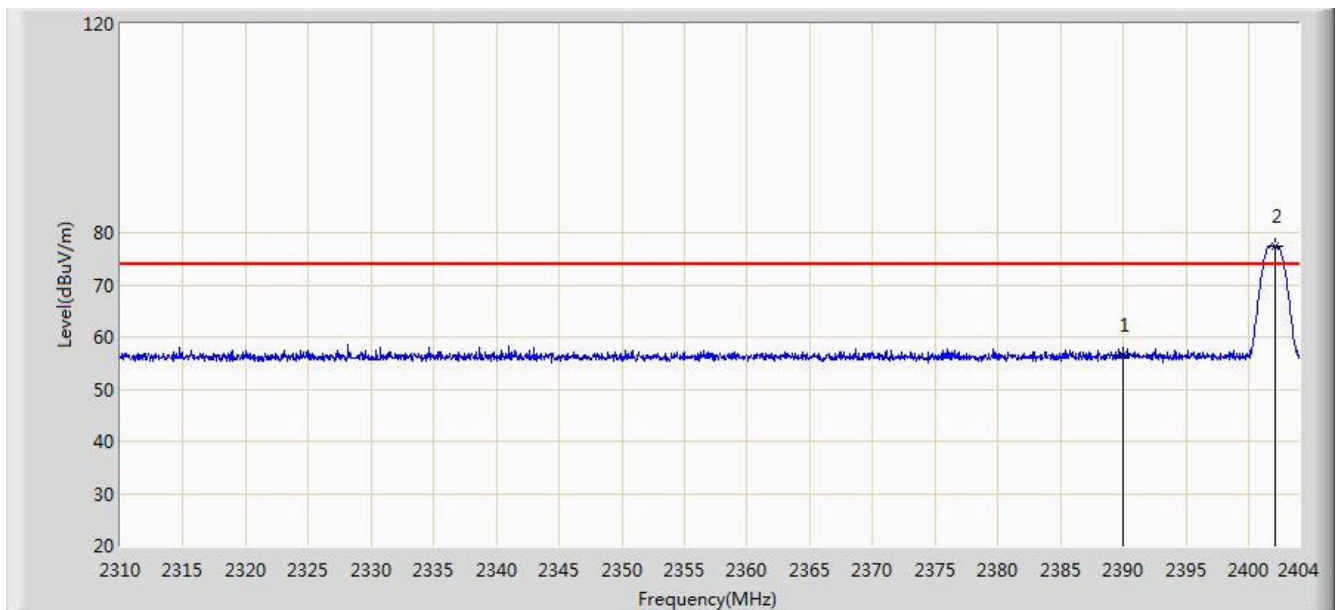

No	Flag	Mark	Frequency (MHz)	Measure Level (dBuV/m)	Reading Level (dBuV)	Over Limit (dB)	Limit (dBuV/m)	Factor (dB)	Type
1			2390.000	56.430	25.746	-17.570	74.000	30.684	PK
2		*	2402.073	77.337	46.676	N/A	N/A	30.661	PK

Note: Measure Level (dB μ V/m) = Reading Level (dB μ V) + Factor (dB)

Factor (dB) = Cable Loss (dB) + Antenna Factor (dB/m)

Engineer: Milo Li	
Site: AC1	Time: 2014/11/03 - 17:39
Limit: FCC_Part15.209_RE(3m)	Margin: 0
Probe: BBHA9120D_1-18GHz	Polarity: Horizontal
EUT: Smart Wristband	Power: By Battery
Test Mode: BLE at channel 2402MHz	

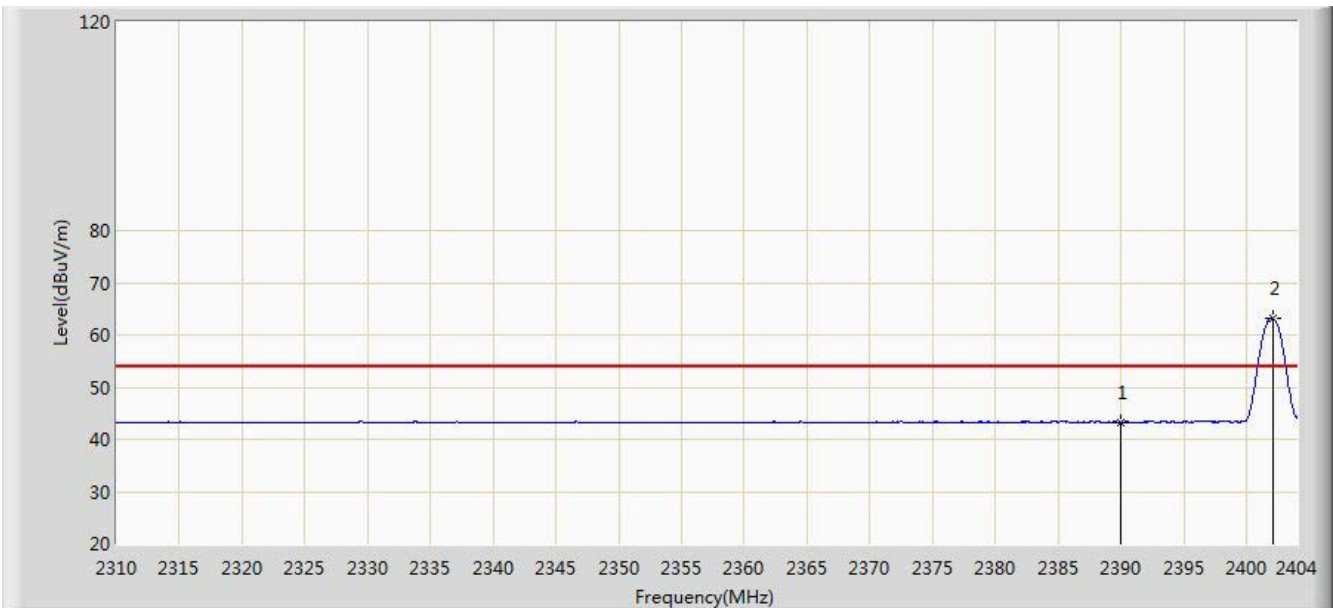

No	Flag	Mark	Frequency (MHz)	Measure Level (dBuV/m)	Reading Level (dBuV)	Over Limit (dB)	Limit (dBuV/m)	Factor (dB)	Type
1			2390.000	43.285	12.601	-10.715	54.000	30.684	AV
2		*	2402.073	63.253	32.592	N/A	N/A	30.661	AV

Note: Measure Level (dBμV/m) = Reading Level (dBμV) + Factor (dB)

Factor (dB) = Cable Loss (dB) + Antenna Factor (dB/m)

Engineer: Milo Li	
Site: AC1	Time: 2014/11/03 - 17:40
Limit: FCC_Part15.209_RE(3m)	Margin: 0
Probe: BBHA9120D_1-18GHz	Polarity: Vertical
EUT: Smart Wristband	Power: By Battery
Test Mode: BLE at channel 2402MHz	

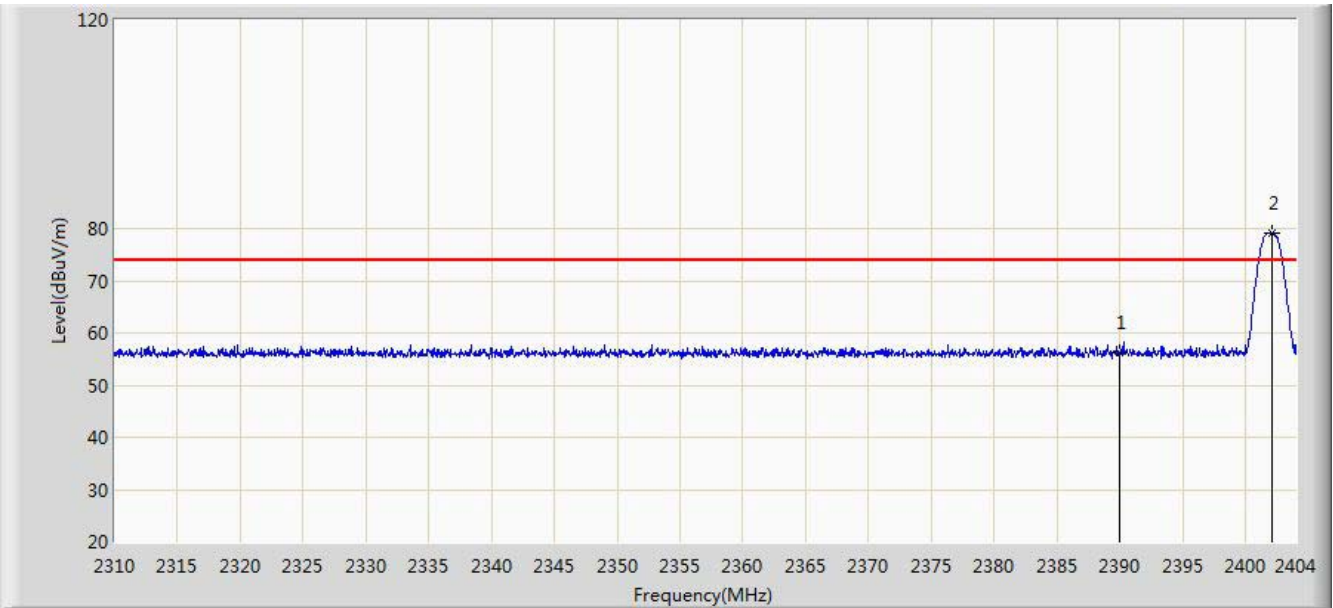

No	Flag	Mark	Frequency (MHz)	Measure Level (dBuV/m)	Reading Level (dBuV)	Over Limit (dB)	Limit (dBuV/m)	Factor (dB)	Type
1			2390.000	56.205	25.521	-17.795	74.000	30.684	PK
2		*	2402.073	79.010	48.349	N/A	N/A	30.661	PK

Note: Measure Level (dBμV/m) = Reading Level (dBμV) + Factor (dB)

Factor (dB) = Cable Loss (dB) + Antenna Factor (dB/m)

Engineer: Milo Li	
Site: AC1	Time: 2014/11/03 - 17:41
Limit: FCC_Part15.209_RE(3m)	Margin: 0
Probe: BBHA9120D_1-18GHz	Polarity: Vertical
EUT: Smart Wristband	Power: By Battery
Test Mode: BLE at channel 2402MHz	

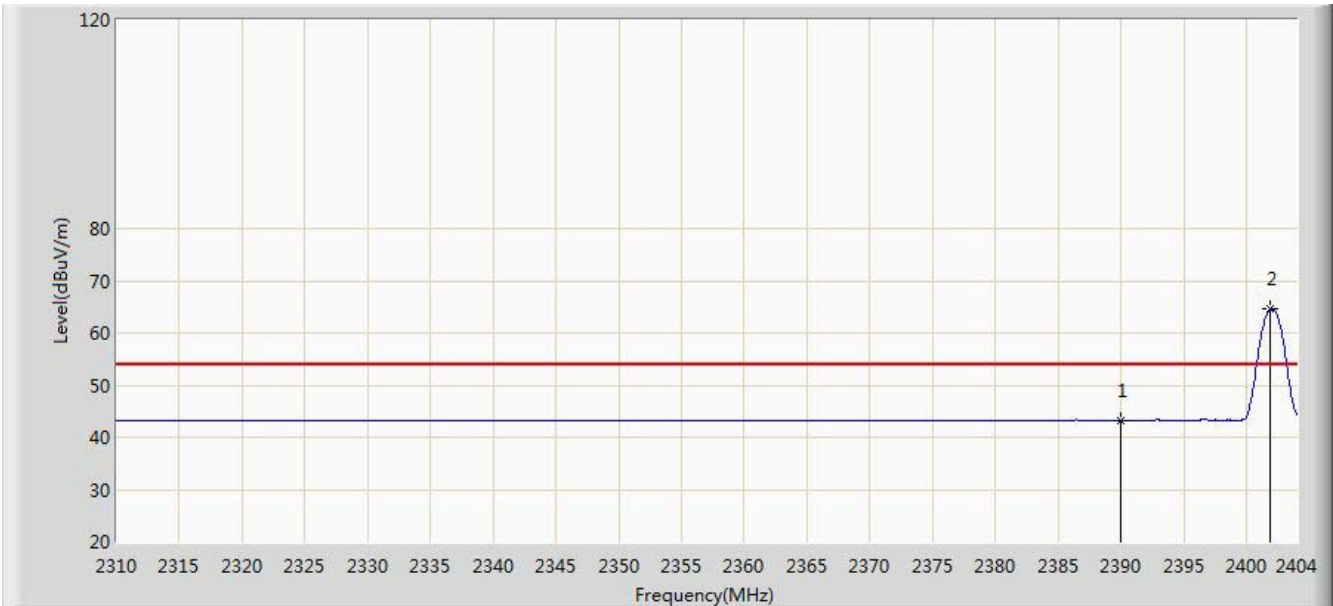

No	Flag	Mark	Frequency (MHz)	Measure Level (dBuV/m)	Reading Level (dBuV)	Over Limit (dB)	Limit (dBuV/m)	Factor (dB)	Type
1			2390.000	43.281	12.597	-10.719	54.000	30.684	AV
2		*	2401.932	64.579	33.918	N/A	N/A	30.662	AV

Note: Measure Level (dBμV/m) = Reading Level (dBμV) + Factor (dB)

Factor (dB) = Cable Loss (dB) + Antenna Factor (dB/m)

Engineer: Milo Li	
Site: AC1	Time: 2014/11/03 - 17:42
Limit: FCC_Part15.209_RE(3m)	Margin: 0
Probe: BBHA9120D_1-18GHz	Polarity: Horizontal
EUT: Smart Wristband	Power: By Battery
Test Mode: BLE at channel 2480MHz	

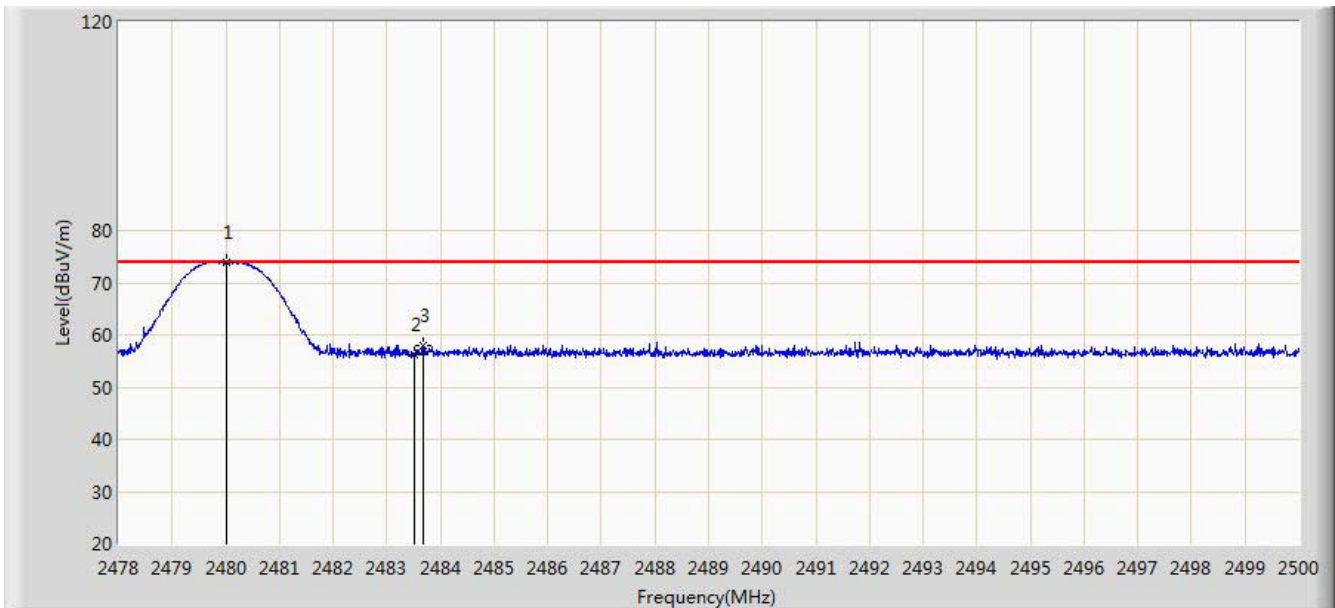

No	Flag	Mark	Frequency (MHz)	Measure Level (dBuV/m)	Reading Level (dBuV)	Over Limit (dB)	Limit (dBuV/m)	Factor (dB)	Type
1		*	2480.024	73.933	43.271	N/A	N/A	30.662	PK
2			2483.500	56.252	25.579	-17.748	74.000	30.673	PK
3			2483.676	57.874	27.201	-16.126	74.000	30.673	PK

Note: Measure Level (dB μ V/m) = Reading Level (dB μ V) + Factor (dB)

Factor (dB) = Cable Loss (dB) + Antenna Factor (dB/m)

Engineer: Milo Li	
Site: AC1	Time: 2014/11/03 - 17:45
Limit: FCC_Part15.209_RE(3m)	Margin: 0
Probe: BBHA9120D_1-18GHz	Polarity: Horizontal
EUT: Smart Wristband	Power: By Battery
Test Mode: BLE at channel 2480MHz	

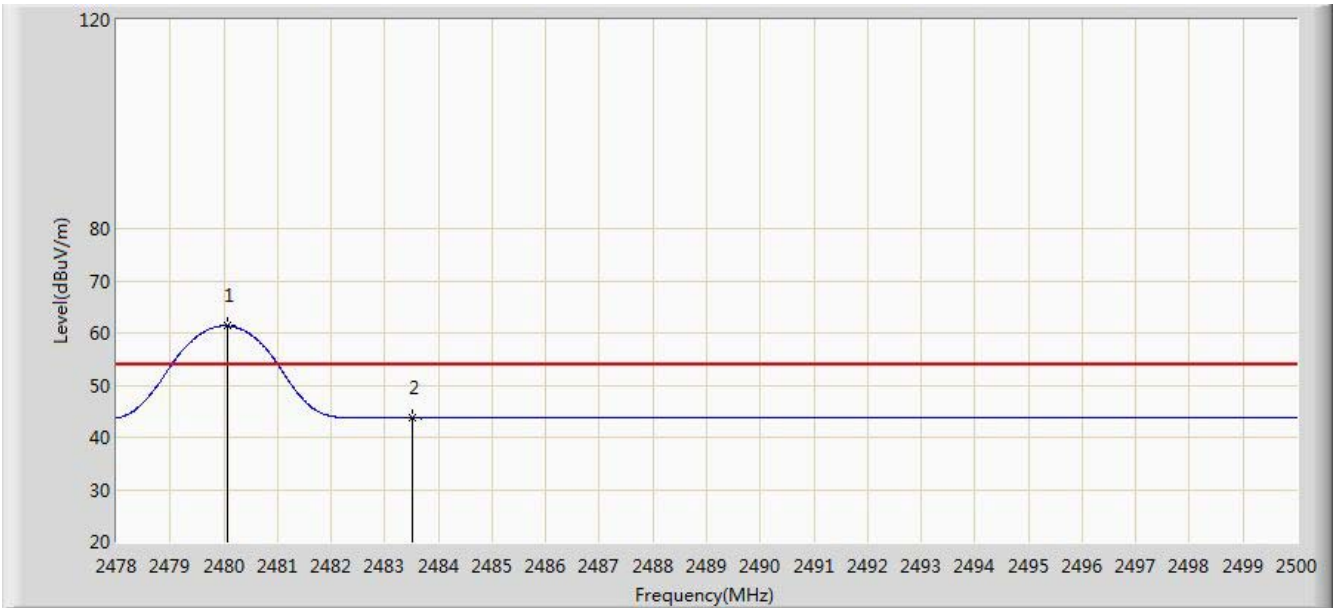

No	Flag	Mark	Frequency (MHz)	Measure Level (dBuV/m)	Reading Level (dBuV)	Over Limit (dB)	Limit (dBuV/m)	Factor (dB)	Type
1		*	2480.079	61.336	30.673	N/A	N/A	30.662	AV
2			2483.500	43.648	12.975	-10.352	54.000	30.673	AV

Note: Measure Level (dBμV/m) = Reading Level (dBμV) + Factor (dB)

Factor (dB) = Cable Loss (dB) + Antenna Factor (dB/m)

Engineer: Milo Li	
Site: AC1	Time: 2014/11/03 - 17:45
Limit: FCC_Part15.209_RE(3m)	Margin: 0
Probe: BBHA9120D_1-18GHz	Polarity: Vertical
EUT: Smart Wristband	Power: By Battery
Test Mode: BLE at channel 2480MHz	

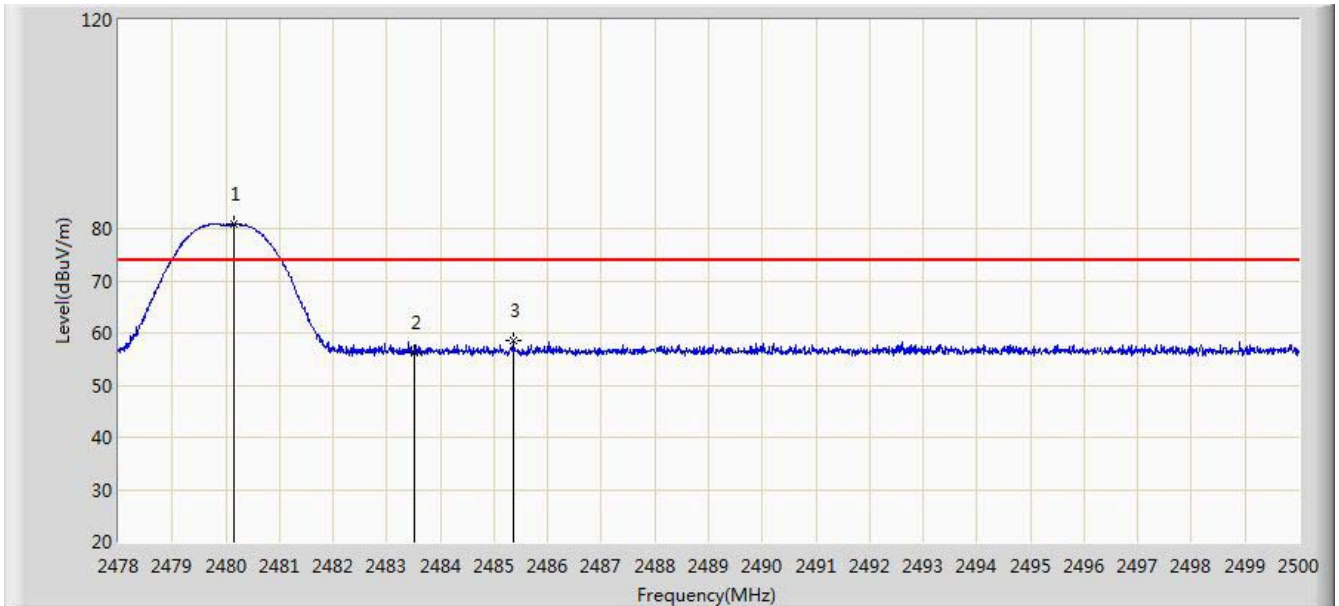

No	Flag	Mark	Frequency (MHz)	Measure Level (dBuV/m)	Reading Level (dBuV)	Over Limit (dB)	Limit (dBuV/m)	Factor (dB)	Type
1		*	2480.156	80.815	50.152	N/A	N/A	30.663	PK
2			2483.500	56.184	25.511	-17.816	74.000	30.673	PK
3			2485.348	58.495	27.817	-15.505	74.000	30.678	PK

Note: Measure Level (dBuV/m) = Reading Level (dBuV) + Factor (dB)

Factor (dB) = Cable Loss (dB) + Antenna Factor (dB/m)

Engineer: Milo Li	
Site: AC1	Time: 2014/11/03 - 17:47
Limit: FCC_Part15.209_RE(3m)	Margin: 0
Probe: BBHA9120D_1-18GHz	Polarity: Vertical
EUT: Smart Wristband	Power: By Battery
Test Mode: BLE at channel 2480MHz	

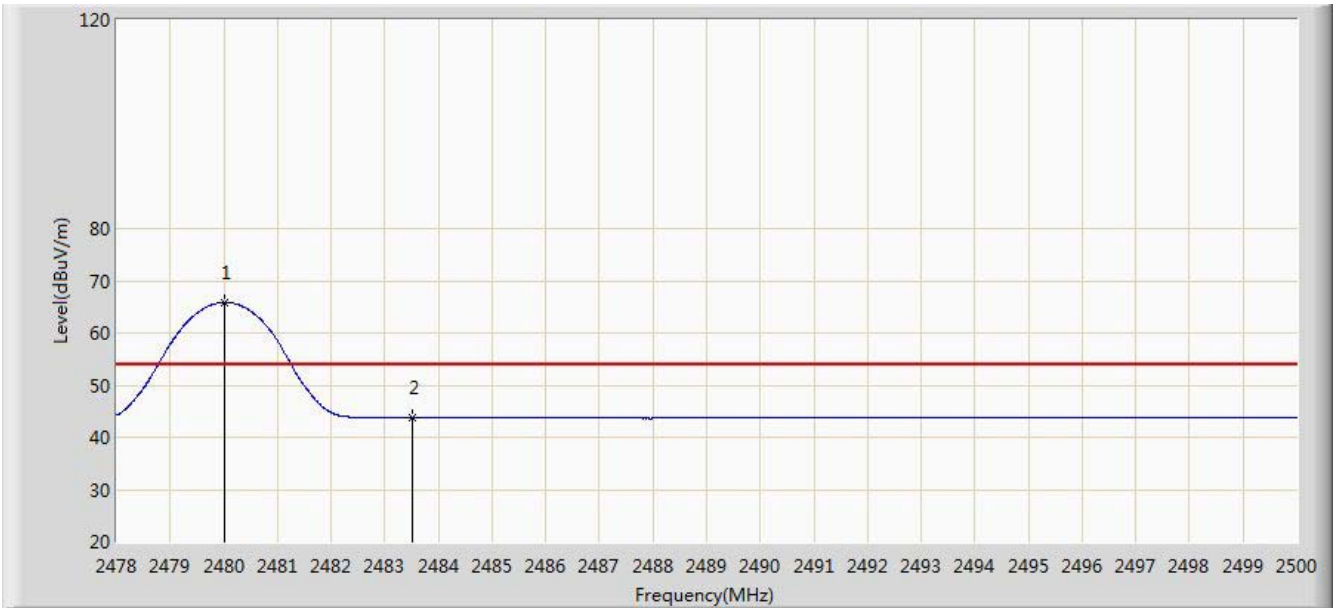

No	Flag	Mark	Frequency (MHz)	Measure Level (dBuV/m)	Reading Level (dBuV)	Over Limit (dB)	Limit (dBuV/m)	Factor (dB)	Type
1		*	2480.002	65.852	35.190	N/A	N/A	30.662	AV
2			2483.500	43.699	13.026	-10.301	54.000	30.673	AV

Note: Measure Level (dBμV/m) = Reading Level (dBμV) + Factor (dB)

Factor (dB) = Cable Loss (dB) + Antenna Factor (dB/m)

7.8. AC Conducted Emissions Measurement

7.8.1. Test Limit

FCC Part 15 Subpart C Paragraph 15.207 Limits		
Frequency (MHz)	QP (dBuV)	AV (dBuV)
0.15 - 0.50	66 - 56	56 - 46
0.50 - 5.0	56	46
5.0 - 30	60	50

Note 1: The lower limit shall apply at the transition frequencies.

Note 2: The limit decreases linearly with the logarithm of the frequency in the range 0.15MHz to 0.5MHz.

7.8.2. Test Setup

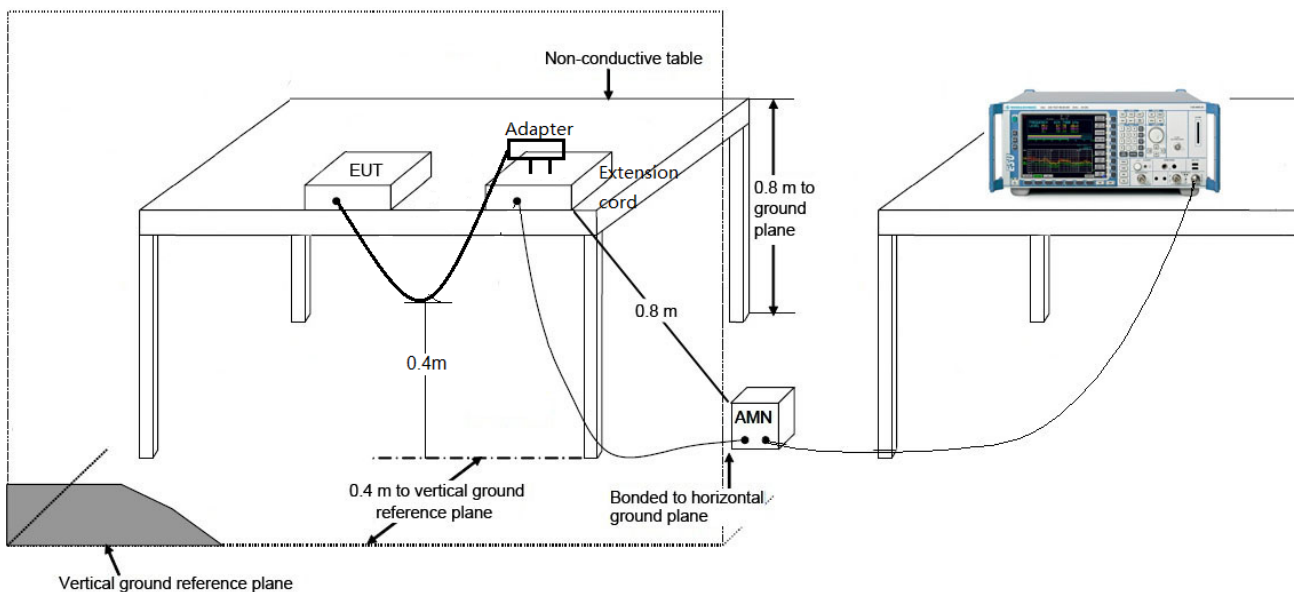

7.8.3. Test Result

Engineer: Milo Li	
Site: SR2	Time: 2014/10/31 - 19:39
Limit: FCC_Part15.207_CE_AC Power	Margin: 0
Probe: ENV216_101683_Filter On	Polarity: Line
EUT: Smart Wristband	Power: AC 120V/60Hz
Note: Mode1	

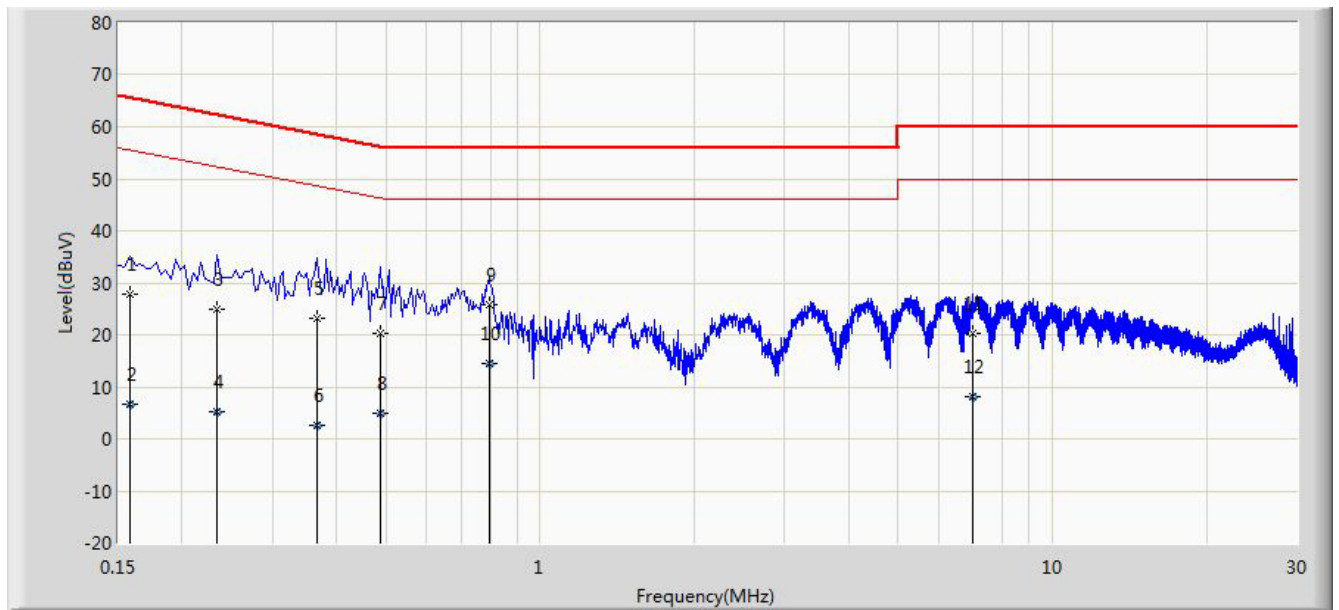

No	Flag	Mark	Frequency (MHz)	Measure Level (dBuV)	Reading Level (dBuV)	Over Limit (dB)	Limit (dBuV)	Factor (dB)	Type
1			0.158	27.904	17.593	-37.664	65.568	10.311	QP
2			0.158	6.657	-3.654	-48.911	55.568	10.311	AV
3			0.234	24.988	15.037	-37.319	62.307	9.951	QP
4			0.234	5.121	-4.830	-47.186	52.307	9.951	AV
5			0.366	23.289	13.231	-35.302	58.591	10.058	QP
6			0.366	2.532	-7.526	-46.059	48.591	10.058	AV
7			0.486	20.385	10.230	-35.851	56.236	10.155	QP
8			0.486	5.034	-5.121	-41.202	46.236	10.155	AV
9		*	0.794	25.843	15.829	-30.157	56.000	10.014	QP
10			0.794	14.592	4.578	-31.408	46.000	10.014	AV
11			6.982	20.243	10.090	-39.757	60.000	10.153	QP
12			6.982	8.170	-1.983	-41.830	50.000	10.153	AV

Note: Measure Level (dB μ V/m) = Reading Level (dB μ V) + Factor (dB)

Factor (dB) = Cable Loss (dB) + LISN Factor (dB)

Engineer: Milo Li	
Site: SR2	Time: 2014/10/31 - 19:46
Limit: FCC_Part15.207_CE_AC Power	Margin: 0
Probe: ENV216_101683_Filter On	Polarity: Neutral
EUT: Smart Wristband	Power: AC 120V/60Hz
Note: Mode1	

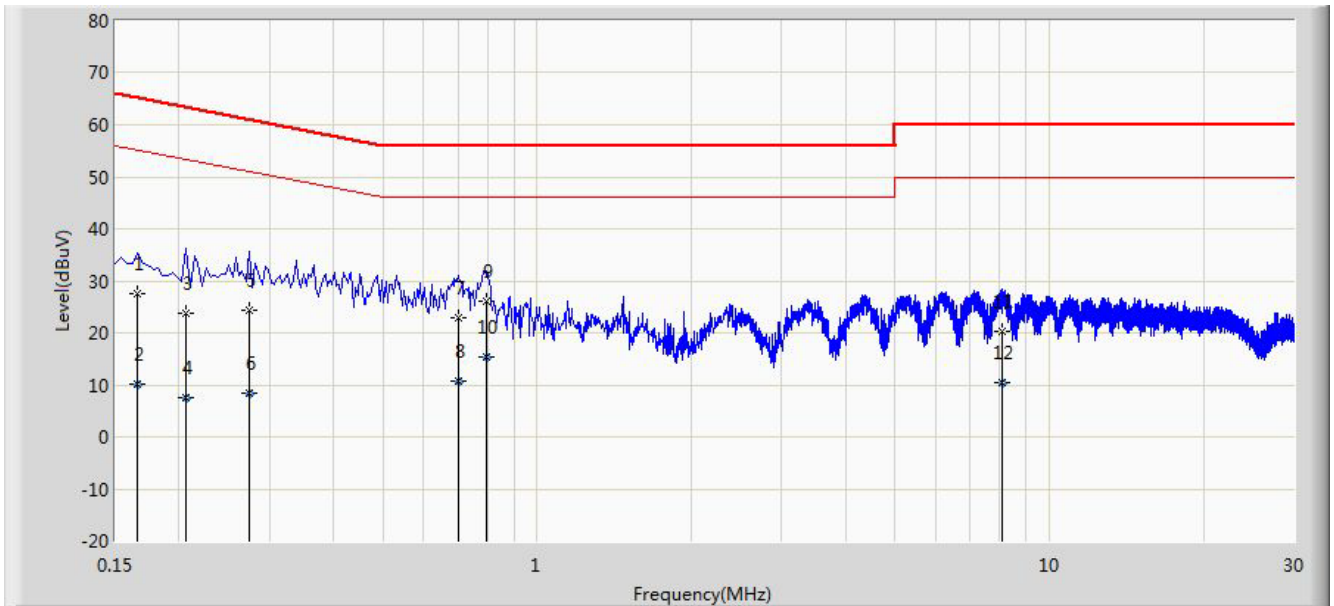

No	Flag	Mark	Frequency (MHz)	Measure Level (dBuV)	Reading Level (dBuV)	Over Limit (dB)	Limit (dBuV)	Factor (dB)	Type
1			0.166	27.569	17.498	-37.589	65.158	10.071	QP
2			0.166	10.040	-0.031	-45.118	55.158	10.071	AV
3			0.206	23.852	13.851	-39.513	63.365	10.001	QP
4			0.206	7.453	-2.548	-45.912	53.365	10.001	AV
5			0.274	24.480	14.461	-36.516	60.996	10.019	QP
6			0.274	8.275	-1.744	-42.721	50.996	10.019	AV
7			0.702	22.890	12.816	-33.110	56.000	10.074	QP
8			0.702	10.861	0.787	-35.139	46.000	10.074	AV
9		*	0.798	26.181	16.161	-29.819	56.000	10.020	QP
10			0.798	15.368	5.348	-30.632	46.000	10.020	AV
11			8.066	20.148	9.959	-39.852	60.000	10.189	QP
12			8.066	10.534	0.345	-39.466	50.000	10.189	AV

Note: Measure Level (dB μ V/m) = Reading Level (dB μ V) + Factor (dB)

Factor (dB) = Cable Loss (dB) + LISN Factor (dB)

8. CONCLUSION

The data collected relate only the item(s) tested and show that the **Smart Wristband FCC ID: 2ADHUIDO001** is in compliance with Part 15C of the FCC Rules.

The End