

<b>Prüfbericht-Nr.:</b> <i>Test report no.:</i>	CN22J0TN(P15C-BLE) 001	<b>Auftrags-Nr.:</b> <i>Order no.:</i>	238542284	Seite 1 von 24 Page 1 of 24
<b>Kunden-Referenz-Nr.:</b> <i>Client reference no.:</i>	N/A	<b>Auftragsdatum:</b> <i>Order date:</i>	2022-04-14	
<b>Auftraggeber:</b> <i>Client:</i>	Microchip Technology Inc. 2355 West Chandler Blvd. Chandler, Arizona 85224-6199, United States.			
<b>Prüfgegenstand:</b> <i>Test item:</i>	IEEE 802.11 b/g/n Network Controller Module with Integrated Bluetooth Low Energy 4.0			
<b>Bezeichnung / Typ-Nr.:</b> <i>Identification / Type no.:</i>	ATWINC3400-MR210CA			
<b>Auftrags-Inhalt:</b> <i>Order content:</i>	FCC Part 15C Test report (BLE)			
<b>Prüfgrundlage:</b> <i>Test specification:</i>	FCC 47CFR Part 15: Subpart C Section 15.247			
<b>Wareneingangsdatum:</b> <i>Date of sample receipt:</i>	2022-03-29			
<b>Prüfmuster-Nr.:</b> <i>Test sample no.:</i>	A003234841-004 A003234841-005			
<b>Prüfzeitraum:</b> <i>Testing period:</i>	2022-04-28 - 2022-05-07			
<b>Ort der Prüfung:</b> <i>Place of testing:</i>	EMC/RF Taipei Testing Site			
<b>Prüflaboratorium:</b> <i>Testing laboratory:</i>	Taipei Testing Laboratories			
<b>Prüfergebnis*:</b> <i>Test result*:</i>	Pass			
<b>zusammengestellt von:</b> <i>compiled by:</i>		<b>genehmigt von:</b> <i>authorized by:</i>		
<b>Datum:</b> <i>Date:</i>	2022-06-07	<b>Ausstellungsdatum:</b> <i>Issue date:</i>	2022-06-07	
<b>Stellung / Position:</b>	Senior Project Manager	<b>Stellung / Position:</b>	Senior Project Manager	
<b>Sonstiges / Other:</b>	This report is only evaluated and verified the output power and RSE tests for second source crystal change. The other test results are referred to report no. D50616R1.			
<b>Zustand des Prüfgegenstandes bei Anlieferung:</b> <i>Condition of the test item at delivery:</i>	Prüfmuster vollständig und unbeschädigt <i>Test item complete and undamaged</i>			
* Legende:	1 = sehr gut P(ass) = entspricht o.g. Prüfgrundlage(n)	2 = gut F(ail) = entspricht nicht o.g. Prüfgrundlage(n)	3 = befriedigend N/A = nicht anwendbar	4 = ausreichend N/T = nicht getestet
* Legend:	1 = very good P(ass) = passed a.m. test specification(s)	2 = good F(ail) = failed a.m. test specification(s)	3 = satisfactory N/A = not applicable	4 = sufficient N/T = not tested
<b>Dieser Prüfbericht bezieht sich nur auf das o.g. Prüfmuster und darf ohne Genehmigung der Prüfstelle nicht auszugsweise vervielfältigt werden. Dieser Bericht berechtigt nicht zur Verwendung eines Prüfzeichens.</b> <i>This test report only relates to the a. m. test sample. Without permission of the test center this test report is not permitted to be duplicated in extracts. This test report does not entitle to carry any test mark.</i>				

## TEST SUMMARY

Report Section	FCC Clause	Test Item	Result
5.1.1	15.247(b) & 15.203	Antenna Requirement	Pass
5.1.2	15.247(b)(3)	Peak Output Power	Pass
-	15.247(a)(2)	6 dB Bandwidth	Refer to report no. D50616R1
-	2.1049	99% Occupied Bandwidth	
-	15.247(e)	Power Spectral Density	
-	15.247(d)	Conducted Spurious Emissions and Band Edges	
5.1.3	15.247(d) & 15.205 & 15.209	Radiated Spurious Emissions and Band Edges	Pass
5.2.1	15.207	Mains Conducted Emission	Pass

**Note:** Determining compliance based on the results of the compliance measurement, not taking into account measurement instrumentation uncertainty.

## Contents

<b>HISTORY OF THIS TEST REPORT .....</b>	<b>5</b>
<b>1. GENERAL REMARKS .....</b>	<b>6</b>
<b>1.1 COMPLEMENTARY MATERIALS.....</b>	<b>6</b>
<b>1.2 DECISION RULE OF CONFORMITY .....</b>	<b>6</b>
<b>2. TEST SITES .....</b>	<b>7</b>
<b>2.1 TEST LABORATORY .....</b>	<b>7</b>
<b>2.2 TEST FACILITY.....</b>	<b>7</b>
<b>2.3 TRACEABILITY .....</b>	<b>8</b>
<b>2.4 CALIBRATION .....</b>	<b>8</b>
<b>2.5 MEASUREMENT UNCERTAINTY .....</b>	<b>8</b>
<b>3. GENERAL PRODUCT INFORMATION.....</b>	<b>9</b>
<b>3.1 PRODUCT FUNCTION AND INTENDED USE .....</b>	<b>9</b>
<b>3.2 SYSTEM DETAILS AND RATINGS.....</b>	<b>9</b>
<b>3.3 NOISE GENERATING AND NOISE SUPPRESSING PARTS .....</b>	<b>10</b>
<b>3.4 SUBMITTED DOCUMENTS.....</b>	<b>10</b>
<b>4. TEST SET-UP AND OPERATION MODES.....</b>	<b>11</b>
<b>4.1 PRINCIPLE OF CONFIGURATION SELECTION .....</b>	<b>11</b>
<b>4.2 CARRIER FREQUENCY AND CHANNEL.....</b>	<b>11</b>
<b>4.3 TEST OPERATION AND TEST SOFTWARE.....</b>	<b>12</b>
<b>4.4 SPECIAL ACCESSORIES AND AUXILIARY EQUIPMENT .....</b>	<b>13</b>
<b>4.5 TEST SETUP DIAGRAM .....</b>	<b>14</b>
<b>5. TEST RESULTS .....</b>	<b>15</b>
<b>5.1 TRANSMITTER REQUIREMENT &amp; TEST SUITES .....</b>	<b>15</b>
5.1.1 <i>Antenna Requirement .....</i>	<i>15</i>
5.1.2 <i>Peak Output Power .....</i>	<i>16</i>
5.1.3 <i>Radiated Spurious Emissions and Band Edges .....</i>	<i>18</i>
<b>5.2 MAINS EMISSION .....</b>	<b>23</b>
5.2.1 <i>Mains Conducted Emission.....</i>	<i>23</i>

**Prüfbericht - Nr.: CN22J0TN(P15C-BLE) 001**  
Test Report No.

Seite 4 von 24  
Page 4 of 24

**APPENDIX A - TEST RESULT OF RADIATED EMISSIONS & MAINS CONDUCTED EMISSION**

**APPENDIX SP - PHOTOGRAPHS OF TEST SETUP**

**APPENDIX EP - PHOTOGRAPHS OF EUT**

**Prüfbericht - Nr.:** CN22J0TN(P15C-BLE) 001  
Test Report No.

Seite 5 von 24  
Page 5 of 24

### HISTORY OF THIS TEST REPORT

Report No.	Description	Date Issued
CN22J0TN(P15C-BLE) 001	Original Release	2022-06-07

## 1. General Remarks

### 1.1 Complementary Materials

All attachments are integral parts of this test report. This applies especially to the following appendix:

**Appendix A - Test Result of Radiated Emissions & Mains Conducted Emission**

**Appendix SP - Photographs of Test Setup**

**Appendix EP - Photographs of EUT**

#### Applied Standard and Test Levels

Radio
FCC 47CFR Part 15: Subpart C Section 15.247
FCC 47CFR Part 2: Subpart J Section 2.1049
ANSI C63.10:2013
KDB 558074 D01 15.247 Meas Guidance v05r02

### 1.2 Decision Rule of Conformity

The decision rule of conformity of this test report is following the requirements of the requested standard in the quotation, and agreed among testing laboratory and manufacturer (applicant) to exclude the consideration of Measurement Uncertainty, unless it is required by the specific standard.

## 2. Test Sites

### 2.1 Test Laboratory

Taipei Testing Laboratories

11F. No.758, Sec. 4, Bade Rd., Songshan Dist.  
Taipei City 105  
Taiwan (R.O.C.)

### 2.2 Test Facility

Taipei Testing Laboratories

No.458-18, Sec. 2, Fenliao Rd., Linkou Dist.,  
New Taipei City 244  
Taiwan (R.O.C.)  
FCC Registration No.: 226631  
ISED Registration No.: 25563

## 2.3 Traceability

All measurement equipment calibrations are traceable to NML(Taiwan)/NIST(USA) or where calibration is performed outside Taiwan, to equivalent nationally recognized standards organizations.

## 2.4 Calibration

Equipment requiring calibration is calibrated periodically in a suitably accredited Calibration Lab. Additionally all equipment is verified for proper performance on a regular basis using in house standards or comparisons.

## 2.5 Measurement Uncertainty

All measurement uncertainty values are shown with a coverage factor of  $k=2$  to indicate a 95% level of confidence.

### Emission Measurement Uncertainty

Parameter	Uncertainty
Radiated Emission (9 kHz ~ 30 MHz)	$\pm 1.15$ dB
Radiated Emission (30 MHz ~ 200 MHz)	$\pm 1.30$ dB
Radiated Emission (200 MHz ~ 1 GHz)	$\pm 1.30$ dB
Radiated Emission (1 GHz ~ 18 GHz)	$\pm 1.54$ dB
Radiated Emission (18 GHz ~ 40 GHz)	$\pm 2.52$ dB
Mains Conducted Emission	$\pm 1.65$ dB



### 3. General Product Information

#### 3.1 Product Function and Intended Use

The EUT is an IEEE 802.11 b/g/n Network Controller Module with Integrated Bluetooth Low Energy 4.0. The Module has RF Shield and integrated Chip Antenna.

For details refer to the User Guide, Data Sheet and Circuit Diagram.

#### 3.2 System Details and Ratings

##### Basic Information of EUT

Item	EUT information
Kind of Equipment/Test Item	IEEE 802.11 b/g/n Network Controller Module with Integrated Bluetooth Low Energy 4.0
Type Identification	ATWINC3400-MR210CA
FCC ID	2ADHKWINC3400

##### Technical Specification of EUT

Item	EUT information
Operating Frequency	2402 MHz ~ 2480 MHz
Channel Spacing	2 MHz
Channel Number	40
Data Rate	1Mbps
Operation Voltage	3.0Vdc~4.2Vdc, Typical = 3.3Vdc (Tested in 5Vdc(USB))
Modulation	GFSK
Maximum Output Power (mW)	4.73
Antenna Information	Refer to 5.1.1
Accessory Device	Refer to 4.4

Note: The 2<sup>nd</sup> source information:

Reference Designator	BOM2 (2nd Source)	Manufacturer	Manufacturer Part No.	Remarks
Y1	26MHz	TST	TZ1039PAAF32	Crystal 16MHz 2520 size
L8, L9, L14	3.3nH	Murata	LQP03TN3N3C02D	
L10	6.8nH	Murata	LQP03TN6N8J02	

### **3.3 Noise Generating and Noise Suppressing Parts**

Refer to the Circuit Diagram.

### **3.4 Submitted Documents**

- Circuit Diagram
- Instruction Manual
- Rating Label
- Technical Description

## 4. Test Set-up and Operation Modes

### 4.1 Principle of Configuration Selection

The test modes were adapted accordingly in reference to the instructions for use.

During testing, Channel and Power Controlling Software provided by the customer was used to control the operating channel as well as the output power level. The RF output power selection is for the setting of RF output expected by the customer and is going to be fixed on the firmware of the final end product.

#### Table for Parameters of Test Software Setting

Frequency (MHz)	Power Setting
2402	6,9,-7.5
2440	6,9,-8.5
2480	6,9,-7.5

### 4.2 Carrier Frequency and Channel

Channel	Freq. (MHz)	Channel	Freq. (MHz)	Channel	Freq. (MHz)	Channel	Freq. (MHz)
0	2402	10	2422	20	2442	30	2462
1	2404	11	2424	21	2444	31	2464
2	2406	12	2426	22	2446	32	2466
3	2408	13	2428	23	2448	33	2468
4	2410	14	2430	24	2450	34	2470
5	2412	15	2432	25	2452	35	2472
6	2414	16	2434	26	2454	36	2474
7	2416	17	2436	27	2456	37	2476
8	2418	18	2438	28	2458	38	2478
9	2420	19	2440	29	2460	39	2480

### 4.3 Test Operation and Test Software

Setup for testing: Test samples are provided with a USB interface which makes it possible to control them through a test software installed on a notebook computer.  
 This software was running on the laptop computer connected to the EUT. It was used to enable the operation modes listed as below.

Test Software	MCHPRT2 V1.3
---------------	--------------

The samples were used as follows:  
 A003234841-004 for conducted test  
 A003234841-005 for radiated test  
 Full test was applied on all test modes, but only worst case was shown.

EUT Configure Mode	Applicable To			Mains Conducted Emission	Description
	Antenna Port Conducted Measurement	Radiated Spurious Emissions above 1 GHz	Radiated Spurious Emissions below 1 GHz		
-	√	√	√	√	-

- Note:
1. The EUT had been pre-tested on the positioned of each 3 axis. The worst case was found when position on Z-plane.
  2. "-" means no effect.

#### Antenna Port Conducted Measurement

- Pre-Scan full test was applied on all test modes, but only worst case was shown.
- Following channel(s) was (were) selected for the final test as listed below.

EUT Configure Mode	Available Frequency (MHz)	Tested Frequency (MHz)	Date Rate (Mbps)
-	2402 to 2480	2402, 2440, 2480	1

#### Radiated Spurious Emissions (Above 1 GHz)

- Pre-Scan full test was applied on all test modes, but only worst case was shown.
- Following channel(s) was (were) selected for the final test as listed below.

EUT Configure Mode	Available Frequency (MHz)	Tested Frequency (MHz)	Date Rate (Mbps)
-	2402 to 2480	2402, 2440, 2480	1

#### Radiated Spurious Emissions (Below 1 GHz)

- Pre-Scan full test was applied on all test modes, but only worst case was shown.
- Following channel(s) was (were) selected for the final test as listed below.

EUT Configure Mode	Available Frequency (MHz)	Tested Frequency (MHz)	Date Rate (Mbps)
-	2402 to 2480	2480	1

#### Mains Conducted Emission

- Pre-Scan full test was applied on all test modes, but only worst case was shown.
- Following channel(s) was (were) selected for the final test as listed below.

EUT Configure Mode	Available Frequency (MHz)	Tested Frequency (MHz)	Date Rate (Mbps)
-	2402 to 2480	2480	1

**Test Condition**

Test Item	Ambient Temperature	Relative Humidity	Tested by
Conducted Measurement	18-23 °C	59-69 %	Nick Hsu
Radiated Spurious Emissions above 1 GHz	23.3-24.1 °C	55-59 %	Chuan Chu
Radiated Spurious Emissions below 1 GHz	23.3-24.1 °C	55-59 %	Chuan Chu
Mains Conducted Emission	20.1-20.9 °C	53-57 %	Ray Huang

## 4.4 Special Accessories and Auxiliary Equipment

The product has been tested together with the following additional accessories:

**Accessory of EUT**

None.

**Support Unit**

No.	Description	Brand	Model	S/N	Remark
<b>Radiated Test</b>					
A	Fixture01	Microchip	SAMD21	-	-
B	Fixture02	Microchip	Microchip-01	-	-
C	Fixture Cable*3	Microchip	Microchip-02	-	10 cm non-shielded cable w/o core
1	Notebook	Lenovo	81BL	MP1DCD6Y	-
2	Mirco USB Cable	TUV	TUV-01	-	200 cm non-shielded cable w/o core
3	USB-B Cable	TUV	TUV-02	-	200 cm non-shielded cable w/o core
<b>Mains Conducted Test</b>					
A	Fixture01	Microchip	SAMD21	-	-
B	Fixture02	Microchip	Microchip-01	-	-
C	Fixture Cable*3	Microchip	Microchip-02	-	-
1	Notebook	Lenovo	81BL	MP1DCD6Y	-
2	Mirco USB Cable	TUV	TUV-01	-	200 cm non-shielded cable w/o core
3	Adapter	HP	PPP009D	-	180 cm shielded cable w/o core
4	USB-B Cable	TUV	TUV-02	-	200 cm non-shielded cable w/o core

### 4.5 Test Setup Diagram

<Radiated Spurious Emissions mode>

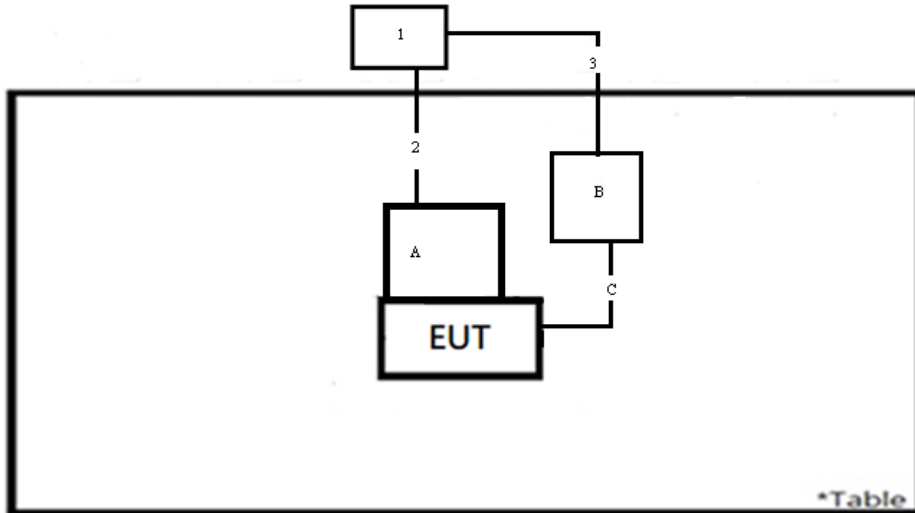

<Mains Conducted Emission mode>

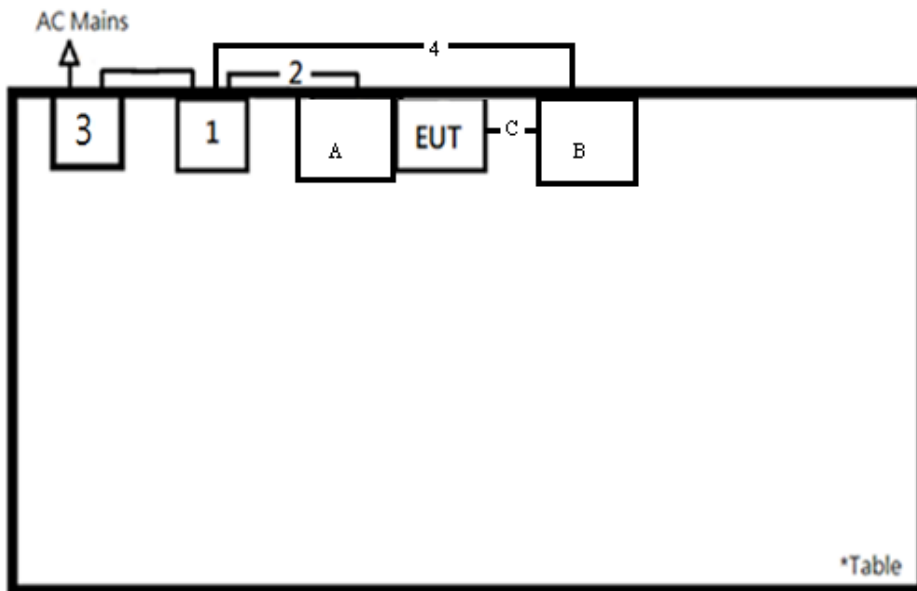

## 5. Test Results

### 5.1 Transmitter Requirement & Test Suites

#### 5.1.1 Antenna Requirement

**Requirement** Use of approved antennas only

According to the manufacturer declaration, the EUT has an antenna with a directional gain of 0.5 dBi. The antenna is a chip antenna with no possibility of replacement with a non-approved antenna by the end-user. Therefore, the EUT is considered to comply with this provision.  
Refer to EUT photo for details.

### 5.1.2 Peak Output Power

**Limit** 1 watt (30 dBm)

**Kind of Test Site** Shielded room

#### Test Setup

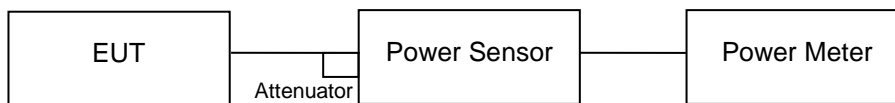

#### Test Instruments

Kind of Equipment	Manufacturer	Type	S/N	Calibration Date	Calibration Due Date	Test Date	
						From	Until
Power Meter	Anritsu	ML2495A	1901008	2022/3/14	2023/3/13	2022/4/28	2022/4/28
Power Sensor	Anritsu	MA2411B	1725269	2022/3/14	2023/3/13	2022/4/28	2022/4/28

#### Test Procedures

A peak power sensor was used on the output port of the EUT. A power meter was used to read the response of the peak power sensor. Record the power level.

Average power sensor was used to perform output power measurement, trigger and gating function of wide band power meter is enabled to measure max output power of TX on burst. Duty factor is not added to measured value.



**Test Result**
**Peak Output Power**
**<1Mbps>**

Channel	Channel Frequency	Peak Output Power		Limit (dBm)
	(MHz)	(dBm)	(mW)	
Low Channel	2402	6.22	4.19	30
Middle Channel	2440	5.84	3.84	30
High Channel	2480	6.75	4.73	30

**Average Power**
**<1Mbps>**

Channel	Channel Frequency	Average Power	
	(MHz)	(dBm)	(mW)
Low Channel	2402	5.76	3.77
Middle Channel	2440	5.39	3.46
High Channel	2480	6.20	4.17

### 5.1.3 Radiated Spurious Emissions and Band Edges

#### Limit

Radiated emissions which fall in the restricted bands, as defined in §15.205(a), must comply with the radiated emission limits specified in §15.209(a).

Emissions radiated outside the restricted and authorized frequency bands must either comply with the radiated emission limits specified for the restricted bands or in §15.247(d).

**Kind of Test Site**                      3m Semi-Anechoic Chamber

#### Test Setup

**<Radiated Emissions below 30 MHz>**

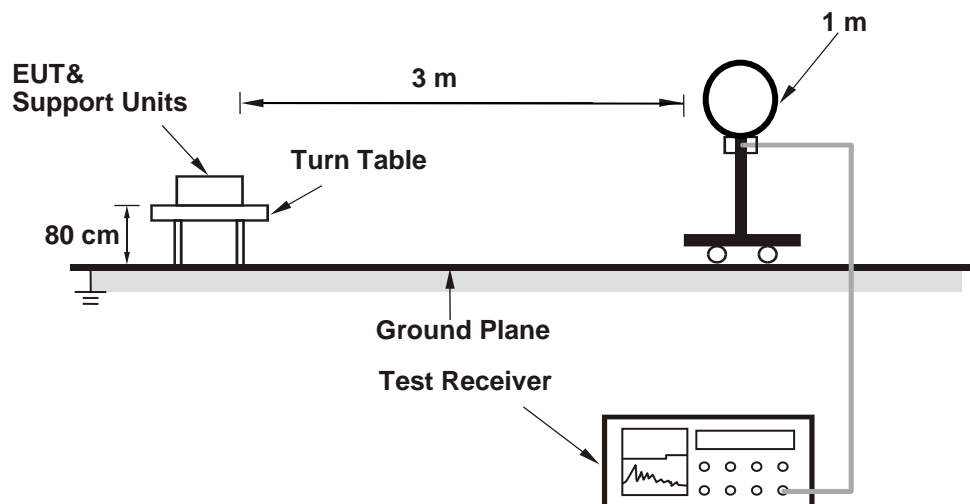

**<Radiated Emissions 30 MHz to 1 GHz>**

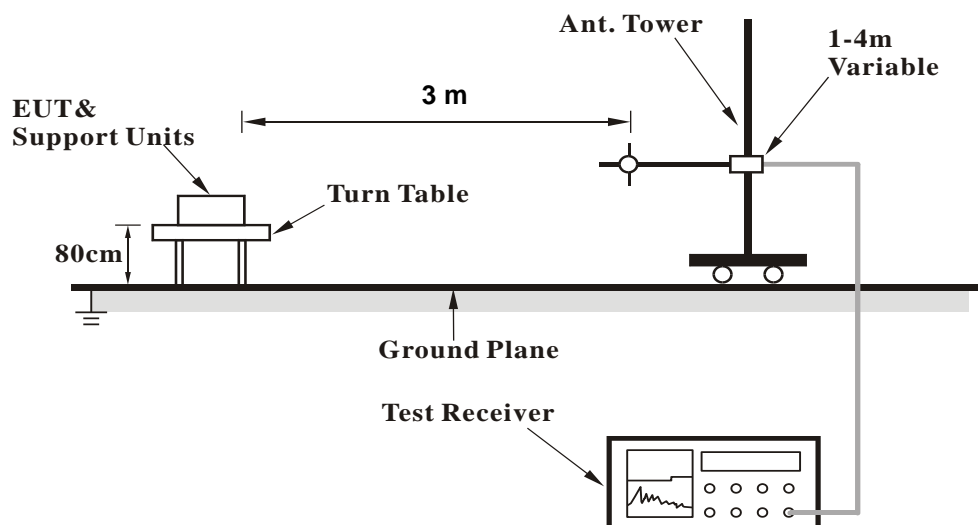

## &lt;Radiated Emissions above 1 GHz&gt;

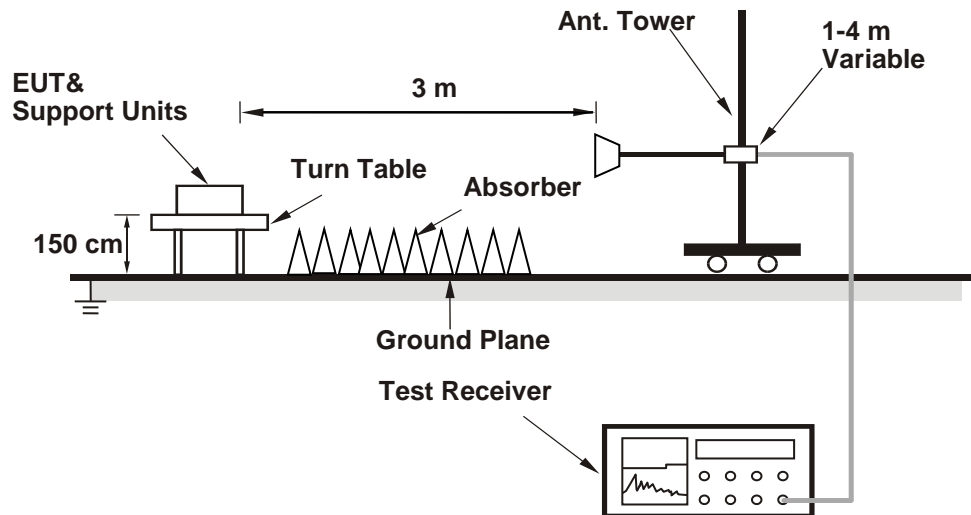

For the actual test configuration, please refer to the attached file (Test Setup Photo).

**Test Instruments and Test Date**

Below 30MHz: 2022/5/3

Kind of Equipment	Manufacturer	Type	S/N	Calibration Date	Calibration Due Date
Receiver	R&S	ESR7	102109	2022/2/25	2023/2/24
Microwave Cable	SUCOFLEX 104EA	800056/4EA	804680/4	2022/3/22	2023/3/21
Loop Antenna	SCHWARZBECK	FMZB 1519B	00215	2021/12/8	2022/12/7

30MHz-1GHz: 2022/5/3

Kind of Equipment	Manufacturer	Type	S/N	Calibration Date	Calibration Due Date
Receiver	R&S	ESR7	102109	2022/2/25	2023/2/24
Bilog Antenna	SCHWARZBECK	VULB-9168	00949	2021/5/30	2022/5/29
LF-AMP	Agilent	8447D	2727A05146	2022/2/16	2023/2/15

Above 1GHz: 2022/5/1 – 2022/5/2

Kind of Equipment	Manufacturer	Type	S/N	Calibration Date	Calibration Due Date
Signal Analyzer	R&S	FSV40	101513	2021/5/28	2022/5/27
Horn Antenna	ETS-Lindgren	3117	00218929	2021/11/25	2022/11/24
HF-AMP + AC source	EMCI	EMC051845SE	980635	2022/1/20	2023/1/19
HF-AMP + AC source	EMCI	EMC184045SE	980656	2022/1/20	2023/1/19
Horn Antenna	SCHWARZBECK	BBHA 9170	00887	2022/3/29	2023/3/28

**Test Procedures****For Radiated Emissions below 30 MHz**

- a. The EUT was placed on the top of a rotating table 0.8 meters above the ground at a 3 meter chamber room. The table was rotated 360 degrees to determine the position of the highest radiation.
- b. The EUT was set 3 meters away from the interference-receiving antenna, which was mounted on the top of a variable-height antenna tower.
- c. Parallel (OPEN), perpendicular (CLOSE), and ground-parallel (GROUND) orientations of the antenna are set to make the measurement.
- d. For each suspected emission, the EUT was arranged to its worst case and the rotatable table was turned from 0 degrees to 360 degrees to find the maximum reading.
- e. The test-receiver system was set to Quasi-Peak Detect Function and Specified Bandwidth with Maximum Hold Mode.

## Note:

1. The resolution bandwidth and video bandwidth of test receiver/spectrum analyzer is 9 kHz at frequency below 30 MHz.
2. All modes of operation were investigated and the worst-case emissions are reported.

**For Radiated Emissions above 30 MHz**

- a. The EUT was placed on the top of a rotating table 0.8 meters (for 30 MHz ~ 1 GHz) / 1.5 meters (for above 1 GHz) above the ground at 3 meter chamber room for test. The table was rotated 360 degrees to determine the position of the highest radiation.
- b. The EUT was set 3 meters away from the interference-receiving antenna, which was mounted on the top of a variable-height antenna tower.
- c. The height of antenna is varied from one meter to four meters above the ground to determine the maximum value of the field strength. Both horizontal and vertical polarizations of the antenna are set to make the measurement.
- d. For each suspected emission, the EUT was arranged to its worst case and then the antenna was tuned to heights from 1 meter to 4 meters and the rotatable table was turned from 0 degrees to 360 degrees to find the maximum reading.
- e. The test-receiver system was set to quasi-peak detect function and specified bandwidth with maximum hold mode when the test frequency is below 1 GHz.
- f. The test-receiver system was set to peak and average detected function and specified bandwidth with maximum hold mode when the test frequency is above 1 GHz. If the peak reading value also meets average limit, measurement with the average detector is unnecessary.

## Note:

1. The resolution bandwidth and video bandwidth of test receiver/spectrum analyzer is 120 kHz for Quasi-peak detection (QP) or Peak detection (PK) at frequency below 1 GHz.
2. The resolution bandwidth of test receiver/spectrum analyzer is 1 MHz and the video bandwidth is 3 MHz for Peak detection (PK) at frequency above 1 GHz.
3. The resolution bandwidth of test receiver/spectrum analyzer is 1 MHz and the video bandwidth is  $\geq 1/T$  (Duty cycle < 98 %) or 10 Hz (Duty cycle  $\geq 98$  %) for Average detection (AV) at frequency above 1 GHz.
4. All modes of operation were investigated and the worst-case emissions are reported.
5. The Radiated Emissions testing was performed in the X(E1), Y(H) and Z(E2) axis orientation. The worst-case Axis orientation is recorded in this test report.

**Prüfbericht - Nr.:**      **CN22J0TN(P15C-BLE) 001**  
*Test Report No.*

**Seite 22 von 24**  
*Page 22 of 24*

**Test Results**

Factor (dB/m) = Antenna Factor (dB/m) + Cable Loss (dB)  
Level (dBuV/m) = Reading (dBuV) + Factor (dB/m)

Please refer to Appendix A.

## 5.2 Mains Emission

### 5.2.1 Mains Conducted Emission

#### Limit

Mains Conducted Emission as defined in §15.207 must comply with the mains conducted emission limits.

**Kind of Test Site**                      Shielded room

#### Test Setup

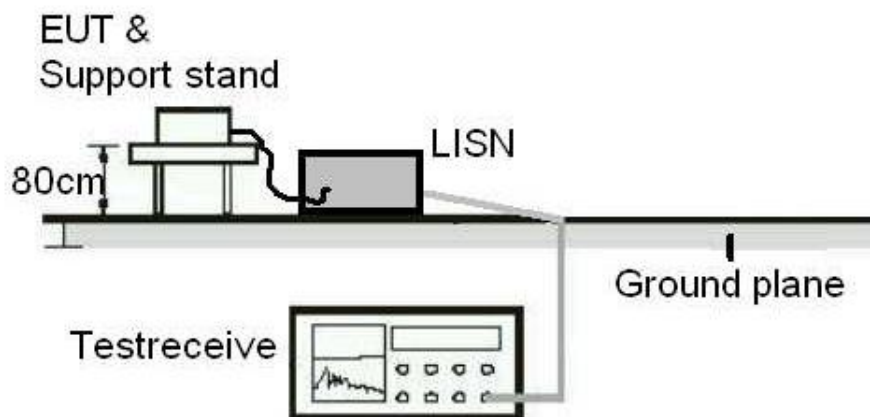

#### Test Instruments

Test Date: 2022/5/7

Kind of Equipment	Manufacturer	Type	S/N	Calibration Date	Calibration Due Date
Two-Line V-Network	Rohde & Schwarz	ENV216	101938	2021/9/23	2022/9/22
EMI Test Receiver	R&S	ESCI	1816063	2021/11/15	2022/11/14

#### **Test Procedures**

- a. The EUT was placed 0.4 meters from the conducting wall of the shielded room with EUT being connected to the power mains through a line impedance stabilization network (LISN). Other support units were connected to the power mains through another LISN. The two LISNs provide 50 ohm/50 uH of coupling impedance for the measuring instrument.
- b. Both lines of the power mains connected to the EUT were checked for maximum conducted interference.
- c. The frequency range from 150 kHz to 30 MHz was searched. Emission levels under (Limit – 20 dB) was not recorded.

Note: The resolution bandwidth and video bandwidth of test receiver is 9 kHz for quasi-peak detection (QP) and average detection (AV) at frequency 0.15 MHz – 30 MHz.

#### **Test Results**

Please refer to Appendix A.



# Appendix A: Test Results of Radiated Spurious Emissions & Mains

## Conducted Emission Test

### Band Edges, 2.31GHz ~ 2.9GHz

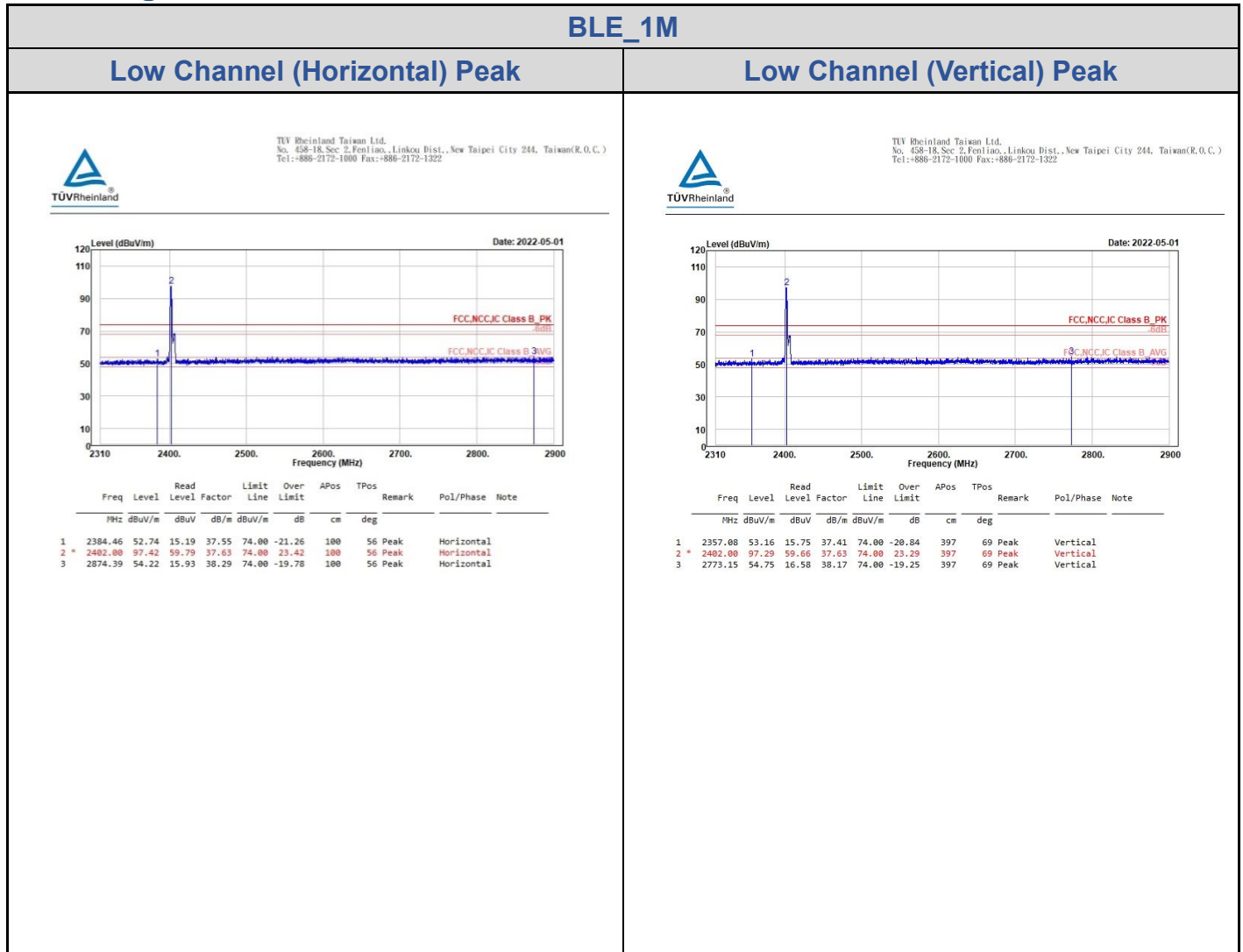

BLE\_1M

Low Channel (Horizontal) Average

Low Channel (Vertical) Average

TÜVRheinland  
TÜVRheinland Taiwan Ltd.  
No. 438-18, Sec 2, Fenliao, Linkou Dist., New Taipei City 244, Taiwan(R.O.C.)  
Tel: +886-2172-1000 Fax: +886-2172-1322

TÜVRheinland  
TÜVRheinland Taiwan Ltd.  
No. 438-18, Sec 2, Fenliao, Linkou Dist., New Taipei City 244, Taiwan(R.O.C.)  
Tel: +886-2172-1000 Fax: +886-2172-1322

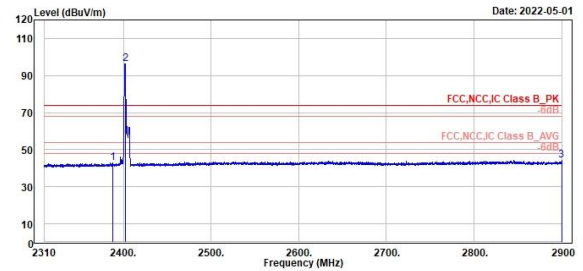
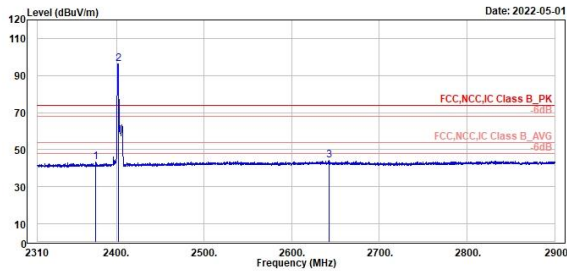

Freq	Level	Read	Limit	Over	APos	TPos	Remark	Pol/Phase	Note
MHz	dBuV/m	dBuV	dB/m	dBuV/m	dB	cm	deg		
1	2376.79	43.28	5.77	37.51	54.00	-10.72	100	56 Average	Horizontal
2 *	2402.00	96.36	58.73	37.63	54.00	42.36	100	56 Average	Horizontal
3	2642.29	44.12	6.10	38.02	54.00	-9.88	100	56 Average	Horizontal

Freq	Level	Read	Limit	Over	APos	TPos	Remark	Pol/Phase	Note
MHz	dBuV/m	dBuV	dB/m	dBuV/m	dB	cm	deg		
1	2388.12	42.90	5.33	37.57	54.00	-11.10	397	69 Average	Vertical
2 *	2402.00	96.25	58.62	37.63	54.00	42.25	397	69 Average	Vertical
3	2899.76	44.15	5.73	38.42	54.00	-9.85	397	69 Average	Vertical

BLE\_1M

High Channel (Horizontal) Peak

High Channel (Vertical) Peak

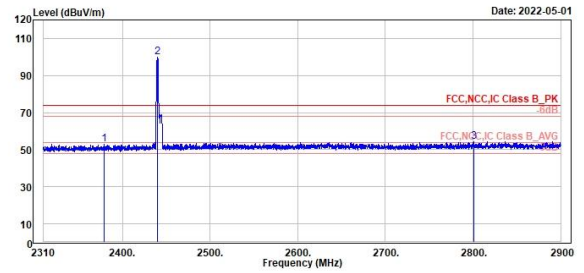
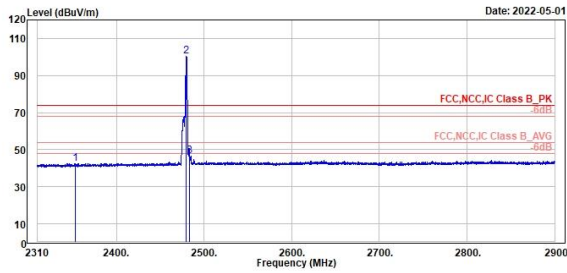

Freq	Level	Read	Level	Limit	Over	APos	TPos	Remark	Pol/Phase	Note
MHz	dBuV/m	dBuV	dB/m	dBuV/m	dB	cm	deg			
1	2353.07	42.49	5.10	37.39	54.00	-11.51	100	52 Average	Horizontal	
2 *	2480.00	100.30	62.51	37.79	54.00	46.30	100	52 Average	Horizontal	
3	2483.46	46.66	8.86	37.80	54.00	-7.34	100	52 Average	Horizontal	

Freq	Level	Read	Level	Limit	Over	APos	TPos	Remark	Pol/Phase	Note
MHz	dBuV/m	dBuV	dB/m	dBuV/m	dB	cm	deg			
1	2379.15	52.83	15.30	37.53	74.00	-21.17	375	119 Peak	Vertical	
2 *	2440.00	99.75	62.07	37.68	74.00	25.75	375	119 Peak	Vertical	
3	2801.12	54.28	16.07	38.21	74.00	-19.72	375	119 Peak	Vertical	

BLE\_1M

High Channel (Horizontal) Average

High Channel (Vertical) Average



TUV Rheinland Taiwan Ltd.  
No. 438-18, Sec 2, Fenliao, Linkou Dist., New Taipei City 244, Taiwan(R.O.C.)  
Tel: +886-2172-1000 Fax: +886-2172-1322

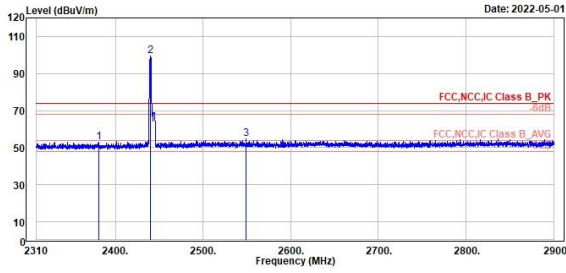

Freq	Level	Read	Level	Factor	Limit	Over	APos	TPos	Remark	Pol/Phase	Note
MHz	dBuV/m	dBuV	dB/m	dBuV/m	dB	dB	cm	deg			
1	2389.08	52.95	15.42	37.53	74.00	-21.05	100	52	Peak	Horizontal	
2 *	2440.00	99.41	61.73	37.68	74.00	25.41	100	52	Peak	Horizontal	
3	2549.07	54.59	16.68	37.91	74.00	-19.41	100	52	Peak	Horizontal	



TUV Rheinland Taiwan Ltd.  
No. 438-18, Sec 2, Fenliao, Linkou Dist., New Taipei City 244, Taiwan(R.O.C.)  
Tel: +886-2172-1000 Fax: +886-2172-1322

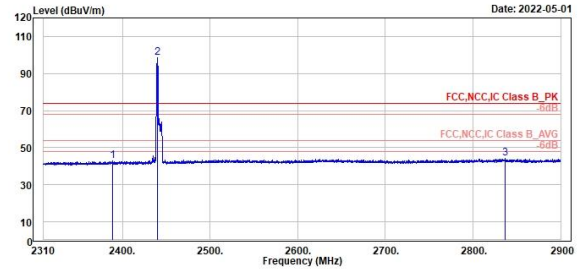

Freq	Level	Read	Level	Factor	Limit	Over	APos	TPos	Remark	Pol/Phase	Note
MHz	dBuV/m	dBuV	dB/m	dBuV/m	dB	dB	cm	deg			
1	2389.06	42.71	5.13	37.58	54.00	-11.29	375	119	Average	Vertical	
2 *	2440.00	98.74	61.06	37.68	54.00	44.74	375	119	Average	Vertical	
3	2836.16	44.42	6.24	38.18	54.00	-9.58	375	119	Average	Vertical	

Spurious Emissions, Tx Mode, 9kHz ~ 30MHz

BLE\_1M

High Channel (Open) 9kHz~150kHz

High Channel (Open) 150kHz~30MHz



TUV Rheinland Taiwan Ltd.  
No. 438-18, Sec. 2, Fenliao, Linkou Dist., New Taipei City 244, Taiwan(R.O.C.)  
Tel: +886-2172-1000 Fax: +886-2172-1322

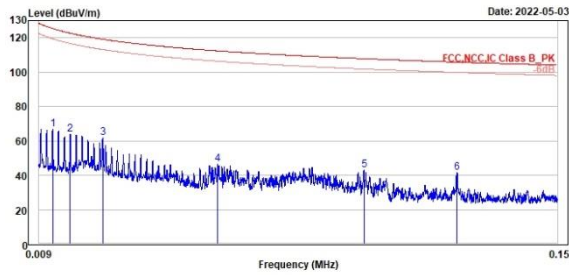

Peak	Freq (MHz)	Level (dBuV/m)	Read Level (dBuV)	Level Factor (dB/m)	Limit Line (dBuV/m)	Over Limit (dB)	APos (cm)	TPos (deg)	Remark	Pol/Phase	Note
1	0.01	66.68	48.72	17.96	125.45	-58.77	100	187	QP	Open	
2	0.02	63.62	45.23	18.39	122.68	-59.06	100	175	QP	Open	
3	0.03	61.78	42.59	19.19	119.16	-57.38	100	164	QP	Open	
4	0.06	46.40	27.26	19.14	112.38	-65.98	100	199	QP	Open	
5	0.10	43.00	24.72	18.28	107.82	-64.82	100	189	QP	Open	
6	0.12	41.49	23.19	18.30	105.82	-64.33	100	153	QP	Open	



TUV Rheinland Taiwan Ltd.  
No. 438-18, Sec. 2, Fenliao, Linkou Dist., New Taipei City 244, Taiwan(R.O.C.)  
Tel: +886-2172-1000 Fax: +886-2172-1322

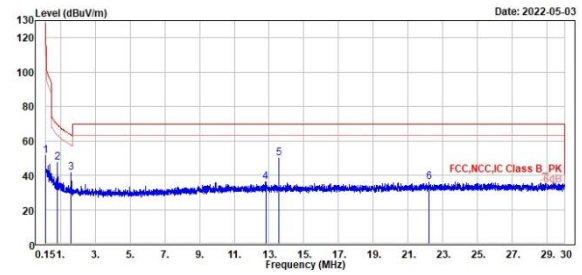

Peak	Freq (MHz)	Level (dBuV/m)	Read Level (dBuV)	Level Factor (dB/m)	Limit Line (dBuV/m)	Over Limit (dB)	APos (cm)	TPos (deg)	Remark	Pol/Phase	Note
1	0.15	51.48	33.08	18.40	104.88	-52.60	100	154	QP	Open	
2	0.81	47.26	28.12	19.14	69.47	-22.21	100	146	QP	Open	
3	1.62	41.53	22.18	19.35	63.42	-21.89	100	146	QP	Open	
4	12.81	36.22	14.52	21.70	69.50	-33.28	100	256	QP	Open	
5	13.56	49.87	28.12	21.75	69.50	-19.63	100	136	QP	Open	
6	22.21	35.86	13.56	22.30	69.50	-33.64	100	1	QP	Open	

BLE\_1M

High Channel (Close) 9kHz~150kHz

High Channel (Close) 150kHz~30MHz



TUV Rheinland Taiwan Ltd.  
No. 458-18, Sec 2, Fenliao, Linkou Dist., New Taipei City 244, Taiwan(R.O.C.)  
Tel: +886-2172-1000 Fax: +886-2172-1322

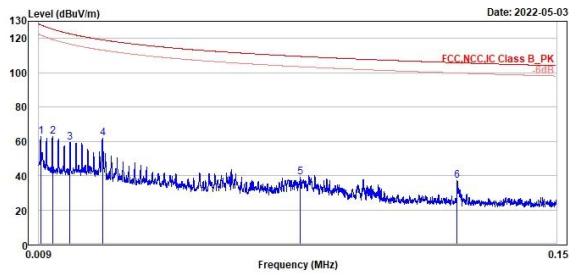

Freq	Level	Read	Limit	Over	APos	TPos	Remark	Pol/Phase	Note
MHz	dBuV/m	dBuV	dB/m	dBuV/m	dB	cm	deg		
1	0.01	62.79	44.96	17.83	127.95	-65.16	100	142 QP	Close
2	0.01	62.63	44.67	17.96	125.45	-62.82	100	136 QP	Close
3	0.02	59.16	40.77	18.39	122.68	-63.52	100	140 QP	Close
4	0.03	61.64	42.45	19.19	119.16	-57.52	100	48 QP	Close
5	0.08	39.03	20.39	18.64	109.51	-70.48	100	154 QP	Close
6	0.12	37.28	18.90	18.30	105.00	-68.52	100	99 QP	Close



TUV Rheinland Taiwan Ltd.  
No. 458-18, Sec 2, Fenliao, Linkou Dist., New Taipei City 244, Taiwan(R.O.C.)  
Tel: +886-2172-1000 Fax: +886-2172-1322

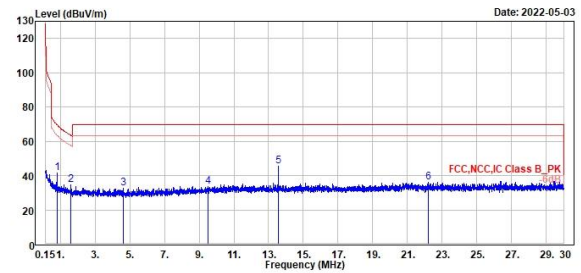

Freq	Level	Read	Limit	Over	APos	TPos	Remark	Pol/Phase	Note
MHz	dBuV/m	dBuV	dB/m	dBuV/m	dB	cm	deg		
1	0.01	41.44	22.30	19.14	69.47	-28.03	100	96 QP	Close
2	1.62	34.78	15.43	19.35	63.44	-28.66	100	96 QP	Close
3	4.63	32.52	13.12	19.40	69.50	-36.98	100	10 QP	Close
4	9.50	33.57	12.32	21.25	69.50	-35.93	100	167 QP	Close
5	13.56	45.68	23.93	21.75	69.50	-23.82	100	88 QP	Close
6	22.20	35.99	13.69	22.30	69.50	-33.51	100	207 QP	Close

Spurious Emissions, Tx Mode, 30MHz ~ 1GHz

BLE\_1M

High Channel (Horizontal)

High Channel (Vertical)



TÜV Rheinland Taiwan Ltd.  
No. 438-18, Sec. 2, Fenliao, Linkou Dist., New Taipei City 244, Taiwan(R.O.C.)  
Tel: +886-2172-1000 Fax: +886-2172-1322

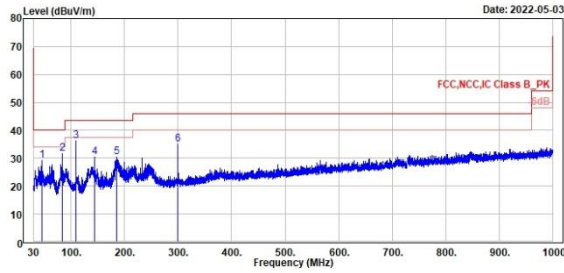

Freq	Level	Read	Limit	Over	APos	TPos	Remark	Pol/Phase	Note
MHz	dBuV/m	dBuV	dB/m	dBuV/m	dB	cm	deg		
1	45.62	29.15	35.12	-5.97	40.00	-10.85	200	75 QP	Horizontal
2	83.93	31.68	43.03	-11.35	40.00	-8.32	300	222 QP	Horizontal
3	108.47	36.29	46.02	-9.73	43.50	-7.21	300	92 QP	Horizontal
4	143.98	30.34	36.53	-6.19	43.50	-13.16	200	272 QP	Horizontal
5	185.59	30.28	38.33	-8.05	43.50	-13.22	100	91 QP	Horizontal
6	298.98	34.93	39.67	-4.74	46.00	-11.07	300	25 QP	Horizontal



TÜV Rheinland Taiwan Ltd.  
No. 438-18, Sec. 2, Fenliao, Linkou Dist., New Taipei City 244, Taiwan(R.O.C.)  
Tel: +886-2172-1000 Fax: +886-2172-1322

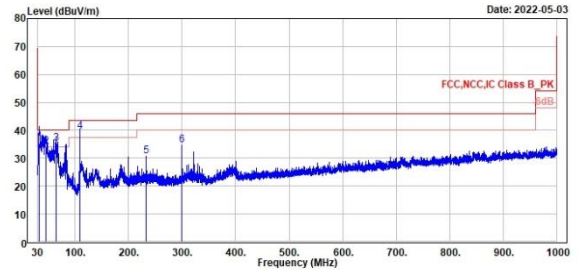

Freq	Level	Read	Limit	Over	APos	TPos	Remark	Pol/Phase	Note
MHz	dBuV/m	dBuV	dB/m	dBuV/m	dB	cm	deg		
1	33.30	35.30	42.73	-7.43	40.00	-4.70	100	141 QP	Vertical
2	45.42	34.00	39.99	-5.99	40.00	-6.00	152	111 QP	Vertical
3	64.73	35.39	43.27	-7.88	40.00	-4.61	100	40 QP	Vertical
4	108.47	39.55	49.28	-9.73	43.50	-3.95	100	175 QP	Vertical
5	233.22	30.76	37.73	-6.97	46.00	-15.24	100	104 QP	Vertical
6	298.85	34.64	39.36	-4.72	46.00	-11.36	100	357 QP	Vertical

**Spurious Emissions, Tx Mode, 1GHz ~ 26.5GHz**
**BLE\_1M**
**Low Channel (Horizontal)**
**Low Channel (Vertical)**

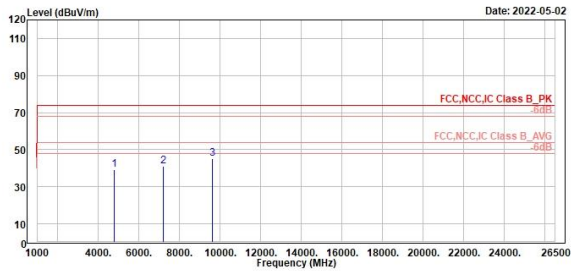

TÜV Rheinland Taiwan Ltd.  
 No. 438-18, Sec 2, Fenliao, Linkou Dist., New Taipei City 244, Taiwan(R.O.C.)  
 Tel: +886-2172-1000 Fax: +886-2172-1322



Freq	Level	Read	Limit	Over	Apos	TPos	Remark	Pol/Phase	Note
MHz	dBuV/m	dBuV	dB/m	dBuV/m	dB	cm	deg		
1	4804.00	39.21	49.08	-9.87	74.00	-34.79	180	275 Peak	Horizontal
2	7206.00	41.03	48.36	-7.33	74.00	-32.97	280	55 Peak	Horizontal
3	9608.00	45.26	50.16	-4.90	74.00	-28.74	480	150 Peak	Horizontal

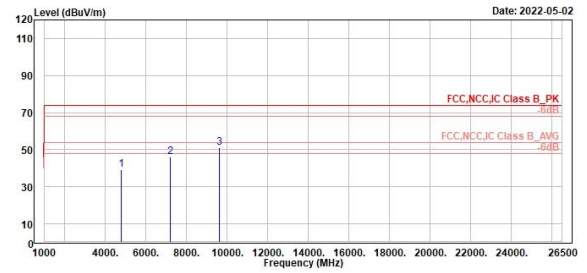

TÜV Rheinland Taiwan Ltd.  
 No. 438-18, Sec 2, Fenliao, Linkou Dist., New Taipei City 244, Taiwan(R.O.C.)  
 Tel: +886-2172-1000 Fax: +886-2172-1322



Freq	Level	Read	Limit	Over	Apos	TPos	Remark	Pol/Phase	Note
MHz	dBuV/m	dBuV	dB/m	dBuV/m	dB	cm	deg		
1	4804.00	39.37	49.24	-9.87	74.00	-34.63	480	118 Peak	Vertical
2	7206.00	45.99	53.32	-7.33	74.00	-28.01	280	153 Peak	Vertical
3	9608.00	50.96	55.86	-4.90	74.00	-23.04	380	279 Peak	Vertical



**BLE\_1M**
**Middle Channel (Horizontal)**
**Middle Channel (Vertical)**

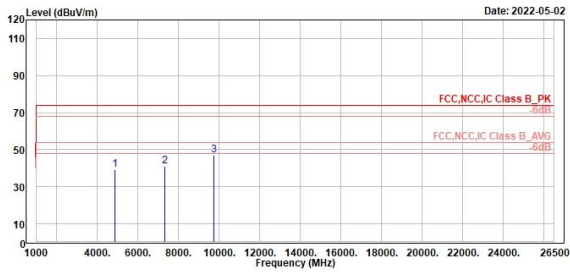

TÜV Rheinland Taiwan Ltd.  
 No. 438-18, Sec 2, Fenliao, Linkou Dist., New Taipei City 244, Taiwan(R.O.C.)  
 Tel: +886-2172-1000 Fax: +886-2172-1322



Freq	Level	Read Level	Factor	Limit Line	Over Limit	APos	TPos	Remark	Pol/Phase	Note
MHz	dBuV/m	dBuV	dB/m	dBuV/m	dB	cm	deg			
1	4880.00	39.38	49.17	-9.79	74.00	-34.62	200	320 Peak	Horizontal	
2	7320.00	40.88	48.37	-7.49	74.00	-33.12	400	217 Peak	Horizontal	
3	9760.00	47.07	51.77	-4.70	74.00	-26.93	100	255 Peak	Horizontal	

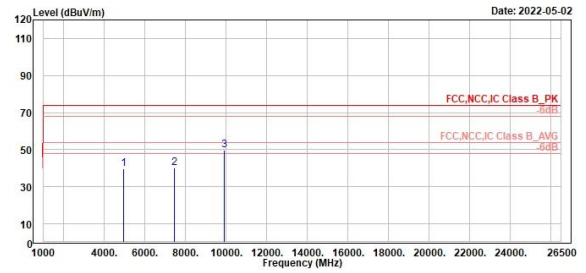

TÜV Rheinland Taiwan Ltd.  
 No. 438-18, Sec 2, Fenliao, Linkou Dist., New Taipei City 244, Taiwan(R.O.C.)  
 Tel: +886-2172-1000 Fax: +886-2172-1322



Freq	Level	Read Level	Factor	Limit Line	Over Limit	APos	TPos	Remark	Pol/Phase	Note
MHz	dBuV/m	dBuV	dB/m	dBuV/m	dB	cm	deg			
1	4960.00	39.48	49.02	-9.54	74.00	-34.52	200	198 Peak	Vertical	
2	7440.00	40.04	47.39	-7.35	74.00	-33.96	400	51 Peak	Vertical	
3	9920.00	49.81	54.16	-4.35	74.00	-24.19	300	273 Peak	Vertical	

BLE\_1M

High Channel (Horizontal)

High Channel (Vertical)



TÜV Rheinland Taiwan Ltd.  
No. 438-18, Sec. 2, Fenliao, Linkou Dist., New Taipei City 244, Taiwan(R.O.C.)  
Tel: +886-2172-1000 Fax: +886-2172-1322



TÜV Rheinland Taiwan Ltd.  
No. 438-18, Sec. 2, Fenliao, Linkou Dist., New Taipei City 244, Taiwan(R.O.C.)  
Tel: +886-2172-1000 Fax: +886-2172-1322

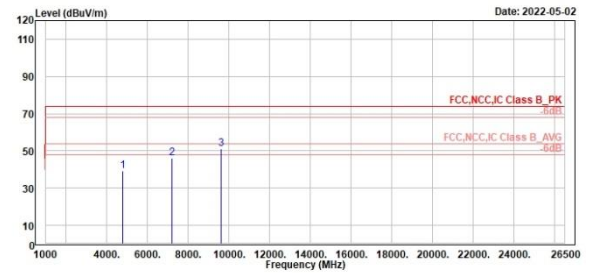
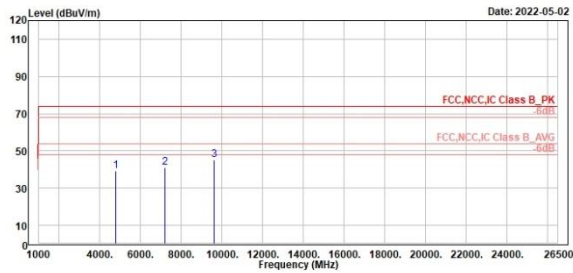

Peak	Freq	Level	Read Level	Factor	Limit Line	Over Limit	APos	TPos	Remark	Pol/Phase	Note
	MHz	dBuV/m	dBuV	dB/m	dBuV/m	dB	cm	deg			
1	4894.00	39.21	49.08	-9.87	74.00	-34.79	100	275	Peak	Horizontal	
2	7286.00	41.03	48.36	-7.33	74.00	-32.97	200	55	Peak	Horizontal	
3	9608.00	45.26	50.16	-4.90	74.00	-28.74	400	150	Peak	Horizontal	

Peak	Freq	Level	Read Level	Factor	Limit Line	Over Limit	APos	TPos	Remark	Pol/Phase	Note
	MHz	dBuV/m	dBuV	dB/m	dBuV/m	dB	cm	deg			
1	4894.00	39.37	49.24	-9.87	74.00	-34.63	400	118	Peak	Vertical	
2	7286.00	45.99	53.32	-7.33	74.00	-28.01	200	153	Peak	Vertical	
3	9608.00	50.96	55.86	-4.90	74.00	-23.04	300	279	Peak	Vertical	

Mains Conducted Emission, 150kHz ~ 30MHz

Worst Band

(Line)

(Neutral)



TUV Rheinland Taiwan Ltd.  
No. 458-18, Sec. 2, Fenhiao, Linkou Dist., New Taipei City 244, Taiwan(R.O.C.)  
Tel: +886-2112-1000 Fax: +886-2112-1322

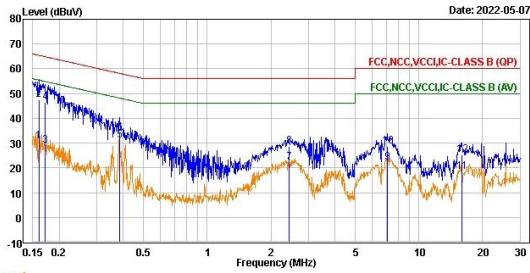

Trace: 1

Line	Freq	Level	Read Level	Factor	Limit	Over	Remark	Pol/Phase	Note
	MHz	dBuV	dBuV	dB	dBuV	dB			
1	0.16	30.85	21.24	9.61	55.46	-24.61	Average	line1	
2	0.16	47.45	37.84	9.61	65.46	-18.01	QP	line1	
3	0.17	29.11	19.50	9.61	54.92	-25.81	Average	line1	
4	0.17	46.32	36.71	9.61	64.92	-18.60	QP	line1	
5	0.39	31.07	21.45	9.62	48.13	-17.06	Average	line1	
6	0.39	34.25	24.63	9.62	58.13	-23.88	QP	line1	
7	2.43	22.17	12.52	9.65	46.00	-23.83	Average	line1	
8	2.43	28.62	18.97	9.65	56.00	-27.38	QP	line1	
9	7.07	22.15	12.44	9.71	50.00	-27.85	Average	line1	
10	7.07	28.51	18.80	9.71	60.00	-31.45	QP	line1	
11	15.93	18.29	8.56	9.73	50.00	-31.71	Average	line1	
12	15.93	25.14	15.41	9.73	60.00	-34.86	QP	line1	



TUV Rheinland Taiwan Ltd.  
No. 458-18, Sec. 2, Fenhiao, Linkou Dist., New Taipei City 244, Taiwan(R.O.C.)  
Tel: +886-2112-1000 Fax: +886-2112-1322

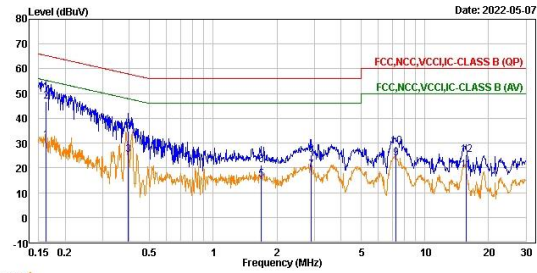

Trace: 1

Line	Freq	Level	Read Level	Factor	Limit	Over	Remark	Pol/Phase	Note
	MHz	dBuV	dBuV	dB	dBuV	dB			
1	0.16	30.96	21.37	9.59	55.38	-24.42	Average	neutral	
2	0.16	46.83	37.24	9.59	65.38	-18.55	QP	neutral	
3	0.40	25.35	15.75	9.60	47.99	-22.58	Average	neutral	
4	0.40	34.78	25.18	9.60	57.99	-23.15	QP	neutral	
5	1.68	15.21	5.59	9.62	46.00	-30.79	Average	neutral	
6	1.68	21.04	11.42	9.62	56.00	-34.96	QP	neutral	
7	2.90	18.96	9.21	9.65	46.00	-27.04	Average	neutral	
8	2.90	25.28	15.63	9.65	56.00	-30.72	QP	neutral	
9	7.28	23.82	14.11	9.71	50.00	-26.18	Average	neutral	
10	7.28	28.55	18.84	9.71	60.00	-31.45	QP	neutral	
11	15.62	18.95	9.17	9.78	50.00	-31.05	Average	neutral	
12	15.62	25.21	15.43	9.78	60.00	-34.79	QP	neutral	