



<b>Prüfbericht-Nr.:</b> <i>Test Report No.:</i>	50141822 001	<b>Auftrags-Nr.:</b> <i>Order No.:</i>	114074446	Seite 1 von 44 <i>Page 1 of 44</i>	
<b>Kunden-Referenz-Nr.:</b> <i>Client Reference No.:</i>	N/A	<b>Auftragsdatum:</b> <i>Order date:</i>	12-Feb-2018		
<b>Auftraggeber:</b> <i>Client:</i>	Microchip Technology Inc. 2355 West Chandler Blvd. Chandler, Arizona 85224-6199, United States.				
<b>Prüfgegenstand:</b> <i>Test item:</i>	IEEE 802.11 b/g/n Link Controller Module With Integrated Bluetooth				
<b>Bezeichnung / Typ-Nr.:</b> <i>Identification / Type No.:</i>	ATWILC3000-MR110UA				
<b>Auftrags-Inhalt:</b> <i>Order content:</i>	FCC Part 15C / IC RSS-247 Test report (BLE)				
<b>Prüfgrundlage:</b> <i>Test specification:</i>	FCC 47CFR Part 15: Subpart C Section 15.247(DTS) RSS-247 (02-2017)				
<b>Wareneingangsdatum:</b> <i>Date of receipt:</i>	14-Feb-2018				
<b>Prüfmuster-Nr.:</b> <i>Test sample No.:</i>	A000698723-002 A000698723-003				
<b>Prüfzeitraum:</b> <i>Testing period:</i>	08-Mar-2018 - 20-Apr-2018				
<b>Ort der Prüfung:</b> <i>Place of testing:</i>	EMC/RF Laboratory Taipei				
<b>Prüflaboratorium:</b> <i>Testing laboratory:</i>	TUV Rheinland Taiwan Ltd.				
<b>Prüfergebnis*:</b> <i>Test result*:</i>	Pass				
<b>Report date / tested by:</b>			<b>kontrolliert von / reviewed by:</b>		
16-May-2018	Jack Chang/Project Manager		16-May-2018	Arvin Ho/Vice General Manager	
<b>Datum</b> <i>Date</i>	<b>Name / Stellung</b> <i>Name / Position</i>	<b>Unterschrift</b> <i>Signature</i>	<b>Datum</b> <i>Date</i>	<b>Name / Stellung</b> <i>Name / Position</i>	<b>Unterschrift</b> <i>Signature</i>
<b>Sonstiges / Other:</b>					
<b>Zustand des Prüfgegenstandes bei Anlieferung:</b> <i>Condition of the test item at delivery:</i>			Prüfmuster vollständig und unbeschädigt <i>Test item complete and undamaged</i>		
* Legende: 1 = sehr gut    2 = gut    3 = befriedigend    4 = ausreichend    5 = mangelhaft P(ass) = entspricht o.g. Prüfgrundlage(n)    F(ail) = entspricht nicht o.g. Prüfgrundlage(n)    N/A = nicht anwendbar    N/T = nicht getestet					
Legend: 1 = very good    2 = good    3 = satisfactory    4 = sufficient    5 = poor P(ass) = passed a.m. test specification(s)    F(ail) = failed a.m. test specification(s)    N/A = not applicable    N/T = not tested					
<b>Dieser Prüfbericht bezieht sich nur auf das o.g. Prüfmuster und darf ohne Genehmigung der Prüfstelle nicht auszugsweise vervielfältigt werden. Dieser Bericht berechtigt nicht zur Verwendung eines Prüfzeichens.</b> <i>This test report only relates to the a. m. test sample. Without permission of the test center this test report is not permitted to be duplicated in extracts. This test report does not entitle to carry any test mark.</i>					

## TEST SUMMARY

**5.1.1 ANTENNA REQUIREMENT***RESULT: Passed***5.1.2 PEAK OUTPUT POWER***RESULT: Passed***5.1.3 6dB BANDWIDTH AND 99% BANDWIDTH***RESULT: Passed***5.1.4 POWER DENSITY***RESULT: Passed***5.1.5 CONDUCTED SPURIOUS EMISSIONS AND FREQUENCY BAND EDGE MEASURED IN 100kHz BANDWIDTH***RESULT: Passed***5.1.6 SPURIOUS EMISSION***RESULT: Passed***5.1.7 MAINS CONDUCTED EMISSIONS***RESULT: Passed***6.1.1 ELECTROMAGNETIC FIELDS***RESULT: Passed*

## Contents

<b>1.</b>	<b>GENERAL REMARKS .....</b>	<b>5</b>
<b>1.1</b>	<b>COMPLEMENTARY MATERIALS.....</b>	<b>5</b>
<b>2.</b>	<b>TEST SITES .....</b>	<b>6</b>
<b>2.1</b>	<b>TEST LABORATORY .....</b>	<b>6</b>
<b>2.2</b>	<b>TEST FACILITY.....</b>	<b>6</b>
<b>2.3</b>	<b>LIST OF TEST AND MEASUREMENT INSTRUMENTS.....</b>	<b>7</b>
<b>2.4</b>	<b>TRACEABILITY .....</b>	<b>8</b>
<b>2.5</b>	<b>CALIBRATION .....</b>	<b>8</b>
<b>2.6</b>	<b>MEASUREMENT UNCERTAINTY .....</b>	<b>8</b>
<b>3.</b>	<b>GENERAL PRODUCT INFORMATION.....</b>	<b>9</b>
<b>3.1</b>	<b>PRODUCT FUNCTION AND INTENDED USE .....</b>	<b>9</b>
<b>3.2</b>	<b>SYSTEM DETAILS AND RATINGS.....</b>	<b>9</b>
<b>3.3</b>	<b>INDEPENDENT OPERATION MODES.....</b>	<b>11</b>
<b>3.4</b>	<b>NOISE GENERATING AND NOISE SUPPRESSING PARTS .....</b>	<b>11</b>
<b>3.5</b>	<b>SUBMITTED DOCUMENTS.....</b>	<b>11</b>
<b>4.</b>	<b>TEST SET-UP AND OPERATION MODES.....</b>	<b>12</b>
<b>4.1</b>	<b>PRINCIPLE OF CONFIGURATION SELECTION .....</b>	<b>12</b>
<b>4.2</b>	<b>TEST OPERATION AND TEST SOFTWARE.....</b>	<b>12</b>
<b>4.3</b>	<b>SPECIAL ACCESSORIES AND AUXILIARY EQUIPMENT .....</b>	<b>12</b>
<b>4.4</b>	<b>COUNTERMEASURES TO ACHIEVE EMC COMPLIANCE.....</b>	<b>13</b>
<b>4.5</b>	<b>TEST SETUP DIAGRAM .....</b>	<b>13</b>
<b>5.</b>	<b>TEST RESULTS .....</b>	<b>15</b>
<b>5.1</b>	<b>TRANSMITTER REQUIREMENT &amp; TEST SUITES .....</b>	<b>15</b>
<b>5.1.1</b>	<i>Antenna Requirement .....</i>	<i>15</i>
<b>5.1.2</b>	<i>Peak Output Power.....</i>	<i>16</i>
<b>5.1.3</b>	<i>6dB Bandwidth and 99% Bandwidth.....</i>	<i>17</i>
<b>5.1.4</b>	<i>Power Density.....</i>	<i>22</i>
<b>5.1.5</b>	<i>Conducted spurious emissions and Frequency Band Edge measured in 100kHz Bandwidth.....</i>	<i>25</i>
<b>5.1.6</b>	<i>Spurious Emission .....</i>	<i>29</i>
<b>5.1.7</b>	<i>Mains Conducted Emissions.....</i>	<i>30</i>
<b>6.</b>	<b>SAFETY HUMAN EXPOSURE .....</b>	<b>31</b>
<b>6.1</b>	<b>RADIO FREQUENCY EXPOSURE COMPLIANCE .....</b>	<b>31</b>
<b>6.1.1</b>	<i>Electromagnetic Fields.....</i>	<i>31</i>

<b>7.</b>	<b>PHOTOGRAPHS OF THE TEST SET-UP.....</b>	<b>32</b>
<b>8.</b>	<b>LIST OF TABLES .....</b>	<b>44</b>
<b>9.</b>	<b>LIST OF PHOTOGRAPHS.....</b>	<b>44</b>

## 1. General Remarks

### 1.1 Complementary Materials

The following attachments are integral parts of this test report:

**Appendix P: Photo Documentation internal view**  
(File Name: 50141822APPENDIXP)

**Appendix D: Test Result of Radiated Emissions**  
(File Name: 50141822APPENDIXD)

Test Specifications

The following standards were applied.

**Table 1: Applied Standard and Test Levels**

<b>Radio</b>
FCC 47CFR Part 15: Subpart C Section 15.247
FCC 47CFR Part 2: Subpart J Section 2.1091
RSS-247 Issue 2 (Feb 2017)
RSS-102 Issue 5
RSS-Gen, Issue 5, April 2018
ANSI C63.10:2013
KDB558074 D01 DTS Meas Guidance v03r05
KDB447498 D01 General RF Exposure Guidance v06

## 2. Test Sites

### 2.1 Test Laboratory

TUV Rheinland Taiwan Ltd.  
Taichung Branch Office

No.9, Lane 36, Minsheng Rd., Sec. 3, Daya District,  
Taichung City 428  
Taiwan (R.O.C.)

### 2.2 Test Facility

TUV Rheinland Taiwan Ltd.  
Taipei Office

11F. No.758, Sec. 4, Bade Rd., Songshan Dist.  
Taipei City 105  
Taiwan (R.O.C.)

FCC RegistrationNo.: 340738  
IC Canada Registration No.: 9465A-1  
TAF Accredited NCC Test Lab. No.:0759  
TAF ISO17025 Certification effective period: 2016-Jul-1st to 2019-Jun-30th



**Testing Laboratory**  
**0759**

## 2.3 List of Test and Measurement Instruments

**Table 2: List of Test and Measurement Equipment**

Kind of Equipment	Manu-facturer	Type	S/N	Last Calibration	Next Calibration
Test Software	Farad	EZ_EMCC	Ver. TUV3A1	N/A	N/A
EMI Test Receiver	R&S	ESCI 7	101549	2017/11/10	2018/11/10
Spectrum Analyzer	R&S	FSV 40	100921	2017/05/02	2018/05/01
Spectrum Analyzer	Agilent	N9010A	MY53470241	2017/05/23	2018/05/22
Preamplifier (30MHz -1GHz)	HP	8447F	2805A03335	2017/08/14	2018/08/14
Preamplifier (18 GHz -40 GHz)	COM-POWER	PAM-840	461257	2018/01/18	2019/01/18
Pre-Amplifier (1GHz~18GHz)	EM Electronics	EM01G18G	60558	2017/11/21	2018/11/21
Bilog Antenna	TESEQ	CBL6111D	29804	2017/08/18	2018/08/18
Horn Antenna	ETS-Lindgren	3117	201918	2017/08/18	2018/08/18
Horn Antenna (18GHz~40GHz)	COM-POWER	AH-840	101031	2017/11/28	2018/11/28
Temp. & Humid. Chamber	Giant Force	GCT-099-40-S	MAF0103-007	2017/03/09	2019/03/09
Loop Antenna	Schwarzbeck	FMZB 1513	1513-076	2017/06/14	2018/06/14
LISN (1 phase)	R&S	ENV216	101243	2017/06/18	2018/06/18
LISN	R&S	ENV216	101262	2017/06/22	2018/06/21
Test Software	Audix	e3	Ver. 9	N/A	N/A
Test Software	Agilent	300328 testsystem	V1.9.1	N/A	N/A
Power sensor	Agilent	U2021XA	MY54020001	2017/03/08	2018/05/30

## 2.4 Traceability

All measurement equipment calibrations are traceable to NML(Taiwan)/NIST(USA) or where calibration is performed outside Taiwan, to equivalent nationally recognized standards organizations.

## 2.5 Calibration

Equipment requiring calibration is calibrated periodically in a suitably accredited Calibration Lab. Additionally all equipment is verified for proper performance on a regular schedule using in house standards or comparisons.

## 2.6 Measurement Uncertainty

The estimated combined standard uncertainty for radiated emissions and conducted emissions measurements .

**Table 3: Emission Measurement Uncertainty**

Parameter	Uncertainty
Radio Frequency	$\pm 1 \times 10^{-7}$
RF power, conducted	$\pm 1.5$ dB
RF power density, conducted	$\pm 3$ dB
spurious emissions, conducted	$\pm 3$ dB
all emissions, radiated	$\pm 6$ dB
Temperature	$\pm 1$ °C
Humidity	$\pm 5$ %
DC and low frequency voltages	$\pm 3$ %



## 3. General Product Information

### 3.1 Product Function and Intended Use

The EUT is an IEEE 802.11 b/g/n Link Controller Module With Integrated Bluetooth . The Module has RF Shield and u.FL connector for External Antenna(s).

For details refer to the User Guide, Data Sheet and Circuit Diagram.

### 3.2 System Details and Ratings

**Table 4: Basic Information of EUT**

Item	EUT information
Kind of Equipment/Test Item	IEEE 802.11 b/g/n Link Controller Module With Integrated Bluetooth
Type Designation	ATWILC3000-MR110UA
FCC ID	2ADHKWILC3000U
IC ID	20266-WILC3000UA
HVIN	ATWILC3000-MR110UA

**Table 5: Technical Specification of EUT**

Technical Specification	Value
Operating Frequencies	2402~2480MHz
Channel number	40
Operation Voltage	2.5V to 4.2V (Typical = 3.3V)
Modulation	GFSK
Antenna gain	Refer external antenna list

**Table 6: External Antenna list**
**Antennas no. 4,6 and 9 selected for testing as worst case antennas**

S/no.	P/N	Vendor	Antenna Gain @ 2.4GHz Band	Antenna type	Remarks
1	W3525B039	Pulse Electronics Corporation	2 dBi	PCB	Cable length 100mm
2	RN-SMA-4	Microchip	2.2 dBi	Dipole	
3	RFDP A870920IMLB301	WALSIN	1.84 dBi	Dipole-DB	Dual Band
4	RFMTA331215IMAB701	WALSIN	3.8 dBi	Metal Stamp	Cable length 150mm
5	RFMTA331240IMAB701	WALSIN	3.0 dBi	Metal Stamp	Antenna same as S/No.4, cable length 400 mm
6	RFPCA381013IMAB701	WALSIN	4.50 dBi	PCB	Cable length 130mm
7	RFPCA381035IMAB701	WALSIN	2.7 dBi	PCB	Antenna same as S/No.6, cable length 350mm
8	RFA-02-3-C5H1	Aristotle	3 dBi	Dipole	
9	RFA-02-5-C7H1	Aristotle	5 dBi	Dipole-Long	
10	RFA-02-P33	Aristotle	2 dBi	PCB	Cable length 150mm
11	1461530100	Molex	3 dBi	PCB/Flexi	Cable length 100mm Dual Band
12	RN-SMA-S	Microchip	0.56 dBi	Dipole-short	
13	RN-SMA-7	Microchip	5 dBi	Dipole-Long	
14	RFA-02-5-F7H1	Aristotle	5 dBi	Dipole-Long	
15	RFA-02-D3	Aristotle	2 dBi	Dipole-no encl.	
16	RFA-02-G03	Aristotle	2 dBi	Metal Stamp	Cable length 150mm
17	RFA-02-L2H1	Aristotle	2 dBi	Dipole	
18	RFA-02-P05	Aristotle	2 dBi	PCB	Cable length 150mm
19	RFA-02-C2M2	Aristotle	2 dBi	Dipole	

### **3.3 Independent Operation Modes**

Basic operation modes are:

- A. Transmitting
  - 1. Low channel
  - 2. Middle channel
  - 3. High channel
- B. Receiving
- C. Standby
- D. Off

### **3.4 Noise Generating and Noise Suppressing Parts**

Refer to the Circuit Diagram.

### **3.5 Submitted Documents**

- Circuit Diagram
- Blocking Diagram
- Rating Label
- Technical Description

## 4. Test Set-up and Operation Modes

### 4.1 Principle of Configuration Selection

The equipment under test (EUT) was configured to measure its maximum power level. The test modes were adapted accordingly in reference to the instructions for use.

### 4.2 Test Operation and Test Software

Setup for testing: Test samples are provided with an I2C to USB Adaptor and UART Interface which makes it possible to control them through the test software installed on a notebook computer.

This software was running on the laptop computer connected to the EUT. It was used to enable the operation modes listed in section 3.3 as appropriate.

The samples were used as follows:

Conducted: A000698723-002

Radiation: A000698723-003

Full test was applied on all test modes, but only worst case was shown

BLE mode:

Channel Low (2402MHz), Channel Mid (2440MHz) and Channel High (2480MHz) were chosen for full testing.

### 4.3 Special Accessories and Auxiliary Equipment

The product has been tested together with the following additional accessories:

Description	Manufacturer	Model No.	Serial No.
Notebook(EMC-06)	Lenovo	TP00048A	PB-0F8B2
Test tool	Microchip	WILC3000/WINC3400 rev7189	N/A

## 4.4 Countermeasures to achieve EMC Compliance

The test sample which has been tested contained the noise suppression parts as described in the Constructional Data Form or the Technical Construction File. No additional measures were employed to achieve compliance.

## 4.5 Test Setup Diagram

**Diagram of Measurement Configuration for Radiation Test**

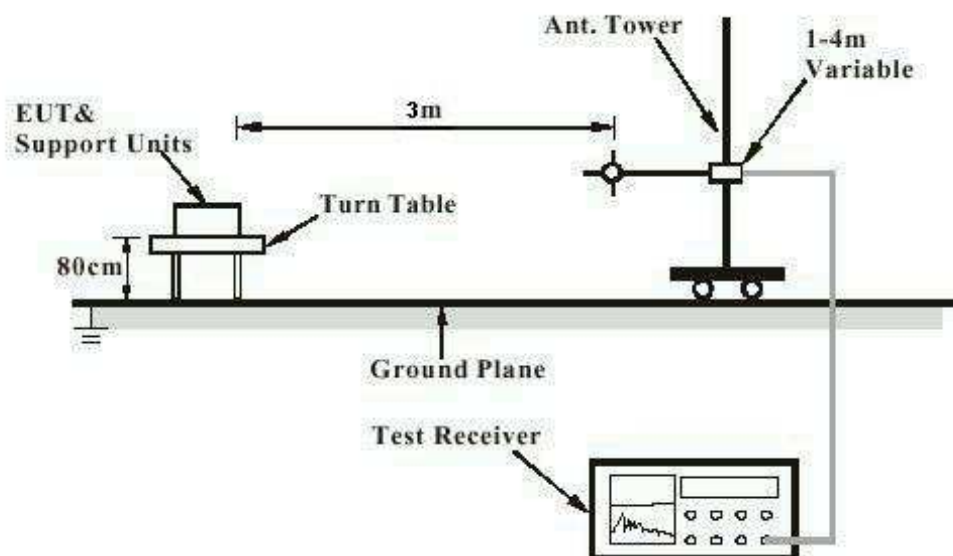

Note: Measurements above 1 GHz are done with a table height of 1.5m

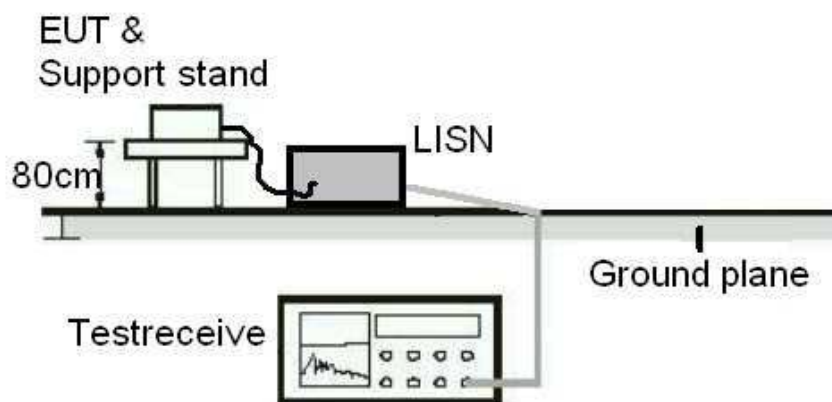
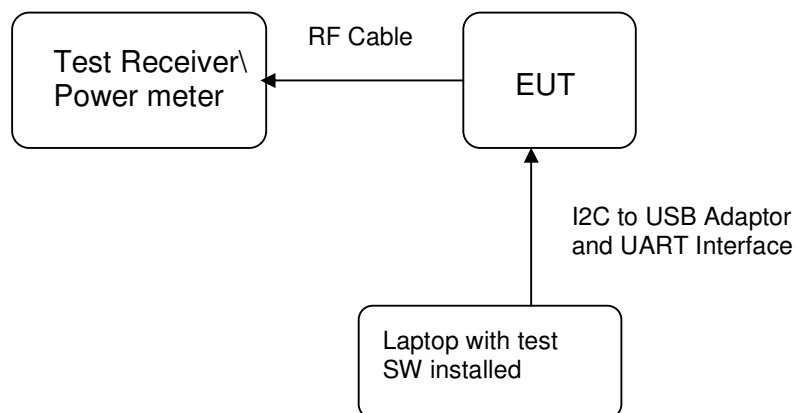
**Diagram of Measurement Equipment Configuration for Mains Conduction Measurement (if applicable)**

**Diagram of Measurement Equipment Configuration for Conducted Transmitter Measurement**

## 5. Test Results

### 5.1 Transmitter Requirement & Test Suites

#### 5.1.1 Antenna Requirement

**RESULT:** **Passed**

Test standard	:	LP0002(2016): 2.2, 3.10.1, (3) FCC Part 15.247(b)(4), Part 15.203 and RSS- Gen 8.3
Requirement	:	use of approved antennas only with directional gains that do not exceed 6 dBi

According to the manufacturer declaration, the EUT has an antenna with Max directional gain of 5dBi (refer External Antenna List). The antenna is connected through a proprietary connector with no possibility of replacement with a non-approved antenna by the end-user. Therefore, the EUT is considered to comply with this provision.

Refer to EUT photo for details.

## 5.1.2 Peak Output Power

**RESULT:**
**Passed**

Test standard : LP0002(2016): 3.10.1, (2)  
 FCC Part 15.247(b)(3), RSS-247 5.4(4)  
 Basic standard : ANSI C63.10:2013, KDB558074  
 Limit : 1 Watt  
 Kind of test site : Shielded room

**Test setup**

Test Channel : Low/ Middle/ High  
 Operation Mode : A  
  
 Ambient temperature : 20-24 °C  
 Relative humidity : 50-65 %  
 Atmospheric pressure : 100-103 kPa

**Table 7: Test result of Peak Output Power**

Channel	Channel Frequency (MHz)	Output Power		Limit (W)	Power Setting PPA, PA, DG
		(dBm)	(W)		
Low Channel	2402	6.54	0.00451	1	6, 6, -5
Middle Channel	2440	6.68	0.00466	1	6, 6, -5
High Channel	2480	6.69	0.00467	1	6, 6, -5

Pmax: 4.6666 mW



### 5.1.3 6dB Bandwidth and 99% Bandwidth

**RESULT:**
**Passed**

Test standard : LP0002(2016): 3.10.1, (5)  
 FCC Part 15.247(a)(2), RSS-247 5.2(1)  
 RSS-Gen (Issue 5)  
 Basic standard : ANSI C63.10:2013, KDB558074  
 Kind of test site : Shielded room

**Test setup**

Test Channel : Low/ Middle/ High  
 Operation Mode : A  
  
 Ambient temperature : 20-24°C  
 Relative humidity : 50-65%  
 Atmospheric pressure : 100-103 kPa

**Table 8: Test result of 6dB Bandwidth**

Channel	Channel Frequency (MHz)	6dB Bandwidth (kHz)	Limit (kHz)	Result
Low Channel	2402	647.4	>500	Pass
Mid Channel	2440	647.4	>500	Pass
High Channel	2480	644.4	>500	Pass

**Table 9: Test result of 99% Bandwidth,**

Channel	Channel Frequency (MHz)	99% Bandwidth (MHz)
Low Channel	2402	1.0129
Mid Channel	2440	1.0129
High Channel	2480	1.0099

## Test Plot of 6dB Bandwidth

### Low Channel

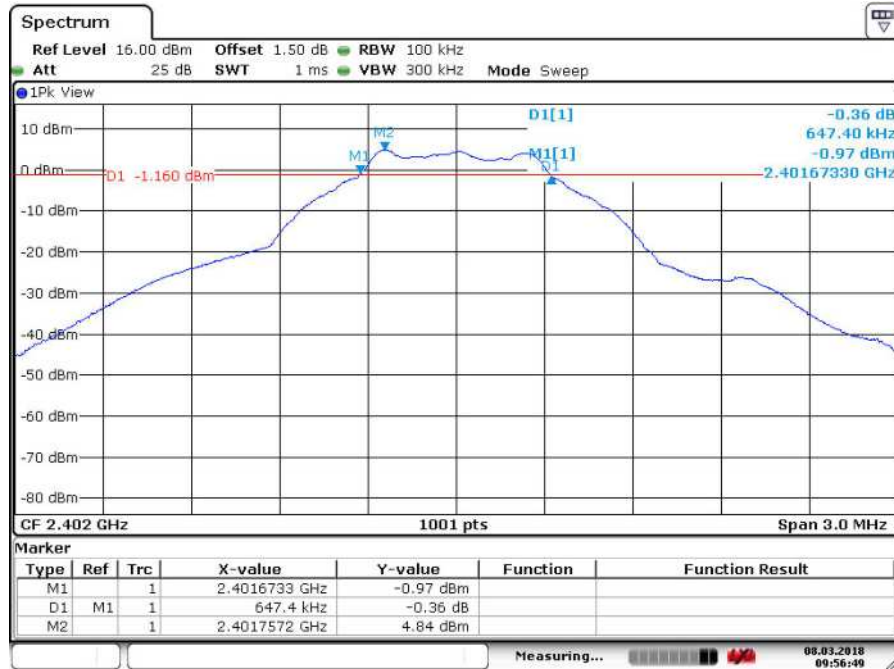

Date: 8 MAR 2018 09:56:49

### Middle Channel

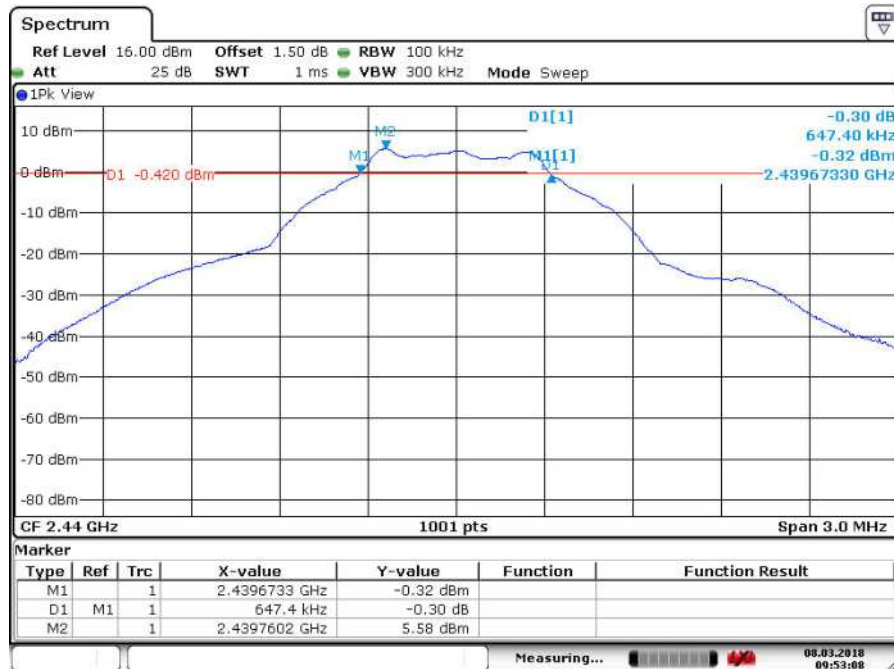

Date: 8 MAR 2018 09:53:08

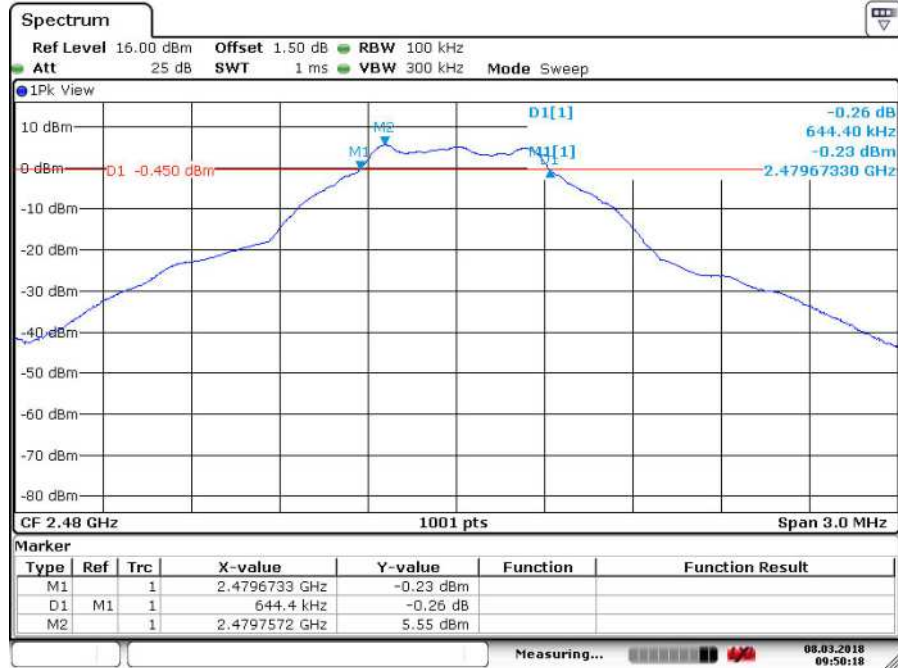
**High Channel**

Date: 8.MAR.2018 09:50:18

## Test Plot of 99% Bandwidth

### Low Channel

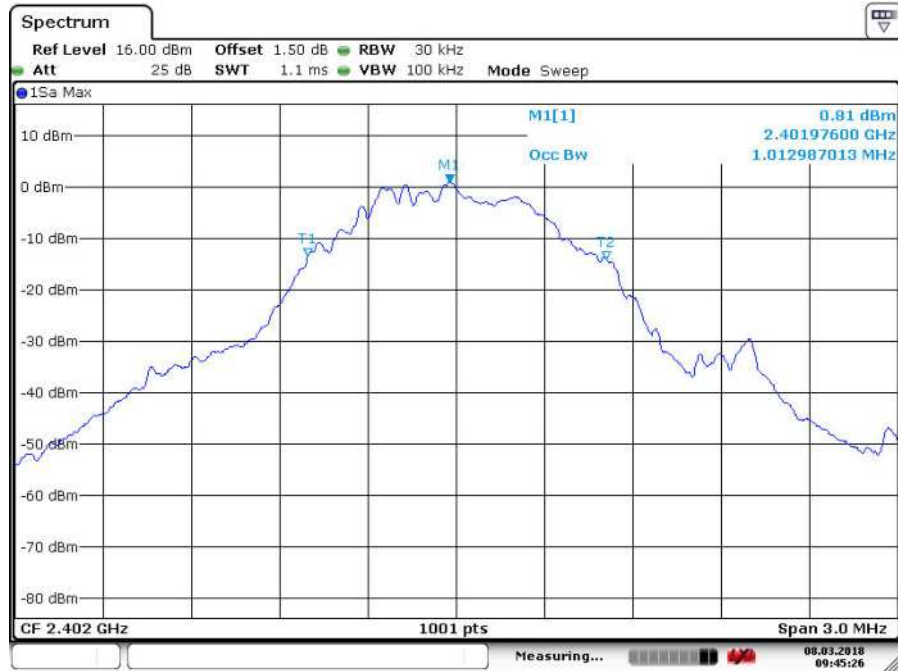

Date: 8 MAR 2018 09:45:26

### Middle Channel

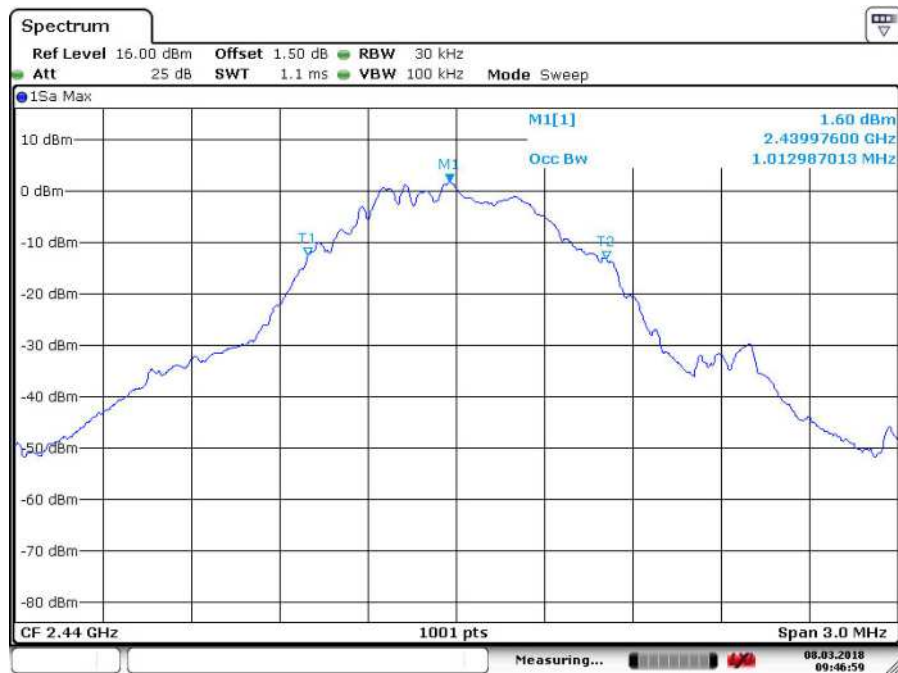

Date: 8 MAR 2018 09:47:00

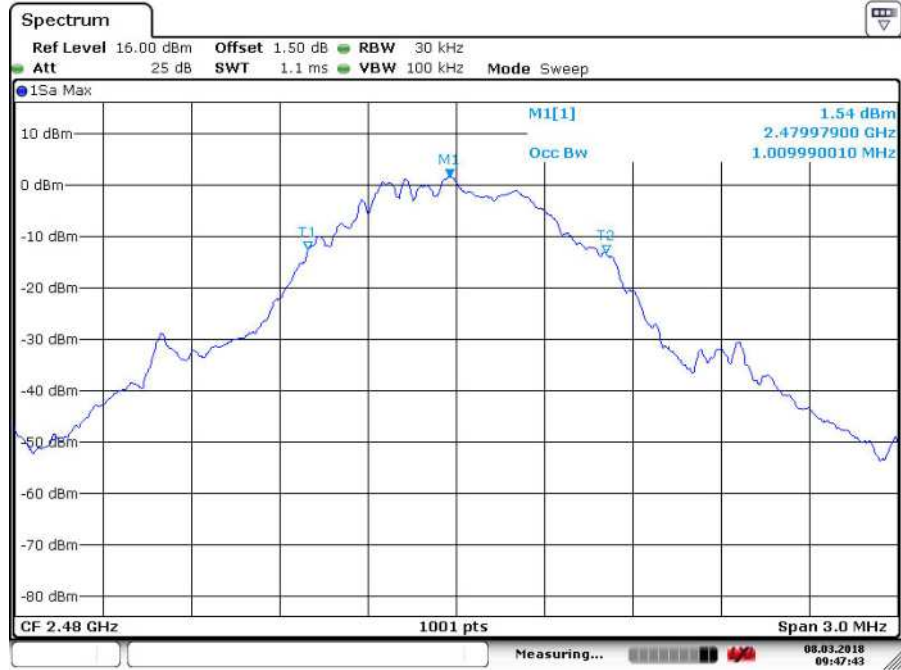
**High Channel**

Date: 8 MAR 2018 09:47:44

### 5.1.4 Power Density

**RESULT:****Passed**

Test standard : LP0002(2016): 3.10.1, (6.2.2)  
FCC Part 15.247(e) , RSS-247 5.2(2)  
Basic standard : ANSI C63.10:2013, KDB558074  
Kind of test site : Shielded room

**Test setup**

Test Channel : Low/ Middle/ High  
Operation Mode : A  
Ambient temperature : 20-24°C  
Relative humidity : 50-65%  
Atmospheric pressure : 100-103 kPa

**Table 10: Test result of Power Density**

Channel	Channel Frequency (MHz)	Power Density	Limit
		(dBm)	(dBm)
Low Channel	2402	-9.75	8
Middle Channel	2440	-9.08	8
High Channel	2480	-9.17	8

## Test Plot of Power Density

### Low Channel

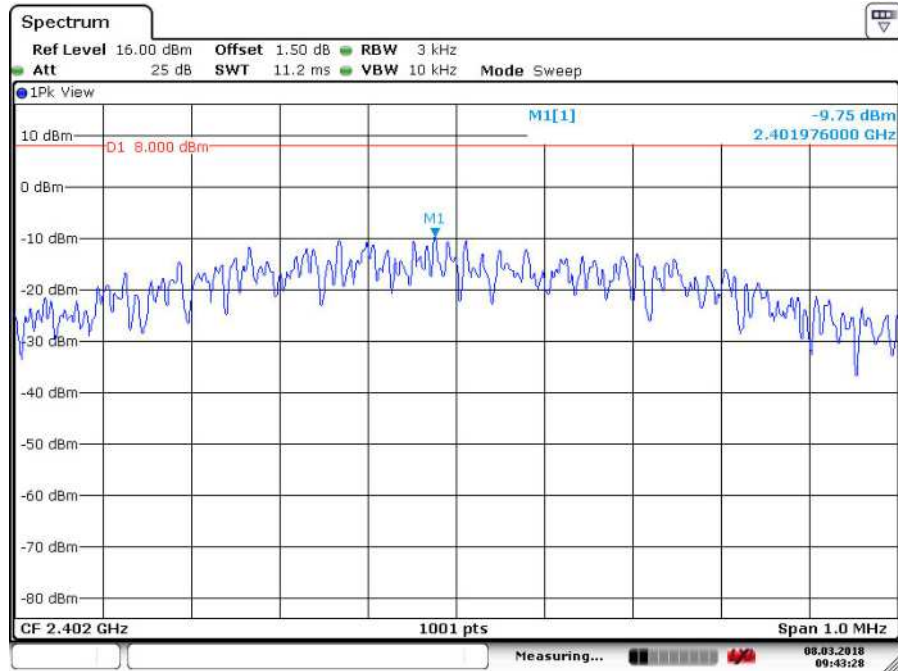

Date: 8 MAR 2018 09:43:29

### Middle Channel

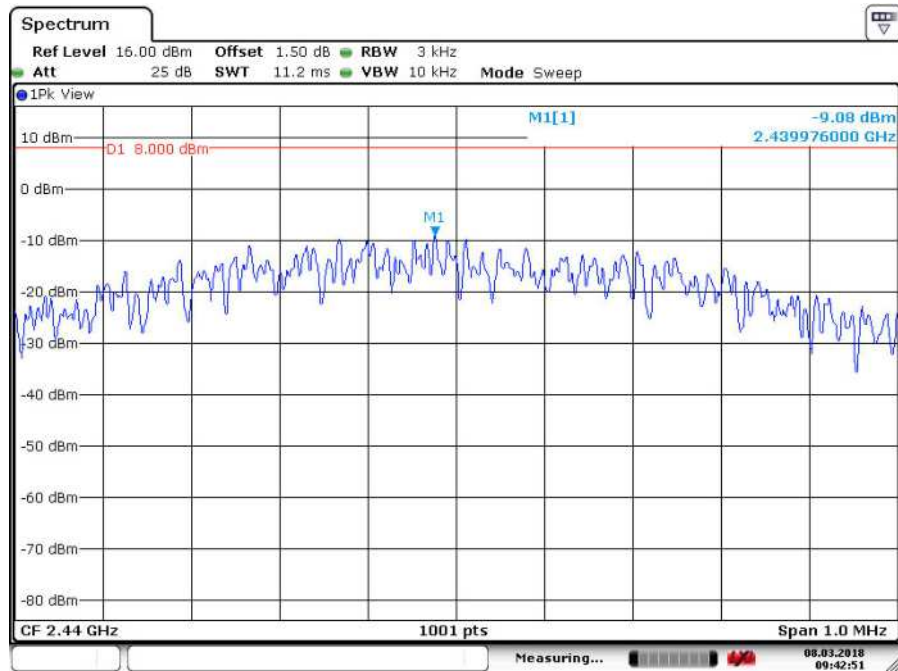

Date: 8 MAR 2018 09:42:51

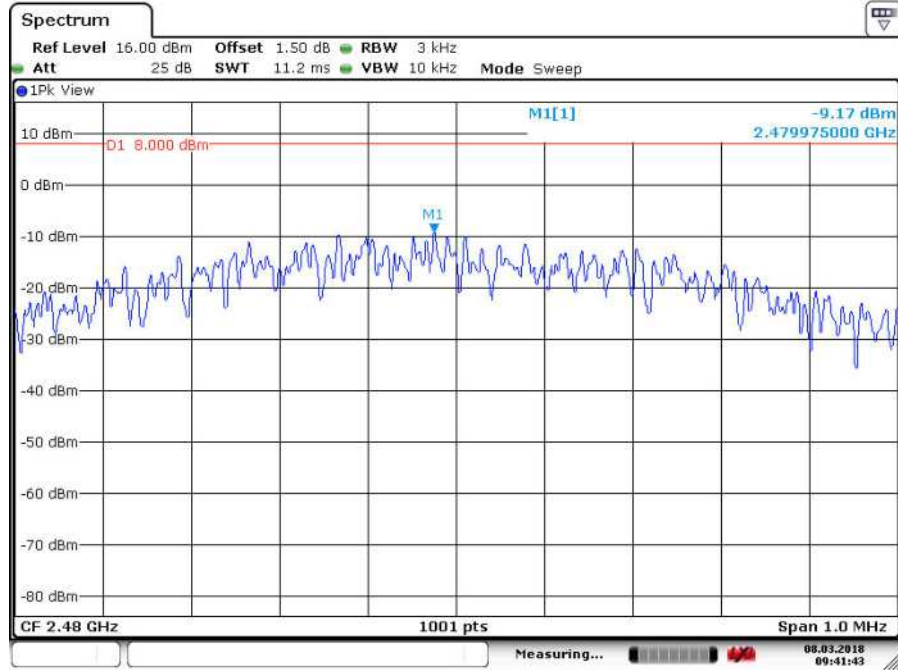
**High Channel**

Date: 8 MAR 2018 09:41:44



### 5.1.5 Conducted spurious emissions and Frequency Band Edge measured in 100kHz Bandwidth

**RESULT:****Passed**

Test standard	:	LP0002(2016): 3.10.1, (5) FCC part 15.247(d), RSS-247 5.5
Basic standard	:	ANSI C63.10:2013, KDB558074
Limit	:	20dB (below that in the 100kHz bandwidth within the band that contains the highest level of the desired power)
Kind of test site	:	Shielded room

**Test setup**

Test Channel	:	Low/ Mid/ High for spurious, Low/ High for Band Edge
Operation mode	:	A
Ambient temperature	:	20-24°C
Relative humidity	:	50-65%
Atmospheric pressure	:	100-103 kPa

All emissions are more than 20dB below fundamental, details refer to following test plot, and compliance is achieved as well.

Due to the small size of the product and that there are no inductive components of significant size, 9kHz to 30MHz frequency range is not tested based on technical judgment.

## Test Plot 100kHz Conducted Emissions

### Low Channel

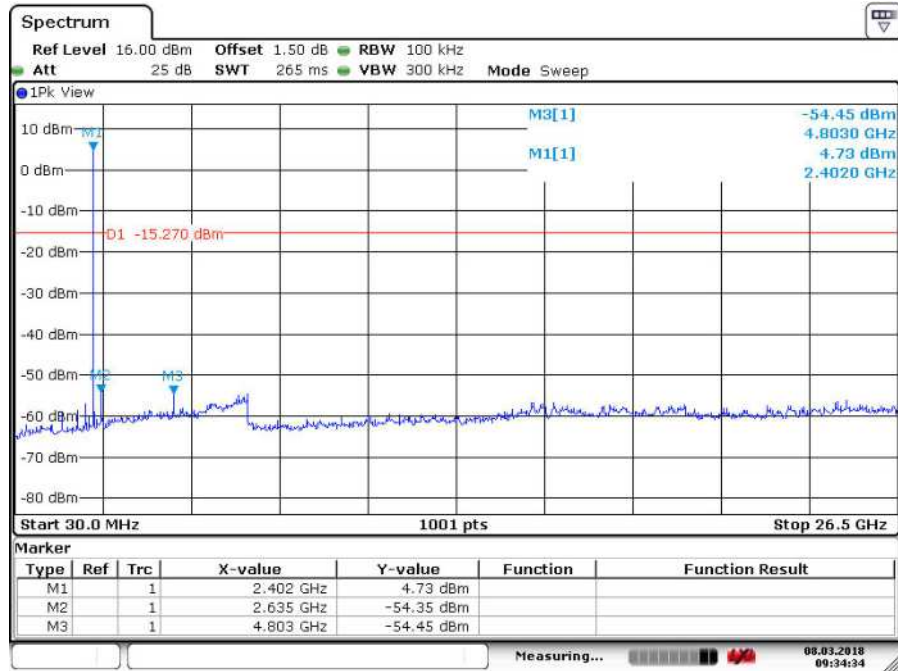

Date: 8 MAR 2018 09:34:34

### Middle Channel

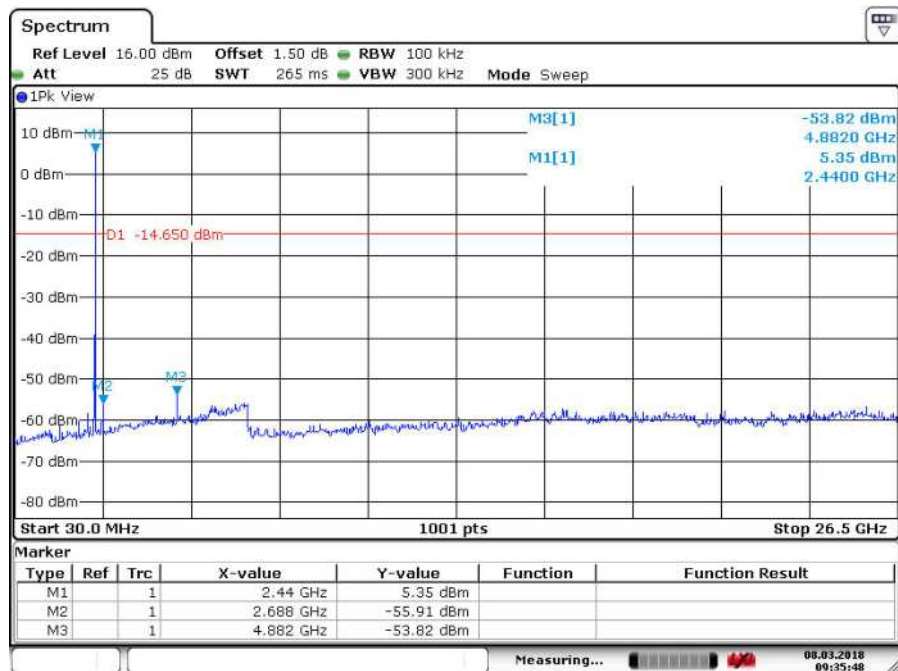

Date: 8 MAR 2018 09:35:49

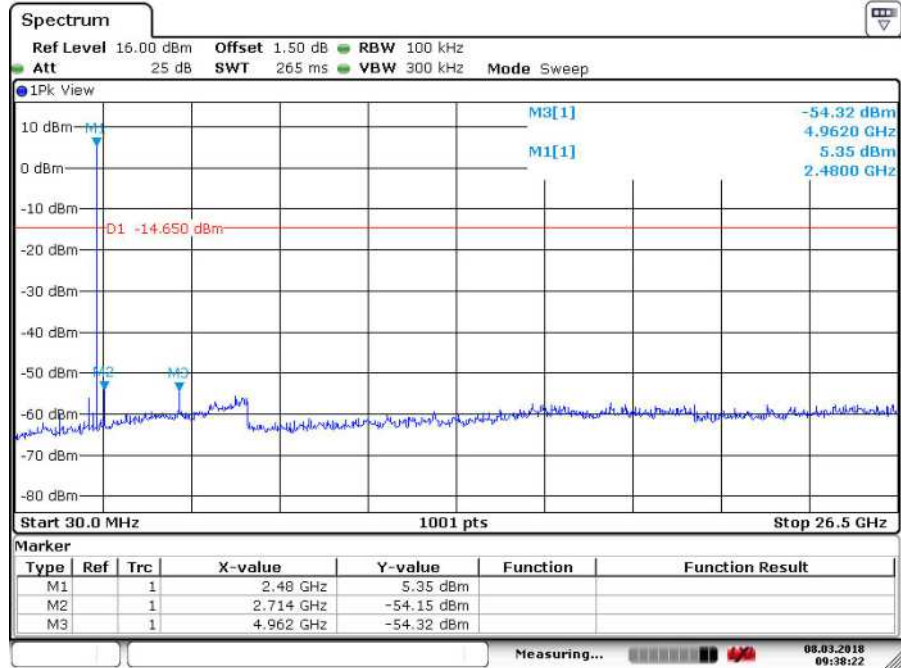
**High Channel**

Date: 8 MAR 2018 09:38:22

## Test Plot 100kHz RBW of Band Edge

### Low Channel

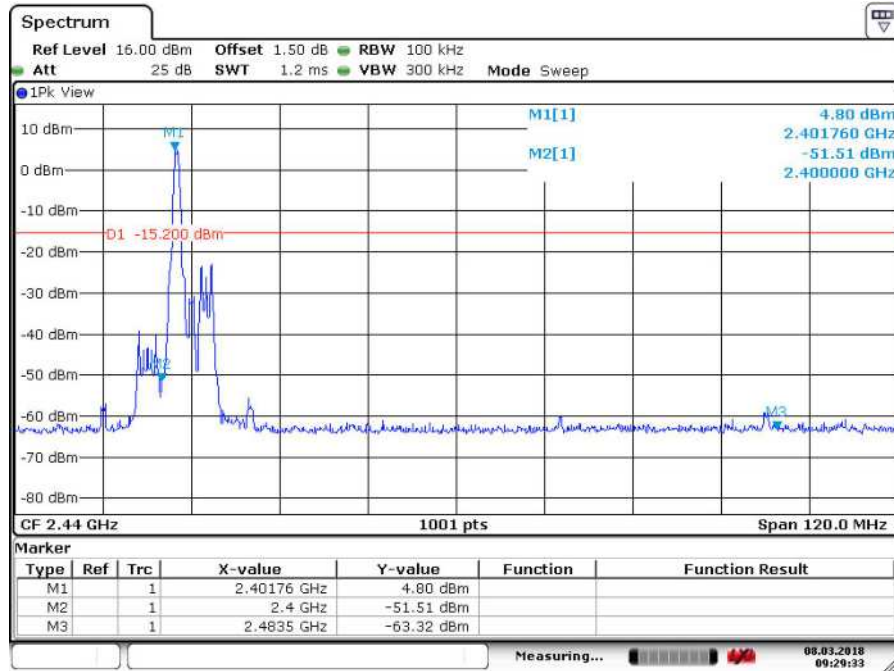

Date: 8 MAR 2018 09:29:33

### High Channel



Date: 8 MAR 2018 09:27:52

## 5.1.6 Spurious Emission

**RESULT:****Passed**

Test standard	:	FCC part 15.247(d), FCC 15.205, FCC 15.209, RSS-247 5.5 and RSS-Gen 8.9 LP0002(2016): 3.10.1, (5)
Basic standard	:	ANSI C63.10: 2013
Limits	:	Radiated emissions which fall in the restricted bands, as defined in FCC 15.205(a) and RSS-Gen i5, 8.10 (Table 7), must comply with the radiated emission limits specified in FCC 15.209(a) and RSS-Gen i5, 8.9 (Table 5 and 6). Radiated emissions which fall in the restricted bands, as defined in LP0002(2016): 2.7, must comply with the radiated emission limits specified in LP0002(2016): 2.8 Emission radiated outside the specified frequency bands must comply with the radiated emission limits specified in FCC 15.209(a) and FCC 15.249(a), RSS-Gen i5, 8.9 (Table 5 and 6). Emission radiated outside the specified frequency bands must comply with the radiated emission limits specified in LP0002(2016): 2.8
Kind of test site	:	3m Semi-Anechoic Chamber

**Test setup**

Test Channel	:	Low/ Middle/ High
Operation mode	:	A, B

For details refer to Appendix D.

The Radiated Emissions testing was performed in the X, Y and Z axis orientation. The worst-case Axis orientation is recorded in this test report.

Mains Emissions

**5.1.7 Mains Conducted Emissions****RESULT:****Passed**

Test standard : FCC Part 15.207  
FCC Part 15.107  
RSS-Gen 8.8  
LP0002: 2.3

Limits : Mains Conducted emissions as defined in  
above test standards must comply with the  
mains conducted emission limits specified

Kind of test site : Shielded Room

**Test setup**

Test Channel : Middle  
Operation mode : A

Remark: For details refer to Appendix D.

## 6. Safety Human exposure

### 6.1 Radio Frequency Exposure Compliance

#### 6.1.1 Electromagnetic Fields

**RESULT:****Passed**

Test standard : FCC KDB Publication 447498 D01 v06  
47CFR 1.1310  
47CFR 2.1091  
RSS-102 issue 5, Table 4

FCC:

Therefore the maximum output power of the transmitter is 4.6666mW < 396mW(Distance: 80 mm), hence the EUT is excluded from SAR evaluation according to FCC KDB publication 447498 D01: Mobile Portable RF Exposure.

Canada:

Maximum conducted peak power: 4.6666 mW  
Antenna Gain: 5 dbi  
Maximum EIRP available 14.8 mW

Since maximum output power of the transmitter is 14.8mW < 309mW (distance ≥50 mm ), hence the EUT is excluded from SAR evaluation according to Table 1 in RSS-102

**---End---**

## 7. Photographs of the Test Set-Up

Photograph 1: Set-up for Spurious Emissions (Front View 1)- RFA-02-5-C7H1-ANT

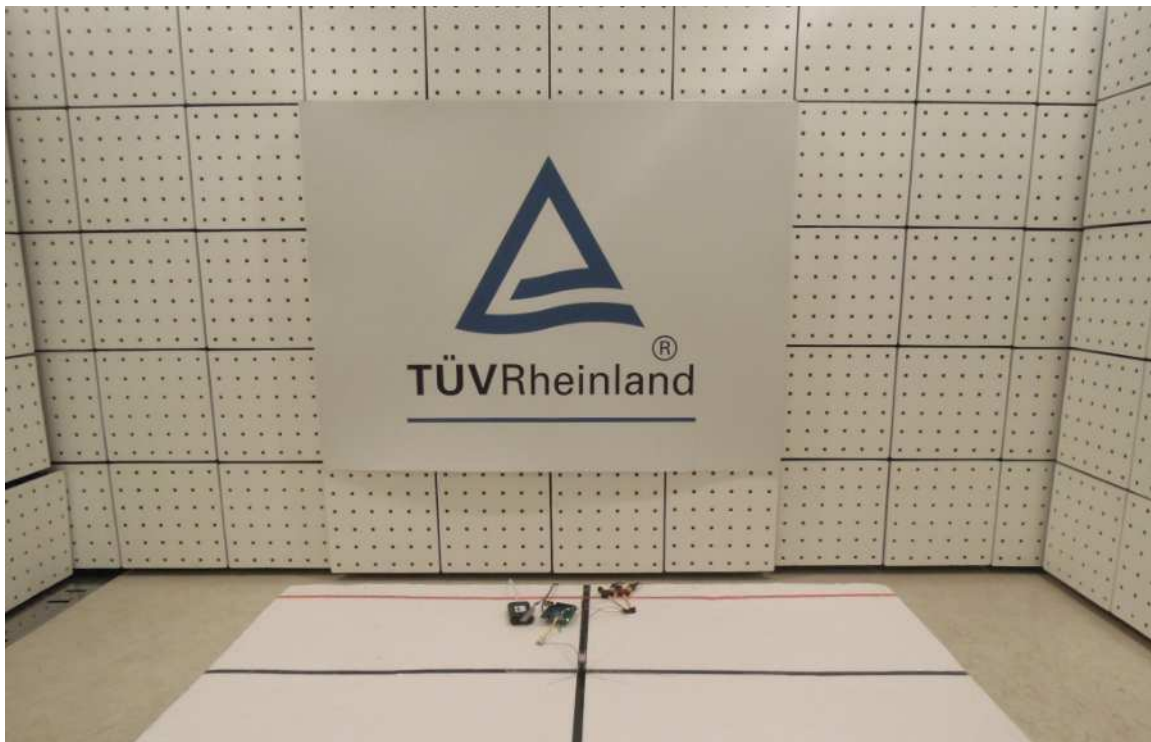



**Photograph 2: Set-up for Spurious Emissions (Back View 1)- RFA-02-5-C7H1-ANT**



**Photograph 3: Set-up for Spurious Emissions (Front View 2)- RFA-02-5-C7H1-ANT**

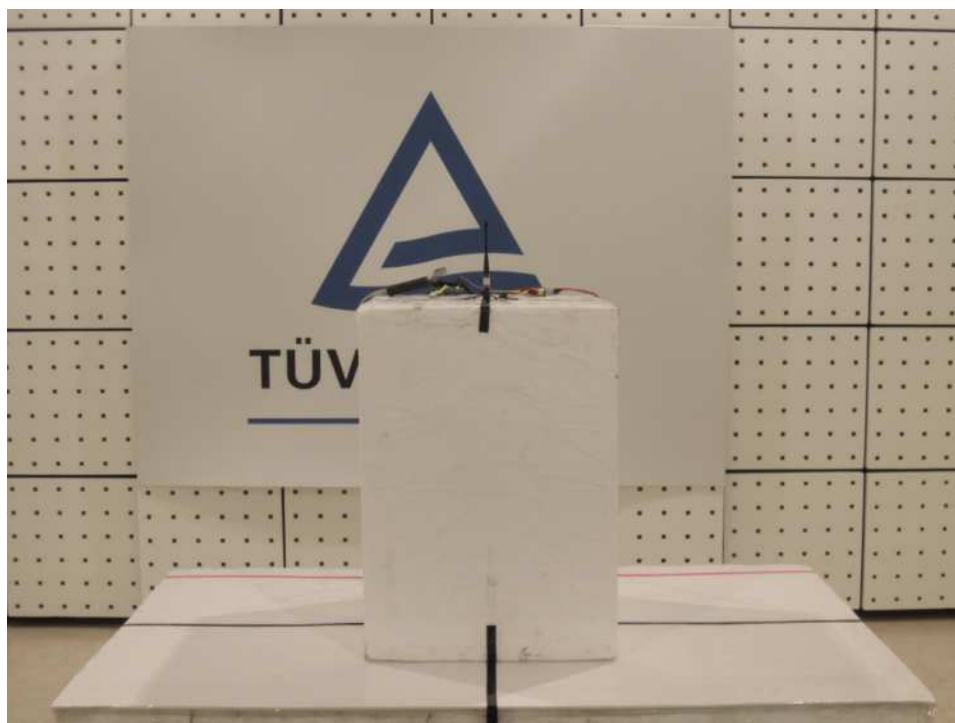

**Photograph 4: Set-up for Spurious Emissions (Back View 2)- RFA-02-5-C7H1-ANT**



**Photograph 5: Set-up for Spurious Emissions (Back View 3)- RFA-02-5-C7H1-ANT**

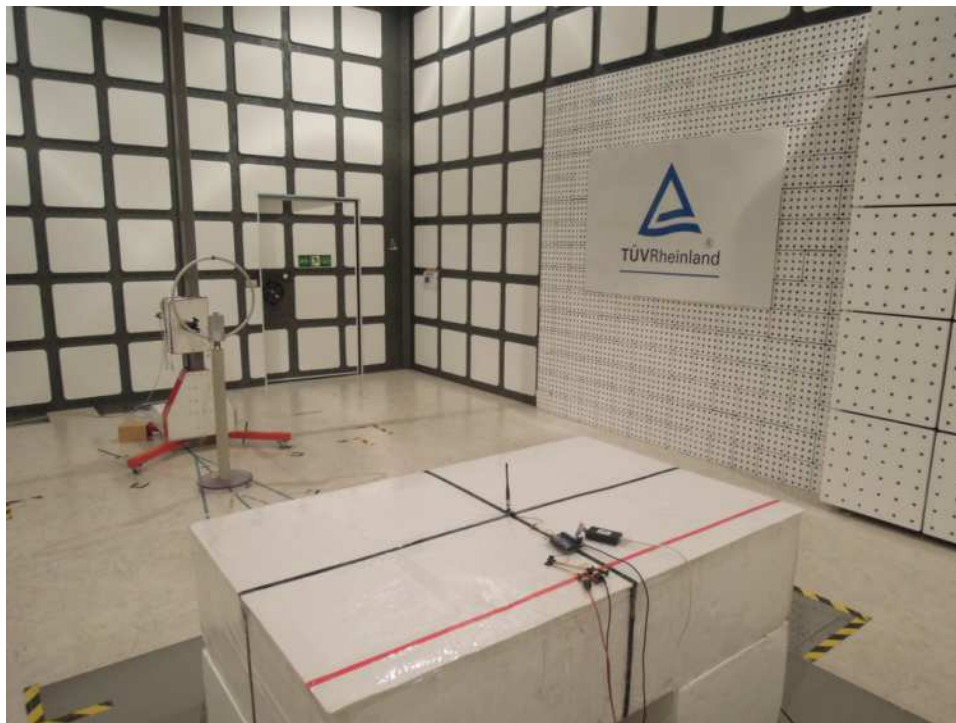

**Photograph 6: Set-up for Spurious Emissions (Back View 4)- RFA-02-5-C7H1-ANT**

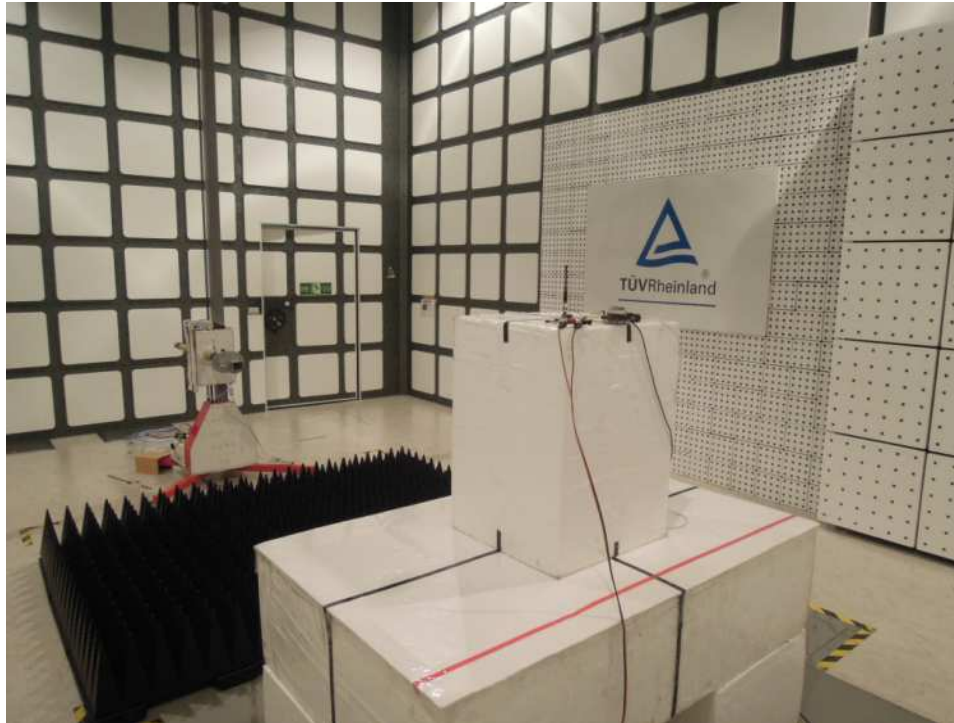

**Photograph 7: Set-up for Spurious Emissions (Front View 1)- RFMTA331215-ANT**

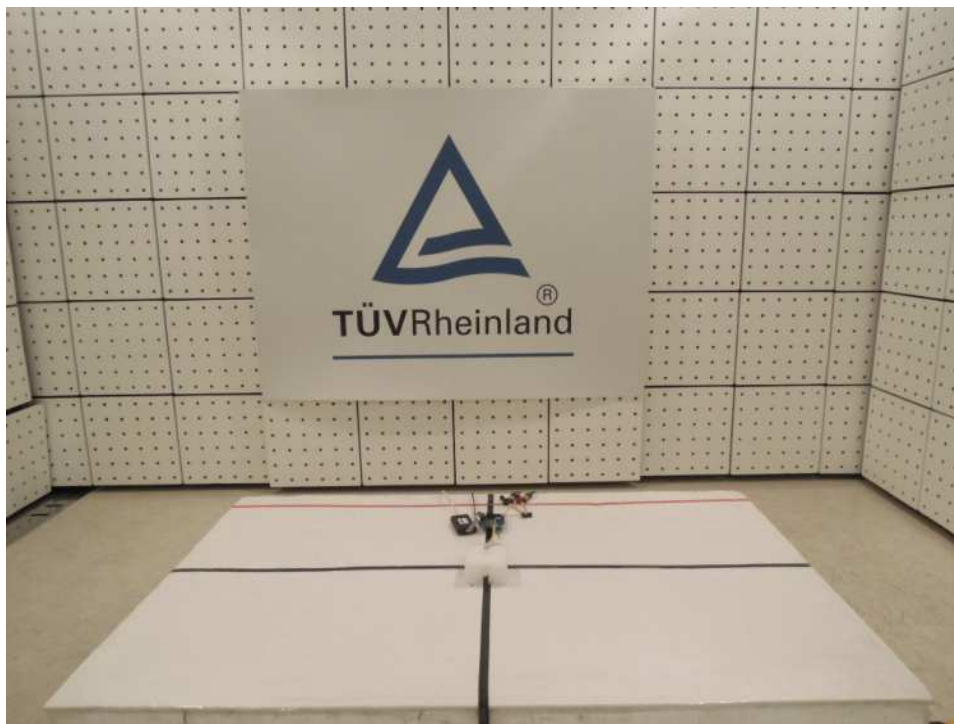

**Photograph 8: Set-up for Spurious Emissions (Back View 1)- RFMTA331215-ANT**

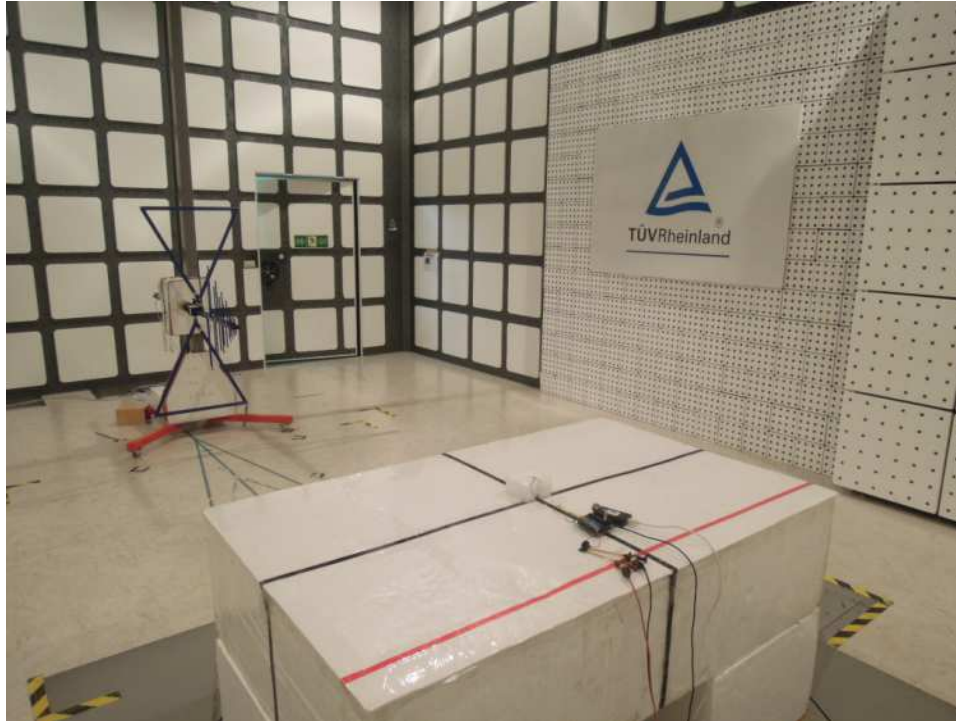

**Photograph 9: Set-up for Spurious Emissions (Front View 2)- RFMTA331215-ANT**

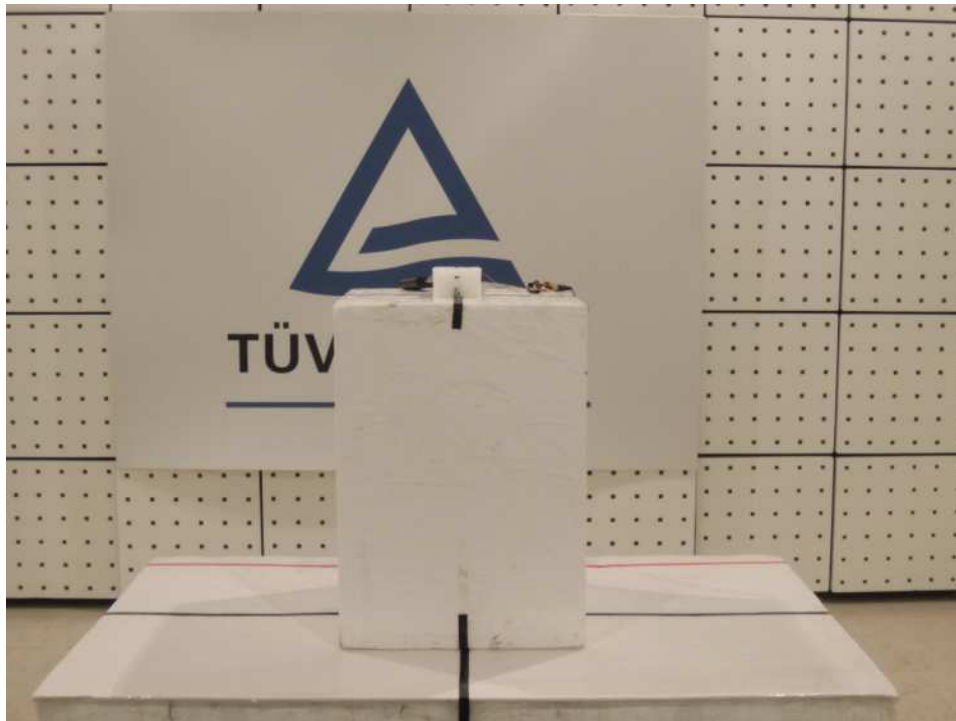

**Photograph 10: Set-up for Spurious Emissions (Back View 2)- RFMTA331215-ANT**

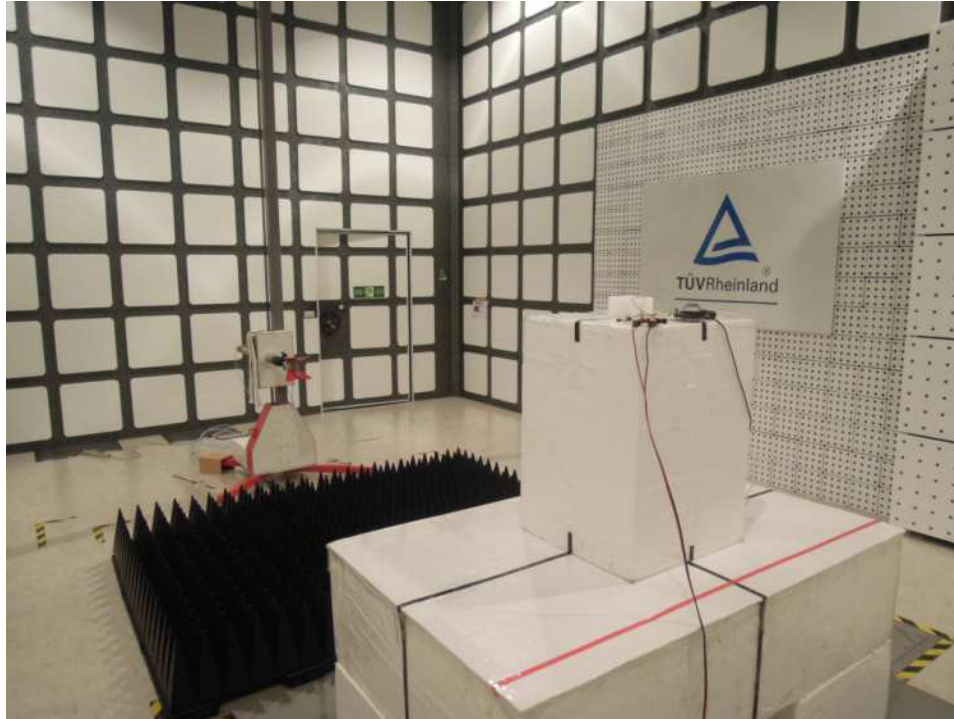

**Photograph 11: Set-up for Spurious Emissions (Back View 3)- RFMTA331215-ANT**

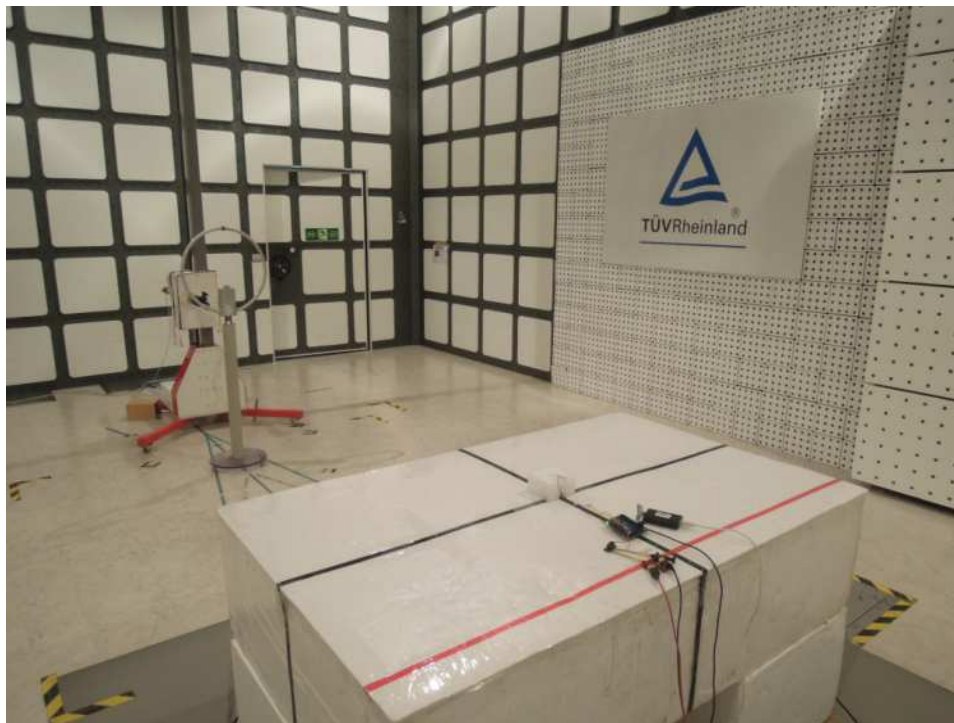

**Photograph 12: Set-up for Spurious Emissions (Back View 4)- RFMTA331215-ANT**



**Photograph 13: Set-up for Spurious Emissions (Front View 1)- RFPCA381013IMAB701-ANT**

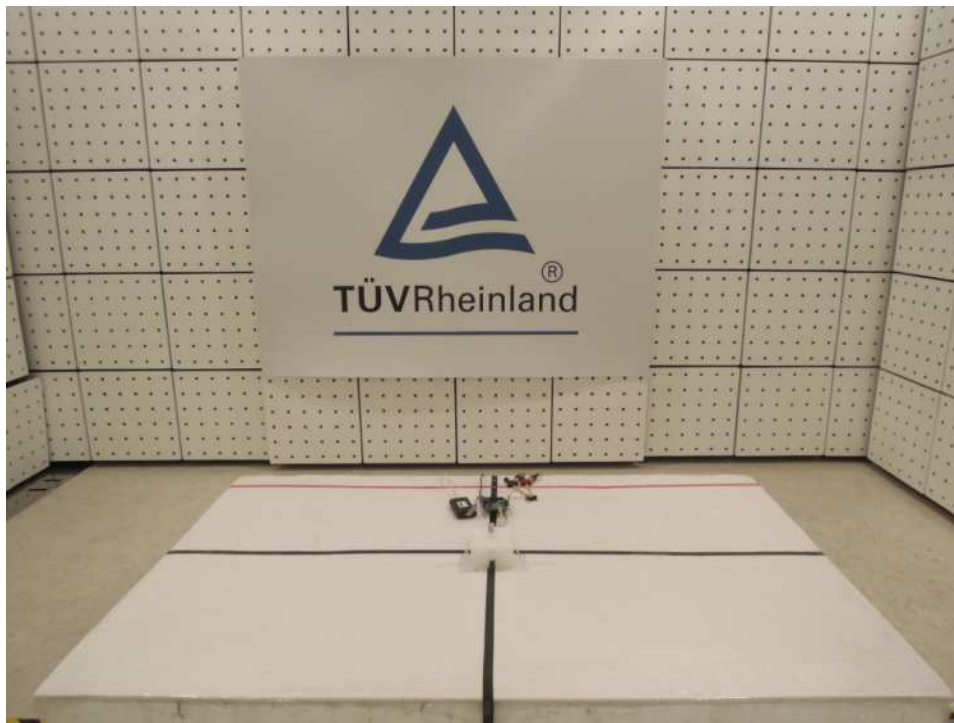

**Photograph 14: Set-up for Spurious Emissions (Back View 1)- RFPCA381013IMAB701-ANT**

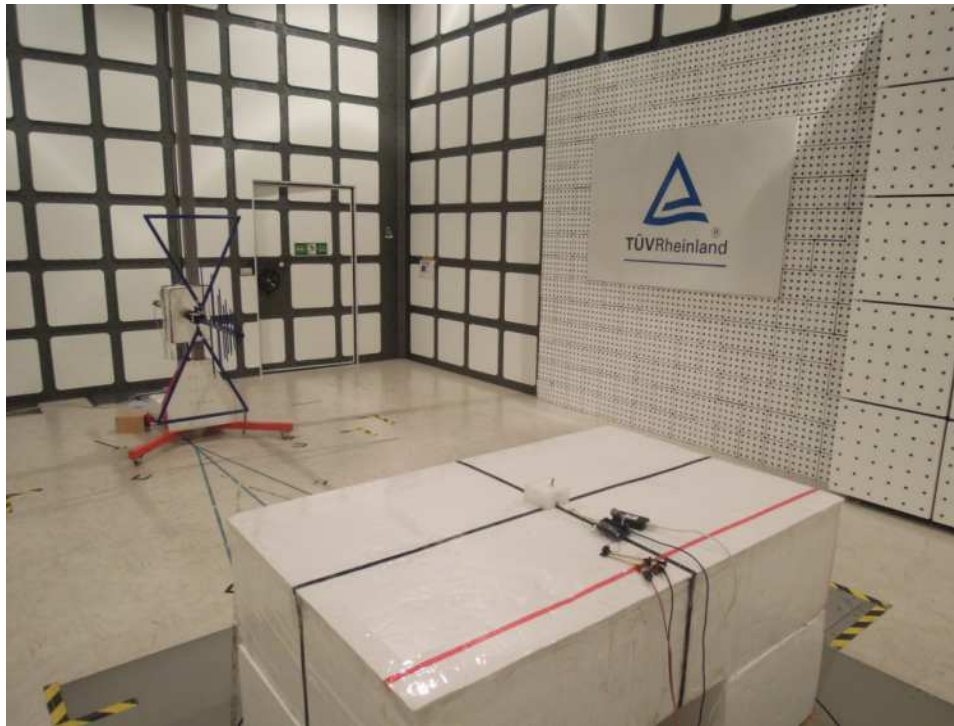

**Photograph 15: Set-up for Spurious Emissions (Front View 2)- RFPCA381013IMAB701-ANT**

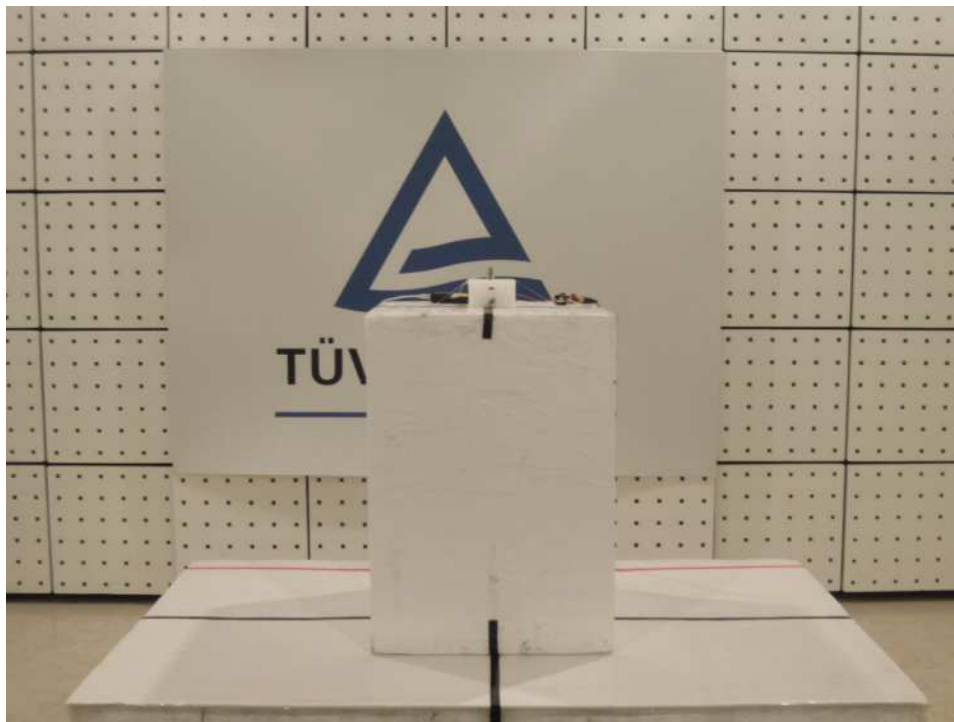

**Photograph 16: Set-up for Spurious Emissions (Back View 2)- RFPCA381013IMAB701-ANT**



**Photograph 17: Set-up for Spurious Emissions (Back View 3)- RFPCA381013IMAB701-ANT**





**Photograph 18: Set-up for Spurious Emissions (Back View 4)- RFPCA381013IMAB701-ANT**

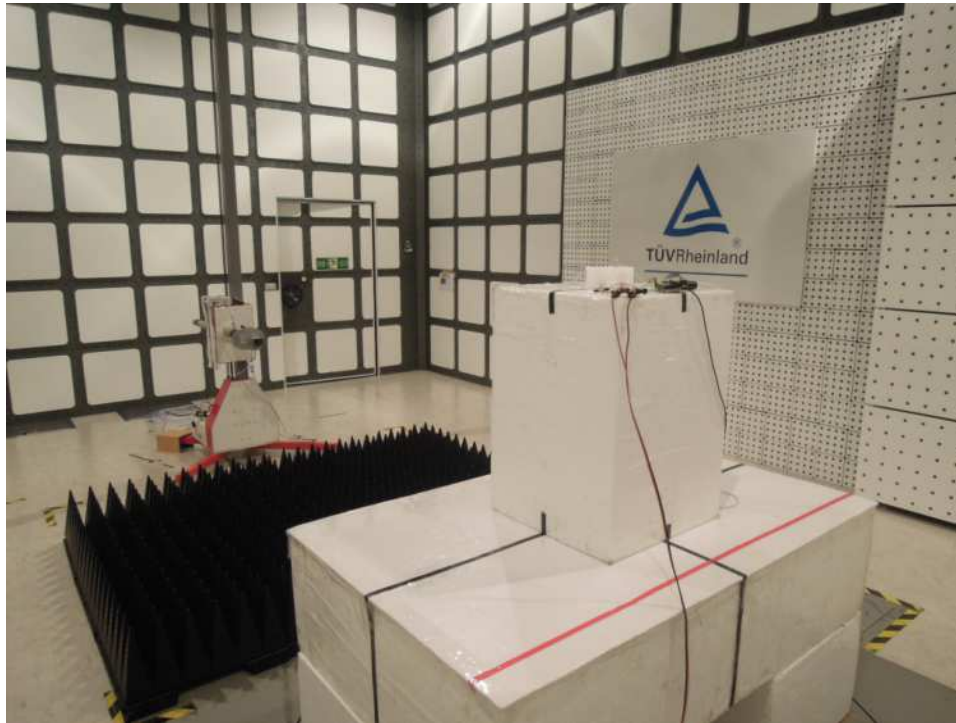

**Photograph 19: Set-up for Conducted testing**



Photograph 20: Set-up for Conducted testing



Photograph 21: Set-up for Mains Conducted testing (Front View)



**Photograph 22: Set-up for Mains Conducted testing (Back View)**

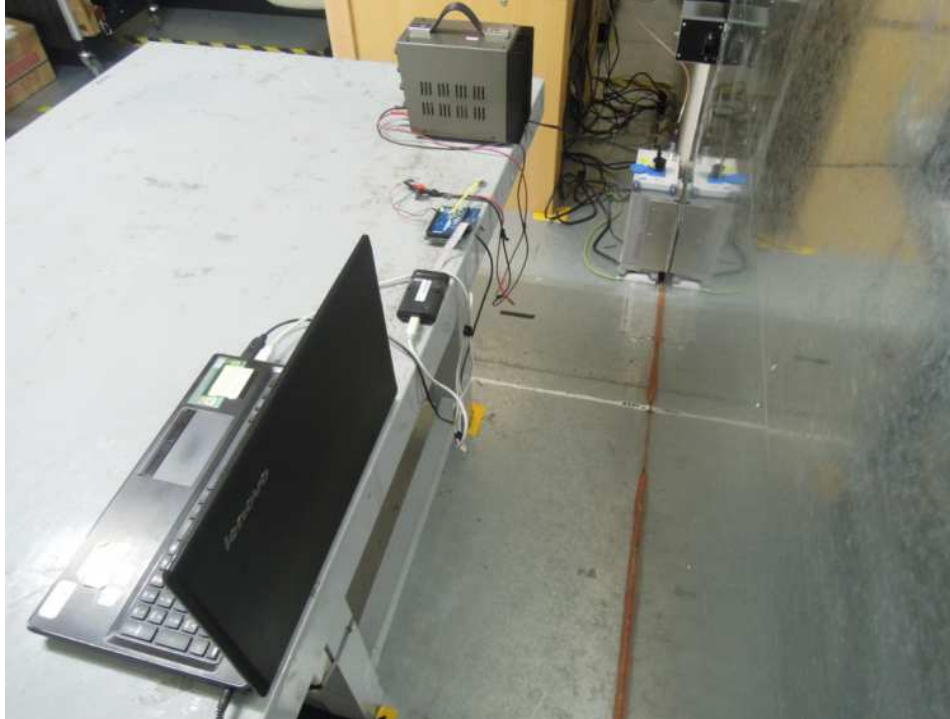

## 8. List of Tables

Table 1: Applied Standard and Test Levels .....	5
Table 2: List of Test and Measurement Equipment .....	7
Table 3: Emission Measurement Uncertainty.....	8
Table 4: Basic Information of EUT .....	9
Table 5: Technical Specification of EUT .....	9
Table 6: External Antenna list.....	10
Table 7: Test result of Peak Output Power .....	16
Table 8: Test result of 6dB Bandwidth .....	17
Table 9: Test result of 99% Bandwidth.....	17
Table 10: Test result of Power Density .....	22

## 9. List of Photographs

Photograph 1: Set-up for Spurious Emissions (Front View 1)- RFA-02-5-C7H1-ANT.....	32
Photograph 2: Set-up for Spurious Emissions (Back View 1)- RFA-02-5-C7H1-ANT .....	33
Photograph 3: Set-up for Spurious Emissions (Front View 2)- RFA-02-5-C7H1-ANT.....	33
Photograph 4: Set-up for Spurious Emissions (Back View 2)- RFA-02-5-C7H1-ANT .....	34
Photograph 5: Set-up for Spurious Emissions (Back View 3)- RFA-02-5-C7H1-ANT .....	34
Photograph 6: Set-up for Spurious Emissions (Back View 4)- RFA-02-5-C7H1-ANT .....	35
Photograph 7: Set-up for Spurious Emissions (Front View 1)- RFMTA331215-ANT .....	35
Photograph 8: Set-up for Spurious Emissions (Back View 1)- RFMTA331215-ANT .....	36
Photograph 9: Set-up for Spurious Emissions (Front View 2)- RFMTA331215-ANT .....	36
Photograph 10: Set-up for Spurious Emissions (Back View 2)- RFMTA331215-ANT.....	37
Photograph 11: Set-up for Spurious Emissions (Back View 3)- RFMTA331215-ANT.....	37
Photograph 12: Set-up for Spurious Emissions (Back View 4)- RFMTA331215-ANT.....	38
Photograph 13: Set-up for Spurious Emissions (Front View 1)- RFPCA381013IMAB701-ANT.....	38
Photograph 14: Set-up for Spurious Emissions (Back View 1)- RFPCA381013IMAB701-ANT .....	39
Photograph 15: Set-up for Spurious Emissions (Front View 2)- RFPCA381013IMAB701-ANT.....	39
Photograph 16: Set-up for Spurious Emissions (Back View 2)- RFPCA381013IMAB701-ANT .....	40
Photograph 17: Set-up for Spurious Emissions (Back View 3)- RFPCA381013IMAB701-ANT .....	40
Photograph 18: Set-up for Spurious Emissions (Back View 4)- RFPCA381013IMAB701-ANT .....	41
Photograph 19: Set-up for Conducted testing .....	41
Photograph 20: Set-up for Conducted testing .....	42
Photograph 21: Set-up for Mains Conducted testing (Front View).....	42
Photograph 22: Set-up for Mains Conducted testing (Back View) .....	43