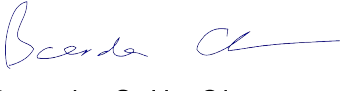

<b>Prüfbericht-Nr.:</b> <i>Test report no.:</i>	60390718 001	<b>Auftrags-Nr.:</b> <i>Order no.:</i>	238133966	Seite 1 von 37 <i>Page 1 of 37</i>
<b>Kunden-Referenz-Nr.:</b> <i>Client reference no.:</i>	N/A	<b>Auftragsdatum:</b> <i>Order date:</i>	14-Jan-2020	
<b>Auftraggeber:</b> <i>Client:</i>	Microchip Technology Inc. 2355 West Chandler Blvd. Chandler, Arizona 85224-6199, United States.			
<b>Prüfgegenstand:</b> <i>Test item:</i>	Low Power LoRa® Sub-1GHz Module			
<b>Bezeichnung / Typ-Nr.:</b> <i>Identification / Type no.:</i>	WLR089U0, WLR089UC			
<b>Auftrags-Inhalt:</b> <i>Order content:</i>	FCC Part 15C / ISED RSS-247 Test report (LoRa)			
<b>Prüfgrundlage:</b> <i>Test specification:</i>	FCC 47CFR Part 15: Subpart C Section 15.247(Hybrid) ISED RSS-247 ISSUE 2 FEB 2017			
<b>Wareneingangsdatum:</b> <i>Date of sample receipt:</i>	19-Feb-2020			
<b>Prüfmuster-Nr.:</b> <i>Test sample no.:</i>	Refer to Page 12			
<b>Prüfzeitraum:</b> <i>Testing period:</i>	20-Mar-2020 – 13-Jul-2020			
<b>Ort der Prüfung:</b> <i>Place of testing:</i>	EMC/RF Laboratory Taipei			
<b>Prüflaboratorium:</b> <i>Testing laboratory:</i>	Taipei Testing laboratories			
<b>Prüfergebnis*:</b> <i>Test result*:</i>	Pass			
<b>überprüft von:</b> <i>reviewed by:</i>	<b>genehmigt von:</b> <i>authorized by:</i>			
<b>Datum:</b> 05-Aug-2020 <i>Date:</i>	 Jack H.C. Chang	<b>Datum:</b> 05-Aug-2020 <i>Date:</i>	 Brenda S.H. Chen	
<b>Stellung / Position:</b>	Project Manager	<b>Stellung / Position:</b>	Project Manager	
<b>Sonstiges / Other:</b>				
<b>Zustand des Prüfgegenstandes bei Anlieferung:</b> <i>Condition of the test item at delivery:</i>		Prüfmuster vollständig und unbeschädigt <i>Test item complete and undamaged</i>		
* Legende:	1 = sehr gut P(ass) = entspricht o.g. Prüfgrundlage(n)	2 = gut 3 = befriedigend F(ail) = entspricht nicht o.g. Prüfgrundlage(n)	4 = ausreichend N/A = nicht anwendbar	5 = mangelhaft N/T = nicht getestet
* Legend:	1 = very good P(ass) = passed a.m. test specification(s)	2 = good 3 = satisfactory F(ail) = failed a.m. test specification(s)	4 = sufficient N/A = not applicable	5 = poor N/T = not tested
<p><b>Dieser Prüfbericht bezieht sich nur auf das o.g. Prüfmuster und darf ohne Genehmigung der Prüfstelle nicht auszugsweise vervielfältigt werden. Dieser Bericht berechtigt nicht zur Verwendung eines Prüfzeichens.</b> <i>This test report only relates to the a. m. test sample. Without permission of the test center this test report is not permitted to be duplicated in extracts. This test report does not entitle to carry any test mark.</i></p>				

## TEST SUMMARY

### 5.1.1 ANTENNA REQUIREMENT

RESULT: *Passed*

### 5.1.2 MAXIMUM CONDUCTED (AVERAGE) OUTPUT POWER

RESULT: *Passed*

### 5.1.3 FREQUENCY SEPARATION

RESULT: *Passed*

### 5.1.4 20dB BANDWIDTH AND 99% BANDWIDTH

RESULT: *Passed*

### 5.1.5 POWER DENSITY

RESULT: *Passed*

### 5.1.6 CONDUCTED SPURIOUS EMISSIONS AND FREQUENCY BAND EDGE MEASURED IN 100kHz BANDWIDTH

RESULT: *Passed*

### 5.1.7 TIME OF OCCUPANCY

RESULT: *Passed*

### 5.1.8 SPURIOUS EMISSION

RESULT: *Passed*

### 5.2.1 MAINS CONDUCTED EMISSIONS

RESULT: *Passed*

### 6.1.1 ELECTROMAGNETIC FIELDS

RESULT: *Passed*

## Contents

<b>1.</b>	<b>GENERAL REMARKS .....</b>	<b>5</b>
<b>1.1</b>	<b>COMPLEMENTARY MATERIALS .....</b>	<b>5</b>
<b>2.</b>	<b>TEST SITES.....</b>	<b>6</b>
<b>2.1</b>	<b>TEST LABORATORY .....</b>	<b>6</b>
<b>2.2</b>	<b>TEST FACILITY .....</b>	<b>6</b>
<b>2.3</b>	<b>LIST OF TEST AND MEASUREMENT INSTRUMENTS .....</b>	<b>7</b>
<b>2.4</b>	<b>TRACEABILITY .....</b>	<b>8</b>
<b>2.5</b>	<b>CALIBRATION.....</b>	<b>8</b>
<b>2.6</b>	<b>MEASUREMENT UNCERTAINTY .....</b>	<b>8</b>
<b>3.</b>	<b>GENERAL PRODUCT INFORMATION .....</b>	<b>9</b>
<b>3.1</b>	<b>PRODUCT FUNCTION AND INTENDED USE.....</b>	<b>9</b>
<b>3.2</b>	<b>SYSTEM DETAILS AND RATINGS .....</b>	<b>9</b>
<b>3.3</b>	<b>INDEPENDENT OPERATION MODES.....</b>	<b>11</b>
<b>3.4</b>	<b>NOISE GENERATING AND NOISE SUPPRESSING PARTS.....</b>	<b>11</b>
<b>3.5</b>	<b>SUBMITTED DOCUMENTS .....</b>	<b>11</b>
<b>4.</b>	<b>TEST SET-UP AND OPERATION MODES .....</b>	<b>12</b>
<b>4.1</b>	<b>PRINCIPLE OF CONFIGURATION SELECTION.....</b>	<b>12</b>
<b>4.2</b>	<b>TEST OPERATION AND TEST SOFTWARE .....</b>	<b>12</b>
<b>4.3</b>	<b>SPECIAL ACCESSORIES AND AUXILIARY EQUIPMENT .....</b>	<b>13</b>
<b>4.4</b>	<b>COUNTERMEASURES TO ACHIEVE EMC COMPLIANCE .....</b>	<b>13</b>
<b>4.5</b>	<b>TEST SETUP DIAGRAM.....</b>	<b>14</b>
<b>5.</b>	<b>TEST RESULTS .....</b>	<b>16</b>
<b>5.1</b>	<b>TRANSMITTER REQUIREMENT &amp; TEST SUITES .....</b>	<b>16</b>
<i>5.1.1</i>	<i>Antenna Requirement .....</i>	<i>16</i>
<i>5.1.2</i>	<i>Maximum conducted (average) output power.....</i>	<i>17</i>
<i>5.1.3</i>	<i>Frequency Separation.....</i>	<i>18</i>
<i>5.1.4</i>	<i>20dB Bandwidth and 99% Bandwidth .....</i>	<i>20</i>
<i>5.1.5</i>	<i>Power Density.....</i>	<i>24</i>
<i>5.1.6</i>	<i>Conducted spurious emissions and Frequency Band Edge measured in 100kHz Bandwidth .....</i>	<i>27</i>
<i>5.1.7</i>	<i>Time of Occupancy.....</i>	<i>32</i>
<i>5.1.8</i>	<i>Spurious Emission.....</i>	<i>34</i>
<b>5.2</b>	<b>MAINS EMISSIONS.....</b>	<b>35</b>
<i>5.2.1</i>	<i>Mains Conducted Emissions .....</i>	<i>35</i>
<b>6.</b>	<b>SAFETY HUMAN EXPOSURE.....</b>	<b>36</b>

**Prüfbericht - Nr.: 60390718 001**  
*Test Report No.***Seite 4 von 37**  
*Page 4 of 37*

<b>6.1</b>	<b>RADIO FREQUENCY EXPOSURE COMPLIANCE .....</b>	<b>36</b>
6.1.1	<i>Electromagnetic Fields .....</i>	<i>36</i>
<b>7.</b>	<b>LIST OF TABLES .....</b>	<b>37</b>

## 1. General Remarks

### 1.1 Complementary Materials

The following attachments are integral parts of this test report:

**Appendix P: Photo Documentation internal view**  
(File Name: 60390718 001 Appendix P)

**Appendix D: Test Result of Radiated Emissions**  
(File Name: 60390718 001 Appendix D)

**Appendix X: Photographs of the Test Set-Up**  
(File Name: 60390718 001 Appendix X)

Test Specifications

The following standards were applied.

#### Table 1: Applied Standard and Test Levels

Radio
FCC 47CFR Part 15: Subpart C Section 15.247
FCC 47CFR Part 2: Subpart J Section 2.1093
ISED RSS-247 Issue 2, Feb 2017
ISED RSS-102 Issue 5, March 2015
ISED RSS-Gen, Issue 5, March 2019
ANSI C63.10:2013
KDB558074 D01 DTS Meas Guidance v05r02
KDB447498 D01 General RF Exposure Guidance v06

## 2. Test Sites

### 2.1 Test Laboratory

Taipei Testing Laboratories

11F. No.758, Sec. 4, Bade Rd., Songshan Dist.  
Taipei City 105  
Taiwan (R.O.C.)

### 2.2 Test Facility

Taipei Testing Laboratories

11F. No.758, Sec. 4, Bade Rd., Songshan Dist.  
Taipei City 105  
Taiwan (R.O.C.)

(Mains Conducted Emission)  
FCC Registration No.: 180491  
ISED Registration No.: 9465A

No.458-18, Sec. 2, Fenliao Rd., Linkou Dist.,  
New Taipei City 244  
Taiwan (R.O.C.)  
(Conducted Test & Radiated Spurious Emissions)  
FCC Registration No.: 226631  
ISED Registration No.: 25563



## 2.3 List of Test and Measurement Instruments

**Table 2: List of Test and Measurement Equipment**

Radiated Test: Testing period is 2020/03/20 to 2020/05/22

Kind of Equipment	Manufacturer	Type	S/N	Calibration Date	Calibration Due Date
Signal Analyzer	R&S	FSV40	101508	2020/3/16	2021/3/15
Receiver	R&S	ESR7	102108	2020/3/16	2021/3/15
Bilog Antenna	SCHWARZBECK	VULB-9168	00951	2020/2/14	2021/2/12
Horn Antenna	ETS-Lindgren	3117	00218930	2019/12/6	2020/12/4
LF-AMP	Agilent	8447D	2944A10772	2020/2/11	2021/2/9
HF-AMP + AC source	EMCI	EMC051845SE	980633	2020/2/17	2021/2/15
HF-AMP + AC source	EMCI	EMC184045SE	980657	2020/2/17	2021/2/15
Horn Antenna	SCHWARZBECK	BBHA 9170	00890	2019/4/12 2020/3/25	2020/4/11 2021/3/24
Loop Antenna	Chance Most	EMCILPA600 + calibration	287	2020/1/9	2021/1/8
Microwave Cable	HUBER+SUHNER	SUCOFLEX 104EA	800056/4EA	2019/4/18 2020/3/25	2020/5/21 2021/3/25
Microwave Cable	HUBER+SUHNER	SUCOFLEX 104	804680/4	2019/4/18 2020/3/25	2020/5/21 2021/3/25
Microwave Cable	HUBER+SUHNER	SUCOFLEX 104	MY37202/4	2019/4/18 2020/3/25	2020/5/21 2021/3/25
Microwave Cable	HUBER+SUHNER	SUCOFLEX 102EA	800898/2EA	2019/4/18 2020/4/22	2020/5/21 2021/4/22
Microwave Cable	HUBER+SUHNER	SUCOFLEX 102EA	800901/2EA	2019/4/18 2020/4/22	2020/5/21 2021/4/22
Microwave Cable	HUBER+SUHNER	SUCOFLEX 102EA	801027/2EA	2019/4/18 2020/4/22	2020/5/21 2021/4/22
Signal Analyzer	R&S	FSV40	101508	2020/3/16	2021/3/15
Receiver	R&S	ESR7	102108	2020/3/16	2021/3/15

Conducted Test: Testing period is 2020/04/27 to 2020/05/28

Kind of Equipment	Manufacturer	Type	S/N	Calibration Date	Calibration Due Date
Power Meter	Anritsu	ML2495A	1901008	2020/4/6	2021/4/5
Power Sensor	Anritsu	MA2411B	1725269	2020/4/7	2021/4/6
Spectrum Analyzer	R&S	FSV40	101512	2020/2/18	2021/2/17

AC Mains: Testing period is 2020/07/03

Kind of Equipment	Manufacturer	Type	S/N	Calibration Date	Calibration Due Date
TWO-LINE V-NETWORK	SCHHWARZBECK	NSLK 8127	8127-00976	2019/10/2	2020/9/30
EMI Test Receiver	R&S	ESR7	102108	2020/4/22	2021/4/21
10dB attenuation	SCHHWARZBECK	VTSD 9561 F-N	660	2020/2/24	2021/2/23
Measurement Software	EZ	EZ EMC (Version NB-03A)	N/A	N/A	N/A

## 2.4 Traceability

All measurement equipment calibrations are traceable to NML(Taiwan)/NIST(USA) or where calibration is performed outside Taiwan, to equivalent nationally recognized standards organizations.

## 2.5 Calibration

Equipment requiring calibration is calibrated periodically in a suitably accredited Calibration Lab. Additionally all equipment is verified for proper performance on a regular schedule using in house standards or comparisons.

## 2.6 Measurement Uncertainty

The estimated combined standard uncertainty for radiated emissions and conducted emissions measurements .

**Table 3: Emission Measurement Uncertainty**

Parameter	Uncertainty
Radio Frequency	± 0.1 ppm
RF power, conducted	± 1.5 dB
RF power density, conducted	± 3 dB
spurious emissions, conducted	± 3 dB
all emissions, radiated	± 6 dB
Temperature	± 1 °C
Humidity	± 5 %
DC and low frequency voltages	±3 %



### 3. General Product Information

#### 3.1 Product Function and Intended Use

The EUT is a LoRa Transceiver module for the sub-1GHz 915MHz ISM band. It contains ATSAMR34J18B SiP (System in Package), 32.768 KHz Crystal, 32 MHz TCXO, RF Switch, Lumped element harmonics rejection filter, impedance matching circuits, LPF, RF shield and U.FL connector for External Antenna in a compact 17mm x 13.5mm size. It enables the user to communicate data through a Wireless interface. The module variant WLR089UC integrates Trust&GO/Flex option which is a Pre-configured and Pre-provisioned Secure Element of Microchip's family of security focused devices for LoRaWAN™ Networks. For details refer to the User Guide, Data Sheet and Circuit Diagram.

#### 3.2 System Details and Ratings

**Table 4: Basic Information of EUT**

Item	EUT information
Kind of Equipment/Test Item	Low Power LoRa® Sub-1GHz Module
Type Identification	WLR089U0, WLR089UC
FCC ID	2ADHKR34M
Canada ID	20266-R34M
Canada HVIN	WLR089U0, WLR089UC

**Table 5: Technical Specification of EUT**

Technical Specification	Value
Operating Frequencies	902.3MHz to 927.5MHz / 902.3MHz to 927.3MHz
Channel number	64 / 26
Channel Separation	200 kHz / 1MHz
Operation Voltage	1.8V DC to 3.3V DC for WLR089U0, 2V DC to 3.3V DC for WLR089UC. EVB is supplied with 5V via USB, this is regulated to 3.3V and supplied to DUT
Modulation	LoRa
Channel Bandwidth	125KHz
Spreading Factor (SF)	7 to 10
Antenna gain	Refer to Table 6

**Table 6: Antenna List**

Antenna #1 selected for RSE measurements.

SIno.	Part Number	Manufacturer	Peak Antenna Gain	Antenna type	Cable Length/Remarks
1	RFA-S1-C55H1-150D034	ALEAD technology	2.0dBi	half-wave dipole	150mm
2	TH-89F-150mm-IPEX	BJTEK NAVIGATION, INC.	1.5dBi	half-wave dipole	150mm
3	GWF-152XMPXX-H015	Joymax Electronics Co., Ltd	2dBi	1/2 Wavelength Dipole Antenna	153mm
4	GWF-152XRSXX-H015	Joymax Electronics Co., Ltd	2dBi	1/2 Wavelength Dipole Antenna	Antenna has 156mm cable with RP-SMA plug and RP-SMA receptacle to u.FL cable of length 50mm used as adapter (Refer note 1 and 2)
5	6610D13081-100	Kinsun	2dBi	1/2-λ , Dipole	100mm
6	6610C03061	Kinsun	2dBi	1/2-λ , Dipole	RP-SMA receptacle to u.FL cable of length 203.20mm used as adapter (Refer note 1 and 2)
7	RFDPA131015IMBB301	PSA Walsin technology Corporation	0.90 dBi	Dipole Antenna	150mm
8	RFA-ZW-C55-B-RP-D034	ALEAD technology	2.0dBi	half-wave dipole	RP-SMA receptacle to u.FL cable of length 203.20mm used as adapter (Refer note 1 and 2)

Note:

- 1) If the end-product using the Module is designed to have an antenna port that is accessible to the end-user then a unique antenna connector (as permissible by FCC) must be used (e.g. RP (Reverse Polarity)-SMA socket).
- 2) If an RF coaxial cable is used between the module RF output and the enclosure, the a unique antenna connector must be used in the enclosure wall for interface with antenna.

All the antennas have the same type and similar in radiated characteristics, can be figured as equivalent antennas, and the antenna 1 with highest gain was selcted for full test.

### **3.3 Independent Operation Modes**

Basic operation modes are:

- A. Transmitting
- B. Receiving
- C. Hopping
- D. Idle
- E. Standby
- F. Backup

### **3.4 Noise Generating and Noise Suppressing Parts**

Refer to the Circuit Diagram.

### **3.5 Submitted Documents**

- Circuit Diagram
- Instruction Manual
- Rating Label
- Technical Description

## 4. Test Set-up and Operation Modes

### 4.1 Principle of Configuration Selection

The equipment under test (EUT) was configured to measure its maximum power level. The test modes were adapted accordingly in reference to the instructions for use.

The worst sample identified as primary model for testing is 'with Trust&Go/Flex'. Radiated spot check were conducted for other Test samples - 'without Trust&Go/Flex' and samples with Alternate Components.

Model No.	Description
WLR089U0	Module with U.FL Connector for External Antenna
WLR089UC	Module with U.FL Connector for External Antenna and Trust&Go/Flex

### 4.2 Test Operation and Test Software

Setup for testing: Test samples are provided with a USB interface which makes it possible to control them through a test software installed on a notebook computer.

This software was running on the laptop computer connected to the EUT. It was used to enable the operation modes listed in section 3.3 as appropriate.

Test Sample Configuration:

Model No.	Module Description	Sample No.
WLR089UC	Module with U.FL Connector for External Antenna and Trust&Go/Flex	A002808320-001
WLR089U0	Module with U.FL Connector for External Antenna	A002821243-001
WLR089UC	Module (Alternate Components) with U.FL Connector for External Antenna and Trust&Go/Flex	A002809975-004
WLR089U0	Module (Alternate Components) with U.FL Connector for External Antenna	A002809975-002

Full test was applied on all test modes, but only worst case was shown

<b>Test Software</b>	fcc_red.py
<b>Power setting</b>	20
<b>Spreading Factor (SF)</b>	10

### 4.3 Special Accessories and Auxiliary Equipment

The product has been tested together with the following additional accessories:

Description	Manufacturer	Model No.	Serial No.
Notebook	Lenovo	TP00048A	PB-0F8B2

### 4.4 Countermeasures to achieve EMC Compliance

No additional measures were employed to achieve compliance.

## 4.5 Test Setup Diagram

### Diagram of Measurement Configuration for Radiation Test

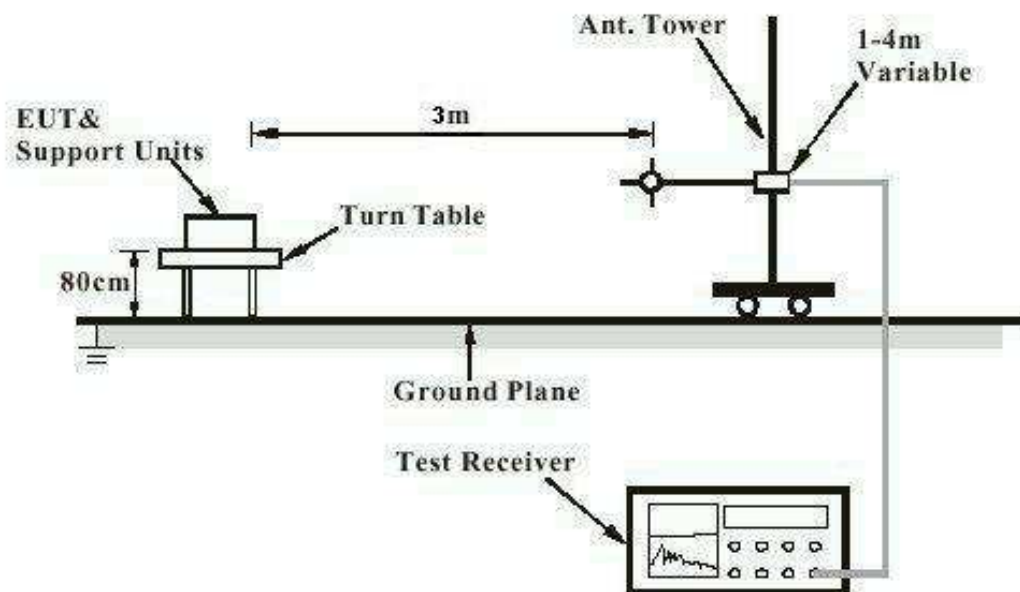

Note: Measurements above 1 GHz are done with a table height of 1.5m

**Diagram of Measurement Equipment Configuration for Mains Conduction Measurement (if applicable)**

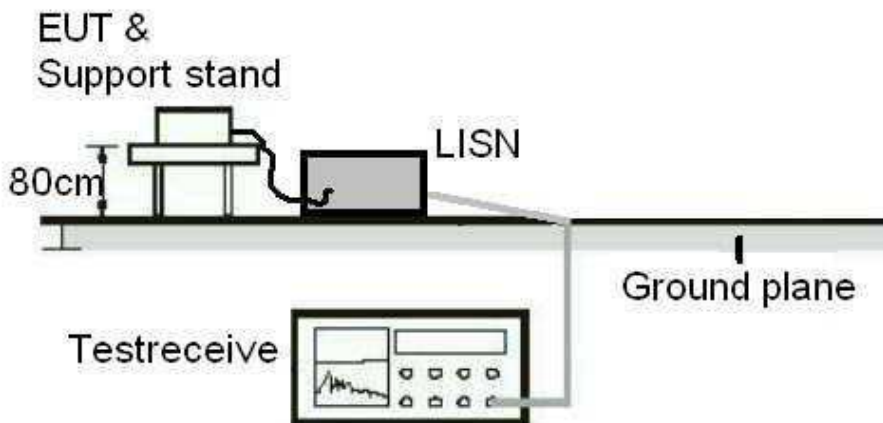

**Diagram of Measurement Equipment Configuration for Conducted Transmitter Measurement**

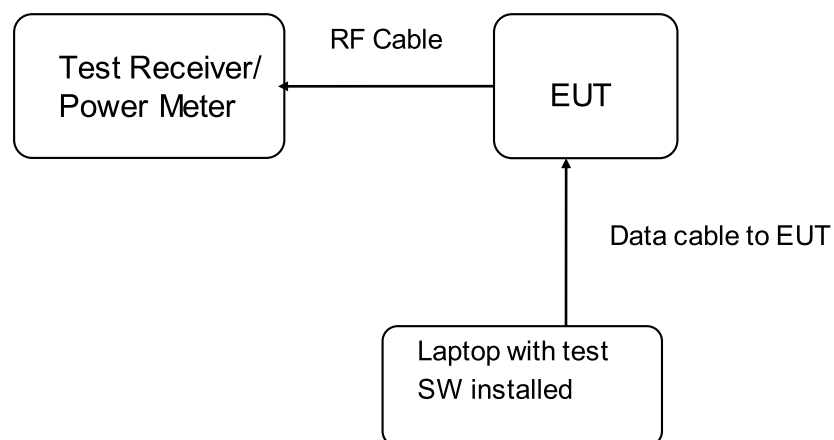

## 5. Test Results

### 5.1 Transmitter Requirement & Test Suites

#### 5.1.1 Antenna Requirement

**RESULT:** **Passed**

Test standard : FCC Part 15.247(b)(4), Part 15.203 and ISSED  
RSS-Gen 6.8

According to the manufacturer declaration, the antenna is not part of the module. The Module has an U.FL connector for external antenna connection; only the antenna tested and approved with Max Gain 2dBi in Table 6 is allowed for use by the end-user. Therefore, the EUT is considered to comply with this provision.

Refer to EUT photo for details.



## 5.1.2 Maximum conducted (average) output power

**RESULT:**
**Passed**

Test standard : FCC Part 15.247(b)(1), ISED RSS-247 5.4(b)  
 Basic standard : ANSI C63.10:2013, KDB558074  
 Limit : 1 Watt  
 Kind of test site : Shielded room

**Test setup**

Test Channel : Low/ Middle/ High  
 Operation Mode : A  
  
 Ambient temperature : 20-24 °C  
 Relative humidity : 50-65 %  
 Atmospheric pressure : 100-103 kPa

**Table 7: Test result of Maximum conducted (average) output power**

Channel	Channel Frequency (MHz)	Output Power		Peak Power (Reference)	Limit
		(dBm)	(W)	(dBm)	(W)
Low Channel	902.3	17.66	0.05834	17.77	1
Middle Channel	914.9	17.69	0.05875	17.79	1
High Channel	927.5	17.71	0.05902	17.81	1
<b>Max EIRP</b>	-	<b>19.71</b>	<b>0.09354</b>	<b>19.81</b>	-

Pmax: 59.02 mW

### 5.1.3 Frequency Separation

**RESULT:**
**Passed**

Test standard : FCC part 15.247(a)(1), ISED RSS-247 5.1(b)  
 Basic standard : ANSI C63.10:2013  
 Limit :  $\geq 25\text{kHz}$  or 20dB bandwidth, whichever is greater

**Test setup**

Test Channel : Hopping on  
 Operation Mode : C  
 Ambient temperature : 24 °C  
 Relative humidity : 53%

**Table 8: Test result of Frequency Separation (26 channels)**

Channel	Channel Frequency (MHz)	Measured Channel Separation (MHz)	Limit (kHz)	Result
Record Channel	914.2	1	$\geq 25\text{kHz}$ or 20dB bandwidth	Pass
Record Channel adj 1	915.2			
Record Channel adj 2	916.2			

**Table 9: Test result of Frequency Separation (64 channels)**

Channel	Channel Frequency (MHz)	Measured Channel Separation (MHz)	Limit (kHz)	Result
Record Channel	908.45	0.2	$\geq 25\text{kHz}$ or 20dB bandwidth	Pass
Record Channel adj 1	908.65			
Record Channel adj 2	908.85			

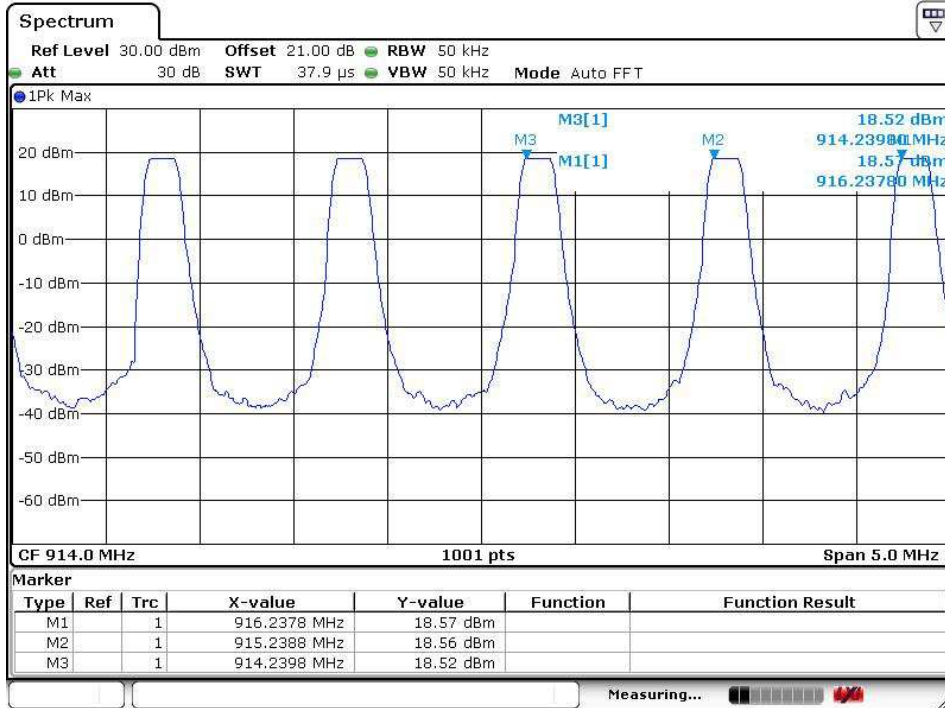
**Hopping on for 26 channels**

Date: 5.MAY.2020 13:01:28

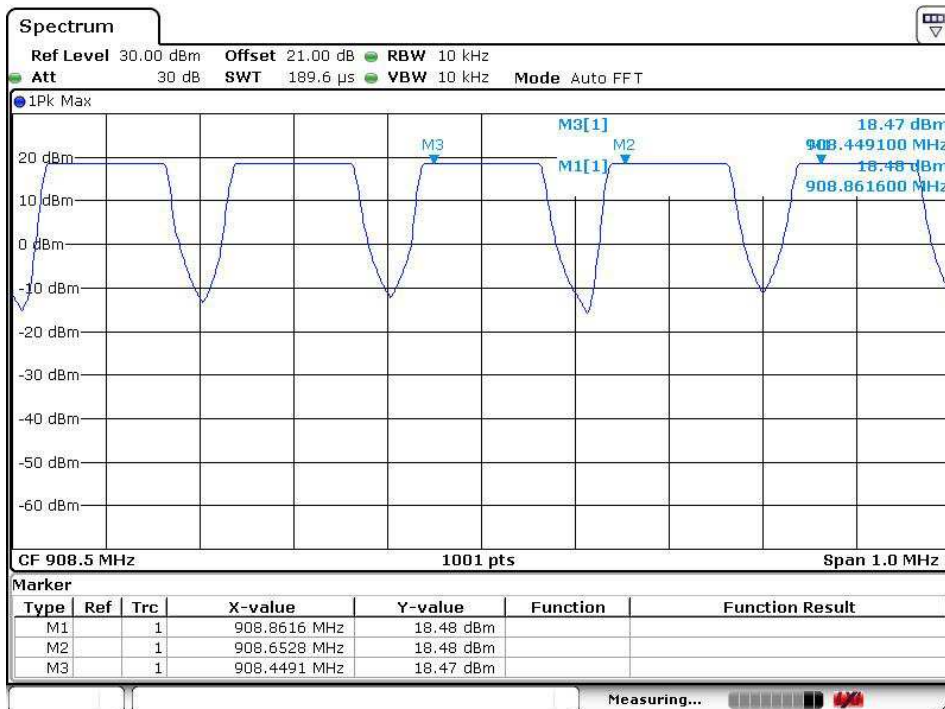
**Hopping on for 64 channels**

Date: 5.MAY.2020 13:24:32

### 5.1.4 20dB Bandwidth and 99% Bandwidth

**RESULT:**
**Passed**

Test standard : FCC Part 15.247(a)(1)(i), ISED RSS-247 5.2(a), ISED RSS-Gen  
 Basic standard : ANSI C63.10:2013, KDB558074, ISED Gen  
 Kind of test site : Shielded room

**Test setup**

Test Channel : Low/ Middle/ High  
 Operation Mode : A

Ambient temperature : 20-24°C  
 Relative humidity : 50-65%  
 Atmospheric pressure : 100-103 kPa

**Table 10: Test result of 20dB Bandwidth**

Channel	Channel Frequency (MHz)	20dB Bandwidth (kHz)
Low Channel	902.3	138.9
Mid Channel	914.9	138.9
High Channel	927.5	138.9

**Table 11: Test result of 99% Bandwidth**

Channel	Channel Frequency (MHz)	99% Bandwidth (kHz)
Low Channel	902.3	127.35
Mid Channel	914.9	127.35
High Channel	927.5	127.35

## Test Plot of 20dB Bandwidth, 125KHz bandwidth

### Low Channel

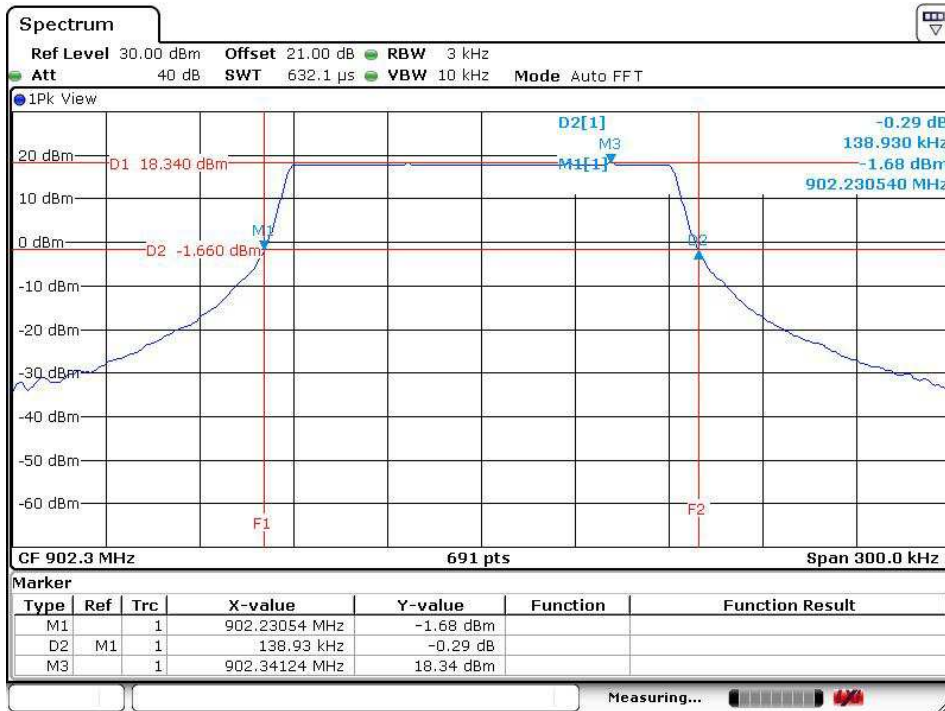

Date: 5.MAY.2020 09:10:32

### Middle Channel

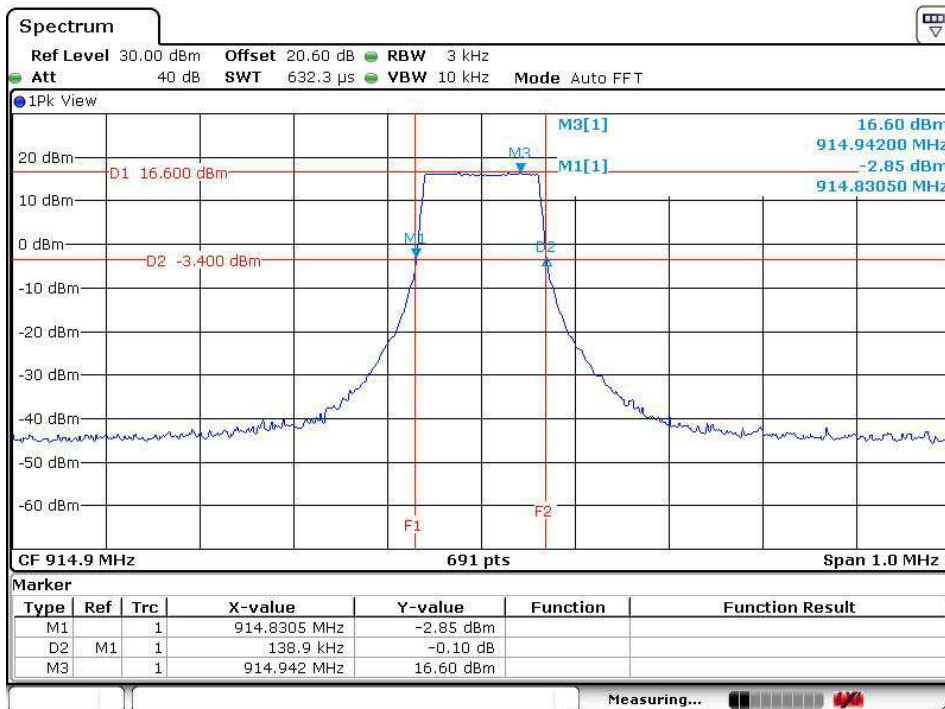

Date: 13.JUL.2020 09:14:31

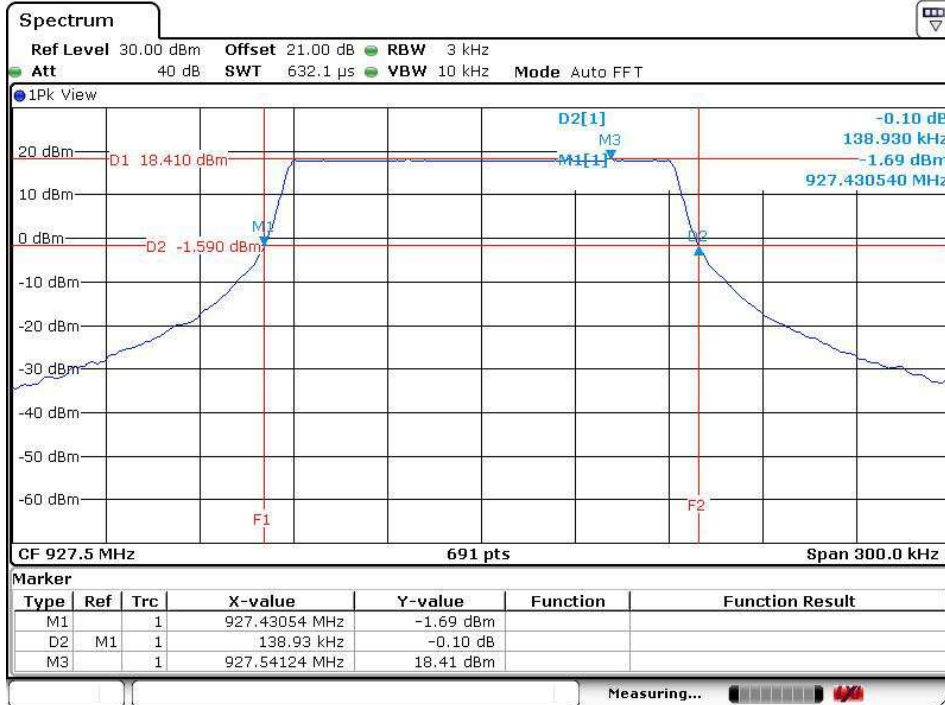
**High Channel**

Date: 5.MAY.2020 09:51:02

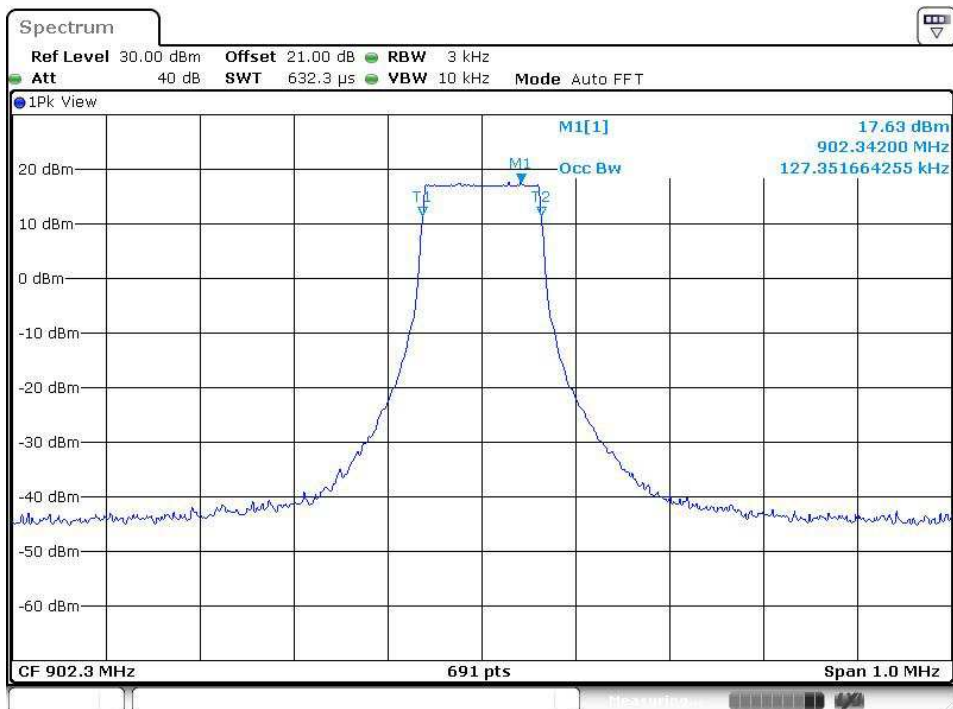
**Test Plot of 99% Bandwidth, 125KHz bandwidth**
**Low Channel**

Date: 5.JUN.2020 12:42:17

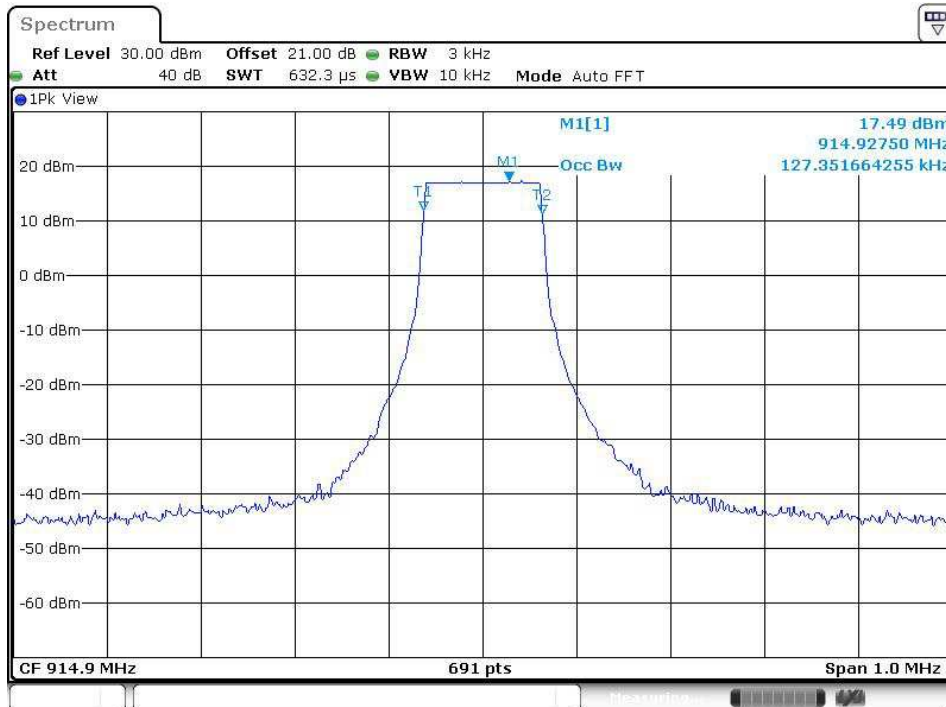
**Middle Channel**

Date: 5.JUN.2020 12:48:01

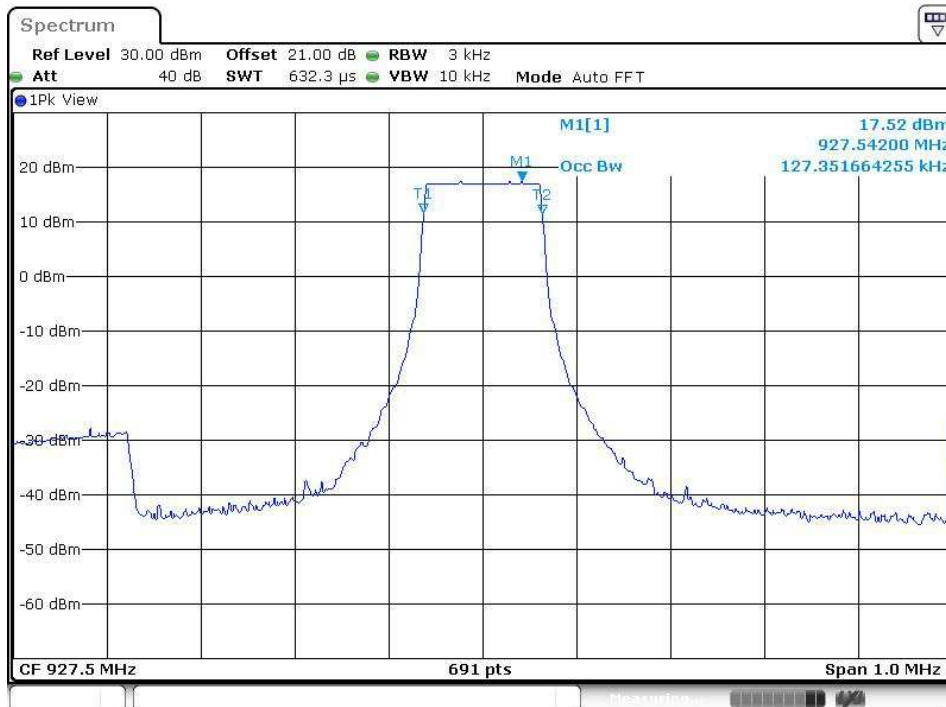
**High Channel**

Date: 5.JUN.2020 12:52:45

### 5.1.5 Power Density

**RESULT:**
**Passed**

Test standard : FCC Part 15.247(f) , ISED RSS-247 5.2(b)  
 Basic standard : ANSI C63.10:2013, KDB558074  
 Kind of test site : Shielded room

**Test setup**

Test Channel : Low/ Middle/ High  
 Operation Mode : A  
 Ambient temperature : 20-24°C  
 Relative humidity : 50-65%  
 Atmospheric pressure : 100-103 kPa

**Table 12: Test result of Power Density**

Channel	Channel Frequency (MHz)	Power Density	Limit
		(dBm)	(dBm)
Low Channel	902.3	2.15	8
Middle Channel	914.9	2.88	8
High Channel	927.5	2.16	8



## Test Plot of Power Density (125kHz Bandwidth)

### Low Channel



Date: 6.JUL.2020 13:31:49

### Middle Channel

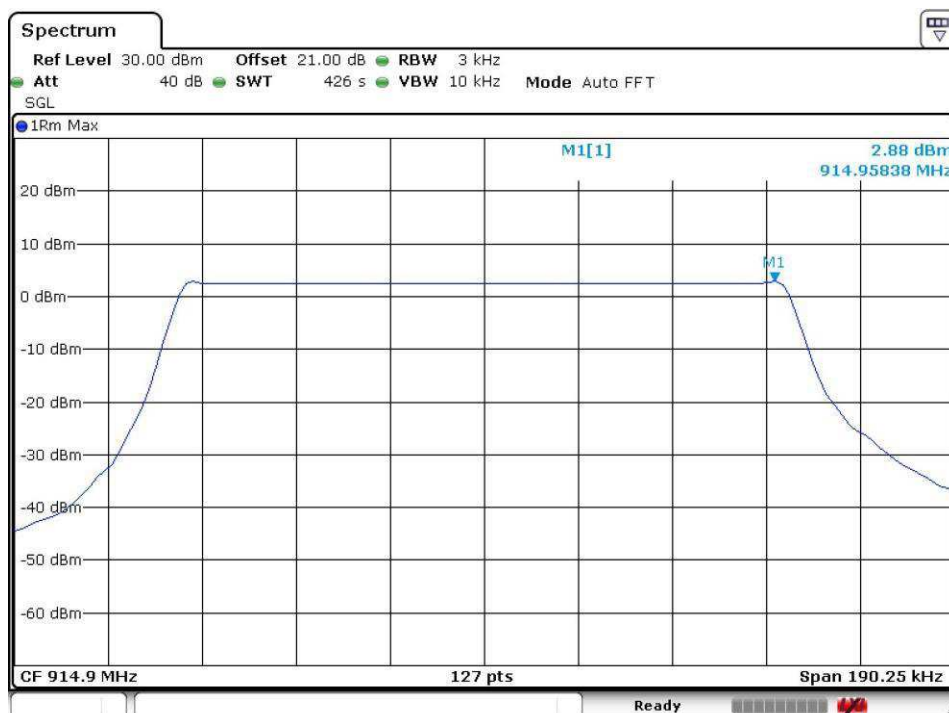

Date: 24.APR.2020 17:05:43

**High Channel**

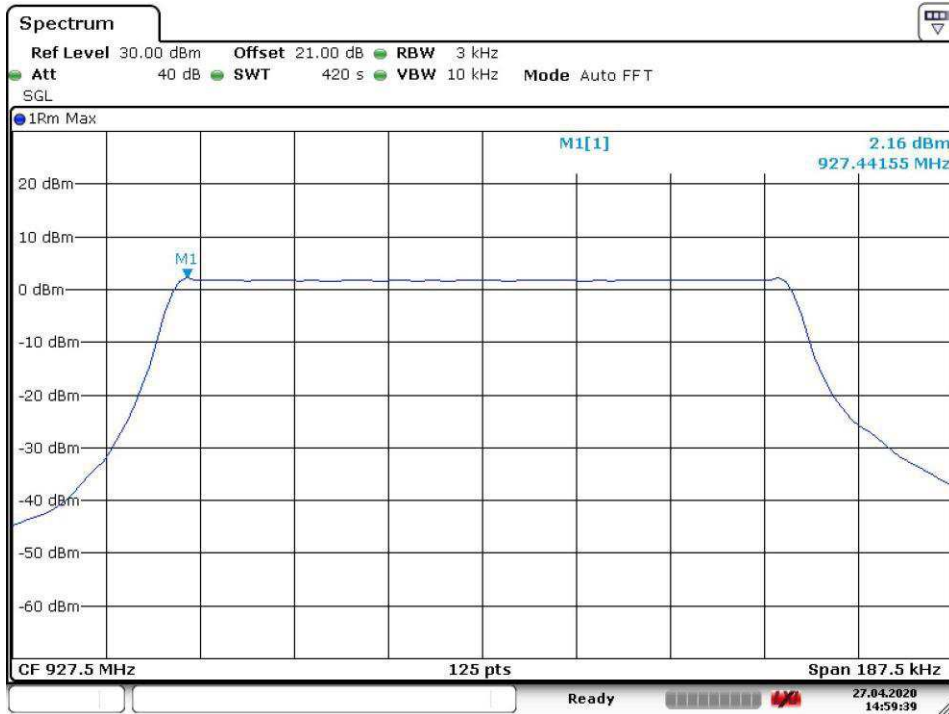

Date: 27.APR.2020 14:59:39

### 5.1.6 Conducted spurious emissions and Frequency Band Edge measured in 100kHz Bandwidth

**RESULT:****Passed**

Test standard : FCC part 15.247(d), ISED RSS-247 5.5  
Basic standard : ANSI C63.10:2013, KDB558074  
Limit : 30dB (below that in the 100kHz bandwidth within the band that contains the highest level of the desired power)  
Kind of test site : Shielded room

**Test setup**

Test Channel : Low/ Middle/ High for Conducted Spurious Emissions  
Low/ High/ Hopping for Frequency Band Edge  
Operation Mode : A, C  
Ambient temperature : 20-24°C  
Relative humidity : 50-65%  
Atmospheric pressure : 100-103 kPa

All emissions are more than 30dB below fundamental, details refer to following test plot, and compliance is achieved as well.

Due to the small size of the product and that there are no inductive components of significant size, 9kHz to 30MHz frequency range is not tested based on technical judgment.

## Test Plot 100kHz Conducted Emissions

### Low Channel

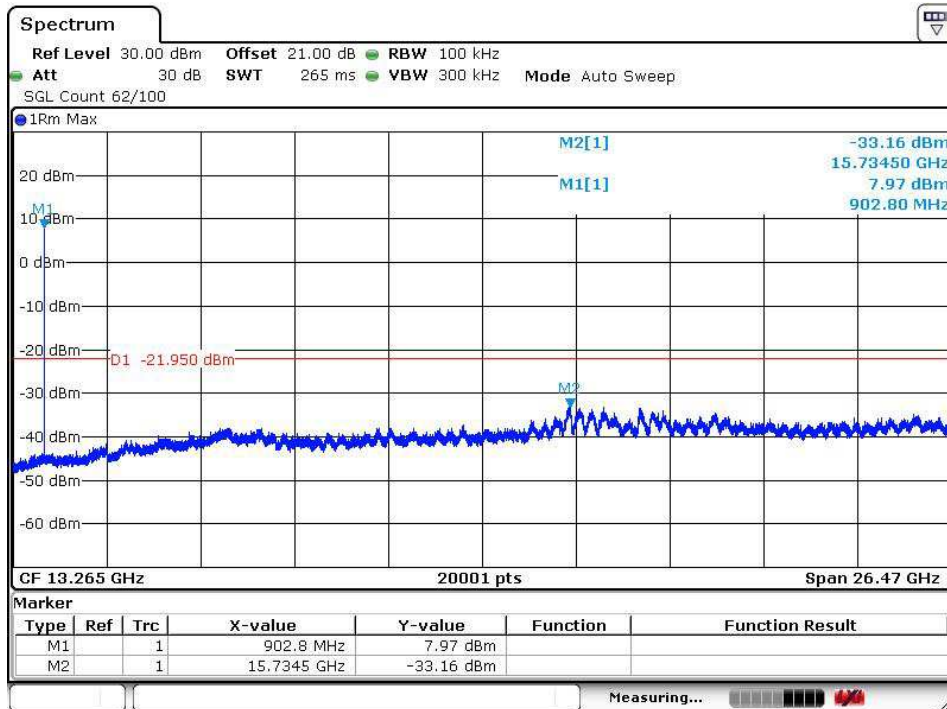

Date: 5.MAY.2020 10:32:17

### Middle Channel

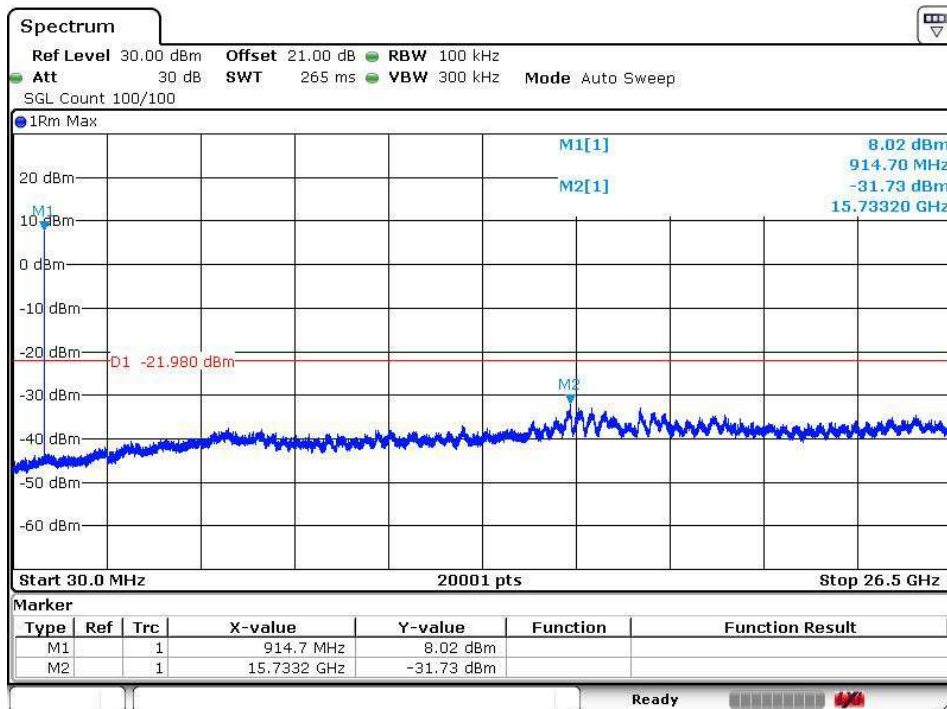

Date: 5.MAY.2020 10:37:56

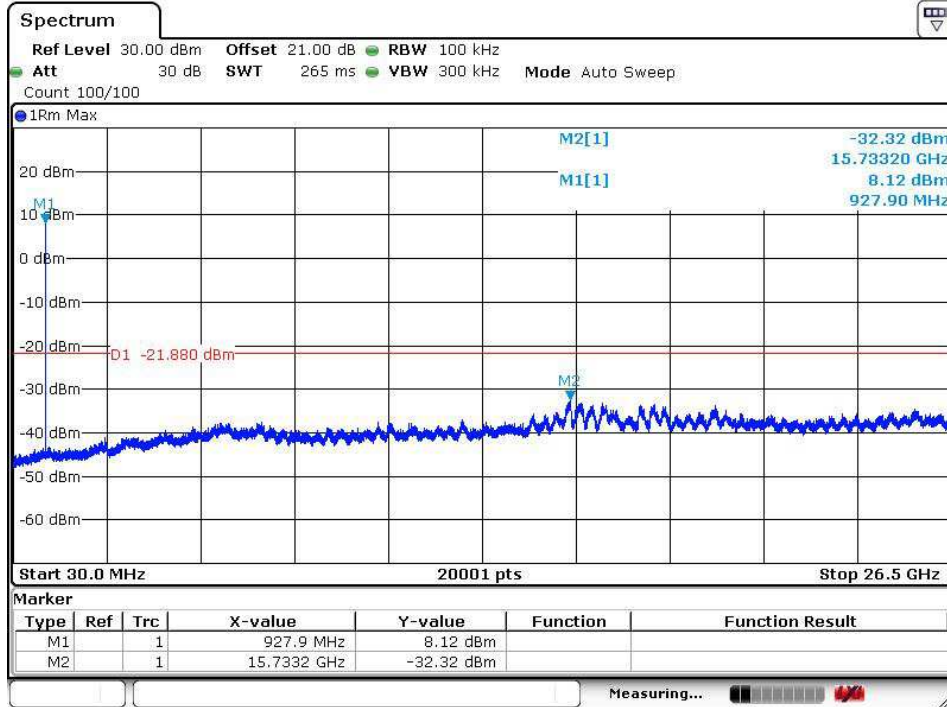
**High Channel**

Date: 5.MAY.2020 10:49:49

## Test Plot 100kHz RBW of Band Edge

### Low Channel

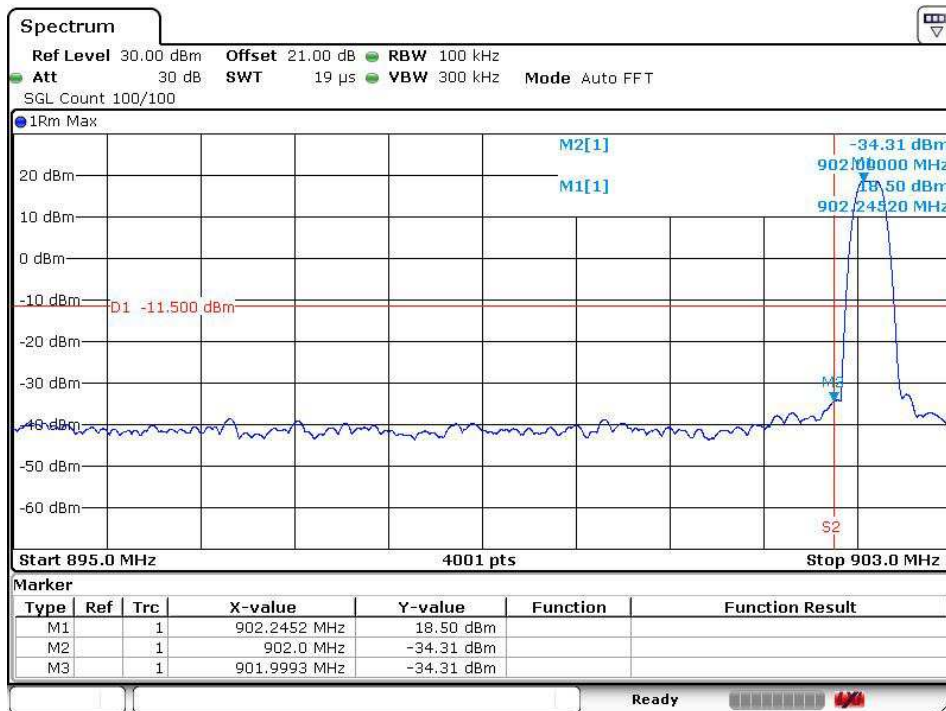

Date: 5.MAY.2020 11:03:37

### High Channel

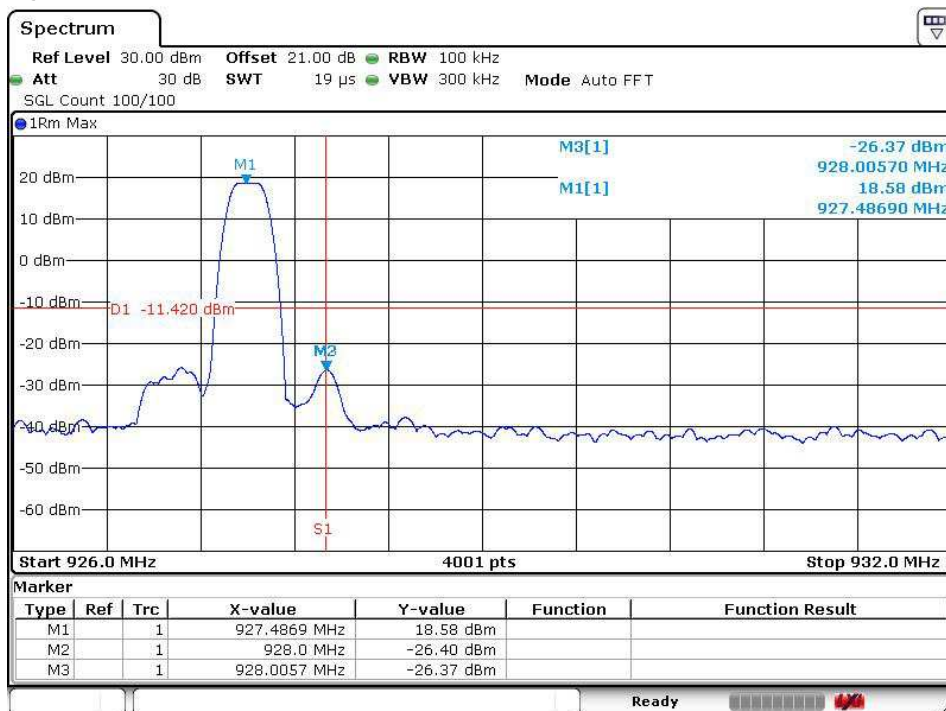

Date: 5.MAY.2020 11:07:36

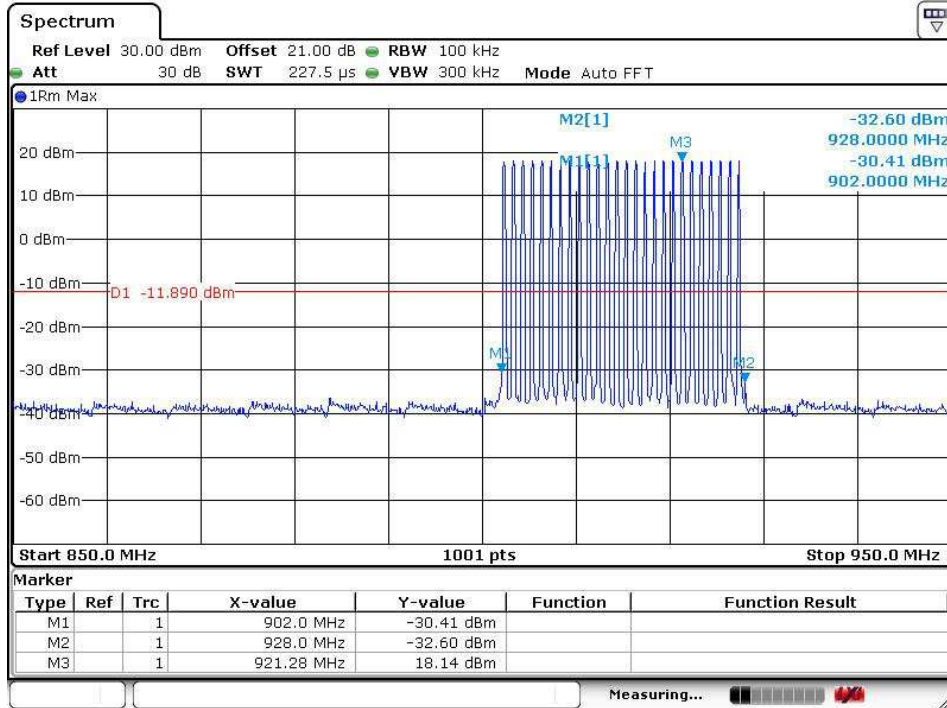
**Hopping on for 26 channels**

Date: 5.MAY.2020 14:17:36

Note: Hopping on for 26 channels were worst case.

### 5.1.7 Time of Occupancy

**RESULT:**
**Passed**

Test standard : FCC part 15.247(f), ISED RSS-247 5.3(a)  
 Basic standard : ANSI C63.10:2013  
 Limits : 0.4s  
 Kind of test site : Shield room

**Test setup**

Test Channel : Hopping on  
 Operation Mode : C  
  
 Ambient temperature : 20-24°C  
 Relative humidity : 50-65%  
 Atmospheric pressure : 100-103 kPa

**Table 13: Test result of Time of Occupancy**

Hopping channels	Captured Burst (ms)	Dwell time (ms)	Limit (ms)	Result
26	326.1	326.1	400	Pass
64	304.3	304.3	400	Pass



## Test Plot of Time of Occupancy

### Hopping on for 26 channels

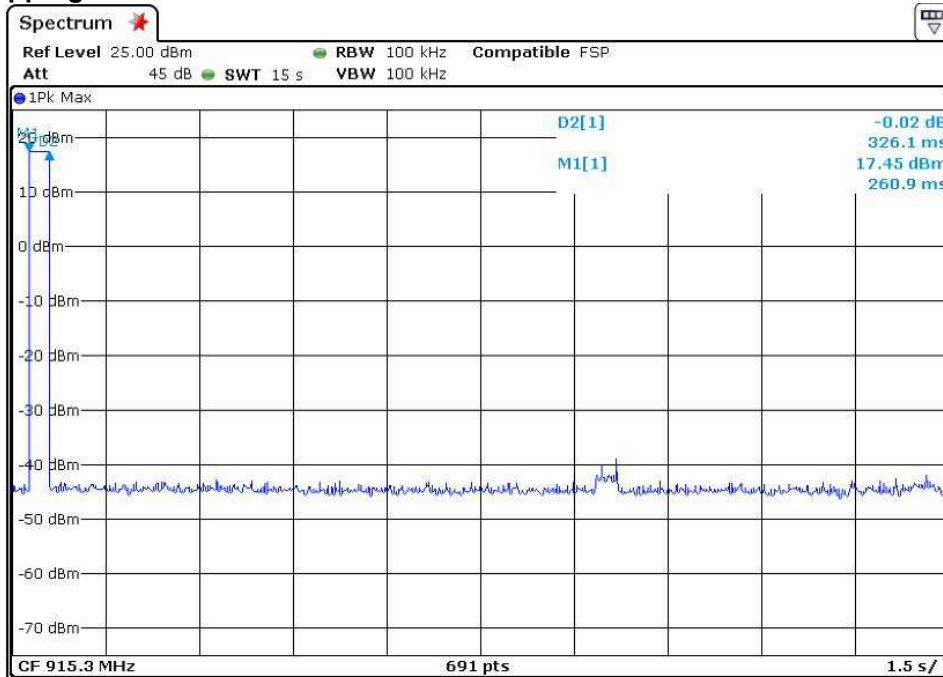

### Hopping for 64 channels

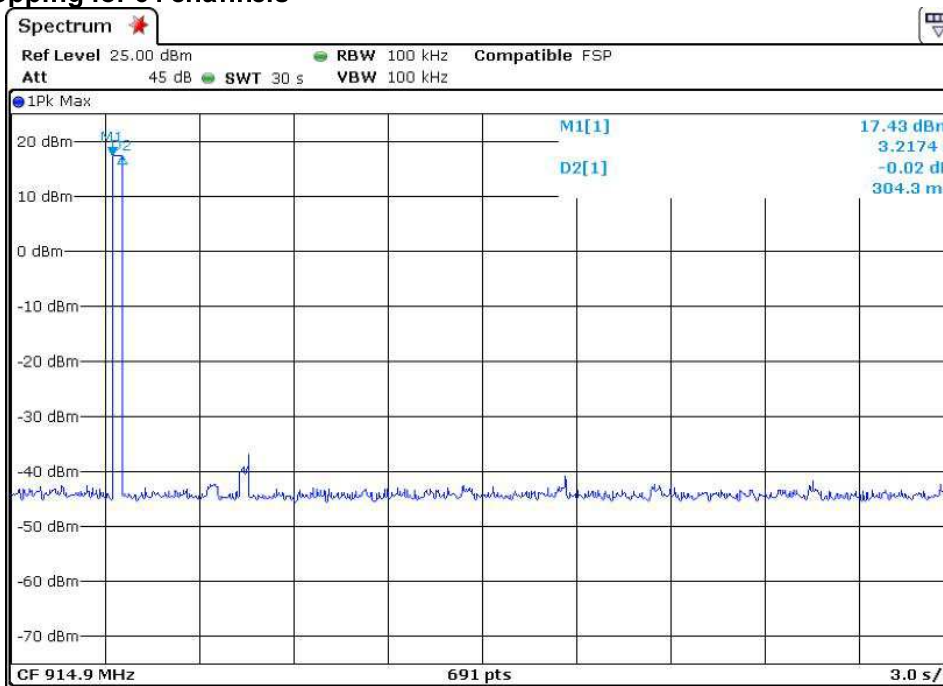

## 5.1.8 Spurious Emission

**RESULT:****Passed**

Test standard	:	FCC part 15.247(d), FCC 15.205, FCC 15.209 and ISED RSS-Gen 8.9, ISED RSS-Gen 8.10
Basic standard	:	ANSI C63.10: 2013
Limits	:	Radiated emissions which fall in the restricted bands, as defined in FCC 15.205(a) and ISED RSS-Gen i5, 8.10 (Table 7), must comply with the radiated emission limits specified in FCC 15.209(a) and ISED RSS-Gen 5, 8.9 (Table 5 and 6). Emission radiated outside the restricted and authorized frequency bands must either comply with the radiated emission limits specified for the restricted bands or in FCC15.247(d) and ISED RSS-247 i2, 5.5
Kind of test site	:	3m Semi-Anechoic Chamber
<b>Test setup</b>		
Test Channel	:	Low/ Middle/ High
Operation mode	:	A
Ambient temperature	:	20-24 °C
Relative humidity	:	50-65 %
Atmospheric pressure	:	100-103 kPa

For details refer to Appendix D.

The Radiated Emissions testing was performed in the X, Y and Z axis orientation. The worst-case Axis orientation is recorded in this test report.

## 5.2 Mains Emissions

### 5.2.1 Mains Conducted Emissions

**RESULT:****Passed**

Test standard : FCC Part 15.207, FCC Part 15.107,  
ISED RSS-Gen 8.8

Limits : Mains Conducted emissions as defined in  
above test standards must comply with the  
mains conducted emission limits specified

Kind of test site : Shielded Room

**Test setup**

Test Channel : 902.3MHz

Operation mode : Normal

Ambient temperature : 20-24 °C

Relative humidity : 50-65 %

Atmospheric pressure : 100-103 kPa

Remark: For details refer to Appendix D.

## 6. Safety Human exposure

### 6.1 Radio Frequency Exposure Compliance

#### 6.1.1 Electromagnetic Fields

**RESULT:****Passed**

Test standard : FCC KDB Publication 447498 D01,  
ISED RSS-102 issue 5, Table 4

FCC:

Since the maximum output power of the transmitter is 59.02 mW < 63 mW (Distance: 20 mm), hence the EUT is excluded from SAR evaluation according to FCC KDB publication 447498 D01: Mobile Portable RF Exposure.

ISED:

Maximum conducted average power: 59.02 mW  
Antenna Gain: 2 dBi  
Maximum EIRP available 93.54 mW

Since maximum output power of the transmitter is 93.54 mW < 95.72 mW (distance ≤ 35 mm), hence the EUT is excluded from SAR evaluation according to Table 1 in RSS-102. For limb-worn devices where the 10 gram value applies, the exemption limits for routine evaluation in Table 1 of RSS-102 are multiplied by a factor of 2.5.

**---End---**

## 7. List of Tables

Table 1: Applied Standard and Test Levels .....	5
Table 2: List of Test and Measurement Equipment.....	7
Table 3: Emission Measurement Uncertainty .....	8
Table 4: Basic Information of EUT.....	9
Table 5: Technical Specification of EUT .....	9
Table 6: Antenna List .....	10
Table 7: Test result of Maximum conducted (average) output power.....	17
Table 8: Test result of Frequency Separation (26 channels) .....	18
Table 9: Test result of Frequency Separation (64 channels) .....	18
Table 10: Test result of 20dB Bandwidth .....	20
Table 11: Test result of 99% Bandwidth .....	20
Table 12: Test result of Power Density .....	24
Table 13: Test result of Time of Occupancy .....	32