

<b>Prüfbericht-Nr.:</b> <i>Test Report No.:</i>	<b>50175101 001</b>	<b>Auftrags-Nr.:</b> <i>Order No.:</i>	114077828	Seite 1 von 40 <i>Page 1 of 40</i>	
<b>Kunden-Referenz-Nr.:</b> <i>Client Reference No.:</i>	N/A	<b>Auftragsdatum:</b> <i>Order date:</i>	22-May-2018		
<b>Auftraggeber:</b> <i>Client:</i>	Microchip Technology Inc. 2355 West Chandler Blvd. Chandler, Arizona 85224-6199, United States.				
<b>Prüfgegenstand:</b> <i>Test item:</i>	SAM R34 Xplained Pro Evaluation Kit				
<b>Bezeichnung / Typ-Nr.:</b> <i>Identification / Type No.:</i>	A09-3167				
<b>Auftrags-Inhalt:</b> <i>Order content:</i>	FCC Part 15C / ISED RSS-247 Test report (LoRa)				
<b>Prüfgrundlage:</b> <i>Test specification:</i>	FCC 47CFR Part 15: Subpart C Section 15.247(Hybrid) RSS-247 ISSUE 2 FEB 2017				
<b>Wareneingangsdatum:</b> <i>Date of receipt:</i>	05-Jul-2018				
<b>Prüfmuster-Nr.:</b> <i>Test sample No.:</i>	A000769530-001				
<b>Prüfzeitraum:</b> <i>Testing period:</i>	09-Aug-2018 – 05-Sep-2018				
<b>Ort der Prüfung:</b> <i>Place of testing:</i>	EMC/RF Laboratory Taipei				
<b>Prüflaboratorium:</b> <i>Testing laboratory:</i>	TUV Rheinland Taiwan Ltd.				
<b>Prüfergebnis*:</b> <i>Test result*:</i>	Pass				
<b>Report date / tested by:</b>		<b>kontrolliert von / reviewed by:</b>			
05-Sep-2018	Jack Chang / Project Manager	05-Sep-2018	Arvin Ho/Vice General Manager		
<b>Datum</b> <i>Date</i>	<b>Name / Stellung</b> <i>Name / Position</i>	<b>Unterschrift</b> <i>Signature</i>	<b>Datum</b> <i>Date</i>	<b>Name / Stellung</b> <i>Name / Position</i>	<b>Unterschrift</b> <i>Signature</i>
<b>Sonstiges / Other:</b>					
<b>Zustand des Prüfgegenstandes bei Anlieferung:</b> <i>Condition of the test item at delivery:</i>		Prüfmuster vollständig und unbeschädigt <i>Test item complete and undamaged</i>			
* Legende:	1 = sehr gut P(ass) = entspricht o.g. Prüfgrundlage(n)	2 = gut F(ail) = entspricht nicht o.g. Prüfgrundlage(n)	3 = befriedigend N/A = nicht anwendbar	4 = ausreichend N/T = nicht getestet	5 = mangelhaft N/T = nicht getestet
Legend:	1 = very good P(ass) = passed a.m. test specification(s)	2 = good F(ail) = failed a.m. test specification(s)	3 = satisfactory N/A = not applicable	4 = sufficient N/T = not tested	5 = poor N/T = not tested
<p><b>Dieser Prüfbericht bezieht sich nur auf das o.g. Prüfmuster und darf ohne Genehmigung der Prüfstelle nicht auszugsweise vervielfältigt werden. Dieser Bericht berechtigt nicht zur Verwendung eines Prüfzeichens.</b>  <i>This test report only relates to the a. m. test sample. Without permission of the test center this test report is not permitted to be duplicated in extracts. This test report does not entitle to carry any test mark.</i></p>					

## TEST SUMMARY

### 5.1.1 ANTENNA REQUIREMENT

RESULT: *Passed*

### 5.1.2 MAXIMUM CONDUCTED (AVERAGE) OUTPUT POWER

RESULT: *Passed*

### 5.1.3 20dB BANDWIDTH AND 99% BANDWIDTH

RESULT: *Passed*

### 5.1.4 POWER DENSITY

RESULT: *Passed*

### 5.1.5 CONDUCTED SPURIOUS EMISSIONS AND FREQUENCY BAND EDGE MEASURED IN 100KHZ BANDWIDTH

RESULT: *Passed*

### 5.1.6 FREQUENCY SEPARATION

RESULT: *Passed*

### 5.1.7 TIME OF OCCUPANCY

RESULT: *Passed*

### 5.1.8 SPURIOUS EMISSION

RESULT: *Passed*

### 5.2.1 MAINS CONDUCTED EMISSIONS

RESULT: *Passed*

### 6.1.1 ELECTROMAGNETIC FIELDS

RESULT: *Passed*

## Contents

<b>1.</b>	<b>GENERAL REMARKS .....</b>	<b>5</b>
<b>1.1</b>	<b>COMPLEMENTARY MATERIALS.....</b>	<b>5</b>
<b>2.</b>	<b>TEST SITES .....</b>	<b>6</b>
<b>2.1</b>	<b>TEST LABORATORY .....</b>	<b>6</b>
<b>2.2</b>	<b>TEST FACILITY.....</b>	<b>6</b>
<b>2.3</b>	<b>LIST OF TEST AND MEASUREMENT INSTRUMENTS.....</b>	<b>7</b>
<b>2.4</b>	<b>TRACEABILITY .....</b>	<b>8</b>
<b>2.5</b>	<b>CALIBRATION .....</b>	<b>8</b>
<b>2.6</b>	<b>MEASUREMENT UNCERTAINTY .....</b>	<b>8</b>
<b>3.</b>	<b>GENERAL PRODUCT INFORMATION.....</b>	<b>9</b>
<b>3.1</b>	<b>PRODUCT FUNCTION AND INTENDED USE .....</b>	<b>9</b>
<b>3.2</b>	<b>SYSTEM DETAILS AND RATINGS.....</b>	<b>9</b>
<b>3.3</b>	<b>INDEPENDENT OPERATION MODES.....</b>	<b>10</b>
<b>3.4</b>	<b>NOISE GENERATING AND NOISE SUPPRESSING PARTS .....</b>	<b>10</b>
<b>3.5</b>	<b>SUBMITTED DOCUMENTS.....</b>	<b>10</b>
<b>4.</b>	<b>TEST SET-UP AND OPERATION MODES.....</b>	<b>11</b>
<b>4.1</b>	<b>PRINCIPLE OF CONFIGURATION SELECTION .....</b>	<b>11</b>
<b>4.2</b>	<b>TEST OPERATION AND TEST SOFTWARE.....</b>	<b>11</b>
<b>4.3</b>	<b>SPECIAL ACCESSORIES AND AUXILIARY EQUIPMENT .....</b>	<b>11</b>
<b>4.4</b>	<b>COUNTERMEASURES TO ACHIEVE EMC COMPLIANCE.....</b>	<b>12</b>
<b>4.5</b>	<b>TEST SETUP DIAGRAM .....</b>	<b>12</b>
<b>5.</b>	<b>TEST RESULTS .....</b>	<b>14</b>
<b>5.1</b>	<b>TRANSMITTER REQUIREMENT &amp; TEST SUITES.....</b>	<b>14</b>
<b>5.1.1</b>	<i>Antenna Requirement .....</i>	<i>14</i>
<b>5.1.2</b>	<i>Maximum conducted (average) output power.....</i>	<i>15</i>
<b>5.1.3</b>	<i>Frequency Separation.....</i>	<i>16</i>
<b>5.1.4</b>	<i>20dB Bandwidth and 99% Bandwidth.....</i>	<i>18</i>
<b>5.1.5</b>	<i>Power Density .....</i>	<i>21</i>
<b>5.1.6</b>	<i>Conducted spurious emissions and Frequency Band Edge measured in 100kHz Bandwidth.....</i>	<i>24</i>
<b>5.1.7</b>	<i>Time of Occupancy .....</i>	<i>29</i>
<b>5.1.8</b>	<i>Spurious Emission .....</i>	<i>32</i>
<b>5.2</b>	<b>MAINS EMISSIONS.....</b>	<b>33</b>
<b>5.2.1</b>	<i>Mains Conducted Emissions.....</i>	<i>33</i>
<b>6.</b>	<b>SAFETY HUMAN EXPOSURE .....</b>	<b>34</b>

<b>6.1</b>	<b>RADIO FREQUENCY EXPOSURE COMPLIANCE .....</b>	<b>34</b>
6.1.1	<i>Electromagnetic Fields.....</i>	<i>34</i>
<b>7.</b>	<b>PHOTOGRAPHS OF THE TEST SET-UP.....</b>	<b>35</b>
<b>8.</b>	<b>LIST OF TABLES .....</b>	<b>40</b>
<b>9.</b>	<b>LIST OF PHOTOGRAPHS.....</b>	<b>40</b>

## 1. General Remarks

### 1.1 Complementary Materials

The following attachments are integral parts of this test report:

**Appendix P: Photo Documentation internal view**  
(File Name: 50175101 001 APPENDIX P)

**Appendix D: Test Result of Radiated Emissions**  
(File Name: 50175101 001 APPENDIX D)

Test Specifications

The following standards were applied.

**Table 1: Applied Standard and Test Levels**

<b>Radio</b>
FCC 47CFR Part 15: Subpart C Section 15.247 FCC 47CFR Part 2: Subpart J Section 2.1091 RSS-247 Issue 2 (Feb 2017) RSS-102 Issue 5 RSS-Gen, Issue 5, April 2018 ANSI C63.10:2013 KDB558074 D01 DTS Meas Guidance v04 KDB447498 D01 General RF Exposure Guidance v06

## 2. Test Sites

### 2.1 Test Laboratory

TUV Rheinland Taiwan Ltd.  
Taichung Branch Office

No.9, Lane 36, Minsheng Rd., Sec. 3, Daya District,  
Taichung City 428  
Taiwan (R.O.C.)

### 2.2 Test Facility

TUV Rheinland Taiwan Ltd.  
Taipei Office

11F. No.758, Sec. 4, Bade Rd., Songshan Dist.  
Taipei City 105  
Taiwan (R.O.C.)

FCC RegistrationNo.: 340738  
IC Canada Registration No.: 9465A-1  
TAF Accredited NCC Test Lab. No.:0759  
TAF ISO17025 Certification effective period: 2016-Jul-1st to 2019-Jun-30th



**Testing Laboratory**  
**0759**

## 2.3 List of Test and Measurement Instruments

**Table 2: List of Test and Measurement Equipment**

Kind of Equipment	Manu-facturer	Type	S/N	Last Calibration	Next Calibration
Test Software	Farad	EZ_EMG	Ver. TUV3A1	N/A	N/A
EMI Test Receiver	R&S	ESR 7	101062	2017/09/25	2018/09/25
Spectrum Analyzer	R&S	FSV 40	100921	2018/05/02	2019/05/02
EXA Signal Analyzer	KEYSIGHT	N9010A	MY52221334	2018/02/05	2019/02/05
Preamplifier (30MHz -1GHz)	HP	8447D	2944A06641	2017/12/26	2018/12/26
Preamplifier (18 GHz -40 GHz)	COM-POWER	PAM-840	461257	2018/01/18	2019/01/18
Pre-Amplifier (1GHz~18GHz)	EM Electronics	EM01G18G	60558	2017/11/21	2018/11/21
Bilog Antenna	TESEQ	CBL6111D	29804	2018/07/02	2019/07/02
Horn Antenna	ETS-Lindgren	3117	00138160	2018/06/01	2019/06/01
Horn Antenna (18GHz~40GHz)	COM-POWER	AH-840	101029	2017/11/28	2018/11/28
Loop Antenna	Schwarzbeck	FMZB 1513	1513-076	2018/06/21	2019/06/21
EMI Test Receiver	R&S	ESR 7	101549	2017/11/10	2018/11/10
Temp. & Humid. Chamber	Giant Force	GCT-099-40-S	MAF0103-007	2017/03/09	2019/03/09
LISN (1 phase)	R&S	ENV216	101243	2018/06/18	2019/06/18
LISN	R&S	ENV216	101262	2018/06/22	2019/06/22
Spectrum Analyzer	Agilent	N9010A	MY53470241	2018/06/04	2019/06/04
Test Software	Agilent	300328 testsystem	V1.9.1	N/A	N/A
Power sensor	Agilent	U2021XA	MY54020001	2018/03/31	2018/11/09

## 2.4 Traceability

All measurement equipment calibrations are traceable to NML(Taiwan)/NIST(USA) or where calibration is performed outside Taiwan, to equivalent nationally recognized standards organizations.

## 2.5 Calibration

Equipment requiring calibration is calibrated periodically in a suitably accredited Calibration Lab. Additionally all equipment is verified for proper performance on a regular schedule using in house standards or comparisons.

## 2.6 Measurement Uncertainty

The estimated combined standard uncertainty for radiated emissions and conducted emissions measurements .

**Table 3: Emission Measurement Uncertainty**

Parameter	Uncertainty
Radio Frequency	± 0.1 ppm
RF power, conducted	± 1.5 dB
RF power density, conducted	± 3 dB
spurious emissions, conducted	± 3 dB
all emissions, radiated	± 6 dB
Temperature	± 1 °C
Humidity	± 5 %
DC and low frequency voltages	±3 %



### 3. General Product Information

#### 3.1 Product Function and Intended Use

The EUT is a Low power transceiver LoRa Technology Evaluation Kit. The Evaluation Kit has RF Shield and SMA connector for External Antenna  
For details refer to the User Guide, Data Sheet and Circuit Diagram.

#### 3.2 System Details and Ratings

**Table 4: Basic Information of EUT**

Item	EUT information
Kind of Equipment/Test Item	SAM R34 Xplained Pro Evaluation Kit
Type Identification	A09-3167
FCC ID	2ADHKA093167
Canada ID	20266-093167
Canada HVIN	A09-3167

**Table 5: Technical Specification of EUT**

Technical Specification	Value
Operating Frequencies	902.3MHz to 927.5MHz / 902.3MHz to 927.3MHz
Channel number	64 / 26
Channel Separation	200 kHz / 1MHz
Operation Voltage	5Vdc through USB port
Modulation	LoRa
Channel Bandwidth	125KHz
Spreading Factor (SF)	7 to 10
Antenna gain	2 dBi

### 3.3 Independent Operation Modes

Basic operation modes are:

- A. Transmitting
  - 1. Low channel
  - 2. Middle channel
  - 3. High channel
- B. Receiving
- C. Hopping
- D. Standby
- E. Off

### 3.4 Noise Generating and Noise Suppressing Parts

Refer to the Circuit Diagram.

### 3.5 Submitted Documents

- Circuit Diagram
- Instruction Manual
- Rating Label
- Technical Description

## 4. Test Set-up and Operation Modes

### 4.1 Principle of Configuration Selection

The equipment under test (EUT) was configured to measure its maximum power level. The test modes were adapted accordingly in reference to the instructions for use.

### 4.2 Test Operation and Test Software

Setup for testing: Test samples are provided with a USB interface which makes it possible to control them through a test software installed on a notebook computer.

This software was running on the laptop computer connected to the EUT. It was used to enable the operation modes listed in section 3.3 as appropriate.

The samples were used as follows:

Conducted: A000769530-001

Radiation: A000769530-001

Full test was applied on all test modes, but only worst case was shown

Test Software	fcc_red.py
Power setting	20
Spreading Factor (SF)	10

### 4.3 Special Accessories and Auxiliary Equipment

The product has been tested together with the following additional accessories:

Description	Manufacturer	Model No.	Serial No.
Notebook(EMC-06)	Lenovo	TP00048A	PB-0F8B2

## 4.4 Countermeasures to achieve EMC Compliance

The test sample which has been tested contained the noise suppression parts as described in the Constructional Data Form or the Technical Construction File. No additional measures were employed to achieve compliance.

## 4.5 Test Setup Diagram

**Diagram of Measurement Configuration for Radiation Test**

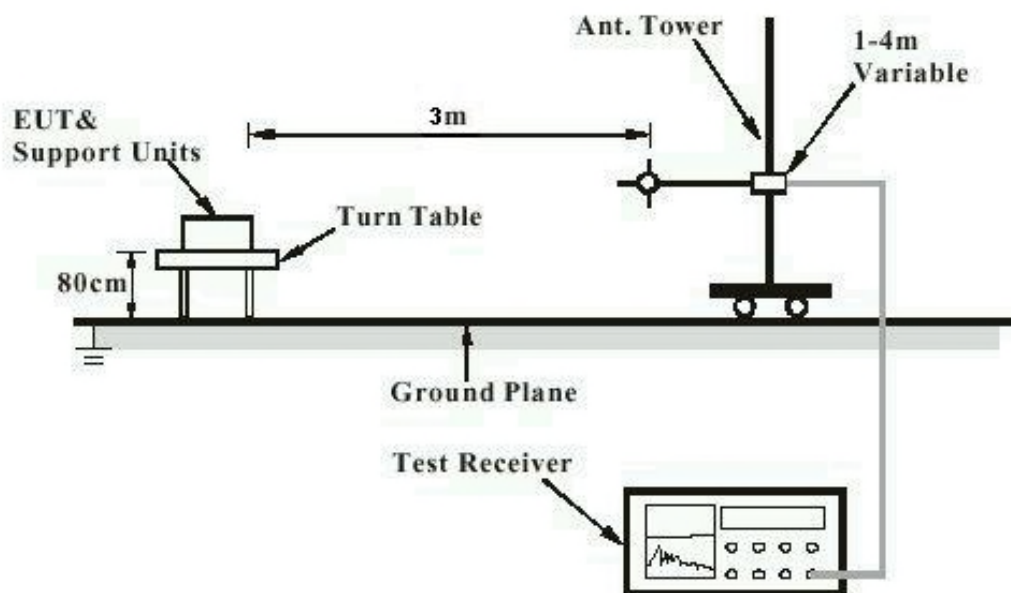

Note: Measurements above 1 GHz are done with a table height of 1.5m

**Diagram of Measurement Equipment Configuration for Mains Conduction Measurement (if applicable)**

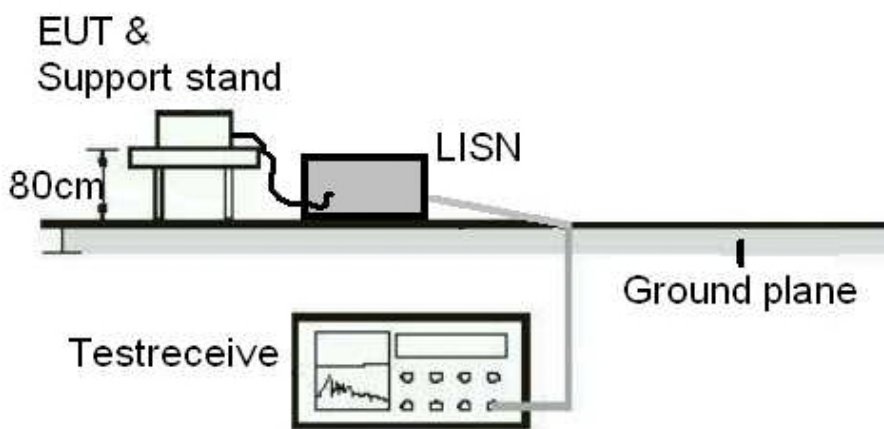

**Diagram of Measurement Equipment Configuration for Conducted Transmitter Measurement**

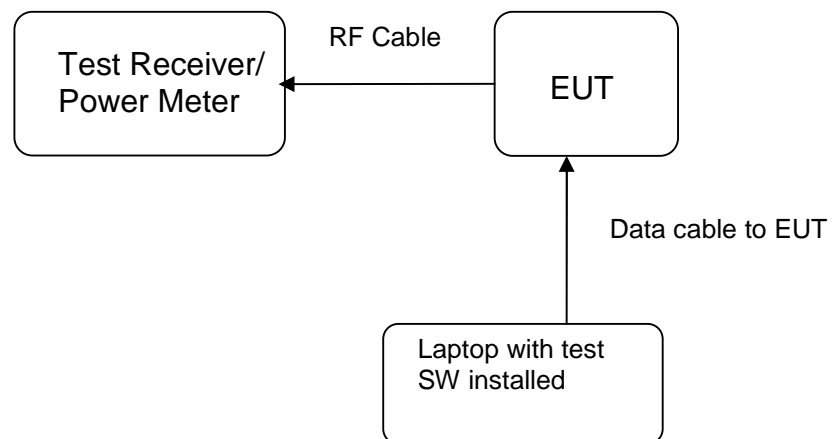

## 5. Test Results

### 5.1 Transmitter Requirement & Test Suites

#### 5.1.1 Antenna Requirement

**RESULT:** **Passed**

Test standard	:	LP0002(2018): 2.2, 3.10.1, (3) FCC Part 15.247(b)(4), Part 15.203 and RSS- Gen 8.3
Requirement	:	use of approved antennas only with directional gains that do not exceed 6 dBi

According to the manufacturer declaration, the EUT has an antenna with a directional gain of 2dBi. The antenna is connected through a SMA connector and only the antenna tested and approved is allowed for use by the end-user. Therefore, the EUT is considered to comply with this provision.

Refer to EUT photo for details.

### 5.1.2 Maximum conducted (average) output power

**RESULT:**
**Passed**

Test standard : LP0002(2018): 3.10.1, (2)  
 FCC Part 15.247(b)(3), RSS-247 5.4(4)  
 Basic standard : ANSI C63.10:2013, KDB558074  
 Limit : 1 Watt  
 Kind of test site : Shielded room

**Test setup**

Test Channel : Low/ Middle/ High  
 Operation Mode : A  
 Ambient temperature : 20-24 °C  
 Relative humidity : 50-65 %  
 Atmospheric pressure : 100-103 kPa

**Table 6: Test result of Maximum conducted (average) output power**

Channel	Channel Frequency (MHz)	Output Power		Limit
		(dBm)	(W)	(W)
Low Channel	902.3	18.56	0.07178	1
Middle Channel	914.9	18.47	0.07031	1
High Channel	927.5	18.33	0.06808	1

Pmax: 71.78 mW

### 5.1.3 Frequency Separation

**RESULT:**
**Passed**

Test standard : FCC part 15.247(a)(1)  
 RSS-247 5.1  
 LP0002(2016): 3.10.1.6 (1) (A)  
 Basic standard : ANSI C63.10:2013  
 LP0002(2016) Appendix II  
 Limit :  $\geq 25\text{kHz}$  or 20dB bandwidth, whichever is greater

**Test setup**

Test Channel : Hopping on  
 Operation Mode : C  
 Ambient temperature : 24°C  
 Relative humidity : 53%

**Table 7: Test result of Frequency Separation (26 channels)**

Channel	Channel Frequency (MHz)	Measured Channel Separation (MHz)	Limit (kHz)	Result
Record Channel	913.3	1	$\geq 25\text{kHz}$ or 20dB bandwidth	Pass
Record Channel adj 1	914.3			
Record Channel adj 2	915.3			

**Table 8: Test result of Frequency Separation (64 channels)**

Channel	Channel Frequency (MHz)	Measured Channel Separation (MHz)	Limit (kHz)	Result
Record Channel	908.3	0.2	$\geq 25\text{kHz}$ or 20dB bandwidth	Pass
Record Channel adj 1	908.5			
Record Channel adj 2	908.7			

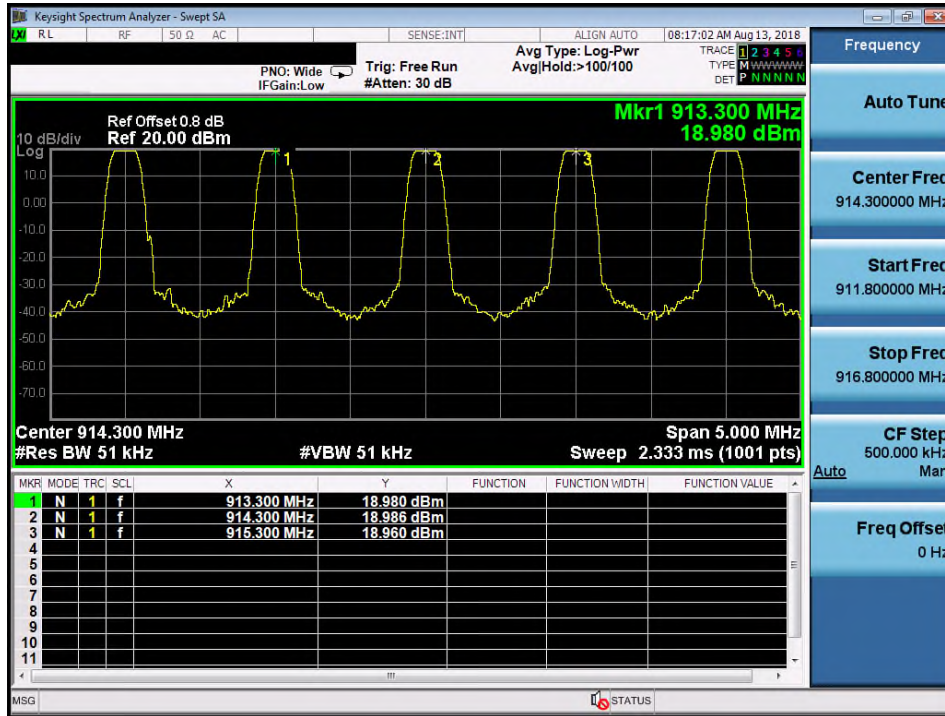
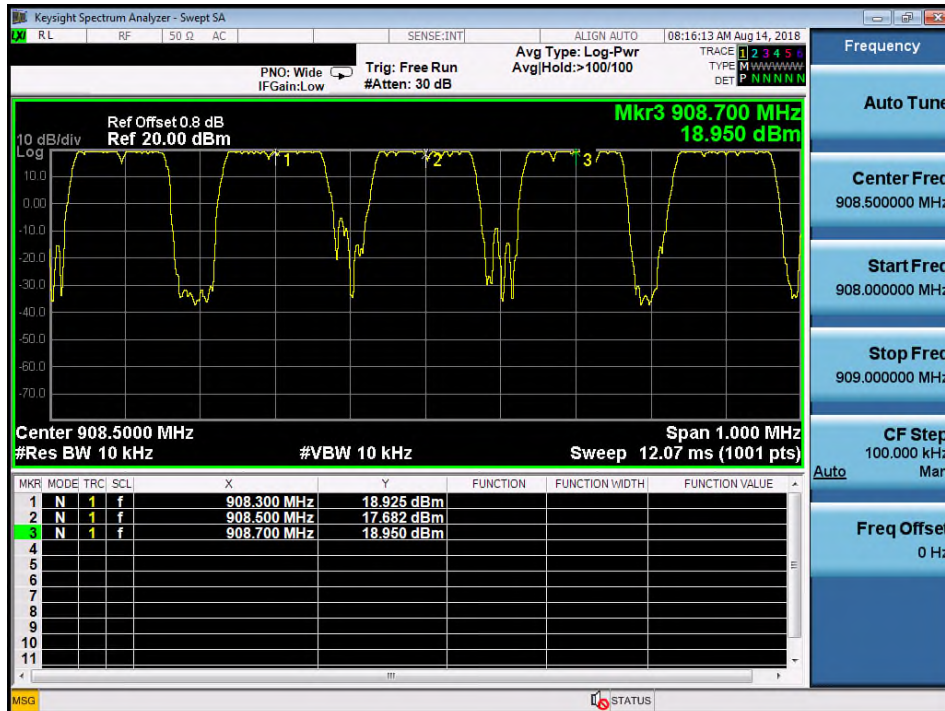

**Hopping on for 26 channels**

**Hopping on for 64 channels**

### 5.1.4 20dB Bandwidth and 99% Bandwidth

**RESULT:**
**Passed**

Test standard : LP0002(2018): 3.10.1, (5)  
 FCC Part 15.247(a)(1)(i), RSS-247 5.2(1)  
 RSS-Gen (Issue 5)  
 Basic standard : ANSI C63.10:2013, KDB558074  
 Kind of test site : Shielded room

**Test setup**

Test Channel : Low/ Middle/ High  
 Operation Mode : A  
  
 Ambient temperature : 20-24°C  
 Relative humidity : 50-65%  
 Atmospheric pressure : 100-103 kPa

**Table 9: Test result of 20dB Bandwidth**

Channel	Channel Frequency (MHz)	20dB Bandwidth (kHz)	Limit (kHz)	Result
Low Channel	902.3	133.5	<200	Pass
Mid Channel	914.9	134.8	<200	Pass
High Channel	927.5	133.7	<200	Pass

**Table 10: Test result of 99% Bandwidth,**

Channel	Channel Frequency (MHz)	99% Bandwidth (kHz)
Low Channel	902.3	123.55
Mid Channel	914.9	123.65
High Channel	927.5	123.89

## Test Plot of 20dB and 99% Bandwidth, 125KHz bandwidth

### Low Channel

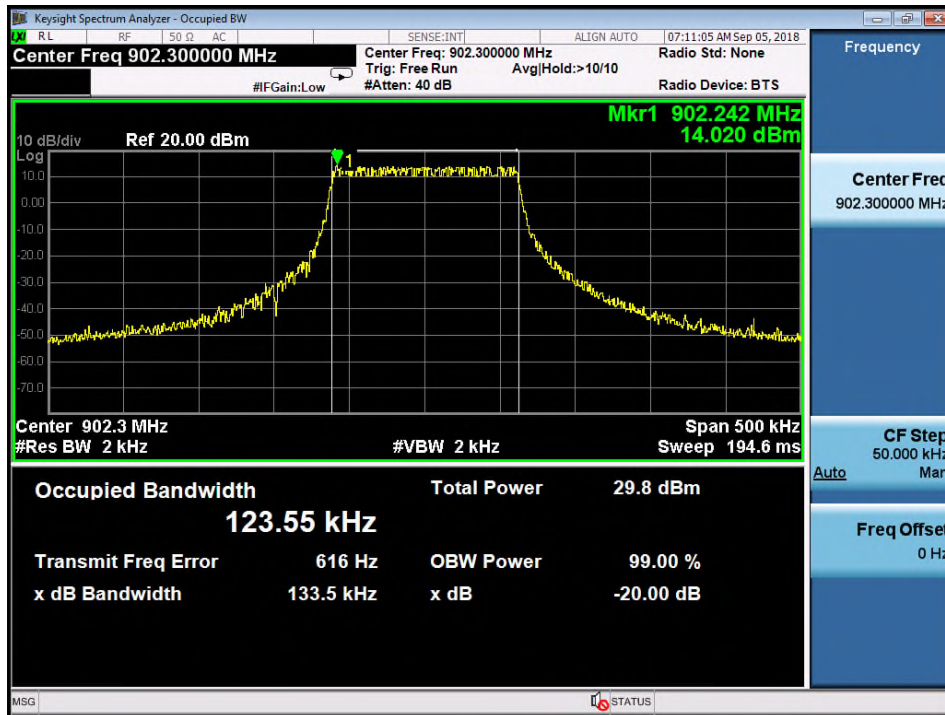

### Middle Channel

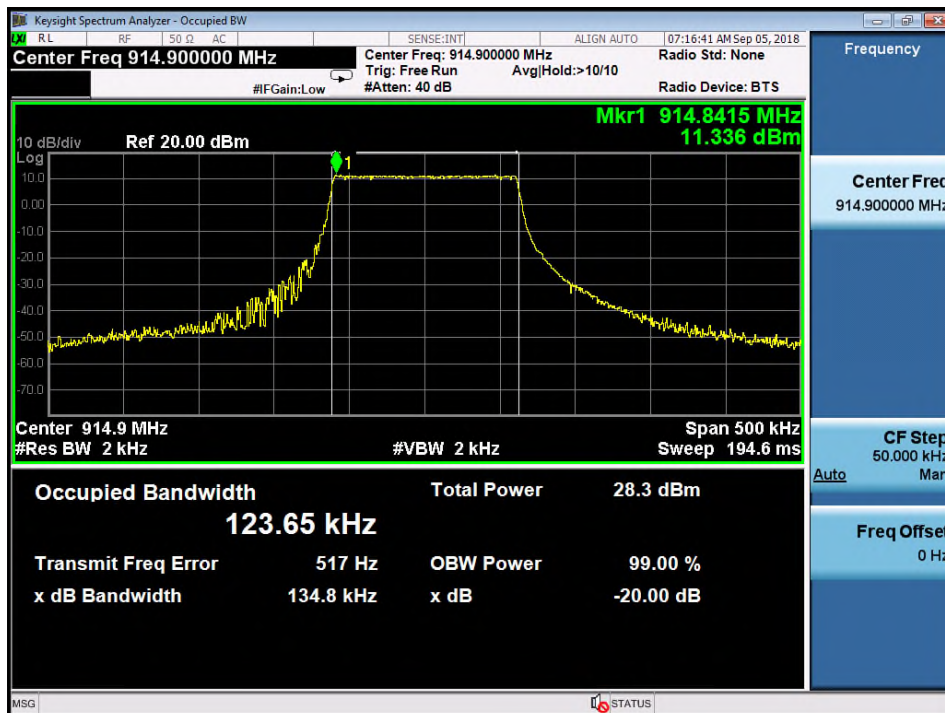

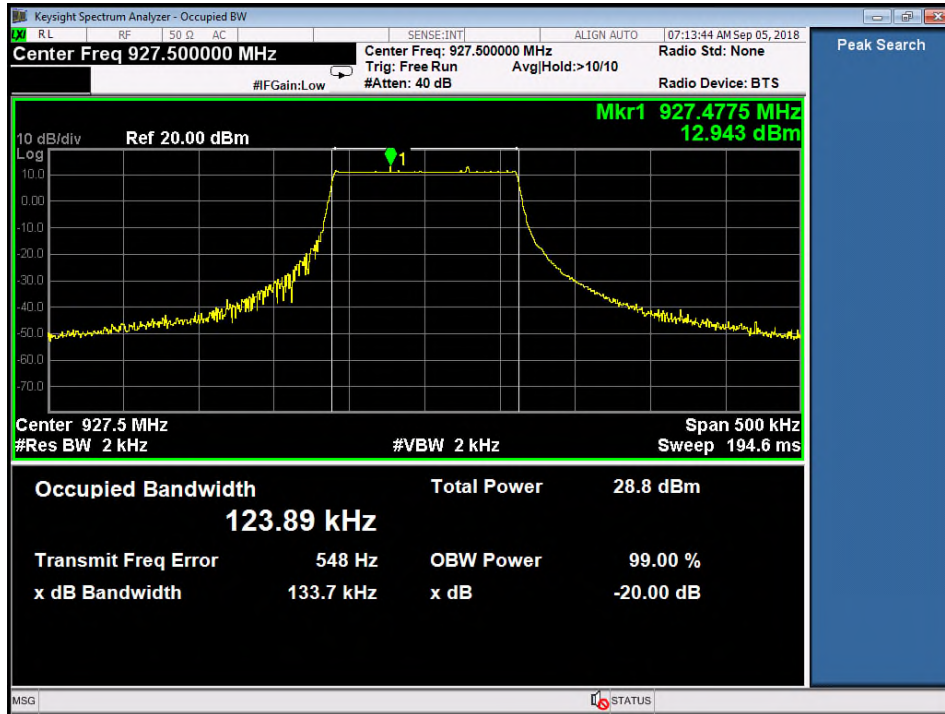
**High Channel**

### 5.1.5 Power Density

**RESULT:**
**Passed**

Test standard : LP0002(2018): 3.10.1, (6.2.2)  
 FCC Part 15.247(f) , RSS-247 5.2(2)  
 Basic standard : ANSI C63.10:2013, KDB558074  
 Kind of test site : Shielded room

**Test setup**

Test Channel : Low/ Middle/ High  
 Operation Mode : A  
 Ambient temperature : 20-24°C  
 Relative humidity : 50-65%  
 Atmospheric pressure : 100-103 kPa

**Table 11: Test result of Power Density**

Channel	Channel Frequency (MHz)	Power Density	Limit
		(dBm)	(dBm)
Low Channel	902.3	6.29	8
Middle Channel	914.9	6.53	8
High Channel	927.5	6.08	8

## Test Plot of Power Density (125kHz Bandwidth)

### Low Channel

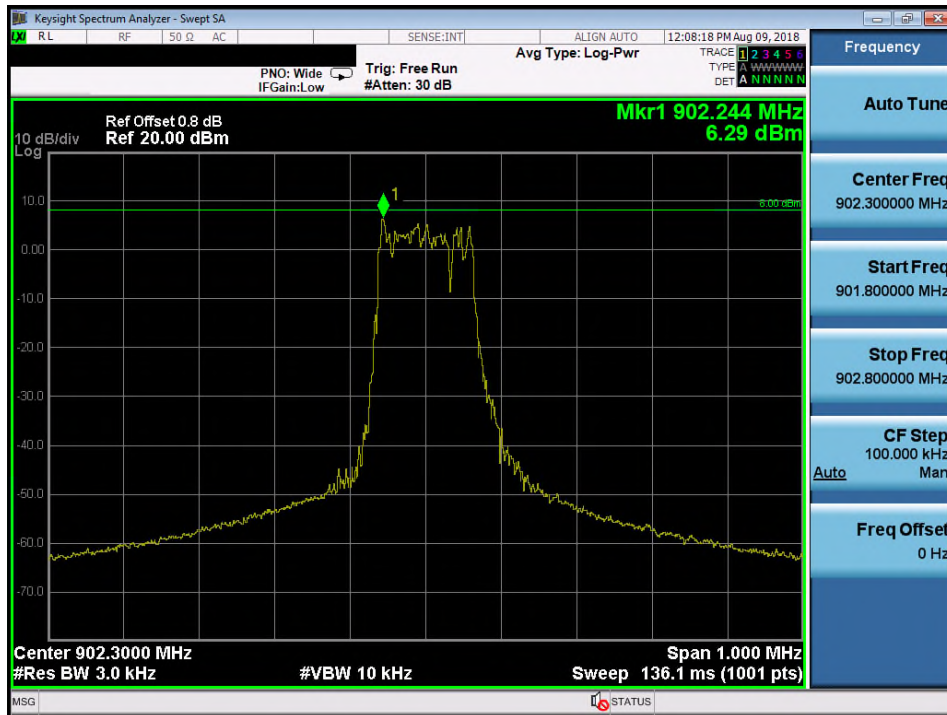

### Middle Channel

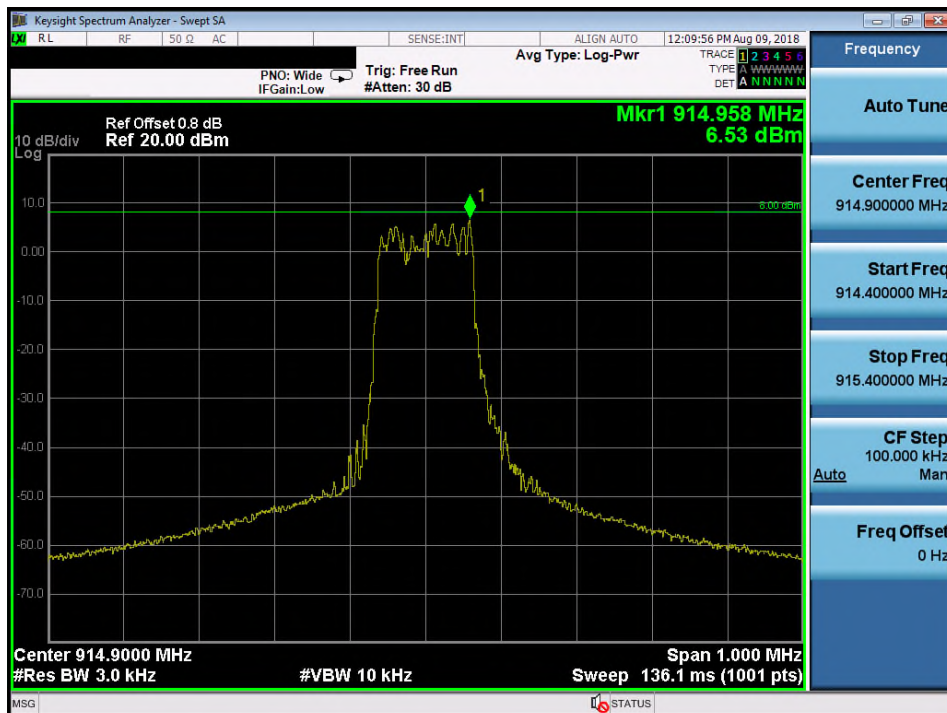

**High Channel**

### 5.1.6 Conducted spurious emissions and Frequency Band Edge measured in 100kHz Bandwidth

**RESULT:** **Passed**

Test standard : LP0002(2018): 3.10.1, (5)  
FCC part 15.247(d), RSS-247 5.5  
Basic standard : ANSI C63.10:2013, KDB558074  
Limit : 30dB (below that in the 100kHz bandwidth within the  
band that contains the highest level of the desired power)  
Kind of test site : Shielded room

#### Test setup

Test Channel : Low/ Middle/ High for Conducted Spurious Emissions  
Low/ High/ Hopping for Frequency Band Edge  
Operation Mode : A, C  
Ambient temperature : 20-24°C  
Relative humidity : 50-65%  
Atmospheric pressure : 100-103 kPa

All emissions are more than 30dB below fundamental, details refer to following test plot, and compliance is achieved as well.

Due to the small size of the product and that there are no inductive components of significant size, 9kHz to 30MHz frequency range is not tested based on technical judgment.



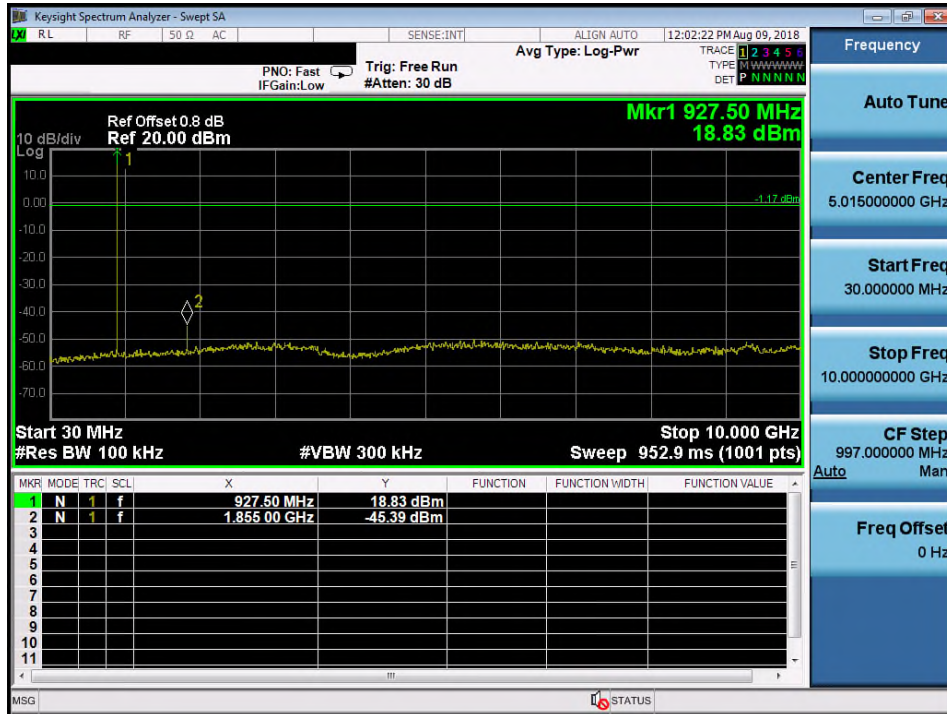

**High Channel**

## Test Plot 100kHz RBW of Band Edge

### Low Channel

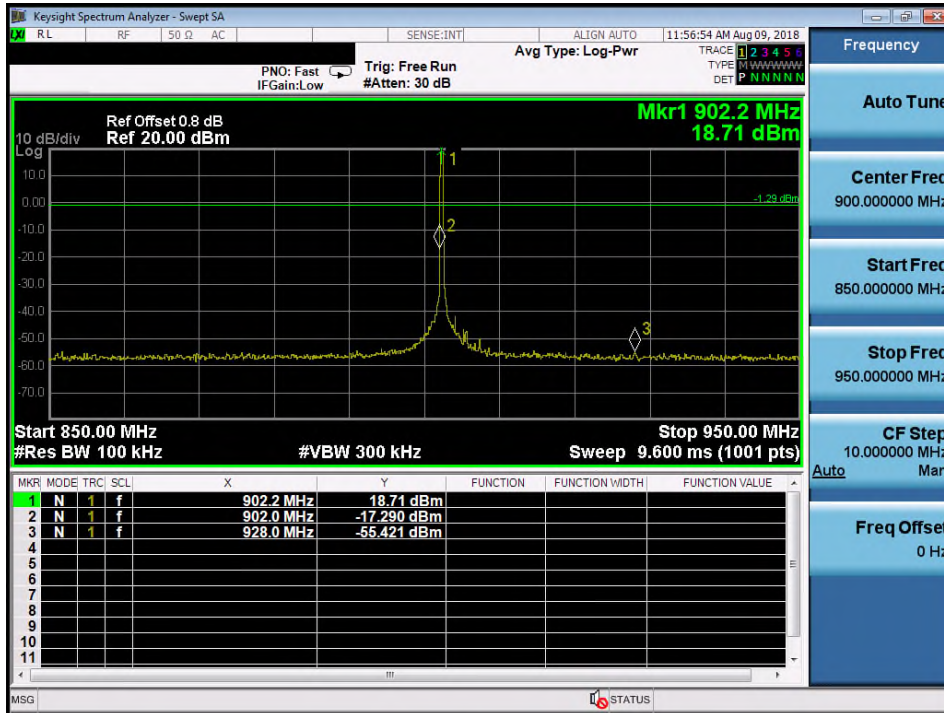

### High Channel

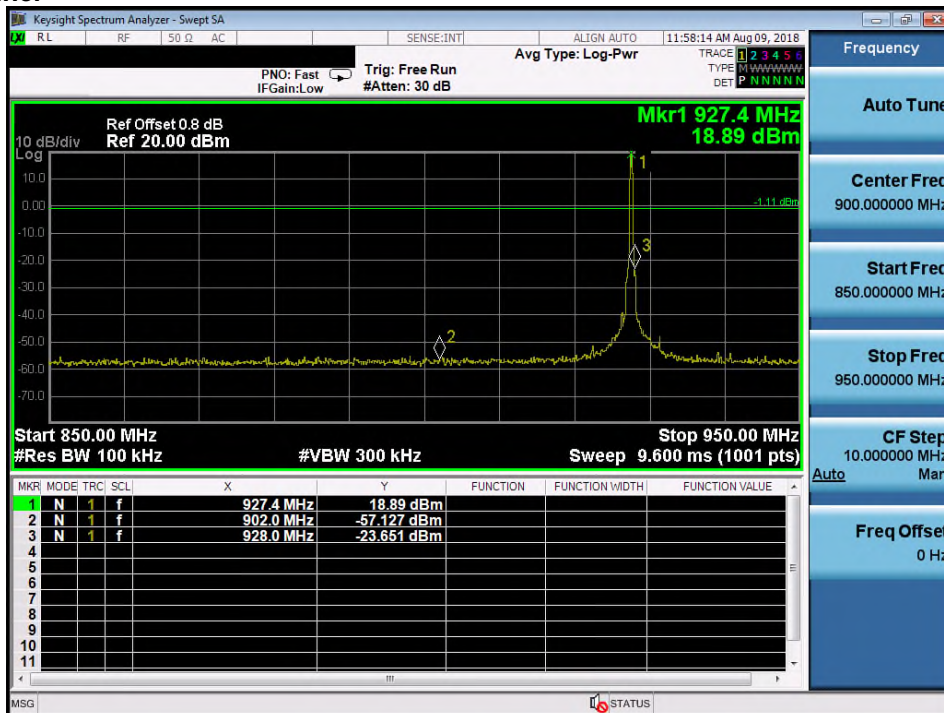

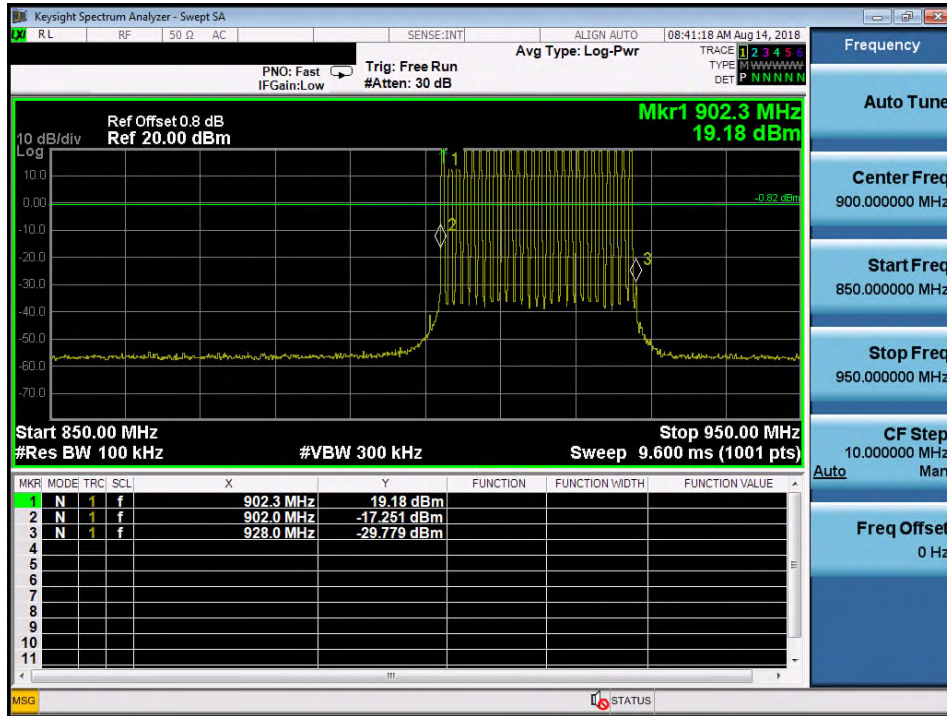
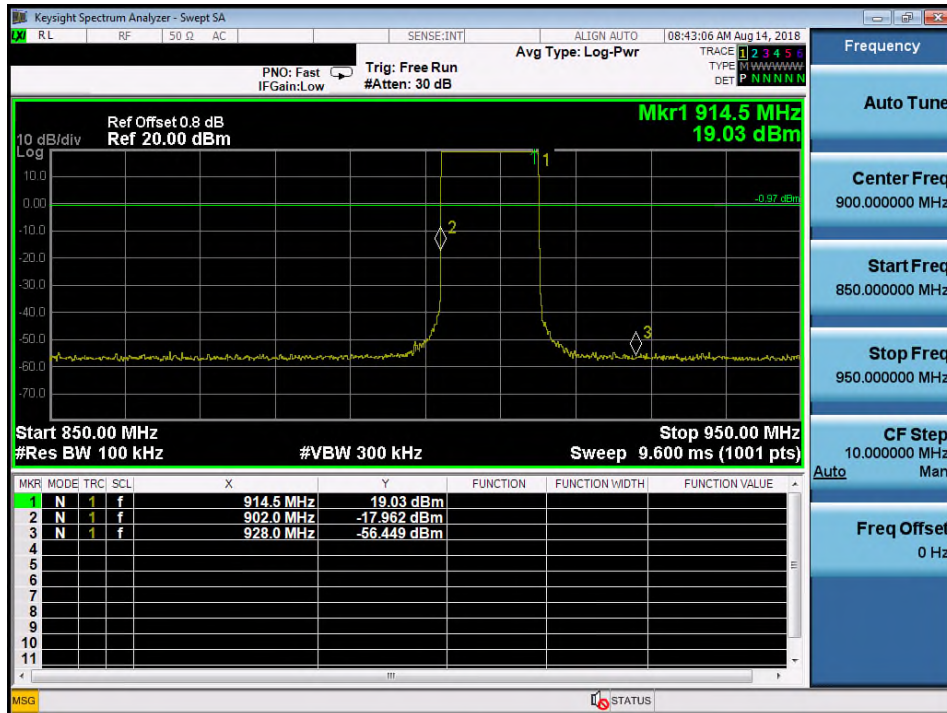
**Hopping on for 26 channels**

**Hopping on for 64 channels**

### 5.1.7 Time of Occupancy

**RESULT:**
**Passed**

Test standard : FCC part 15.247(f)  
 RSS-247 5.1(5)  
 LP0002(2016): 3.10.1.6 (1) (A) (a)  
 Basic standard : ANSI C63.10:2013  
 LP0002(2016) Appendix II  
 Limits : 0.4s  
 Kind of test site : Shield room

**Test setup**

Test Channel : Hopping on  
 Operation Mode : C  
 Ambient temperature : 20-24°C  
 Relative humidity : 50-65%  
 Atmospheric pressure : 100-103 kPa

**Table 12: Test result of Time of Occupancy**

Hopping channels	Captured Burst (s)	Dwell time (s)	Limit (s)	Result
26	0.330	0.330	0.4	Pass
64	0.328	0.330	0.4	Pass

## Test Plot of Time of Occupancy

### Hopping on for 26 channels

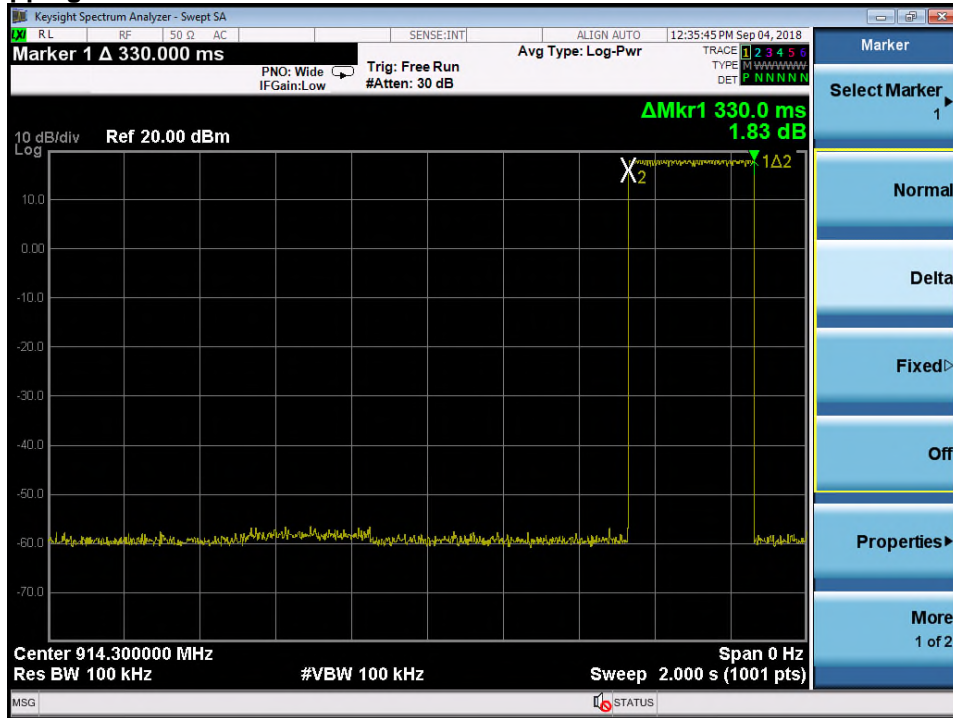

### Hopping for 26 channels

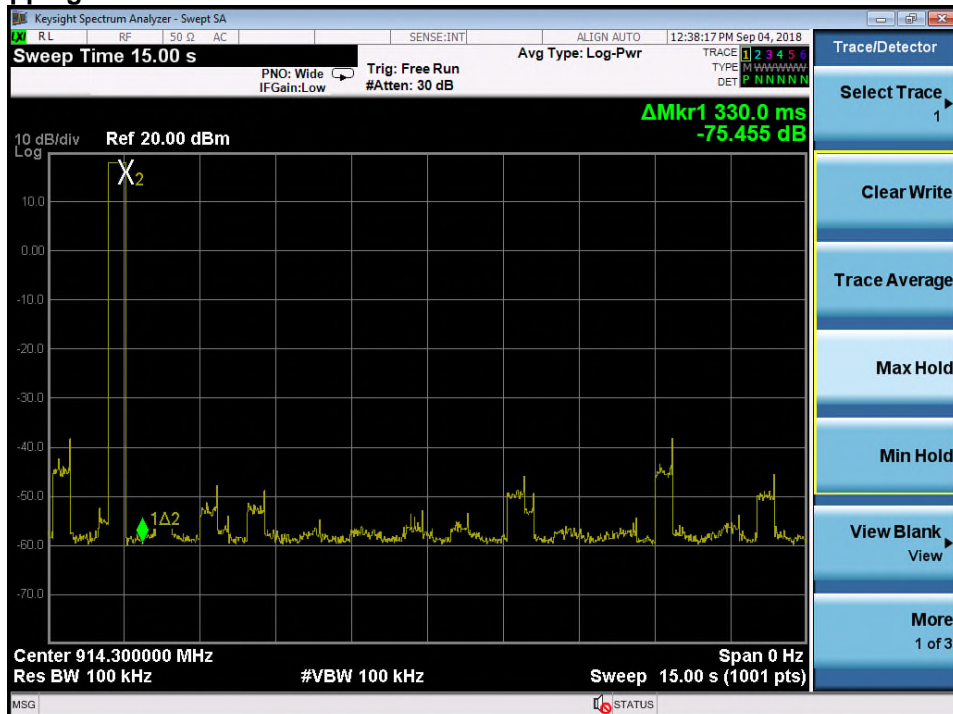



## 5.1.8 Spurious Emission

**RESULT:****Passed**

Test standard	:	FCC part 15.247(d), FCC 15.205, FCC 15.209 and RSS-Gen i5, 8.9 LP0002(2018): 3.10.1, (5)
Basic standard	:	ANSI C63.10: 2013
Limits	:	Radiated emissions which fall in the restricted bands, as defined in FCC 15.205(a) and RSS-Gen i5, 8.10 (Table 7), must comply with the radiated emission limits specified in FCC 15.209(a) and RSS-Gen i5, 8.9 (Table 5 and 6). Radiated emissions which fall in the restricted bands, as defined in LP0002(2018): 2.7 , must comply with the radiated emission limits specified in LP0002(2018): 2.8 Emission radiated outside the restricted and authorized frequency bands must either comply with the radiated emission limits specified for the restricted bands or in FCC15.247(d) and RSS-247 i2, 5.5 Emission radiated outside the specified frequency bands must comply with the radiated emission limits specified in LP0002(2018): 2.8
Kind of test site	:	3m Semi-Anechoic Chamber
<b>Test setup</b>		
Test Channel	:	Low/ Middle/ High
Operation mode	:	A, B
Ambient temperature	:	20-24 °C
Relative humidity	:	50-65 %
Atmospheric pressure	:	100-103 kPa

For details refer to Appendix D.

The Radiated Emissions testing was performed in the X, Y and Z axis orientation. The worst-case Axis orientation is recorded in this test report.



## 5.2 Mains Emissions

### 5.2.1 Mains Conducted Emissions

**RESULT:****Passed**

Test standard	:	FCC Part 15.207 FCC Part 15.107 RSS-Gen i5, 8.8 LP0002: 2.3
Limits	:	Mains Conducted emissions as defined in above test standards must comply with the mains conducted emission limits specified
Kind of test site	:	Shielded Room

**Test setup**

Test Channel	:	Normal link
Operation mode	:	Normal link
Ambient temperature	:	20-24 °C
Relative humidity	:	50-65 %
Atmospheric pressure	:	100-103 kPa

Remark: For details refer to Appendix D.

## 6. Safety Human exposure

### 6.1 Radio Frequency Exposure Compliance

#### 6.1.1 Electromagnetic Fields

**RESULT:**
**Passed**

Test standard : FCC KDB Publication 447498 D01  
 RSS-102 issue 5, Table 4

The EUT will maintain a 20 cm distance to all persons.

**Maximum Exposure:**

Power to Antenna (mW)	71.78 mW
Power to Antenna (dBm)	18.6 dBm
Antenna Gain	2 dBi
Power+Ant Gain	113.8 mW
Distance	20 cm
S=	0.023 mW/cm <sup>2</sup>

Limit FCC: 0.61 mW/cm<sup>2</sup>

Limit Canada: 0.277 mW/cm<sup>2</sup>

FCC/NCC:

0.3-1.34 MHz	(100) mW/cm <sup>2</sup>
1.34-30 MHz	(180/f <sup>2</sup> ) mW/cm <sup>2</sup>
30-300 MHz	0.2 mW/cm <sup>2</sup>
300-1500 MHz	f/1500 mW/cm <sup>2</sup>
1500-100,000 MHz	1.0 mW/cm <sup>2</sup>

Canada:

10-20 MHz	0.2 mW/cm <sup>2</sup>
20-48 MHz	(0.8944/f <sup>0.5</sup> ) mW/cm <sup>2</sup>
48-300 MHz	0.129 mW/cm <sup>2</sup>
300-6000 MHz	(0.002619*f <sup>0.6834</sup> ) mW/cm <sup>2</sup>
6000-15000MHz	1.0 mW/cm <sup>2</sup>

---End---

## 7. Photographs of the Test Set-Up

Photograph 1: Set-up for Spurious Emissions (Front View 1)



**Photograph 2: Set-up for Spurious Emissions (Front View 2)**

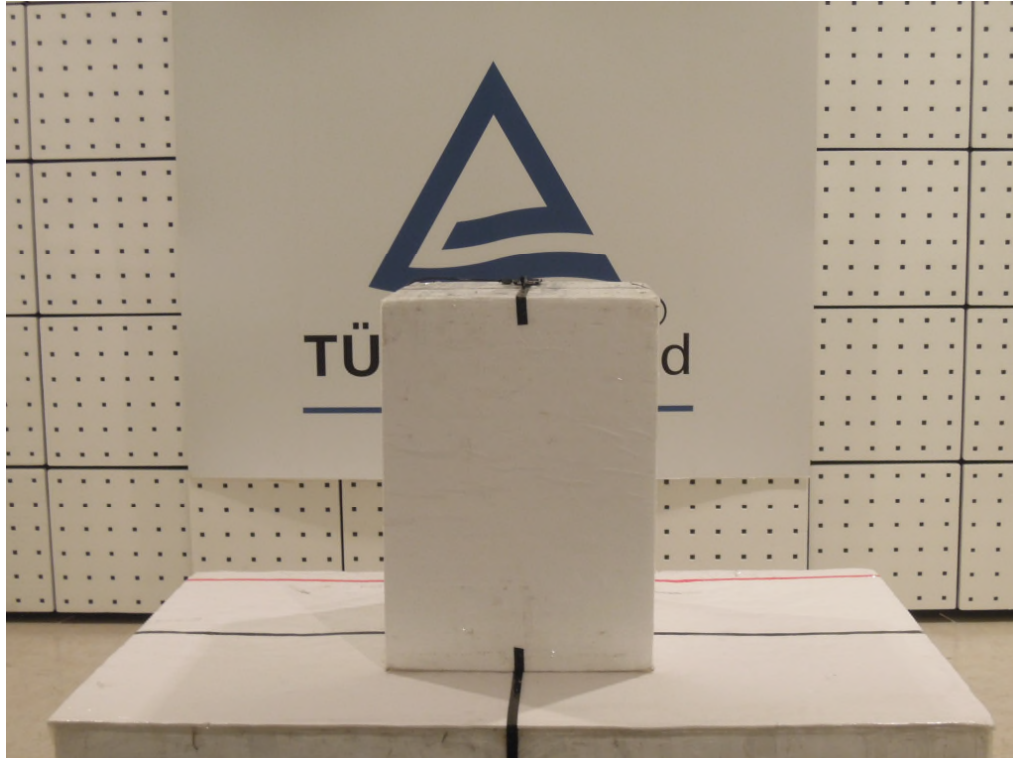

**Photograph 3: Set-up for Spurious Emissions (Back View 1)**

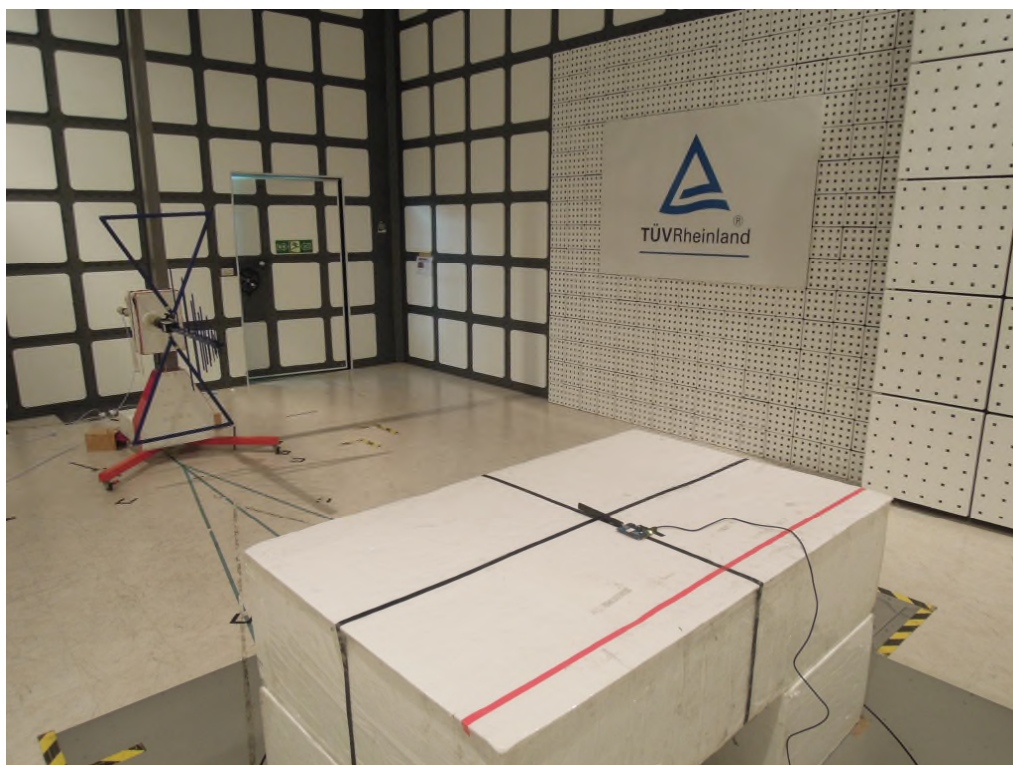

**Photograph 4: Set-up for Spurious Emissions (Back View 2)**

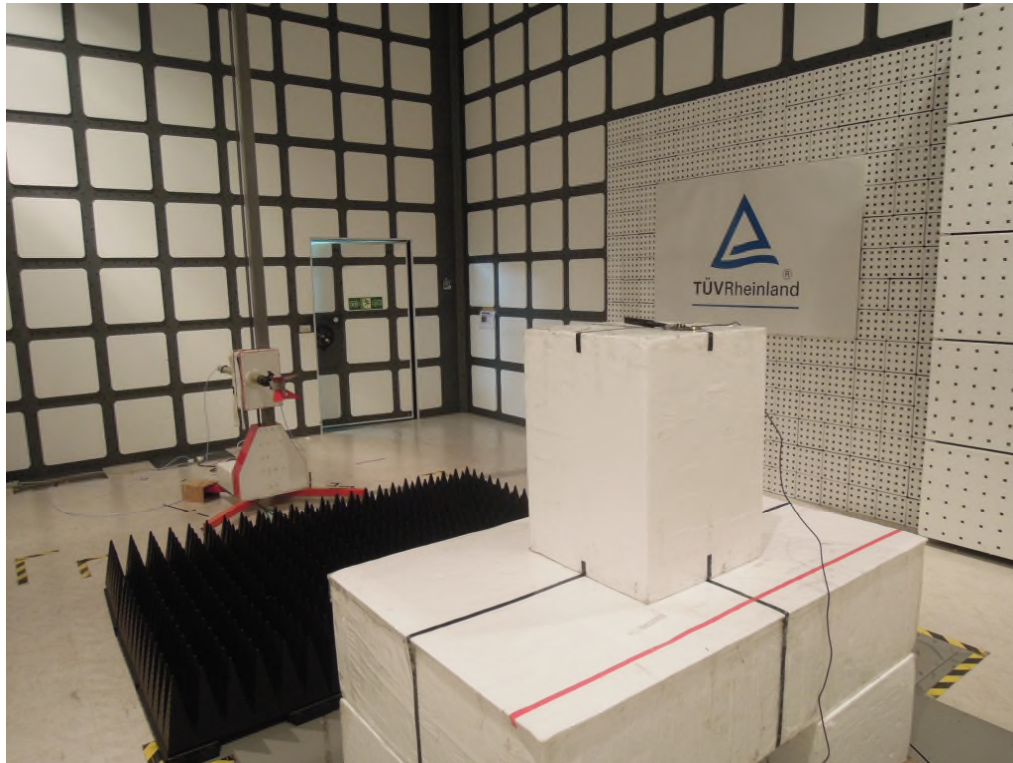

**Photograph 5: Set-up for Spurious Emissions (Back View 3)**

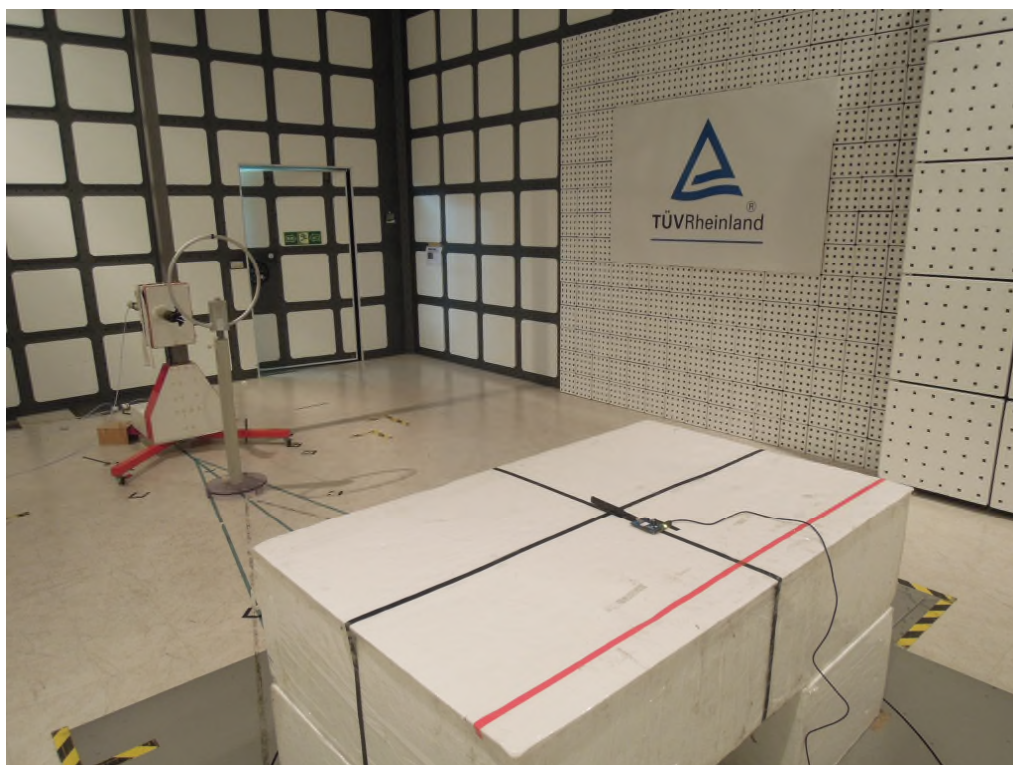

Photograph 6: Set-up for Conducted testing

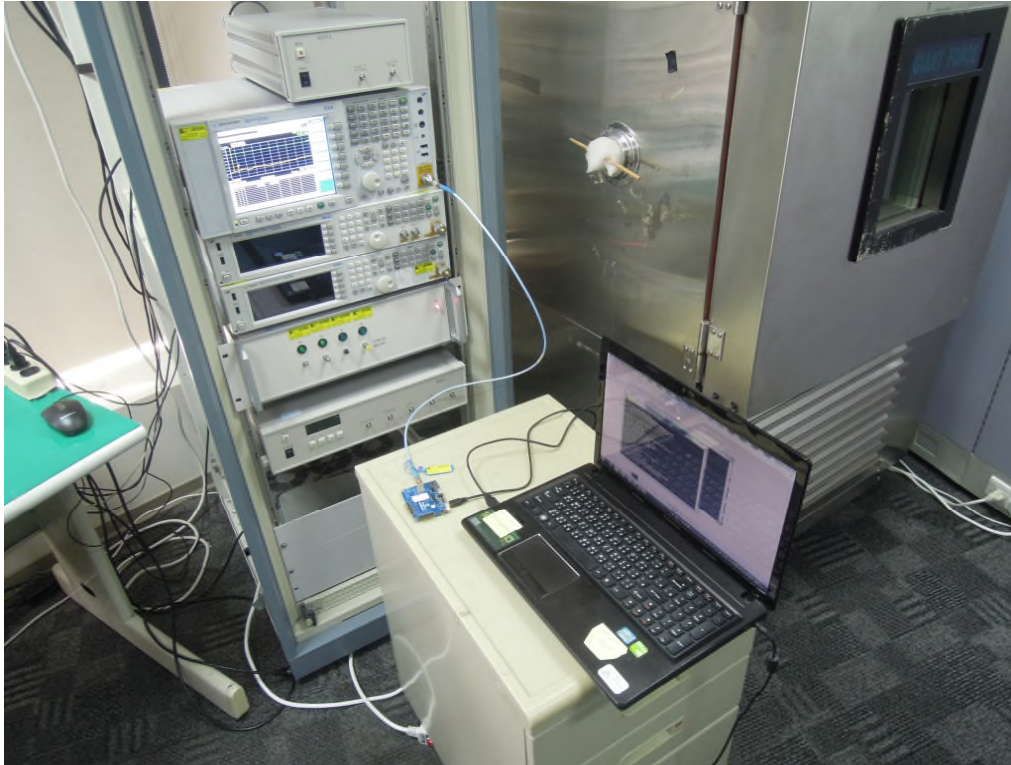

Photograph 7: Set-up for Conducted testing

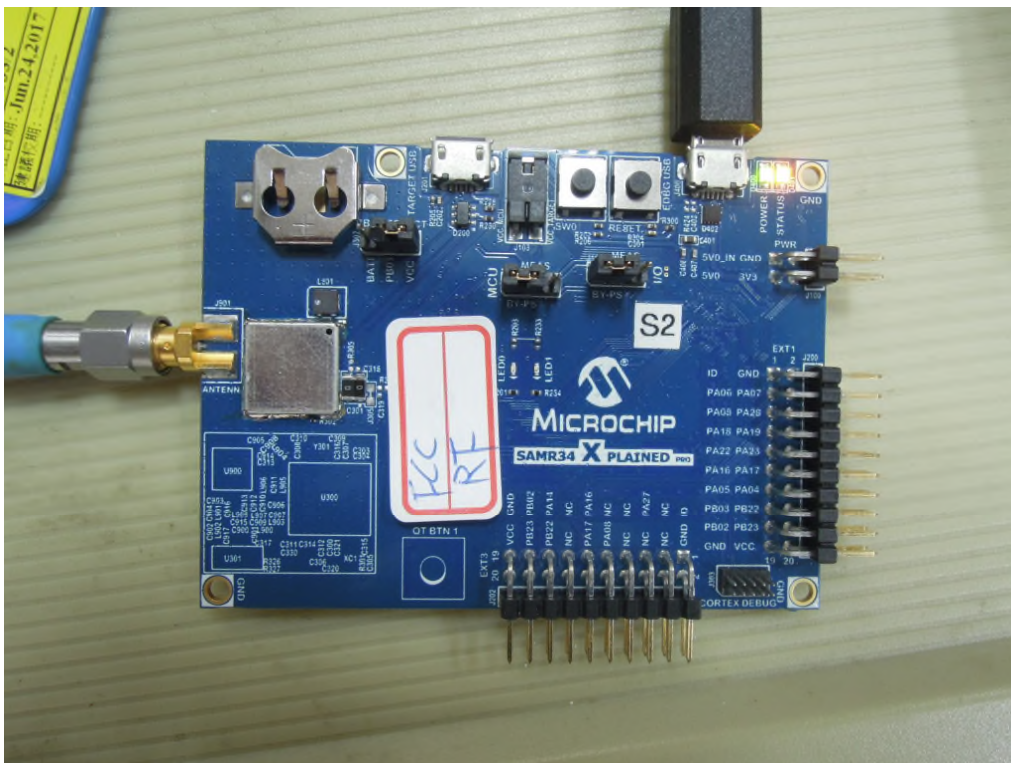

**Photograph 8: Set-up for for Mains Conducted testing Back**



**Photograph 9: Set-up for for Mains Conducted testing Front**

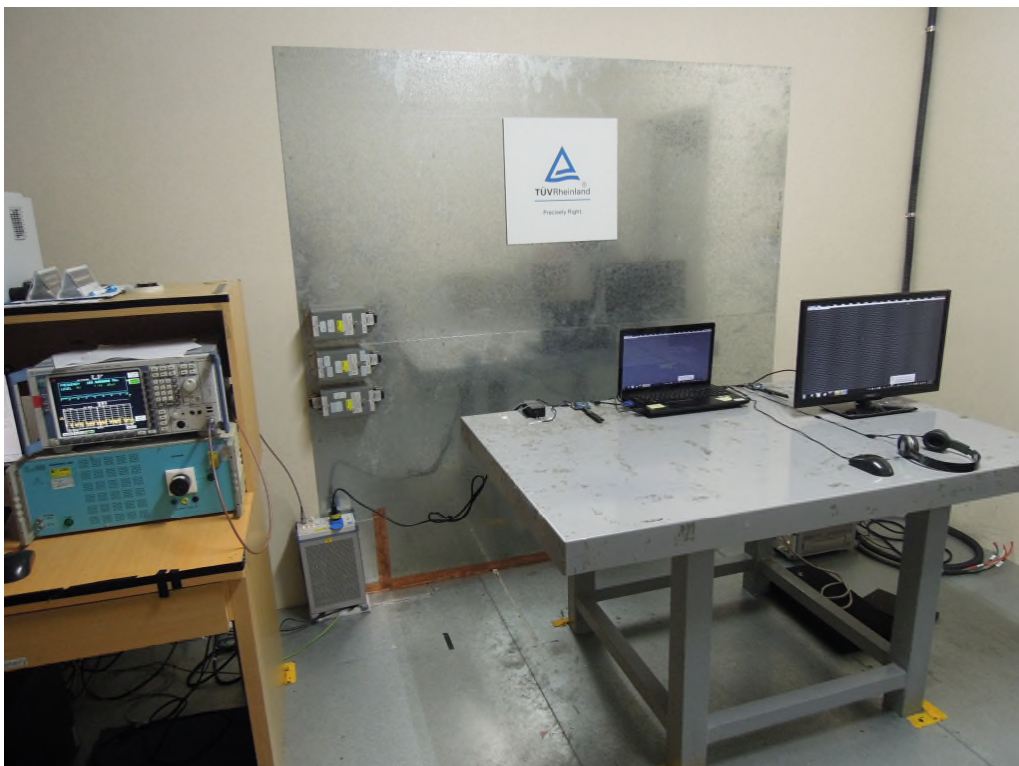

## 8. List of Tables

Table 1: Applied Standard and Test Levels .....	5
Table 2: List of Test and Measurement Equipment .....	7
Table 3: Emission Measurement Uncertainty.....	8
Table 4: Basic Information of EUT .....	9
Table 5: Technical Specification of EUT .....	9
Table 6: Test result of Maximum conducted (average) output power .....	15
Table 7: Test result of Frequency Separation (26 channels) .....	16
Table 8: Test result of Frequency Separation (64 channels) .....	16
Table 9: Test result of 20dB Bandwidth .....	18
Table 10: Test result of 99% Bandwidth,.....	18
Table 11: Test result of Power Density .....	21
Table 12: Test result of Time of Occupancy.....	29

## 9. List of Photographs

Photograph 1: Set-up for Spurious Emissions (Front View 1).....	35
Photograph 2: Set-up for Spurious Emissions (Front View 2).....	36
Photograph 3: Set-up for Spurious Emissions (Back View 1).....	36
Photograph 4: Set-up for Spurious Emissions (Back View 2).....	37
Photograph 5: Set-up for Spurious Emissions (Back View 3).....	37
Photograph 6: Set-up for Conducted testing .....	38
Photograph 7: Set-up for Conducted testing .....	38
Photograph 8: Set-up for for Mains Conducted testing Back.....	39
Photograph 9: Set-up for for Mains Conducted testing Front.....	39