

FCC TEST REPORT  
for  
Shenzhen Moikit Network Technology Co.,Ltd  
  
moikit gene  
Model No.: G1206

Prepared for : Shenzhen Moikit Network Technology Co.,Ltd  
Address : Room 701,Building A,Baoan Internet creative garden,Xingye Road  
2005,Xixiang street,Baoan,Shenzhen,Shenzhen,518101,China

Prepared By : Shenzhen Anbotek Compliance Laboratory Limited  
Address : 1/F., Building 1, SEC Industrial Park, No.0409 Qianhai Road,  
Nanshan District, Shenzhen, Guangdong, China  
Tel: (86) 755-26066544  
Fax: (86) 755-26014772

Report Number : R011611857I  
Date of Test : Nov. 22~Dec. 05, 2016  
Date of Report : Dec. 06, 2016

**TABLE OF CONTENT**

Description

Page

Test Report

**1. GENERAL INFORMATION.....4**

    1.1. Description of Device (EUT).....4

    1.2. Auxiliary Equipment Used during Test.....5

    1.3. Description of Test Facility.....5

    1.4. Measurement Uncertainty.....5

**2. TEST METHODOLOGY.....6**

    2.1. Summary of Test Results.....6

    2.2. Description of Test Modes.....6

**3. CONDUCTED EMISSION TEST.....7**

    3.1. Block Diagram of Test Setup.....7

    3.2. Power Line Conducted Emission Measurement Limits (15.207).....7

    3.3. Configuration of EUT on Measurement.....8

    3.4. Operating Condition of EUT.....8

    3.5. Test Procedure.....8

    3.6. Test equipment.....8

    3.7. Power Line Conducted Emission Measurement Results.....8

**4. FCC PART 15.247 REQUIREMENTS FOR DTS DEVICE..... 13**

    4.1 Test Setup.....13

    4.2 6dB Bandwidth.....13

    4.3. Maximum Peak output power test.....17

    4.4. 100 kHz bandwidth outside the frequency Measurement.....20

    Conducted Emission Method.....22

    4.5. Peak Power Spectral Density.....24

    4.6. Radiated Emissions and Band Edges Measurement.....27

**5. ANTENNA APPLICATION..... 36**

    5.1. Antenna requirement.....36

    5.2. Result.....36

**6. PHOTOGRAPH..... 37**

    6.1 Photo of Conducted Emission Test.....37

    6.2 Photo of Radiation Emission Test.....37

**APPENDIX I (EXTERNAL PHOTOS)..... 39**

**APPENDIX II (INTERNAL PHOTOS)..... 42**

## TEST REPORT

Applicant : Shenzhen Moikit Network Technology Co.,Ltd  
Manufacturer : Shenzhen Moikit Network Technology Co.,Ltd  
EUT : moikit gene  
Model No. : G1206  
Serial No. : N.A.  
Trade Mark : moikit  
Rating : Input 5V, 200mA (Battery DC 3.7V, 150mAh)

Measurement Procedure Used:  
FCC Part15 Subpart C 2016, Paragraph 15.247

The device described above is tested by Shenzhen Anbotek Compliance Laboratory Limited to determine the maximum emission levels emanating from the device and the severe levels of the device can endure and its performance criterion. The measurement results are contained in this test report and Shenzhen Anbotek Compliance Laboratory Limited is assumed full of responsibility for the accuracy and completeness of these measurements. Also, this report shows that the EUT (Equipment Under Test) is technically compliant with the FCC Part 15 Subpart C requirements.

This report applies to above tested sample only and shall not be reproduced in part without written approval of Shenzhen Anbotek Compliance Laboratory Limited.

Date of Test : Nov. 22~Dec. 05, 2016

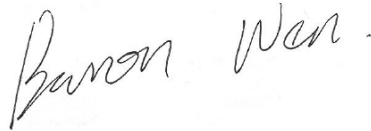
Prepared by :   
(Tested Engineer / Baron Wen)

Reviewer :   
(Project Manager / Dolly Mo)

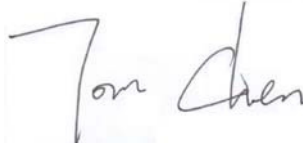
Approved & Authorized Signer :   
(Manager / Tom Chen)

## 1. GENERAL INFORMATION

### 1.1. Description of Device (EUT)

EUT : moikit gene

Model Number : G1206

Test Power Supply : AC 120V, 60Hz for adapter/  
AC 240V, 60Hz for adapter  
DC 3.7V Battery inside

Frequency : 2402~2480MHz

Modulation : GFSK

Channel Spacing : 2MHz

Number of Channels : 40

Antenna Type : PCB Antenna

Antenna Gain : 2.2 dBi

Applicant : Shenzhen Moikit Network Technology Co.,Ltd  
Address : Room 701,Building A,Baoan Internet creative garden,Xingye Road  
2005,Xixiang street,Baoan,Shenzhen,Shenzhen,518101,China

Manufacturer : Shenzhen Moikit Network Technology Co.,Ltd  
Address : Room 701,Building A,Baoan Internet creative garden,Xingye Road  
2005,Xixiang street,Baoan,Shenzhen,Shenzhen,518101,China

Factory : Shenzhen RuiYi Electronic Science And Technology Co., Ltd.  
Address : A Zone, Tangtou Third Industrial Park, Shiyan Town, Bao'an  
District, Shenzhen, China

Date of receipt : Nov. 22, 2016

Date of Test : Nov. 22~Dec. 05, 2016

## 1.2. Auxiliary Equipment Used during Test

Adapter : Manufacturer: ZTE  
M/N: STC-A2050I1000USBA-C  
S/N: 201202102100876  
Input: 100-240V~50/60Hz 0.3A  
Output: DC 5V, 1000mA

## 1.3. Description of Test Facility

The test facility is recognized, certified, or accredited by the following organizations:

### **FCC-Registration No.: 752021**

Shenzhen Anbotek Compliance Laboratory Limited, EMC Laboratory has been registered and fully described in a report filed with the (FCC) Federal Communications Commission. The acceptance letter from the FCC is maintained in our files. Registration 752021, July 06, 2016.

### **IC-Registration No.: 8058A-1**

Shenzhen Anbotek Compliance Laboratory Limited., EMC Laboratory has been registered and fully described in a report filed with the (IC) Industry Canada. The acceptance letter from the IC is maintained in our files. Registration 8058A, Jun. 13, 2016.

### **Test Location**

All Emissions tests were performed at  
Shenzhen Anbotek Compliance Laboratory Limited. at 1/F., Building 1, SEC  
Industrial Park, No.0409 Qianhai Road, Nanshan District, Shenzhen, Guangdong,  
China

## 1.4. Measurement Uncertainty

Radiation Uncertainty : Ur = 4.1 dB (Horizontal)  
Ur = 4.3 dB (Vertical)  
Conduction Uncertainty : Uc = 3.4dB

## 2. TEST METHODOLOGY

The tests documented in this report were performed in accordance with ANSI C63.10: 2013 and FCC Part 15, Paragraph 15.247.

### 2.1. Summary of Test Results

The EUT has been tested according to the following specifications:

Standard	Test Type	Result	Notes
FCC Part 15, Paragraph 15.107, 15.207	Conducted Emission Test	PASS	Complies
FCC Part 15, Paragraph 15.247(b)(1)	Peak Output Power	PASS	Complies
FCC Part 15, Paragraph 15.247(a)(2)	6dB Bandwidth	PASS	Complies
FCC Part 15, Paragraph 15.247(c)	100kHz Bandwidth of Frequency Band Edges	PASS	Complies
FCC Part 15, Paragraph 15.209(a)(f)	Spurious Emission	PASS	Complies
FCC Part 15, Paragraph 15.247(a)(1)	Frequency Separation	-	N/A
FCC Part 15, Paragraph 15.247(a)(1)(iii)	Number of Hopping Frequency	-	N/A
FCC Part 15, Paragraph 15.247(a)(1)(iii)	Time of Occupancy	-	N/A
FCC Part 15, Paragraph 15.247(c)	Peak Power Density	PASS	Complies

### 2.2. Description of Test Modes

The EUT has been tested under operating condition.

Software used to control the EUT for staying in continuous transmitting and receiving mode is programmed.

Channel Low(2402MHz), Channel Middle(2440MHz) and Channel High(2480MHz) are chosen for the final testing.

### 3. Conducted Emission Test

#### 3.1. Block Diagram of Test Setup

##### 3.1.1. Block diagram of connection between the EUT and simulators

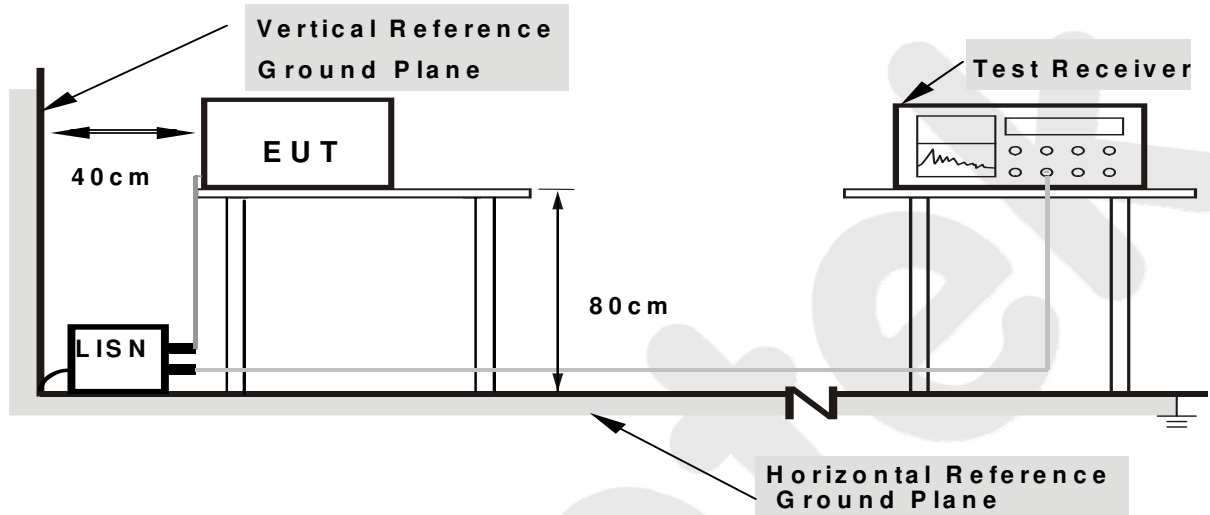

- Note:**
1. Support units were connected to second LISN.
  2. Both of LISNs (AMN) are 80 cm from EUT and at least 80 from other units and other metal planes

#### 3.2. Power Line Conducted Emission Measurement Limits (15.207)

Frequency MHz	Limits dB(μV)	
	Quasi-peak Level	Average Level
0.15 ~ 0.50	66 ~ 56*	56 ~ 46*
0.50 ~ 5.00	56	46
5.00 ~ 30.00	60	50

- Notes:
1. \*Decreasing linearly with logarithm of frequency.
  2. The lower limit shall apply at the transition frequencies.

### 3.3. Configuration of EUT on Measurement

The following equipments are installed on Power Line Conducted Emission Measurement to meet the commission requirement and operating regulations in a manner which tends to maximize its emission characteristics in a normal application.

### 3.4. Operating Condition of EUT

- 3.4.1. Setup the EUT and simulator as shown as Section 3.1.
- 3.4.2. Turn on the power of all equipment.
- 3.4.3. Let the EUT work in test mode (Charge Mode) and measure it.

### 3.5. Test Procedure

The EUT system is connected to the power mains through a line impedance stabilization network (L.I.S.N.). This provides a 50ohm coupling impedance for the EUT system. Please refer the block diagram of the test setup and photographs. Both sides of AC line are checked to find out the maximum conducted emission. In order to find the maximum emission levels, the relative positions of equipment and all of the interface cables shall be changed according to FCC ANSI C63.10-2013 on Conducted Emission Measurement.

The bandwidth of test receiver (ESCI) set at 9KHz.

The frequency range from 150KHz to 30MHz is checked.

The test results are reported on Section 3.6.

### 3.6. Test equipment

Item	Equipment	Manufacturer	Model No.	Serial No.	Last Cal.	Cal. Interval
1.	Two-Line V-network	Rohde & Schwarz	ENV216	100055	Apr. 16, 2016	1 Year
2.	EMI Test Receiver	Rohde & Schwarz	ESCI	100627	Apr. 16, 2016	1 Year
3.	RF Switching Unit	Compliance Direction	RSU-M2	38303	Apr. 16, 2016	1 Year

### 3.7. Power Line Conducted Emission Measurement Results

**PASS.**

The frequency range from 150KHz to 30 MHz is investigated.

Please refer the following pages.

**CONDUCTED EMISSION TEST DATA**

Test Site: 1# Shielded Room  
 Operating Condition: Charge Mode  
 Test Specification: AC 120V, 60Hz for adapter  
 Comment: Live Line  
 Tem.:24°C Hum.:49%

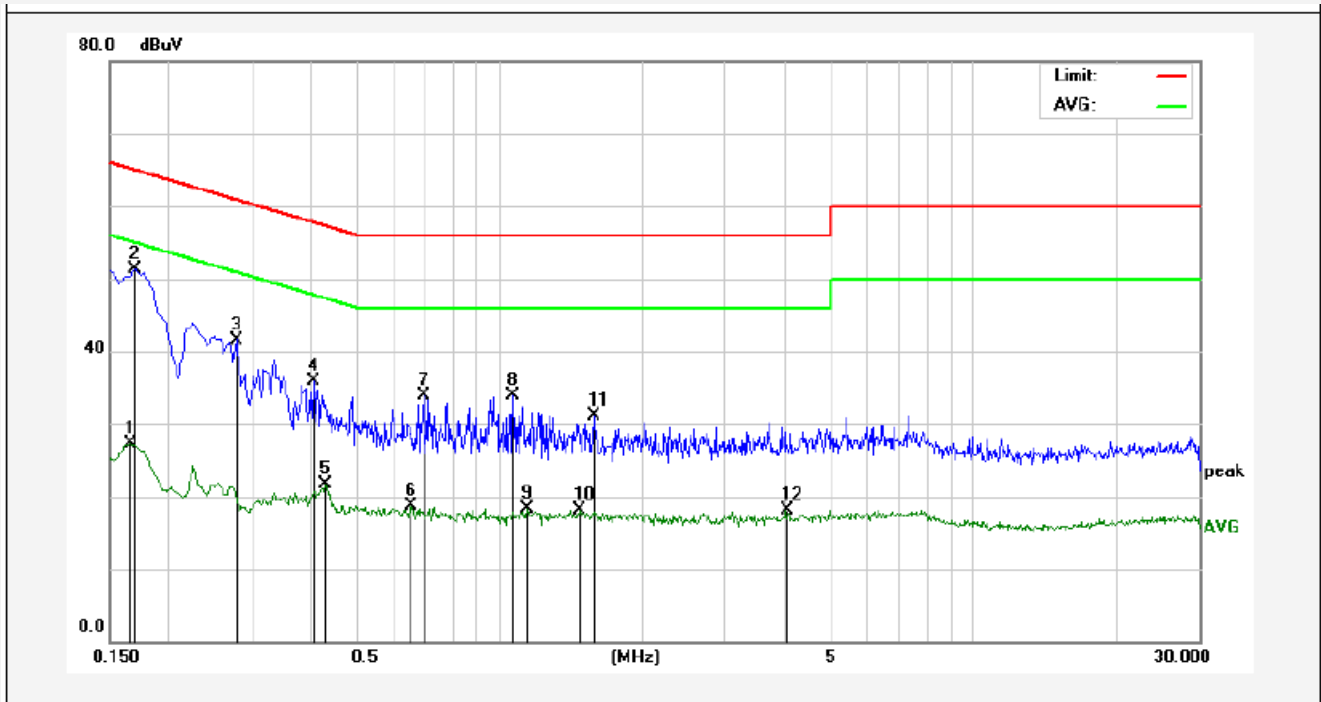

No.	Freq. (MHz)	Reading (dBuV)	Factor (dB)	Result (dBuV)	Limit dBuV	Over Limit (dB)	Detector	Remark
1	0.1660	7.32	19.90	27.22	55.15	-27.93	AVG	
2	0.1700	31.49	19.90	51.39	64.96	-13.57	QP	
3	0.2779	21.71	19.89	41.60	60.88	-19.28	QP	
4	0.4060	15.88	19.94	35.82	57.73	-21.91	QP	
5	0.4300	1.68	19.95	21.63	47.25	-25.62	AVG	
6	0.6540	-1.38	20.03	18.65	46.00	-27.35	AVG	
7	0.6900	13.82	20.04	33.86	56.00	-22.14	QP	
8	1.0660	13.71	20.12	33.83	56.00	-22.17	QP	
9	1.1420	-1.72	20.12	18.40	46.00	-27.60	AVG	
10	1.4740	-2.00	20.13	18.13	46.00	-27.87	AVG	
11	1.5780	10.96	20.13	31.09	56.00	-24.91	QP	
12	4.0380	-2.12	20.18	18.06	46.00	-27.94	AVG	

**CONDUCTED EMISSION TEST DATA**

Test Site: 1# Shielded Room  
 Operating Condition: Charge Mode  
 Test Specification: AC 120V, 60Hz for adapter  
 Comment: Neutral Line  
 Tem.:24°C Hum.:49%

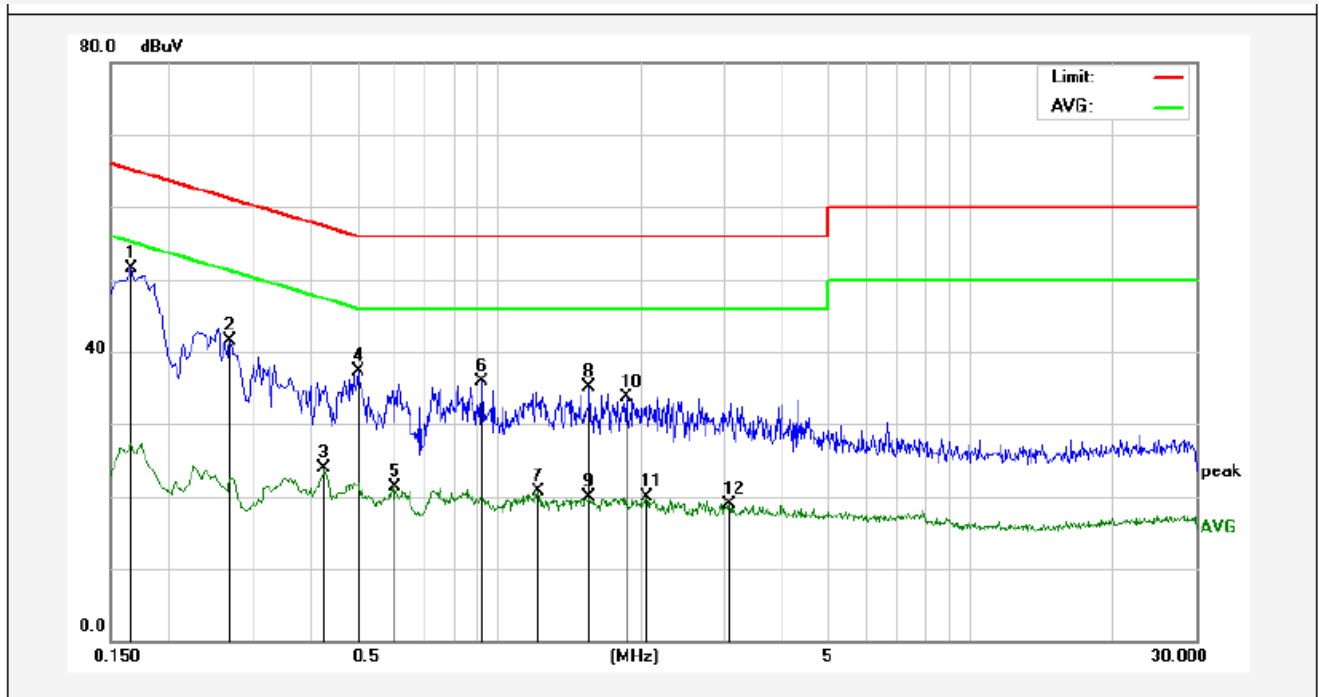

No.	Freq. (MHz)	Reading (dBuV)	Factor (dB)	Result (dBuV)	Limit dBuV	Over Limit (dB)	Detector	Remark
1	0.1660	31.56	19.90	51.46	65.15	-13.69	QP	
2	0.2700	21.69	19.89	41.58	61.12	-19.54	QP	
3	0.4260	3.90	19.95	23.85	47.33	-23.48	AVG	
4	0.5020	17.26	19.98	37.24	56.00	-18.76	QP	
5	0.6020	1.37	20.01	21.38	46.00	-24.62	AVG	
6	0.9220	15.85	20.10	35.95	56.00	-20.05	QP	
7	1.2100	0.55	20.12	20.67	46.00	-25.33	AVG	
8	1.5580	14.99	20.13	35.12	56.00	-20.88	QP	
9	1.5580	-0.15	20.13	19.98	46.00	-26.02	AVG	
10	1.8660	13.66	20.14	33.80	56.00	-22.20	QP	
11	2.0620	-0.25	20.14	19.89	46.00	-26.11	AVG	
12	3.0740	-1.27	20.16	18.89	46.00	-27.11	AVG	

**CONDUCTED EMISSION TEST DATA**

Test Site: 1# Shielded Room  
 Operating Condition: Charge Mode  
 Test Specification: AC 240V, 60Hz for adapter  
 Comment: Live Line  
 Tem.:24°C Hum.:49%

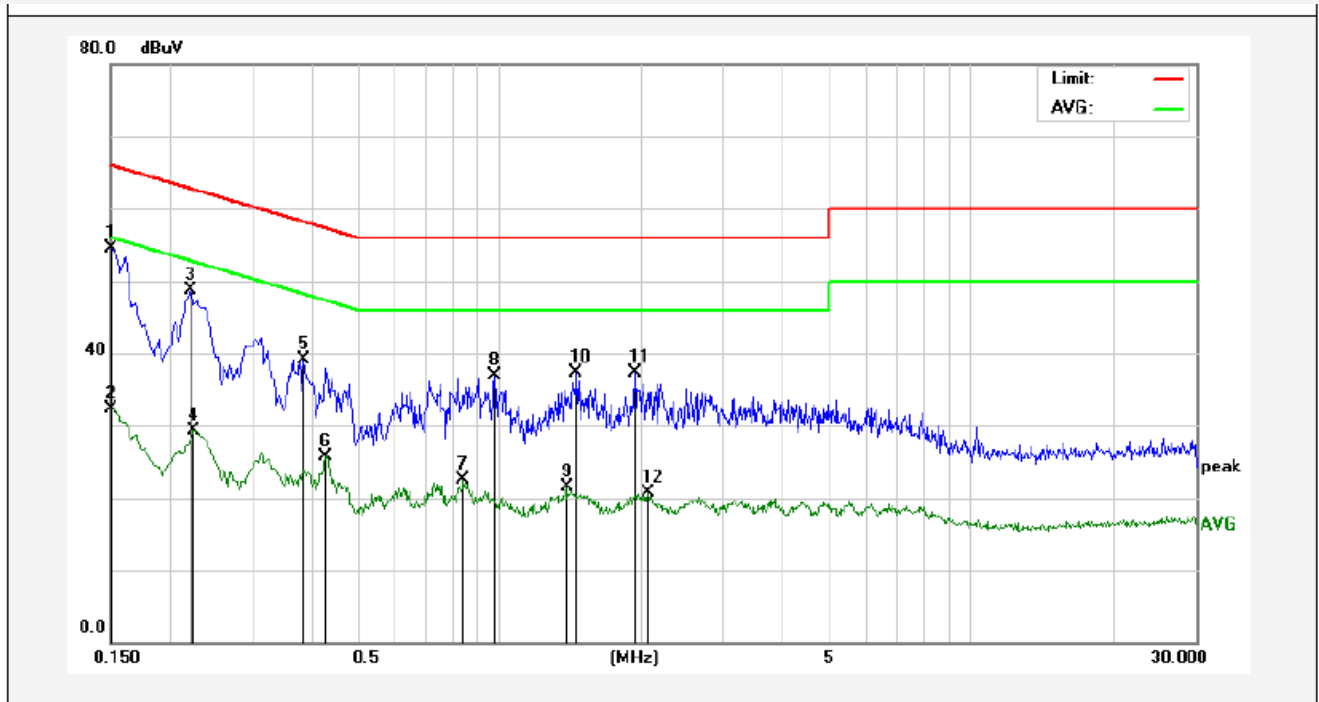

No.	Freq. (MHz)	Reading (dBuV)	Factor (dB)	Result (dBuV)	Limit dBuV	Over Limit (dB)	Detector	Remark
1	0.1500	34.66	19.90	54.56	65.99	-11.43	QP	
2	0.1500	12.35	19.90	32.25	55.99	-23.74	AVG	
3	0.2220	28.82	19.89	48.71	62.74	-14.03	QP	
4	0.2260	9.48	19.89	29.37	52.59	-23.22	AVG	
5	0.3860	19.24	19.93	39.17	58.15	-18.98	QP	
6	0.4300	5.76	19.95	25.71	47.25	-21.54	AVG	
7	0.8420	2.46	20.08	22.54	46.00	-23.46	AVG	
8	0.9820	16.83	20.12	36.95	56.00	-19.05	QP	
9	1.3940	1.36	20.13	21.49	46.00	-24.51	AVG	
10	1.4580	17.08	20.13	37.21	56.00	-18.79	QP	
11	1.9420	17.18	20.14	37.32	56.00	-18.68	QP	
12	2.0660	0.61	20.14	20.75	46.00	-25.25	AVG	

**CONDUCTED EMISSION TEST DATA**

Test Site: 1# Shielded Room  
 Operating Condition: Charge Mode  
 Test Specification: AC 240V, 60Hz for adapter  
 Comment: Neutral Line  
 Tem.:24°C Hum.:49%

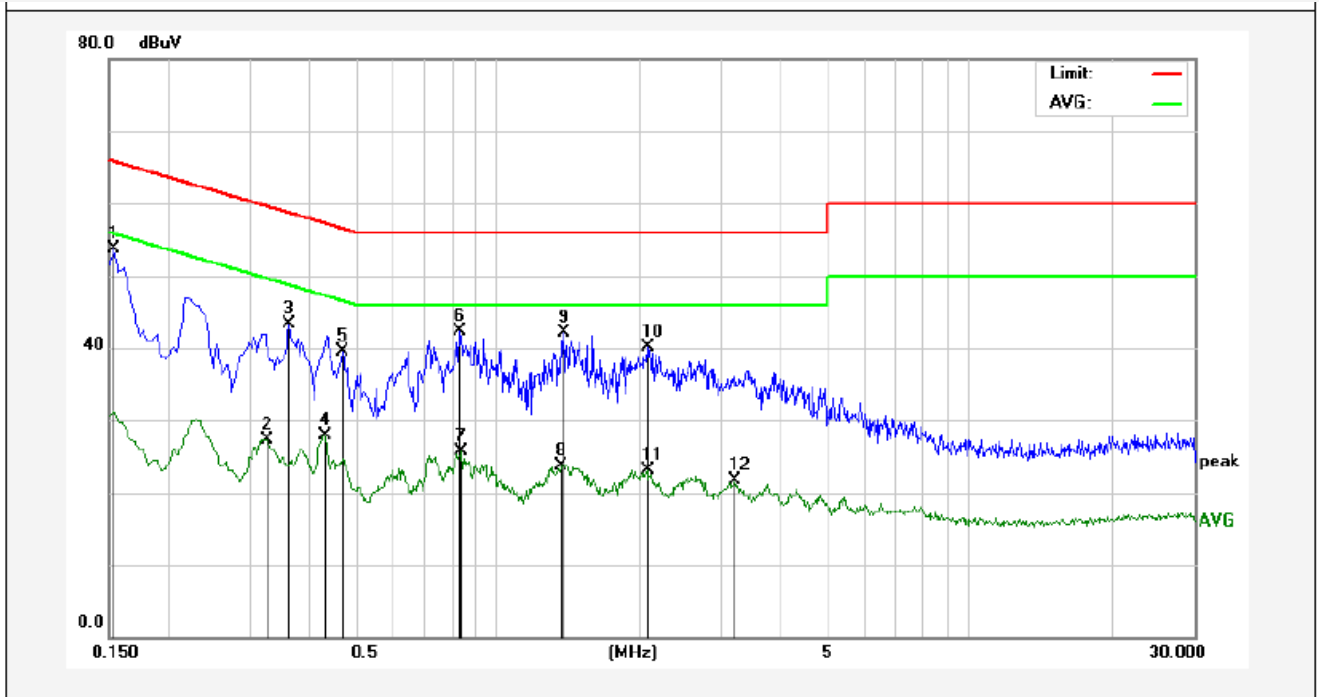

No.	Freq. (MHz)	Reading (dBuV)	Factor (dB)	Result (dBuV)	Limit dBuV	Over Limit (dB)	Detector	Remark
1	0.1539	33.73	19.90	53.63	65.78	-12.15	QP	
2	0.3260	7.49	19.90	27.39	49.55	-22.16	AVG	
3	0.3620	23.31	19.92	43.23	58.68	-15.45	QP	
4	0.4300	7.88	19.95	27.83	47.25	-19.42	AVG	
5	0.4700	19.58	19.97	39.55	56.51	-16.96	QP	
6	0.8340	22.14	20.08	42.22	56.00	-13.78	QP	
7	0.8420	5.53	20.08	25.61	46.00	-20.39	AVG	
8	1.3700	3.65	20.13	23.78	46.00	-22.22	AVG	
9	1.3860	21.92	20.13	42.05	56.00	-13.95	QP	
10	2.0780	19.87	20.14	40.01	56.00	-15.99	QP	
11	2.0780	2.97	20.14	23.11	46.00	-22.89	AVG	
12	3.1860	1.50	20.16	21.66	46.00	-24.34	AVG	

## 4. FCC Part 15.247 Requirements for DTS Device

### 4.1 Test Setup

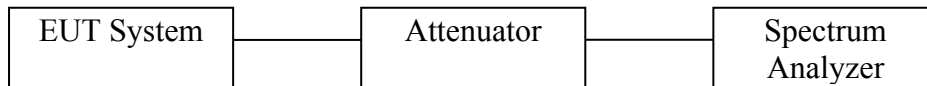

### 4.2 6dB Bandwidth

#### a. Limit

For the direct sequence systems, the minimum 6dB bandwidth shall be at least 500kHz.

#### b. Test Procedure

1. Place the EUT on the table and set it in the transmitting mode.
2. Remove the antenna from the EUT and then connect a low loss RF cable from the antenna port to the spectrum analyzer.
3. Set the spectrum analyzer as:  
RBW = 100kHz, VBW  $\geq 3 \times$  RBW = 300kHz,  
Detector = Peak  
Trace mode = Max hold.  
Sweep - auto couple.
4. Mark the peak frequency and -6dB (upper and lower) frequency.
5. Repeat until all the rest channels are investigated.

**c. Test Setup See 4.1**

**d. Test Equipment**

Item	Equipment	Manufacturer	Model No.	Serial No.	Last Cal.	Cal. Interval
1.	Spectrum Analysis	Agilent	E4407B	US39390582	Apr. 16, 2016	1 Year
2.	Preamplifier	Instruments corporation	EMC011830	980100	Apr. 16, 2016	1 Year
3.	EMI Test Receiver	Rohde & Schwarz	ESPI	101604	Apr. 16, 2016	1 Year
4.	Double Ridged Horn Antenna	Instruments corporation	GTH-0118	351600	Apr. 19, 2016	1 Year
5.	Bilog Broadband Antenna	Schwarzbeck	VULB9163	VULB 9163-289	Apr. 19, 2016	1 Year
6.	Pre-amplifier	SONOMA	310N	186860	Apr. 16, 2016	1 Year
7.	EMI Test Software EZ-EMC	SHURPLE	N/A	N/A	N/A	N/A
8	Power Sensor	DAER	RPR3006W	15I00041SN046	Jun 30, 2016	1 Year
9	MXA Spectrum Analysis	Agilent	N9020A	MY51170037	Jun 30, 2016	1 Year
10	MXG RF Vector Signal Generator	Agilent	N5182A	MY48180656	Jun 30, 2016	1 Year
11	Signal Generator	Agilent	E4421B	MY41000743	Jun 30, 2016	1 Year
12	DC Power supply	IV	IV-8080	YQSB0096	Jun 30, 2016	1 Year
13	TEMP&HUMI PROGRAMMABLE CHAMBER	Bell Group	BE-THK-150M8	SE-0137	Mar. 16, 2016	1 Year

**Test Results**

Channel	Frequency (MHz)	Bandwidth (kHz)	Limit (kHz)	Results
Low	2402	506.0		Pass
Mid	2440	515.5	>500	Pass
High	2480	507.1		Pass

Test Plots See the following page.

CH Low

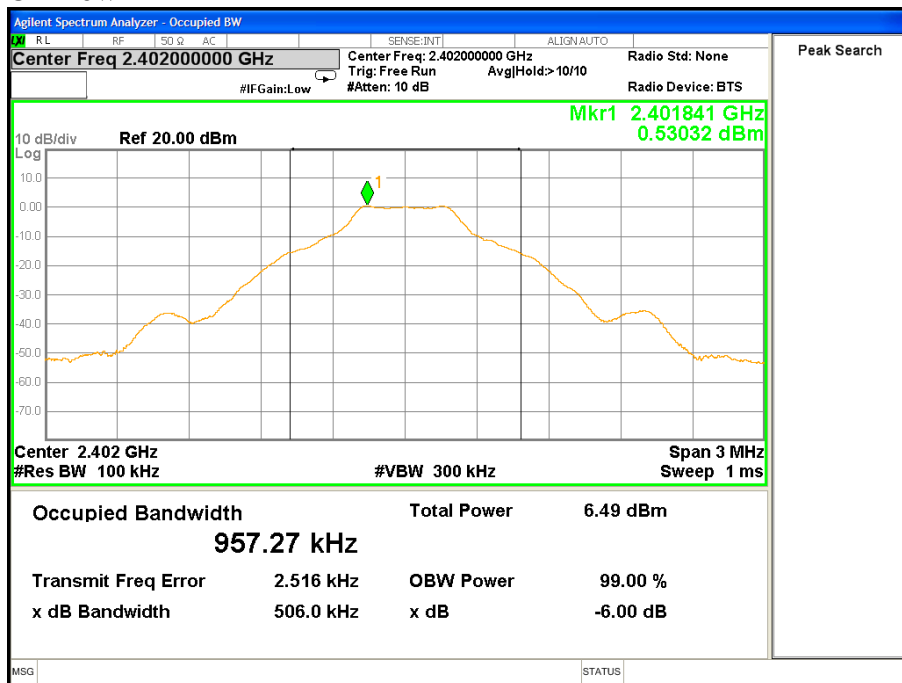

CH Mid

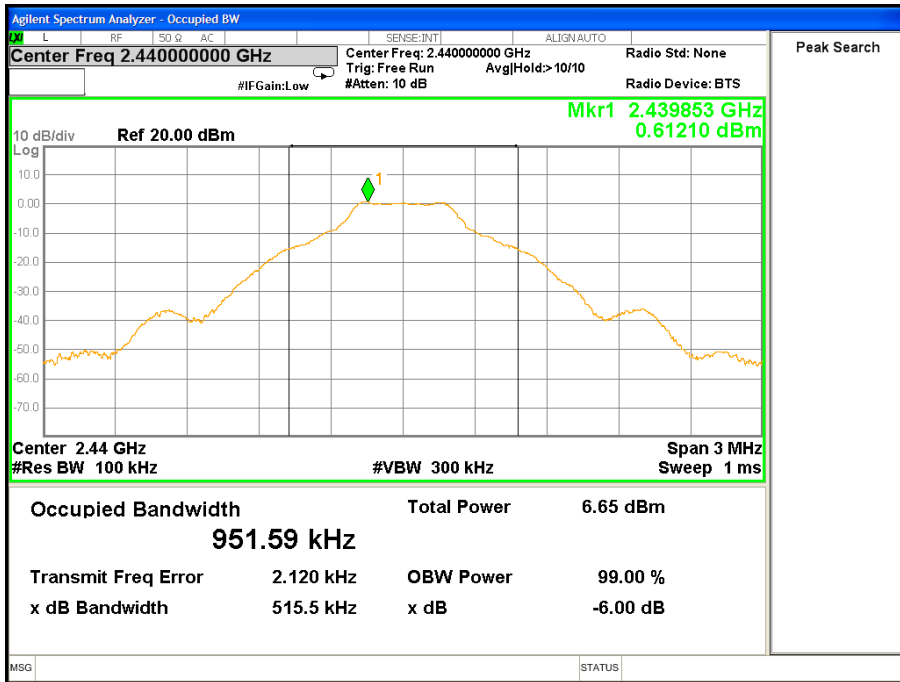

CH High

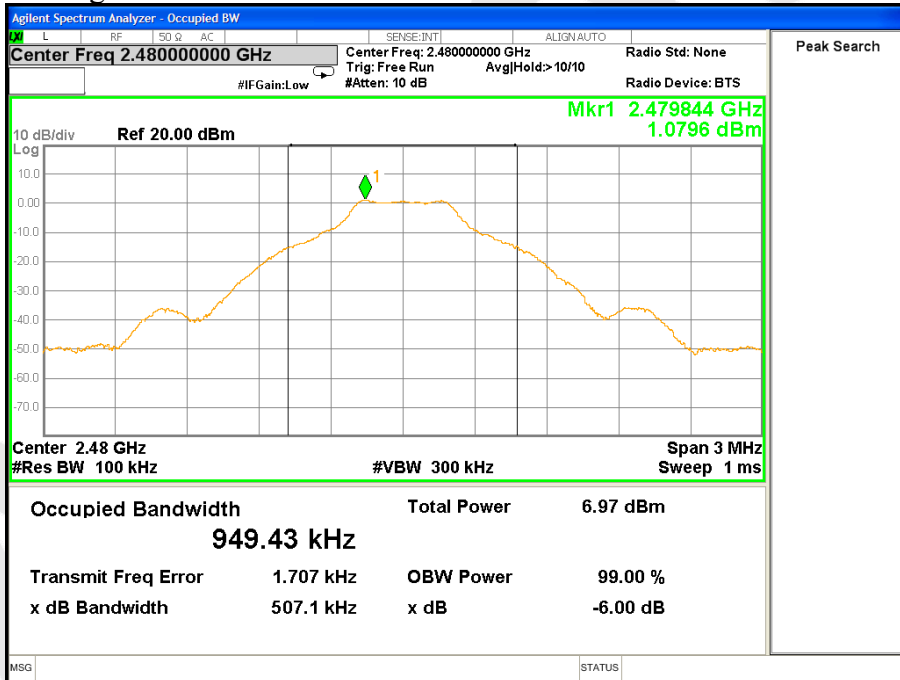

### 4.3. Maximum Peak output power test

#### a. Limit

The maximum peak output power of the intentional radiator shall not exceed the following:

1. For systems using digital modulation in the bands of 902-928 MHz, 2400-2483.5 MHz, and 5725-5850 MHz: 1 watt (30dBm).
2. Except as shown in paragraphs (b)(3) (i), (ii) and (iii) of this section, if transmitting antenna of directional gain greater than 6 dBi are used the peak output power from the intentional radiator shall be reduced below the stated values in paragraphs (b)(1) or (b)(2) of this section, as appropriate, by the amount in dB that the directional gain of the antenna exceeds 6 dBi.

#### b. Configuration of Measurement

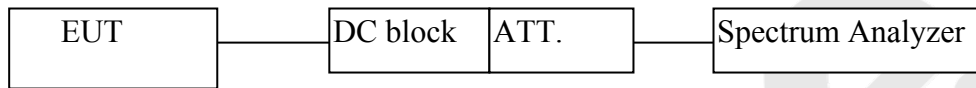

#### c. Test Procedure

**This test was according the kDB 558074 D01 DTS Meas Guidance v03r05 9.1.1:**

1. This procedure shall be used when the measurement instrument has available a resolution bandwidth that is greater than the DTS bandwidth.
2. Set the RBW  $\geq$  DTS bandwidth.
3. Set the VBW  $\geq 3 * RBW$ .
4. Set the span  $\geq 3 * RBW$ .
5. Detector = peak.
6. Sweep time = auto couple.
7. Trace mode = max hold.
8. Allow trace to fully stabilize.
9. Use peak marker function to determine the peak amplitude level.

#### d. Test Equipment

Same as the equipment listed in 4.2.

#### e. Test Results

Pass.

**g. Test Data**

Channel	Frequency (MHz)	Maximum transmit power (dBm)	Limit		Result
			(dBm)	(watts)	
Low	2402	0.848	30	1	Pass
Mid	2440	0.961			Pass
High	2480	1.289			Pass

**CH Low**

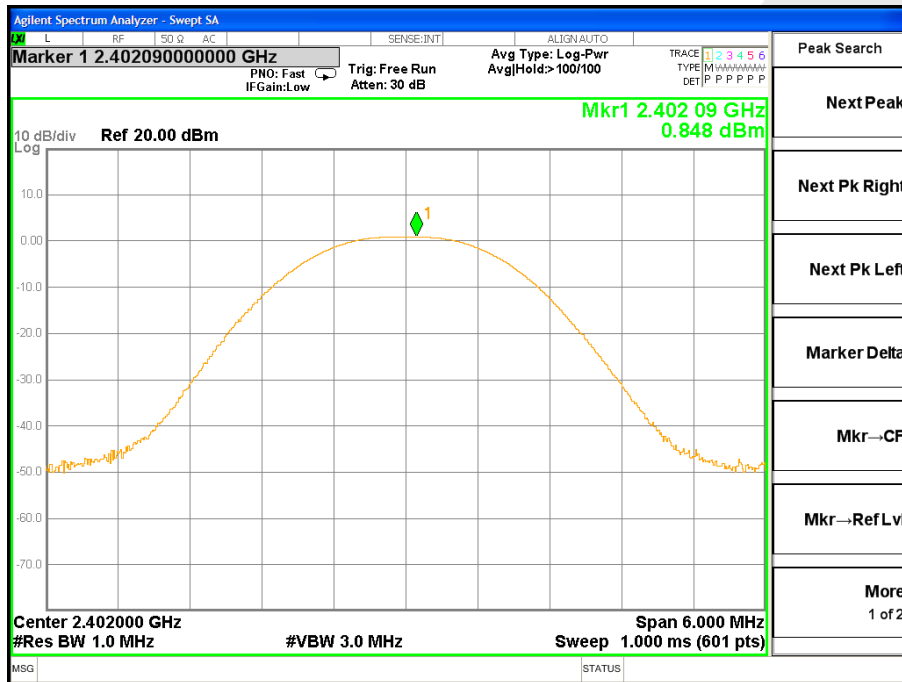

CH Mid

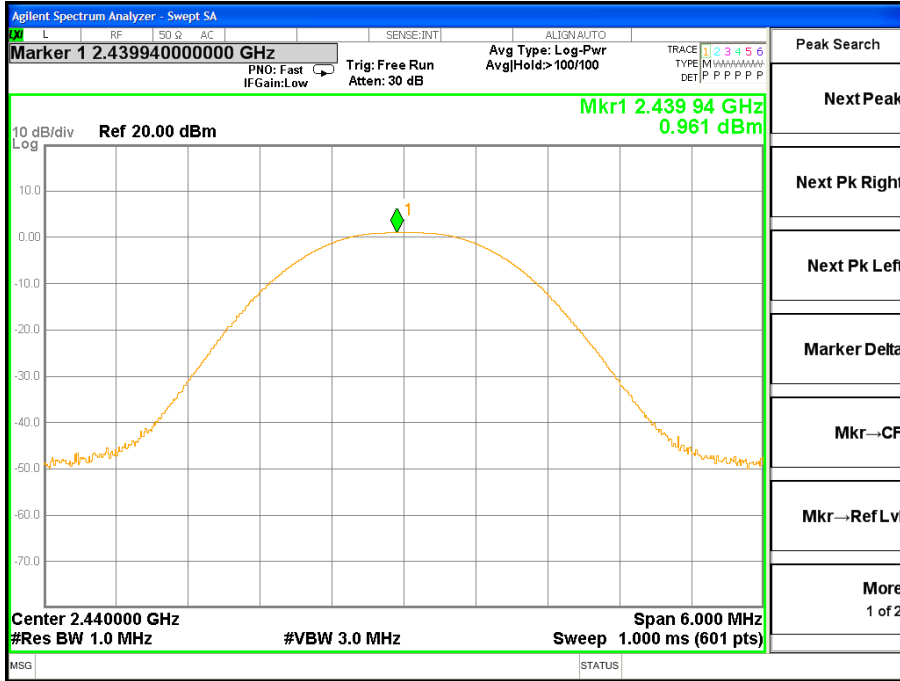

CH High

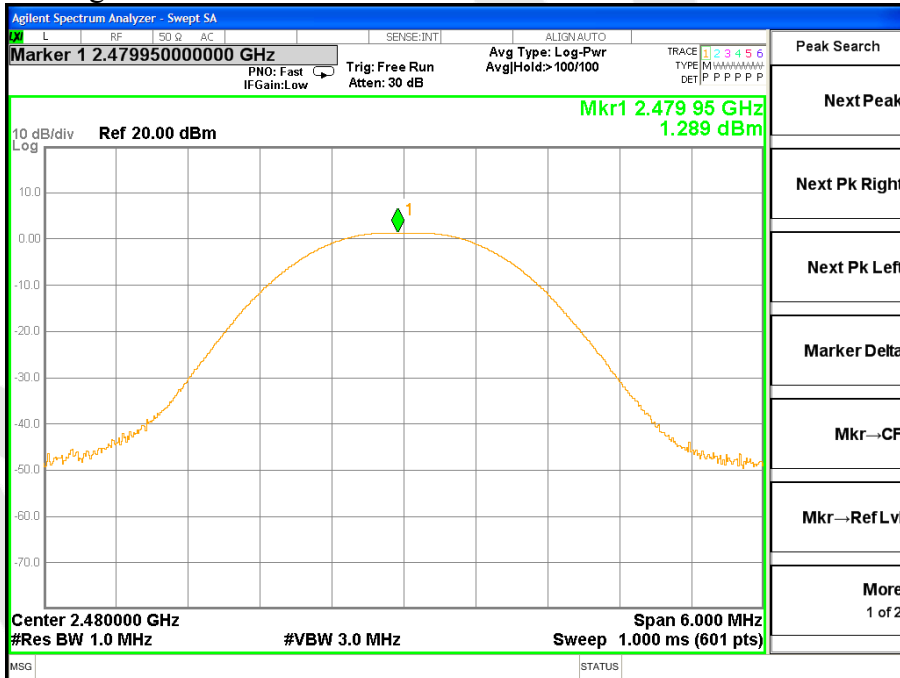

#### 4.4. 100 kHz bandwidth outside the frequency Measurement

**a. Limit**

According to §15.247(c), in any 100 kHz bandwidth outside the frequency bands in which the spread spectrum intentional radiator is operating, the radio frequency power that is produced by the intentional radiator shall be at least 20dB below that in the 100kHz bandwidth within the band that contains the highest level of the desired power, In addition, radiated emissions which fall in the restricted bands, as defined in §15.205(a), must also comply with the radiated emission limits specified in 15.209(a).

**b. Test Procedure**

Measurement Procedure

The EUT must have its hopping/Non-hopping function enabled. Using the following spectrum analyzer setting:

1. Set the RBW = 100KHz.
2. Set the VBW = 300KHz.
3. Sweep time = auto couple.
4. Detector function = peak.
5. Trace mode = max hold.
6. Allow trace to fully stabilize.

**c. Test SET-UP**

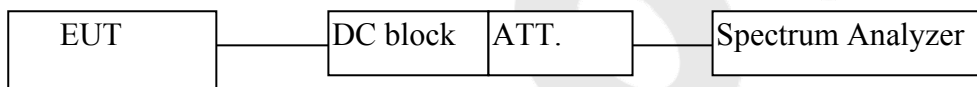

**d. Test Equipment**

Same as the equipment listed in 4.2.

**Test Results**

Frequency Band	Delta Peak to band emission (dBc)	Limit (dBc)	Result
2400	55.704	20	Pass
2483.5	59.541	20	Pass

CH Low

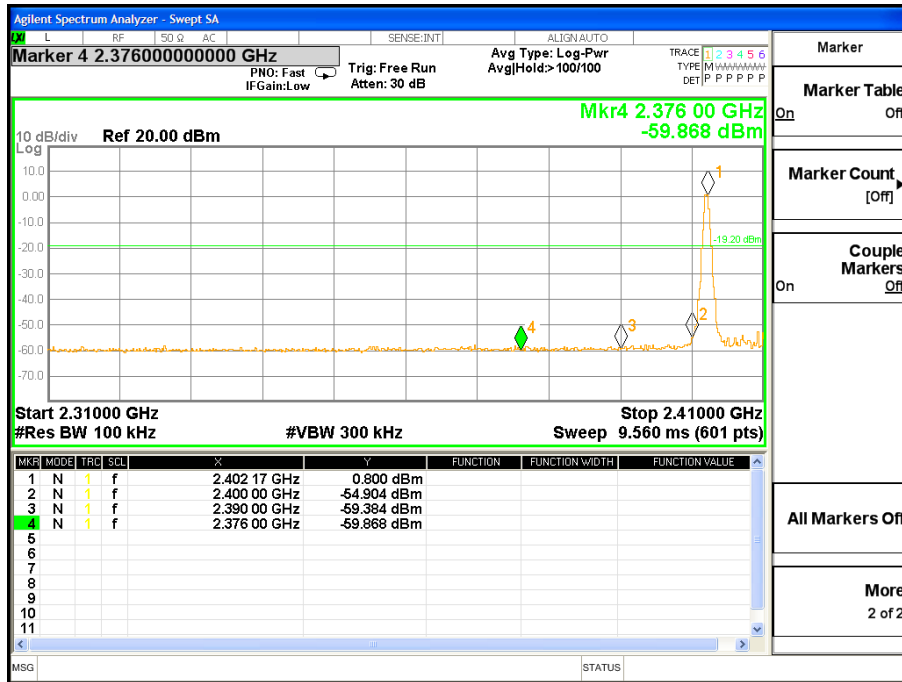

CH High

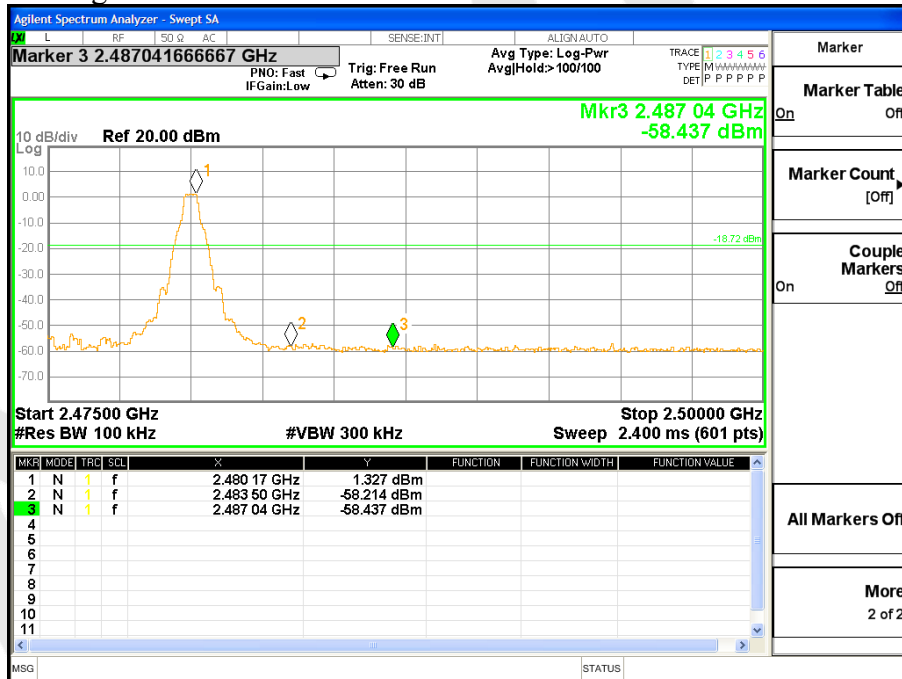

### Conducted Emission Method

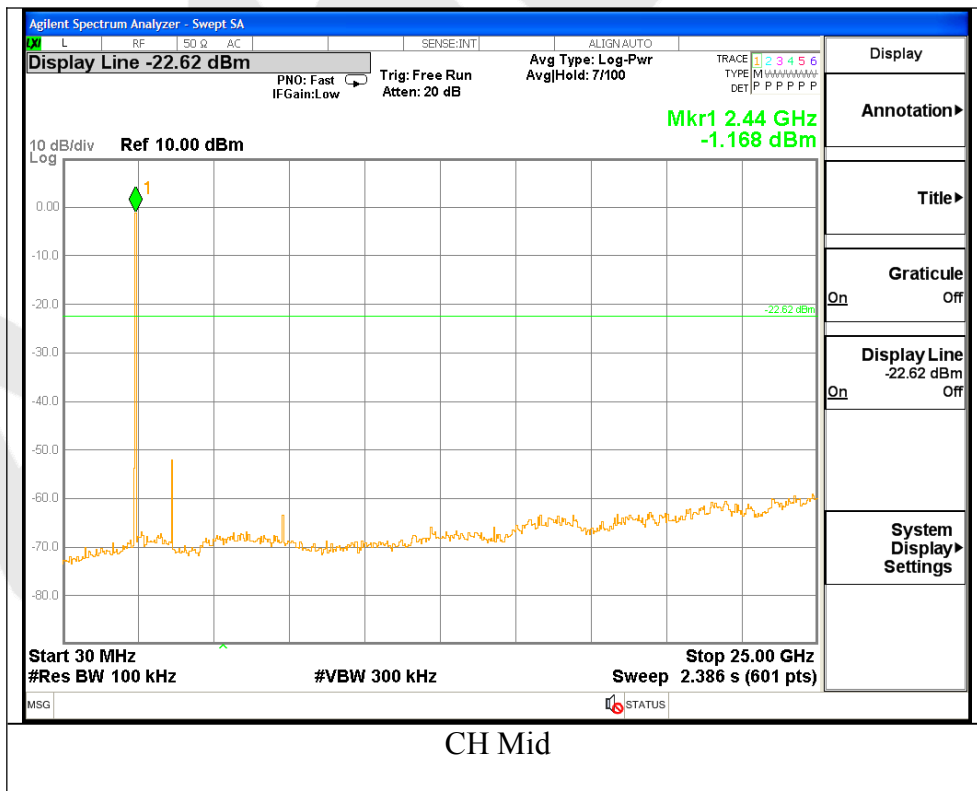
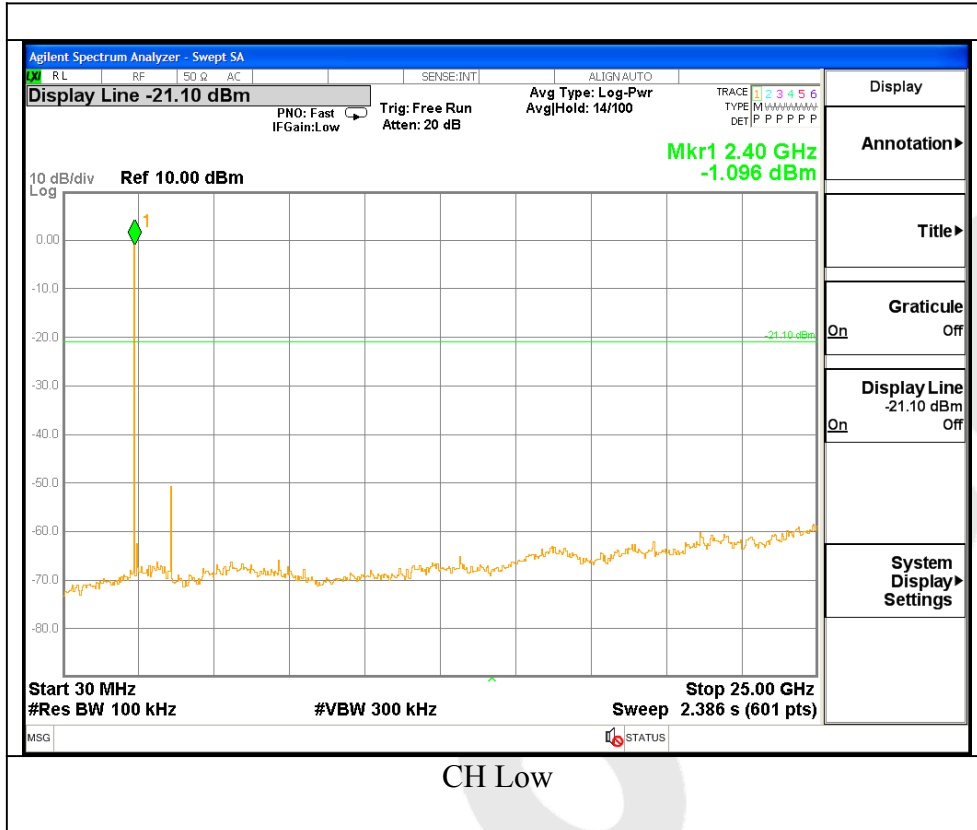

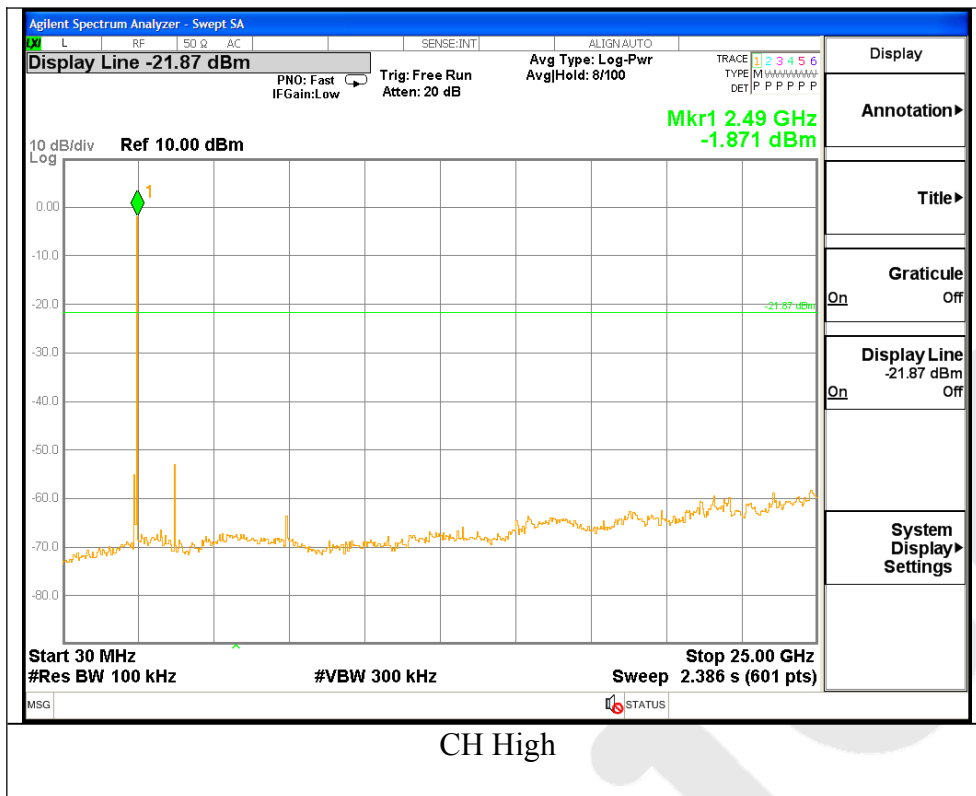

Anbotek

## 4.5. Peak Power Spectral Density

### a. Limit

1. For direct sequence systems, the peak power spectral density conducted from the intentional radiator to the antenna shall not be greater than 8dBm in any 3kHz band during any time interval of continuous transmission.
2. The direct sequence operating of the hybrid system, with the frequency hopping operation turned off, shall comply with the power density requirements of paragraph (d) of this section.

### b. Test Procedure

1. Place the EUT on the table and set it in transmitting mode. Remove the antenna from the EUT and then connect a low loss RF cable from the antenna port to the spectrum analyzer.
2. Set the spectrum analyzer as RBW = 3kHz, VBW = 10kHz, Span = 1.5xDTS BW
3. Record the max. reading.
4. Repeat the above procedure until the measurements for all frequencies are completed.

### c. Test Equipment

Same as the equipment listed in 4.2.

### d. Test Setup

See 3.1

**Test Results**

Channel	Frequency (MHz)	PPSD (dBm/3KHz)	∑PPSD (dBm/3KHz)	Limit (dBm)	Result
Low	2402	-11.077	-	8.00	Pass
Mid	2440	-10.964	-	8.00	Pass
High	2480	-10.540	-	8.00	Pass

CH Low

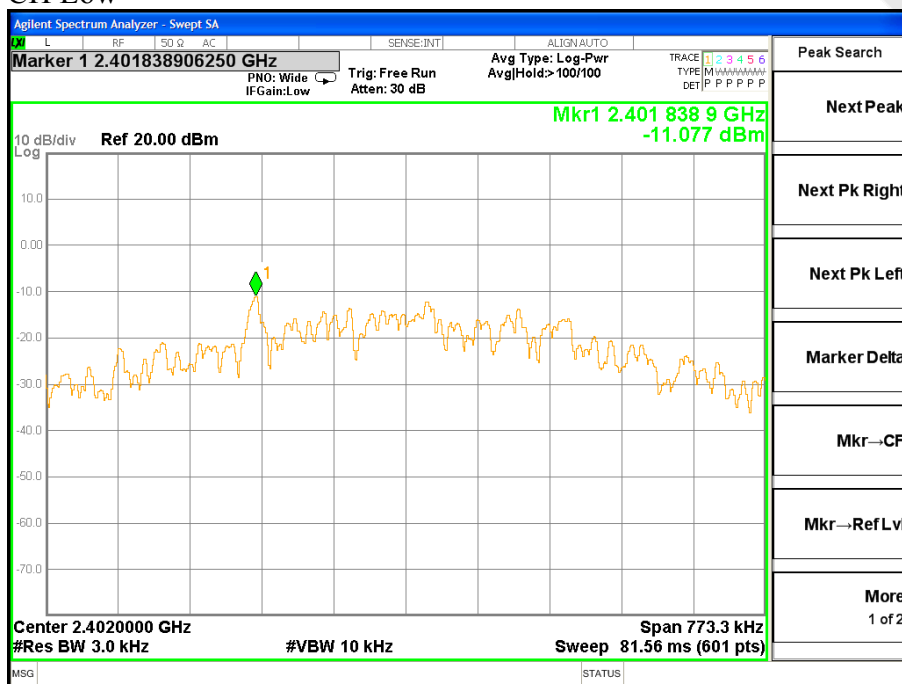

CH Mid

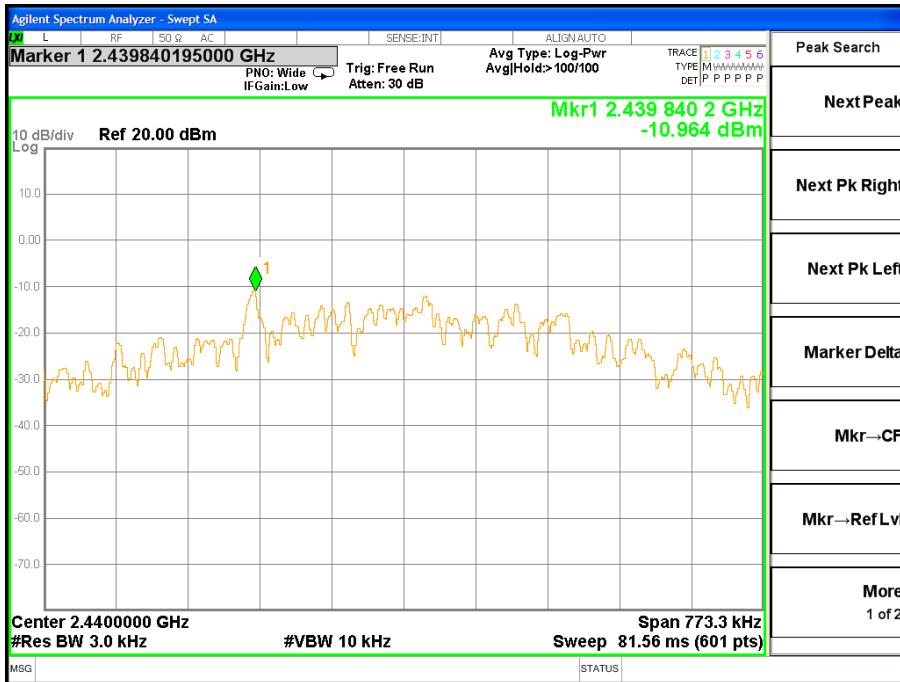

CH High

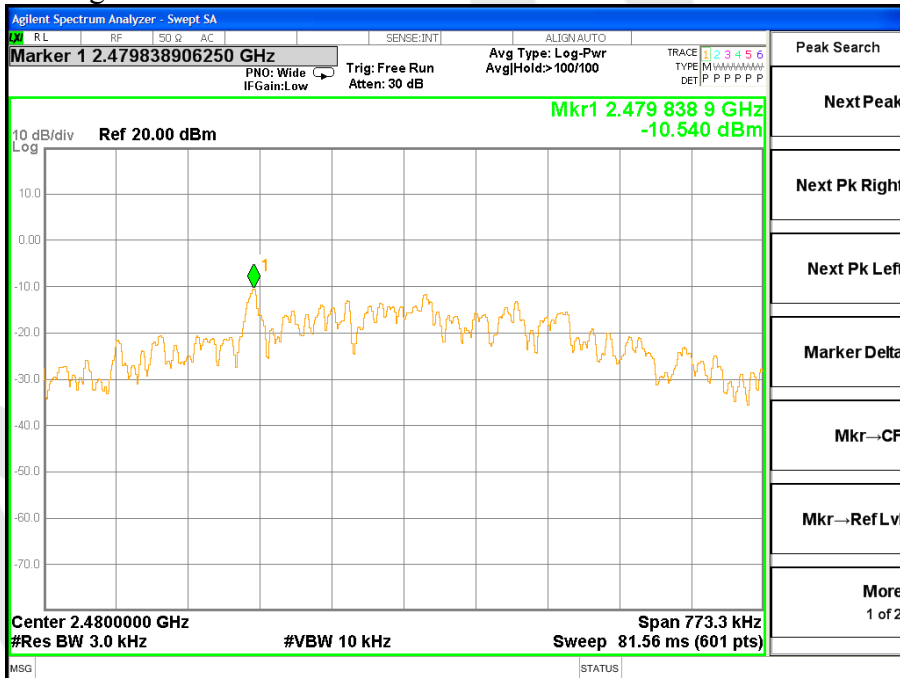

#### 4.6. Radiated Emissions and Band Edges Measurement

##### 4.6.1.1. Test Limits (< 30 MHz)

Frequency (MHz)	Field Strength (microvolts/meter)	Measurement Distance (meter)
0.009-0.490	2400/F(kHz)	300
0.490-1.705	24000/F(kHz)	30
1.705-30.0	30	30

##### 4.6.1.2. Test Limits (≥ 30 MHz)

FIELD STRENGTH of Fundamental: @3M	FIELD STRENGTH of Harmonics	S15.209	
902-928 MHz		30 - 88 MHz	40 dBuV/m
2.4-2.4835 GHz		88 - 216 MHz	43.5
94 dBμV/m @3m	54 dBμV/m @3m	216 - 960 MHz	46
		ABOVE 960 MHz	54dBuV/m

In any 100 kHz bandwidth outside the frequency band in which the spread spectrum or digitally modulated intentional radiator is operating, the radio frequency power that is produced by the intentional radiator shall be at least 20 dB below that in the 100 kHz bandwidth within the band that contains the highest level of the desired power, based on either an RF conducted or a radiated measurement. Attenuation below the general limits specified in Section 15.209(a) is not required. In addition, radiated emissions which fall in the restricted bands, as defined in Section 15.205(a), must also comply with the radiated emission limits specified in Section 15.209(a) (see Section 15.205(c)).

#### Test Equipment

Item	Equipment	Manufacturer	Model No.	Serial No.	Last Cal.	Cal. Interval
1.	Spectrum Analysis	Agilent	E4407B	US39390582	Apr. 16, 2016	1 Year
2.	Preamplifier	Instruments corporation	EMC011830	980100	Apr. 16, 2016	1 Year
3.	EMI Test Receiver	Rohde & Schwarz	ESPI	101604	Apr. 16, 2016	1 Year
4.	Double Ridged Horn Antenna	Instruments corporation	GTH-0118	351600	Apr. 19, 2016	1 Year
5.	Bilog Broadband Antenna	Schwarzbeck	VULB9163	VULB 9163-289	Apr. 19, 2016	1 Year
6.	Pre-amplifier	SONOMA	310N	186860	Apr. 16, 2016	1 Year
7.	EMI Test Software EZ-EMC	SHURPLE	N/A	N/A	N/A	N/A
8.	Power Sensor	DAER	RPR3006W	15I00041SN046	Jun 30, 2016	1 Year
9.	MXA Spectrum Analysis	Agilent	N9020A	MY51170037	Jun 30, 2016	1 Year
10.	DC Power supply	IV	IV-8080	YQSB0096	Jun 30, 2016	1 Year
11.	TEMP&HUMI PROGRAMMABLE CHAMBER	Bell Group	BE-THK-150M8	SE-0137	Mar. 16, 2016	1 Year

4.6.2. Test Configuration:

4.6.2.1. 9k to 30MHz emissions:

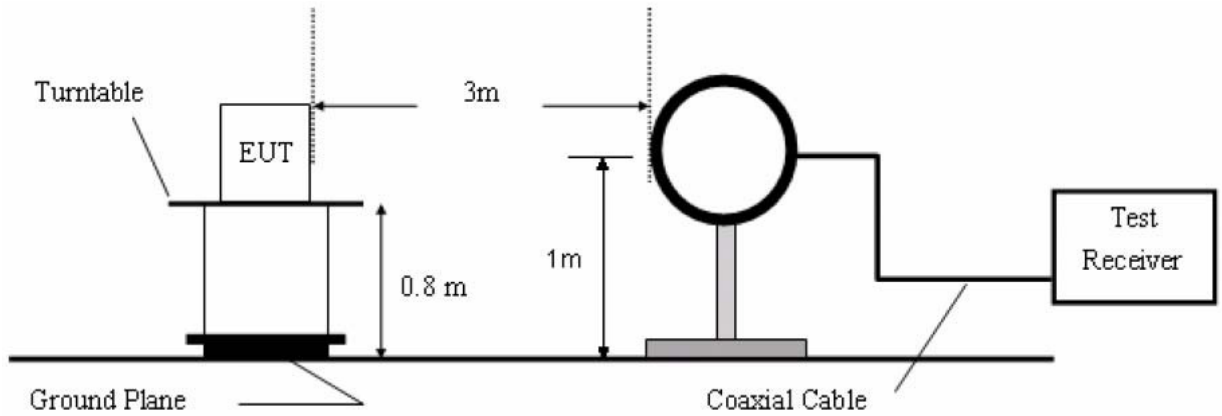

4.6.2.2. 30M to 1G emissions:

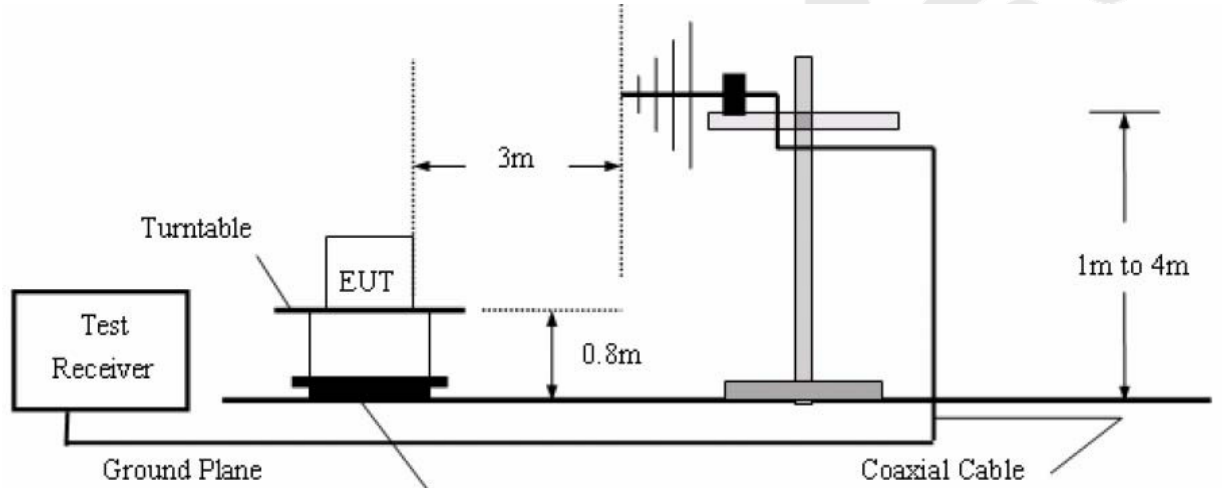

4.6.2.3. 1G to 40G emissions:

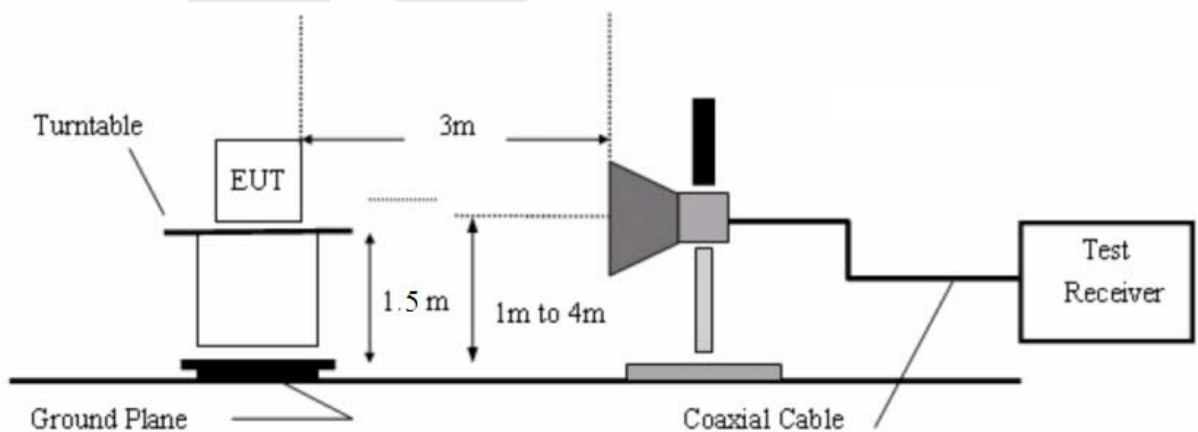

#### 4.6.3. Test Procedure

For below 1GHz: The EUT is placed on a turntable, which is 0.8m above the ground plane.  
For above 1GHz: The EUT is placed on a turntable, which is 1.5m above the ground plane.  
The turn table can rotate 360 degrees to determine the position of the maximum emission level.  
The EUT is set 3 meters away from the receiving antenna which is mounted on a antenna tower.  
The antenna can be moved up and down from 1 to 4 meters to find out the maximum emission level. Both horizontal and vertical polarization of the antenna are set on test.

Measurements are made on 9KHz to 30MHz and 30MHz to 26GHz range with the transmitter set to the lowest, middle, and highest channels.

All readings from 30MHz to 1GHz are quasi-peak values with a resolution bandwidth of 120kHz. All reading are above 1GHz, peak & average values with a resolution bandwidth of 1MHz.

The EUT is tested in 9\*6\*6 Chamber. The device is evaluated in xyz orientation.

The test results are listed in Section 4.6.4.

#### 4.6.4. Test Results

PASS.

The EUT was tested on (Charge Mode, BT Mode) modes, only the worst data of (Charge Mode) is attached in the following pages.

Only the worst case (x orientation).

The test results of above 18000MHz are attenuated more than 20dB below the permissible limits, so the results don't record in the report.

Job No.:	011611857I	Polarization:	Horizontal
Standard:	FCC PART15 C	Power Source:	AC 120V, 60Hz for adapter
Test item:	Radiation Test	Temp.(C)/Hum.(%RH):	24.4(C)/50% RH
Test Mode:	Charge Mode	Distance:	3m

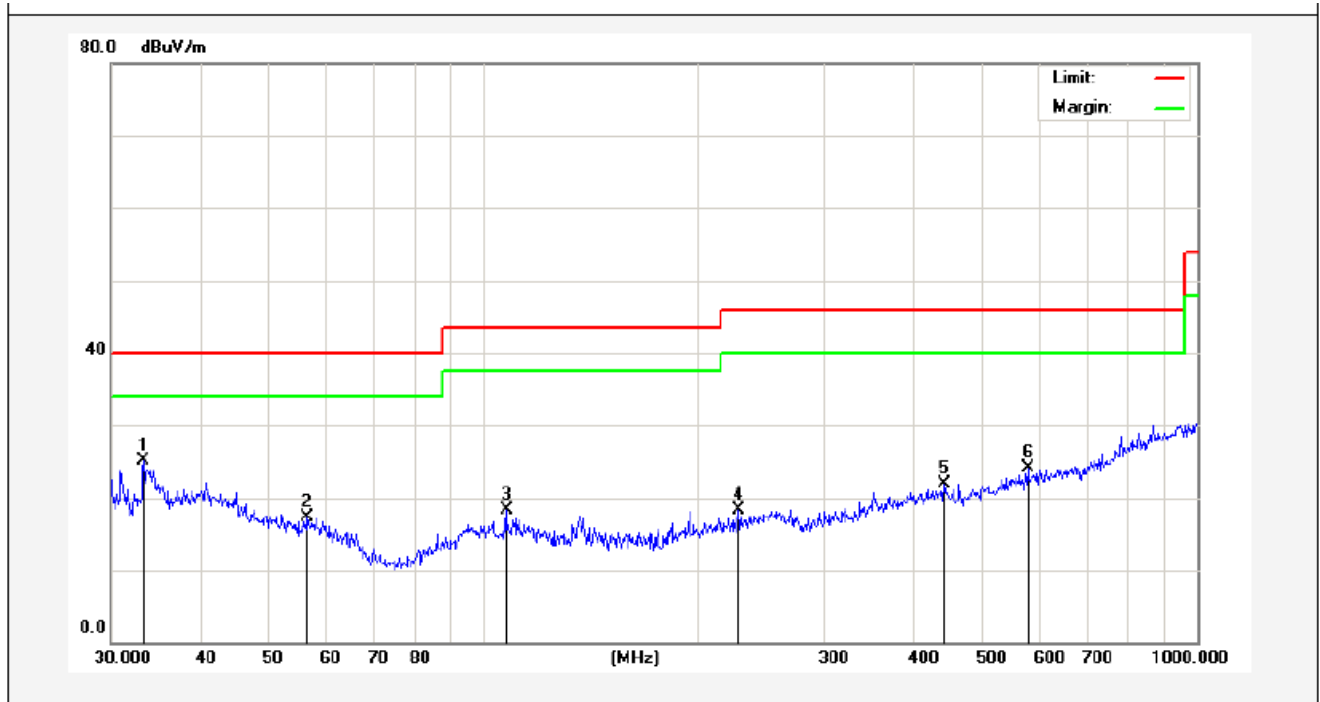

No.	Freq. (MHz)	Reading (dBuV/m)	Factor (dB/m)	Result (dBuV/m)	Limit (dBuV/)	Over Limit (dB)	Detector	Height (cm)	degree (deg)	Remark
1	33.3279	40.29	-15.18	25.11	40.00	-14.89	peak			
2	56.5929	32.31	-15.08	17.23	40.00	-22.77	peak			
3	107.5101	38.91	-20.66	18.25	43.50	-25.25	peak			
4	227.6906	37.70	-19.33	18.37	46.00	-27.63	peak			
5	441.7426	34.15	-12.20	21.95	46.00	-24.05	peak			
6	578.6699	35.20	-11.18	24.02	46.00	-21.98	peak			

Job No.:	011611857I	Polarization:	Vertical
Standard:	FCC PART15 C	Power Source:	AC 120V, 60Hz for adapter
Test item:	Radiation Test	Temp.(C)/Hum.(%RH):	24.4(C)/50% RH
Test Mode:	Charge Mode	Distance:	3m

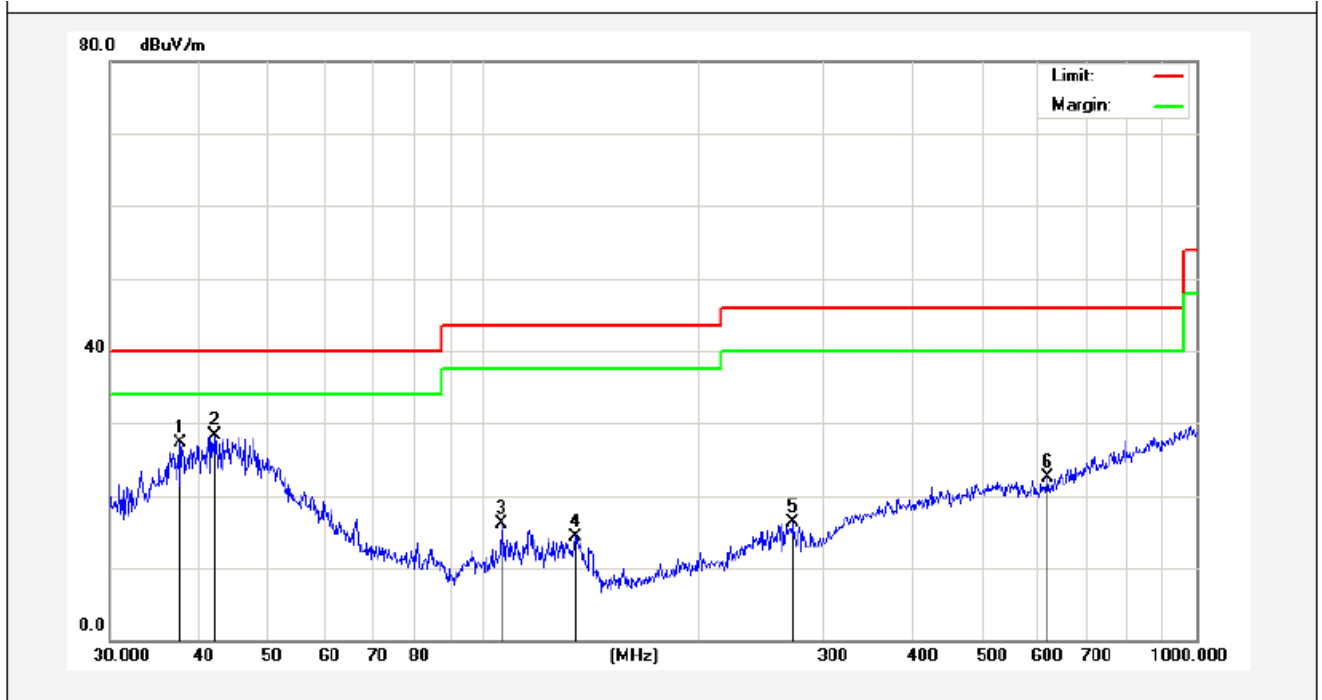

No.	Freq. (MHz)	Reading (dBuV/m)	Factor (dB/m)	Result (dBuV/m)	Limit (dBuV/)	Over Limit (dB)	Detector	Height (cm)	degree (deg)	Remark
1	37.5479	39.59	-12.30	27.29	40.00	-12.71	peak			
2	42.0066	39.55	-11.15	28.40	40.00	-11.60	peak			
3	106.0126	31.86	-15.69	16.17	43.50	-27.33	peak			
4	134.5592	32.52	-18.12	14.40	43.50	-29.10	peak			
5	271.3246	30.93	-14.69	16.24	46.00	-29.76	peak			
6	618.5369	31.51	-9.09	22.42	46.00	-23.58	peak			

**Test Results (Above 1000MHz)**

Test channel:	Low CH
---------------	--------

Peak value:

Frequency (MHz)	Read Level (dBuV)	Antenna Factor (dB/m)	Cable Loss (dB)	Preamp Factor (dB)	Level (dBuV/m)	Limit Line (dBuV/m)	Over Limit (dB)	Polarization
4804.00	38.07	34.04	6.58	34.09	44.60	74.00	-29.40	Vertical
7206.00	32.34	37.11	7.73	34.50	42.68	74.00	-31.32	Vertical
9608.00	31.92	39.31	9.23	34.79	45.67	74.00	-28.33	Vertical
12010.00	*					74.00		Vertical
14412.00	*					74.00		Vertical
4804.00	42.51	34.04	6.58	34.09	49.04	74.00	-24.96	Horizontal
7206.00	34.16	37.11	7.73	34.50	44.50	74.00	-29.50	Horizontal
9608.00	31.41	39.31	9.23	34.79	45.16	74.00	-28.84	Horizontal
12010.00	*					74.00		Horizontal
14412.00	*					74.00		Horizontal

Average value:

Frequency (MHz)	Read Level (dBuV)	Antenna Factor (dB/m)	Cable Loss (dB)	Preamp Factor (dB)	Level (dBuV/m)	Limit Line (dBuV/m)	Over Limit (dB)	Polarization
4804.00	26.74	34.04	6.58	34.09	33.27	54.00	-20.73	Vertical
7206.00	20.94	37.11	7.73	34.50	31.28	54.00	-22.72	Vertical
9608.00	19.97	39.31	9.23	34.79	33.72	54.00	-20.28	Vertical
12010.00	*					54.00		Vertical
14412.00	*					54.00		Vertical
4804.00	31.05	34.04	6.58	34.09	37.58	54.00	-16.42	Horizontal
7206.00	23.16	37.11	7.73	34.50	33.50	54.00	-20.50	Horizontal
9608.00	19.76	39.31	9.23	34.79	33.51	54.00	-20.49	Horizontal
12010.00	*					54.00		Horizontal
14412.00	*					54.00		Horizontal

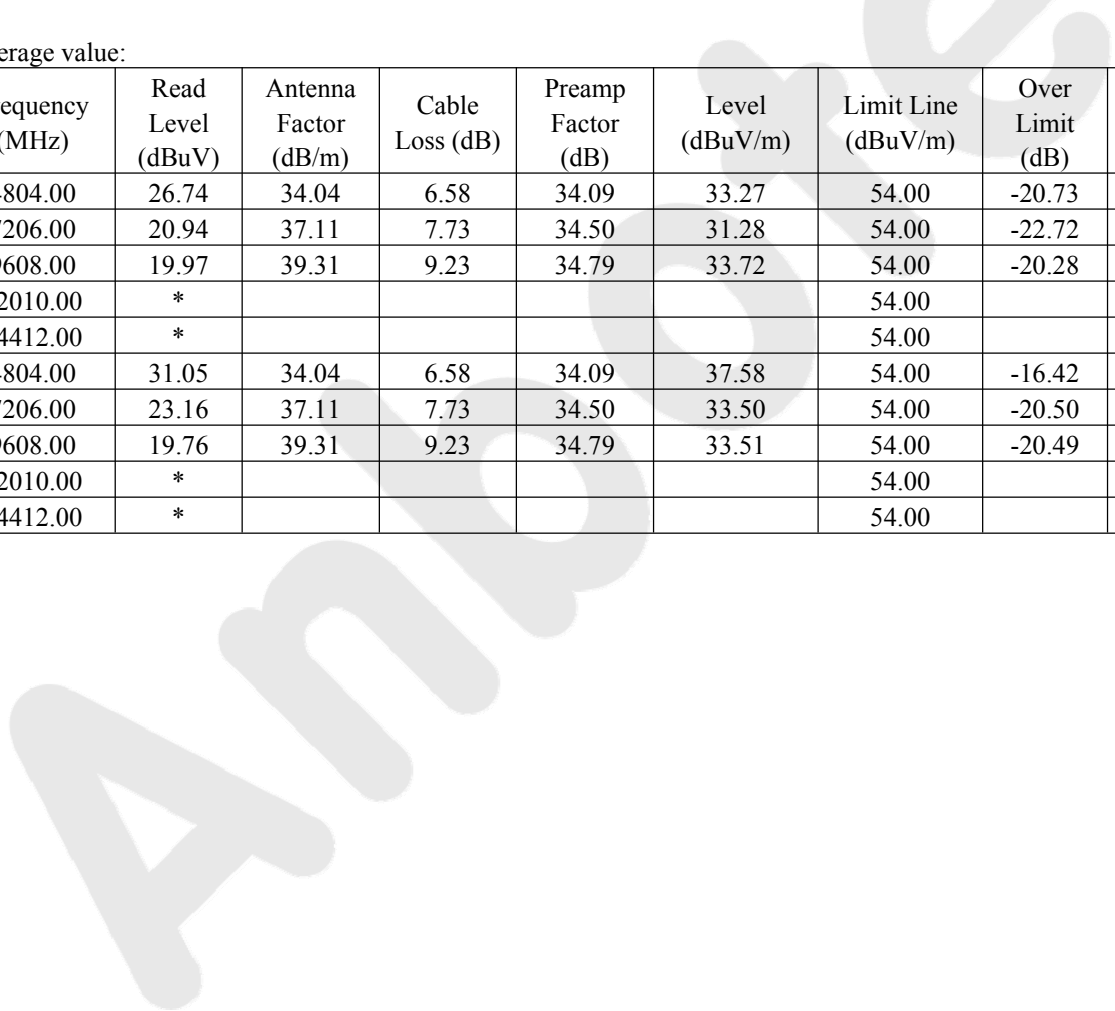

Test channel:	Mid CH
---------------	--------

Peak value:

Frequency (MHz)	Read Level (dBuV)	Antenna Factor (dB/m)	Cable Loss (dB)	Preamp Factor (dB)	Level (dBuV/m)	Limit Line (dBuV/m)	Over Limit (dB)	Polarization
4804.00	36.46	34.38	6.69	34.09	43.44	74.00	-30.56	Vertical
7206.00	31.27	37.22	7.78	34.53	41.74	74.00	-32.26	Vertical
9608.00	30.97	39.46	9.35	34.80	44.98	74.00	-29.02	Vertical
12010.00	*					74.00		Vertical
14412.00	*					74.00		Vertical
4804.00	40.57	34.38	6.69	34.09	47.55	74.00	-26.45	Horizontal
7206.00	32.95	37.22	7.78	34.53	43.42	74.00	-30.58	Horizontal
9608.00	30.31	39.46	9.35	34.80	44.32	74.00	-29.68	Horizontal
12010.00	*					74.00		Horizontal
14412.00	*					74.00		Horizontal

Average value:

Frequency (MHz)	Read Level (dBuV)	Antenna Factor (dB/m)	Cable Loss (dB)	Preamp Factor (dB)	Level (dBuV/m)	Limit Line (dBuV/m)	Over Limit (dB)	Polarization
4804.00	25.44	34.38	6.69	34.09	32.42	54.00	-21.58	Vertical
7206.00	20.06	37.22	7.78	34.53	30.53	54.00	-23.47	Vertical
9608.00	19.19	39.46	9.35	34.80	33.20	54.00	-20.80	Vertical
12010.00	*					54.00		Vertical
14412.00	*					54.00		Vertical
4804.00	29.58	34.38	6.69	34.09	36.56	54.00	-17.44	Horizontal
7206.00	22.17	37.22	7.78	34.53	32.64	54.00	-21.36	Horizontal
9608.00	18.85	39.46	9.35	34.80	32.86	54.00	-21.14	Horizontal
12010.00	*					54.00		Horizontal
14412.00	*					54.00		Horizontal

Test channel:	High CH
---------------	---------

Peak value:

Frequency (MHz)	Read Level (dBuV)	Antenna Factor (dB/m)	Cable Loss (dB)	Preamp Factor (dB)	Level (dBuV/m)	Limit Line (dBuV/m)	Over Limit (dB)	Polarization
4804.00	36.20	34.72	6.79	34.09	43.62	74.00	-30.38	Vertical
7206.00	31.10	37.34	7.82	34.57	41.69	74.00	-32.31	Vertical
9608.00	30.82	39.62	9.46	34.81	45.09	74.00	-28.91	Vertical
12010.00	*					74.00		Vertical
14412.00	*					74.00		Vertical
4804.00	40.26	34.72	6.79	34.09	47.68	74.00	-26.32	Horizontal
7206.00	32.75	37.34	7.82	34.57	43.34	74.00	-30.66	Horizontal
9608.00	30.13	39.62	9.46	34.81	44.40	74.00	-29.60	Horizontal
12010.00	*					74.00		Horizontal
14412.00	*					74.00		Horizontal

Average value:

Frequency (MHz)	Read Level (dBuV)	Antenna Factor (dB/m)	Cable Loss (dB)	Preamp Factor (dB)	Level (dBuV/m)	Limit Line (dBuV/m)	Over Limit (dB)	Polarization
4804.00	25.28	34.72	6.79	34.09	32.70	54.00	-21.30	Vertical
7206.00	19.94	37.34	7.82	34.57	30.53	54.00	-23.47	Vertical
9608.00	19.09	39.62	9.46	34.81	33.36	54.00	-20.64	Vertical
12010.00	*					54.00		Vertical
14412.00	*					54.00		Vertical
4804.00	29.39	34.72	6.79	34.09	36.81	54.00	-17.19	Horizontal
7206.00	22.05	37.34	7.82	34.57	32.64	54.00	-21.36	Horizontal
9608.00	18.73	39.62	9.46	34.81	33.00	54.00	-21.00	Horizontal
12010.00	*					54.00		Horizontal
14412.00	*					54.00		Horizontal

Note:

1, Final Level = Receiver Read level + Antenna Factor + Cable Loss – Pre-amplifier Factor

2, “\*”, means this data is the too weak instrument of signal is unable to test.

**Radiated band edge:**

Test channel:	Lowest CH
---------------	-----------

Peak value:

Frequency (MHz)	Read Level (dBuV)	Antenna Factor (dB/m)	Cable Loss (dB)	Preamp Factor (dB)	Level (dBuV/m)	Limit Line (dBuV/m)	Over Limit (dB)	Polarization
2390.00	46.10	27.59	5.38	30.18	48.89	74.00	-25.11	Horizontal
2400.00	63.35	27.58	5.39	30.18	66.14	74.00	-7.86	Horizontal
2390.00	46.96	27.59	5.38	30.18	49.75	74.00	-24.25	Vertical
2400.00	65.73	27.58	5.39	30.18	68.52	74.00	-5.48	Vertical

Average value:

Frequency (MHz)	Read Level (dBuV)	Antenna Factor (dB/m)	Cable Loss (dB)	Preamp Factor (dB)	Level (dBuV/m)	Limit Line (dBuV/m)	Over Limit (dB)	Polarization
2390.00	35.13	29.15	3.41	34.01	33.68	54.00	-20.32	Horizontal
2400.00	46.50	29.16	3.43	34.01	45.08	54.00	-8.93	Horizontal
2390.00	35.23	29.15	3.41	34.01	33.78	54.00	-20.22	Vertical
2400.00	48.35	29.16	3.43	34.01	46.93	54.00	-7.07	Vertical

Test channel:	Highest CH
---------------	------------

Peak value:

Frequency (MHz)	Read Level (dBuV)	Antenna Factor (dB/m)	Cable Loss (dB)	Preamp Factor (dB)	Level (dBuV/m)	Limit Line (dBuV/m)	Over Limit (dB)	Polarization
2483.50	47.44	29.28	3.53	34.03	46.22	74.00	-27.78	Horizontal
2500.00	46.19	29.30	3.56	34.03	45.02	74.00	-28.98	Horizontal
2483.50	48.65	29.28	3.53	34.03	47.43	74.00	-26.57	Vertical
2500.00	47.40	29.30	3.56	34.03	46.23	74.00	-27.77	Vertical

Average value:

Frequency (MHz)	Read Level (dBuV)	Antenna Factor (dB/m)	Cable Loss (dB)	Preamp Factor (dB)	Level (dBuV/m)	Limit Line (dBuV/m)	Over Limit (dB)	Polarization
2483.50	37.98	29.28	3.53	34.03	36.76	54.00	-17.24	Horizontal
2500.00	35.67	29.30	3.56	34.03	34.50	54.00	-19.50	Horizontal
2483.50	39.38	29.28	3.53	34.03	38.16	54.00	-15.84	Vertical
2500.00	35.77	29.30	3.56	34.03	34.60	54.00	-19.40	Vertical

*Note: Final Level = Receiver Read level + Antenna Factor + Cable Loss – Pre-amplifier Factor*

## 5. ANTENNA APPLICATION

### 5.1. Antenna requirement

The EUT'S antenna is met the requirement of FCC part 15C section 15.203.

An intentional radiator shall be designed to ensure that no antenna other than that furnished by the responsible party shall be used with the device. The use of a permanently attached antenna or of an antenna that uses a unique coupling to the intentional radiator shall be considered sufficient to comply with the provisions of this section. The manufacturer may design the unit so that a broken antenna can be replaced by the user, but the use of a standard antenna jack or electrical connector is prohibited. This requirement does not apply to carrier current devices or to devices operated under the provisions of §15.211, §15.213, §15.217, §15.219, or §15.221. Further, this requirement does not apply to intentional radiators that must be professionally installed, such as perimeter protection systems and some field disturbance sensors, or to other intentional radiators which, in accordance with §15.31(d), must be measured at the installation site. However, the installer shall be responsible for ensuring that the proper antenna is employed so that the limits in this part are not exceeded.

### 5.2. Result

The EUT's antenna used a PCB antenna which is permanently attached, The antenna's gain is 2.2dBi and meets the requirement.

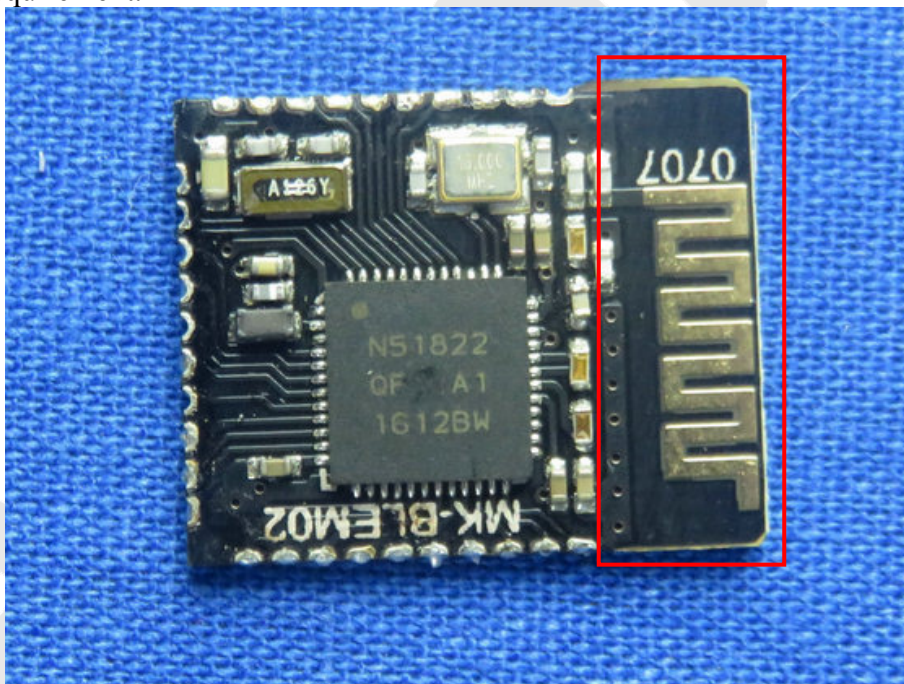

## 6. PHOTOGRAPH

### 6.1 Photo of Conducted Emission Test



### 6.2 Photo of Radiation Emission Test

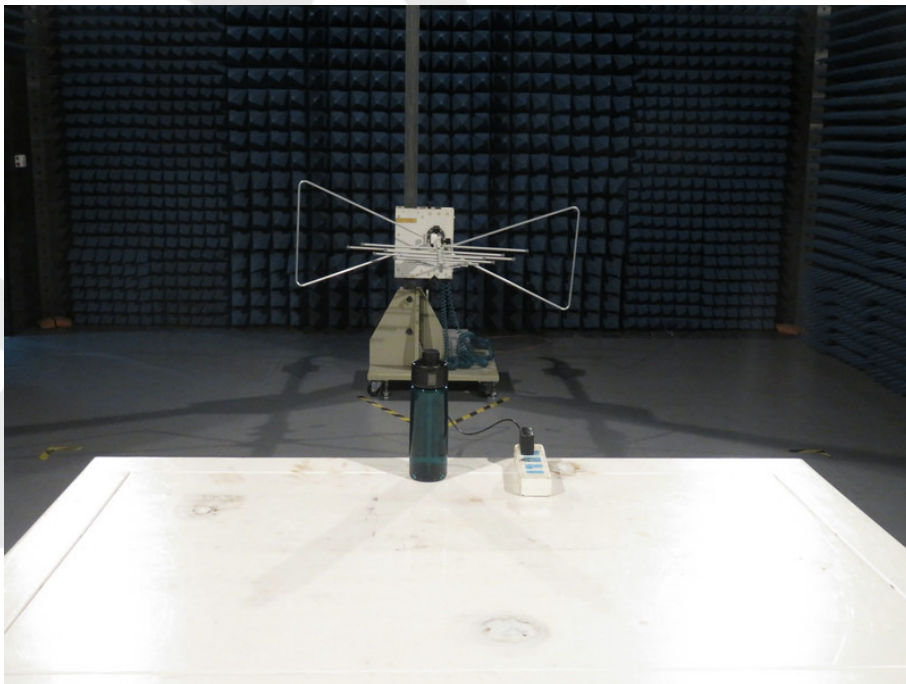

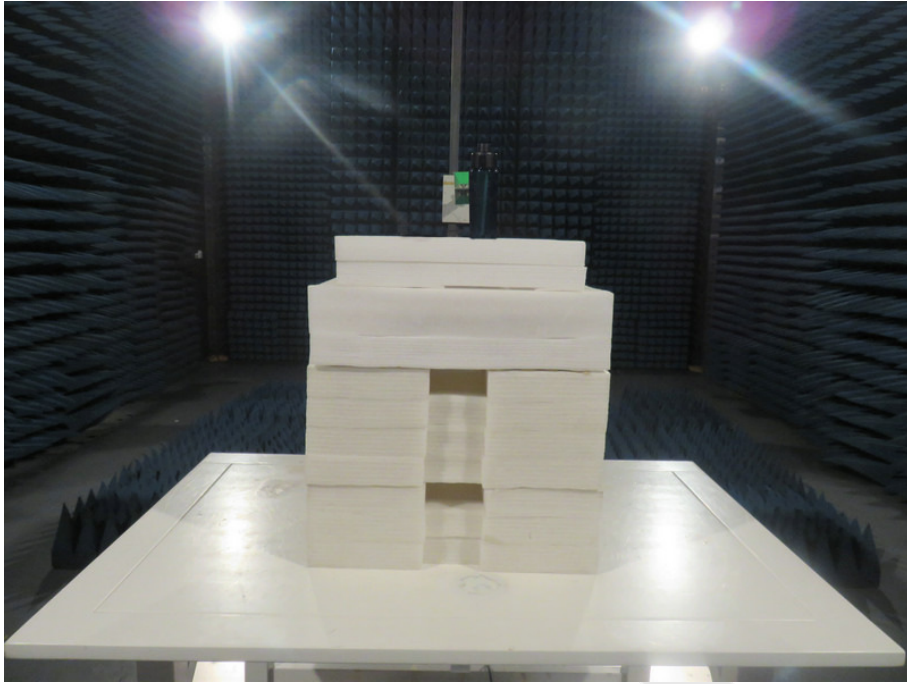

### APPENDIX I (EXTERNAL PHOTOS)

1. Figure



2. Figure



3. Figure



4. Figure



5. Figure



6. Figure

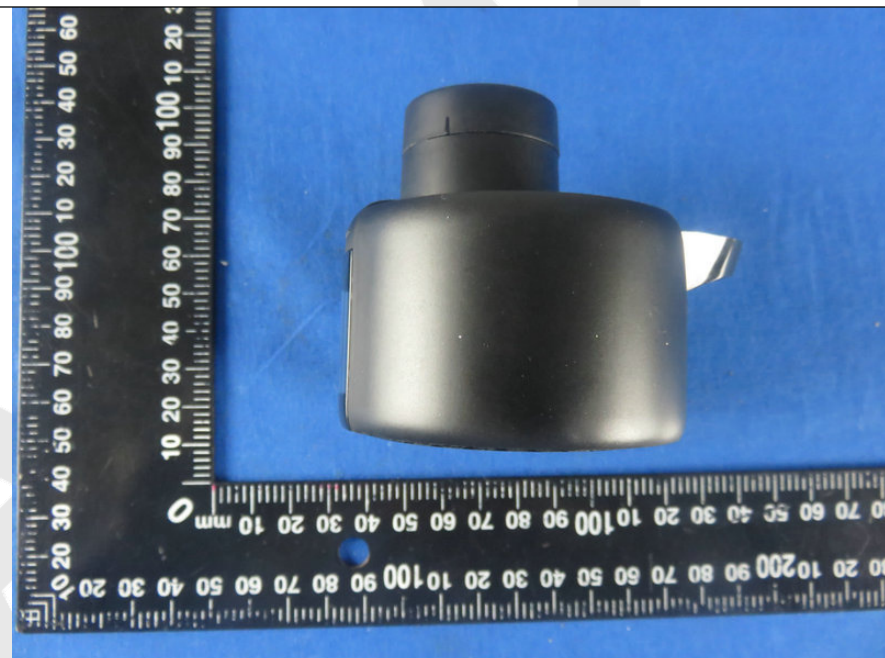

## APPENDIX II (INTERNAL PHOTOS)

1. Figure

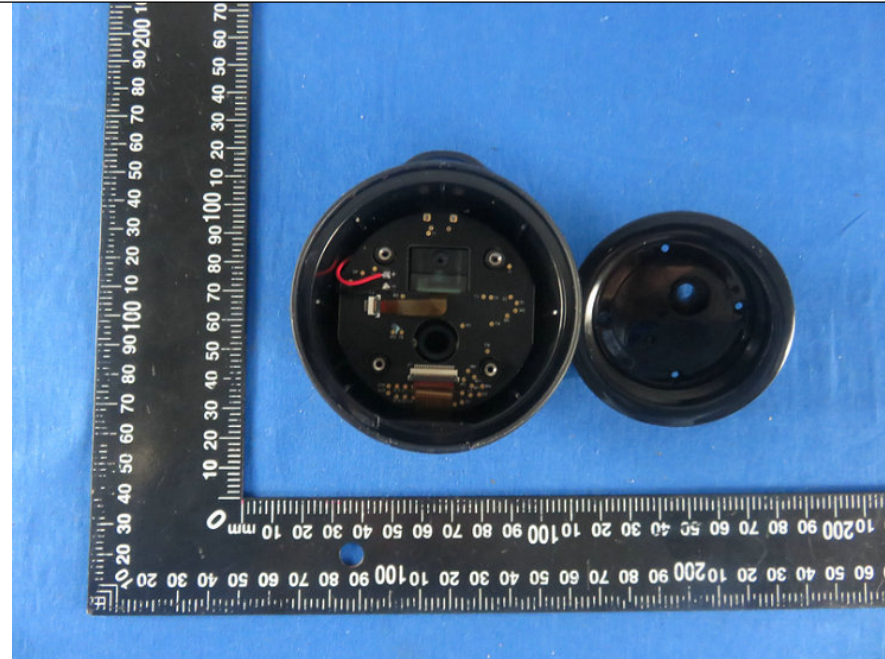

2. Figure

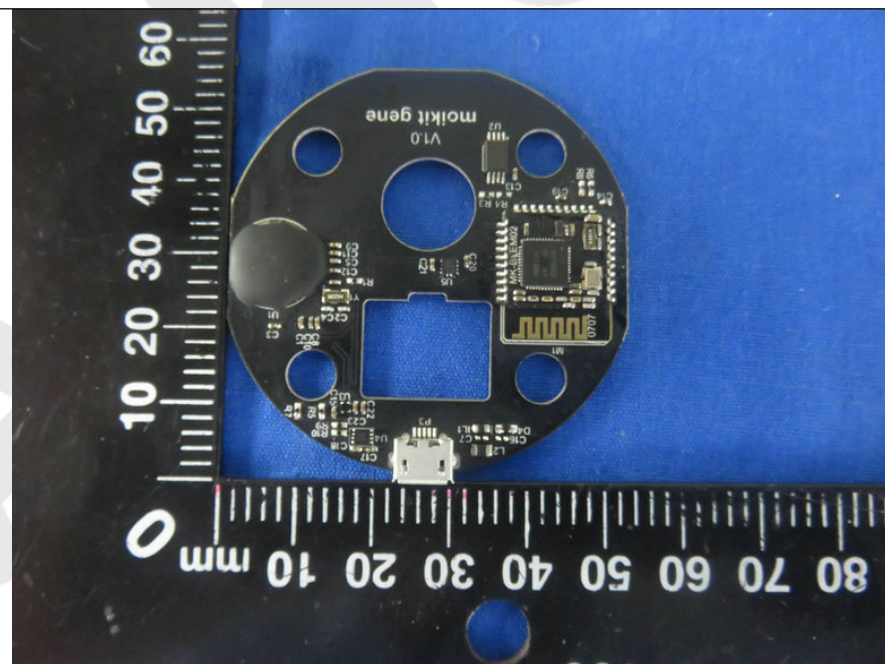

3. Figure

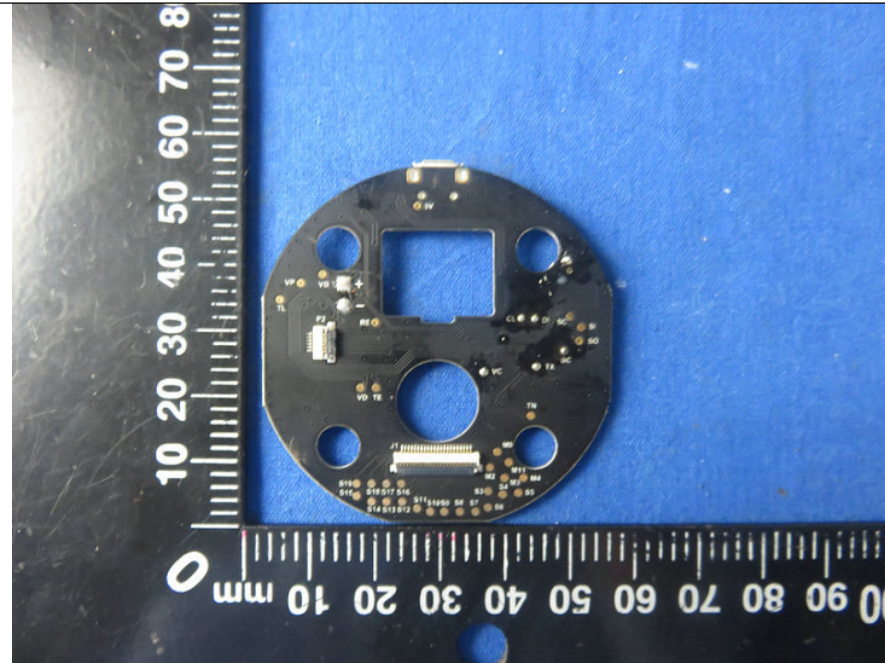

4. Figure

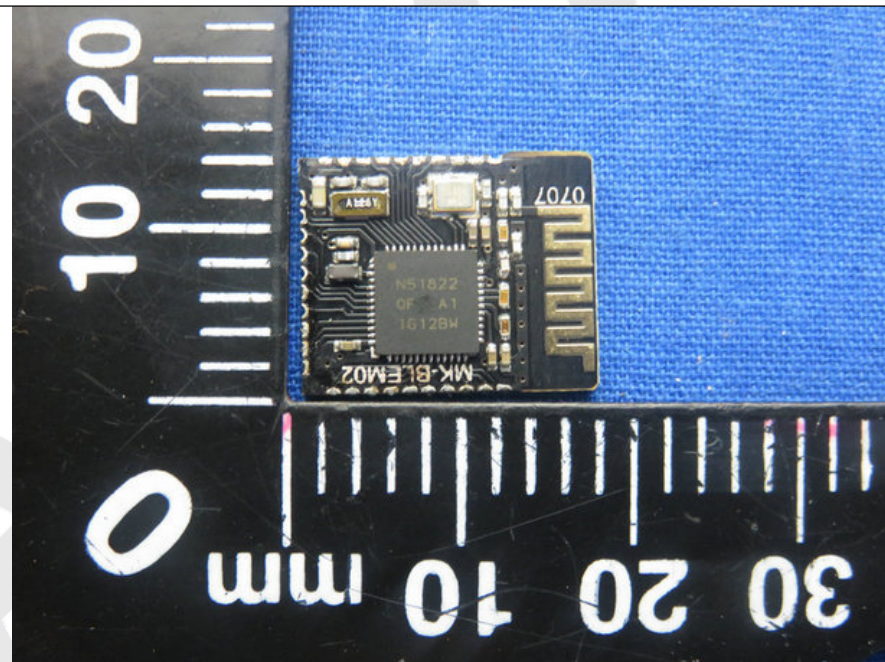

5. Figure

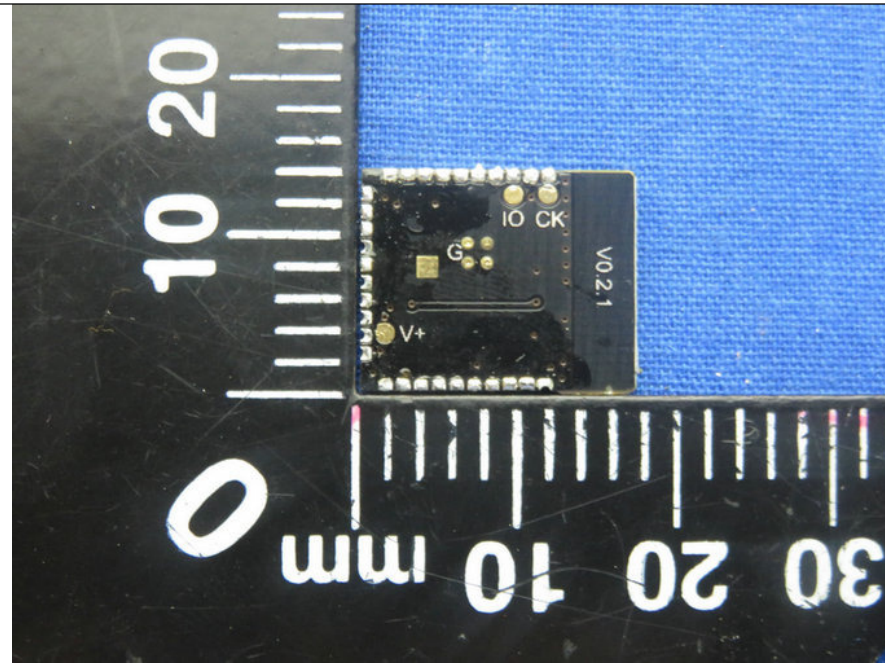

6. Figure

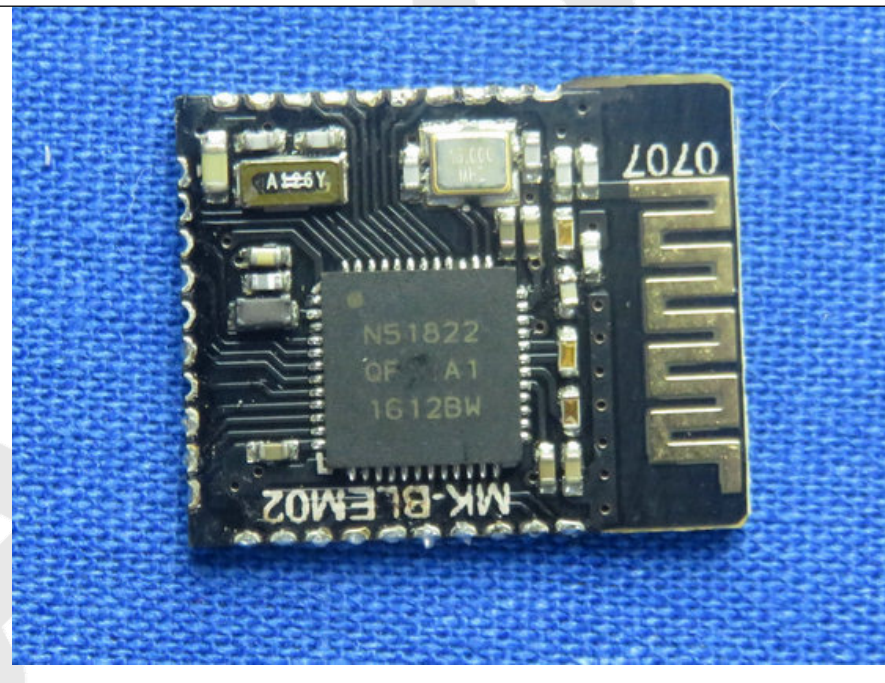

7. Figure

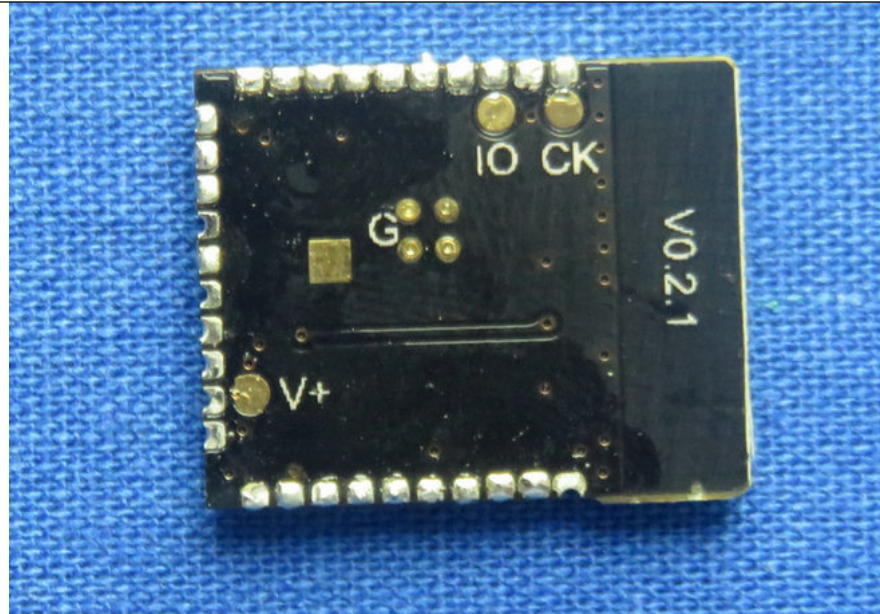

8. Figure

