

Königswinkel 10  
32825 Blomberg, Germany  
Phone: +49 (0) 52 35 / 95 00-0  
Fax: +49 (0) 52 35 / 95 00-10  
office@phoenix-testlab.de  
www.phoenix-testlab.de

# Test Report

Report Number:

**F170923E2**

Equipment under Test (EUT):

B&R radio board with 13.56 MHz RFID and onboard BTLE+WiFi Module  
**RFM-1-BTWNF**

Applicant:

**B&R Industrial Automation GmbH**

Manufacturer:

**B&R Industrial Automation GmbH**



Deutsche  
Akkreditierungsstelle  
D-PL-17186-01-01  
D-PL-17186-01-02  
D-PL-17186-01-03

## References

- [1] **ANSI C63.10-2013**, American National Standard of Procedures for Compliance Testing of Unlicensed Wireless Devices
- [2] **FCC CFR 47 Part 15**, Radio Frequency Devices
- [3] **RSS-247 Issue 2 (February 2017)**, Digital Transmission Systems (DTSs), Frequency Hopping Systems (FHSs) and Licence-Exempt Local Area Network (LE-LAN) Devices
- [4] **RSS-Gen Issue 4 (November 2014)**, General Requirements for Compliance of Radio Apparatus

## Test Result

The requirements of the tests performed as shown in the overview (clause 4) were fulfilled by the equipment under test.

The complete test results are presented in the following.

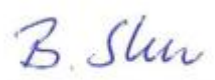
Test engineer:	<u>Bernward ROHDE</u> Name	<u></u> Signature	<u>10.10.2017</u> Date
Authorized reviewer:	<u>Bernd STEINER</u> Name	<u></u> Signature	<u>10.10.2017</u> Date

**This test report is only valid in its original form.**

Any reproduction of its contents in extracts without written permission of the accredited test laboratory PHOENIX TESTLAB GmbH is prohibited.

The test results herein refer only to the tested sample. PHOENIX TESTLAB GmbH is not responsible for any generalizations or conclusions drawn from these test results concerning further samples. Any modification of the tested samples is prohibited and leads to the invalidity of this test report. Each page necessarily contains the PHOENIX TESTLAB Logo and the TEST REPORT NUMBER.

This test report is valid in hardcopy form as well as in electronic form.

<b>Contents</b>	<b>Page</b>
1 Identification.....	4
1.1 Applicant.....	4
1.2 Manufacturer.....	4
1.3 Test Laboratory.....	4
1.4 EUT (Equipment Under Test) .....	5
1.5 Technical Data of Equipment.....	6
1.6 Dates .....	7
2 Operational States .....	7
3 Additional Information .....	8
4 Overview.....	8
5 Results.....	9
5.1 Duty cycle .....	9
5.2 Maximum peak output power.....	9
5.3 DTS Bandwidth / 99% Bandwidth .....	12
5.3.1 Method of measurement .....	12
5.3.2 Test result.....	13
5.4 Band-edge compliance.....	17
5.4.1 Method of measurement (band edges next to unrestricted bands (radiated)) .....	17
5.4.2 Test result (band edges next to unrestricted bands (radiated)).....	18
5.4.3 Method of measurement (band edges next to restricted bands (radiated)).....	19
5.4.4 Test result (band edges next to restricted bands (radiated)) .....	19
5.5 Maximum unwanted emissions.....	20
5.5.1 Method of measurement (radiated emissions) .....	20
5.5.2 Test results (radiated emissions) .....	27
6 Test equipment and ancillaries used for tests .....	33
7 Report History.....	34
8 List of Annexes .....	34

# 1 Identification

## 1.1 Applicant

Name:	B&R Industrial Automation GmbH
Address:	B&R Straße 1 5142 Eggelsberg
Country:	Austria
Name for contact purposes:	Bernhard Falch
Phone:	+43 7748 6586 1323
Fax:	+43 7748 6586 26
eMail Address:	Bernhard.falch@br-automation.com
Applicant represented during the test by the following person:	none

## 1.2 Manufacturer

Name:	B&R Industrial Automation GmbH
Address:	B&R Straße 1 5142 Eggelsberg
Country:	Austria
Name for contact purposes:	Bernhard Falch
Phone:	+43 7748 6586 1323
Fax:	+43 7748 6586 26
eMail Address:	Bernhard.falch@br-automation.com
Applicant represented during the test by the following person:	none

## 1.3 Test Laboratory

The tests were carried out by: **PHOENIX TESTLAB GmbH**  
**Königswinkel 10**  
**32825 Blomberg**  
**Germany**

accredited by Deutsche Akkreditierungsstelle GmbH (DAkkS) in compliance with DIN EN ISO/IEC 17025 under Reg. No. D-PL-17186-01-02, FCC Test Firm Accreditation with the registration number 469623, designation number DE0004 and Industry Canada Test site registration SITE# IC3469A-1.

## 1.4 EUT (Equipment Under Test)

Test object: *	B&R radio board with 13.56 MHz RFID and onboard BTLE+WiFi Module
Type / PMN: *	RFM-1-BTWNF
FCC ID: *	2ADFV-RFM-1-BTWNF
IC Certification Number: *	1244A-RFM1BTWNF
Serial number: *	Engineering sample
PCB identifier: *	WIFI-BT-NFC
MAC Address:*	5C-F3-70-41-6D-92
HVIN (Hardware Version Identification Number): *	RFM-1-BTWNF
FVIN (Firmware Version Identification Number): *	v1.0

\* As declared by the applicant

BT LE frequencies:				
Channel 00	RX:	2402 MHz	TX:	2402 MHz
Channel 19	RX:	2440 MHz	TX:	2440 MHz
Channel 39	RX:	2480 MHz	TX:	2480 MHz

## 1.5 Technical Data of Equipment

Fulfills specifications: *	Bluetooth 4.0 Low Energy only					
Antenna type: *	onboard chip antenna					
Antenna gain: *	0.5 dBi					
Antenna connector: *	none					
Power supply - EUT	U <sub>nom</sub> =	5.0 V DC	U <sub>min</sub> =	4.75 V DC	U <sub>max</sub> =	5.25 V DC
Type of modulation: *	GFSK					
Operating frequency range:*	2402 – 2480 MHz					
Number of channels: *	40					
Temperature range: *	0 °C to +75 °C					
Lowest / highest Internal clock frequency: *	13.56 MHz / 2.480GHz					

\* Declared by the applicant

Ancillary devices:	
Industrial PC: *	BRaccessoryPC1a

\* Provided by the applicant

### The following external I/O cables were used:

Identification	Connector		Length
	EUT	Ancillary	
System connector (DC and data lines USB used)	Mini plug	USB	2.5 m

\*: Length during the test if no other specified.

## 1.6 Dates

Date of receipt of test sample:	07.07.2017
Start of test:	18.07.2017
End of test:	31.08.2017

Physical Boundaries of the EUT:

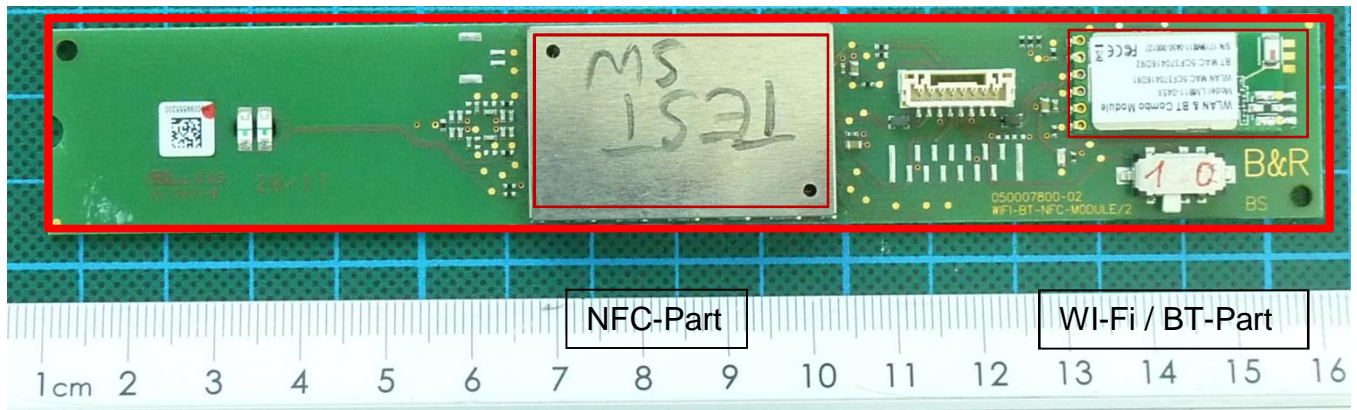

## 2 Operational States

The EUT is radio module that incorporates a 13.56 MHz RFID and an additional already FCC/IC certified Bluetooth Low Energy&WiFi Module.

During the Bluetooth Low Energy radio tests the RFID module was active and continuously transmitting (reading tag). So both transmitters were operating simultaneously.

The test modes were set via an ancillary industrial computer provided by the applicant. The test modes were set by using a test-software called "RTK\_BT\_MP 8723BU" as used for the Realtech RTL8723B chip as provided by the applicant.

The default power settings of the module were applied.

All tests were done with an unmodified sample.

Operation mode	Description of the operation mode	Mode	Channel	Modulation	Data rate / Mbps
1	Continuous transmitting on 2402 MHz	BTLE	0	GFSK	1 Mbps
2	Continuous transmitting on 2440 MHz	BTLE	19	GFSK	1 Mbps
3	Continuous transmitting on 2480 MHz	BTLE	39	GFSK	1 Mbps

### 3 Additional Information

The combo Bluetooth Low Energy&WiFi module is tested and certified for stand-alone configuration only. This test report covers only the additional measurements to show compliance with the regulations for simultaneous transmission with the 13.56 MHz RFID transmitter

### 4 Overview

Application	Frequency range [MHz]	FCC 47 CFR Part 15 section [2]	RSS-247 [3] or RSS-Gen, Issue 4 [4]	Status	Refer page
Maximum Peak Output Power	2400.0 - 2483.5	15.247 (b) (3), (4)	5.4 (2) [3]	Passed	9 et seq
DTS Bandwidth	2400.0 - 2483.5	15.247 (a) (2)	5.2 (1) [3]	Passed	9 et seq
Band edge compliance	2400.0 - 2483.5	15.247 (d)	5.5 [3] 8.9 [4], 8.10 [4]	Passed	17 et seq.
Radiated emissions (transmitter)	0.009 – 26,500	15.247 (d) 15.205 (a) 15.209 (a)	5.5 [3] 8.9 [4], 8.10 [4]	Passed	20 et seq.



## 5 Results

### 5.1 Duty cycle

The Bluetooth Low Energy module was set to test-mode with 100% duty cycle; therefore a duty cycle calculation is not applicable.

### 5.2 Maximum peak output power

No sample with an antenna connector was delivered, so the antenna gain information from the original test-report Report No.: STR170482171-1 was used.

Antenna Gain = 0.5 dBi

#### Acceptable measurement configuration

Procedure 11.9.1.1 in [1] was used for the following test.

The following procedure shall be used when an instrument with a resolution bandwidth that is greater than the DTS bandwidth is available to perform the measurement:

- a) Set the RBW  $\geq$  DTS bandwidth.
- b) Set VBW  $\geq$  [3  $\times$  RBW].
- c) Set span  $\geq$  [3  $\times$  RBW].
- d) Sweep time = auto couple.
- e) Detector = peak.
- f) Trace mode = max hold.
- g) Allow trace to fully stabilize.
- h) Use peak marker function to determine the peak amplitude level.

The measurement was performed at the lower end of the assigned frequency band.

The measured Electric field strength was corrected with the following correction factor:

Antenna Factor [dB] + Cable Attenuation [dB] - Amplifier Gain [dB] = correction factor [dB]

The formula in 11.12.2.2 e) in [1] was used to calculate the EIRP power:

$$E = EIRP - 20\log(d) + 104.8$$

$$EIRP = E - 95.3$$

$$MPOP = EIRP - G$$

$E$  is the electric field strength in dB $\mu$ V/m

$EIRP$  is the equivalent isotropically radiated power in dBm

$d$  is the specified measurement distance in m

$G$  is the antenna gain in dBi

$MPOP$  is the maximum peak output power – measured antenna port conducted – in dBm

**Result:** radiated measurement on sample with integral antenna

MPOP\_ch00.PNG: Maximum peak output power measured on channel 00 (operation mode 1):

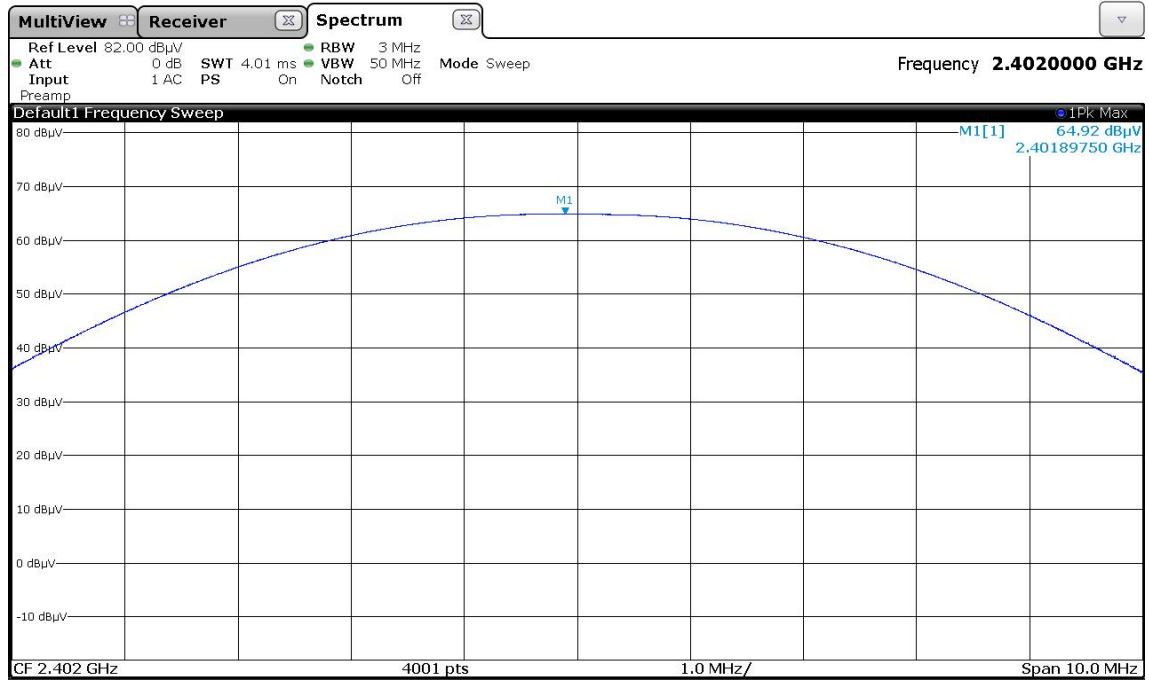

MPOP\_ch19.PNG: Maximum peak output power measured on channel 19 (operation mode 2):

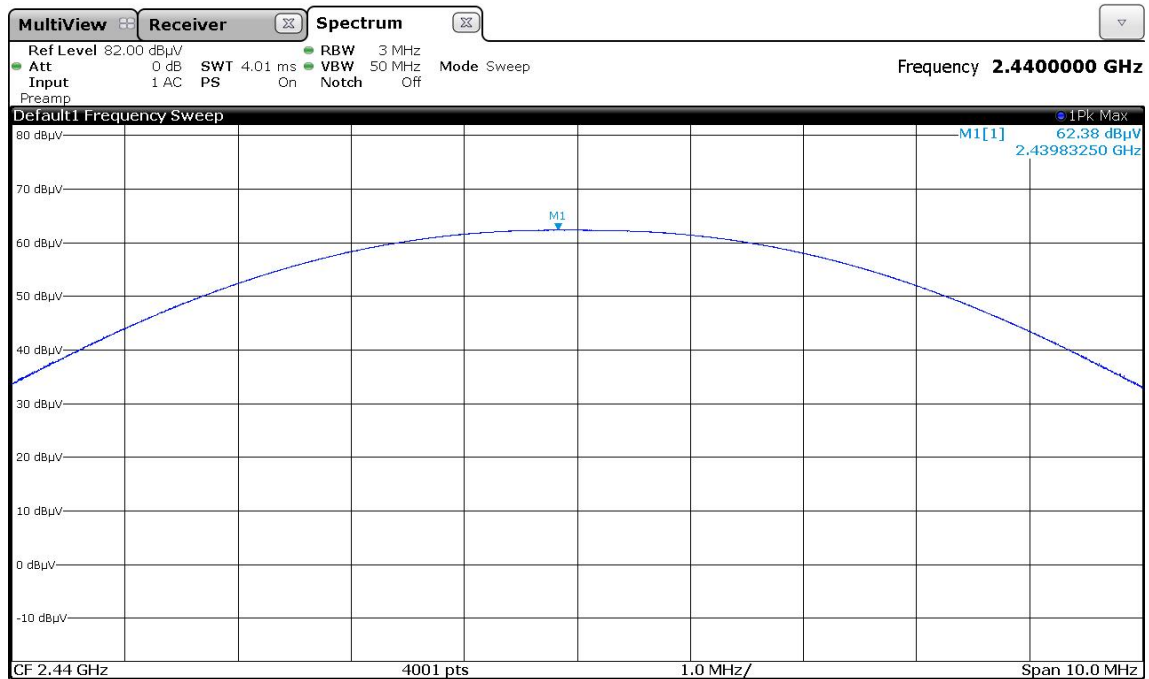

MPOP\_ch39.PNG: Maximum peak output power measured on channel 39 (operation mode 3):

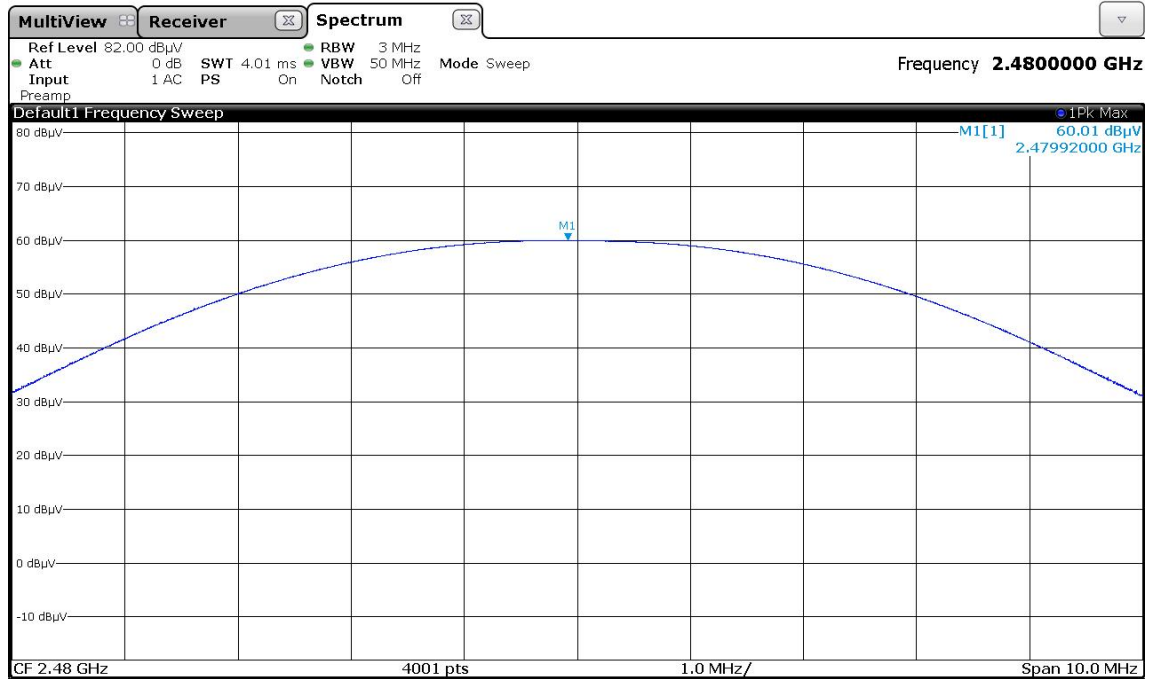

Operation mode	Frequency [MHz]	Reading [dBmV]	Corr. Fact. [dB]	Field Strength @ 3m [dBmV]	EIRP [dBm]	Maximum peak conducted output power* [dBm]	Limit [dBm]
1	2402	64.9	34.1	99.0	3.7	3.2	30
2	2440	62.4	34.1	96.5	1.2	0.7	30
3	2480	60.0	34.2	94.1	-1.2	-1.7	30

\* calculated as EIRP – Antenna Gain

Test: Passed

TEST EQUIPMENT USED FOR THE TEST:

1- 9

## 5.3 DTS Bandwidth / 99% Bandwidth

### 5.3.1 Method of measurement

For the DTS bandwidth measurement, the EUT was measured radiated in the anechoic chamber using the procedures described in 5.5.1.

For the 99 % Bandwidth the EUT was measured with the aid of a loop antenna.

#### Acceptable measurement configurations

The measurement for the DTS bandwidth procedure refers to part 11.8.1 of document [1].

- Set RBW = 100 kHz.
- Set the video bandwidth (VBW)  $\geq 3 \times$  RBW.
- Detector = Peak.
- Trace mode = max hold.
- Sweep = auto couple.
- Allow the trace to stabilize.
- Measure the maximum width of the emission that is constrained by the frequencies associated with the two outermost amplitude points (upper and lower frequencies) that are attenuated by 6 dB relative to the maximum level measured in the fundamental emission.

The following procedure was used for measuring the 99 % bandwidth:

The occupied bandwidth is the frequency bandwidth such that, below its lower and above its upper frequency limits, the mean powers are each equal to 0.5% of the total mean power of the given emission. The following procedure shall be used for measuring 99% power bandwidth:

- The instrument center frequency is set to the nominal EUT channel center frequency. The frequency span for the spectrum analyzer shall be between 1.5 times and 5.0 times the OBW.
- The nominal IF filter bandwidth (3 dB RBW) shall be in the range of 1% to 5% of the OBW, and VBW shall be approximately three times the RBW, unless otherwise specified by the applicable requirement.
- Set the reference level of the instrument as required, keeping the signal from exceeding the maximum input mixer level for linear operation. In general, the peak of the spectral envelope shall be more than  $[10 \log (\text{OBW}/\text{RBW})]$  below the reference level. Specific guidance is given in 4.1.5.2.
- Step a) through step c) might require iteration to adjust within the specified range.
- e) Video averaging is not permitted. Where practical, a sample detection and single sweep mode shall be used. Otherwise, peak detection and max hold mode (until the trace stabilizes) shall be used.
- f) Use the 99% power bandwidth function of the instrument (if available) and report the measured bandwidth.
- g) If the instrument does not have a 99% power bandwidth function, then the trace data points are recovered and directly summed in linear power terms. The recovered amplitude data points, beginning at the lowest frequency, are placed in a running sum until 0.5% of the total is reached; that frequency is recorded as the lower frequency. The process is repeated until 99.5% of the total is reached; that frequency is recorded as the upper frequency. The 99% power bandwidth is the difference between these two frequencies.
- The occupied bandwidth shall be reported by providing plot(s) of the measuring instrument display; the plot axes and the scale units per division shall be clearly labeled. Tabular data maybe reported in addition to the plot(s).

Since this is only a relative measurement, no measurement level correction was performed.

### 5.3.2 Test result

Ambient temperature	22 °C
---------------------	-------

Relative humidity	59 %
-------------------	------

The plots show the results for the worst case.

DTS\_BW\_ch00.wmf: 6-dB Bandwidth (operation mode 1):

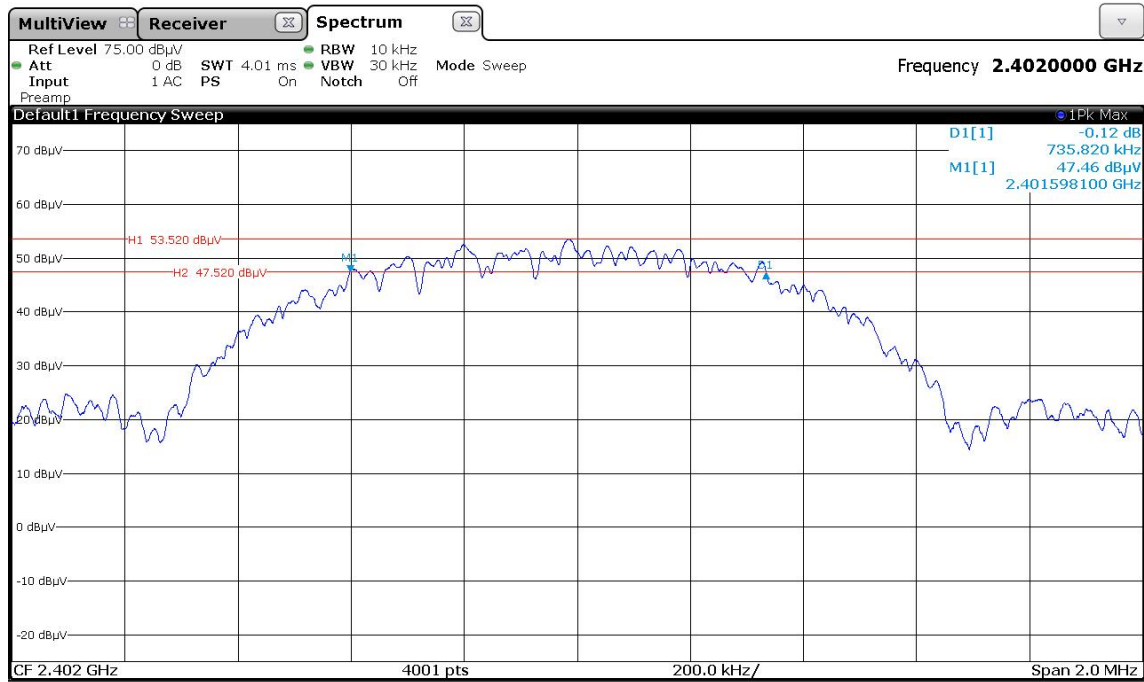

99%\_BW\_ch00.png: 99% Bandwidth (operation mode 1):

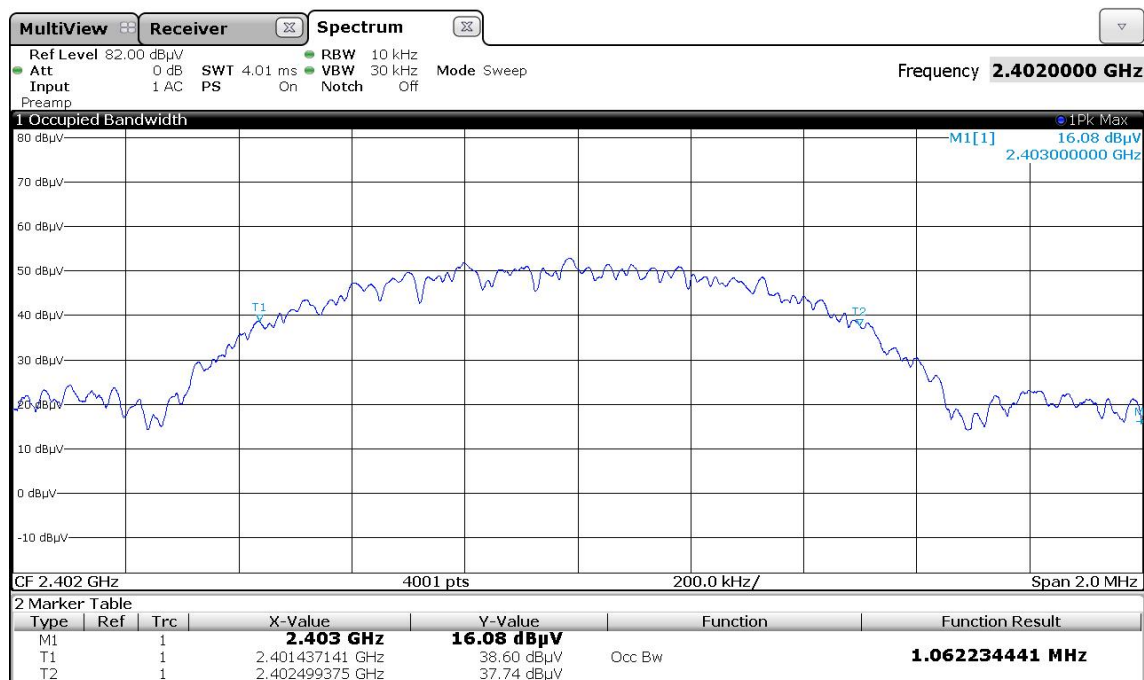

DTS BW ch19.wmf: 6-dB Bandwidth (operation mode 2):

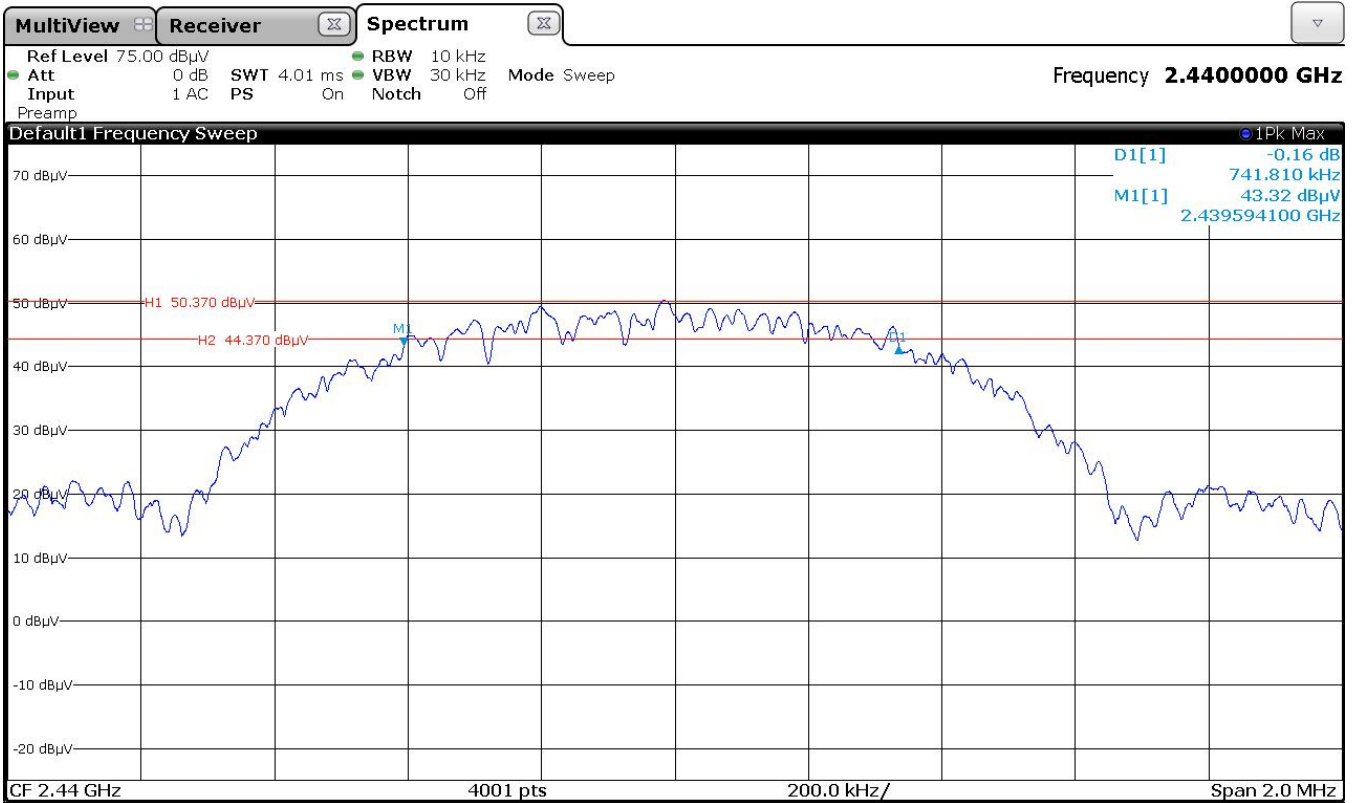

99% BW ch19.png: 99% Bandwidth (operation mode 2):

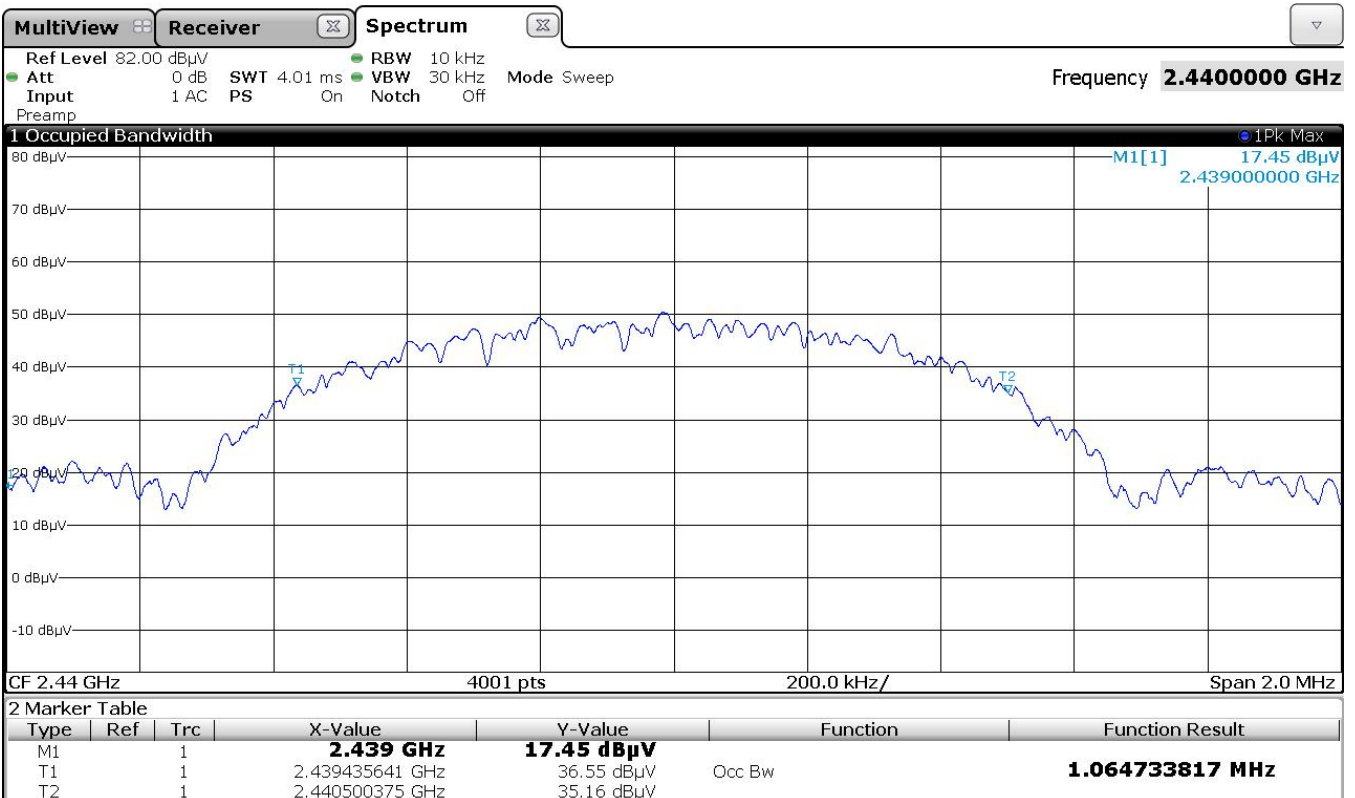

DTS BW ch39.wmf: 6-dB Bandwidth (operation mode 3):

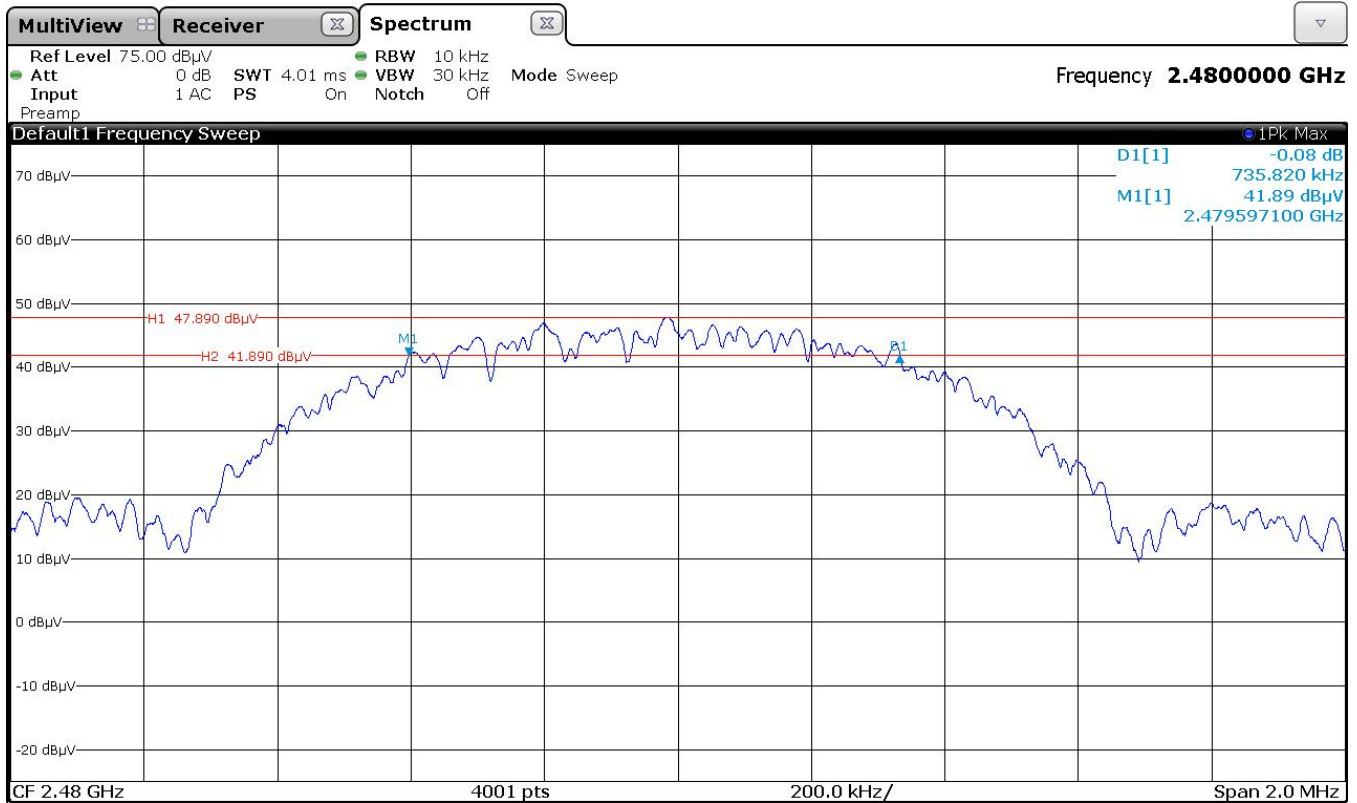

99% BW ch39.png: 99% Bandwidth (operation mode 3):

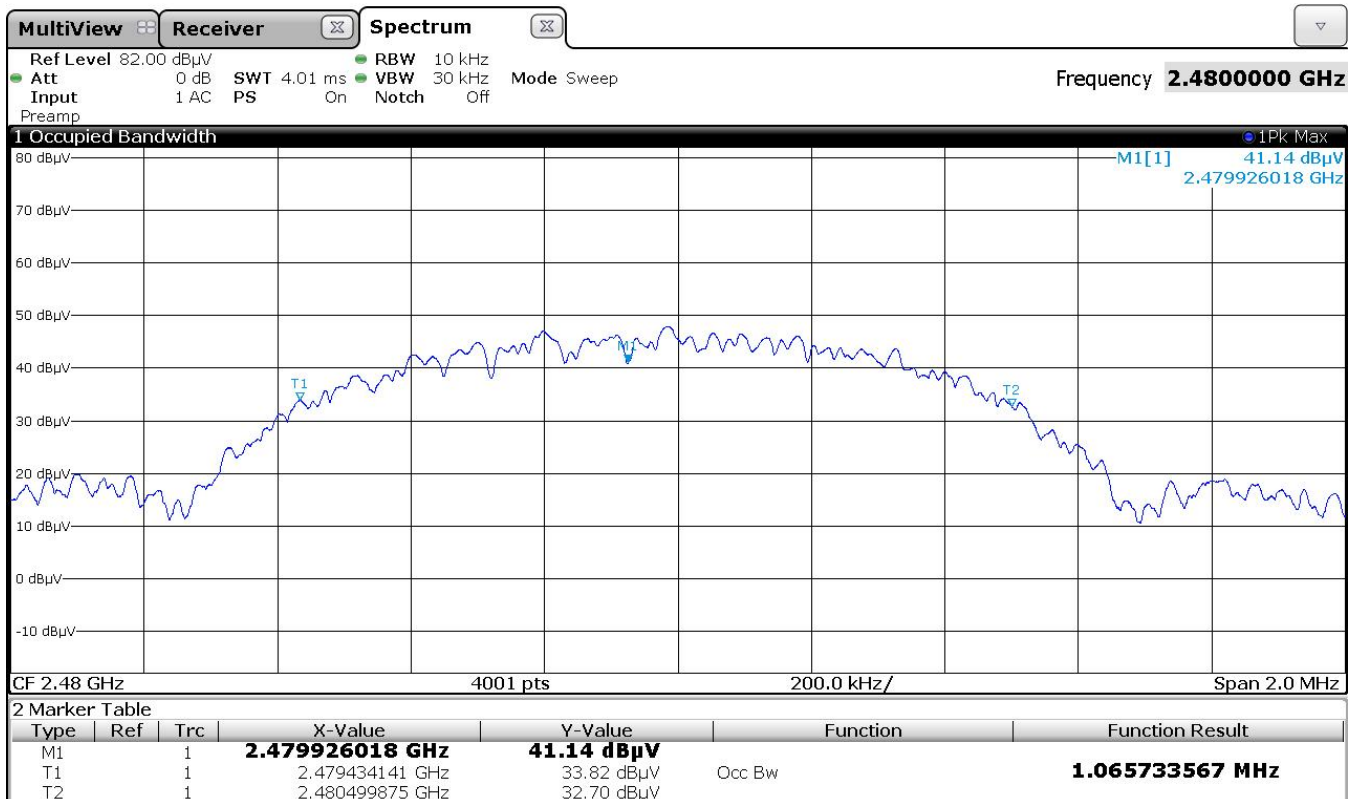

Operation Mode	Center Frequency [MHz]	Minimum 6-dB Bandwidth Limit [MHz]	6 dB Bandwidth [MHz]	99 % Bandwidth [MHz]	Result
1	2402	0.5	0.735	1.062	Passed
2	2440	0.5	0.742	1.065	Passed
3	2480	0.5	0.736	1.066	Passed

Test: Passed

TEST EQUIPMENT USED FOR THE TEST:

1- 9



## 5.4 Band-edge compliance

### 5.4.1 Method of measurement (band edges next to unrestricted bands (radiated))

The EUT was measured radiated in the anechoic chamber using the procedures described in 5.5.1.

#### Acceptable measurement configurations

The measurement procedure refers to part 11.11.2 and 11.11.3 of document [1].

Measurement Procedure Reference – Reference Level:

- Set instrument center frequency to DTS channel center frequency.
- Set the span to  $\geq 1.5$  times the DTS bandwidth.
- RBW = 100 kHz.
- VBW  $\geq 300$  kHz.
- Set the span to  $\geq 1.5$  times the DTS Bandwidth.
- Detector = Peak.
- Sweep time = auto couple.
- Trace mode = max hold.
- Allow trace to fully stabilize.
- Use the peak marker function to determine the maximum PSD level.

Measurement Procedure – Unwanted Emissions

- Set the center frequency and span to encompass the frequency range to be measured.
- RBW = 100 kHz.
- VBW  $\geq 300$  kHz.
- Detector = Peak.
- Ensure that the number of measurement points  $\geq \text{span}/\text{RBW}$ .
- Sweep time = auto couple.
- Trace Mode = max hold.
- Allow the trace to stabilize.
- Use the peak marker function to determine the maximum amplitude level.

The measurement procedure at the band edges was simplified by performing the measurement in just one plot. Both, the in-band-emission and the unwanted emission were be encompassed by the span. After trace stabilization, the maximum peak was be determined by a peak detector and the value was marked by an appropriate limit line. The second limit line, which is 20 dB below the first, marks the limit for the emissions in the unrestricted band. A maximum-peak-detector marks the highest emission in the unrestricted band next to the band edge.

The measurements were performed at the lower end of the 2.4 GHz band.

### 5.4.2 Test result (band edges next to unrestricted bands (radiated))

LowerBandEdge\_ch0.wmf: radiated band-edge compliance at an unrestricted band-edge (operation mode 1):

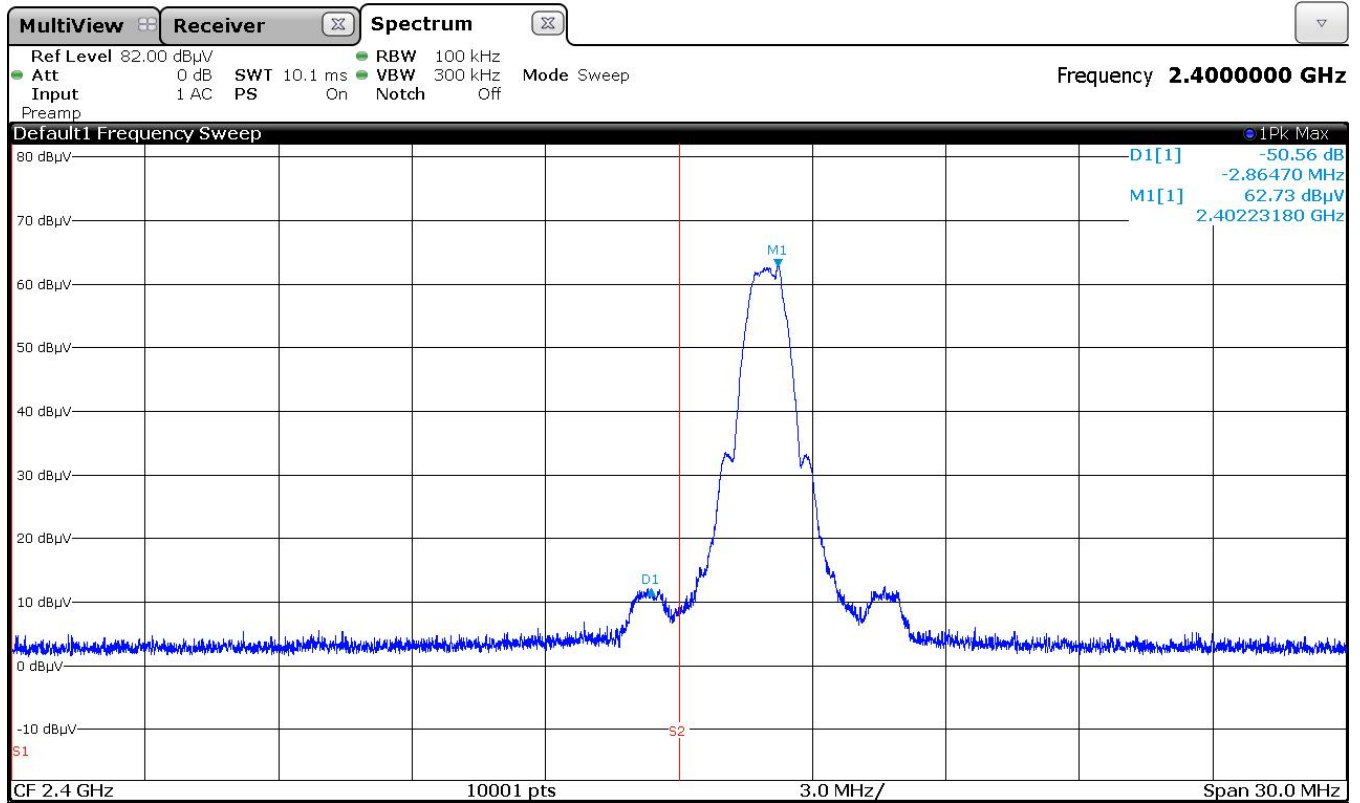

Operation Mode	Tx Frequency [MHz]	Emission Frequency [MHz]	Reference Level [dBµV/m]	Limit [dBµV/m]	Emission Level [dBµV/m]	Margin [dB]	Result
1	2402	2399.367	62.73	42.73	12.17	30.56	Passed

Test: Passed

TEST EQUIPMENT USED FOR THE TEST:

1- 9, 24

### 5.4.3 Method of measurement (band edges next to restricted bands (radiated))

The EUT was measured radiated in the anechoic chamber using the procedures described in 5.5.1.

#### Acceptable measurement configurations

The same measurement configurations as described in 5.5.1. were used for the preview and final measurement.

### 5.4.4 Test result (band edges next to restricted bands (radiated))

UpperBandEdge\_ch39.wmf: radiated band-edge compliance at a restricted band-edge (operation mode 3):

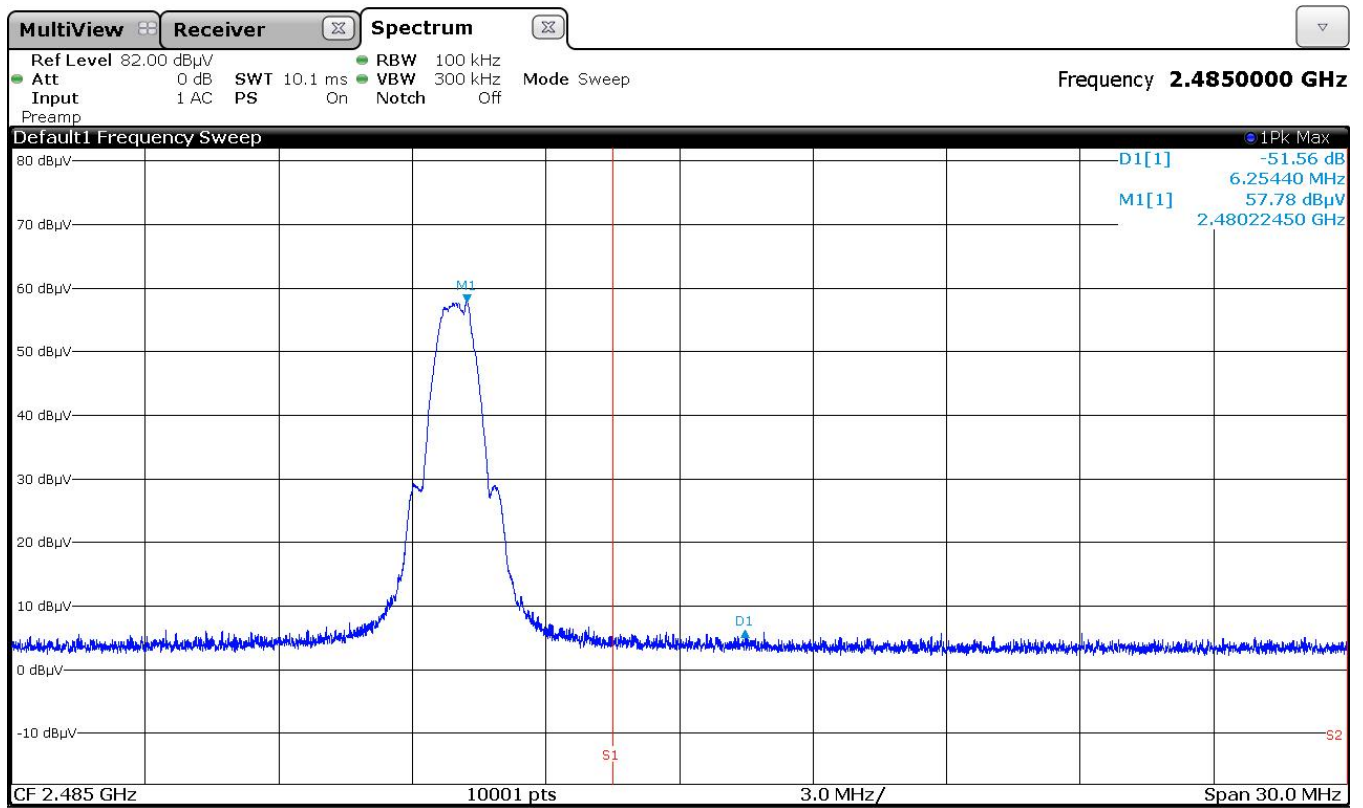

No emissions were found during the preliminary measurement; therefore no final measurement was performed.

Test: Passed

TEST EQUIPMENT USED FOR THE TEST:

1- 9, 24

## 5.5 Maximum unwanted emissions

### 5.5.1 Method of measurement (radiated emissions)

The radiated emission measurement is subdivided into five stages.

- A preliminary measurement carried out in a fully anechoic chamber with a fixed antenna height in the frequency range 9 kHz to 1 GHz.
- A final measurement carried out on an outdoor test site without reflecting ground plane and a fixed antenna height in the frequency range 9 kHz to 30 MHz.
- A final measurement carried out on an open area test site with reflecting ground plane and various antenna height in the frequency range 30 MHz to 1 GHz.
- A preliminary measurement carried out in a fully anechoic chamber with a variable antenna distance and height in the frequency range above 1 GHz.
- A final measurement carried out in a fully anechoic chamber with a fixed antenna height in the frequency range above 1 GHz.

#### **Preliminary measurement (9 kHz to 30 MHz):**

In the first stage a preliminary measurement will be performed in a shielded room with a measuring distance of 3 meters. Table top devices will set up on a non-conducting turn device on the height of 1.5m. Floor-standing devices will be placed directly on the turntable/ground plane. The set-up of the Equipment under test will be in accordance to [1].

The frequency range 9 kHz to 30 MHz will be monitored with a spectrum analyzer while the system and its cables will be manipulated to find out the configuration with the maximum emission levels if applicable. The EMI Receiver will be set to MAX Hold mode. The EUT and the measuring antenna will be rotated around their vertical axis to found the maximum emissions.

The resolution bandwidth of the spectrum analyzer will be set to the following values:

Frequency range	Resolution bandwidth
9 kHz to 150 kHz	200 Hz
150 kHz to 30 MHz	10 kHz

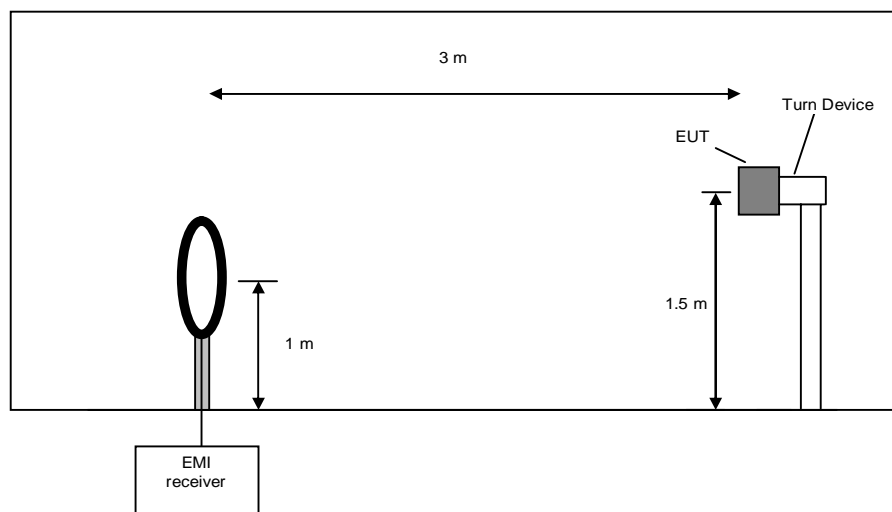

Preliminary measurement procedure:

Prescans were performed in the frequency range 9 kHz to 150 kHz and 150 kHz to 30 MHz.

Prescans were performed in the frequency range 30 MHz to 230 MHz and 230 MHz to 1 GHz.

The following procedure will be used:

1. Monitor the frequency range at horizontal polarization and a EUT azimuth of 0 °.
2. Manipulate the system cables within the range to produce the maximum level of emission.
3. Rotate the EUT by 360 ° to maximize the detected signals.
4. Repeat 1) to 3) with the vertical polarization of the measuring antenna.
5. Make a hardcopy of the spectrum.
6. Repeat 1) to 5) with the EUT raised by an angle of 0° (45°, 90°) according to 6.6.5.4 in [1].
7. Measure the frequency of the detected emissions with a lower span and resolution bandwidth to increase the accuracy and note the frequency value.

**Final measurement (9 kHz to 30 MHz):**

In the second stage a final measurement will be performed on an open area test site with no conducting ground plane in a measuring distances of 3 m, 10 m and 30 m. In the case where larger measuring distances are required the results will be extrapolated based on the values measured on the closer distances according to Section 15.31 (f) (2) [2]. The final measurement will be performed with a EMI Receiver set to Quasi Peak detector except for the frequency bands 9 kHz to 90 kHz and 110 kHz to 490 kHz where an average detector will be used according Section 15.209 (d) [2].

On the frequencies, which were detected during the preliminary measurements, the final measurement will be performed while rotating the EUT and the measuring antenna in the range of 0 ° to 360 ° around their vertical axis until the maximum value is found.

The resolution bandwidth of the EMI Receiver will be set to the following values:

Frequency range	Resolution bandwidth
9 kHz to 150 kHz	200 Hz
150 kHz to 30 MHz	9 kHz

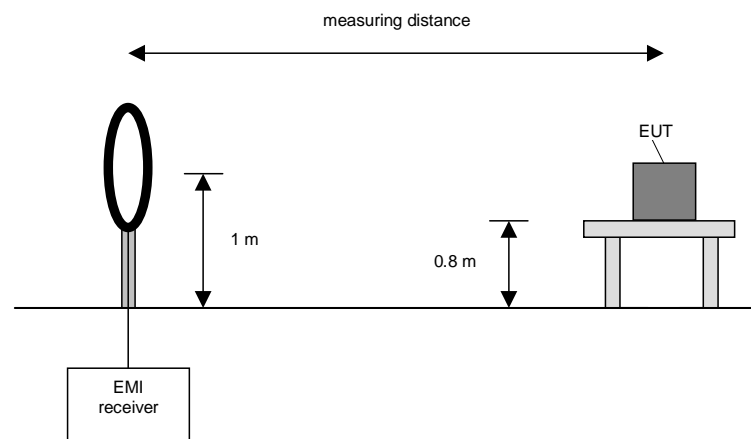

Final measurement procedure:

The following procedure will be used:

- 1) Monitor the frequency range with the measuring antenna at vertical orientation parallel to the EUT at an azimuth of 0 °.
- 2) Rotate the EUT by 360 ° to maximize the detected signals and note the azimuth and orientation.
- 3) Rotate the measuring antenna to find the maximum and note the value.
- 4) Rotate the measuring antenna and repeat steps 1) to 3) until the maximum value is found.
- 5) Repeat steps 1) to 4) with the other orthogonal axes of the EUT (if the EUT is a module and might be used in a handheld equipment application).

**Preliminary measurement (30 MHz to 1 GHz)**

In the first stage a preliminary measurement will be performed in a fully anechoic chamber with a measuring distance of 3 meter. Table top devices will set up on a non-conducting turn device on the height of 1.5m. Floor-standing devices will be placed directly on the turntable/ground plane. The set up of the Equipment under test will be in accordance to [1].

The frequency range 30 MHz to 1 GHz will be measured with an EMI Receiver set to MAX Hold mode and a resolution bandwidth of 100 kHz. The measurement will be performed in horizontal and vertical polarisation of the measuring antenna and while rotating the EUT in its vertical axis in the range of 0 ° to 360 °. This measurement is repeated after raising the EUT in 30° steps according 6.6.5.4 in [1].

The resolution bandwidth of the EMI Receiver will be set to the following values:

Frequency range	Resolution bandwidth
30 MHz to 230 MHz	100 kHz
230 MHz to 1 GHz	100 kHz

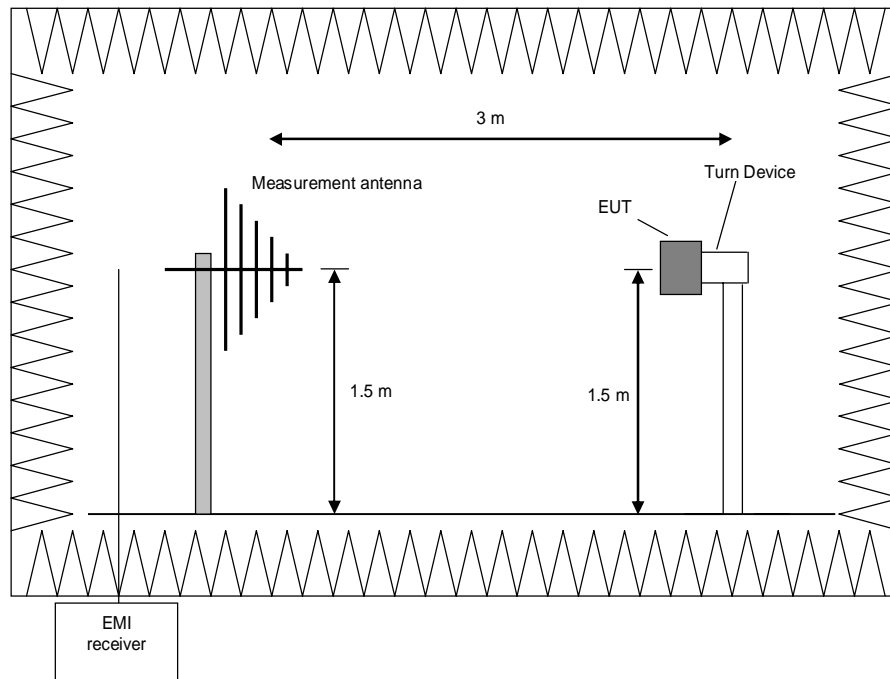

Procedure preliminary measurement:

Prescans were performed in the frequency range 30 MHz to 230 MHz and 230 MHz to 1 GHz.

The following procedure will be used:

8. Monitor the frequency range at horizontal polarization and a EUT azimuth of 0°.
9. Manipulate the system cables within the range to produce the maximum level of emission.
10. Rotate the EUT by 360° to maximize the detected signals.
11. Repeat 1) to 3) with the vertical polarization of the measuring antenna.
12. Make a hardcopy of the spectrum.
13. Repeat 1) to 5) with the EUT raised by an angle of 0° (45°, 90°) according to 6.6.5.4 in [1].
14. Measure the frequency of the detected emissions with a lower span and resolution bandwidth to increase the accuracy and note the frequency value.

**Final measurement (30 MHz to 1 GHz)**

A final measurement on an open area test site will be performed on selected frequencies found in the preliminary measurement. During this test the EUT will be rotated in the range of 0° to 360°, the measuring antenna will be set to horizontal and vertical polarization and raised and lowered in the range from 1 m to 4 m to find the maximum level of emissions.

The resolution bandwidth of the EMI Receiver will be set to the following values:

Frequency range	Resolution bandwidth
30 MHz to 1 GHz	120 kHz

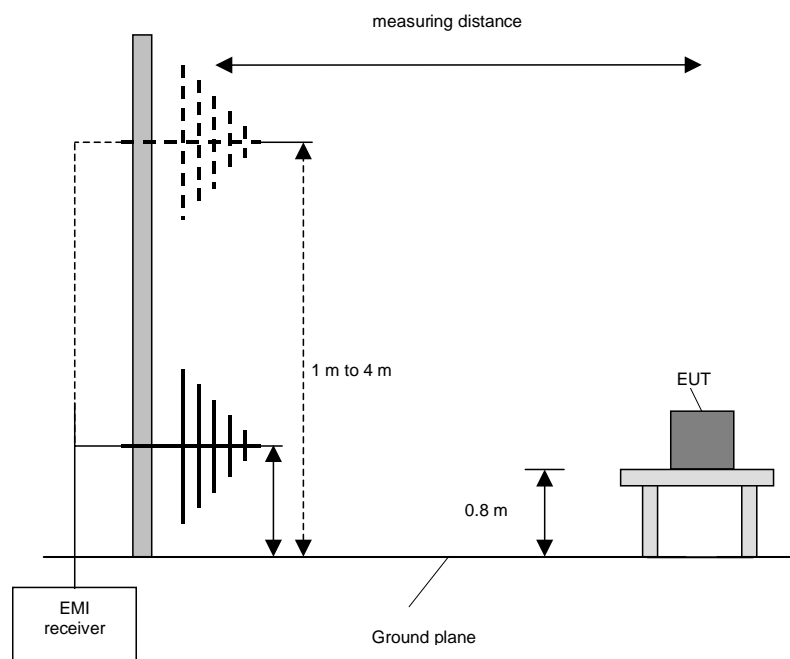

Procedure final measurement:

The following procedure will be used:

- 1) Measure on the selected frequencies at an antenna height of 1 m and a EUT azimuth of 23 °.
- 2) Move the antenna from 1 m to 4 m and note the maximum value at each frequency.
- 3) Rotate the EUT by 45 ° and repeat 2) until an azimuth of 337 ° is reached.
- 4) Repeat 1) to 3) for the other orthogonal antenna polarization.
- 5) Move the antenna and the turntable to the position where the maximum value is detected.
- 6) Measure while moving the antenna slowly +/- 1 m.
- 7) Set the antenna to the position where the maximum value is found.
- 8) Measure while moving the turntable +/- 45 °.
- 9) Set the turntable to the azimuth where the maximum value is found.
- 10) Measure with Final detector (QP and AV) and note the value.
- 11) Repeat 5) to 10) for each frequency.
- 12) Repeat 1) to 11) for each orthogonal axes of the EUT (because of EUT is a module and might be used in a handheld equipment application).

**Preliminary and final measurement (1 GHz to 40 GHz)**

This measurement will be performed in a fully anechoic chamber. Table top devices will set up on a non-conducting turn device on the height of 1.5m. The set-up of the Equipment under test will be in accordance to [1].

**Preliminary measurement (1 GHz to 40 GHz)**

The frequency range will be divided into different sub ranges depending of the frequency range of the used horn antenna. The spectrum analyzer set to MAX Hold mode and a resolution bandwidth of 100 kHz. The measurement will be performed in horizontal and vertical polarization of the measuring antenna and while rotating the EUT in its vertical axis in the range of 0 ° to 360 °. This measurement is repeated after raising the EUT in 30° steps according 6.6.5.4 in [1].

The resolution bandwidth of the EMI Receiver will be set to the following values:

Frequency range	Resolution bandwidth
1 GHz to 4 GHz	100 kHz
4 GHz to 12 GHz	100 kHz
12 GHz to 18 GHz	100 kHz
18 GHz to 25 / 26.5 GHz	100 kHz
26.5 GHz to 40 GHz	100 kHz



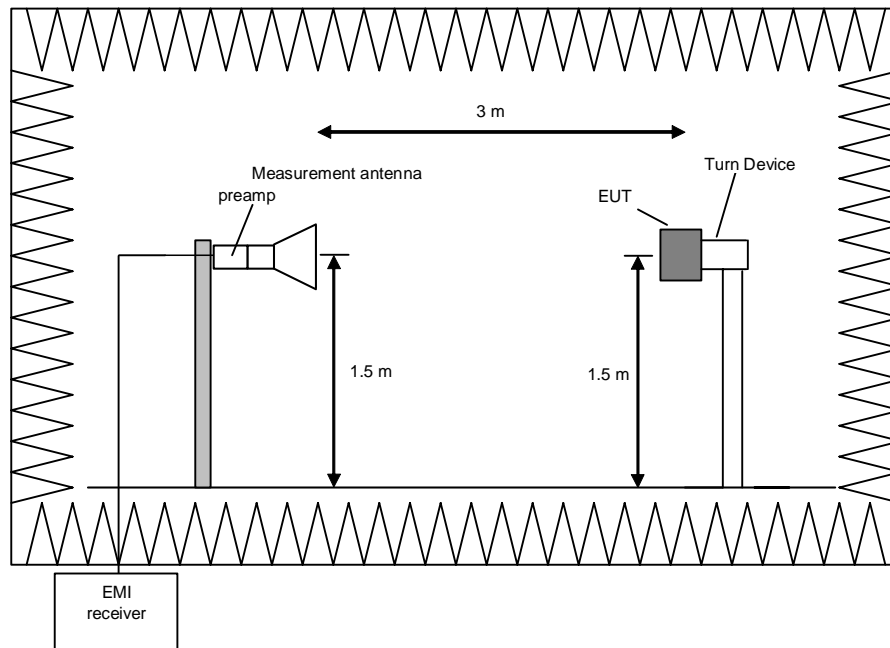

**Procedure preliminary measurement:**

Prescans were performed in the frequency range 1 to 40 GHz. The following procedure will be used:

1. Monitor the frequency range at horizontal polarization and a EUT azimuth of 0 °.
2. Rotate the EUT by 360° to maximize the detected signals.
3. Repeat 1) to 2) with the vertical polarization of the measuring antenna.
4. Make a hardcopy of the spectrum.
5. Repeat 1) to 4) with the EUT raised by an angle of 30° (60°, 90°, 120° and 150°) according to 6.6.5.4 in [1].
6. Measure the frequency of the detected emissions with a lower span and resolution bandwidth to increase the accuracy and note the frequency value.
7. The measurement antenna polarization, with the according EUT position (Turntable and Turn device) which produces the highest emission for each frequency will be used for the final measurement. The six closest values to the applicable limit will be used for the final measurement.

**Final measurement (1 GHz to 40 GHz)**

The frequency range will be divided into different sub ranges depending of the frequency range of the used horn antenna. The EMI Receiver set to peak and average mode and a resolution bandwidth of 1 MHz. The measurement will be performed by rotating the turntable through 0 to 360° in the worst-case EUT orientation which was obtained during the preliminary measurements.

The resolution bandwidth of the EMI Receiver will be set to the following values:

Frequency range	Resolution bandwidth
1 GHz to 4 GHz	1 MHz
4 GHz to 12 GHz	1 MHz
12 GHz to 18 GHz	1 MHz
18 GHz to 25 / 26.5 GHz	1 MHz
26.5 GHz to 40 GHz	1 MHz

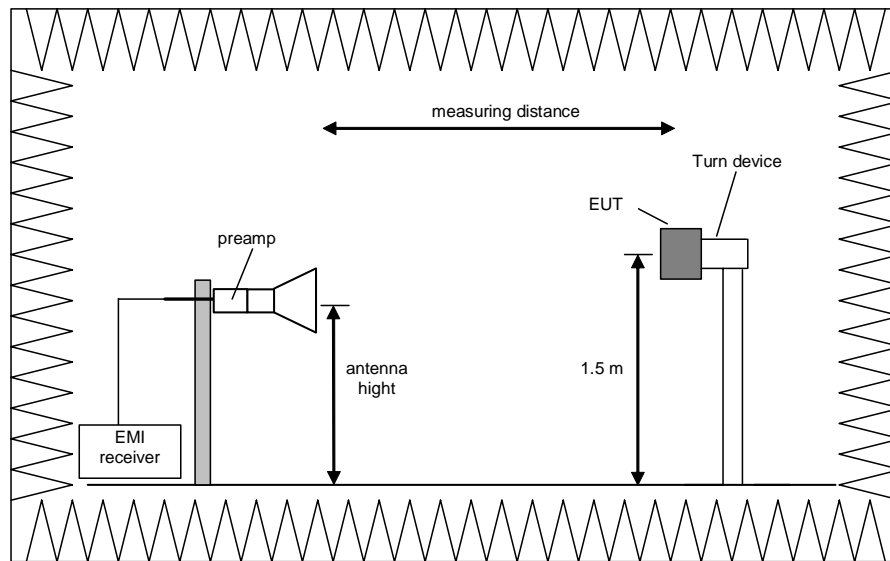

Procedure of measurement:

The measurements were performed in the frequency ranges 1 GHz to 4 GHz, 4 GHz to 12 GHz, 12 GHz to 18 GHz, 18 GHz to 25 /26.5 GHz and 26.5 GHz to 40 GHz.

The following procedure will be used:

- 1) Set the turntable and the turn device to obtain the worst-case emission for the first frequency identified in the preliminary measurements.
- 2) Set the measurement antenna polarization to the orientation with the highest emission for the first frequency identified in the preliminary measurements.
- 3) Set the spectrum analyzer to EMI mode with peak and average detector activated.
- 4) Rotate the turntable from 0° to 360° to find the TT Pos. that produces the highest emissions.
- 5) Note the highest displayed peak and average values
- 6) Repeat the steps 1) to 5) for each frequency detected during the preliminary measurements.

## 5.5.2 Test results (radiated emissions) – Emissions with internal antenna from 9 kHz – 26.5 GHz

### 5.5.2.1 Preliminary radiated emission measurement 9kHz – 26.5 GHz

Ambient temperature	22 °C	Relative humidity	59 %
---------------------	-------	-------------------	------

Position of EUT: The EUT was set-up on a EUT turn device of a height of 1.5 m. The distance between EUT and antenna was 3 m.

For the final test on the open area test site the EUT was placed on a table with the height of 0.8 m. The distance between EUT and antenna was 3 m.

Cable guide: For detail information of test set-up and the cable guide refer to the pictures in the annex A in the test report.

Test record: Only the plot of the worst case emission is submitted below.

Supply voltage: During all measurements the EUT was powered with 5 V via USB.

#### **Transmitter operates at the lower end of the assigned frequency band (operation mode 2)**

#### **170923 9kHz-30MHz ch00: Spurious emissions from 9 kHz to 30 MHz (operation mode 2):**

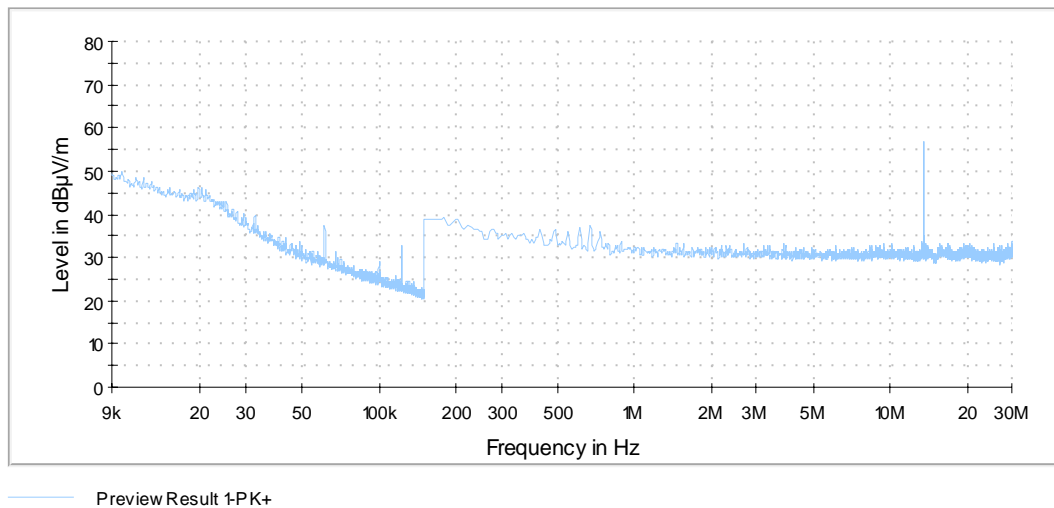

Remark: The peak at 68 kHz was caused by the measurement system and not by the equipment under test  
The peak at 13.56 MHz is the simultaneous transmitting RFID reader – so a wanted signal

170923 30MHz-1GHz ch00 TX: Spurious emissions from 30 MHz to 1 GHz (operation mode 2):  
(Preliminary results)

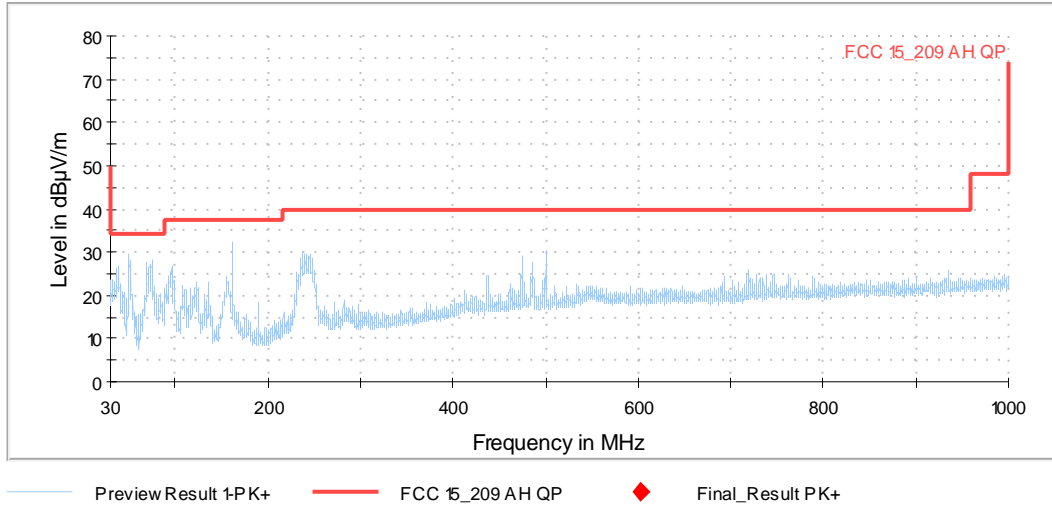

170923 1-4GHz ch00 : Spurious emissions from 1 GHz to 4 GHz (operation mode 2):

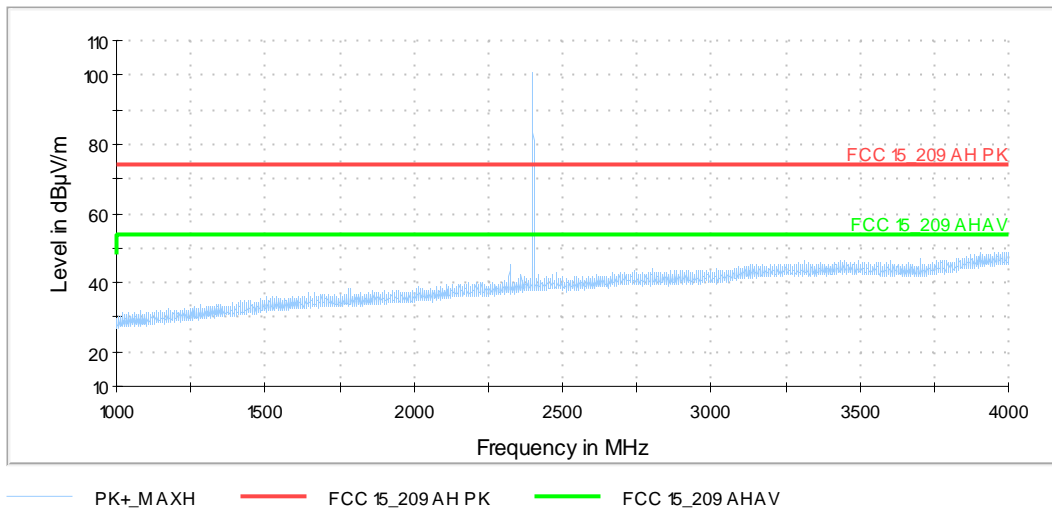

170923 4-12GHz ch00 : Spurious emissions from 4 GHz to 12 GHz (operation mode 2):

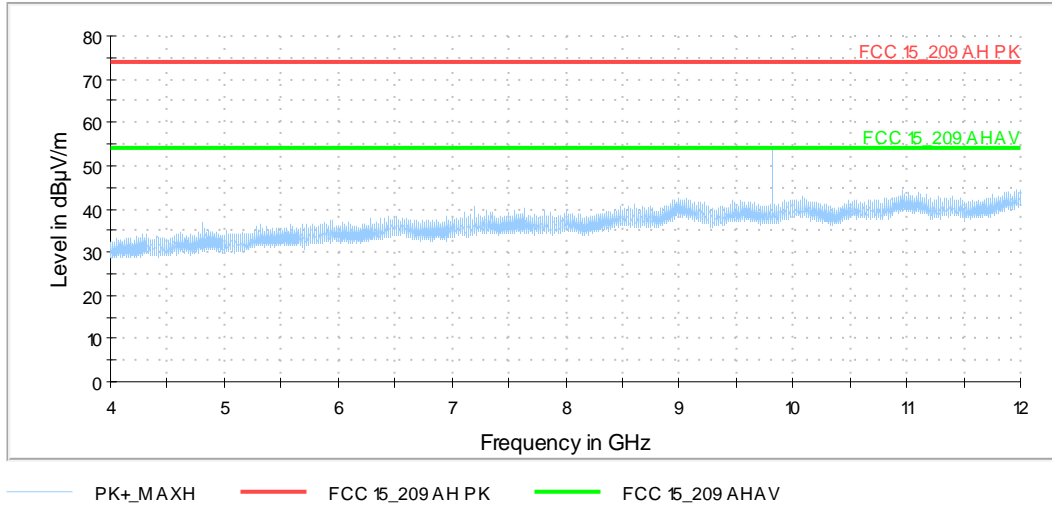

170923 12-18GHz ch00: Spurious emissions from 12 GHz to 18 GHz (operation mode 2):

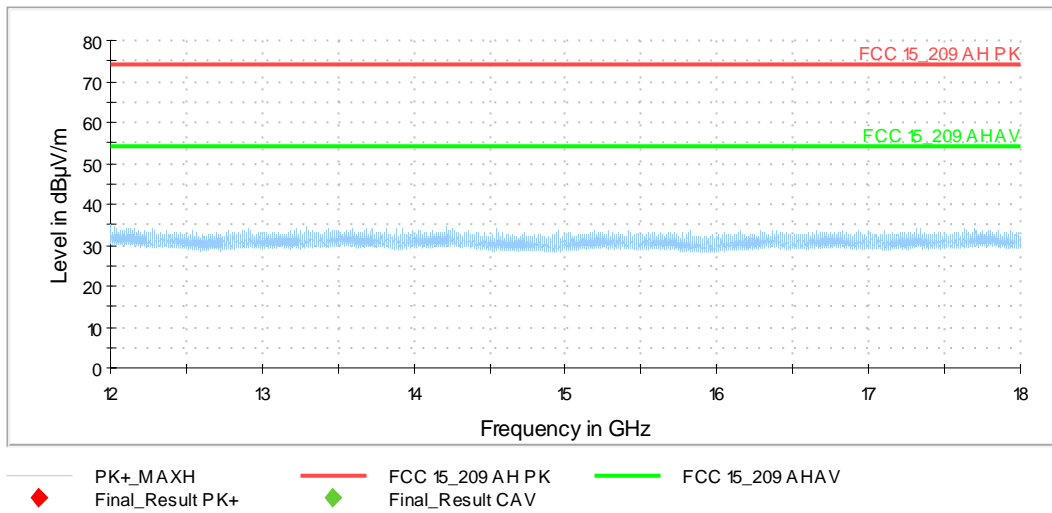

170923 18-25GHz ch00: Spurious emissions from 18 GHz to 25 GHz (operation mode 2):

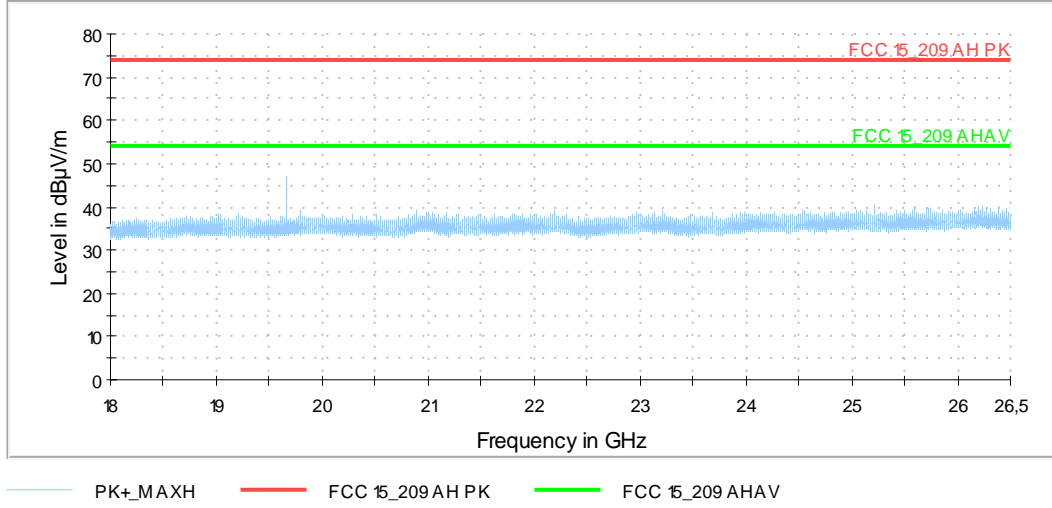

### 5.5.2.2 Final radiated measurements

#### Transmitter operates at the lower end of the assigned frequency band (operation mode 2)

Results with measuring distance of 3 m						
Frequency [MHz]	Result [dB $\mu$ V/m]	Limit [dB $\mu$ V/m]	Margin [dB]	Detector	Readings [dB $\mu$ V]	Antenna factor [dB/m]
13.56	35.2	69.54	70.3	AV	15.2	20.0
Results with measuring distance of 10 m						
Frequency [MHz]	Result [dB $\mu$ V/m]	Limit [dB $\mu$ V/m]	Margin [dB]	Detector	Readings [dB $\mu$ V]	Antenna factor [dB/m]
13.56	Signal was below the noise floor of the measuring system at 10 m distance					
Measurement uncertainty: +2.2 dB / -3.6 dB						

Frequency [MHz]	QuasiPeak [dB $\mu$ V/m]	Limit [dB $\mu$ V/m]	Margin [dB]	Height [cm]	Pol	Azimuth [deg]	Corr. [dB]
50.273000	31.51	40.00	8.49	102.0	V	78.0	16.2
74.571500	26.00	40.00	14.00	162.0	V	262.0	14.8
95.911500	28.39	43.50	15.11	127.0	V	10.0	18.2
162.730180	34.15	43.50	9.35	102.0	V	93.0	19.3
237.531500	28.41	46.00	17.59	112.0	H	142.0	20.3
499.965000	24.89	46.00	21.11	104.0	V	231.0	27.5
Measurement uncertainty				+2.2 dB / -3.6 dB			

Frequency [MHz]	MaxPeak [dB $\mu$ V/m]	Average [dB $\mu$ V/m]	Limit [dB $\mu$ V/m]	Margin (dB)	Pol	Azimuth (deg)	Elevation (deg)	Corr. (dB)
2321.980000	---	43.7	54.0	10.3	H	205	150	33.6
2321.980000	50.3	---	74.0	23.7	H	205	150	33.6
2402.080000*	---	101.6	54.0	-47.6	H	208	150	34.0
2402.080000*	102.4	---	74.0	-28.4	H	208	150	34.0
9827.900000	---	53.2	54.0	0.8	H	312	30	7.6
9827.900000	56.6	---	74.0	17.4	H	312	30	7.6
19655.800000	---	45.2	54.0	8.8	V	291	60	6.6
19655.800000	50.4	---	74.0	23.7	V	291	60	6.6
Measurement uncertainty				+2.2 dB / -3.6 dB				

\* Wanted signal of the EUT

170923 30MHz-1GHz ch00 TX: Spurious emissions from 30 MHz to 1 GHz (operation mode 2):  
 (Final results)

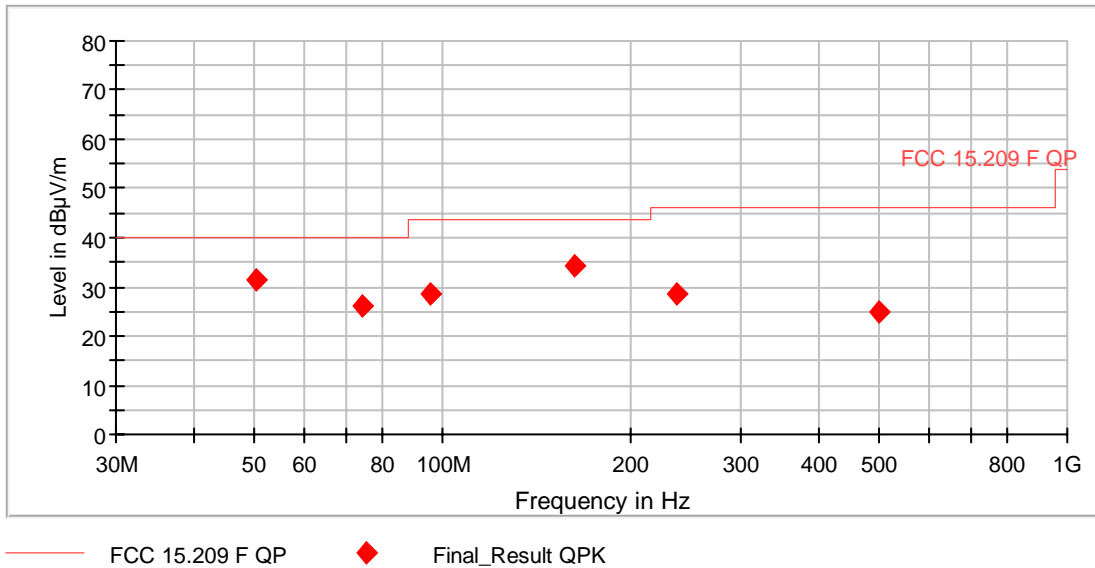

TEST EQUIPMENT USED FOR THE TEST:	
9kHz – 30 MHz, preliminary:	3, 5, 9 - 11
9kHz – 30 MHz, final:	10, 12 - 13
30 MHz – 1GHz, preliminary:	1 - 3, 5, 9, 14 - 16
30 MHz – 1GHz final:	17 - 24
1 GHz – 26.5 GHz:	1, 3 - 7, 9, 15, 25 - 31



## 6 Test equipment and ancillaries used for tests

No.	Test equipment	Type	Manufacturer	Serial No.	PM. No.	Cal. Date	Cal Due
1	Antenna mast	AS615P	Deisel	615/310	480187	Calibration not necessary	
2	Fully anechoic chamber M20	B83117-E2439-T232	Albatross Projects	103	480303	29.11.2016	11.2017
3	Turntable	DS420 HE	Deisel	420/620/00	480315	Calibration not necessary	
4	RF-cable No.3	Sucoflex 106B	Suhner	0563/6B / Kabel 3	480670	Calibration not necessary	
5	Multiple Control Unit	MCU	Maturo GmbH	MCU/043/971107	480832	Calibration not necessary	
6	Antenna (Log.Per.)	HL050	Rohde & Schwarz	100438	481170	31.08.2014	09.2017
7	RF-Cable No. 40	Sucoflex 106B	Suhner	0708/6B / Kabel 40	481330	Calibration not necessary	
8	HF-Cable	Sucoflex 104	Huber+Suhner	517406	482391	Calibration not necessary	
9	EMI receiver	ESW44	Rohde & Schwarz	101635	482467	22.06.2017	06.2019
10	loop antenna	HFH2-Z2	Rohde & Schwarz	100417	481912	20.10.2016	10.2017
11	Antenna support	AS620P	Deisel	620/375	480325	Calibration not necessary	
12	Outdoor test site	OATS Parkplatz	PHOENIX TESTLAB GmbH	-	480293	Calibration not necessary	
13	EMI Receiver / Spectrum Analyser	ESI 40	Rohde & Schwarz	100064/040	480355	15.02.2017	02.2018
14	RF-cable No.36	Sucoflex 106B	Suhner	0587/6B / Kabel 36	480865	Calibration not necessary	
15	Software	EMC32	Rohde & Schwarz		481800	Calibration not necessary	
16	Antenna (Bilog)	CBL6112B	Schaffner EMV GmbH (-Chase)	2688	480328	19.06.2017	06.2020
17	Attenuator 6 dB	R412706000	Radiall	9833	410082	Calibration not necessary	
18	Open area test site M6	Freifeld M6	Phoenix Contact	-	480085	20.04.2017	10.2018
19	Antenna mast	MA240-0	Inn-Co GmbH	MA240-0/030/6600603	480086	Calibration not necessary	
20	Turntable	DS412	Deisel	412/316	480087	Calibration not necessary	
21	Controller	HD100	Deisel	100/349	480139	Calibration not necessary	
22	EMI Receiver	ESIB 7	Rohde & Schwarz	100304	480521	18.02.2016	02.2018
23	Antenna (Bilog)	CBL6111D	Schaffner Elektrotest GmbH / Teseq GmbH	25761	480894	18.09.2014	09.2017
24	Software	EMC32	Rohde & Schwarz	100061	481022	Calibration not necessary	
25	standard gain horn antenna	18240-20	Flann Microwave	483	480294	Calibration not necessary	
26	standard gain horn antenna	20240-20	Flann Microwave	411	480297	Calibration not necessary	
27	Microwave cable 2m	Insulated Wire Inc.	Insulated Wire	KPS-1533-800-KPS	480302	Calibration not necessary	
28	Preamplifier 100 MHz - 13 GHz	JS3-00101200-23-5A	MITEQ Hauppauge N.Y.	681851	480337	18.02.2016	02.2018
29	Preamplifier 18 GHz - 26 GHz	JS4-18002600-20-5A	MITEQ Hauppauge N.Y.	658697	480342	17.02.2016	02.2018

